

SESSION INFORMATION

- A. TARGET DATA:
Task/Target No. : 93-169-P
Session No. : 01
- B. PERSONNEL DATA:
Source No. : 049
Monitor's No. : NA
Beacon/Sender No. : DG
- C. SESSION DATA:
Date Task Received : 25 FEB 93
Session Date : 26 FEB 93
Start Time : 1118
Stop Time : 1202
Method Used : CRV
Aids/Distractions (PIs) : Sore shoulder
Pre-session Hunches (AVs) : None
Date Summary Returned : 26 FEB 93
- D. EVALUATION DATA:
Viewer's Estimate :
Evaluator's Estimate :
- E. SESSION SUMMARY:

The target consists of a complex of structures which have a military orientation. There is the concept of "surrounded". The structures of this complex are mostly above ground but there is a "partially below" or "buried" aspect to the target. The target is predominately involved with the concepts of projection and retrieval. The system is associated with "large scale generation" of energy and it can be very dangerous.

There is an experimental and R&D aspect to the target, though the target feels that it is not fully functioning. There is a curving wooden aspect or feature associated with the target. Another feature has a "scoop-like" profile. There are numerous sets of parallel present as well as rounded objects reminiscent of boulders.

It is windy here and the wind can be very strong. There is steep terrain with a canyon-like appearance. It is reminiscent of a large, curving canyon. There are stacked wooden pieces (see diagram on page ii). Colors are predominately blue, gray and transparent.

Viewer's Note: This target really got me agitated. It felt as if my skin was crawling. There were 100's of prickly sensations under my skin. Felt as if I was being zapped by something.

Object

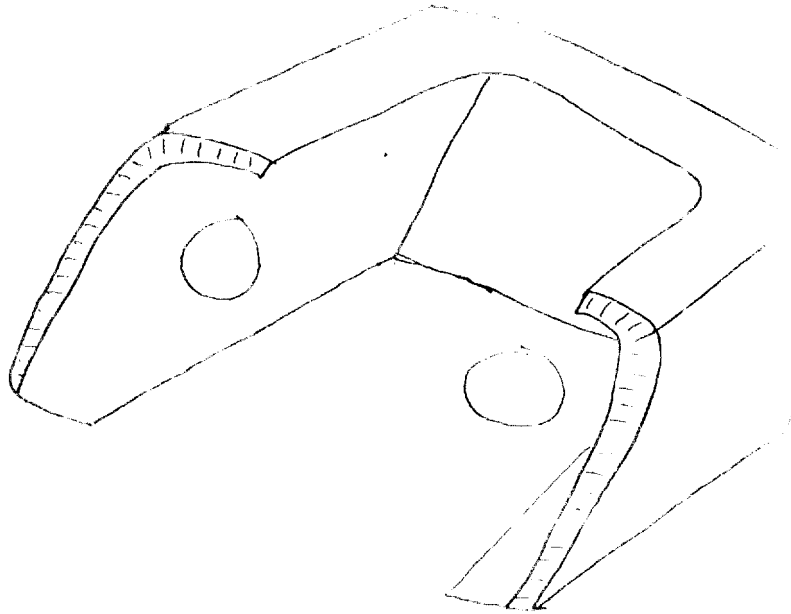
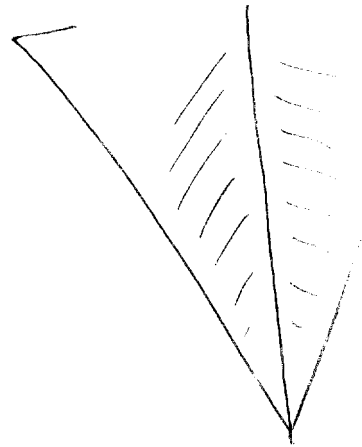
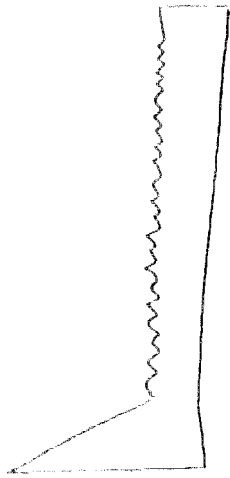

UB objects -

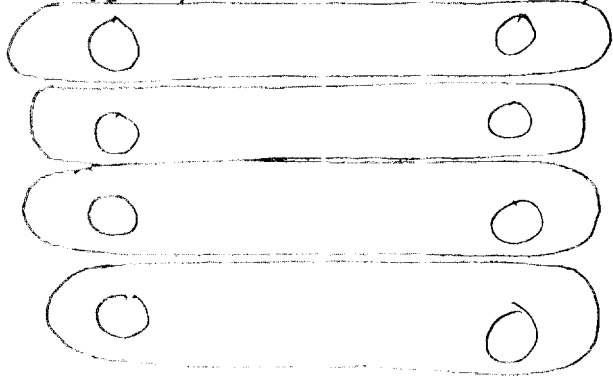

STACKED WOOD PIECES

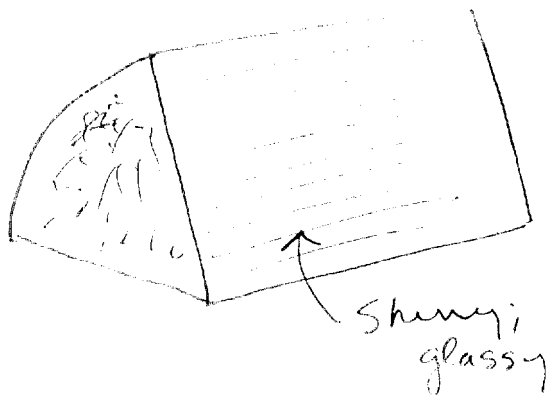
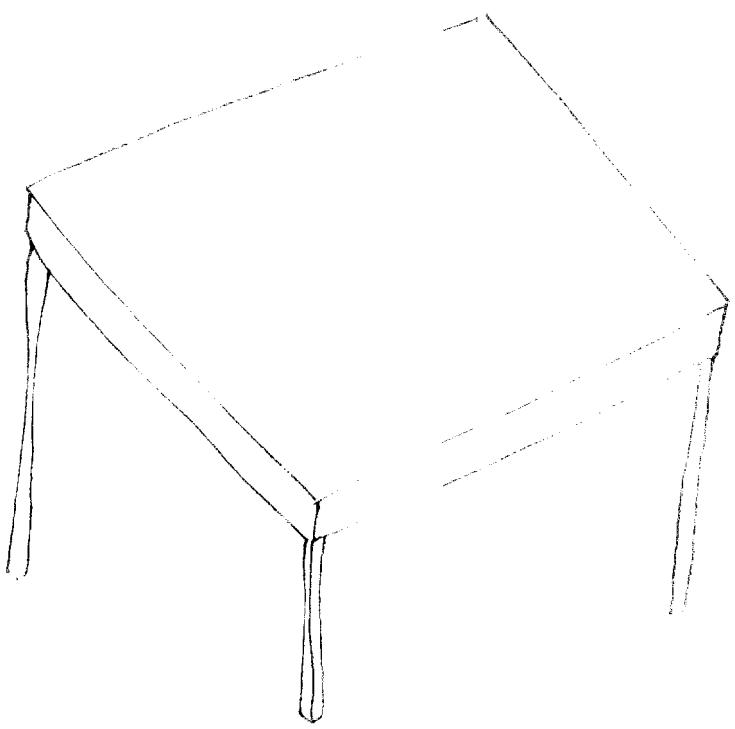

Shiny; glassy

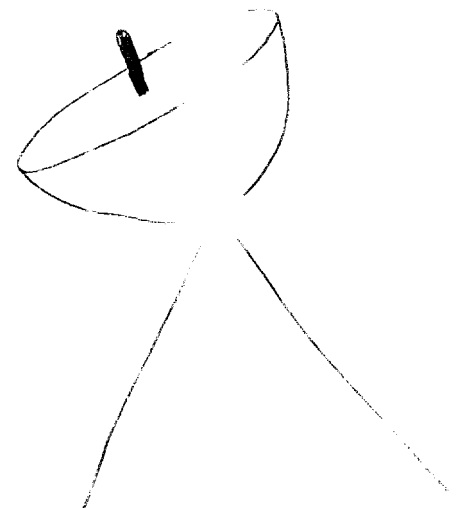

(Li)

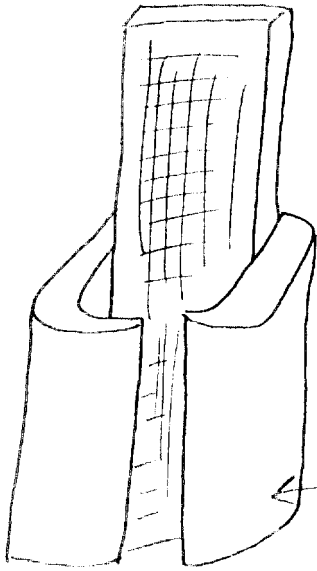

Taller structure w/ a surrounded
by a closed-in base shoe shaped
feature.

This portion "feels" like a modern
newer addition.

Concept of being surrounded

overhead
view

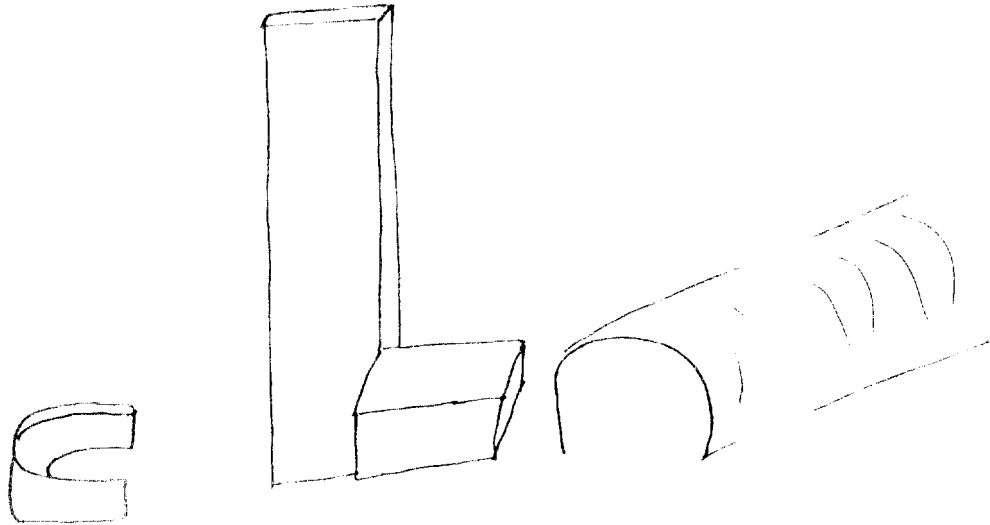
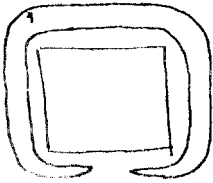

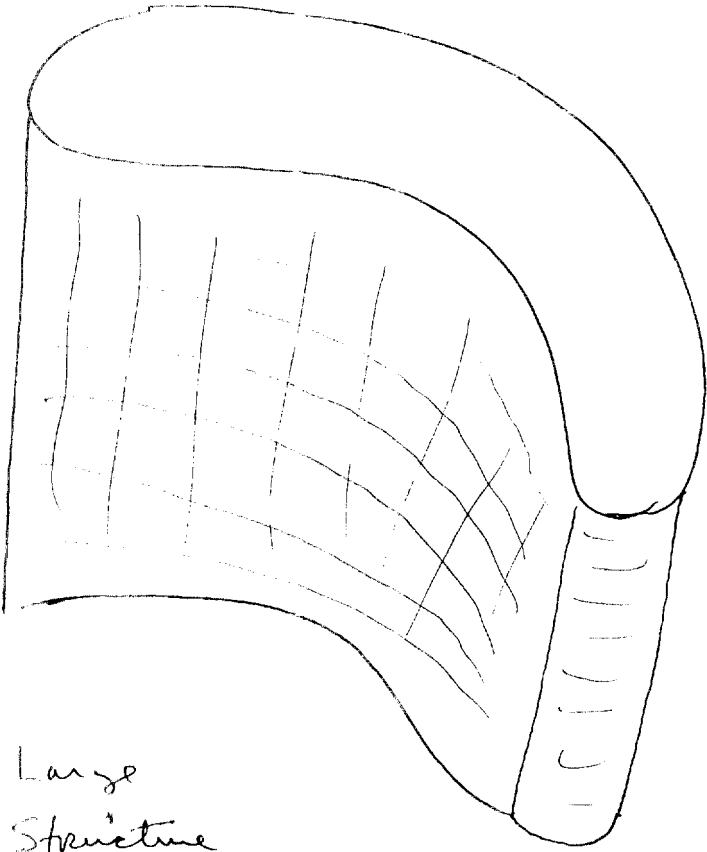

Large
Structure

U/I objects

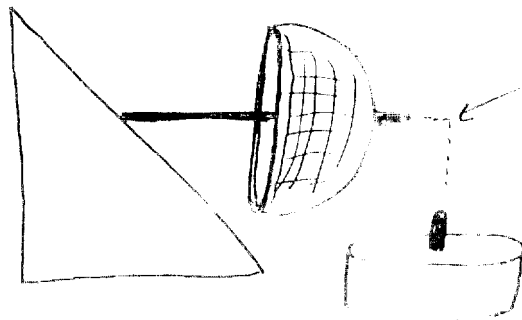

concept of
conjunction,
interception,
integration at
this point

- Concept of perspective / retrieval

107

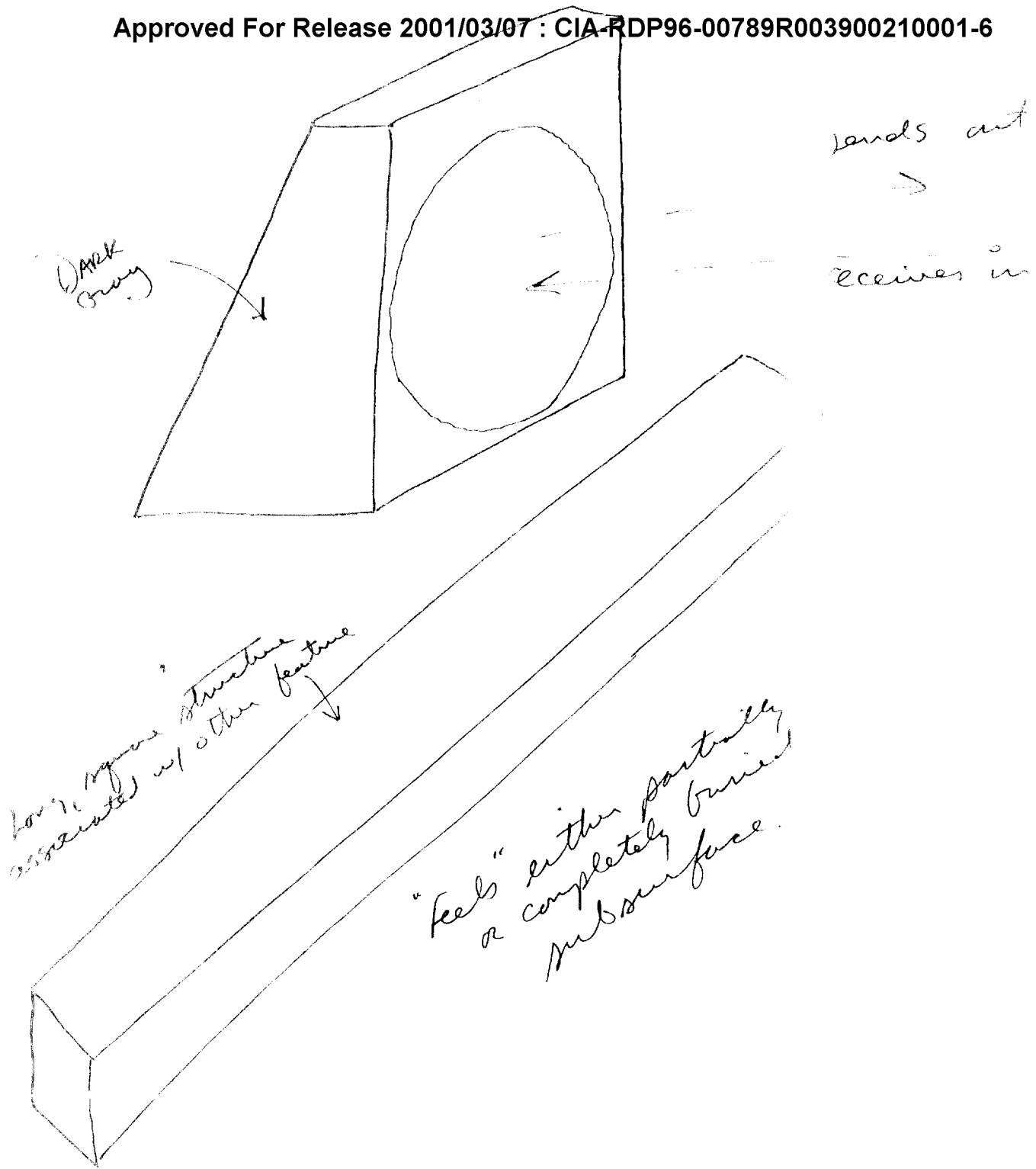

(5)

*1/1 object or
Component.*

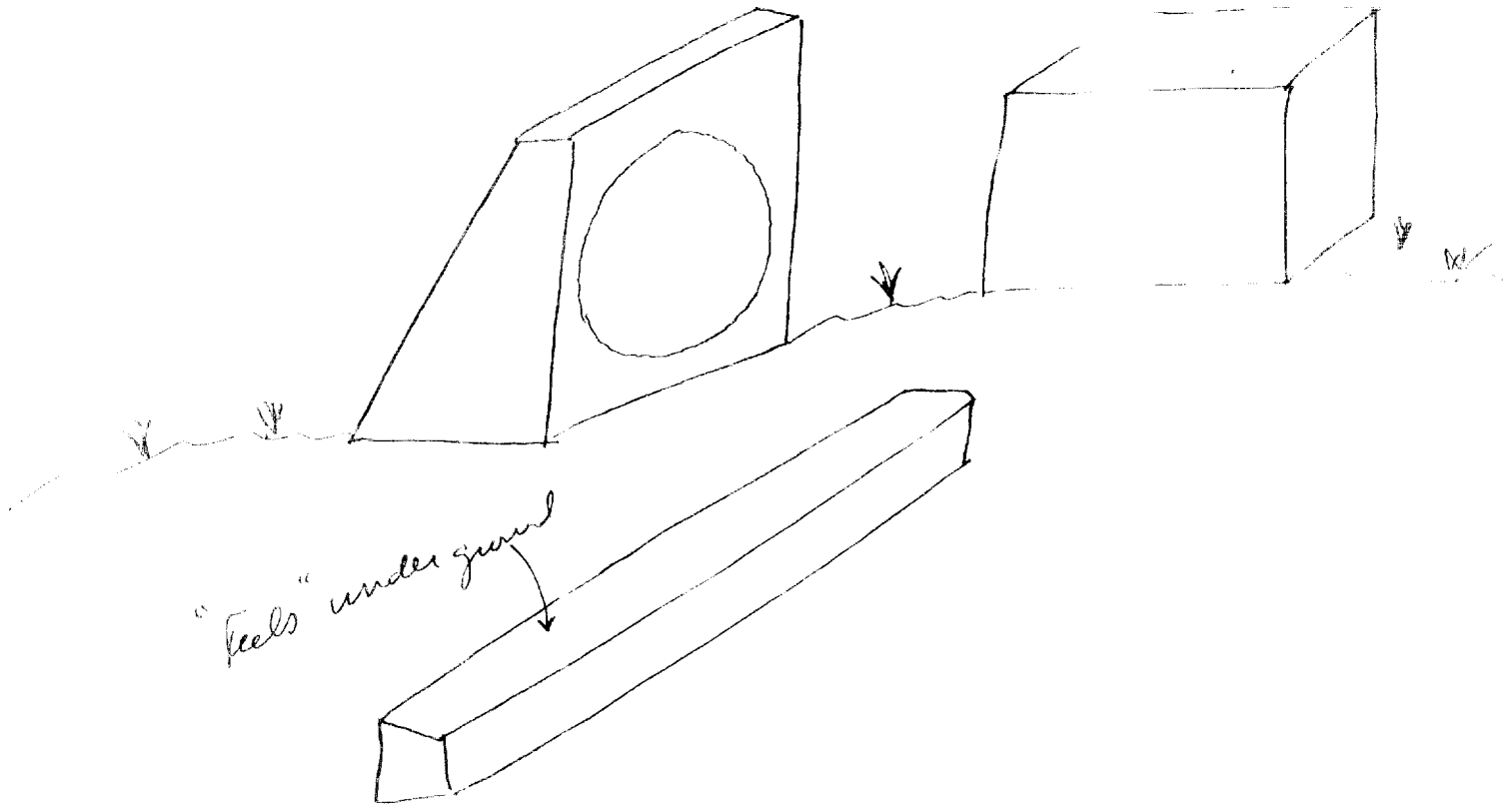
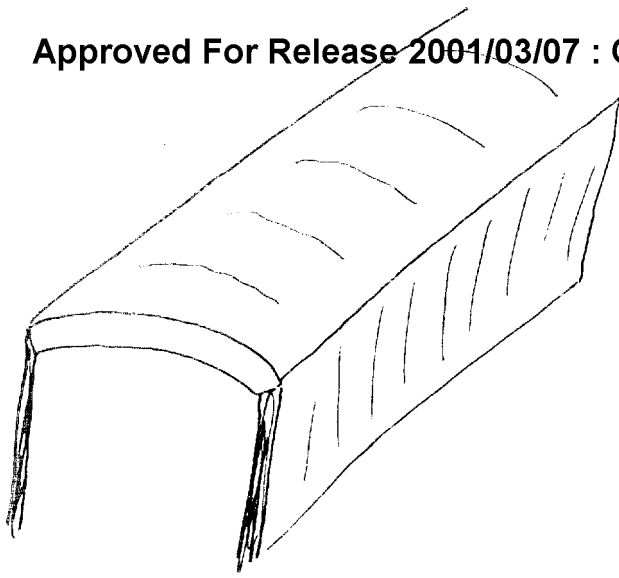

or

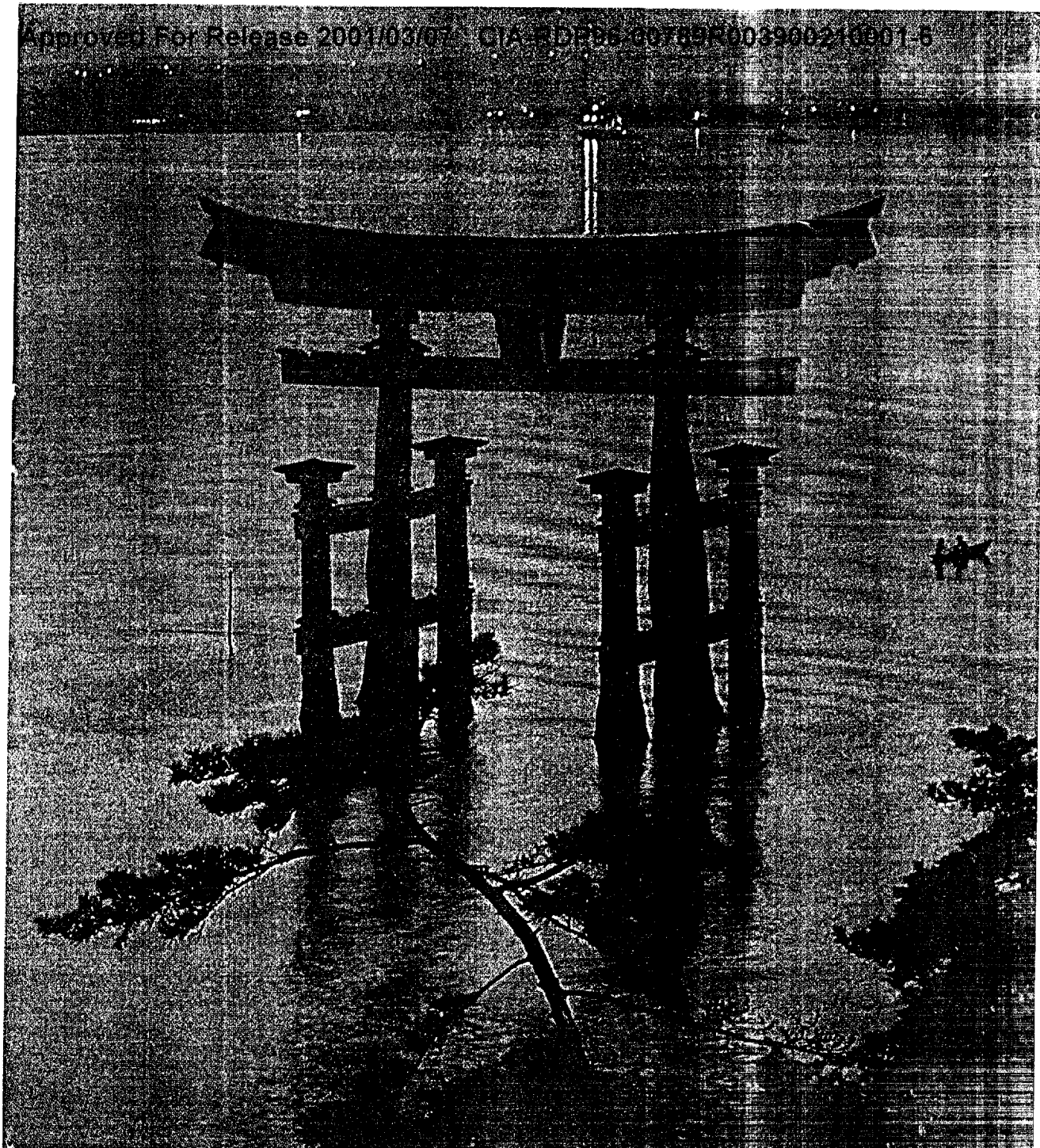

Guardian gateway, the torii entrance to Itsuku Shima Shrine shelters a sacred corner of Hiroshima Bay from the lights of change that multiply along the shore. Much of Japan wears a new face, but in many villages and island byways of the Inland Sea, the grace and traditions of the past stubbornly linger on.

93-169-~~1~~

1. Conceptual/General

a. Sources/Production/Commercial

Historical.

b. Blue

c. White dots

d. Gateway

2. Specifics Analysis

a. Scheme

b. Asian/Japanese.

c. Bay area (Hawaii)

d. Archway.

TASKING SHEET

SOURCE NO: _____

DATE: 25 FEB 93

SUSPENSE: 26 FEB 93

1600 hrs

1. PROJECT NUMBER: 98-169-P

2. METHOD/TECHNIQUE: Method of choice.

3. BACKGROUND: This project is a continuation of a proficiency series targeting "structures/configurations,"

----These configurations can be anything. However, buildings/structures will be dominant.

----Targets will emphasize key elements that are unique or distinct. They will be composed of specific shapes, contours, and configurations. Some targets may have multiple similar shapes/features

----Targets may be of a commercial, governmental, or military They may be either historic or contemporary.

4. ESSENTIAL ELEMENTS OF INFORMATION: _____

----Describe/sketch the key features/shapes/contours of the target.

----Describe/sketch the spatial relationships or relative sizes of the target features.

----Determine other features such as colors and predominant backgrounds.

----Determine the purpose of the target structures.

COMMENTS: _____

----This target has/does not have a beacon person. Beacon person is DG.

----Optional Coordinates: 921141/111430