

~~SECRET~~

PROJECT EVALUATION FEEDBACK

PROJECT NO. \_\_\_\_\_  
DATE OF PROJECT \_\_\_\_\_

The following is an evaluation form <sup>SG1J</sup> for the project you reviewed. Please complete this form and return to [redacted] Chief, Technology Assessment and Support Activity.

A. Is the information accurate? (Circle response)

<u>Categories</u>	Source <u>A</u>	Source <u>B</u>	Source <u>C</u>
Yes (true)	(1)	(1)	(1)
May be true	(2)	(2)	(2)
Possibly true	(3)	(3)	(3)
No	(4)	(4)	(4)
Possibly not true	(5)	(5)	(5)
Unsure	(6)	(6)	(6)

B. What is value of the Source(s)' information? (Circle response)

Major significance	(1)	(1)	(1)
High value	(2)	(2)	(2)
Of value	(3)	(3)	(3)
Low value	(4)	(4)	(4)
No value	(5)	(5)	(5)

UNCLASSIFIED WHEN BLANK

~~SECRET~~

~~SECRET~~

C. Rationale for source evaluation. Provide rationale/analysis which led to your evaluation of responses provided above. Include confirmatory/new confirmatory data and whether collection requirements are currently validated/tasked to either obtain or verify such data. Please provide your written evaluation by source.

D. \_\_\_\_\_  
NAME OFFICE/PHONE NUMBER

UNCLASSIFIED WHEN BLANK

~~SECRET~~

STAR GATE

SESSION INFORMATION

A. TARGET DATA:  
Task/Target No. :94-237-0  
Session No. :01

B. PERSONAL DATA:  
Source No. :025  
Monitor's No. :  
Beacon/Sender No. :

C. SESSION DATA:  
Date Task Received :25 April 1994  
Session Date :25 April 1994  
Start Time :1:00  
Stop Time :2:00  
Method Used :ERV  
Aids/Distractions (PIs) :  
Pre-session Hunches (AVs) :  
Date Summary Returned :25 April 1994

D. EVALUATION DATA:  
Viewer's Estimate :  
Evaluator's Estimate :

E. SESSION SUMMARY

SG1A

██████████ is meeting with people who are military related at a land water interface location. A large building or industrial plant is in the vicinity. <sup>SG1A</sup>██████████ is meeting with people for both technical and social purposes. Work related activities, projects and communications are emphasized.

TASKING SHEET

SOURCE NO: 025

DATE: 25 Apr 94

SUSPENSE: 25 Apr 94

1600 Hrs

1. PROJECT NUMBER: 94-237-0

2. METHOD/TECHNIQUE: Method of Choice

3. BACKGROUND: Follow-on project.

4. ESSENTIAL ELEMENTS OF INFORMATION: \_\_\_\_\_

Describe circumstance of target's meeting(s) during the period  
1-20 May 94 and focus specifically on the person(s) involved with  
the meeting(s).

5. COMMENTS: \_\_\_\_\_

**SG1A**

**Approved For Release 2001/03/07 : CIA-RDP96-00789R002500110021-0**

**Approved For Release 2001/03/07 : CIA-RDP96-00789R002500110021-0**

TASKING SHEET

SOURCE NO: \_\_\_\_\_

DATE: 25 Apr 94

SUSPENSE: 25 Apr 94

1600 Hrs

1. PROJECT NUMBER: 94-237-0

2. METHOD/TECHNIQUE: Method of Choice

3. BACKGROUND: \_\_\_\_\_  
Follow-on project.

4. ESSENTIAL ELEMENTS OF INFORMATION: \_\_\_\_\_

Describe circumstance of target's meeting(s) during the period  
1-20 May 94 and focus specifically on the person(s) involved with  
the meeting(s).

5. COMMENTS: Coordinates: 885921/370701

a)

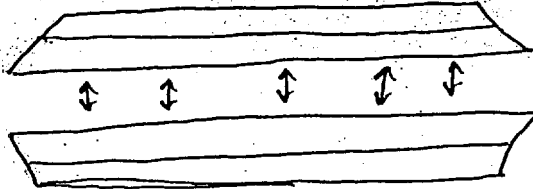

← Plate-shaped object  
 "floating" about another  
 plate-shaped object

b<sub>1</sub>)

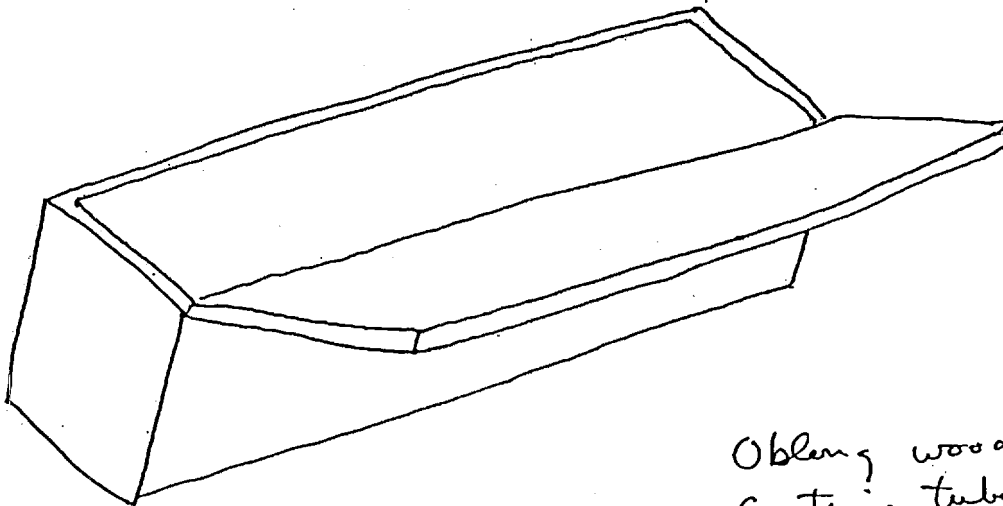

Oblong wooden box;  
 contains tube-like  
 object; object sits off  
 to one side.

b<sub>2</sub>)

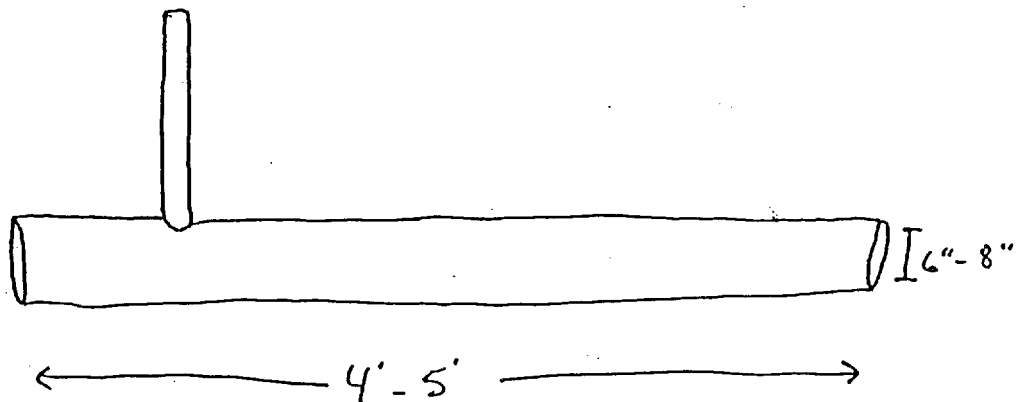

Object within above box; lies on its side;  
 packed with soft material.

~~SECRET~~

a)

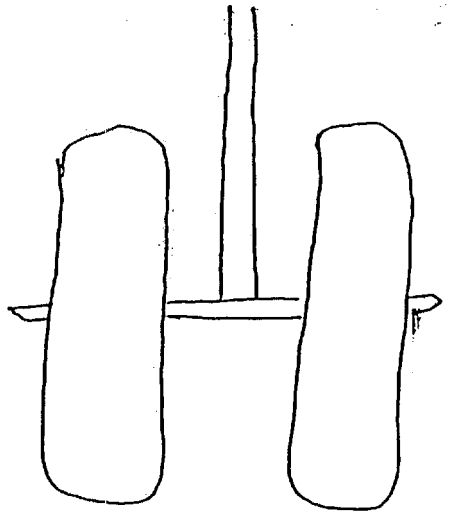

b)

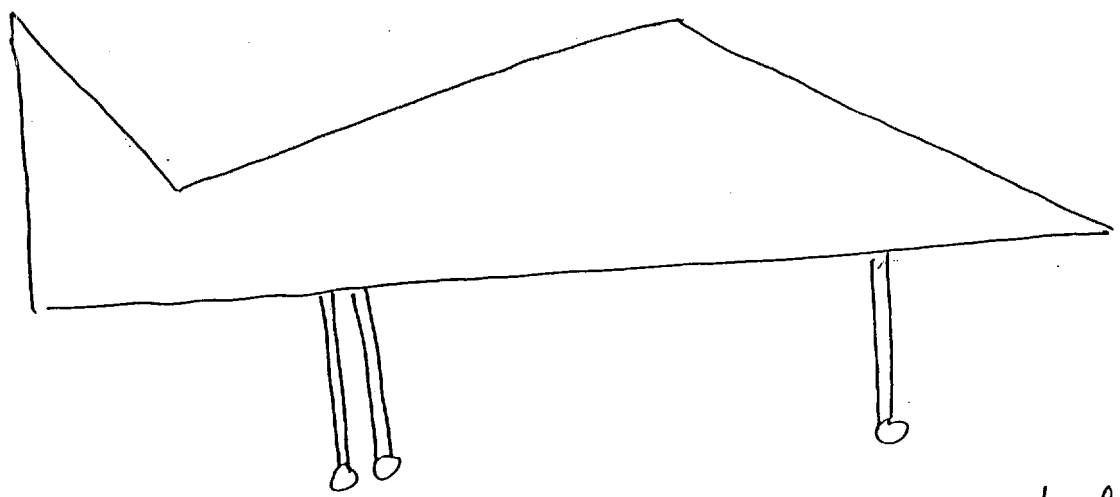

*silhouetted: Sits high above the wheels*

c)

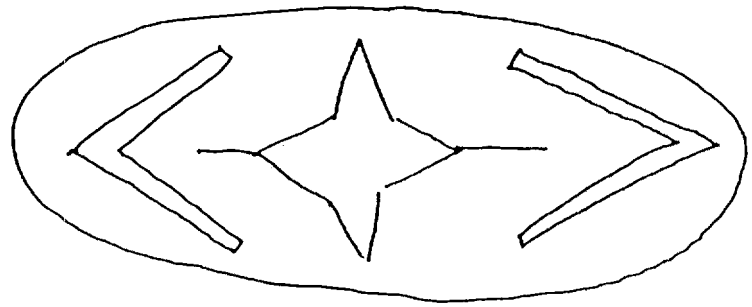

*unknown object / feature*

~~SECRET~~  
NOFORN  
STAR GATE  
LIMDIS



~~SECRET~~

a)

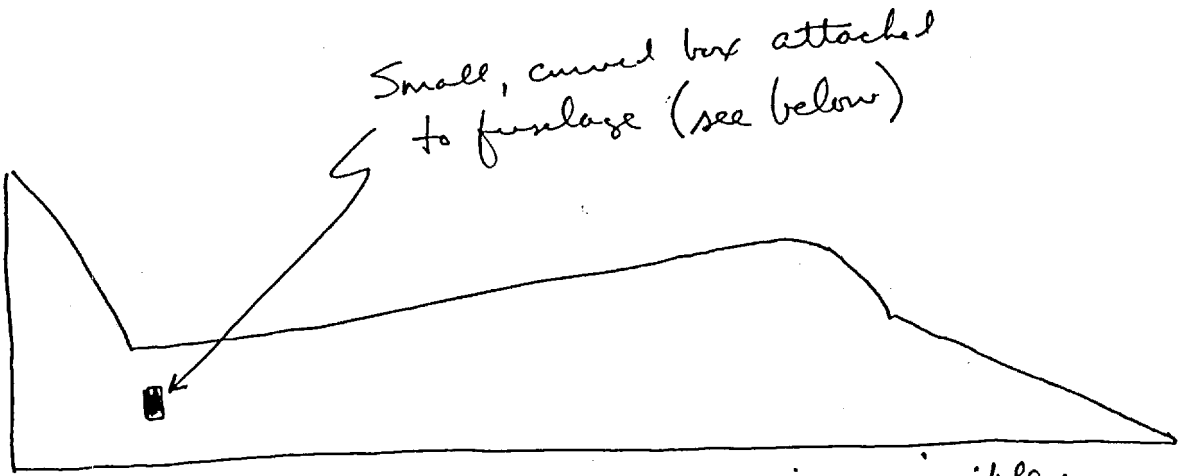

Small, curved box attached to fuselage (see below)

Isolated aircraft; no engines visible; silhouetted against a bright background.

b<sub>1</sub>)

View of under-side of curved box  
→

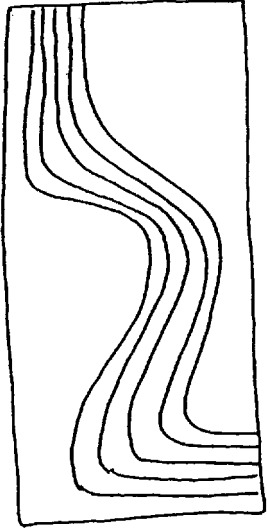

outline of fuselage

b<sub>2</sub>)

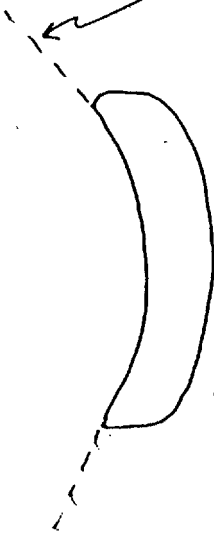

"side view"

\* Curved box from above aircraft

~~SECRET~~  
NOFORN  
STAR GATE

a<sub>1</sub>)

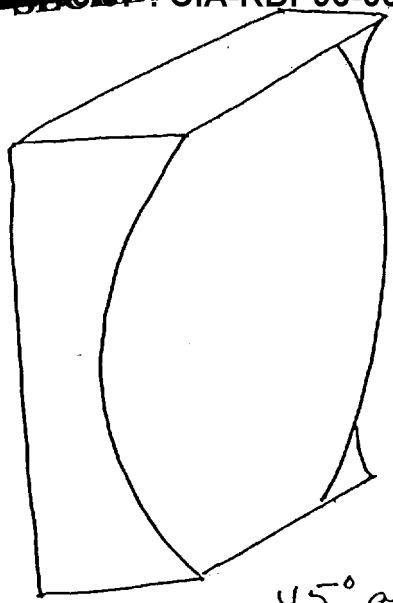

45° angle view

a<sub>2</sub>)

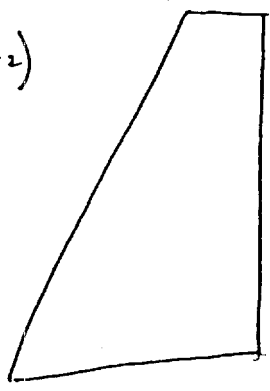

Side view

\* There is a row or alignment of these objects; all similarly shaped; dark colored; huge.

b)

POSITION OF INDIVIDUALS IN MEETING.

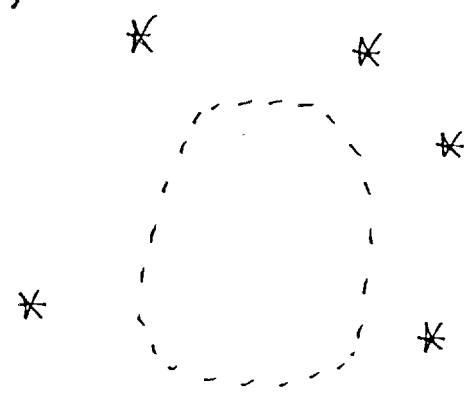

(see next page)

~~SECRET~~

NOFORN

STAR GATE

LIMDIS

~~SECRET~~  
LARGE OPEN AREA

LARGE STRUCTURE

a)

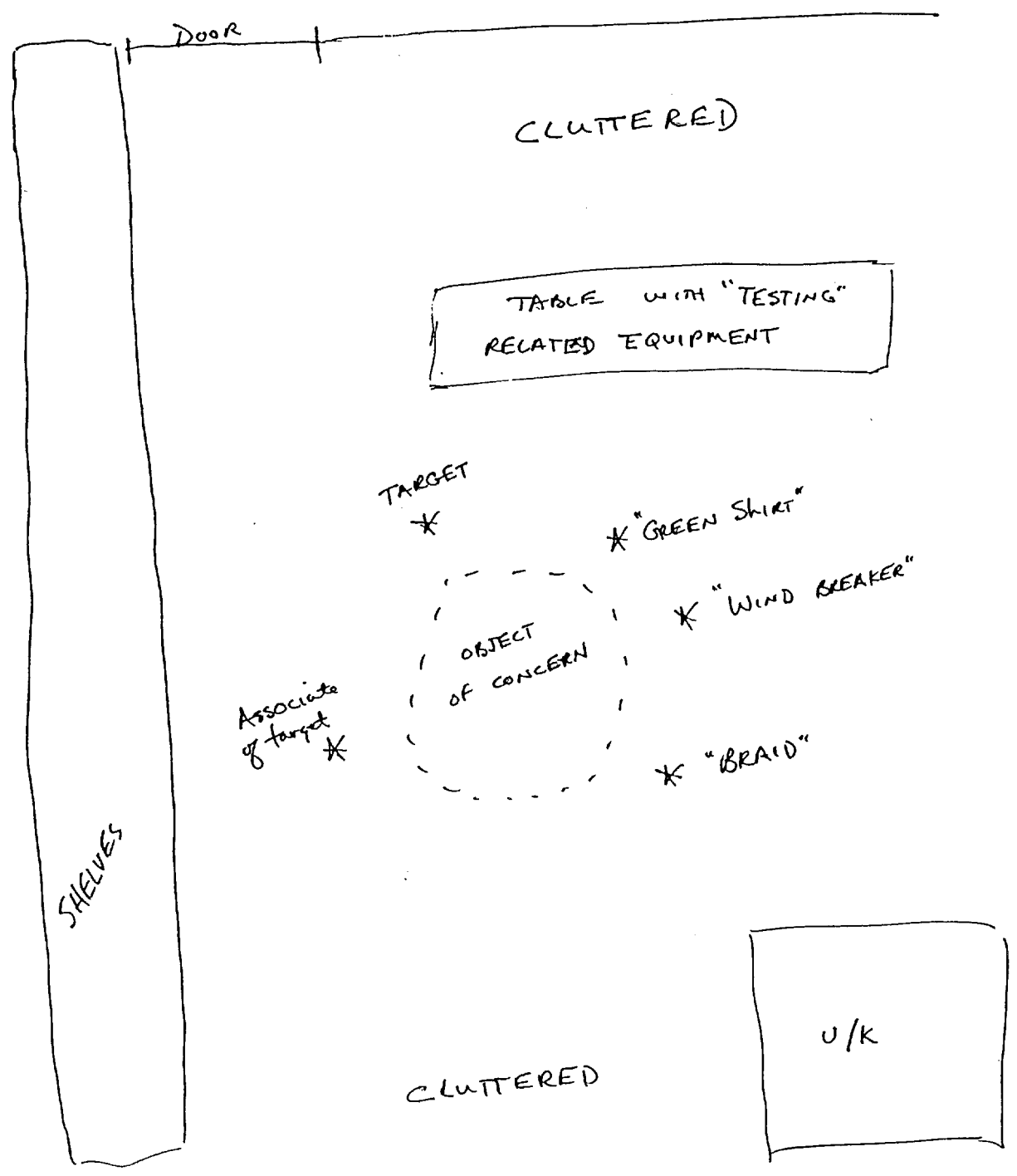

LAY-OUT OF OFFICE / LAB WHERE MEETING OF INTEREST OCCURS

~~SECRET~~

NOFORN  
STAR GATE  
LIMDIS