

~~SECRET~~

DATA SUMMARIES

(S/NF/SG/LIMDIS) Following are the perceived highlights from each source.

- (S/NF/SG/WN/LIMDIS) Source A:
SG1A

-- [REDACTED] is meeting with people who are military related at a land water interface location. A large building or industrial plant is in the vicinity. [REDACTED] is meeting with people for both technical and social purposes. Work related activities, projects and communications are emphasized.

SG1A

- (S/NF/SG/WN/LIMDIS) Source B:

-- The target is associated with high tech "stuff"; the discussions deal with extremely sophisticated technology. A military is somehow involved.

-- There is the sense that this technology is associated with aircraft in someway, either directly (the aircraft itself or parts thereof) or indirectly (extraneous aspects outside of, but relating to, aircraft).

-- A group of five individuals will have, or have had, a discussion revolved around one) the contents of a long, oblong box (Attachment A) and either an aircraft or a piece of an aircraft (Attachments B&C). This group is in a place where there have been numerous small cylinders (like miniature scuba tanks) stored. This place is a small office/lab type area contained within a larger structure. This structure is reminiscent of a warehouse or maintenance facility. Somehow there is the concept of a "Chinese" association here, whether it's governmental, genetics (i.e. someone of Chinese descent, personal religious philosophy; I don't know.

REPRODUCTION REQUIRES
APPROVAL OF ORIGINATOR
OR HIGHER DOD AUTHORITY

WARNING NOTICE-INTELLIGENCE
SOURCES OR METHODS INVOLVED

FURTHER DISSEMINATION
ONLY AS DIRECTED BY DIA/PAG
OR HIGHER DOD AUTHORITY

CLASSIFIED BY MULTIPLE SOURCES
DECLASSIFY ON OADR

~~SECRET~~

NOT RELEASABLE TO FOREIGN NATIONALS

~~SECRET~~

-- One individual is the target (Attachment D&E); a second is an associate of the target and has closely cropped hair; a third is an Afro-American dressed in green shirt and "feels" associated with the military; a fourth is a caucasian (nationality unknown) wearing a windbreaker; this guy smacks of being an operative of a well established intelligence agency; and the fifth individual has a long braid and is of mixed heritage (Oriental and Latino or Middle Eastern).

-- This particular meeting is a "set-up" with a double cross planned by a third party. The "windbreaker" has previous knowledge of this plan.

-- The aircraft depicted in the sketches can only be seen in silhouette. They have been silhouetted by a bright flash from behind. It or they sit isolated from other features including structures. No exterior engines could be discerned and aircraft sits high about the wheels.

- (S/NF/SG/WN/LIMDIS) Source C:

-- No information.

~~SECRET~~

NOT RELEASABLE TO FOREIGN NATIONALS
STAR GATE

WNINTEL

LIMDIS

a)

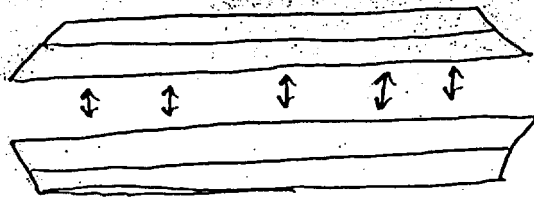

← Plate-shaped object
"floating" about another
plate-shaped object

b₁)

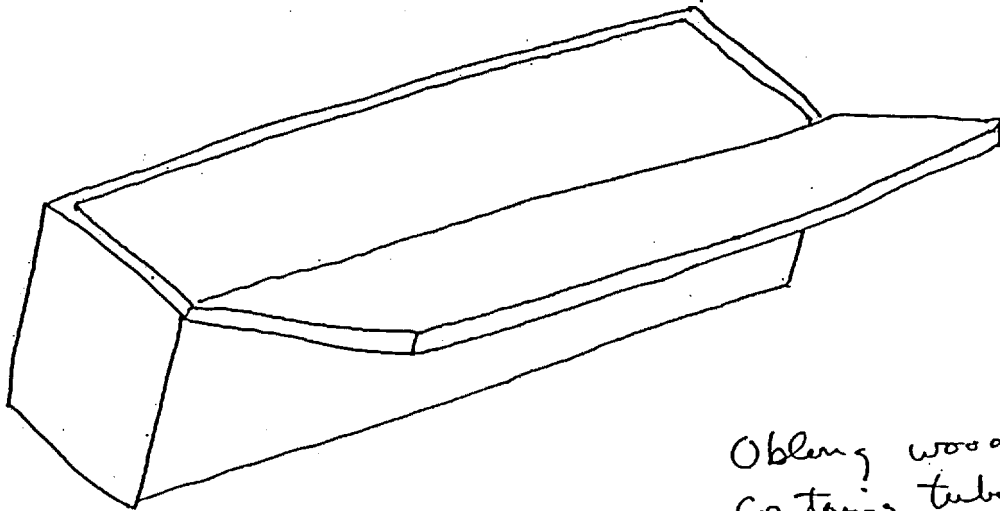

Oblong wooden box;
contains tube-like
object; object sits off
to one side.

b₂)

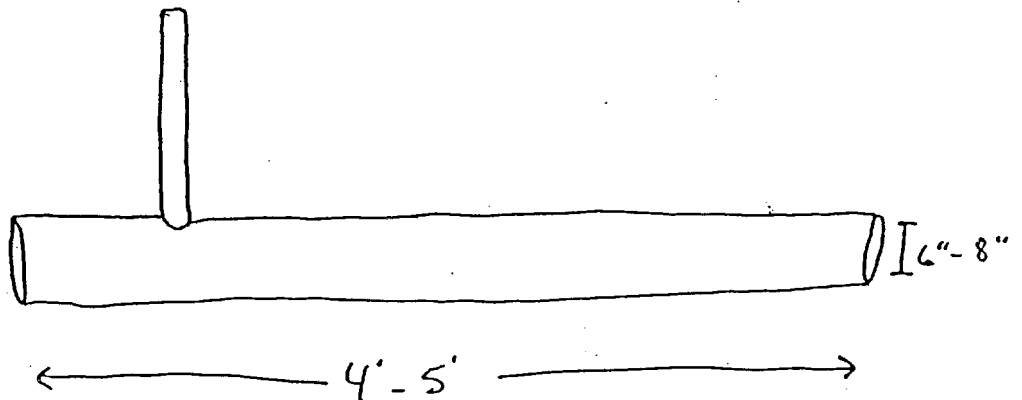

Object within above box; lies on its side;
packed with soft material.

~~SECRET~~

NOFORN
STAR GATE

LIMDIS

~~SECRET~~

a)

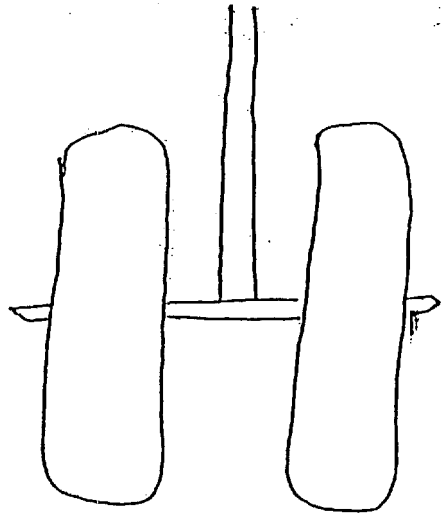

b)

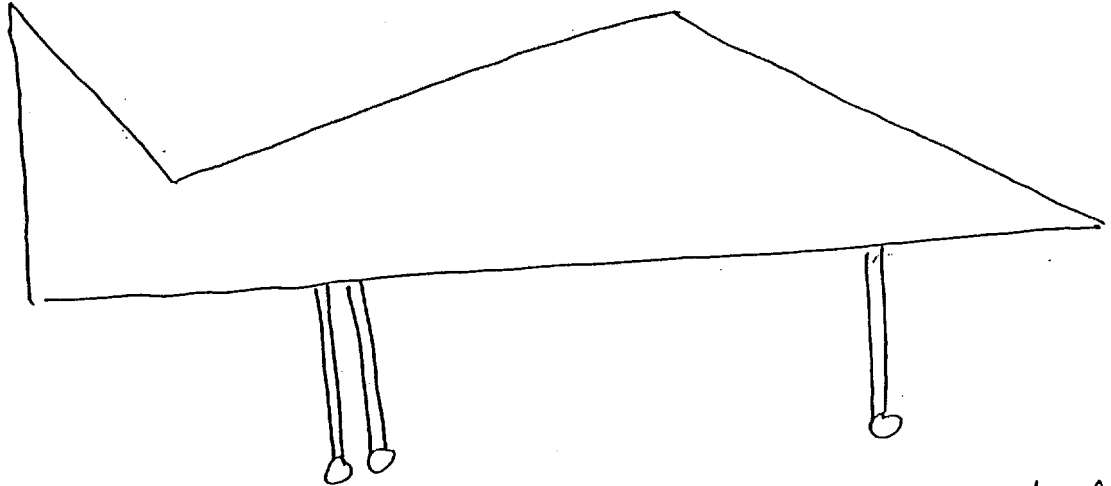

Silhouetted: Sits high above the wheels

c)

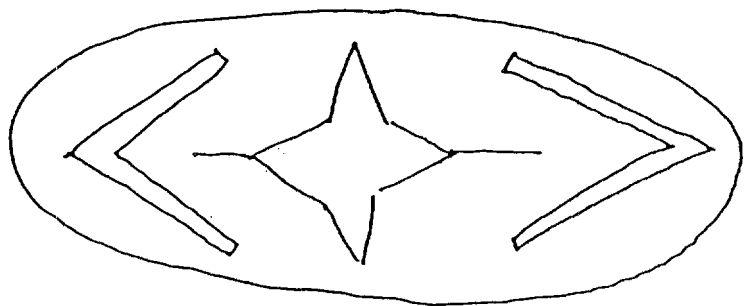

Unknown object / feature

~~SECRET~~
NOFORN
~~STAR GATE~~
LIMDIS

~~SECRET~~

a)

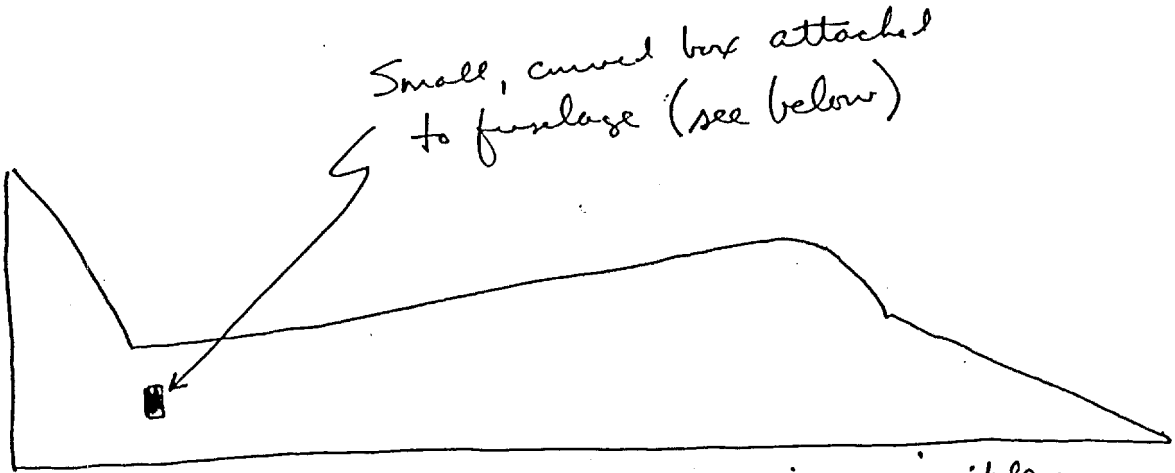

Small, curved box attached to fuselage (see below)

Isolated aircraft; no engines visible; Silhouetted against a bright background.

b.)

View of under-side of curved box

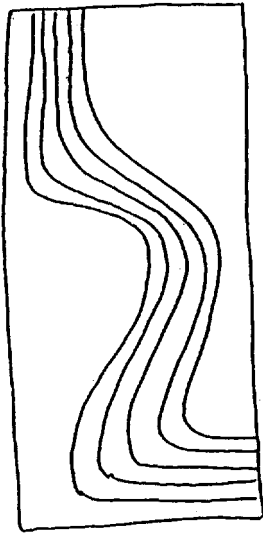

outline of fuselage

b2)



"Side view"

* Curved box from above aircraft

~~SECRET~~

NOFORN
STAR GATE
LIMDIS

~~SECRET~~

a₁)

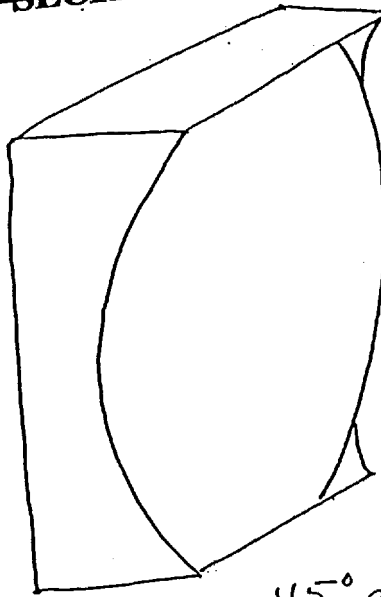

45° angle view

a₂)

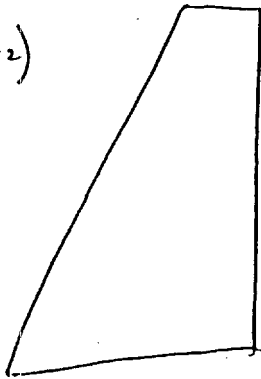

Side view

* There is a row or alignment of these objects; all similarly shaped; dark colored; huge.

b)

POSITION OF INDIVIDUALS IN MEETING.

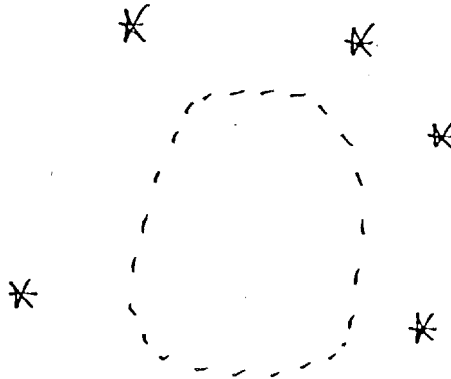

(see next page)

~~SECRET~~

NOFORN
STAR GATE
LIMDIS

~~SECRET~~
LARGE OPEN AREA WITHIN VERY
LARGE STRUCTURE

a)

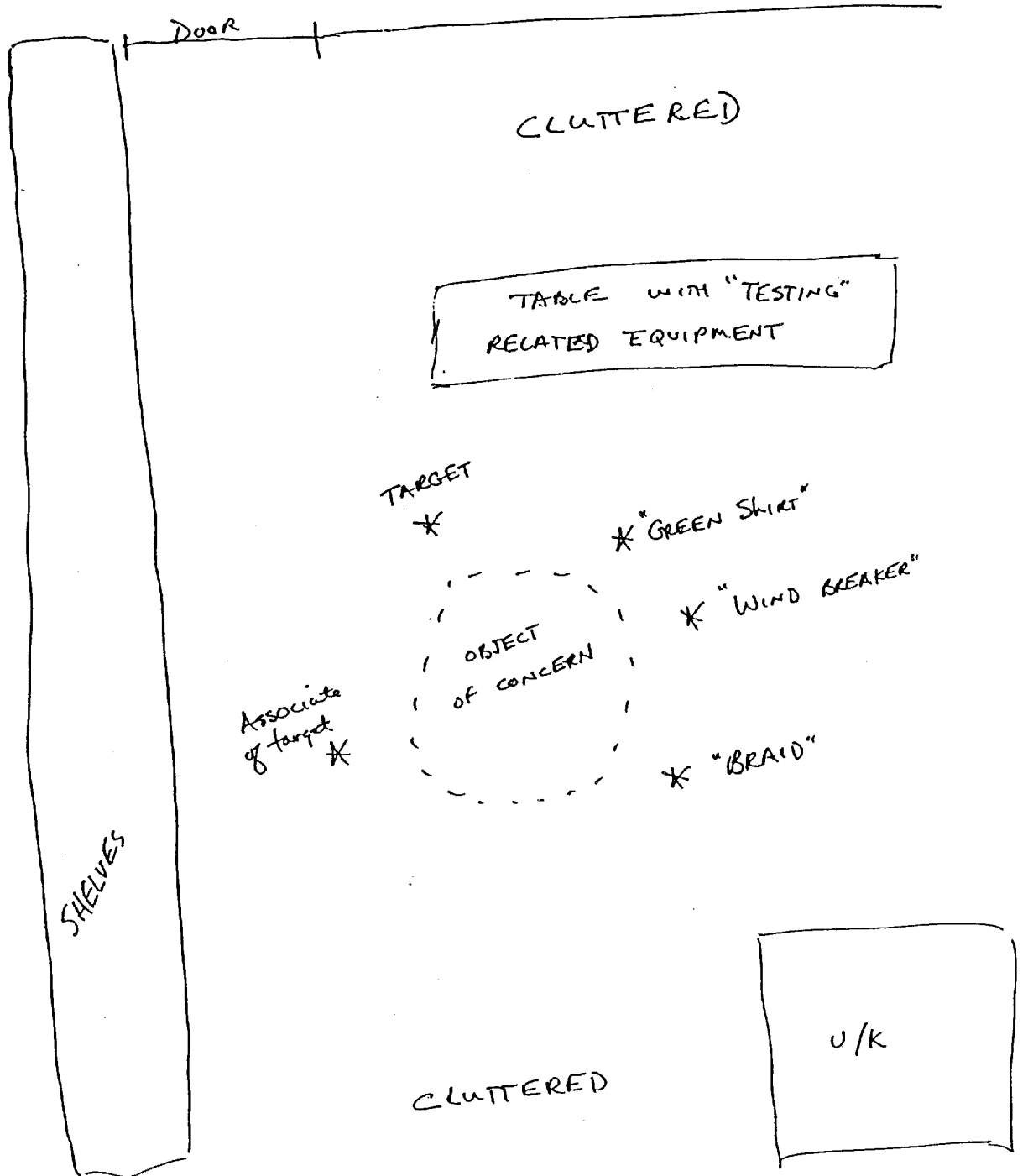

LAY-OUT OF OFFICE / LAB WHERE
MEETING OF INTEREST OCCURS

~~SECRET~~
NOFORN
STAR GATE
LIMDIS