

~~SECRET~~

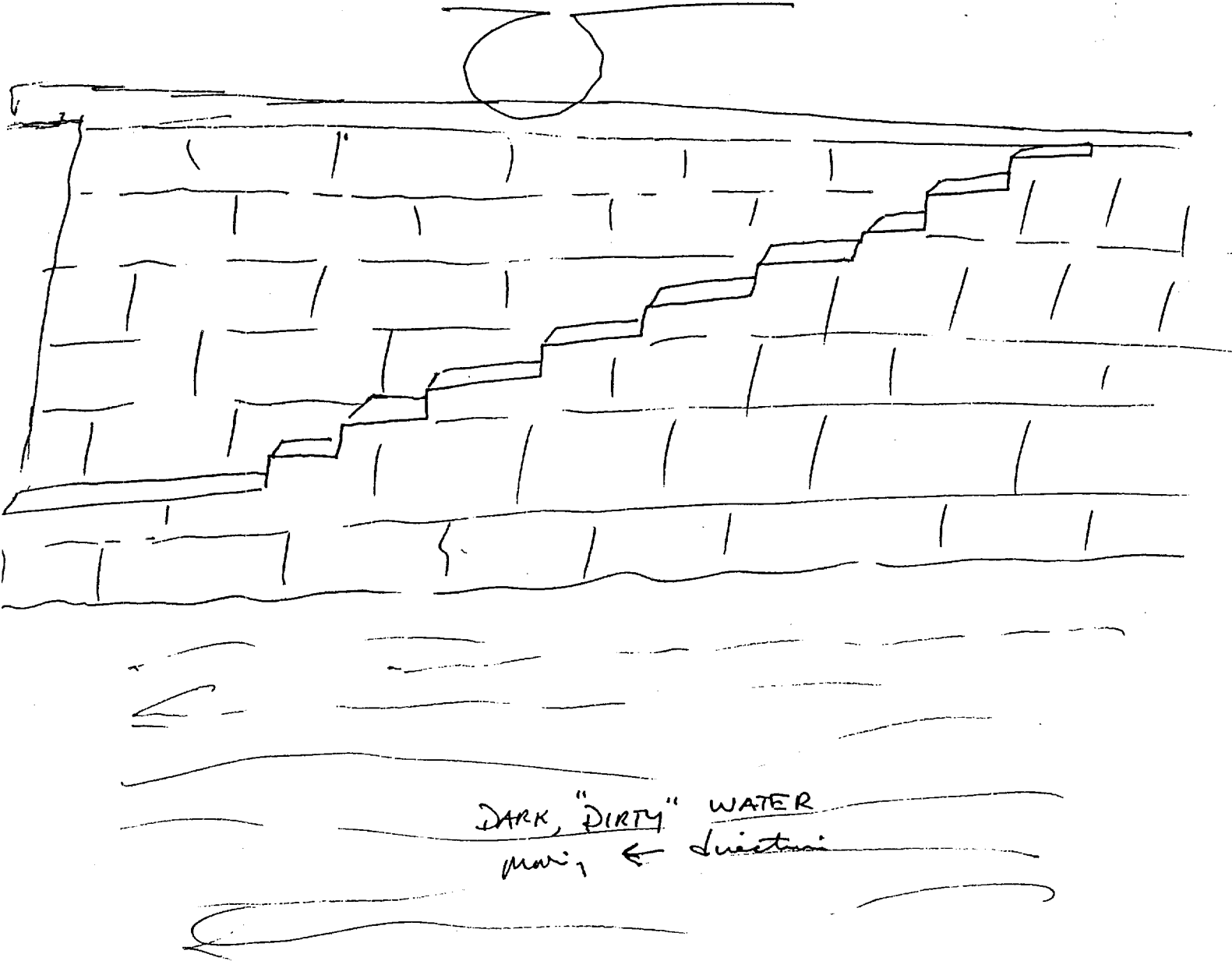

~~SECRET~~
NOFORN
STAR GATE
LIMIDS

~~SECRET~~

Approved For Release 2001/03/07 : CIA-RDP96-00789R002500110005-8

Unidentified figures / concepts

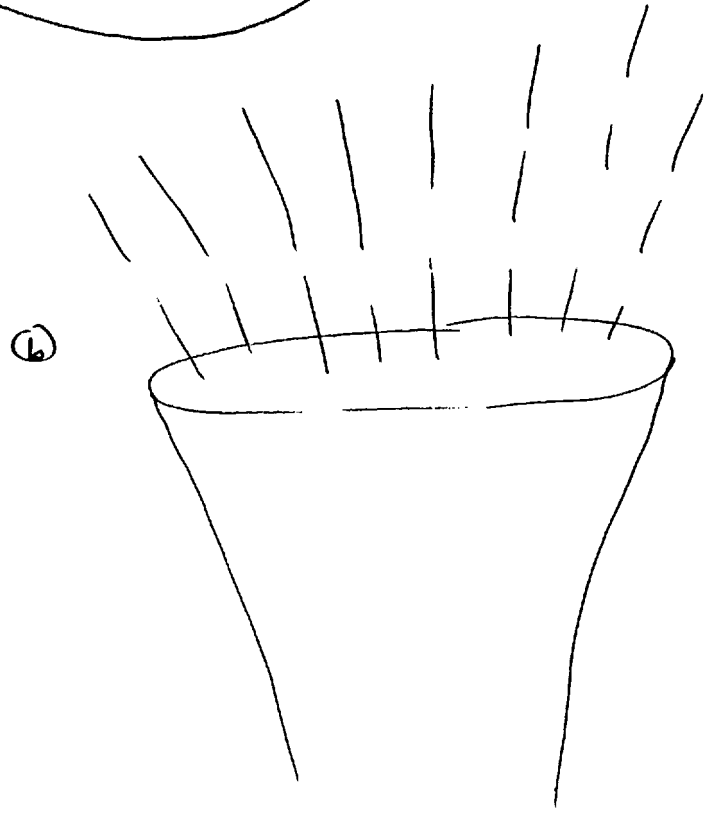
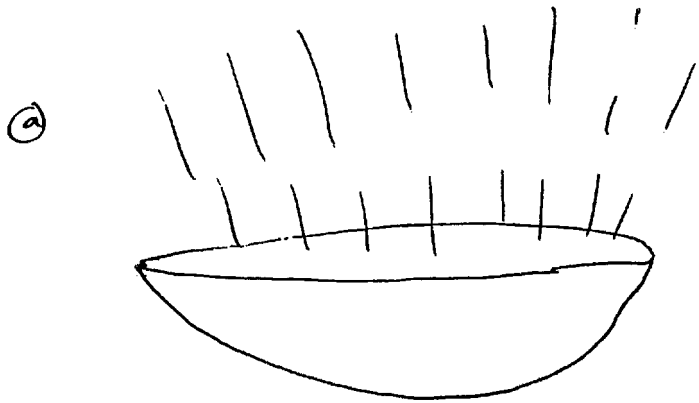

~~SECRET~~

NOFORN
STAR GATE

Approved For Release 2001/03/07 : CIA-RDP96-00789R002500110005-8

ATTACHMENT B

(b)

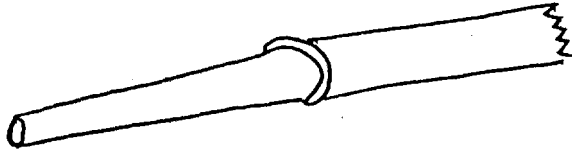

"concept of
- Binder cap"

(c)



(d)

liquid material

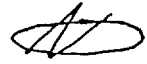

inverted "cone" shape

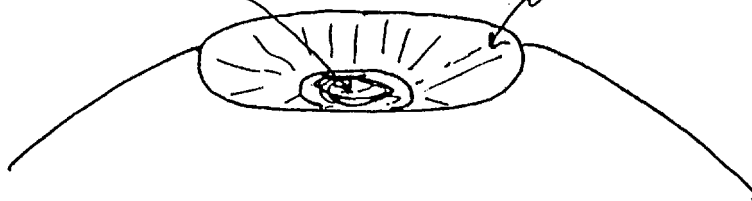

~~SECRET~~

NOFORN

STAR GATE

LIMDS

~~SECRET~~

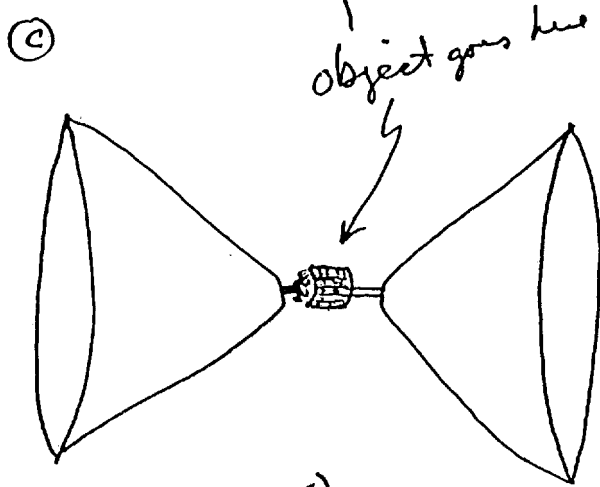
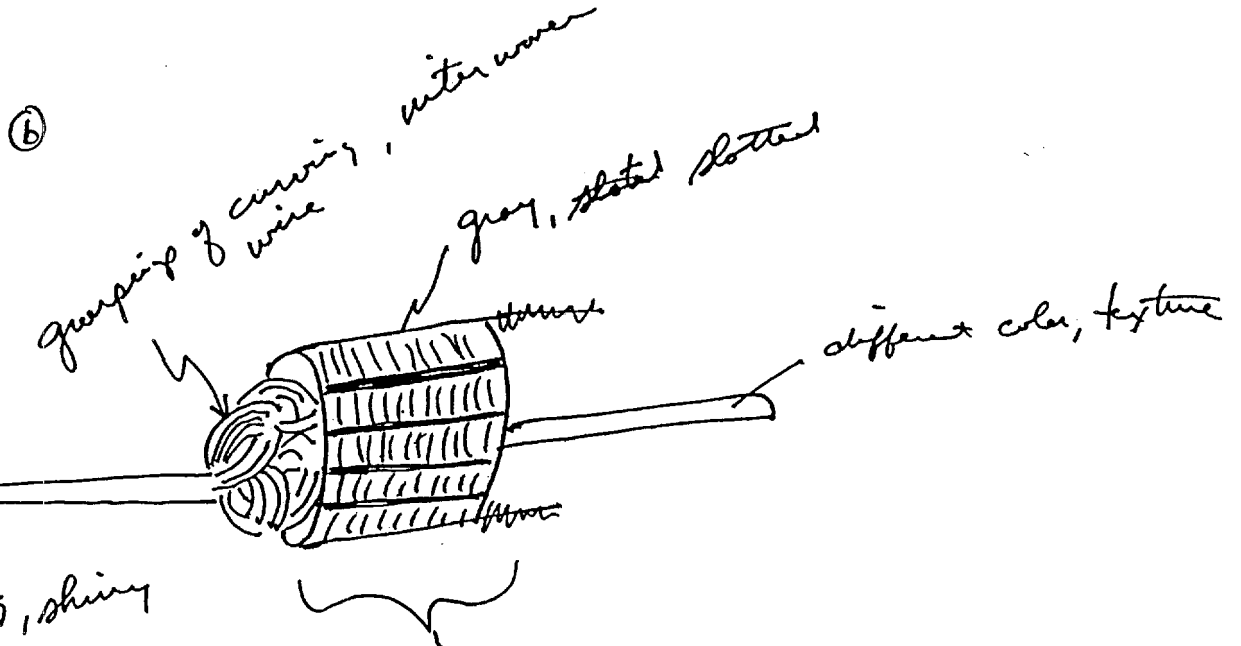
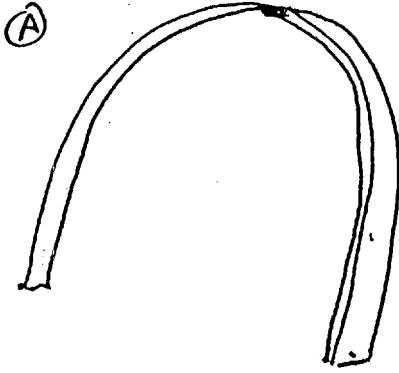

- concept of inverted cones

~~SECRET~~
NOFORN
STAR GATE

~~SECRET~~

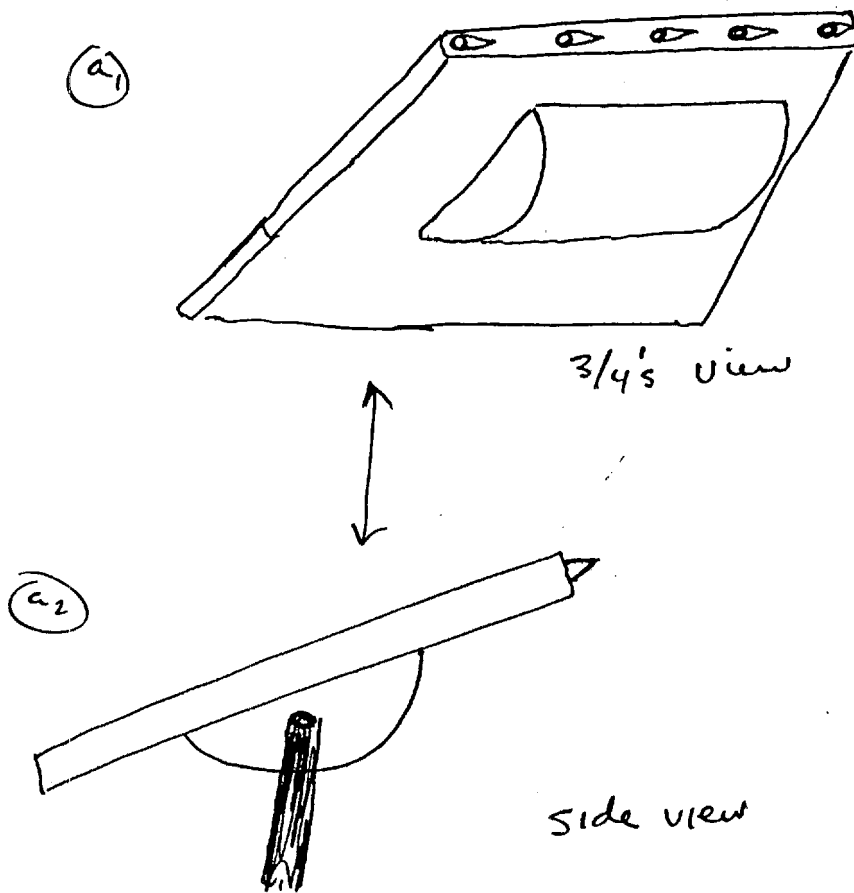

~~SECRET~~
NOFORN
STAR GATE

SESSION INFORMATION

- A. TARGET DATA:
Task/Target No. : 94-232-0
Session No. : 01
- B. PERSONNEL DATA:
Source No. : 049
Monitor's No. : NA
Beacon/Sender No. : NA
- C. SESSION DATA:
Date Task Received : 7 APR 94
Session Date : 8 APR 94
Start Time : 1200
Stop Time : 1310
Method Used : CRV
Distractions (PIs) : Sinuses; worn out!
Pre-session Hunches (AVs) : None
Date Summary Returned : 8 Apr 94
- D. EVALUATION DATA:
Viewer's Estimate :
Evaluator's Estimate :
- E. SESSION SUMMARY:

The target individual is middle aged, has pudgy cheeks and a pot marked complexion, wears glasses, is over weight (has a round body shape) and deals with electronically related stuff. He is preoccupied with the concept of a "flip chart"(?).

He is a womanizer, frequents "girly" shows/institutions, is a control freak and a real pig (i.e. slime ball). The concepts of unsavory and unrepentant are associated with this individual.

His activities will involve watching a portion of a river-like body of water and the traffic moving upon it. It will be a location where steps lead from a higher level downward along a stone block wall to just above the water surface (see sketch). The water here is dark gray/green and feels really dirty. The surface appears lumpy and stringy at times.

There is a "V"-shaped trough or canal within this vicinity. It is steep, the sides are hard like cement, slippery and gooey, it smells stagnant here and the "exit" appears to be suspended several feet above a lower level. There are the concepts of underground and emerging associated with this feature.

The target's intentions are associated with the following concepts: projectiles/missiles/rocket; a glowing substance shooting out of a pointed object; a fast, linear movement; slowing rotating motion; direction; and sensing.

The term "Binder Cap" is also associated with what this individual is up to.

All of the sketches relate to what the target is involved with. It feels as if he is involved with a connection with a Middle Eastern regime; one that does not feel too friendly.

Other unidentified or seemingly disassociated concepts, figures, etc. are:

- a series of "V"-shaped angles superimposed upon one another.
- spinning motions which feel to simultaneously spin in both a vertical and horizontal direction.
- something or someone being "out-of-place".
- structures reminiscent of stone-lined tunnels or sewers.
- a cross-shaped object which sits atop a tall pole.
- computers.
- "super gun" (?).
- "sighting" apparatus.
- inverted cones.
- tracking.
- projectiles.
- electric motor armature.

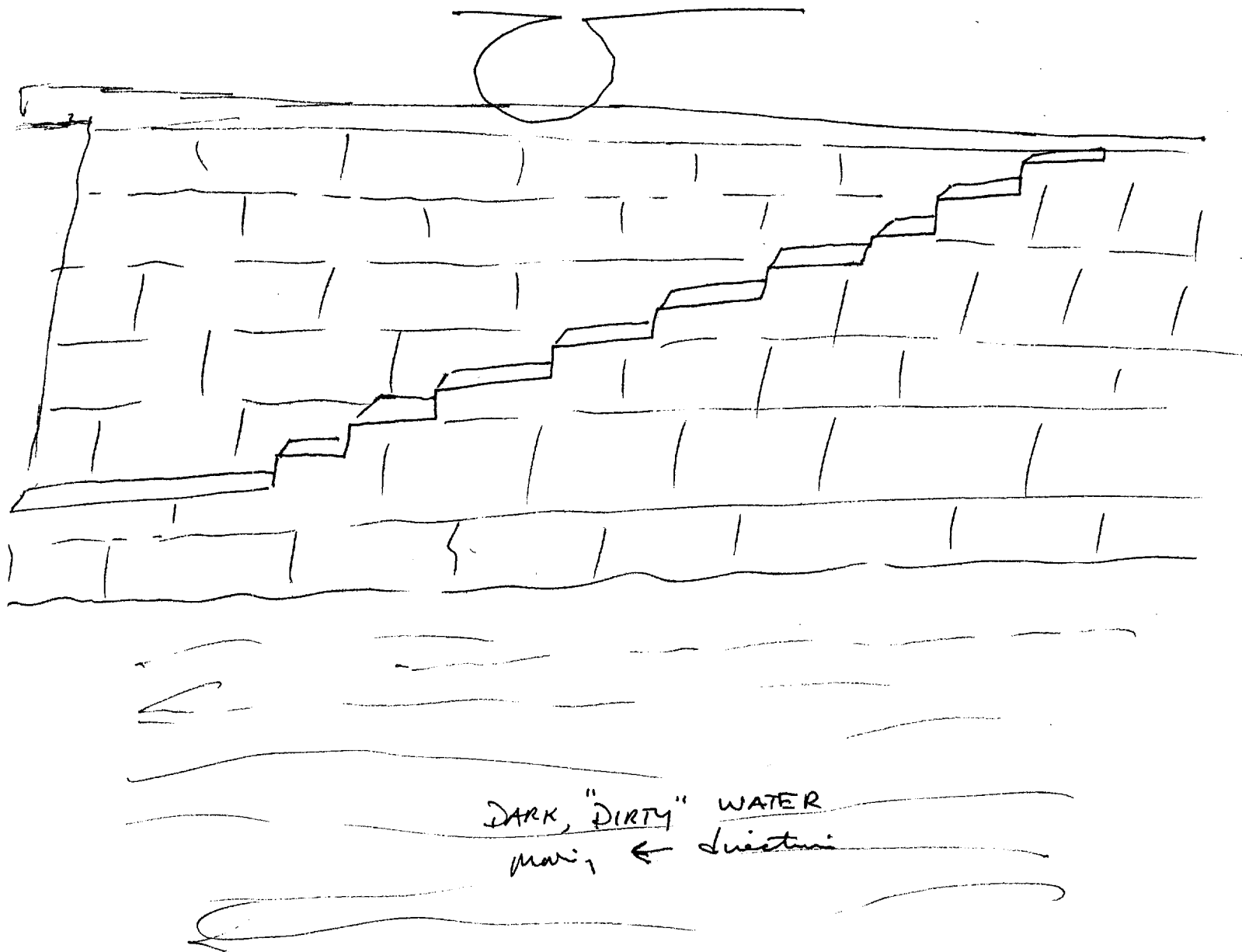

Unidentified figure, possibly

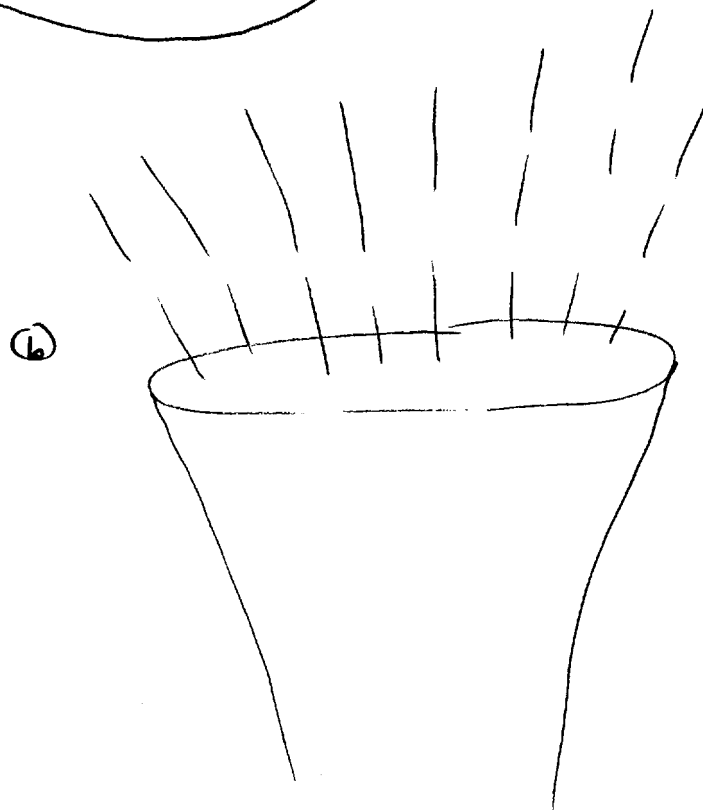
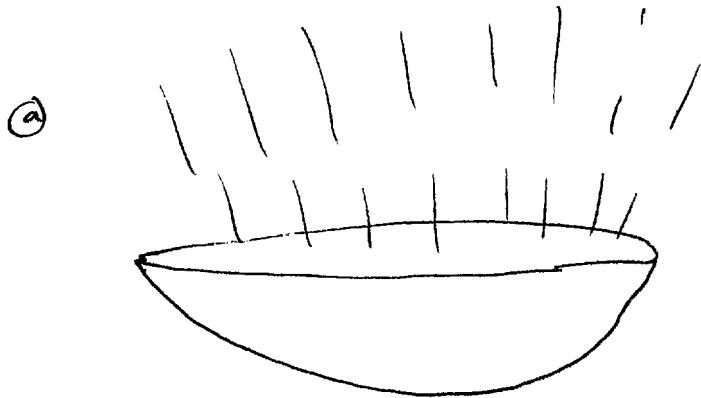

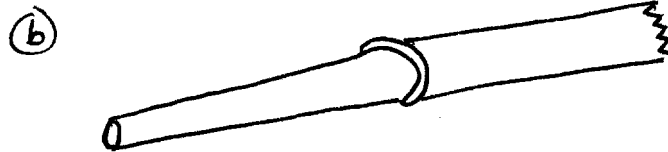
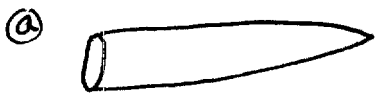

— "concept of
— Binder "cap"

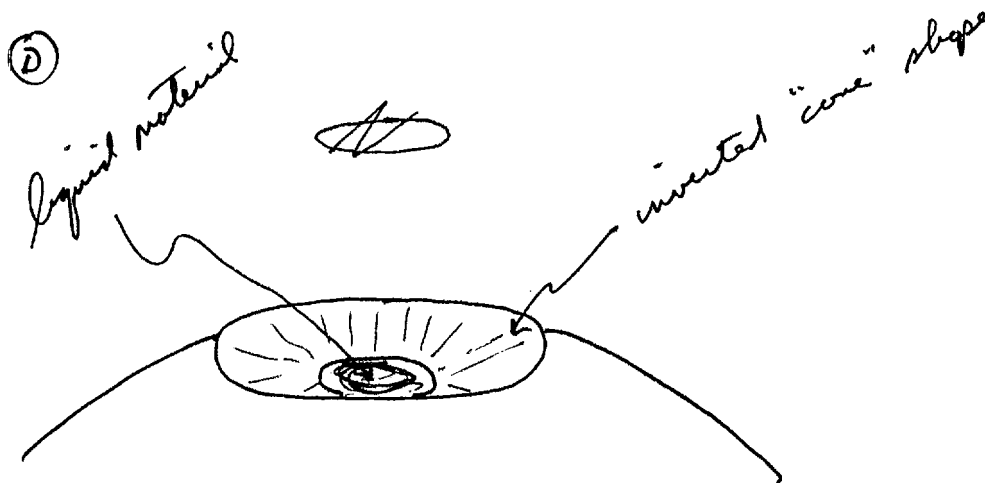

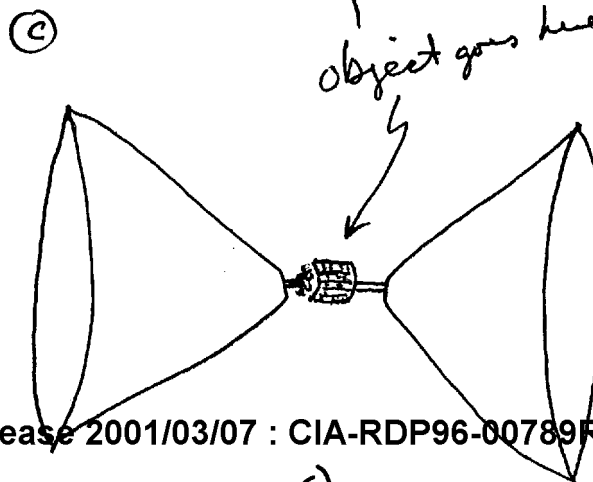
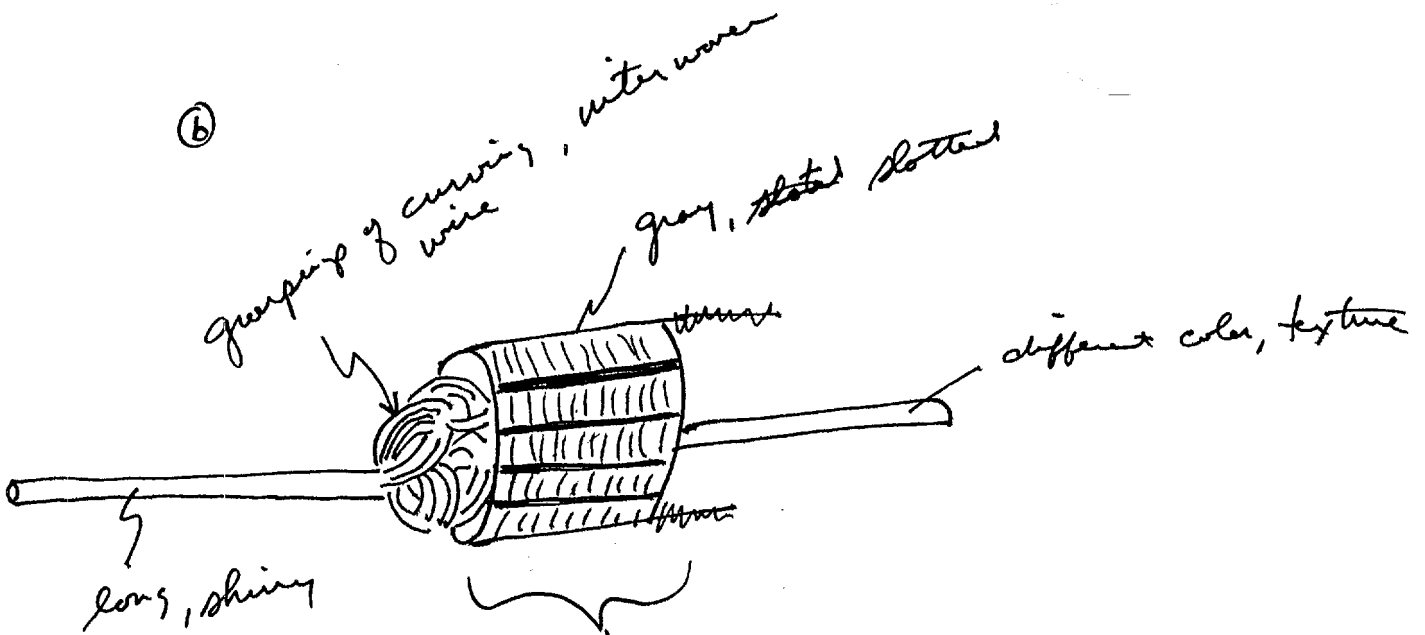
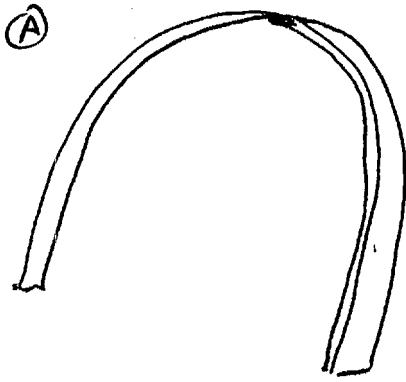

- concept of inverted cones

