

~~SECRET~~

PROJECT SUMMARY

- A. (U) DATE: 1 Oct 91
- B. (U) PROJECT: 91013
- C. (S/NF/SG/LIMDIS) TASK: Describe activities depicted on sealed photograph; provide any relevant information.
- D. (U) RESULTS:
1. (U) SOURCE A
 - a. (U) DOI: 27 Sep 91
 - b. (S/NF/SG/LIMDIS) SUMMARY:
 - (1) AREA: Storage facility, possible Eastern or Asian location. Near a cliff area.
 - (2) ASSOCIATION: Munitions present; long slender objects/nozzles; chemicals or gas; affects breathing.
 - (3) ACTIVITY: Possible testing (objects fly into cliff area); possible future tank deployment.
 2. (U) SOURCE B
 - a. (U) DOI: 30 Sep 91
 - b. (S/NF/SG/LIMDIS) SUMMARY:
 - (1) AREA: Dark, hollow location; sterile environment; numerous interconnected structures, with recesses, cavities, and underground conduits.
 - (2) ASSOCIATIONS: Numerous objects (like turning cylinders---see sketches). Sense of a vacuum present; sense of a green passage; sense of high energy, rocking motion.
 - (3) ACTIVITY: Like a filtration process; liquid-like

~~SECRET~~/NOFORN/LIMDIS
STAR GATE

~~SECRET~~

substance moving through a tube.
Spinning; centrifugal forces are
involved.

3. (U) SOURCE C

a. (U) DOI: 27 Sep 91

b. (S/NF/SG/LIMDIS) SUMMARY:

(1) AREA: Flat, open area, with few structures.

(2) ASSOCIATIONS: Truck-type vehicles are in area;
large round objects; long,
straight stacked objects; large
glowing red circular shape;
scientific sense; association to
clear liquid, rods.

(3) ACTIVITY: Elaborate production, equipment
movement; sense of energy or light.
Sense of shaking (when equipment
operating).

4. (U) SOURCE D

a. (U) DOI: 27 Sep 91

b. (S/NF/SG/LIMDIS) SUMMARY:

(1) AREA: Large, outside area; some buildings

(2) ASSOCIATION: Large bundles of documents with
blue markings are in building.

(3) ACTIVITY: In past, explosions had occurred
nearby. Current situation
(associated with building) seems one
of unsuccess; possibly a "hold-out"
situation involving old vs new people
or ideas.

~~SECRET~~ NOFORN/LIMDIS
STAR GATE

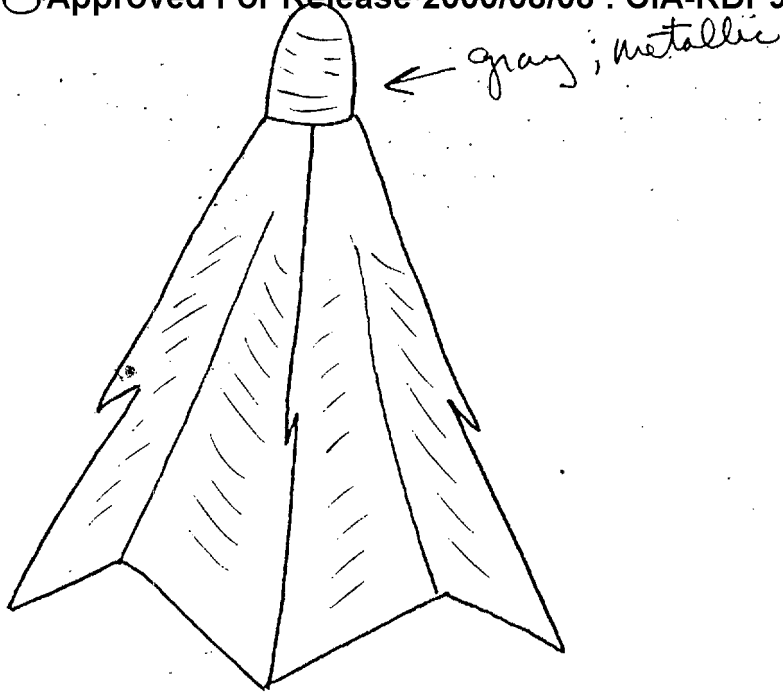

u/I object

Q

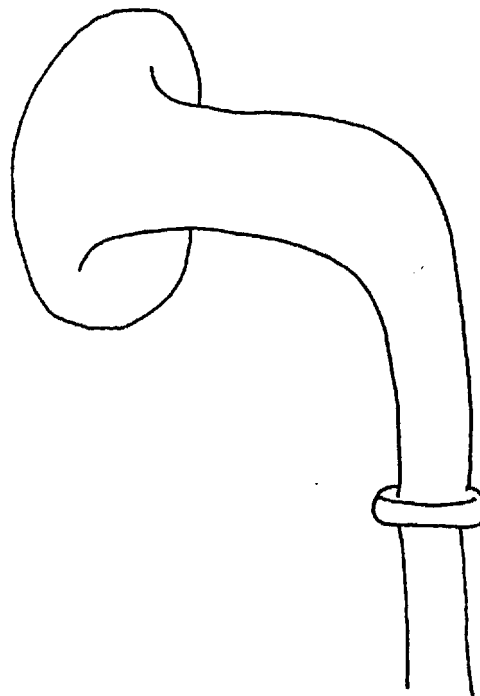

u/I object

079-1

Q

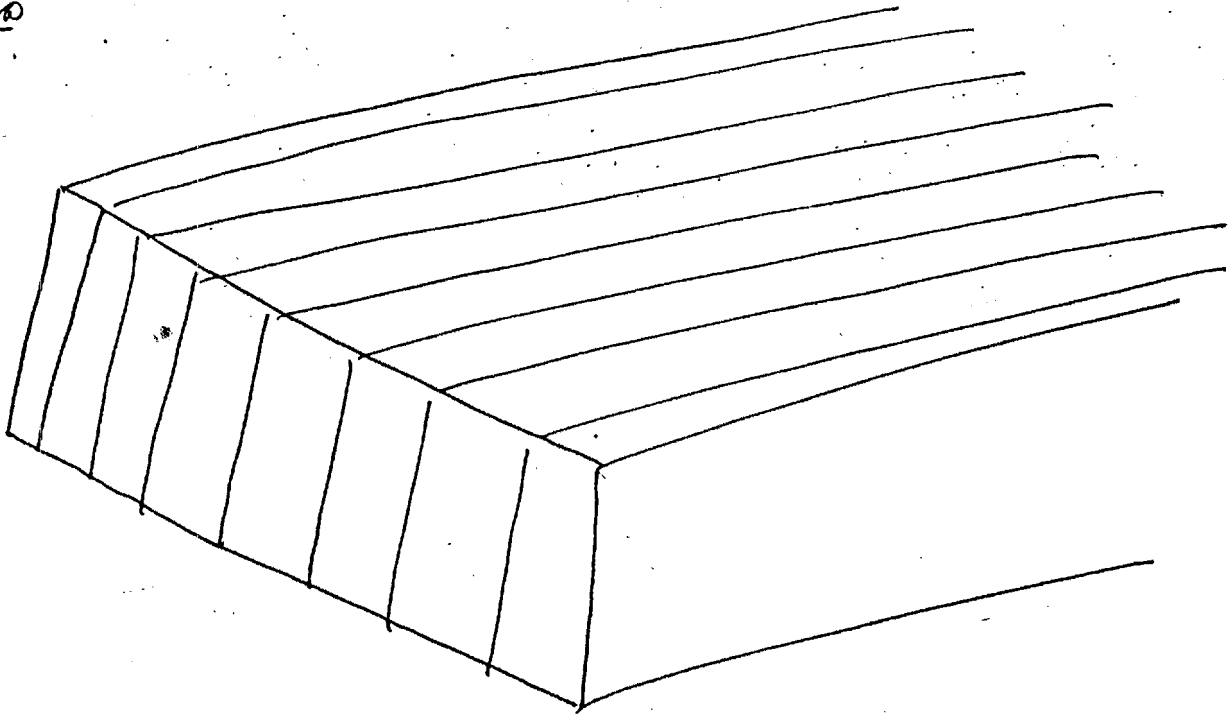

1/1 object

Q

* some sort of "flap" that flips out from main body of larger object

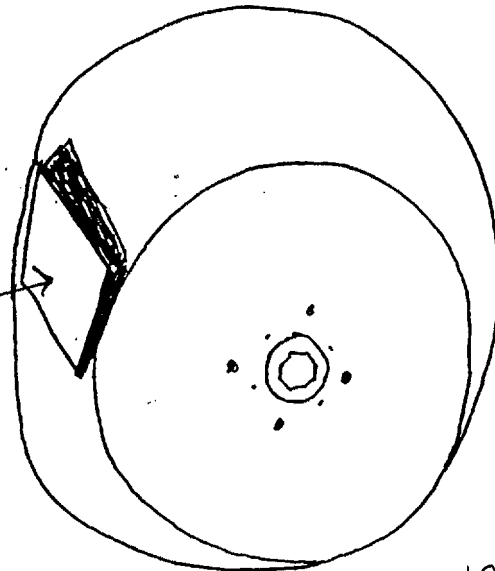

* slowly turning; "flap" like feature used for passing of something, either into, or out of, circular object.

079-2

(a)

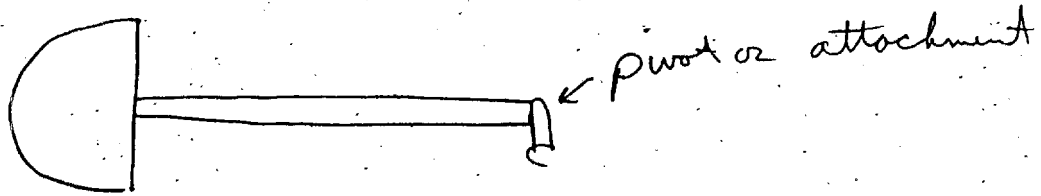

V/I object which slowly moves back
in forth in a fan-like motion

(b)

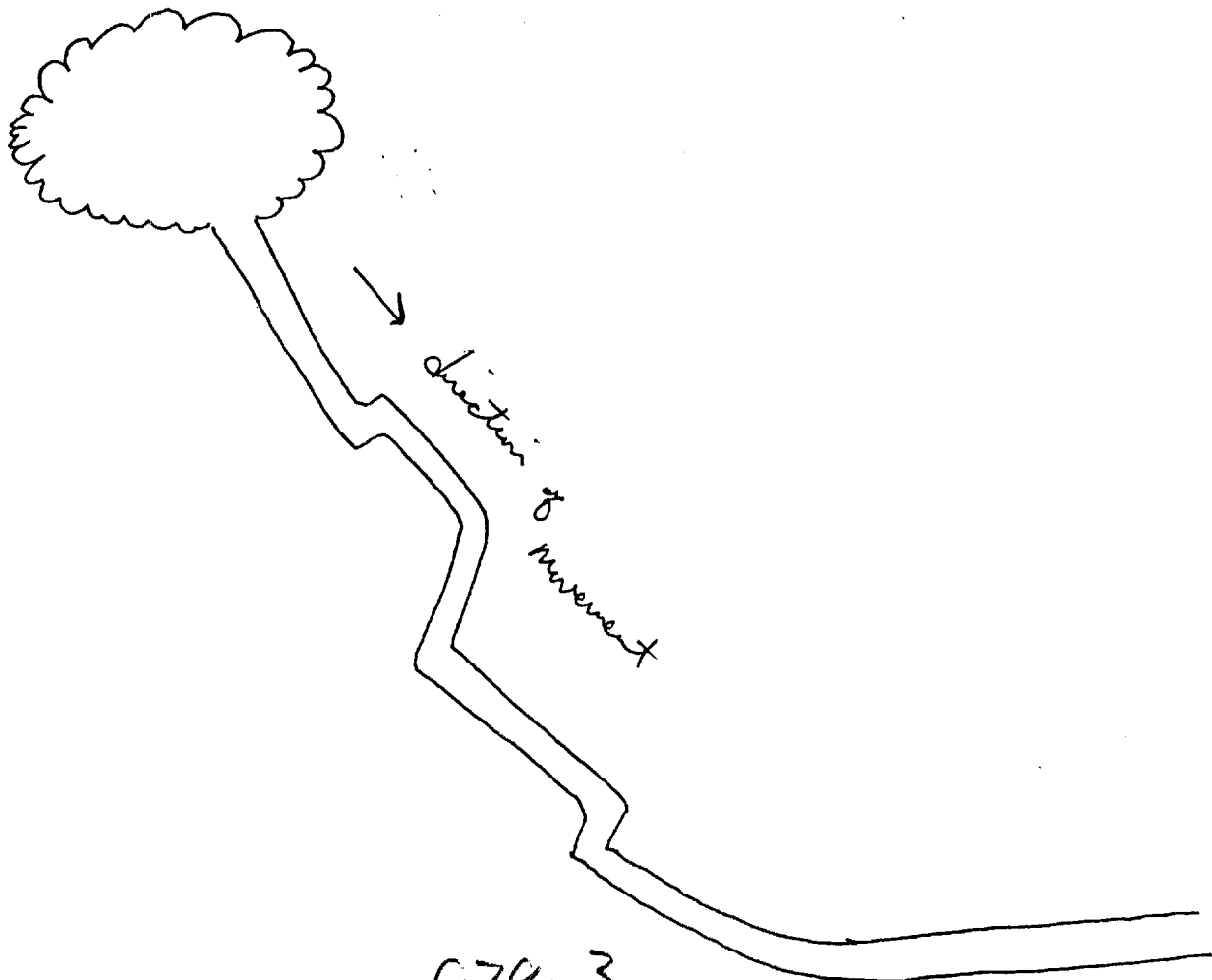

079-3

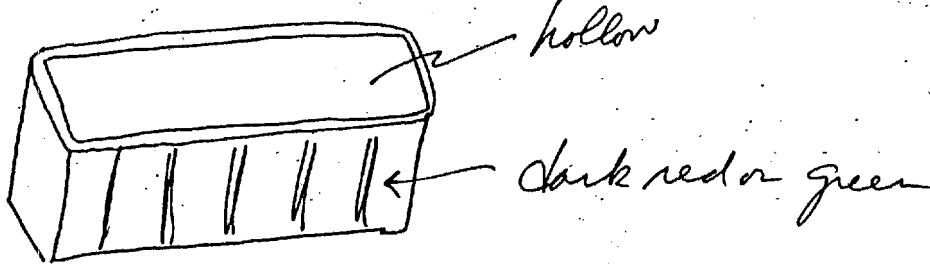

u/I object

(B)

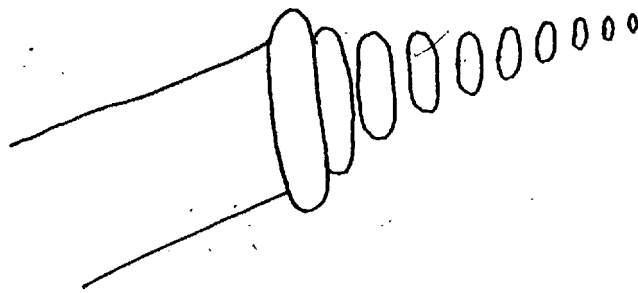

u/I object associated with pulsations & high energy

079.4

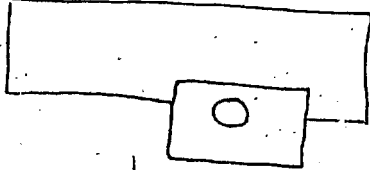

* overhead view

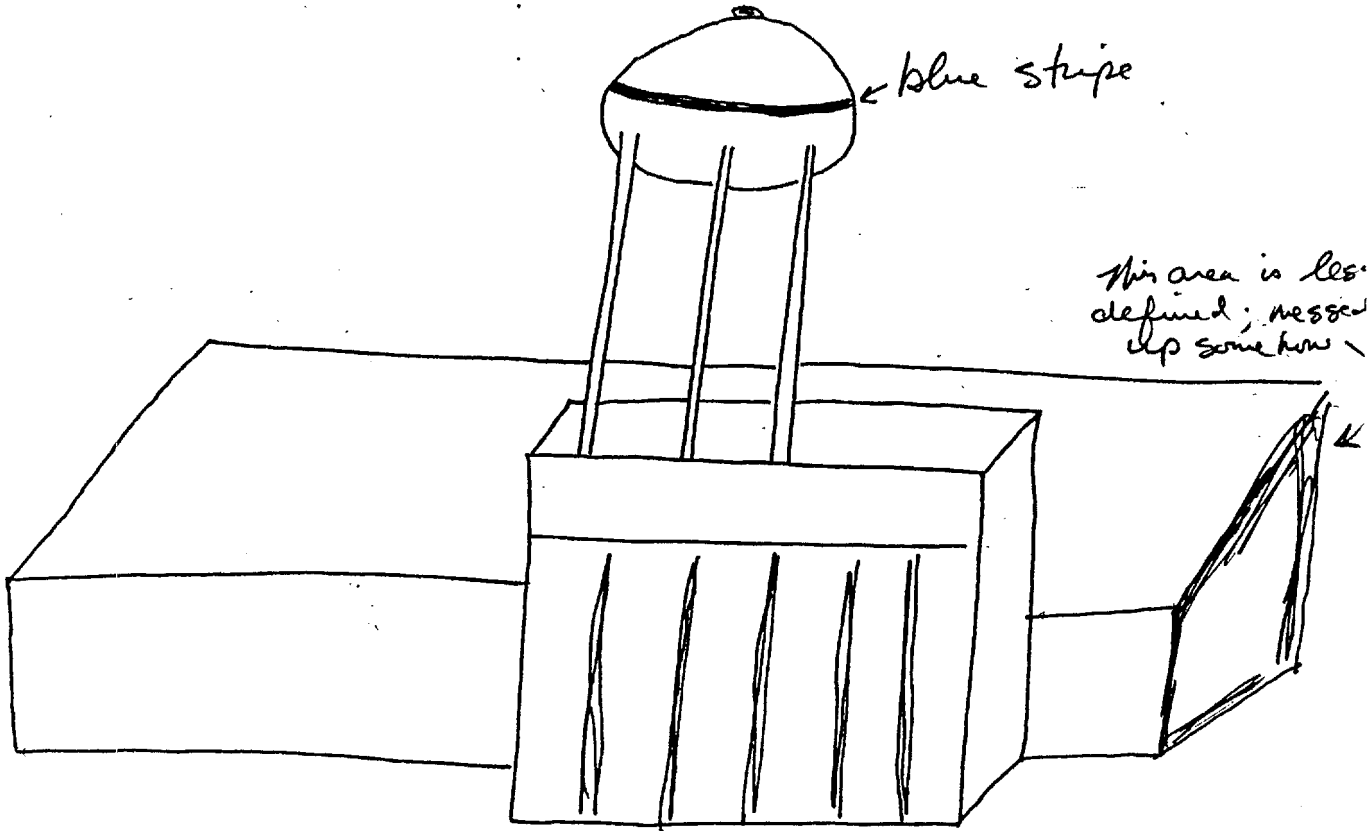

* side view

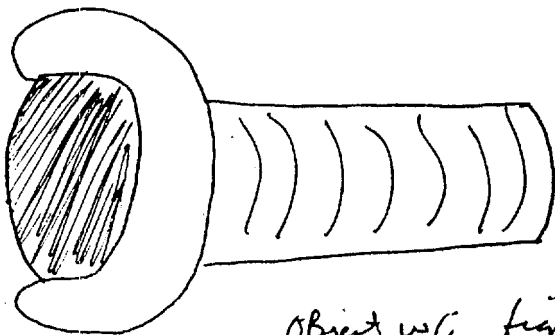

Object w/o figure above; hollow, large,
rounded end at "opening"; spinning.
070-5

U/I object

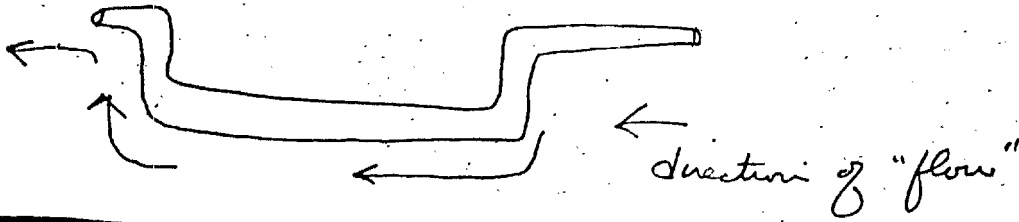

(b)

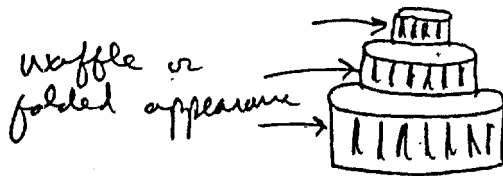

Series of concentric - sized
 air-filter looking objects
 sitting on top of one another,
 spinning, at different
 speeds relative to each other

(c)

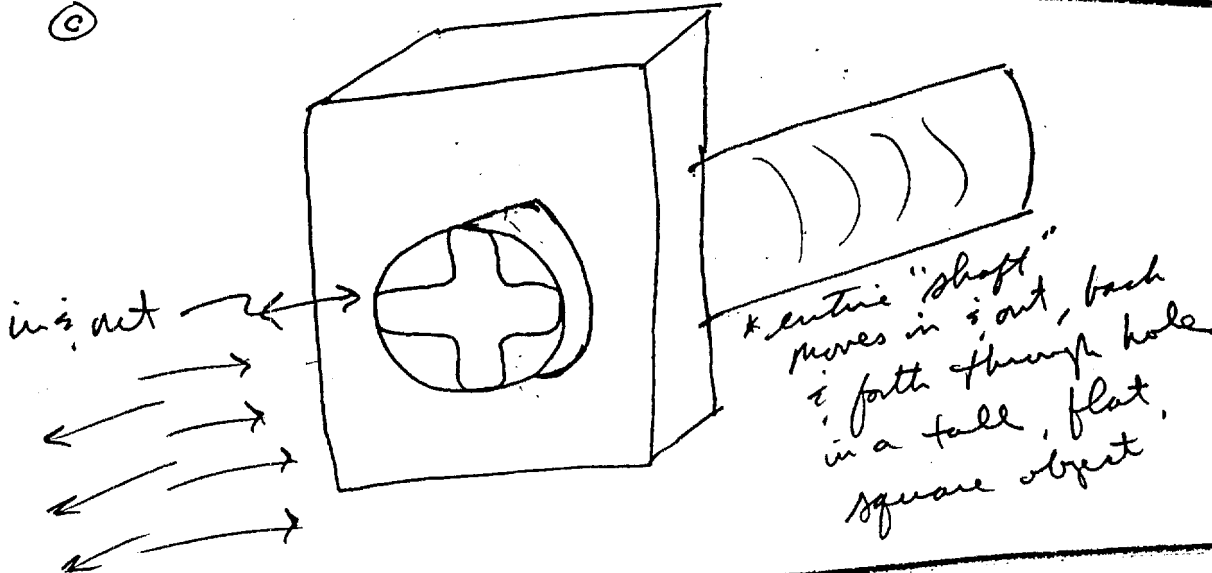

(d)

* series of convoluted
 features; some sort
 of material passes
 or moves through
 or around them.
 Concept of filtration.

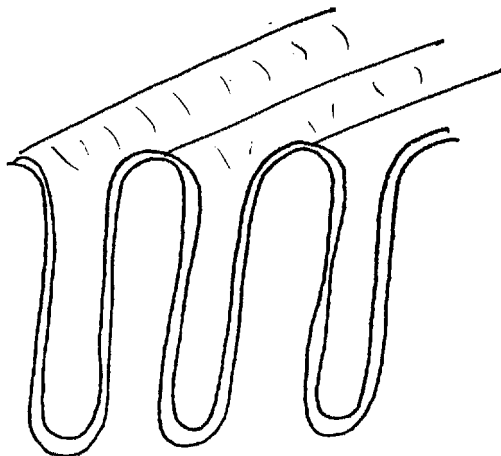

~~SECRET~~

A. Are the assessments accurate? (circle response)

<u>Source A</u>	<u>Source B</u>	<u>Source C</u>	<u>Source D</u>
(1) Yes (true)	(1)	(1)	(1)
(2) May be true	(2)	(2)	(2)
(3) Possibly true	(3)	(3)	(3)
(4) No	(4)	(4)	(4)
(5) Possibly not true	(5)	(5)	(5)
(6) Unsure)	(6)	(6)	(6)

B. What is value of the Source(s)' assessments: (circle response)

<u>Source A</u>	<u>Source B</u>	<u>Source C</u>	<u>Source D</u>
(1) Major significance	(1)	(1)	(1)
(2) High value	(2)	(2)	(2)
(3) Of value	(3)	(3)	(3)
(4) Low value	(4)	(4)	(4)
(5) No value	(5)	(5)	(5)

C. Rationale for source evaluation. Provide rationale/analysis which led to your evaluation of responses provided above. Include confirmatory/new confirmatory data and whether collection requirements are currently validated/tasked to either obtain or verify such data. Please provide your written evaluation by source.

D. _____
NAME OFFICE/PHONE NUMBER

LIMITED DISTRIBUTION NOT RELEASABLE TO FOREIGN NATIONALS

~~SECRET~~