

**ILLEGIB**

**Approved For Release 2001/03/07 : CIA-RDP96-00789R001200140002-2**

**Approved For Release 2001/03/07 : CIA-RDP96-00789R001200140002-2**

UNCLASSIFIED

WORKING PAPER

Target #:  
Date: 28 June 90  
Time: 0942-1415  
Viewer: 052  
Session: 01

SUMMARY OF INFORMATION:

The target is a structure and land. There are angles and a diagonal at this site. Something about this site makes my nose burn and itch. The structure is long, tall, narrow and dome-shaped. The sides are smooth, hard, and could be made of glass. They curve and bend outward. The structure is shiny and bright. It has a flat top and a flat bottom. There is something diagonal off to the side of the structure, it makes me think of a lightning bolt.

There are many people inside this structure. They are doing something together. The theme seems to be "get down." The activity directly related to the structure is hot smoke. The structure is on fire and 55% of the people survived.

052

28 June 90  
Ft. Meade  
0942  
072

PI: none  
AV: none

539143  
574057

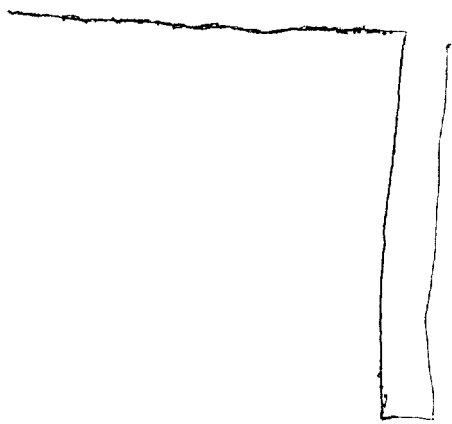

A. Wavy Access  
hard  
B. Land  
  
A. Angle  
hard  
B. Structure

539143  
574057

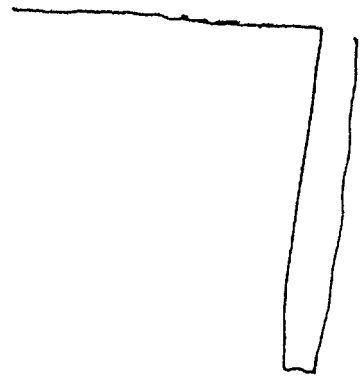

A. flat, across  
hard  
B. canal  
A. angle  
hard  
B. structure

52

Black  
Blue  
horizontal

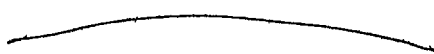
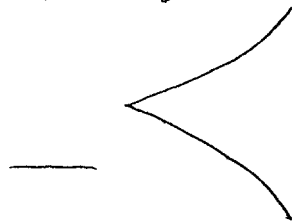

Angle

green

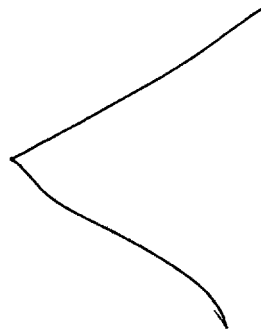
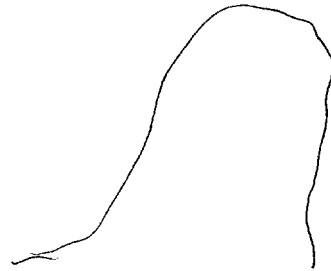

Angle

Blue

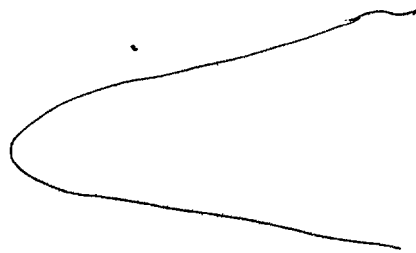

long  
narrow

AOL BK  
ship

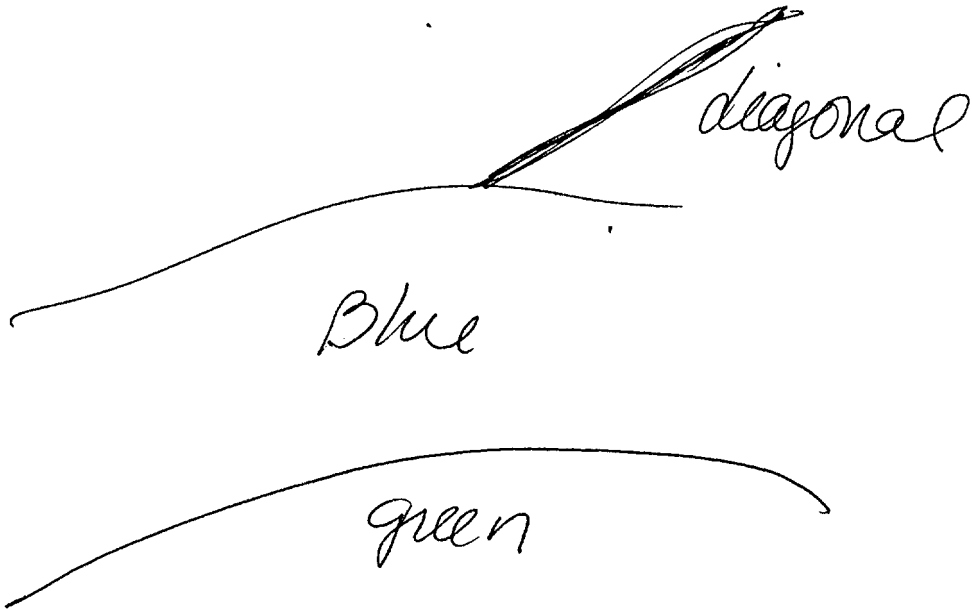

AZ BK  
makes me  
want to sneeze



54

S2

D AI EI TI AOLA/S

Blue



A/S

Ship That's  
Carrying cocaine  
(OP)

Conf BK

Is water  
there ?

Blue  
Green

diagonal

S2 Q AI EI T I ADC A/S



Angles

Sneeze  
(itchy nose)

people

A/S  
Rocks

(structure)

Blue

Red

cloudy



diagonal



S2 O AI EI T I ADZ A/S  
(structure)

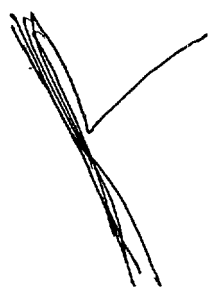

Angle

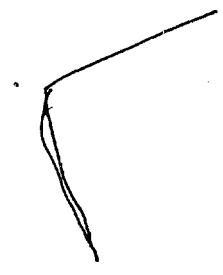

itchy  
nose itchy  
burning  
in my nose

A/S  
dome shaped -  
something in  
a dome



S2 O AI EI TI AOL A/S  
(Structure)

Red  
Blue

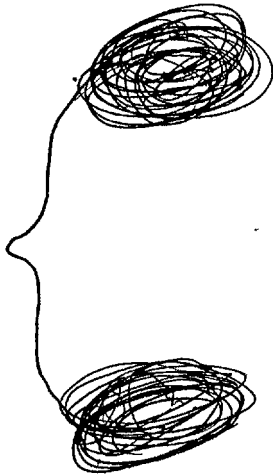

A/S  
something  
inside  
this thing

people

A/S  
glass



S2 D AI EIT I ADL A/S

Interim Summary.

The target is a structure and land.

There are angles and diagonals at this site  
Something about this site burns and  
itches my nose.

There is something dome shaped  
and something inside this thing.

Glass and rocks are a part of this site

There are people at this site.

There is something long and narrow.

S2 D AI EI T I ADL A/S

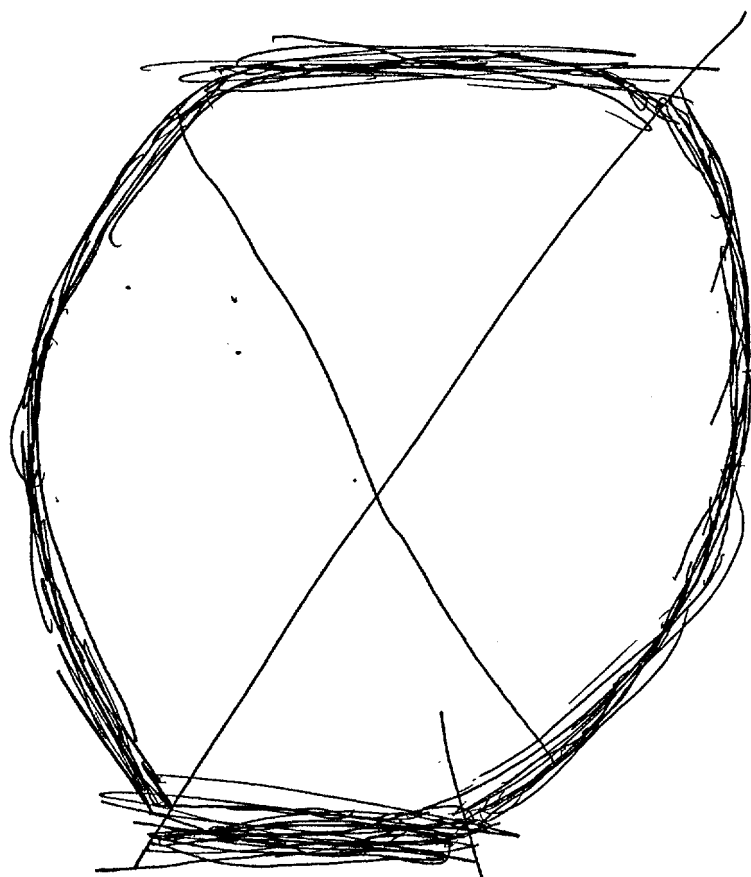

hard glass

people inside

~~ADL~~  
A/S  
Barrel

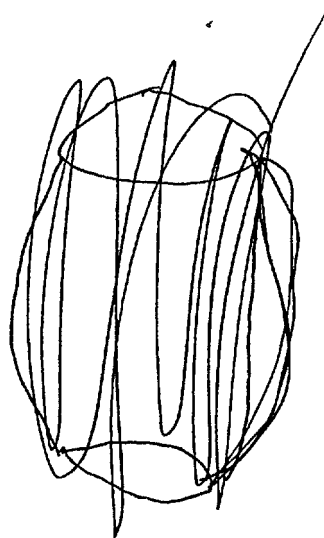
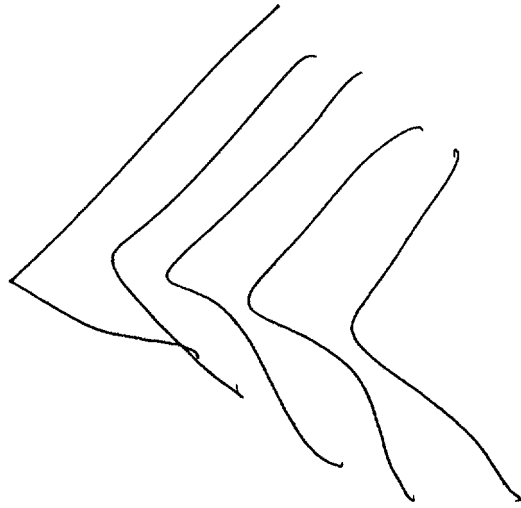

page 2

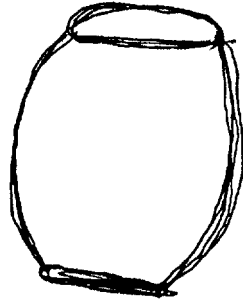

ALS  
Barrel  
&  
Gunpowder

56

page 13

S2 O AI EI TI AD AS  
(structure)

(sides)  
smooth  
hard  
long  
tall  
narrow

Conf BC  
still confused  
as to if there  
is Water there

shiny  
bright

flat top  
" bottom

people

diagonal

AS  
~~lightning~~ Bolt

Slc

S2 D AI EI T I AOL A/S

Diagonal  
off-to side  
of structure

Interim Summary

The structure has a flat top and flat bottom. The sides curve outward and are smooth and hard. They could be made of glass. There is something long, tall, narrow, and a diagonal that is off to the side of the structure. It makes me think of a lecture hall. There are people inside the structure.

BK

1045



1315

539143  
574057

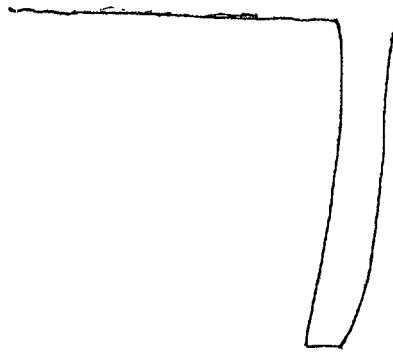

A. Flat across  
hard  
B. land

A. Angle  
hard  
B. structure

94

S2 Q AI EI TI ADL A/S  
(structure)

Black  
blue

A/S  
Burrell

S4

S2 O AI EI T I AOL A/S  
(Structure)



AOL BK  
Halley comet

Blue

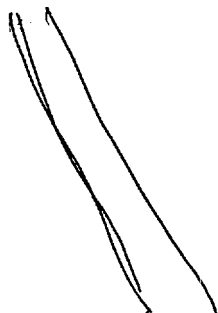

Diagonal

S4 1/2 There is more than one shape  
at this site

(34)

S2 D AI EIT I ADL A/S

The activity of the people at the site is perceptible:

Blue

Green



Bright Angle

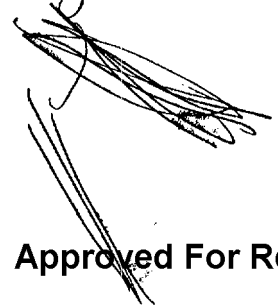

A/S

54

S2 Q AI EITI AOC A/S  
(people's activity)

Blue

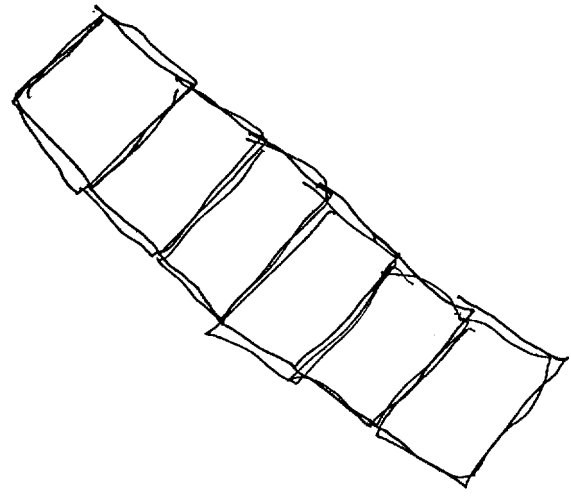

grooves

sitting

A/S  
Space Shuttle

S2 D AI EI TI AOL A/S  
(people's Activity)

S4 1/2 "get down"

A/S  
"get down"

S6

S2 D AI EI TI AOL A/S  
(people's Activity)

yellow  
blue

S4 1/2 people are doing something together. There's more than one person there

S2 D AI EI T I AD C A/S

(codes Activity)



get down  
~~bring~~

A/S  
maybe they're  
listening to  
music

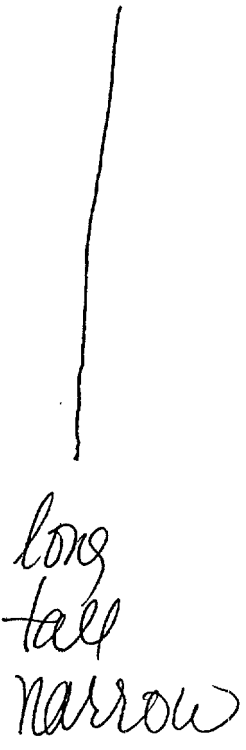

56

S2 D AI EI TI ADL A/S  
(People's Activity)

A/S  
Capitol Hill

Interim Summary:

There are more than one person inside this structure. They are doing something together. The Theme seems to be "get down"

A/S  
Dancing

S2 D AI EI TI ADL A/S

The activity directly related to the structure is perceptible.

Blue  
Hot

S2 D AI EITI AOL A/S  
(Activity Structure)

smokey  
cloudy

A/S  
Structures on fire

S6

S2 D AI EITI AOL A/S

A/S  
Tall Building  
with windows on  
side  
on fire

A/S  
Smokestack  
on fire  
Smoke coming out



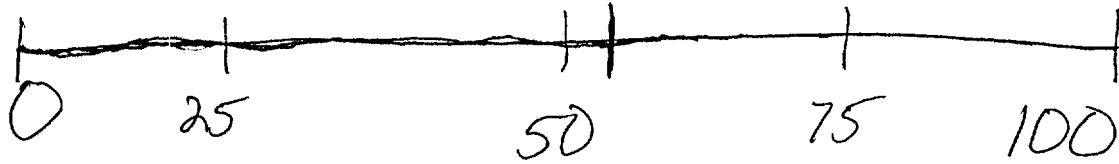

55 %

Survived

end Site!

1415

Long  
Tall

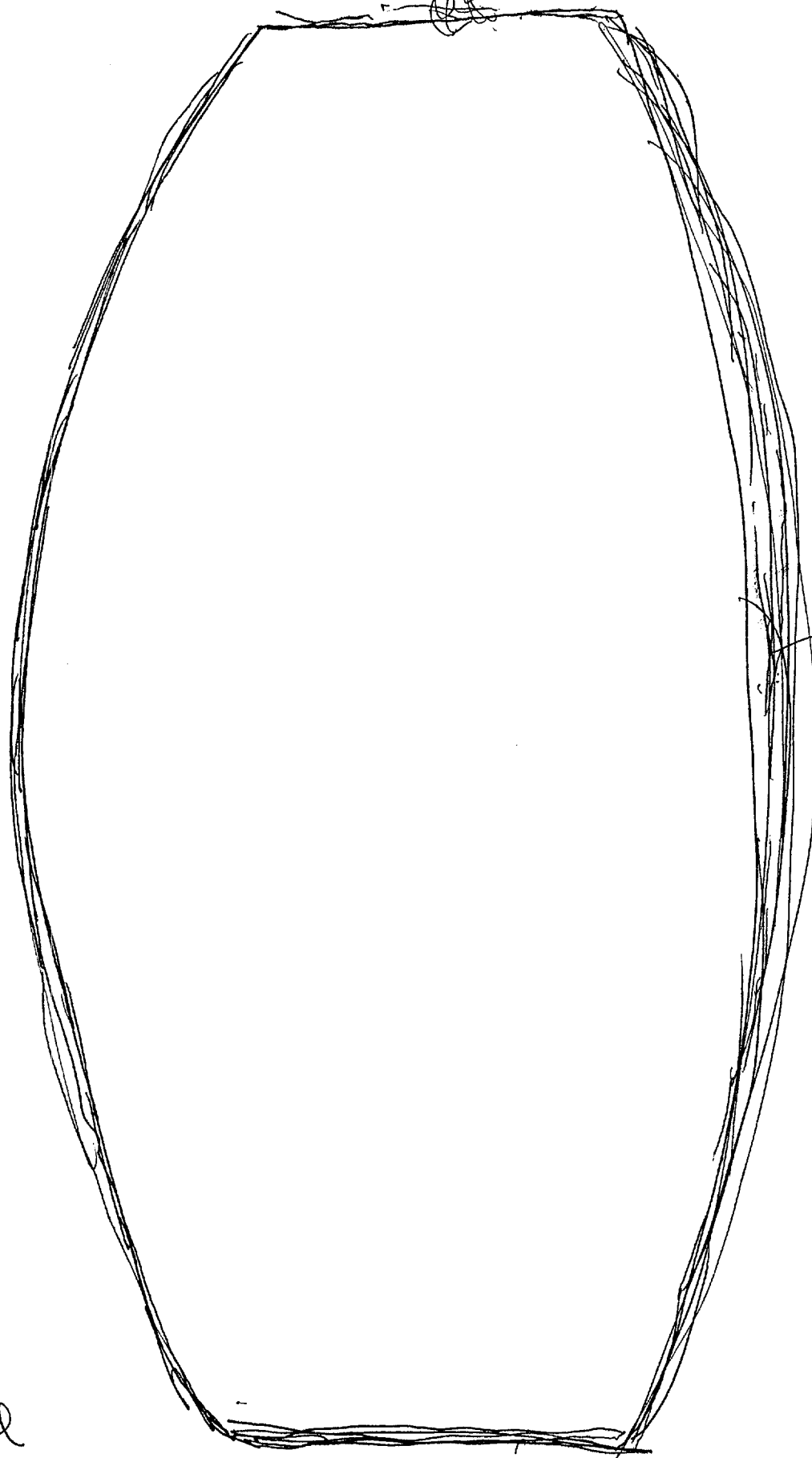

glass  
sides

sides  
curve  
out

Diagonal  
narrow

CPYRGHT

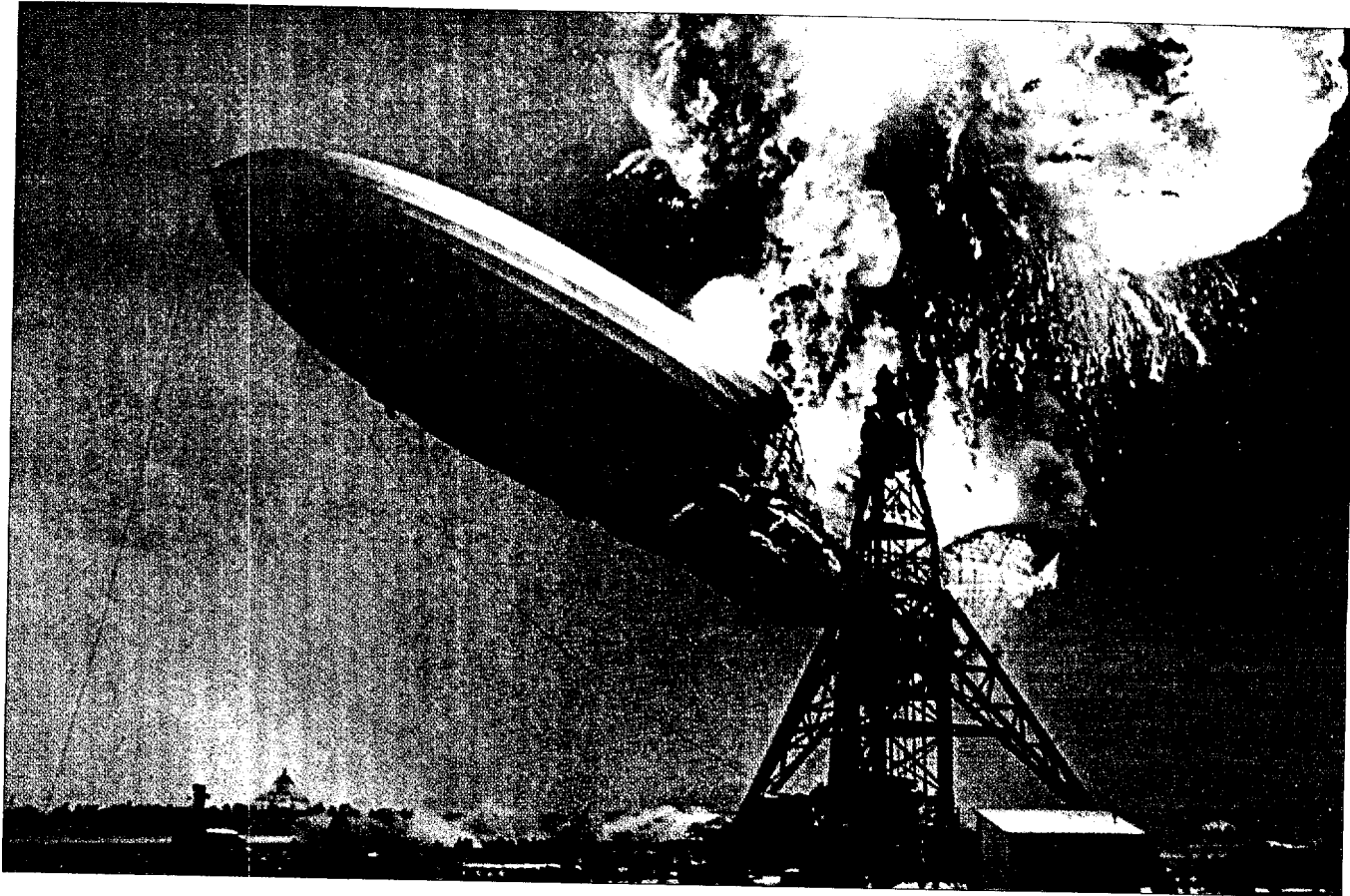

## ***The Hindenburg Disaster***

SAM SHERE, MAY 6, 1937

*Passengers paid \$400 to cross the Atlantic in luxury aboard the Hindenburg. The magnificent 804-ft.-long dirigible boasted a dining room, a library and a lounge with a grand piano. While*

*attempting to land at Lakehurst, N.J., after its 37th ocean crossing, the airship suddenly burst into flames. Of its 97 passengers and crew, 36 perished as the era of lighter-than-air commercial*

*flight came to a tragic end. Though 22 still and newsreel photographers were on hand, this frame by Shere, of International News Photos, is perhaps best remembered.*

TIME/FALL 1989