

~~SECRET//NOFORN~~

PROJECT SUN STREAK

WARNING NOTICE: INTELLIGENCE SOURCES AND METHODS INVOLVED

-----

PROJECT NUMBER: 90100	SESSION NUMBER: 01
DATE OF SESSION: 22 AUG 90	DATE OF REPORT: 22 AUG 90
START: 1100	END: 1130
METHODOLOGY: CRV	VIEWER IDENTIFIER: 049

-----

1. (S/STD) MISSION: To determine if <sup>SG1A</sup> narcotics are on board the target vessel identified as the [redacted]. If so, describe the type of narcotics involved; how packaged; and, where stored. Determine if the illegal drugs are being carried by any of the crew members.

2. (S/STD) VIEWER TASKING: <sup>SG1A</sup> access and describe the target vessel identified as the [redacted]. In the course of viewing, determine if contraband is on board. If so, where what type of contraband; how packaged; and, where stored.

3. (S/STD) COMMENTS: Viewer identified the vessel as being large which is correct. Viewer reported that the [redacted] <sup>SG1A</sup> is currently carrying contraband in the form of illegal drugs. The contraband has been packaged within long tubes reminiscent of those used as the cores for rolls of carpet. The tubes are 6 feet to 8 feet in diameter, 6 paces long and made of a hard material. They are stacked in a cage like rack. The rack is located below the corner where the port side hull and the deck meet at mid ship. Viewer also reported that a man named Oscar is associated with the drugs and this man is a crewman. \*

4. (S/STD) EVALUATION: 4

5. (S/STD) SEARCH EVALUATION: N/A

*6 to 8 inches \**

HANDLE VIA STIPPLE CHANNELS ONLY

~~SECRET//NOFORN~~

CLASSIFIED BY: ODSINT, DAMI-PO  
 DECLASSIFY ON: OADR

*\* Debrief indicates rocks located immediately below deck from cargo to forenoon to the catwalk.*

~~SECRET NOFORN STIPPLED~~

P:  
V: 049  
D: 22 AUG 90  
T: 1100-1130  
S: 01

Summary of Information

The overall attitude on the vessel for this trip is that it will be "easy sailing" because of the American authority's emphasis on the Middle East situation. Contraband narcotics are present. They have been packed within long tubes reminiscent of those used as the cores for rolls of carpet. These tubes are 6'-8' in diameter, 6 paces long and made of a very hard material. They are stacked in a cage-like rack. This rack is located just below the corner where the port side hull and the deck meet at mid ship. A catwalk or walkway runs along side and parallel to the rack. This rack sits on top of a larger tube/duct which has contained motion within it. The floor of the walkway and the surface in which this larger tube/duct sits upon are one in the same. There is a rather "cavalier" attitude in the attempt to hide the narcotics. A man named OSCAR is associated with the drugs. His job/he is known by the phrase of a "typical 'hatch' guy". There are smells of food cooking, particularly chicken soup. There is also a musty and dirty smell present. The phrase "off in bay..." is also associated with OSCAR.

Handle Via Skeet Channels Only  
~~SECRET NOFORN STIPPLED~~

~~PT - Communist~~  
in M.E.; my station  
AV - metal pulled vessel

049  
22 Aug 90  
Rt Member  
Solo  
1057

102  
Steamer.  
Seal Boat  
Control flight  
Control flight  
w/ split 55  
Hydrofoil  
PB-3

837

MISS BK

883765

871549

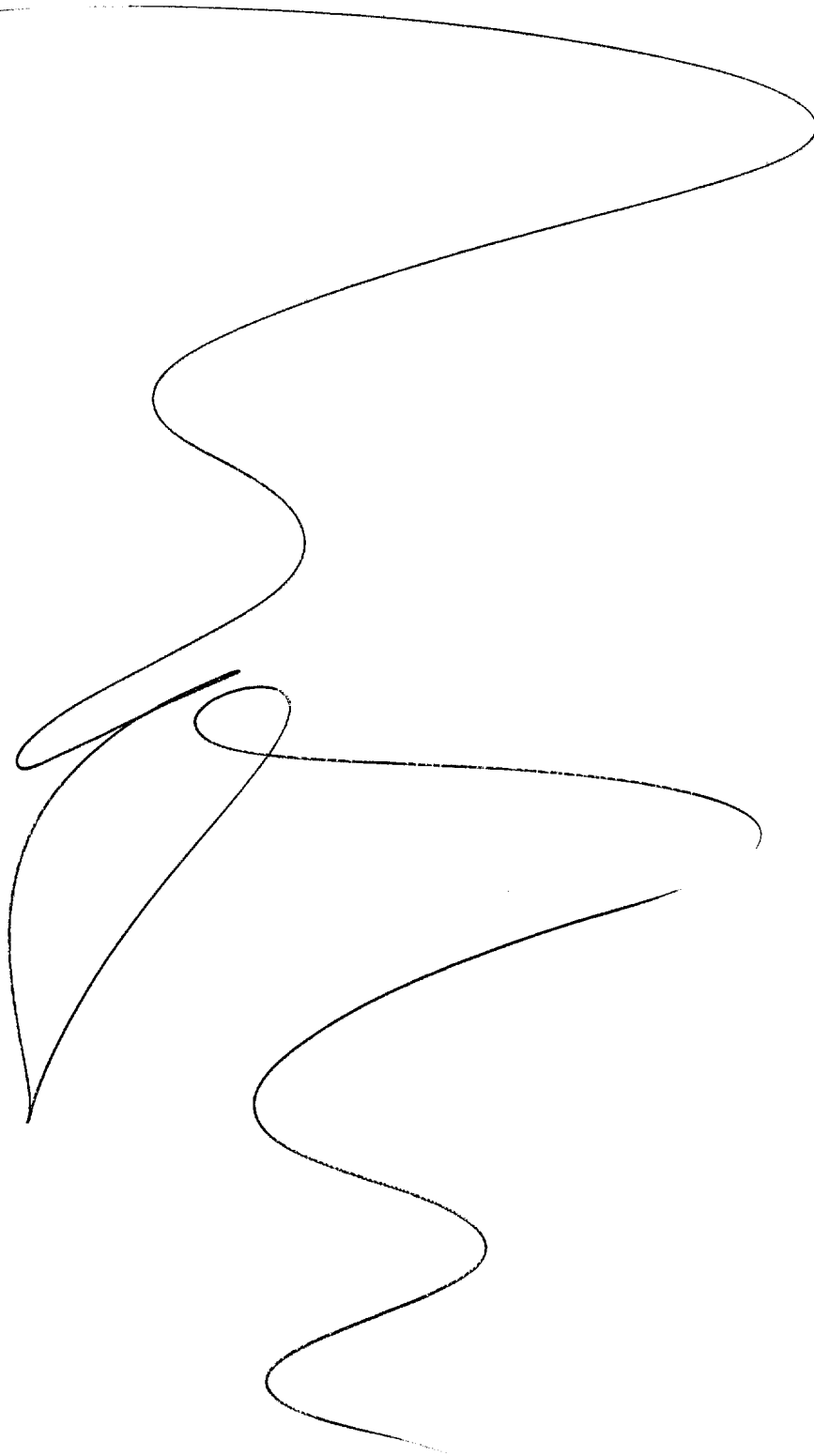

Confidential BK

3)

883765

871548

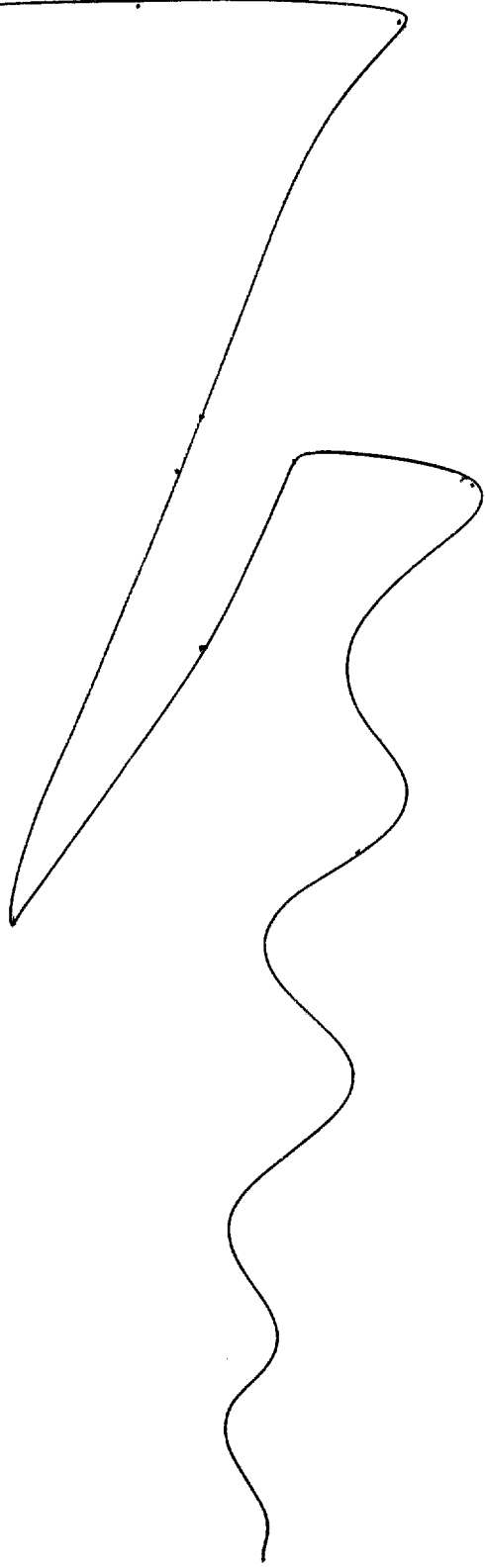

A - across  
 angle down,  
 angle up,  
 angle out,  
 way down

- hand  
 flat  
 - Mammals

B - structure

A -

AvC BK  
 Metal sheets  
 Metal box

A - motor

B - no B

AvC BK -  
 Wooden objects

A - way  
 B - water

AvC BK

Folded canvas  
 sails

52

green

white

blue

orange

red

yellow

blue

flat

ribbed

cylindrical

green

white

bellows

heavy notes  
up & down

AI BK  
Makes no  
senses

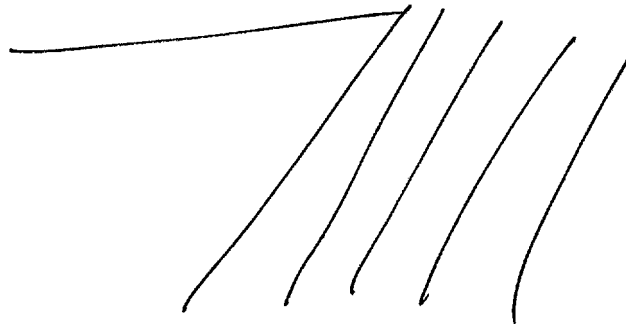

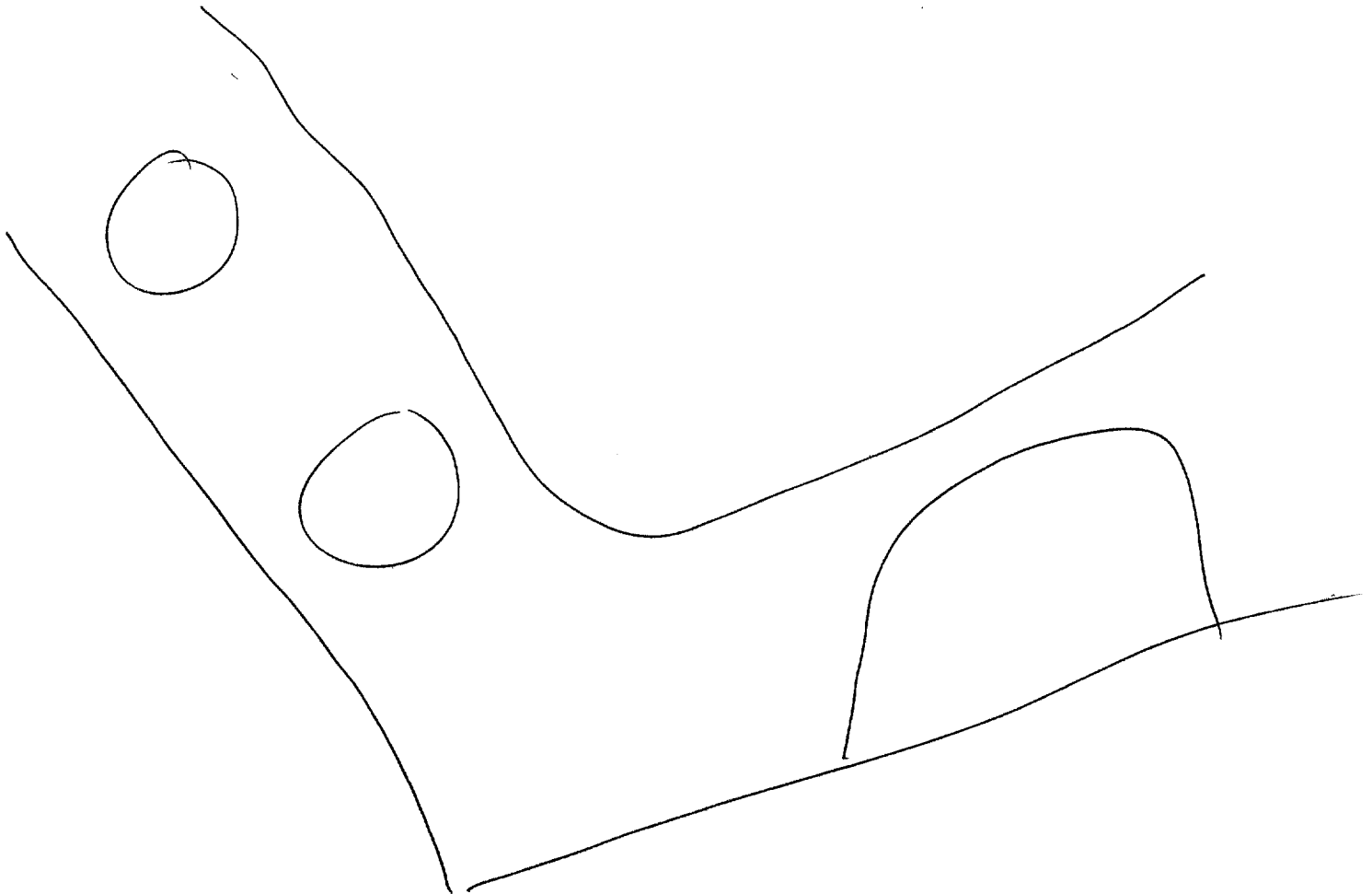
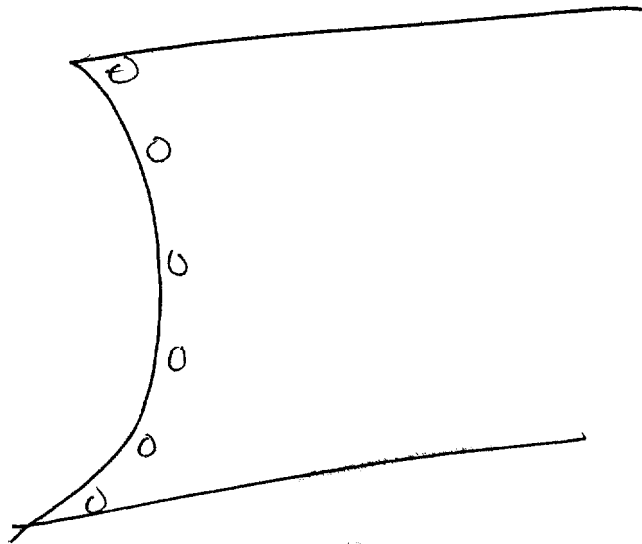

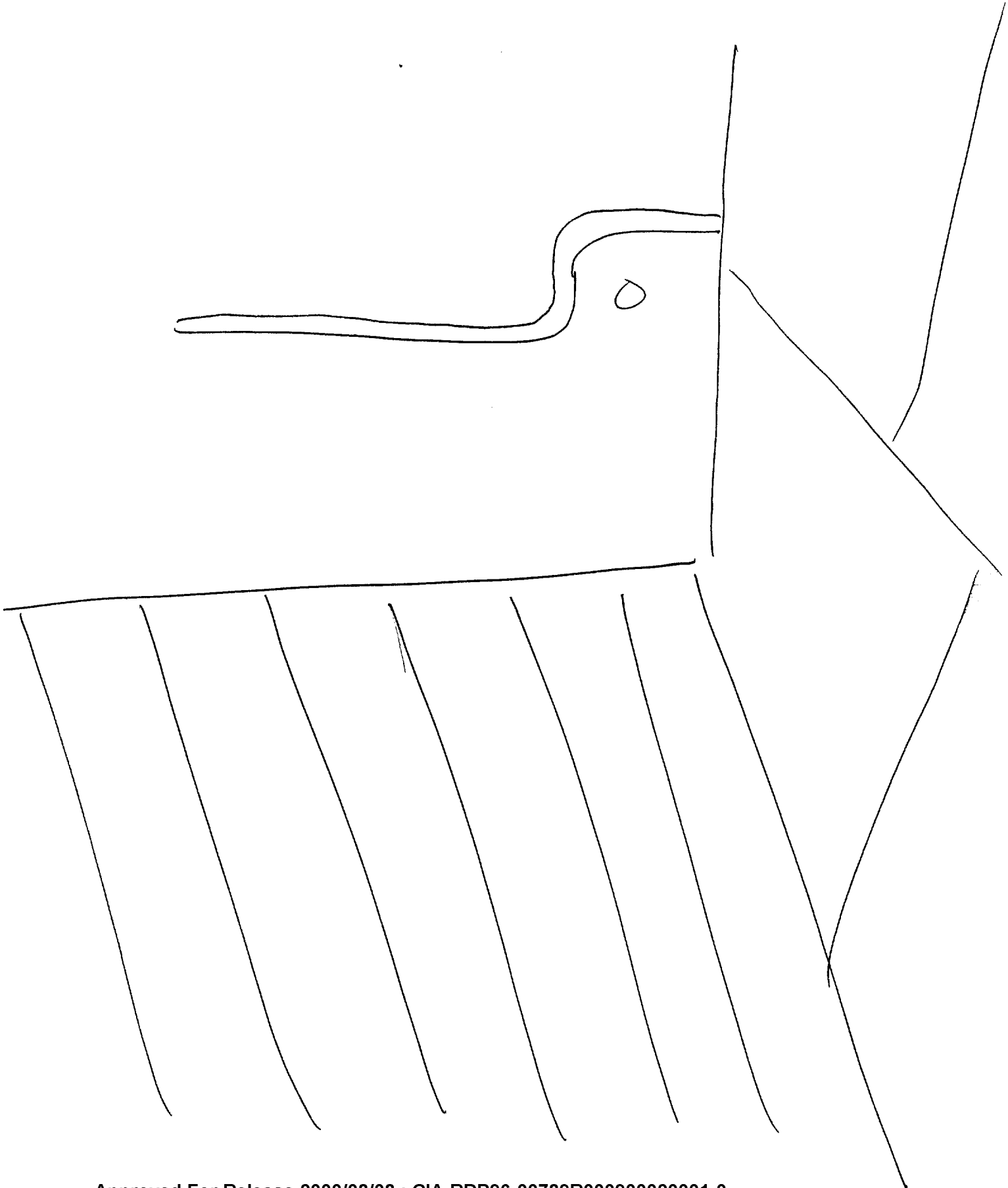



52  
D AI EI T I AUC A/S

pink  
gray  
green

AI DIC  
ugly colors

gray striped

gold

heavy up: down motion sunset

person perched  
on long pole  
or boom

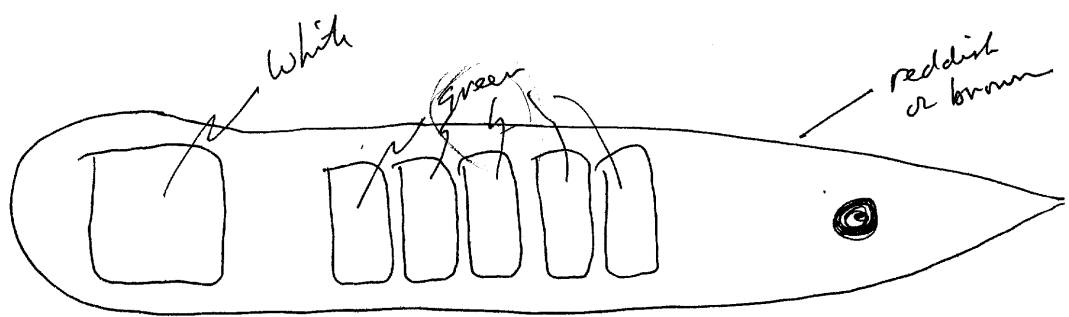

fily  
gray  
dark

A/S  
petio hold

" "

OSCAR

lobsters  
cooking

52

D AI EI T I A/C A/S

Galley  
stove cannot goods  
chicken soup cooling

Oscar = typical hatch guy

[location in ship]

Musty smell  
chubby  
chubby

A/C  
Hopi Kira  
w/alter

round of tubes like object held  
in panel just under desk, mid  
ship, port side. Tubes are 6 pieces  
long, very hard; held in a rack  
for tubes like a set of parts.

52

AL FI T I WOC A/S

56 1/2 a cut walk or walk way occurs  
along side & just below path.  
Patten cavaler in attempt to  
hide the stuff.

90100  
901822  
V:049  
S:01

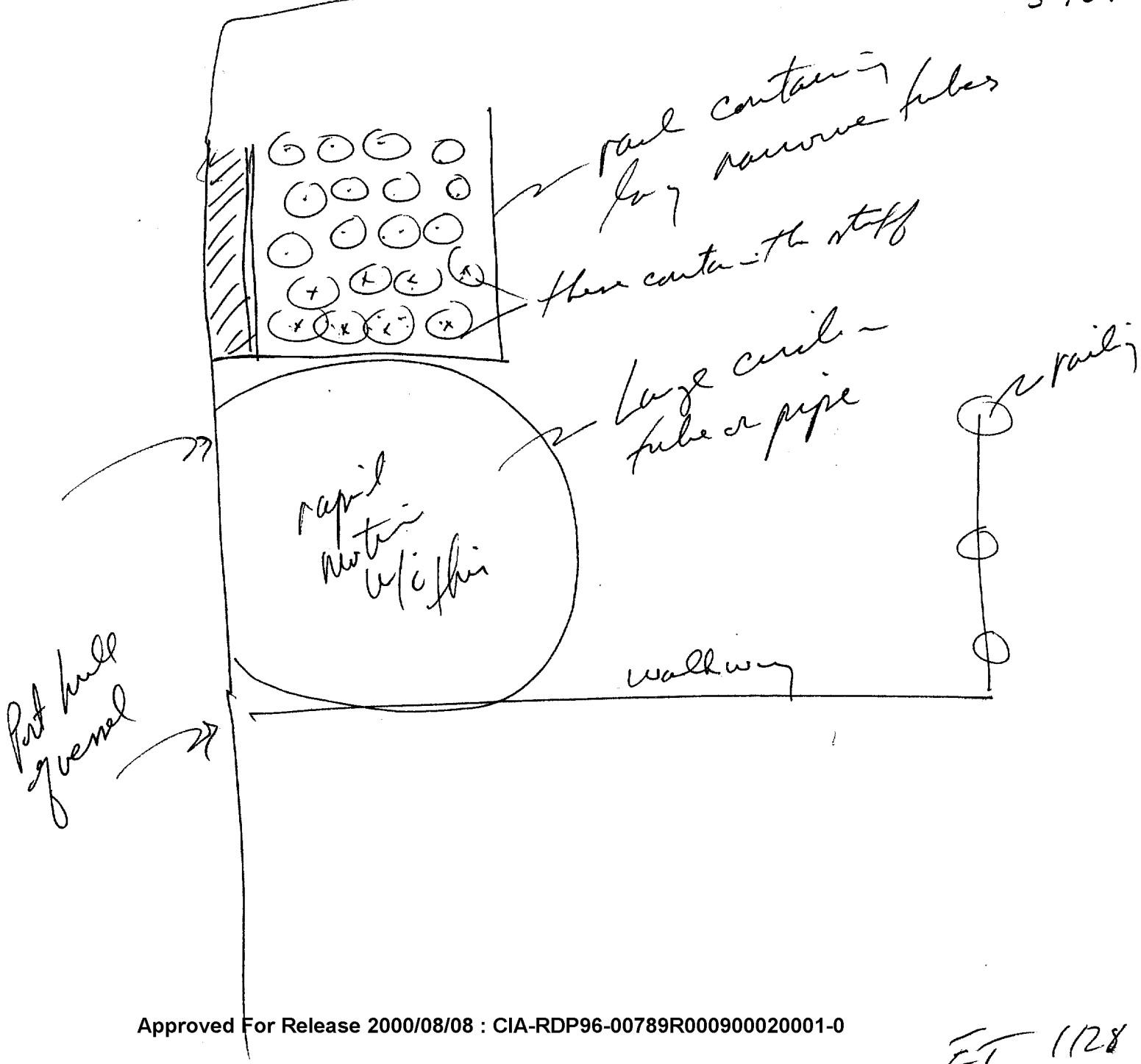

ET 1128

The overall attitude on the vessel for this trip is that it will be "easy sailing" because of the American authority's emphasis on the Middle East international contraband narcotics on present. They have been packed w/i long tubes reminiscent of those used as the cores for rolls of carpet. These tubes are 6"-8" in diameter, 6 pieces long & made of a very hard material. They are stored in a cage-like rack. This rack is located just below