

~~SECRET~~  
ORCON/NOFORN

INSCOM

GRILL FLAME

PROJECT

SESSION REPORT

CLASSIFIED BY: Director, DIA  
REVIEW ON: 30 Jun 99  
EXTENDED BY: Director, DIA  
REASON: 2-301-C (3) (6)

GRILL FLAME

~~SECRET~~

~~SECRET~~

SUMMARY ANALYSIS

REMOTE VIEWING (RV) SESSION LXVII

1. (S) This report provides documentation of a remote viewing session conducted for training purposes to enhance a remote viewer's demonstrated ability.
2. (S) The remote viewer's impressions during this session had some correlation to the target area. The viewer appeared very hypertonic prior to the session. Once into the session, though, the viewer became very relaxed. Although there was a lot of noise throughout the session, the viewer stated that he had not heard any of it.
3. (S) The protocol used for this session and which will be used in later training is detailed in the document, Standard Remote-Viewing Protocol (Local Targets) by Harold E. Puthoff and Russell Targ, November 1978.
4. (S) Following is a transcript of the viewer's impressions during the remote viewing session. At TAB A are drawings made by the viewer reference his impressions of the target site. At TAB B are photographs of the target site.

~~SECRET~~

~~SECRET~~

TRANSCRIPT

REMOTE VIEWING (RV) SESSION LXVII

TIME

#11: This will be a remote viewing session (edited for security).

PAUSE

#29, its now 10 o'clock. The beacons are at the target location. Reach out and go to that location and tell me what you see.

PAUSE

+01 #29: Two light colored parallel lines. They could be poles. They appeared to be metallic. Appear to be on the close order of 20 feet high - at least I can see them going up in the air. Two parallel, cylindrical poles.

+02 First, a rectangle at the top of that. Now that may be an analytical overlay. Because the question . . . intuitively is, what are they for? And it seems to be to hold something up.

#11: Okay.

#29: And then, what is the thing which is being held up? And it appears to be a horizontal rectangle.

PAUSE

The poles are definite and they are about 6 to 8 feet apart and about 20 feet high. And then, I had the feeling that there is a rectangle above the poles.

PAUSE

+04 That was interesting. They're walking forward. The beacons are walking forward and I went drifting forward with them, so that I first saw an object at a distance like that and then as they moved forward. . no, that's not wide enough. . as they moved forward, it got progressively larger.

PAUSE

~~SECRET~~

~~SECRET~~

+05 Cup shaped object made out of some kind of hard material. Could be cast concrete. Carved stone. Something. Something massive . . like that feeling. I cannot see water inside it. It has the signature of a fountain, but to say its a fountain is analytical. It could be a trash recepticle. Ha ha ha.

+06 I'm not sure the drawing is (not audible). I just got the impression of a large brick building with an entrance set in the corner and some kind of an overhang over the corner entrance. But I don't. . I don't feel good about the image. So. Drop that and see if I can go back and look for #66 and #20. Start. . .

PAUSE

#29: Oops! This one is going to be tricky to draw. Its a large dark shape, rectalinear object. I have the feeling that its sheathed in like metal siding that's you know, kind of a dark color. Bank your knuckles on it and it sounds metallic, but is not a metal column. Order of magnitude would be . . ahh. . that's . . I don't understand too why I'm looking down on the top of the thing. Unless my order of magnitude is wrong, but I get the feeling that its. . four feet and the proportion that I saw in this direction is six and the height is 10 feet anyway. But I seem to be looking on the top of it. I don't know, I'm having a lot of trouble with these dum sessions because I went through a bench period where there was a bench in everything. Then I went through a staircase period and there was a staircase in everything. And this seems to be part of my staircase period. What am I up to? That's four I think.

#11: Well, you know, a lot of these targets have been preselected for us by somebody else. There have been a lot of similar things. So, just go ahead and describe whatever you see no matter how ridiculous it might seem.

#29: Its dark. Not shiney, but oxidized metal. Dark. No oxidized metal implies rust. I don't believe to imply rust.

#11: Like a primer.

#29: No. No. Like aluminum siding. Yeah, like

2 ~~SECRET~~

~~SECRET~~

aluminum siding. Bronze. Dark bronze or something like that.

PAUSE

+11 Okay. Projecting overhang. Now, I can't tell whether they're inside. . ah. . its one of those perspective things where if you draw it this way it flops from there. . by being outside to there. . being inside.

#11: Uh huh.

#29: But I can see it from both ways.

PAUSE

+12 One of the things that's really odd about this sensation is that I can see through things. I know its not normal to be able to see through things.

#11: Ha ha ha.

#29: That's five. As if this was a doorway set in. I'll indicate glass doors but I don't see them. I just get the feeling there's an opening. . and light being in through here. Five "A". I'm going to try and draw it as if we were (not audible). Damn it! I can't see it!

PAUSE

Patience. Patience.

PAUSE

+14 I guess that's what I was trying to see. God! Oh, there's a rectangular metal frame sign on the wall that. . it was like, you know, if you go to a movie theater, it say Now Playing - King Kong and the Lord of the Underworld or whatever. A glass fronted case that has material displayed showed inside of it. I don't want to say that its (not audible) yet. Order of magnitude - 6, Oh come on pencil (not audible), 6 inches deep and 2½ feet by 3½ feet high. Glass front. Aluminum sides.

SIRENS - OUTSIDE

~~SECRET~~

~~SECRET~~

#11: Yeah, that's pretty good.

#29: I just went back to drawing 3a. And I got it again clearly and I added the color light blue. . . to the projecting (not audible).

PAUSE

#20 on that concrete thing. It could be a drinking fountain too.

PAUSE

+21 Okay. I think that;s what I want to . . I don't . . seem to be getting anything new. It seems to be review time.

PAUSE

(Not audible) a strange pattern.

PAUSE

Hmmm.

Number 2 - I had the feeling there's a you know, concrete type area. But the lines are not very strong. You know, its just a concrete walkway area. Hard, flat surface and this object was something that was walked by. Sort of noted in passing (not audible). Yeah. Height of the thing is three feet.

PAUSE

No, I'm not going to say that. If I think that its a drinking fountain or something like a drinking fountain, then I'll make it 3½ feet. I'll say three feet but (not audible) that order of magnitude.

PAUSE

Initially, well I get the cup shape, more than I get the base. So the base is less important than the cup shape.

PAUSE

So here's a large corner of . . its the corner of a large building and I'm going to put in a dotted line because I have a feeling that that

~~SECRET~~

~~SECRET~~

original roof line that I drew isn't tall enough. Going back and looking at the second perception, that I had of it when I added the color to the overhang, blue, or projecting entrance way or whatever you want to call it. It did seem like the building was taller than I had it drawn here.

PAUSE

Four I don't understand. Dark. Bronze, metallic. Shape. But I seem to be looking down on the top of it and I don't. . I still don't understand that. I just have a feeling that it was quite tall. Oh well. Five and 5a was this inside/outside entrance side thing where. . . Yeah, . . its an optical illusion the way I got the, the image of the thing is an optical illusion. Sort of snapped back and forth like I have trouble with perspectives sometimes.

Six was the display case that is next to a set back. Term it a set back rather than calling it an entrance because it may not be an entrance.

PAUSE

Seven was another shot of the overhang. And that's all she wrote. Do you have any questions?

#11: No. It sounds to me like a pretty good session.

#29: Ha ha. So did the last one.

#11: What? I don't know. How do you feel about it? Confident?

#29: Nope. After three zeros. . . I don't feel confident.

#11: Well, that's good because most of the time when you feel confident that's when (not audible). Is there anything that you want to go back and look at, at the location? I know you realize that once the beacon has gone from the location, we can go back and (not audible).

~~SECRET~~

I don't necessarily want to say that its a movie poster. It could be a display case for something and this is on a . . on a . . on a wall to the right. . to the left of an opening.

It could be the same opening that I was drawing at five. It could be a display case for merchandise. It could be a display case for a poster. (Not audible) I say its a display case for a picture for a movie then I'm going to build a movie theater out of that damn place and I don't want to do that.

#11: Okay. Well, start over again. Concentrate on #66 and #20. Find them.

#29: (Not audible)

PAUSE

+15

There's that projecting overhang again. I have a feeling they're idling around in front of this building. It has this projection but I keep getting the projection from different directions. I just got it sticking out over top of my head as if I'm towing around like a balloon behind #20 at that, at that particular moment. And he's . . . Oh yeah. He's idling around underneath this, this overhead projection doing type "O" circles. Orbit is the term I normally use.

PAUSE

What am I up to? Label that One. That's Six and this is Seven.

PAUSE

+18

Okay, I want to say that #66's got the camera and is taking pictures. Seventeen, that can't be.

PAUSE

Okay, throughout this session I didn't have the feeling that they were inside. I had the feeling that they were idling around out front of a building.

PAUSE



~~SECRET~~

#29: Well, when I go back to the drawings I call up the images and in that sense I've already gone back through the perceptions. Its a fifty - I think its a diminishing return thing, for me, when I go back and look at the perceptions. Because there's a huge tendency to do a lot of analysis.

#11: Exactly.

#29: I seem to get, you know, I seem to go through the target to a certain point and then, you know, I just don't. . . the camera stops running or whatever.

#11: Um hm.

#29: This stair glass, if there's anything I want to do, its the vertical (not audible). . .

#11: Okay, yeah, that would be your first and strongest impression. (Not audible).

PAUSE

#29: #11, its just not coming.

#11: Okay.

PAUSE

#29: No. Anything I put on it at this point, I just have the feeling its going to be analytical.

#11: Sure.

#29: I can change the object up at the top of those poles almost at will. I've done it twice and I don't think either one of them's right.

#11: Well, then we'll call it the end.

#29: Okay.

~~SECRET~~

# TAB A

JUN 28, 1979

OT - 1000

VIEWER 14

FAC. 11

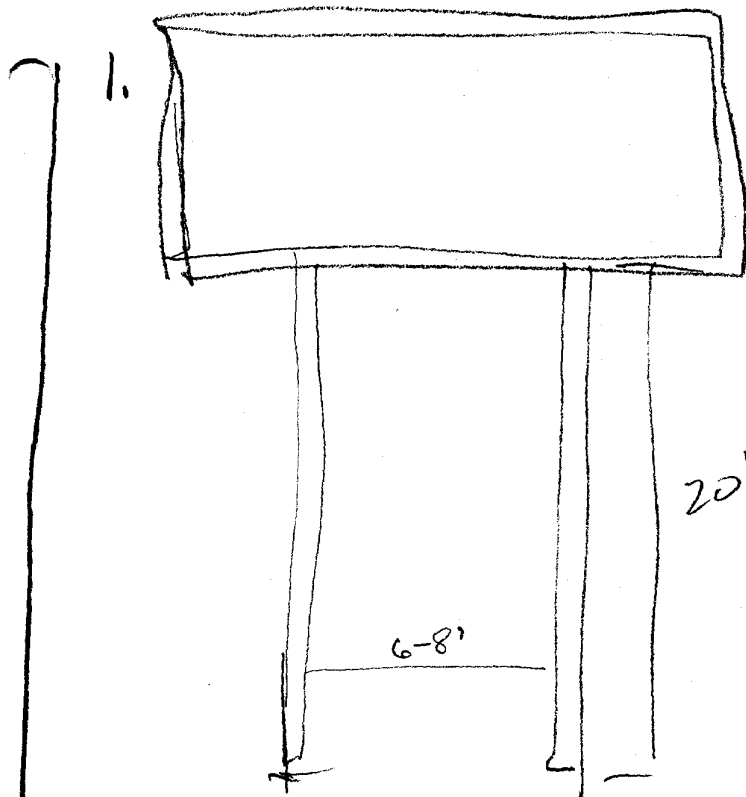

2 Vertical poles -  
6-8" diameter  
shiny aluminum  
brushed finish.  
Rectangle - maybe

2

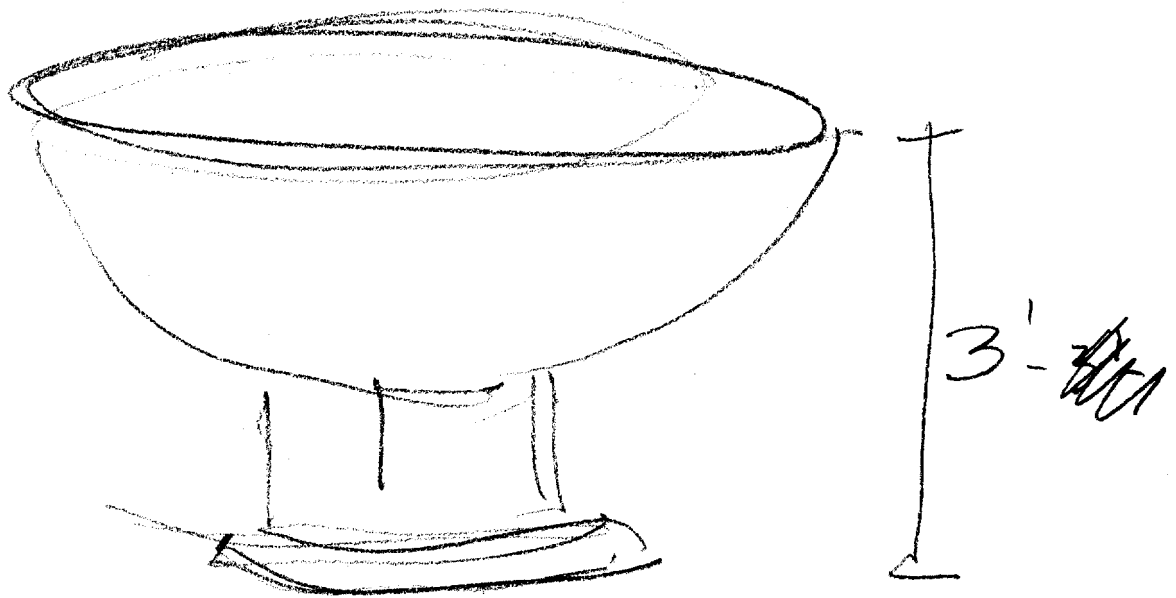
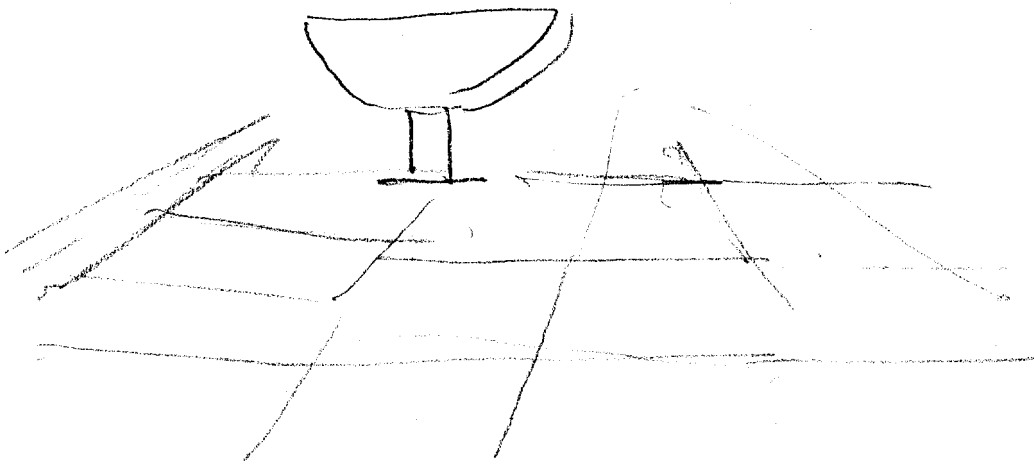

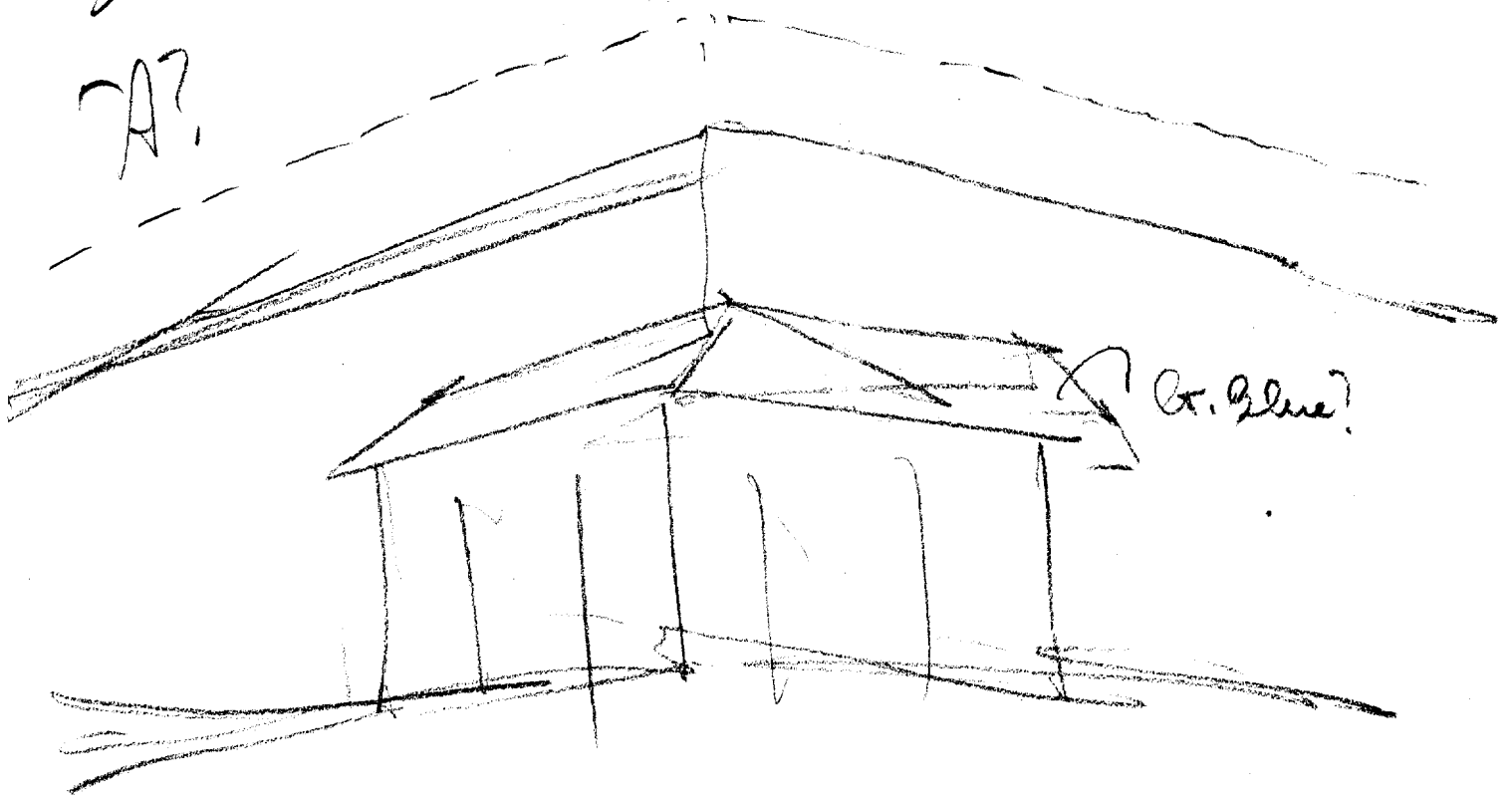



Dark bronze  
Metallic sheath.

15

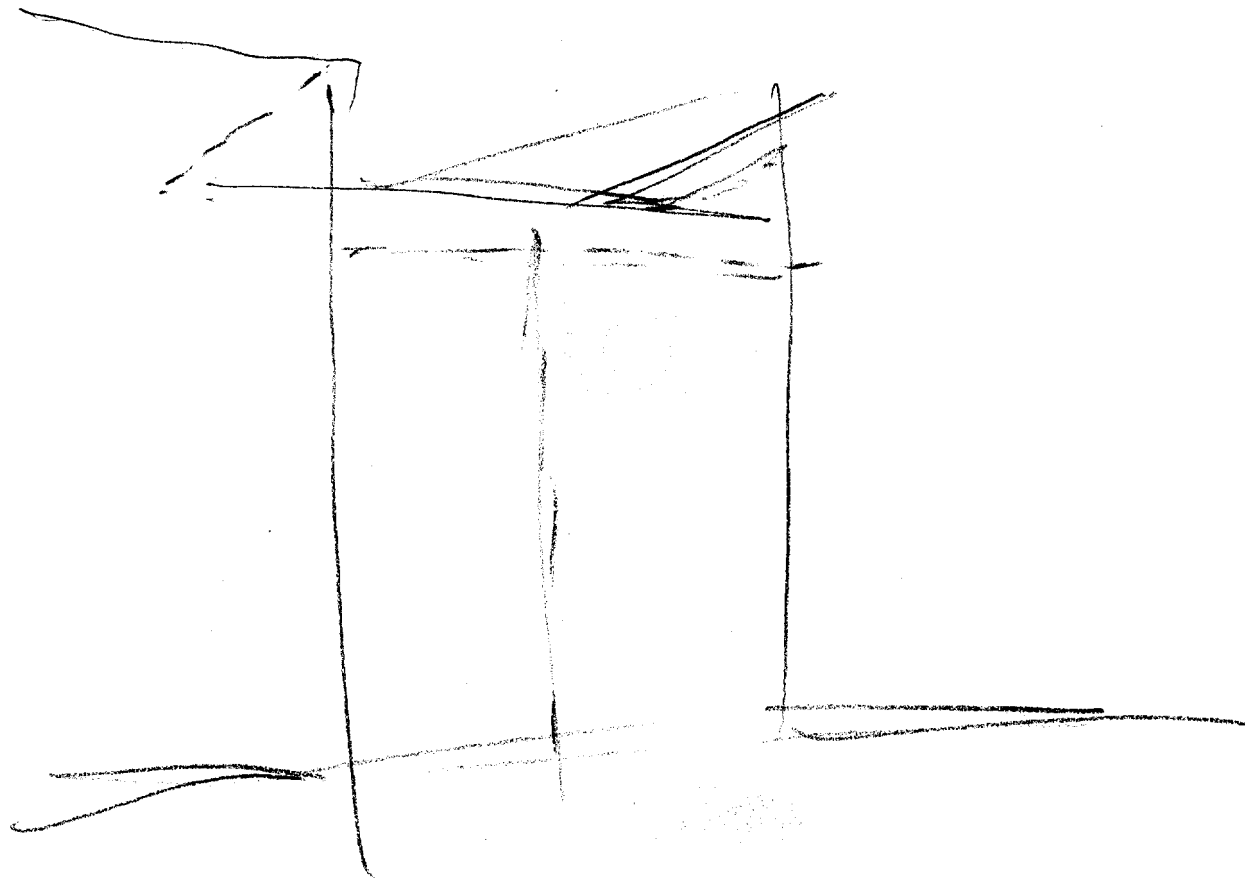

5/4.

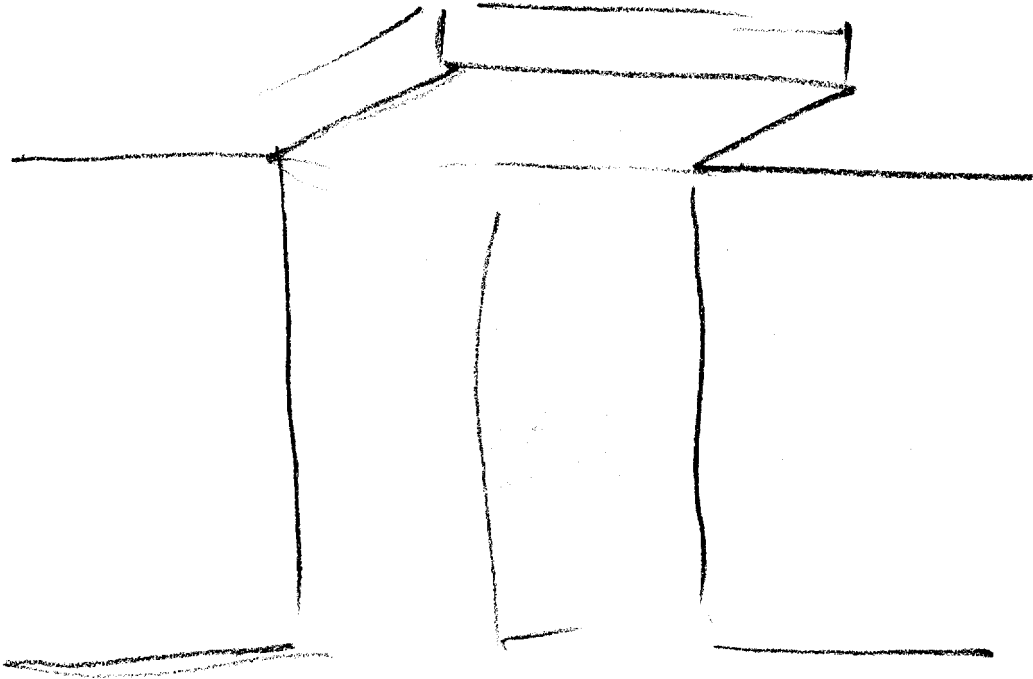



6

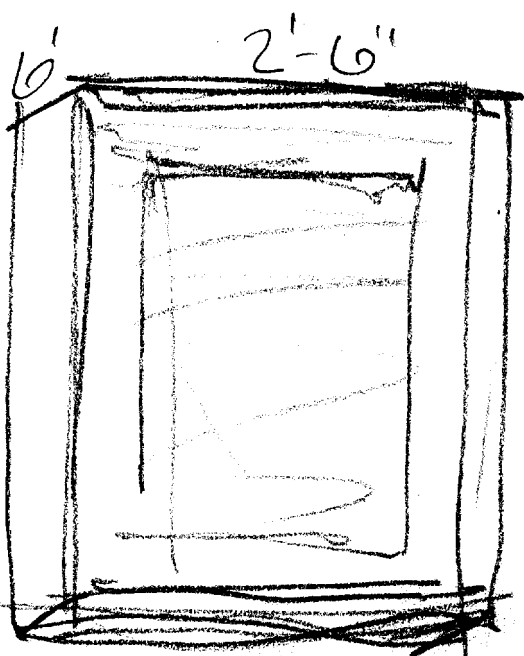

3'-0''

7

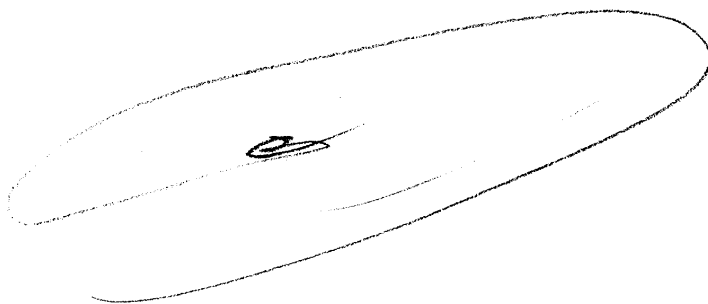
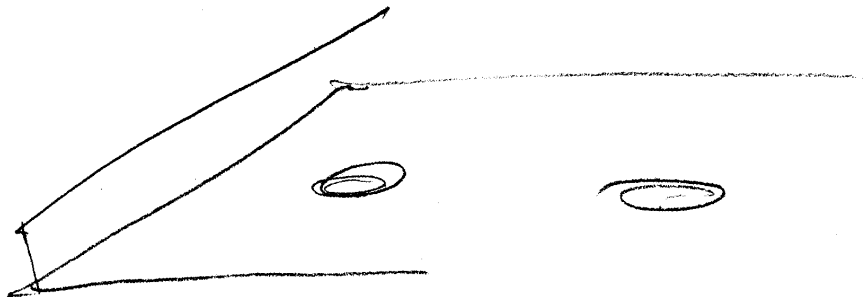

# TAB B

