

INSCOM
GRILL FLAME
PROGRAM

SESSION REPORT

CLASSIFIED BY:MSG,DAMI-ISH
DATED: 051630ZJUL78
REVIEW ON: *29 Dec 78*

NOT RELEASABLE TO FOREIGN NATIONALS

GRILL FLAME

Page 1 of 2 copy

SUMMARY ANALYSIS

REMOTE VIEWING (RV) SESSION DC-43

1. (S/NOFORN) This report documents a remote viewing session conducted in compliance with a request for information concerning the activities of a ship identified as the [REDACTED] SG1A
2. (S/NOFORN) The remote viewer's impressions of the target are provided as raw intelligence data, and, as such, have not been subjected to any intermediate analysis, evaluation or collation. Interpretation and use of the information provided is the responsibility of the requestor.
3. (S/NOFORN) The protocol used for this session is detailed in the document Grill Flame Protocol, AMSAA Applied Remote Viewing Protocol (S), undated.
4. (S/NOFORN) Following is a transcript of the viewer's impressions during the remote viewing session. At TAB A are drawings made by the remote viewer reference his impressions of the target site. At TAB B is target cuing information provided the remote viewer. At TAB C are control monitor comments.
5. (S/NOFORN) This session was conducted concurrently with Session DC-42 on 111330 Dec 80.

NOT RELEASABLE TO FOREIGN NATIONALS

TRANSCRIPT

REMOTE VIEWING (RV) SESSION DC-43

TIME

#66: This will be a remote viewing session for 1300 hours, 11 December 1980.

Relax and concentrate now. Relax. Relax. Relax. Focus now on the [redacted] Focus now on t [redacted] a ship you know well, at this time. The [redacted] ship you know well, at this time. Focus now on the [redacted] and describe it's present location, it's present location to me.

SG1A
SG1A
SG1A
SG1A

+03 #31: Mmm..... This ship is.....moving, it's at sea..... It's at a.....elongated "L" body of water... It's at one end of it, sorta on the left hand side above some sort of a intrusion in the water like a place where the land comes into the water more...more towards the left side than.....line sorta comes up and out. A block that...juts up on the left side.....

#66: Focusing now on the ship, focusing now on the ship [redacted] in terms of our intelligence interest, in terms of our intelligence interest, describe what this ship is doing. Describe what the ship is doing in terms of our intelligence interest.....

SG1A
SG1A

+08 #31: Ship is returning....the ship is returning.....

#66: All right. Now focus even closer, even closer, closer, closer on the ship itself. Now you perceive on the ship, on the ship. Look now through the ship, scanning through the ship as it is at sea, at the present time. There is a key person controlling the activities aboard the ship. There is a key person who controls the activities aboard the ship. Scan the ship as it is at sea now. Is he there? Is he there on the ship, this key person who controls the activities? Is he there on the ship?...

+11 #31: Some man wearin' a dark sweater, almost turtleneck, with a cap, like a mate's cap. He is standing in the....there, uh, he's standing outside someplace exposed in the, where it's white and metal all around. Someplace where he can look over a metal ledge like a...like he's out on an open air part of the...the back part of the boat. He look up and he look down over the boat.

#66: All right. Now...

~~SECRET~~

#31: I see mountains and a...mountains up front....on the horizon there are mountains, and a gash in mountains like a...a place where the water narrows to...

#66: Okay.

#31: ...go through some skinny area. Not super skinny, but area that's several miles across.

#66: Okay, let's not get too far- don't let things away from the ship attract your attention. Let's not wink away from the problem at hand. It's very easy to do. Focus your attention now back onto the ship, back onto the ship, and focus on this key individual. Tell me about him specifically. What is he doing right now?

#31: There's a pair of binoculars over his...head, and he's standing exposed face to structure on the left hand wing. And he is standing and looking ahead at the mountians.

#66: All right.

#31: He is alone.

+15 #66: Place your hand on his shoulder and ask him, ask him what's going on. Ask him how things are going. Communicate with him.

PAUSE

#31: They're about to enter the channel...

+16 #66: All right, fine. Now maintaining your focus, maintaining your focus on the key individual with your hand on his shoulder, maintaining contact with him, him, we are interested in him, only him. Listen carefully. Focus on him and move in time plus 24 hours, plus 24 hours. And as you are with the key person plus 24 hours, describe your location to me.

PAUSE

#31: Down below I have...out on the bow I am watching him lifting tarps and walking amongst the equipment on the bow, and checking and...life boat there.

#66: Ask him, ask him what is going on now. Ask him how are things going. Communicate with him in this time window..... Just relax and concentrate, relax and concentrate. Relax and spend this time communicating, relax, relax, relax.

+20 31: Everything's goin' okay, he's just off watch. But I had a.... feeling of him walking down a set of big wide steps in a village of some kind, or extra large village maybe. Buildings around and a...something about sarnus or stardus...like a port of call coming up or something.

- +22 #66: Okay. Focus your attention on him, completely on the key person and move once again in time forward, forward in time to 2 days from now. Move forward in time till 2 days from now, 2 days from now. And as you focus on the key person describe your location to me.....
- #31: Feeling of two big white, uh, square like containers. Feeling of him directing some activity. Feeling that to my left was a, uh, c-...round canvas thing like a cover on the back end of a truck was there like a military truck cover. I don't know what the two big white rectangular things are, think he's down below in some hold somewhere, some deck.
- +25 #66: Now ask him what he's doing. Ask him how things are going. Communicate with him in this time window.....
- #31: Says, uh, little bit concerned about whether he makes the, whether he gets away with this, he's got a...some sort of a threat coming up, like a random ship inspection or something that causes some sort of a problem regarding whether he's gonna be successful or not. It's like there's no real reason why he shouldn't get away with it, but it is sort of a crunch point where he might fail just by chance.
- #66: All right.
- #31: I think what's happening is he's moving, there's some rearrangements in cargo.
- #66: Very good.
- #31: Playing like a peanut in a pea here, like he's switching something around...from one place to another.
- +29 #66: Hold your attention on him now, hold your attention, focus solely and completely on him, and move in time plus one more day, plus one more day, 3 days from now. Move in time, holding your focus on the key individual 3 days from now. As you focus on the key individual 3 days from now describe your location to me.....
- +30 #31: Two things, I...believe the ship is hove to at wherever it is that the...thing has to be done I...feeling of him being a... maybe ashore and some sort of a curvy roofed place that looked funny, almost pillowy ceiling, curved over. But in this place he is some place of business, place of government business, like paying a toll or customs. And then I had a launch with him in it coming up alongside the boat, and him getting back on the boat.
- #66: Focus now much closer, much closer, right down to him. Focus now right down to him. Ask him what is he doing. Ask him how are things going. Communicate with him in this time window.
- #31: I asked. I said "Did it work?" and he said "Yes, it did",

+32 #31: rather disgustedly like every time he goes through this process he gets ripped off, like he thinks whatever it is that happened is exhorbitant or too much. But you gotta play the game type of feeling.... I asked him "Where to next?" and he said "home".

#66: All right, holding your focus on him, holding your focus on him move 4 days from now, move forward one more day to 4 days from now, 4 days from now. And as you focus on the key individual describe your location to me. Four days from now, focusing on the key individual.

PAUSE

#31: Just boat movement again.....

+35 #66: I didn't understand.

#31: It's just moving, that's all...

#66: By what method does he move?

#31: On the boat.

#66: All right. In this time window 4 days from now ask him what he's doing, ask him how he is getting on. Communicate with him in this time window...

+37 #31: Ah, how are you doing, he says..."I'm doing well". He said, uh, feel he's more assured of himself now, everything seems to be goin' all right. I asked if he had any more obstacles and he said one possibility of...like I got a feeling of one, he still could get caught or, uh...caught if, uh, if somebody found out what was happening they could still get him at one...another country could get him at some other bottleneck area on his route, but it would have to be a stop and search at sea because he did not have to stop, but that those people would be willing if they found out about it to come out and hassle him. But that if they didn't find out about it they wouldn't come out and hassle him. It's not like he had to stop and submit.

#66: All right.

#31: Routinely it would be like if they caught him at the last minute. And that is like a couple, two or three days ahead.

+39 #66: All right. Let's move now just one more day, focusing, focusing solely and completely, move now to 5 days from now, 5 days from now, and focusing solely and completely on the key individual describe your location as you stand next to him, this key individual. Five days from now.

#31: He's like, uh...he's like, uh, moved down the right. There's a stairway on the right side of the...like a ladder on the right

- #31: side of the, uh, bridge. I saw him coming down it, he's out by the water, he's comin' down the stairway backwards, or rather frontwards. Like a steep staircase or ladder. He came down then he walked out across the deck toward me, toward the bow of the boat, I thought (mumbling) were on the right, uh, somewhere out there in the water there might be another boat, cruising in some sort of a parallel course. And he was like going out in the bow to do his thing and look around as he's supposed to look around.
- +40 #66: Now focus tightly on him as he goes about his activity, and ask him what he's doing, ask him how things are going. Communicate with him in this time window.
- +42 #31: Well I had, uh.....he's doin' his routine now... It looked somewhere sorta close between, uh, north coast of Africa and Italy and the football, Sicily, and he's just doing his thing...
- +43 #66: Okay, fine. Focus very closely on him now and move forward in time one more day, one more day, holding tight to him, and as you focus one more day ahead in the future, one more day to 6 days from now, 6 days from now. Stand next to him and describe your location to me. As you move forward in time one day, 6 days from now, focus on the key individual now as I turn over the tape, focus 6 days from now on the key individual. Relax and concentrate, concentrate, concentrate, as I turn over the tape. The key individual 6 days from now, 6 days from now. Describe your location to me.
- PAUSE
- +48 #31: (Mumbling) for the last couple days I haven't felt anything about mountains. I get a coastline again. Coming into another area where the coastline is up front, little ways, still a little ways away, but I'm not getting it...like down at the end of the Med in the next day or two. They're still, I just see him doing his, I had the feeling just now of a radio message but, some sort of a radio message. I just see the guy doing his thing, he's just, you know. How many times does he look under a canvas? I don't know.
- #66: Okay. Now rather than observing him, rather than observing him and his routine, ask him, ask him how he is doing, ask him how things are going. In this time window, 6 days from now, communicate with him.....
- +50 #31: Feeling everything's all right and sort of...minor things wrong with the ship, ship needs some sort of a weird valve and, uh, (mumbling) on some sort of bright and metal rod to...seem to be some problems with it. Nit-picky stuff, nothing important. Where he's concerned about getting stopped and inspected is at Gibraltar. Something about being vulnerable as he gets in near land in the Gibraltar area... Somebody could come up and pick him off...

#66: All right. Hold your focus on him and move forward one day,

#66: move forward in time one day, forward in time one day to 7 days from now, 7 days from now. And as you focus on this key individual stand next to him and describe your location to me, 7 days from now.

#31: Now he's on the bridge and he's there with another guy and it's a very special time so he has to be up there with him. Feeling of maybe a mile or 2 or 3 away on the right side of the ship is a land mass and tall mountain area. Other boats, other ships around...all types, and some little sailing thing and other larger ones and...ahead and aft. And he's there with this other guy and they're making sure everything's goin' all right.

+54 #66: Now rather than observing what is going on, move now closer and closer and closer to this key individual and ask him what he is doing and how are things going. Ask him, communicate with him in this time window 7 days from now.

PAUSE

#31: He points out and he says "Yes, can't you see?"... And everything's sort of orderly and all the ships are one behind the other and there's nothing to worry about and...reasonably clear day. If the little ships stay out of his way everything'll be okay.

#66: All right, fine. Focus very, very closely now on the key individual, focus very, very closely on the key individual and I now free you from all time constraints and time windows, so that you may focus solely and completely on this individual, this individual that you've been following and monitoring. Describe him to me. Tell me about him, tell me about this key individual....

+56 #31: He must be, uh, 40 or so, clean shaven, Caucasian, about 6 feet tall.....less than 200 pounds and in the 70's, 170's or 180's. I think he doesn't have any family, he's only one..... Hair's a little bit longer than ours, but not too much. Feeling that it was curly, or curlyish, wavy curly, black, but not kinky sort of black but it's curly...

#66: All right, fine now. Focus now in this past time period where you have been looking and remember the time period now, remember back in your scan to the time period when he was moving cargo around down in the hold, move back to that time period now and describe this cargo to me....

#31: Well it's, uh....something with a trailer that's not associated with it...that's palatized...military equipment...that has some sort of a rectangular hole in it...making like a rectangular tube at an angle. I don't know if that's in the trailer or if that's in the other thing. The feeling of this trailer that's pulled behind something.

#66: Is this military equipment assembled or disassembled?

+63

#31: Well, I don't know. The thing that's rectangular looked like it was hollow so it might be empty... I didn't see the full thing yet. Know what all it is, all I know is that it's something that's pulled behind something else.....

#66: Okay. As you look at this in the whole now it might be difficult to see how it all fits together all crowded down here in the hold, all crowded in the hold, stacked and put away neatly. I want you now to put your hand out and touch it, and the minute you touch it you'll get a picture in your mind of what it looks like when it's used. Reach your hand out now and touch it and let there be a picture in your mind of the way it really looks when it's being used. Describe the picture that comes to your mind.

#31: It's like a rocket launch, a removable rock- multiple launcher. Some sort of wheels on it, a big box it sits at an angle off, off vertical on, the feeling of lines inside that big box that...

#66: Okay.

#31: Like it might be the tubes or anything. I had a feeling of arrows flying out of the tubes, or the lines being arrows rather.

#66: All right, fine. Now is there other things in the hold, is there other things besides this that you found? Remember you saw him moving equipment around and rearranging things. Are there other things there?

#31: Sure, there's plenty of stuff in here. That big, long, round diameter barrel, 15 or 20 feet long, about 4 feet in diameter. Still get the feeling of the rear end of that truck, the canvas on it. There was some other thing that was, uh, really funny in shape, it looked like a old bren gun carrier, tracked and stubby. And then another feeling that something stuck up outta that, like a, some sort of a tube stuck up outta that. But it looked short and stubby compared to the size of the tube, or the thing that stuck up out it...

#66: Okay, remember all these things that you've seen here, this stuff you call military equipment, remember each item that you've seen down there. And now I have no further questions concerning the ship [REDACTED] If there's anything you'd like to add please do so now.

SG1A

#31: No.

#66: All right, fine. Then bring your attention to focus on me in the room here and let's prepare to draw that which you've seen. Move your arms, move your legs, take a few deep breaths and prepare to draw.

#31: Okay. Sketch one, day one, present day. I have the ship is under way, is steaming, uh, in, in the direction of one end of

#31: a large body of water, but I felt that there was land around it. You know, like, uh, maybe it was in and coming, getting ready to come out of the Black Sea or something like that. A coastline all around it and that ahead of the boat some good distance, some 80 miles maybe or somethin' like that....yeah, you know, a long distance, was a projection that stuck out from the left that had mountains in it and then sort of went, subsided back in to the left. And then we got to like some sort of a natural channel about 20 miles wide or something. All right, and then sort of g-, just a generally round shaped coastline on the right.

Uh, our guy, whoever our guy is, is on the bridge standing with a pair of binoculars, as shown in s-s-s, no, as not shown in sketch 2.

#66: That's 'cause it's another day.

#31: That's another day, yeah. Okay, I didn't draw a sketch of that 'cause- anyway, he's just holding binoculars around his neck. His interest is concerned on the mountains that are on the horizon up ahead and the interest in entering this channel. Okay.

Uh, function is that the ship is returning is all I got. Ship is returning like that is as pertains to the intelligence aspect of this ship is returning.

Day two-

#66: Which is one day.

#31: Which is actually one day in future...uh, I have, find my guy, again the ship is at sea, uh, I find my guy out on the bow. Oh, in day one, which was the present, I find the guy on the- what is it? Starboard side of the boat, out on one of the little wings there, and I marked an "X" on the Xerox of the photograph that's to be his approximate position. He was like outside, but covered over, uh, like a breezeway or somethin' like that.

Day 2 I've got him down on the bow somewhere and he's just like off duty, off bridge duty, is what I mean, he's off bridge duty, but he still has his duties to perform and part of them are checking the hold covers, the hatch covers, and that kind of stuff. And that's what he's doing on day 2. And, uh, while he's out there I try to communicate with him and I get this feeling that he's possibly thinking about a port of call which is coming up, which is something like Sarnus or Sardus.

Uh, and I like flit to this image of him walking down this white marble staircase and there's white, whitewashed building all around and it's an irregular little street like some sort of a little fishing vil-, you know, an upbeat fishing village would be. You know. That's what I think, I don't think he's there,

#31: I think he's thinking about being there in the future, from future day, one day in the future.

Okay, sketch 4. Uh, find our guy in the hold of the vessel, I think. He is, this is actually sketch 4 is day three, which is 2 days, 2 days in future... He's down in the hold, there's large white boxes around that are predominating in the background as though they're containers, like there are containers on board the ships, like containerization. But he's sort of concerned and he's directing the movement and adjustment of some palatized equipment, which is over here on the left side of sketch 4.

And part of that equipment was like, I got the feeling of I was looking at the back end of a duece and a half with the tarpaulin cover over it. And there were some other pieces, very vague of. at that time very bague of tarped equipment and palated equipment, and he's like directing a couple guys maybe with forklifts moving the stuff around.

And I had the feeling that he was like concerned about some upcoming thing, and what he was doing is he was playing find the pea in the walnut type thing, you know, where you- he was moving some other stuff around in front so that nobody could see the really neat stuff that was in the back. In the event that they got looked at, that they got inspected.

Day 4, sketch 5, 3 days in the future... I had two feeling, uh, on sketch 5 and 6. The first one is that he is ashore, and he is in some little, uh, governmental office some admin office of some kind. A very peculiar thing is this arch, it's an arched room, at the back of which is some sort of a desk for like taking care of people, and there's this line of people, men and women, about 5 or 6, and he's standing in this line waiting to be waited upon. Arched roof around it, and it's like he's waiting to pay tax or do something quasi-official, like a toll or a tax payment and arrange something like that. And the roof of this place is oh, gray, pillowy type of ceiling, like it's segmented and arched, as I've drawn in sketch 5. Then another feeling from this day, which is 3 days in the future, day 4, is that he chug-chugs back to his ship, and that he boards back on board his ship, like having done some menial chore on shore. And he's taken back to board this ship in some sort of a small launch.

After that, which is day 4, day 5 is an at sea feeling again, sort of a feeling of relief as though the big thing that he had been worried about earlier has now occurred. That's day 5, I didn't draw a sketch for that, 'cause there's nothin' to talk about...

Sketch 7 is about day 6 or 5 days in the future. And, uh, in this feeling I have the feeling that he has like...I had the feeling, I was, couldn't get anything outta him except just

#31: garbage. This sort of relief that the big thing was over and done with and that there was some sort of a little problem maybe in the future, if everything went okay there wouldn't be any problem and it was little likelihood of any problem in the future, so he really, wasn't really spending much time on the possibility of getting intercepted now if anybody had found out what was going on.

To the right of the ship which I take to be the north was an area, land mass, I felt was Italy and Sicily. On day 6 the ship is proceeding past Italy, past Sicily and north of the North African coast. Other than that I don't know what to talk about. That's like his location at the time. I got a little bit of an aerial.

Sketch 8 is also day 6, or 5 days in the future. And part of the...yeah, I'm sorry. Ske- break that. Now, sketch 8 is day 7 or 6 days in the future. He was concerned essentially with some mocks-nicks stuff, uh...some sort of a pipe was in the bowels of the boat were giving him problems. And mocks-nicks stuff... Okay. Uh, possibility of some sort of a radio message occurring now on day 7, which is 6 days in the future, some sort of like some sort of a communications. I've written in here dit-dit-dit-dot-dot-dot but I don't know if it was open text or morse. Um, I had the feeling more that it was open text actually. So I'll scratch that out.... Clear voice....

Uh, some mountains, again my feeling of mountains up on the horizon as though they're nearing some other place where the water runs into the shore. Okay. Essentially boring. Again some very, very little concern, some minor concern about the possibility of being intercepted at this late date.

Sketch 9 is day 8 or 7 days in the future. And I have this feeling of like heavy mountains right up close, maybe 2, 3 miles from the ship. Uh, little ships and boats over near the mountains playing around in the background, shooting things at each other, screaming at each other, fishing, whatever. And that in front of the ship is like another ship that's going away, and that like, uh, sketch 10 I show that, I have this feeling like they've arrived at Gibraltar and that they are going through the channel at Gibraltar. The mountains are over here on the right, little boats, large boats are out in this seaway and they're moving through.

#66: You're saying this is Gibraltar or it's an area that looks like Gibraltar might look?

#31: No, I'm saying it's an area that looks like Gibraltar, but you know, that's the big heavy mountains on one side, and I didn't have any feeling for any high ground on the other side. That type of thing.

#66: Okay.

#31: But again, another canalized place where ships go one after the other. Ten, eleven. Now, you directed me back to talk about the things that I saw down in the hold when I was down there. One thing I, feeling I had was, first of all this is late in a long session...thing I had was like staring down a rectangular tube that was made out of some light pla- light metal or plastic that was like OD in in color, and that it was long, it was maybe long, but I only saw it from the end. But I had the feeling this was some unusually long thing, maybe 8 or 9 feet. And the only thing about it, other than rectangular is that each of it's corners is flattened off, so it's actually octagular. That's sketch 11.

Sketch 12, feeling of some little...

#66: This is when I was asking you to tell me about the equipment in the hold again?

#31: Yeah. Equipment in the hold. Some feeling for a small piece, like a towed wagon that had some funny square thing on it that pointed up at an angle, like a multiple rock- towed multiple rocket launcher piece of equipment, with big black tire on it. Um...okay. I've written down mobile, multiple towed, T-O-W-E-D, multiple rocket launcher. That was a strong feeling.

Uh, you asked me if there was anything else around there. There was an awful lot of stuff around. I did not feel that the hold was empty, as a matter of fact I felt that the boat was pretty well loaded. But the thing about it is that there were maybe 2 or 3 of everything and that there were probably other things in there that I did not see. I had the feeling that there was other stuff in there but I only got like a shot at 2 or 3 of the things to look at. A cylinder feeling, light cylinder, light colored, light toned cylinder, segmented cylinder barrel, 4 by 15 or 20 feet long. Uh, this was like a light color, like a steel would be it's light toned, like a reflective as opposed to painted black or something.

Sketch 13 is the feeling of the duece and a half type truck again..... Sketch 14 is an interesting, funny combination of input. I don't know if it's, what the heck the thing is. I describe it in the tape is being small like a bren gun carrier. A bren gun carrier is a World War II piece of, piece of British World War II equipment that carried about three guys, all it was was an automatic weapons carrier and it was tracked and it was very low and very small, not a big massive tank, tank, tank. This thing sort of was reminiscent of a, a snow cat type of thing.

Okay. Small, compact, oh- another feeling that comes through is prime mover, like something that's tracked that tow- pulls some other big things behind it. I wanna write that down 'cause that's somethin' I just remembered.... Like a snow cat or a bren gun

- #31: carrier. Maybe only 4 bogie wheels on the side and a couple carriers and everything. And it's not a tank, it's not streamlined and ballistically tapered and everything. It's very blocky. I've drawn just boxes on top of these treads here. Please understand here that that's not the real shape, that's the idea of the shape, because otherwise my shape is indescribable. It's blocky and square cornered and angular up against rounds. And I saw this thing sitting with some sort of apparatus on the back which had, uh, a long tube in it. And I don't know where this long tube thing came from, but it had a single long tube. Now I know that they have some- I know that the Soviets have something like this that is- it's the tracked multiple rocket launcher. That's the gestalt of it, is small like that tracked multiple rocket launcher. But instead of having the boxy rocket launcher goody on it, okay, it had a tube. One single tube sticking up out of the back of it.
- #66: Okay.
- #31: Of pretty fair size.
- #66: Now again you say that this equipment is not the only equipment on the ship?
- #31: No, I don't believe this is all that is there, but this is all that was either in that area or all that the guy is interested in for intelligence purposes.
- #66: Okay... Now, I'd like to go back to one portion which you skipped over in drawings because it wasn't necessary to draw and just ask you one additional question that doesn't involve you drawing.
- #31: Okay.
- #66: When you described the individual you described his physical makeup to me. Do you have any comments at this time about his personality? What kind of a guy is this key person that you spent some time with?
- #31: What kind of a guy is he?
- #66: Uh-huh.
- #31: He doesn't have much time for young wipper-snappers.
- #66: You- do you have any comments about his personality? You get any feeling about him at all that you'd like to comment on?...
- #31: Sort of sharp and preemptory. Uh, regards the whole thing as a pain in the ass. You know, not my talking to him so much as this whole mish-mash that he's involved in has been just a big pain in the ass and he's sort of a little, you know...
- #66: Okay.

- #31: Irritated about it...chafed about it, irritated about it. Uh, and I got that mostly because he just didn't wanna talk about it that much. You know, he just didn't, you know, well, god, you know, I think about it all the time, do I have to talk about it too, type of thing. It's really eating me out, you know, giving me a...
- #66: Okay.
- #31: A case. And, uh, I don't know, what else did I say, mid-forties, curly dark hair and sort of an aqualine nose and I don't think he's married, 'cause I...course who know? Maybe he just doesn't think he's married. He might be married. But, you know, I just didn't get any, really feel for it. I was mostly tryin' to answer your questions.
- #66: Okay, good. Do you have any further comments then, about your impressions of the target as you worked it?
- #31: Nope.
- #66: Okay, fine.

TAB

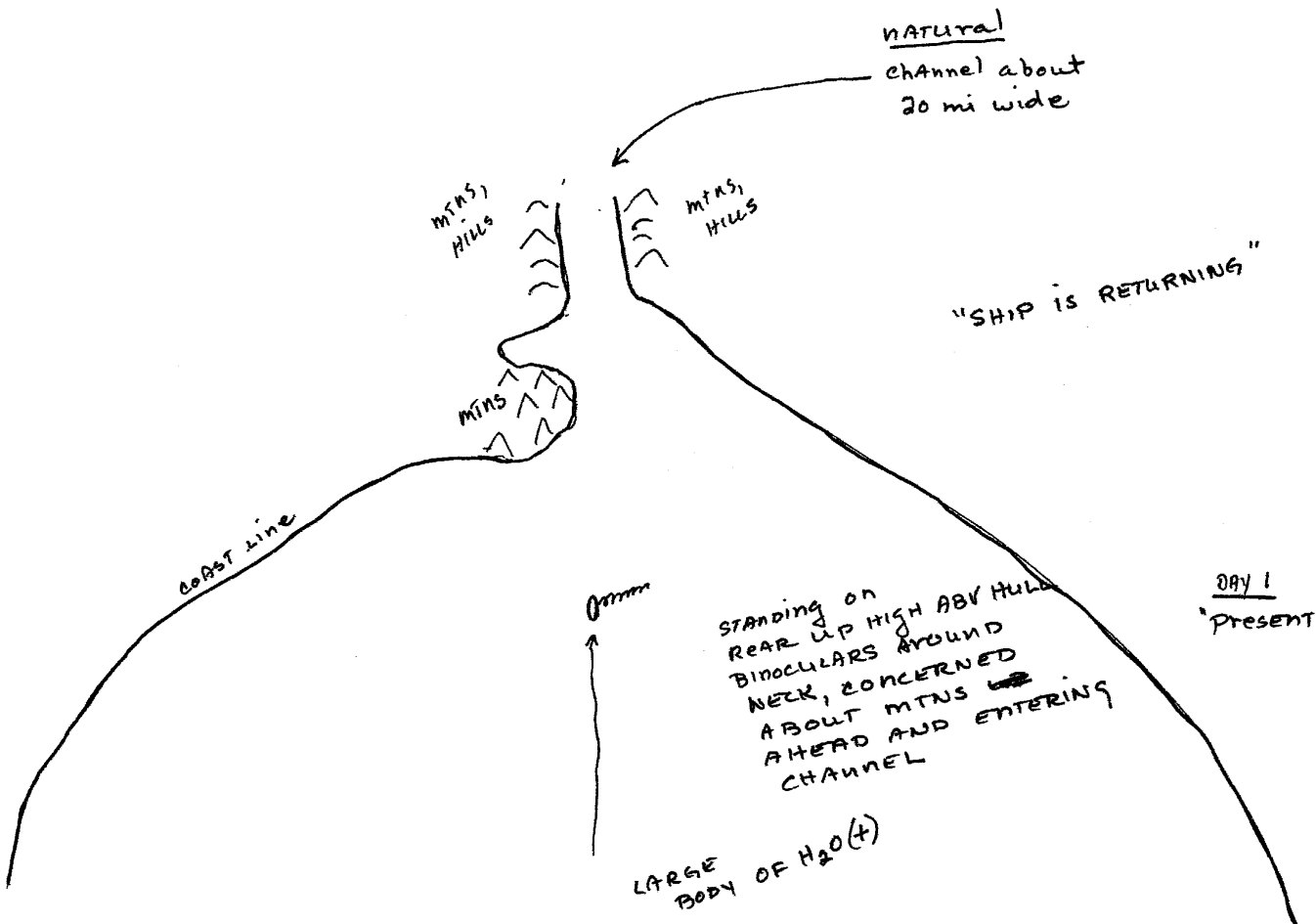

DAY 2
1 day in figure

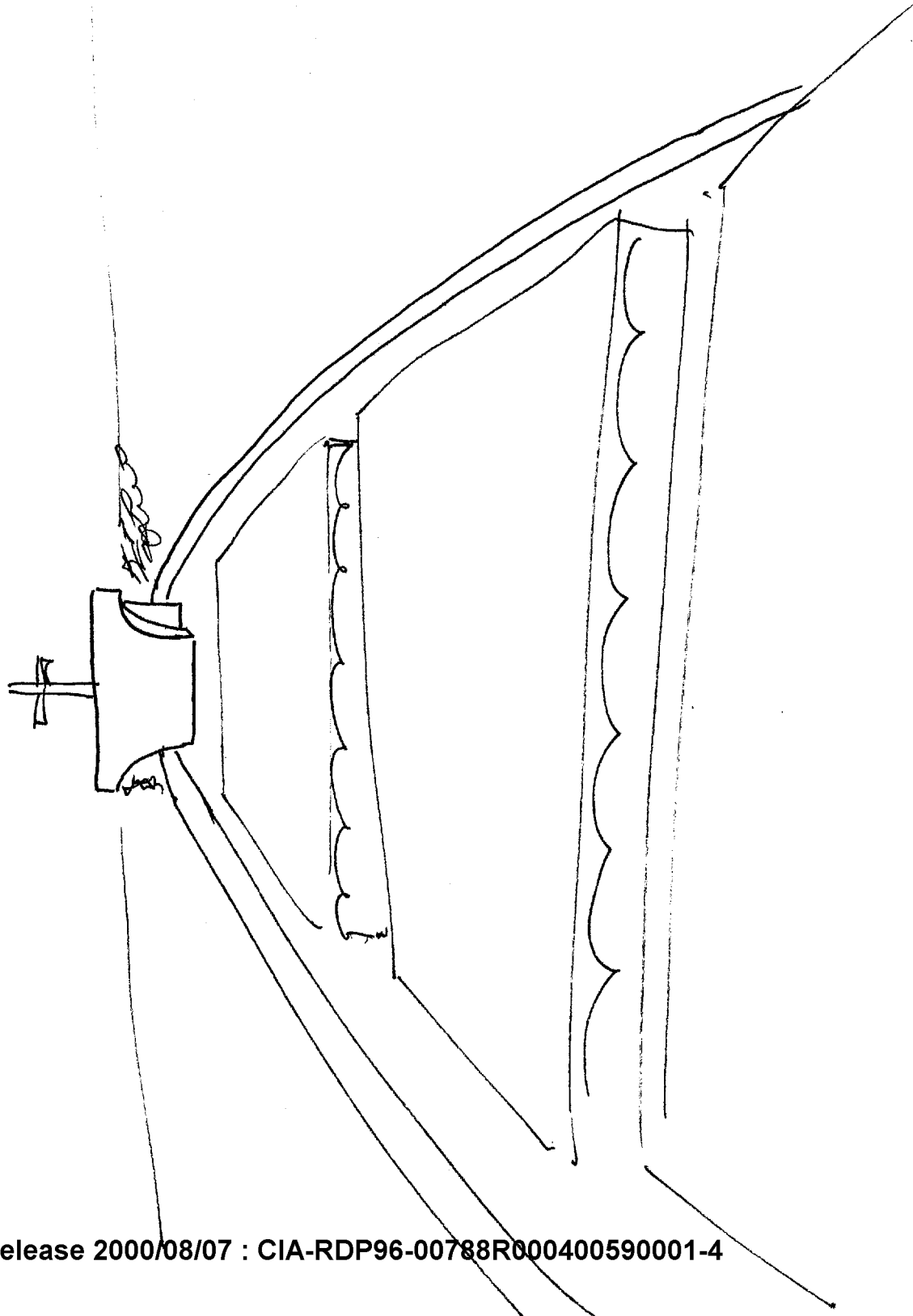

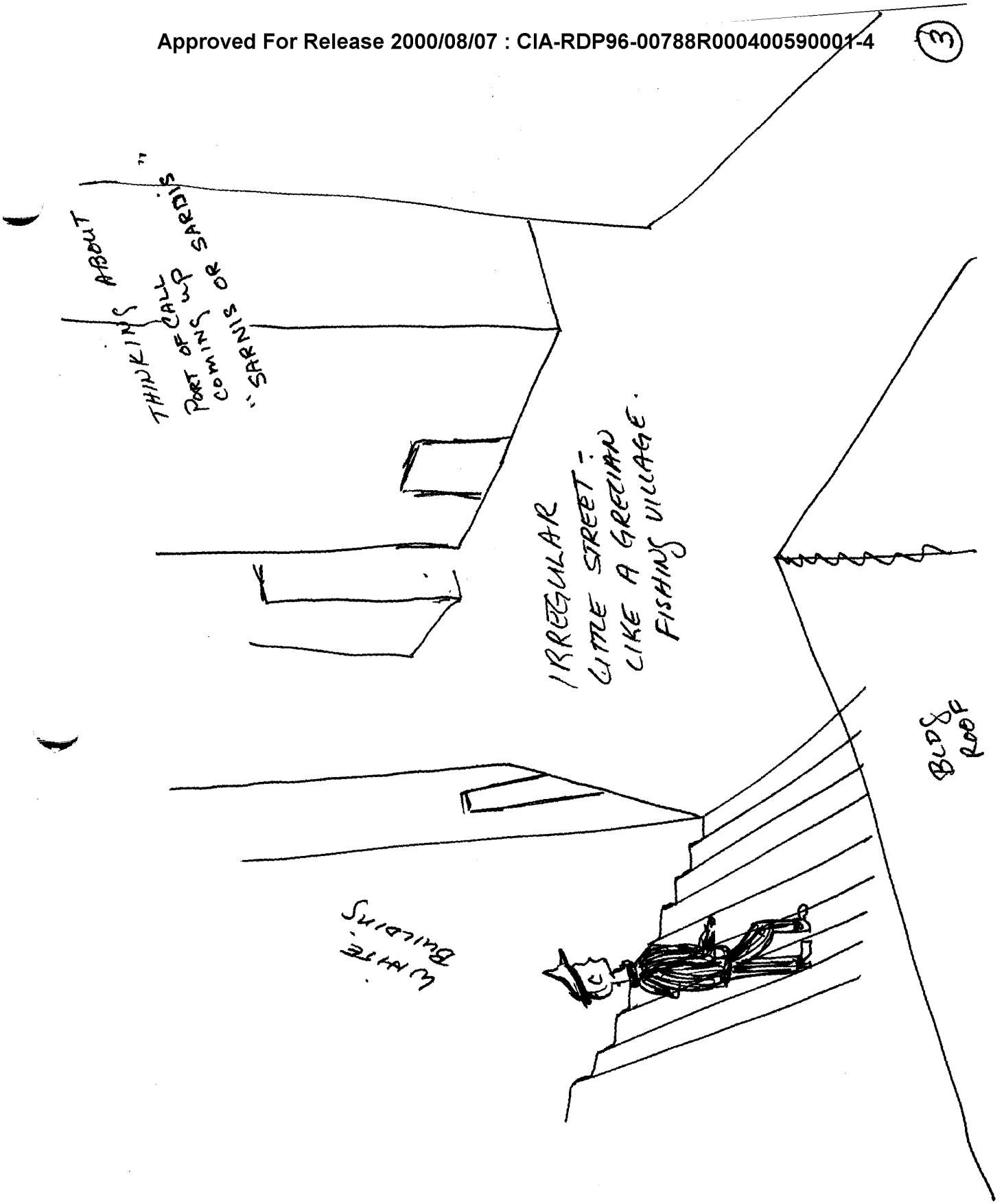

BIG WHITE
BOXES LIKE
CONTAINERS

(2 days in future)
DAY 3
IN THE HOLD
OF VESSEL

BIG
WHITE
BOXES LIKE
CONTAINERS

"the Pod"

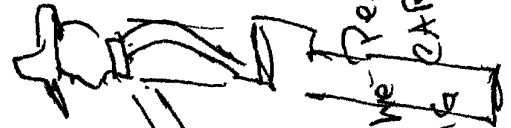

"find the REA in
the Pod"
"find the REA in
the Pod"
- directing
MOVING CARGO
AROUND

OTHER
PIECES
OF
PALETIZED
CARGO BEING
MOVED AROUND

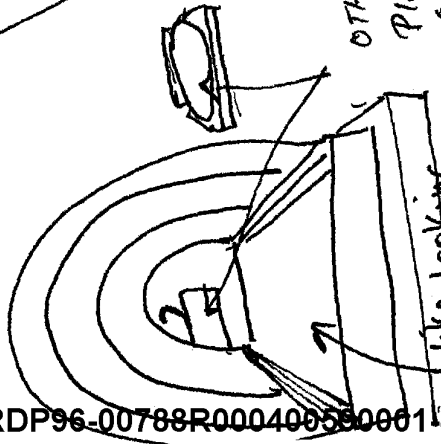

"like looking
in REAR of
"device in a hall

"BROWN" TYPE OF
CENTERS - A
TYPE OF
CENTERS - A
TYPE OF
CENTERS - A

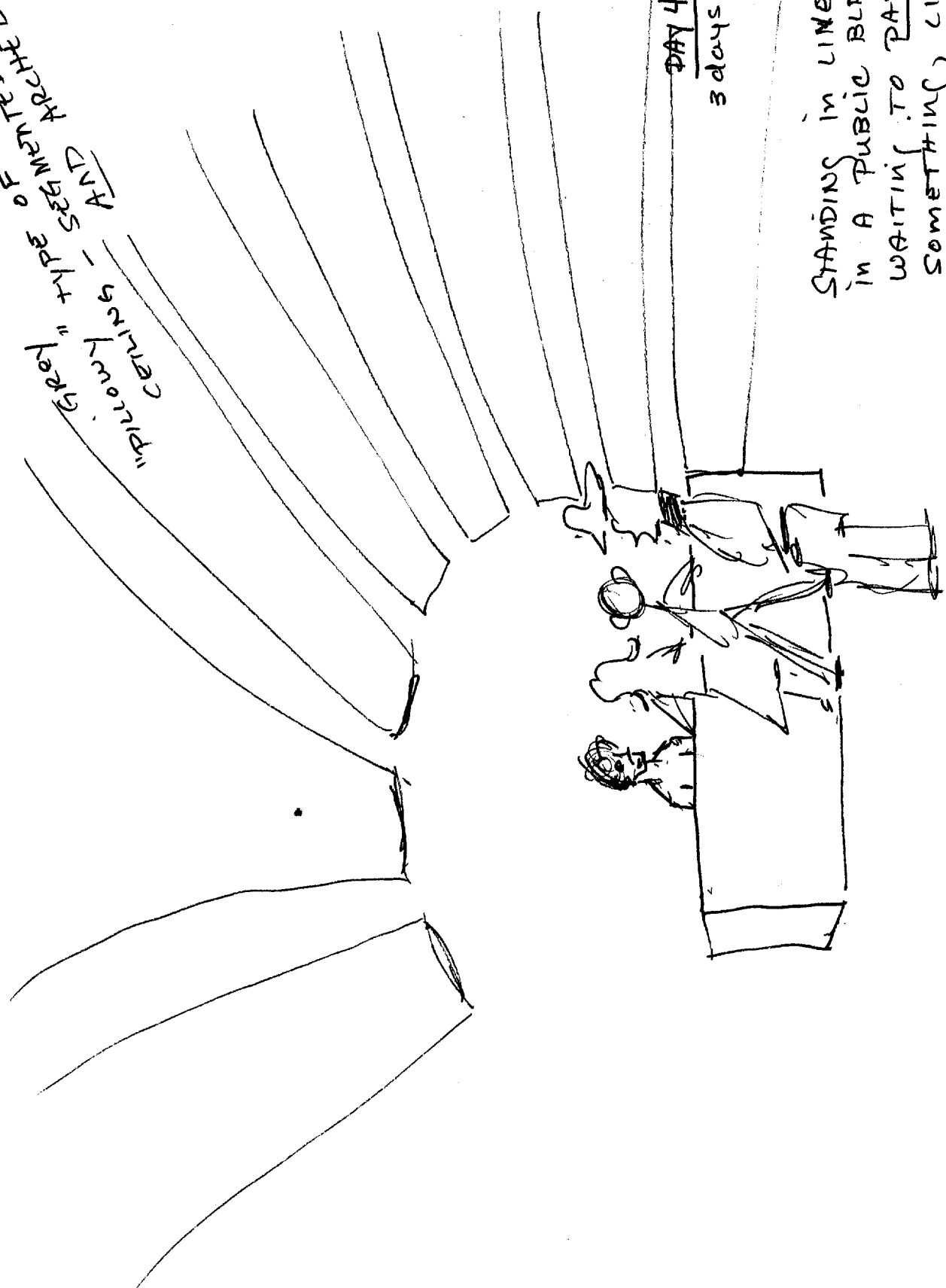

DAY 4
3 days in
structure

STANDING IN LINE
IN A PUBLIC BLDG
WAITING TO PAY
SOMETHING, LIKE
A TOLL OR A TAX.

DAY 4
3 days in future

ARRIVING BACK
AT BOAT BY
A LITTLE BOAT
WITH 3-4 guys
in it. Like
A SMALL CAJONCH.

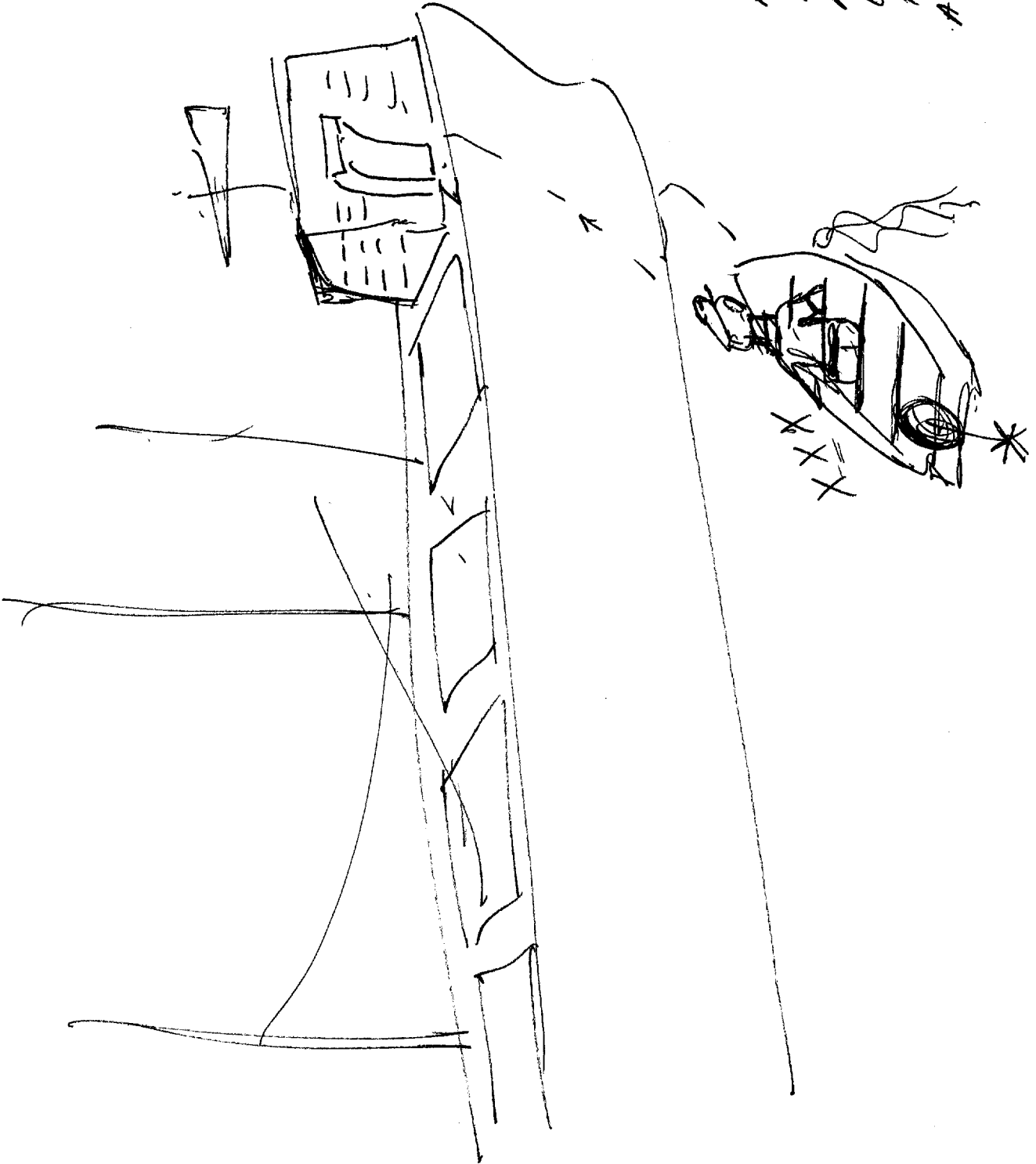

SIX
DAY
(5 days in future)

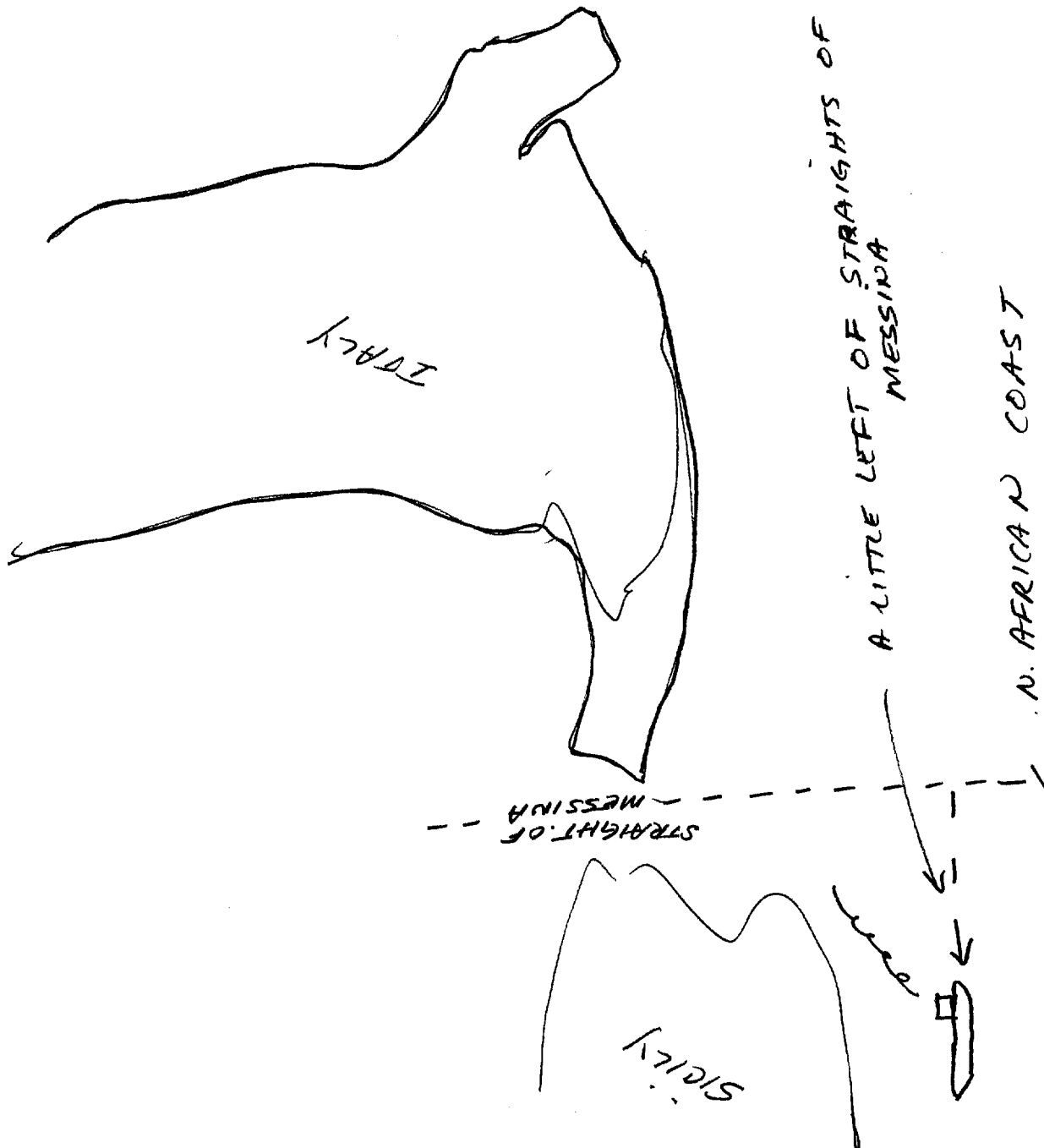

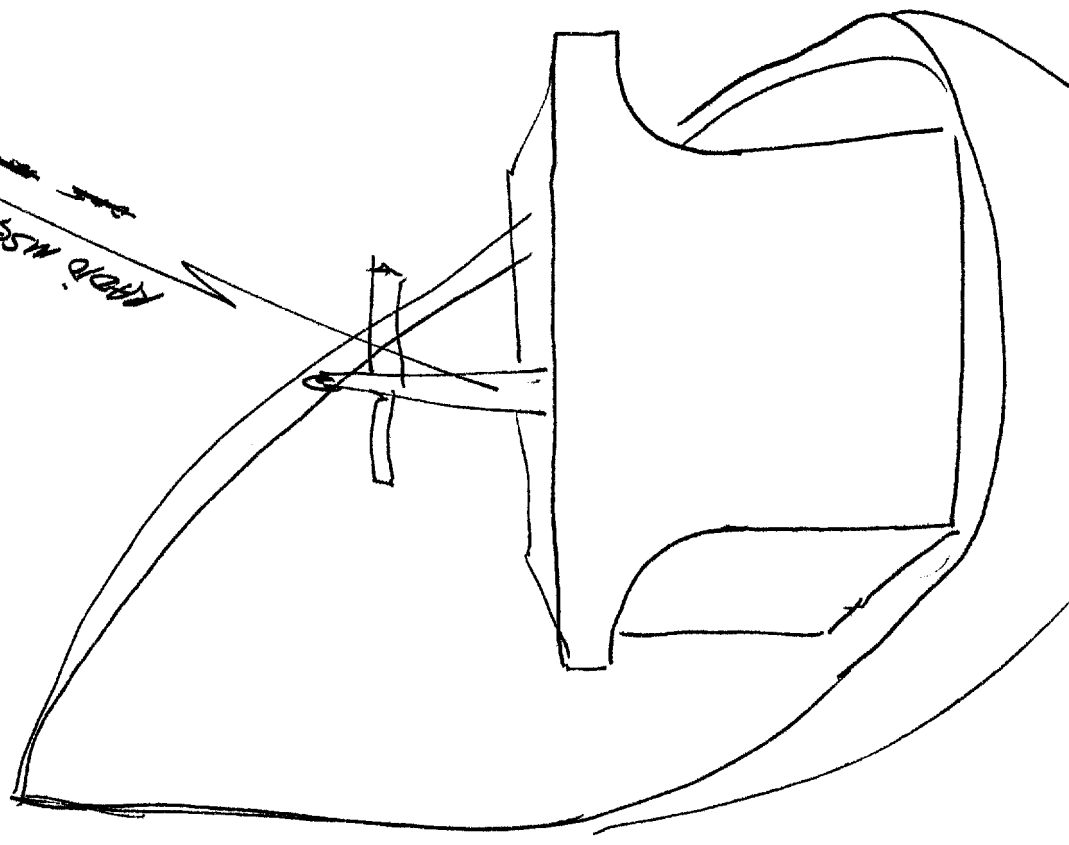
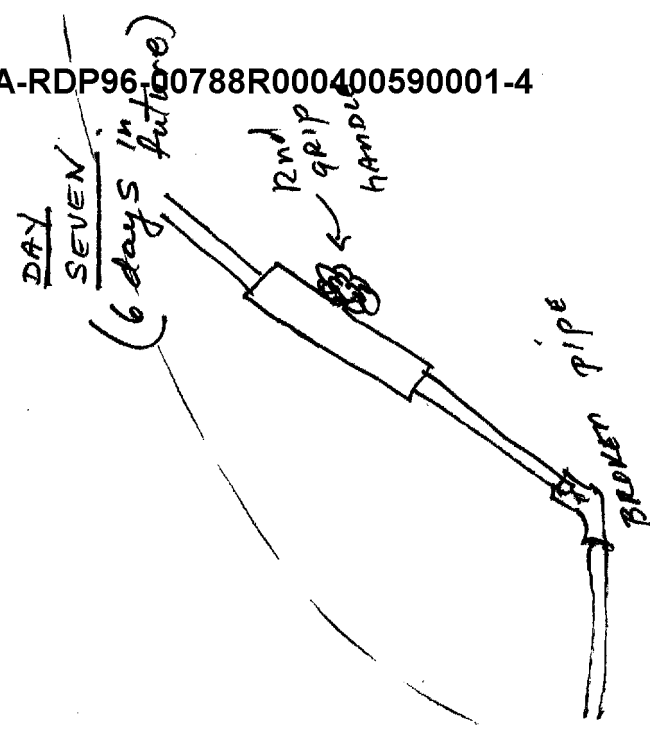
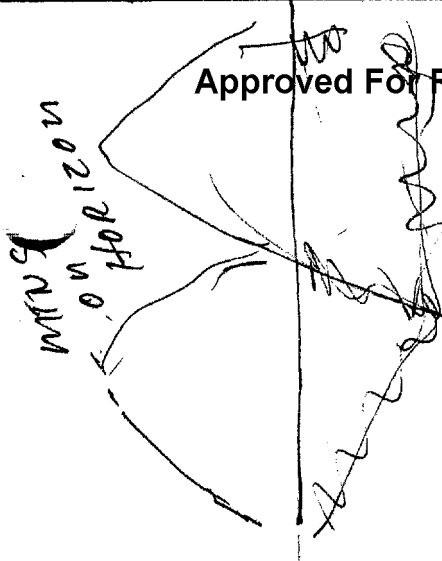

Handwritten notes on a diagonal line with arrows pointing to the right:

- UPPER VOICE KIMSN
- UPPER VOICE
- NSG

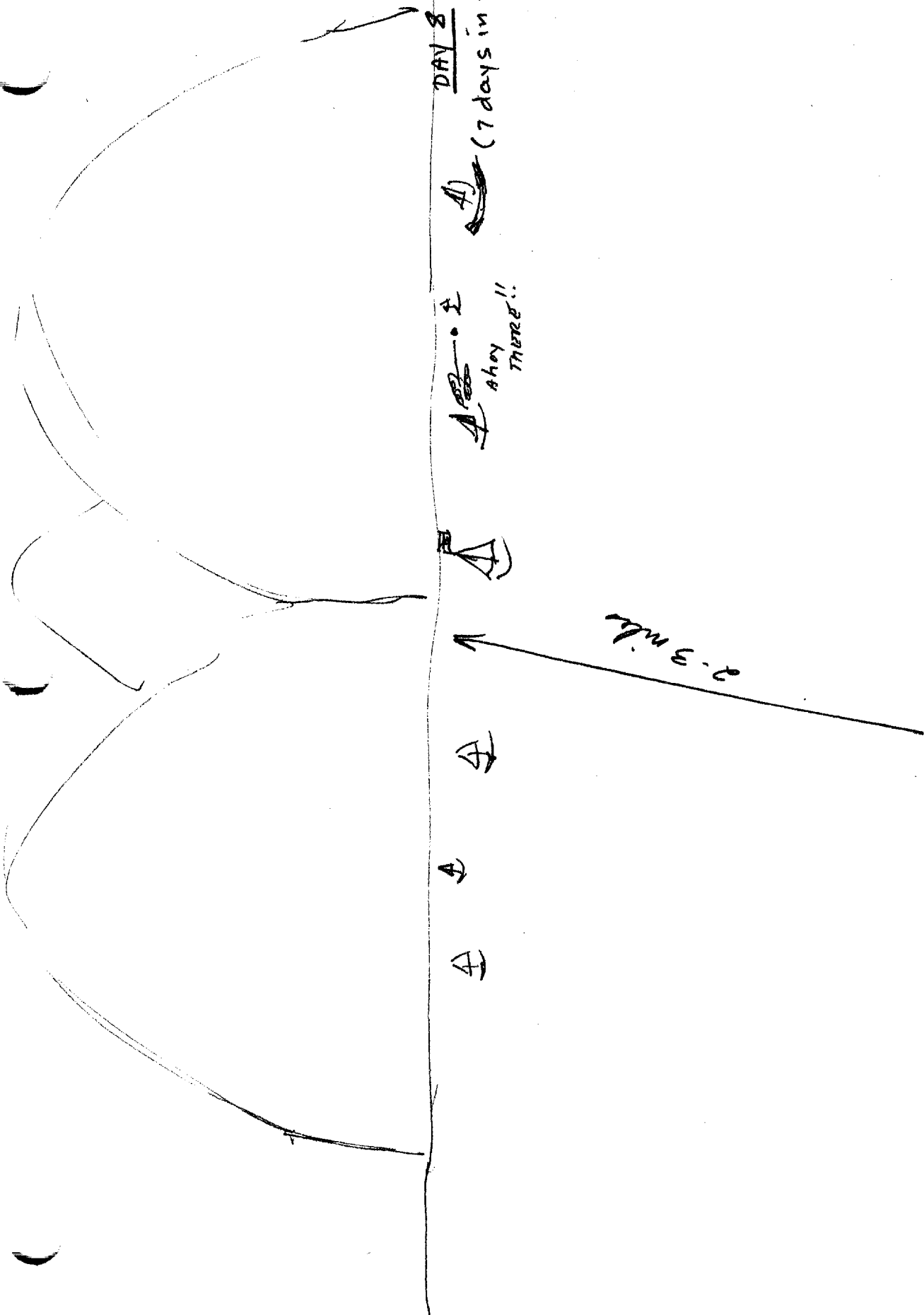

SHIP IN CHANNEL
STEAMING
AHEAD

MTAS
OVER
THERE

BOW OF IMPORTANT
BOAT

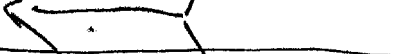

O.D. LIKE PLASTIC OR LIGHT METAL

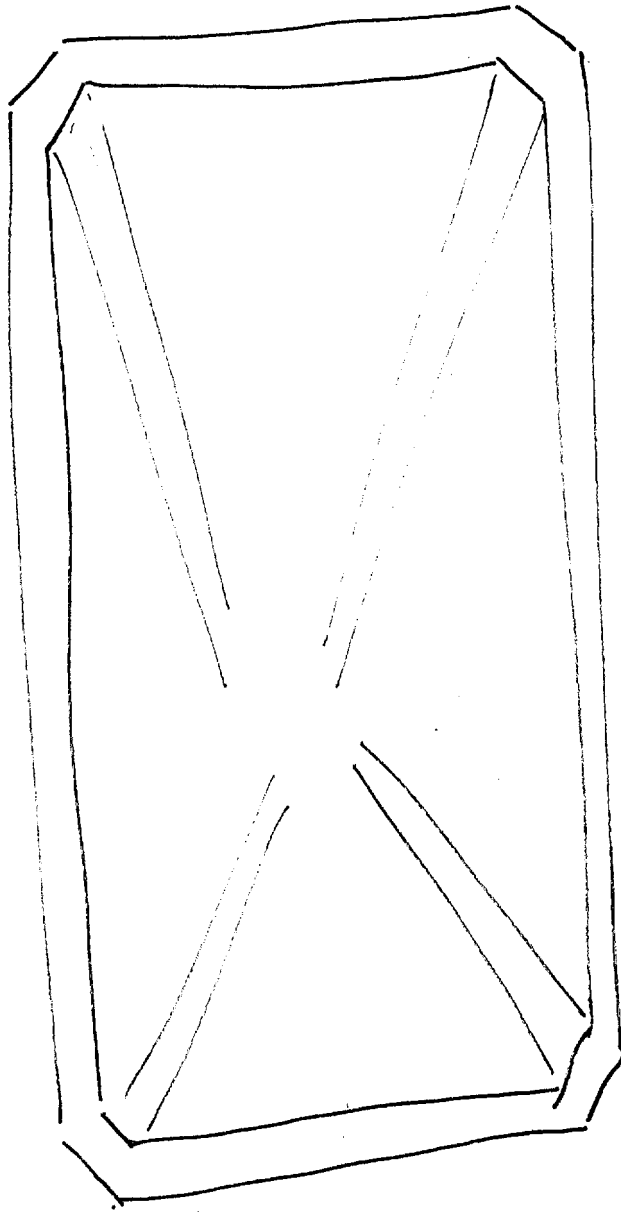

Aug 15-8

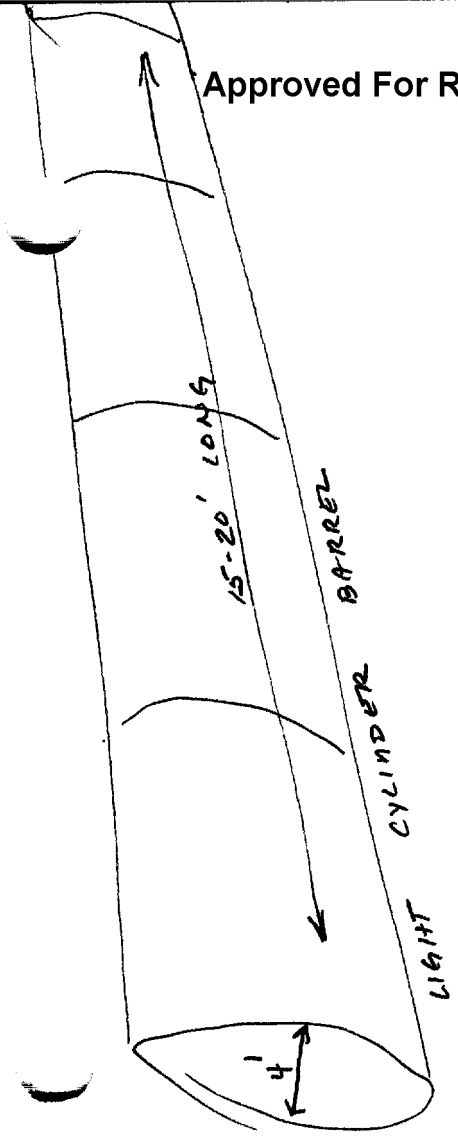

ROCKET LAUNCHER
 SOMETHING PULLED
 SOMETHING BEHIND
 ELSE
 MULTIPLE
 MOBILE TOWED

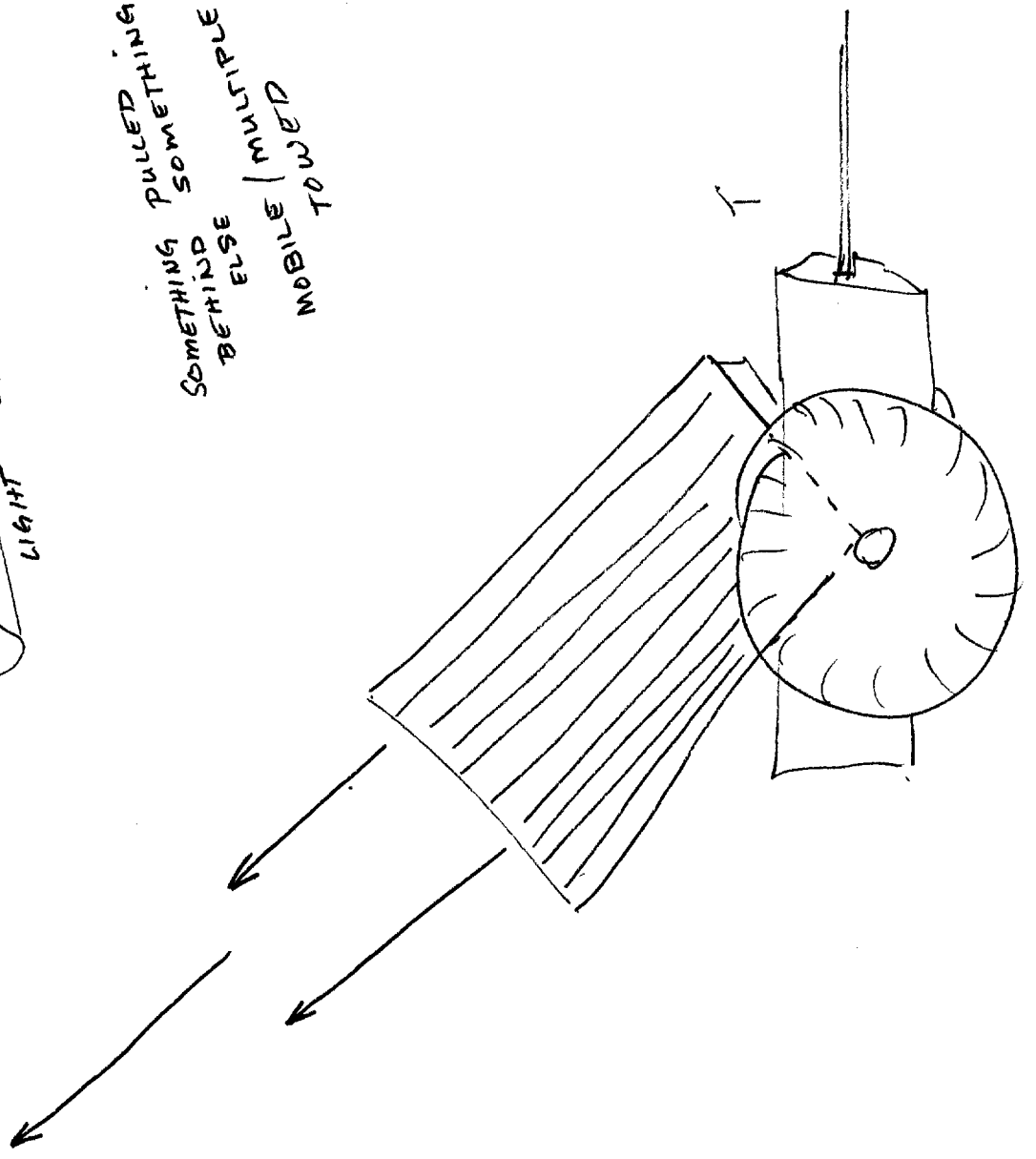

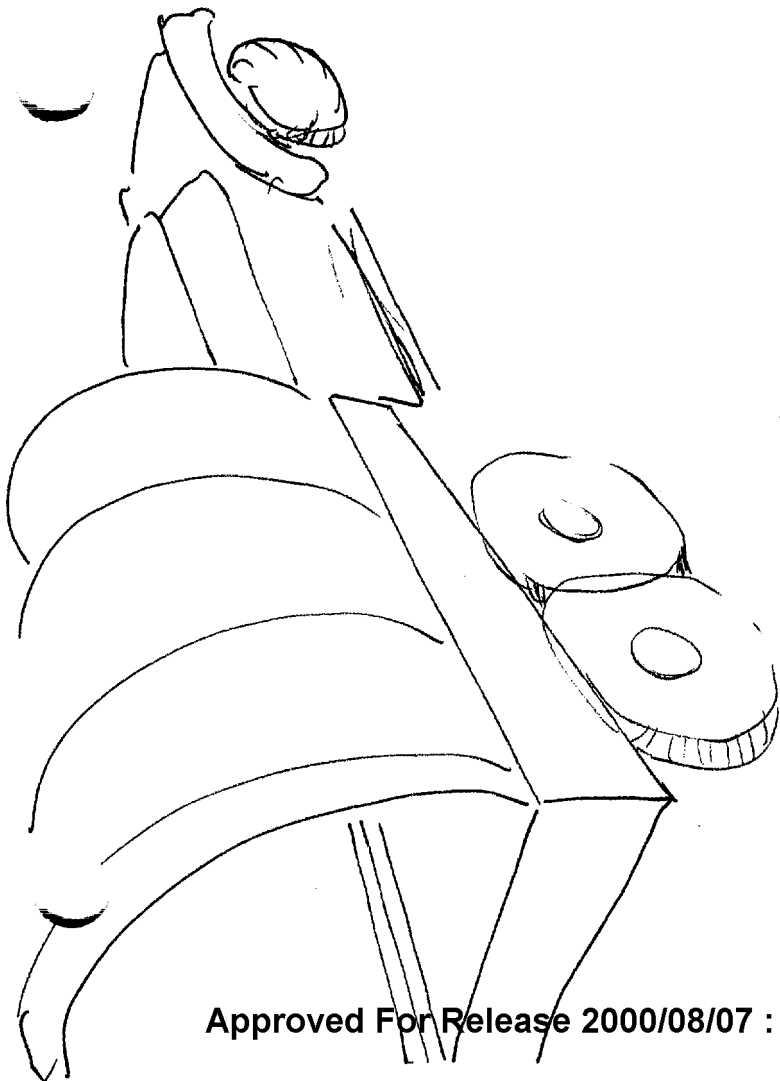
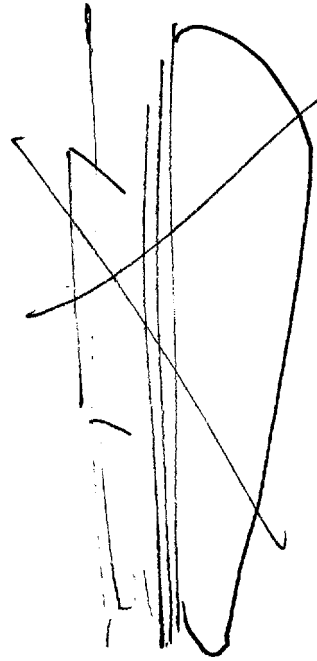

LONG TUBE ON
REAR OF SMALL
TRACKED VEHICLE

"VERY BOXY"
TOP ON
TANK TREADS

NOT A TANK
SQUAT AND STUBBY
LIKE AN OLD
BREN GUN CARRIER

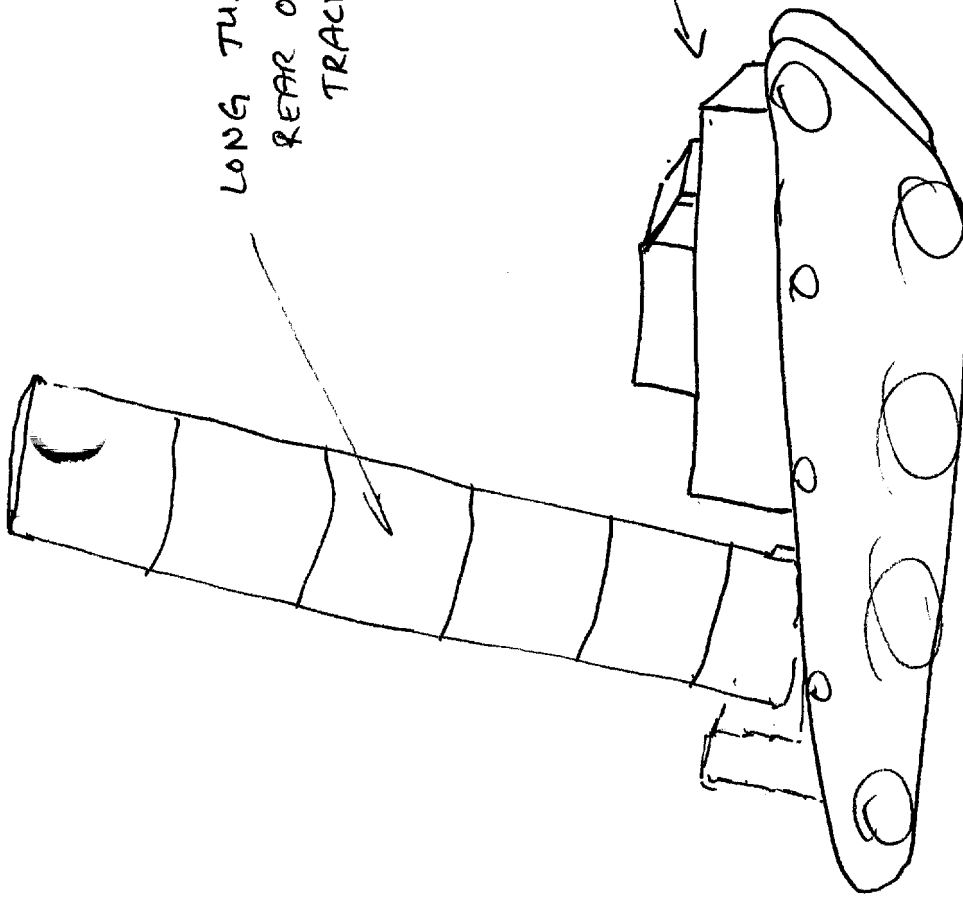

PRIME-MOVER

TAB

TARGET CUING INFORMATION

REMOTE VIEWING (RV) SESSION DC-43

- SG1A
1. (S/NOFORN) Prior to the session the viewer was shown the attached photograph and told that his target would be the sister ship which was called the [REDACTED]
 2. (S/NOFORN) During the session the viewer was asked to describe the activity of the "key person" on board the ship for the next seven days. The viewer was asked to describe the location of the target ship.
 3. (S/NOFORN) During the session the viewer was asked to elaborate on portions of his perceptions by the interviewer as directed by the control monitor.

NOT RELEASABLE TO FOREIGN NATIONALS

SG1A

Approved For Release 2000/08/07 : CIA-RDP96-00788R000400590001-4

Approved For Release 2000/08/07 : CIA-RDP96-00788R000400590001-4

TAB

~~SECRET~~
CONTROL MONITOR COMMENTS

REMOTE VIEWING (RV) SESSION DC-43

1. (S/NOFORN) The control monitor (CM) only was able to listen to the very end of this session because he was busy monitoring session DC-42 which was being carried out at the same time.
2. (S/NOFORN) The following questions/directions were given to the interviewer by the CM during the session:
 - a. Is the "key person" still on-board (day 7)? If so, describe him.
 - b. Is there any cargo in the holds of the ship (day 7)? Describe.
 - c. What is the viewer's overall feeling towards what has been going on?

NOT RELEASABLE TO FOREIGN NATIONALS

~~SECRET~~

~~SECRET~~

TARGET DATA:

(1) Picture of sister ship

SG1A

(2) Actual target is the 

Note: color of the ships are different,
but construction & design
are the same.

EEI:

SG1A

1. Where is the  Now?
(AS of 1330 HRS, 11 Dec 80)

2. What is it doing?

3. What will it do in the next 7 days?

4. Is the "key person" who is
controlling the activities of the
ship aboard the ship? If not,
where is he?