

SECRET

ORCON/NOT RELEASABLE TO FOREIGN NATIONALS

INSCOM

GRILL FLAME

PROGRAM

SESSION REPORT

CLASSIFIED BY: DIRECTOR, DIA  
REVIEW ON: *10 Mar 2000*  
EXTENDED BY: DIRECTOR, DIA  
REASON: 2-301c (3 & 6)

GRILL FLAME

SECRET

SUMMARY ANALYSIS

REMOTE VIEWING (RV) SESSION CCC10

1. (S) This report documents a remote viewing session conducted in compliance with a request for information on an area of interest.
2. (S) The remote viewer was able to attain his usual state of relaxed concentration during the session. Ambient room noise was moderate and periodic. He was disturbed by ambient room noise at times but was able to regain his concentration when the noise subsided. After the session he expressed his confidence in his imagery.
3. (S) The protocol used for this session is detailed in the document Grill Flame Protocol, AMSAA Applied Remote Viewing Protocol (S), undated.
4. (S) Following is a transcript of the viewer's impressions during the remote viewing session. At TAB A are drawings made by the viewer reference his impressions of the target site. At TAB is target cuing information reference this session.

**SECRET**

TRANSCRIPT

REMOTE VIEWING (RV) SESSION CCC10

TIME

#28

This will be a remote viewing (RV) session for the 4th of March 1980. We have an on-target time of 1400 hours.

PAUSE

SG1A

Relax and concentrate now. Relax, relax, relax, relax, relax and concentrate. Focus. Move your awareness. Move your focus. Move through time

Relax and concentrate and tell me when you've arrived on the target

PAUSE

+06

#31

Have a feeling of a, a big palace or monument with a, a vertical columns high up like. I see a, a big building, skyscraper, skyscraper...seems across the street.

#28

SG1A

All right. Once again let yourself relax and concentrate. Relax and concentrate focusing on

+09

#31

Have a feeling of a....desk...a feeling I'm high up in a nice office building or something like a high ....look out the window I'd I see outside. Desk, a large desk. Feeling of flags, drapery behind it. The room seems funny. As though it's triangular shaped. It's as though I was at the end of a hall at the head of the arrow, and the wings go off on the other side, and then there is a desk. I feel he is sitting at a desk. At the center of the base...some carpeting

**SECRET**

SECRET

nice...uh...windows...uh...covered by a vertical lines on either side of the desk. A feeling of an old fashioned ink bottle with a long, dark pen on the upper left corner of the desk.

SG1A

#28

All right. Listen carefully now. Listen carefully. Focus your attention on him. Focus your attention solely on [REDACTED] Describe his primary duty.

+13

#31

He is involved a, a I feel a re....reorganizing of a....big governmental structure. ✓

#28

Tell me the raw data which makes you say that.

#31

He is...uh...feeling of him taking on organization ideas and discarding them...a screener a proponent a trying ideas and evaluating some for organization, but I did not feel military in its...I felt rather a civil body. ✓

SG1A

#28

All right. Once again. Relax and concentrate. Relax and concentrate. Focus solely on [REDACTED] Describe his prime concern.

SG1A

PAUSE

+17

#31

I had these....almost a fear a heavy concern for stability...uh...feeling of the country...uh...no small minute thing rather an amalgam of feelings of civil disturbance threat from within. Trying to get a solution to a an age old problem compact many facets. ✓

SG1A

#28

All right. Relax and concentrate once again. Relax and concentrate. Focus your attention solely on [REDACTED]

PAUSE

#28

Describe his specific activity as you observe him.

PAUSE

+21

#31

Feeling of receiving visitors in this office. I see him reading and reviewing papers and....they are studies, they are thick manuscripts. They are not single pieces of paper. They are almost bound documents. They are like legal size. They are longer than regular paper. They are.....he's reading ✓

SECRET

**SECRET**

these. Many peculiarly long and skinny...but they appear bound on the left side. They...uh...appear to have a light green cover. A formal cover. I see a various things. The most activity is (mumbling) sitting at desk.

SG1A

#28

All right. Fine. Now, listen very carefully. Remaining in the vicinity in space [REDACTED] close your eyes at the target location. Close your eyes now, you are no longer aware of the target, but you and your awareness are still in the vicinity of [REDACTED]

SG1A

PAUSE

#31

+27

Feel as though I am...I don't know...feel as though I am...uh...in an enclosed place, but I'm standing in front of a tiered audience along bleacher rows of audience that is maybe twenty or twenty-five high. Like a race track reviewing it's stand. Grand stand. Something long and people sitting in it everywhere, and then down below it's level, and it's some sort of a funny thing that sticks out of it that people stand on to make addresses. It's almost like it's below in level on each side of this thing. It's almost like it's outdoors, but it's indoors. It's a big thing and I can't figure it out. It's...it's long and flat in the base. Along the side of it are these...uh...off to one side of these seats, tiered seats...shooting out from the front of it is like a little knob...looks like a little water droplets sticking out from the bottom of this thing. It is white as though it was a dies, dies or a little band shell, but without the shell around it. This thing is down low so that the people that are in this stand can look down at them. Whoever is there. I think our guy is on that, as though he is being presented to someone or as though he is being reviewed, or being seen, or being questioned.

SG1A

#28

Ok. Relax and concentrate for a moment now. Relax and concentrate and let your attention focus on the man [REDACTED]

**SECRET**

SECRET

PAUSE

#31 Keep seeing...keep seeing him on a die, with 3 or 4 other people. Feeling of bunting and pass in review. The feeling I have is that this die sits down in front of the reviewing stand, and there's a little box that people sit in when they review, but I see...the feeling of movement along in front of this place, but I simultaneously see picture of a man standing and three or four sitting near him. The man standing is speaking like from a rostrum (phonetic) speaking into a thing like a microphone, but the predominant feeling is that he is looking away from this big bench thing out into the open area in front. At first I thought he was looking back at the stand, but...as though he were answering questions, but after that, and stronger is the feeling that he is looking away from the stand and rather is speaking to troops or to an assembly of people below and away from him.

SG1A

#28 All right. Once again relax and concentrate. Relax and concentrate. Relax and focus your attention solely on [REDACTED] Focus on him and describe his prime concern.

PAUSE

#38 #31 The...uh...role of the military in maintaining... stabilization of government is one which will never change and must be maintained, and is a role that cannot be diminished...uh...feeling of like a... feeling of a new...uh...thought in political thought that this is...uh...the military does have a key role bigger than before. That's not going to change, and that is the answer to problems, instability... maintains the momentum...uh...mobilization...uh... this is the new...uh...new thought is not going... I have the feeling like...uh...I'm not, not going to take second fiddle to the civilian body or civilian rule, because that always ends up messing things up.

Looks like he's ...uh...making a new vocal policy statement about the future that...the key to that future is...the military, I guess.

#28

SG1A



SECRET

SECRET

PAUSE

#31 He is...standing and 2 seated men on his left. I don't see the man on his right. He is speaking standing on a small platform...standing behind somewhat of a low rostrum (phonetic) that is belly high. See him moving his right hand to emphasize points. See him gripping the rostrum with his left hand.

PAUSE

#28 All right. Fine. Relax and concentrate now. Close your eyes to the target scene and let your imagery go blank. Return now through time in space. Return now to time in space. Move your arms; move your legs and prepare to draw the perceptions that you had.

#31 The first feeling I had was like colors standing, and that in front of these colors was...or guide (phonetic) this is a little peculiar thing here too, or guy (phonetic) who has a funny desk...weird desk. It's like each side of his desk is elevated and he has a writing area inside. This is looking at the front of the desk. A real nice open type table, but it's got a bump on each side, ok, and next to him, next on each...the wing backs here in the back of the room are nice white draped curtains...really, I got a really plush feeling. A really plush general...better than a general's office actually, when you get right down to it...white...sheers and the same thing on the other side.

Had our guy sitting in the back as though he was reading. The feeling here was that he was reading studies. He was not reading single pieces of paper. He was reading bound documents and feeling was as though he was considering options...considering methods of organizing a civil....not....it wasn't a military. It wasn't like he was organizing a division or a brigade or how many tanks to put in a division, or anything like that. It was as though he was in...like a reconstruction thing. Like he was trying to figure out what the best method of organizing a civil body was to be. It had nothing at all to do with military. It was much more political military, you know. Heavy on the political side of it. ✓

And...uh...the funny thing about this room is that it was at the end of a hall...I'll draw an overhead. It was arrow shaped. I didn't get the feeling it was square. It was as though you walked into the hall where ✓

SECRET

**SECRET**

you spit out this hall and this...the big room at the end of the hall..it winged back from there... the back wall and then it came across like that... and he sat right in front of the door, but that these wings were slanted. It wasn't a rectangular room. It was a slanted room...arrowheaded shape. Ok. That's one thing.

He was reading green...I got the feeling it was a pale green color, bound documents. They were oversized like they were legal sized bound documents, and I looked at the legal size, you know, and I was thinking to myself usually legal size is a legal pad and somebody flips through it like this, and I sort of like took a little closer look and they weren't. They were bound on the left side. I don't know. I had the feeling that they were bound on the left side anyway. It may or may not be the way they do it, but... OK.

So, a feeling for the shape of this room is like this in sketch number 2. Window there. Window there. Flag pole there or flags. I had the standing flag fleeling. With the desk here. The desk being a real nice solid oak and type thing and it's got these funny raised things on each side of it, and old fashioned ink bottle sticking out like that, and it was a black ink bottle sits there on the left. Think the guy's lefty, I don't know, but.....ahh.....these are windows.....here's a flag, ok, and the guy sits there.

My feelings of association are...I don't know...did I go over them well enough...what I thought the guy was thinking about...like I said he was reviewing...It was like he was saying, no, that's too much solid one way. We've got to do something to stabilize the country type of a thing, and then, no, that's not strong enough. He was going through various....like people had sent him suggestions, and he had like 3 to pick and choose from. He was going over this in his head.....or not the country, but rather whatever organization, ok.

On to the next one?

#28

All right.

#31

Then I guess.... You'll have to refresh my memory. Was that when we moved then?

#28

Ok. After you were through describing...uh...time frame of.....

**SECRET**



~~SECRET~~

#31 Oh! Remind me to go back and do my first imagery too.

#28 All right.

#31 Which was just my acquisition imagery, but.....

SG1A

#28 . before we focused on himself. Ok. Then we moved in time to [REDACTED] and not knowing where he would be in and around [REDACTED] whether he would be in the same office or not, I attempted to let you free-flow that so that you were at liberty, at least, to come up with another location.

SG1A

#31 Uh...the imagery, the imagery, the acquisition imagery here was as though I was standing in...well it's hard to say...it's as though I was standing on the infield of a ball diamond, or the infield of a race track is better. But, that the grandstand was not some humongous thing that went up some 80 feet in the air. Rather, the grandstand was something that was more like a low set of bleachers. It had maybe 25 or 30 rows in it and they went back. All I saw was one, one strip. I don't know if this idea of grandstand is curved or if it is straight or not. All I saw was straight portion. Had the feeling that I was.....it was a mixed feeling. It was as though I was outside...it was as though I was in a place where I should have been outside, but I felt inside. I felt as though this place could have been an outside...right to begin with, I was a little mixed up...whether this could be an outside huge race course, type of public address place or maybe it was one small fragment of a large building...interior room that I was looking at. But it was....I had the definite feeling of some sort of covering over it. I really did, and I couldn't make it out. What I ended up with then was what I saw going off in the distance here, ok, like that. This being a wall, ok, and this being the seats. Tiered seats, and the thing is only .....what did I say.....20 rows max, ok. Now, jutting out from this it's as though there is a dies there. I had a curvy feeling. It's as though it's curved. It's not round. I mean it's curve is not round. It's curved. It's not square, ok. This juts out, like that. And the rest of the stand, or bleachers, or whatever it is goes on this way. I had the feeling even that the... yeah, I had the feeling that.....ok.....and it's curiously set.....it's curiously set off from the wall. I'll draw an overhead feeling here. It's as though it's almost separated a little bit to make it a little bit different. To make it a little bit farther out

~~SECRET~~

**SECRET**

forward of the regular seats in the back. Well anyway, how do you spell dies? Dais, or dias. I don't know. You know what I mean. It's like when you're up...when you're out in front in front of everybody.....a podium, a big podium. A sub-band stand, I guess, is what you call it. The idea of several people being here...I...several...wrong... 4 people being here, of which our guy has the X over him. He's standing, and then there's 2 there, and he has, he stands behind a thing that's got a microphone sticking up out of it, ok. Now, I had two various thoughts. This is a little muddled here. This is what I settled on.

The feeling that....in 3.....the feeling that a ceremony of some type was taking....a massive ceremony of some type was taking place. Ok. And that they were proceeding this way...passed in front...and then that they came around, and they assembled. Massive ranks assembled here before the dies, ok. Assembled ranks here, ok. So they pass in review type of a situation. They all come here in what would be the infield, I guess, and then our guy starts talking. You asked me what he is doing. I had him addressing the people. He was speaking from this podium, and then I don't know what I said. Because I think...I really don't recall. I know that I was talking but I really don't recall what it was I was saying. The essence of it being...I really had a good feeling. Like I was right in there. The essence of it being the fact, you know, it was a new system and this is the way it's going to be guised. The new plan is this. We're not going to take it in the ear anymore. We're going to have more of a ready hand in whatever it is that we're supposed to be doing etcetera, etcetera, etcetera. That's about it. Sort of a da..... The feeling from him was that, well, you know like when you're about ready to jump out of the airplane, this is it, you know (whistle). It opens or it don't. We'll see what happens, type of a feeling. This was sort of a feeling coming from him, you know. Like, well here it is, you know. I can't, I can't put it off any longer. This is going to be the one. We'll run this up the flagpole and see if anybody salutes....type of a situation.

The alternate to 3 was some..... I couldn't figure out if this guy was talking away from the grandstand or if he was talking to the grandstand. It was a little mix up there. When I first went into the imagery it was as though he was baring his bones before....like a

**SECRET**

**SECRET**

Senate committee, you know. I had this feeling of sitting before the diet, answering questions and speaking through a microphone. The idea of speaking public address microphone in a different, in a segregated area was very strong but the relationship between the audience and the speaker was what I couldn't figure out. That alternate feeling would have them...the rows bleachers, or seats, you know, podium seats rather, with the podium reversed and him speaking into the crowd...into the observer crowd, and I couldn't really get that hashed out.

#28 Do the...in the perception of him facing people sitting in rows of seats...in that perception of the happenings do you still have the...uh...rows of ranks as that part of that imagery?

#31 Like behind him...what would then be behind?

#28 What I want to know...I want to know what your imagery is.

#31 No. No. No. The imagery there is limited to...into the dies and the row seats...into the dies and the row seats with the dies turned around and with the attention of the speaker and this guy being directed towards the rowed seats instead of what in sketch 3 has him with the rowed seats behind him speaking out into this infield. This assembled ranks. There's a little bit of humble jumble there, ok. The feeling.....again, though, the initial feeling of row seats...that's a hit...you know. That's right on. No question about that. This separate, slightly separated area where he is, that's no trouble with that and the fact that he's making public address of some kind, that's no, no trouble. Where the trouble was in my imagery is what the relationship between, you know. Which way he was looking and who he was speaking to. Ok. That's, you know, and with that comes this pass and review thing you know, because in the alternate system there wouldn't be any pass and review, you know, because he wouldn't have anybody, you know. That type.....

Ok. An overhead is sort of like this. This rounded in 4. Here are the rank seats. Rows of seats. I'll call this number 3 overhead. There is a guy here. Our guy there with the X speaking into a microphone. Another guy here and another guy there. Again, there's this thing that's like a little nodule that sticks out front. But it's round. That's this rounded feeling. The other thing on it is bunting, ok. Around it. I know that the

**SECRET**

**SECRET**

SG1A

[REDACTED] but the word occurred to me here, in 3, I used it just now, earlier...that did occur to me during the session when I was in this imagery with rowed rank seats and him speaking publicly.

#28

And what does that word mean to you?

#31

[REDACTED]



SG1A

What else?

#19.5

How do you feel about it?

#31

I feel real good about that, and I feel real good about what I already just explained. You know. The general...the flavor of this. I am, I am the first to point out though there are two alternatives here. Two variety...feeling. I feel pretty strongly about the sensations that I got. In other words, picking, trying to pick his brain. I feel pretty strongly about the civil association at the first part of this session. Again, him attempting to decide which way of 2 or 3 alternatives they were going to go and trying to go through organizations in it. Not being military. But, rather being...a civil decision being made. Having to do with the body politic, ok. How to keep the body politic appeased and down in the streets and not rioting. I did, I did get this, almost this fear that I better make the right decision or else the lid's going to blow off. You know. Boy, if we blow this one there's going to be hell to pay.



\*

#19.5

Do you have a feeling as to whether or not that decision that you just talked about was made before or after the 17th?

#31

I have the feeling....in the first part of the session the decision was being made and that it was made between this part of the session and this part of the session, because when he was up doing his thing in front of God, and everybody in the last part of this session that was the feeling, you know, well we have got to run this up the flag pole. You know. We can't put it off any longer. This is the way it's going to be, and I tuned in on these



**SECRET**

**SECRET**

really aggressive type system change words. You know. We're not going to have this screwed up system that we had before. We're going to have this one now. You know. The military is going to stay...what did I... The military is going to stay in a position of strength. We're not going to turn. I had the real feeling that we're not going to turn over the reigns of government to civilians again, and that the military would be the final check in the check and balances system, and that's the decision that he was trying to make here....one of the alternatives that he was considering here and that had been done and then on the 17th that was the decision that was going to be presented. Not... r was being presented because those were the words that I was picking up. The real...I almost felt a little hoakey (phonetic) saying it, you know. Real...uh...in the sensitivity of the session, you know...it felt almost like it were a Hitler trip, but I know that it wasn't the case. But it was this real firing burnstone from the pulpit, you know, and he was laying it on the ranks...you guys are really cool and we are going to stay cool. You know. We're the protectors of the father land. And the term father land was there. It was somewhere in the monologue.

#19.5 I only have one other question. Do you know or do you have any idea who this guy really is?

#31 You mean outside of this?

#19.5 Yes.

#31 No. I have not the slightest dammed idea who he is.

#28 Do you have anything you would like to add?

#31 Yes. I would like to sketch the first part of the session.

SG1A

#28 All right. Let's do that now. This is before I told you to focus your attention then on 

SG1A

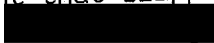
#31 That gave me a little trouble. Reason it gave me a little trouble is, I don't know...how can I tell...the sort of the thought that slipped through my mind, how do I know if I'm in  or not, you know. So I ended up with a building that looked like the front....I mean it was really an ornate brick palace, you know. I called it the palace or a palace. It's like a Washington Memorial type of thing. But, it was functional building.

SG1A

**SECRET**

**SECRET**

It wasn't a memorial. You know. It was something with these big colonnades, you know, everything like that, and I then sort of cruised around again and I saw...I felt like I was on a street...I looked across and there was some sort of a big regular rectangular skyscraper across the street. So that's all I could say. For all I knew, I could have been anywhere. You know. But, it sort of puzzled me at the time. Anyway.

SG1A

#28

So then on page 5 you are going to be drawing your imagery that you had before focusing on [REDACTED]

SG1A

#31

I mean, I know it may not be germain, or anything, but I feel better getting rid of it. In that way I don't have to screw with it again.

I'll just do a quick one here. It doesn't have to have any quality in it, I guess. Again the feeling of these big massive colonnades. A big public building. Then across the street was just a large skyscraper. Ok. That is that.

#28

Ok. Anything else you would like to add?

#31

No. Other than the sketch in 1 and 2...if anybody out there...if anybody out there knows how to get to this guy's office...ha, ha at the end of a long hall...uh...you know...there's this long hall type of a situation....uh...that's all I can say.

**SECRET**

**TAB**

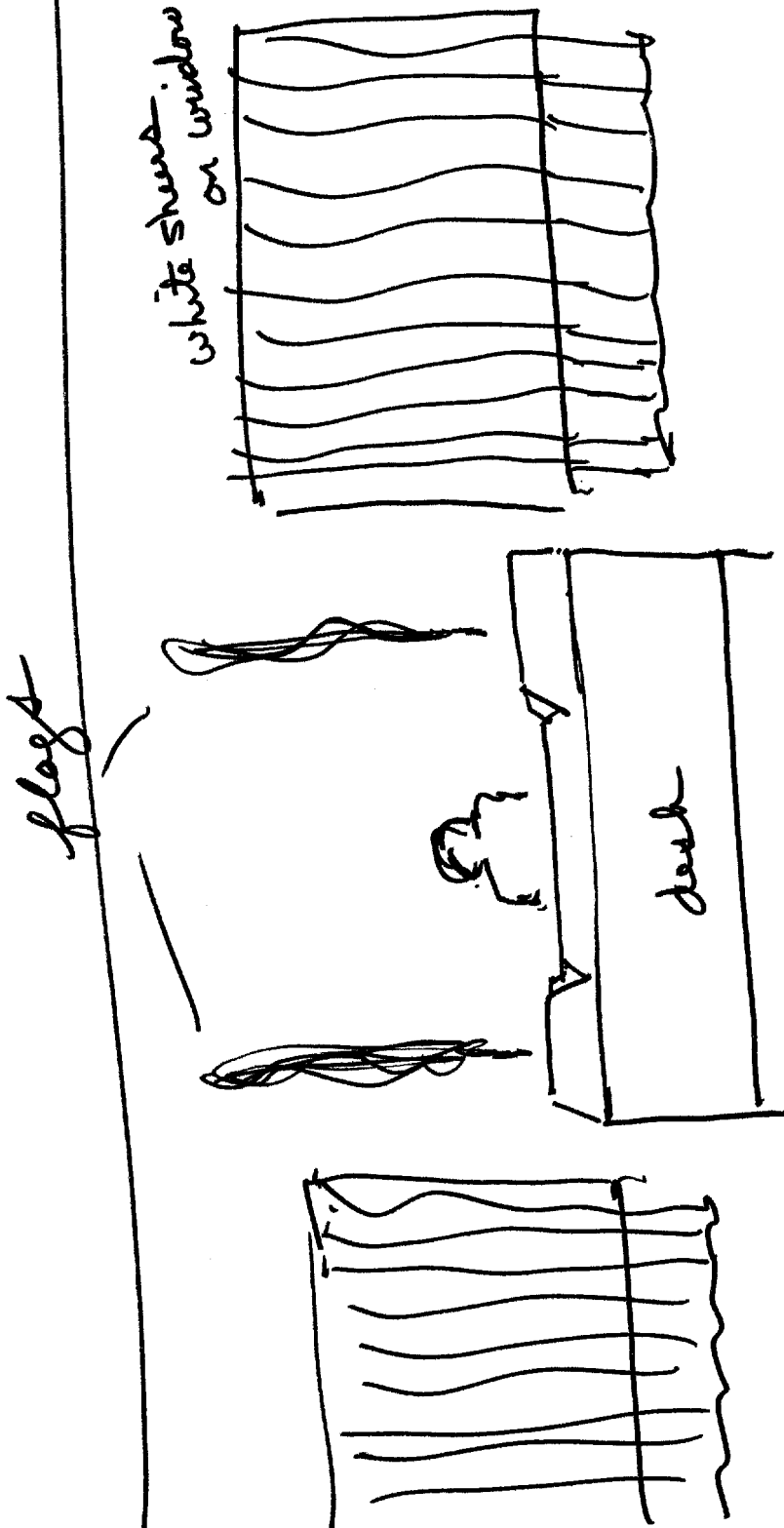



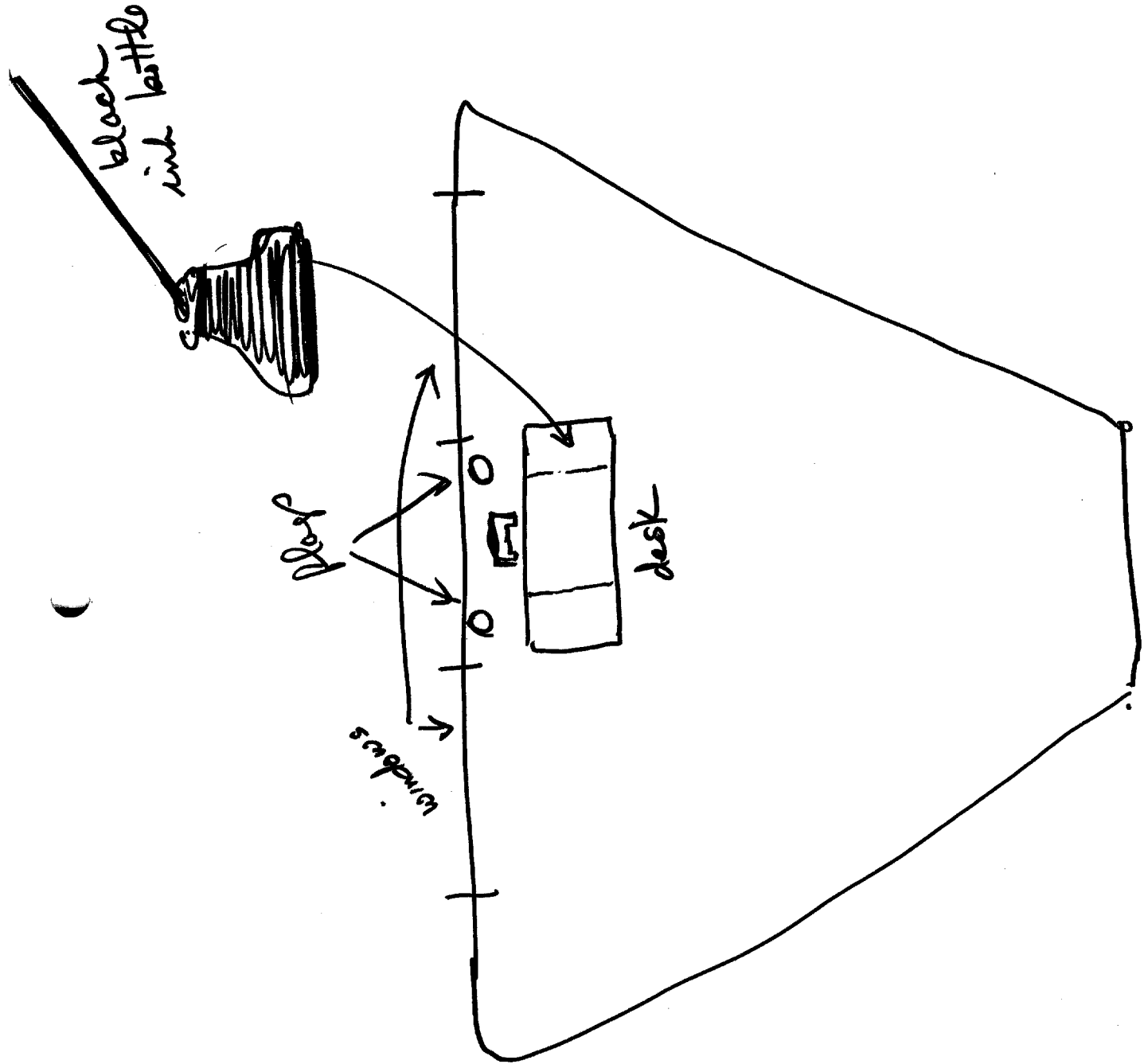

DIET?

Smoking

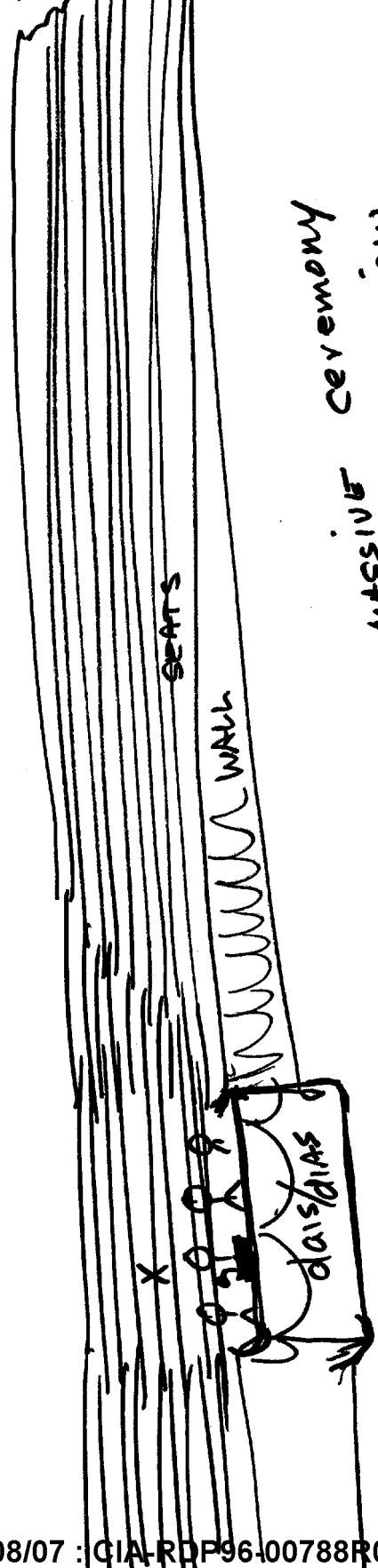

MASSIVE CEREMONY  
PASS in review

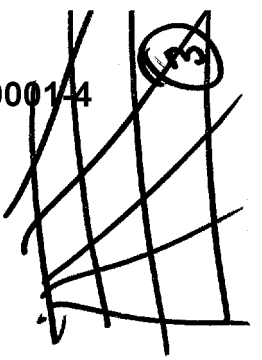



#3 overhead

ROWS OF SEATS

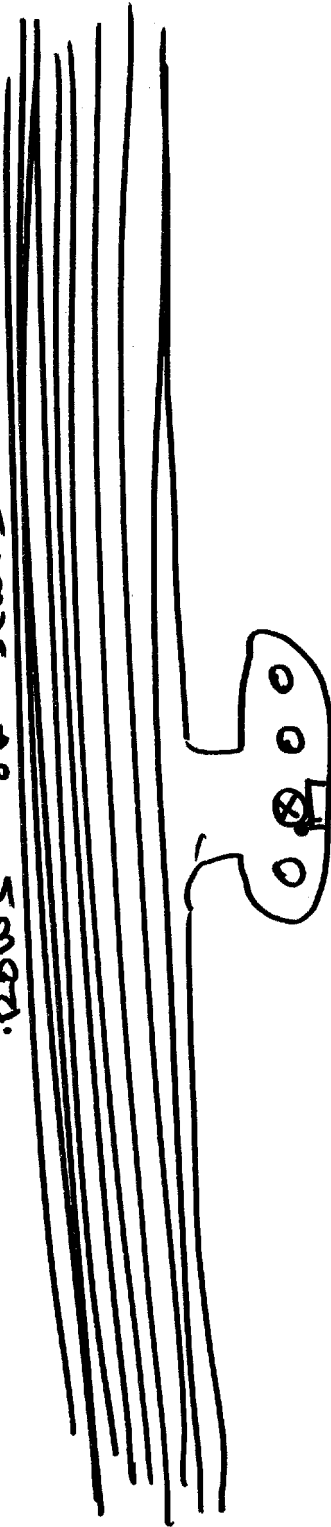

BIG PUBLIC BLDG OR PALACE

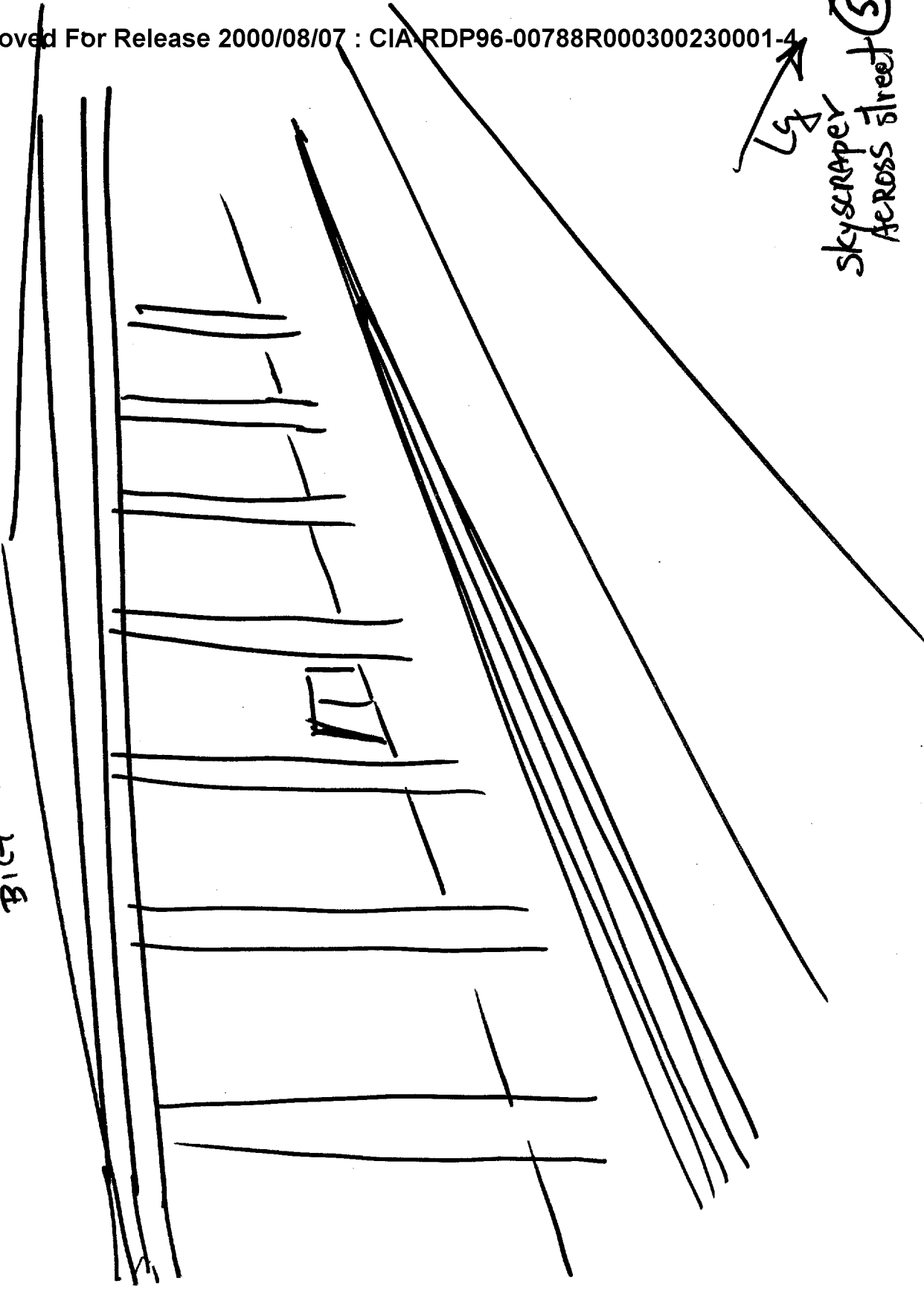

57 →  
skyscraper  
across street 5

**TAB**

**SECRET**

CUING DATA

1. (S) The facilitator and viewer were both provided with a picture of the target subject and his name, grade, country of origin, and probable location. In addition the facilitator was provided with the target times and dates, which were not provided to the viewer until the appropriate portion of the session wherein they were required. The facilitator was also provided with three basic questions to ask (attached), which were designed to circumvent direct cuing towards the required information.
2. (S) Both viewer and facilitator knew prior to the session which analyst would be directing the specific target, but since information concerning country of origin was provided to the viewer as a portion of the targeting information, this should have had no ill affect.
3. (S) No other information was provided to either viewer or facilitator prior to the session.

  
JOSEPH W. McMONEAGLE  
CW2 Analyst

**SECRET**

**SG1A**

**Approved For Release 2000/08/07 : CIA-RDP96-00788R000300230001-4**

**Next 1 Page(s) In Document Exempt**

**Approved For Release 2000/08/07 : CIA-RDP96-00788R000300230001-4**