

APPENDIX 1

Electric Power Production in
Gas-Graphite Reactors

FILE: BLUENOSE FT25FO01 A

PAGE 001

YYMM	ELECTRICAL POWER GENERATED (Mwh)									
	G1	G2	G3	EDF1	EDF2	EDF3	ST1	ST2	Bugey	Vandelos
56 5	1405.	0.	0.	0.	0.	0.	0.	0.	0.	0.
56 6	1405.	0.	0.	0.	0.	0.	0.	0.	0.	0.
56 7	1405.	0.	0.	0.	0.	0.	0.	0.	0.	0.
56 8	1405.	0.	0.	0.	0.	0.	0.	0.	0.	0.
56 9	1405.	0.	0.	0.	0.	0.	0.	0.	0.	0.
56 10	1405.	0.	0.	0.	0.	0.	0.	0.	0.	0.
56 11	1405.	0.	0.	0.	0.	0.	0.	0.	0.	0.
56 12	1405.	0.	0.	0.	0.	0.	0.	0.	0.	0.
57 1	1405.	0.	0.	0.	0.	0.	0.	0.	0.	0.
57 2	1405.	0.	0.	0.	0.	0.	0.	0.	0.	0.
57 3	1405.	0.	0.	0.	0.	0.	0.	0.	0.	0.
57 4	1405.	0.	0.	0.	0.	0.	0.	0.	0.	0.
57 5	1405.	0.	0.	0.	0.	0.	0.	0.	0.	0.
57 6	1405.	0.	0.	0.	0.	0.	0.	0.	0.	0.
57 7	1405.	0.	0.	0.	0.	0.	0.	0.	0.	0.
57 8	1405.	0.	0.	0.	0.	0.	0.	0.	0.	0.
57 9	1405.	0.	0.	0.	0.	0.	0.	0.	0.	0.
57 10	1405.	0.	0.	0.	0.	0.	0.	0.	0.	0.
57 11	1405.	0.	0.	0.	0.	0.	0.	0.	0.	0.
57 12	1405.	0.	0.	0.	0.	0.	0.	0.	0.	0.
58 1	1405.	0.	0.	0.	0.	0.	0.	0.	0.	0.
58 2	1405.	0.	0.	0.	0.	0.	0.	0.	0.	0.
58 3	1405.	0.	0.	0.	0.	0.	0.	0.	0.	0.
58 4	1405.	0.	0.	0.	0.	0.	0.	0.	0.	0.
58 5	1405.	0.	0.	0.	0.	0.	0.	0.	0.	0.
58 6	1405.	0.	0.	0.	0.	0.	0.	0.	0.	0.
58 7	1405.	0.	0.	0.	0.	0.	0.	0.	0.	0.
58 8	1405.	0.	0.	0.	0.	0.	0.	0.	0.	0.
58 9	1405.	0.	0.	0.	0.	0.	0.	0.	0.	0.
58 10	1405.	0.	0.	0.	0.	0.	0.	0.	0.	0.
58 11	1405.	0.	0.	0.	0.	0.	0.	0.	0.	0.
58 12	1405.	0.	0.	0.	0.	0.	0.	0.	0.	0.
59 1	845.	0.	0.	0.	0.	0.	0.	0.	0.	0.
59 2	845.	0.	0.	0.	0.	0.	0.	0.	0.	0.
59 3	845.	0.	0.	0.	0.	0.	0.	0.	0.	0.
59 4	845.	11278.	0.	0.	0.	0.	0.	0.	0.	0.
59 5	845.	11278.	0.	0.	0.	0.	0.	0.	0.	0.
59 6	845.	11278.	0.	0.	0.	0.	0.	0.	0.	0.
59 7	845.	11278.	0.	0.	0.	0.	0.	0.	0.	0.
59 8	845.	11278.	0.	0.	0.	0.	0.	0.	0.	0.
59 9	845.	11278.	0.	0.	0.	0.	0.	0.	0.	0.
59 10	845.	11278.	0.	0.	0.	0.	0.	0.	0.	0.
59 11	845.	11278.	0.	0.	0.	0.	0.	0.	0.	0.
59 12	845.	11278.	0.	0.	0.	0.	0.	0.	0.	0.
60 1	689.	9187.	0.	0.	0.	0.	0.	0.	0.	0.
60 2	689.	9187.	0.	0.	0.	0.	0.	0.	0.	0.
60 3	689.	9187.	0.	0.	0.	0.	0.	0.	0.	0.
60 4	689.	9187.	0.	0.	0.	0.	0.	0.	0.	0.
60 5	689.	9187.	9187.	0.	0.	0.	0.	0.	0.	0.
60 6	689.	9187.	9187.	0.	0.	0.	0.	0.	0.	0.
60 7	689.	9187.	9187.	0.	0.	0.	0.	0.	0.	0.
60 8	689.	9187.	9187.	0.	0.	0.	0.	0.	0.	0.
60 9	689.	9187.	9187.	0.	0.	0.	0.	0.	0.	0.
60 10	689.	9187.	9187.	0.	0.	0.	0.	0.	0.	0.
60 11	689.	9187.	9187.	0.	0.	0.	0.	0.	0.	0.

FILE: BLUENOSE FT25FOO1 A

RUFFING COMPUTER CENTER

PAGE 002

6012	689.	9187.	9187.	0.	0.	0.	0.	0.	0.	0.
61 1	802.	10701.	10701.	0.	0.	0.	0.	0.	0.	0.
61 2	802.	10701.	10701.	0.	0.	0.	0.	0.	0.	0.
61 3	802.	10701.	10701.	0.	0.	0.	0.	0.	0.	0.
61 4	802.	10701.	10701.	0.	0.	0.	0.	0.	0.	0.
61 5	802.	10701.	10701.	0.	0.	0.	0.	0.	0.	0.
61 6	802.	10701.	10701.	0.	0.	0.	0.	0.	0.	0.
61 7	802.	10701.	10701.	0.	0.	0.	0.	0.	0.	0.
61 8	802.	10701.	10701.	0.	0.	0.	0.	0.	0.	0.
61 9	802.	10701.	10701.	0.	0.	0.	0.	0.	0.	0.
6110	802.	10701.	10701.	0.	0.	0.	0.	0.	0.	0.
6111	802.	10701.	10701.	0.	0.	0.	0.	0.	0.	0.
6112	802.	10701.	10701.	0.	0.	0.	0.	0.	0.	0.
62 1	981.	13077.	13077.	0.	0.	0.	0.	0.	0.	0.
62 2	981.	13077.	13077.	0.	0.	0.	0.	0.	0.	0.
62 3	981.	13077.	13077.	0.	0.	0.	0.	0.	0.	0.
62 4	981.	13077.	13077.	0.	0.	0.	0.	0.	0.	0.
62 5	981.	13077.	13077.	0.	0.	0.	0.	0.	0.	0.
62 6	981.	13077.	13077.	0.	0.	0.	0.	0.	0.	0.
62 7	981.	13077.	13077.	0.	0.	0.	0.	0.	0.	0.
62 8	981.	13077.	13077.	0.	0.	0.	0.	0.	0.	0.
62 9	981.	13077.	13077.	0.	0.	0.	0.	0.	0.	0.
6210	981.	13077.	13077.	0.	0.	0.	0.	0.	0.	0.
6211	981.	13077.	13077.	0.	0.	0.	0.	0.	0.	0.
6212	981.	13077.	13077.	0.	0.	0.	0.	0.	0.	0.
63 1	1380.	18402.	18402.	0.	0.	0.	0.	0.	0.	0.
63 2	1380.	18402.	18402.	0.	0.	0.	0.	0.	0.	0.
63 3	1380.	18402.	18402.	0.	0.	0.	0.	0.	0.	0.
63 4	1380.	18402.	18402.	0.	0.	0.	0.	0.	0.	0.
63 5	1380.	18402.	18402.	0.	0.	0.	0.	0.	0.	0.
63 6	1380.	18402.	18402.	0.	0.	0.	0.	0.	0.	0.
63 7	1380.	18402.	18402.	0.	0.	0.	0.	0.	0.	0.
63 8	1380.	18402.	18402.	0.	0.	0.	0.	0.	0.	0.
63 9	1380.	18402.	18402.	0.	0.	0.	0.	0.	0.	0.
6310	1380.	18402.	18402.	0.	0.	0.	0.	0.	0.	0.
6311	1380.	18402.	18402.	0.	0.	0.	0.	0.	0.	0.
6312	1380.	18402.	18402.	7688.	0.	0.	0.	0.	0.	0.
64 1	1469.	19577.	19577.	14011.	0.	0.	0.	0.	0.	0.
64 2	1469.	19577.	19577.	14011.	0.	0.	0.	0.	0.	0.
64 3	1469.	19577.	19577.	14011.	0.	0.	0.	0.	0.	0.
64 4	1469.	19577.	19577.	14011.	0.	0.	0.	0.	0.	0.
64 5	1469.	19577.	19577.	14011.	0.	0.	0.	0.	0.	0.
64 6	1469.	19577.	19577.	14011.	0.	0.	0.	0.	0.	0.
64 7	1469.	19577.	19577.	14011.	0.	0.	0.	0.	0.	0.
64 8	1469.	19577.	19577.	14011.	0.	0.	0.	0.	0.	0.
64 9	1469.	19577.	19577.	14011.	0.	0.	0.	0.	0.	0.
6410	1469.	19577.	19577.	14011.	0.	0.	0.	0.	0.	0.
6411	1469.	19577.	19577.	14011.	0.	0.	0.	0.	0.	0.
6412	1469.	19577.	19577.	14011.	0.	0.	0.	0.	0.	0.
65 1	1114.	25557.	25556.	12500.	25000.	0.	0.	0.	0.	0.
65 2	1114.	25557.	25556.	12500.	25000.	0.	0.	0.	0.	0.
65 3	1114.	25557.	25556.	12500.	25000.	0.	0.	0.	0.	0.
65 4	1114.	25557.	25556.	12500.	25000.	0.	0.	0.	0.	0.
65 5	1114.	25557.	25556.	12500.	25000.	0.	0.	0.	0.	0.
65 6	1114.	25557.	25556.	12500.	25000.	0.	0.	0.	0.	0.

UNCLASSIFIED

FILE: BLUENOSE FT25FO01 A

RUFFING COMPUTER CENTER

PAGE 003

65	7	1114.	25557.	25556.	12500.	25000.	0.	0.	0.	0.	0.
65	8	1114.	25557.	25556.	12500.	25000.	0.	0.	0.	0.	0.
65	9	1114.	25557.	25556.	12500.	25000.	0.	0.	0.	0.	0.
6510	1114.	25557.	25556.	12500.	25000.	0.	0.	0.	0.	0.	0.
6511	1114.	25557.	25556.	12500.	25000.	0.	0.	0.	0.	0.	0.
6512	1114.	25557.	25556.	12500.	25000.	0.	0.	0.	0.	0.	0.
66	1	1183.	21683.	21682.	36500.	49958.	0.	0.	0.	0.	0.
66	2	1183.	21683.	21682.	36500.	49958.	0.	0.	0.	0.	0.
66	3	1183.	21683.	21682.	36500.	49958.	0.	0.	0.	0.	0.
66	4	1183.	21683.	21682.	36500.	49958.	0.	0.	0.	0.	0.
66	5	1183.	21683.	21682.	36500.	49958.	0.	0.	0.	0.	0.
66	6	1183.	21683.	21682.	36500.	49958.	0.	0.	0.	0.	0.
66	7	1183.	21683.	21682.	36500.	49958.	0.	0.	0.	0.	0.
66	8	1183.	21683.	21682.	36500.	49958.	0.	0.	0.	0.	0.
66	9	1183.	21683.	21682.	36500.	49958.	0.	0.	0.	0.	0.
6610	1183.	21683.	21682.	36500.	49958.	0.	0.	0.	0.	0.	0.
6611	1183.	21683.	21682.	36500.	49958.	0.	0.	0.	0.	0.	0.
6612	1183.	21683.	21682.	36500.	49958.	0.	0.	0.	0.	0.	0.
67	1	1332.	25816.	25818.	21483.	112992.	10917.	0.	0.	0.	0.
67	2	1332.	25816.	25818.	21483.	112992.	10917.	0.	0.	0.	0.
67	3	1332.	25816.	25818.	21483.	112992.	10917.	0.	0.	0.	0.
67	4	1332.	25816.	25818.	21483.	112992.	10917.	0.	0.	0.	0.
67	5	1332.	25816.	25818.	21483.	112992.	10917.	0.	0.	0.	0.
67	6	1332.	25816.	25818.	21483.	112992.	10917.	0.	0.	0.	0.
67	7	1332.	25816.	25818.	21483.	112992.	10917.	0.	0.	0.	0.
67	8	1332.	25816.	25818.	21483.	112992.	10917.	0.	0.	0.	0.
67	9	1332.	25816.	25818.	21483.	112992.	10917.	0.	0.	0.	0.
6710	1332.	25816.	25818.	21483.	112992.	10917.	0.	0.	0.	0.	0.
6711	1332.	25816.	25818.	21483.	112992.	10917.	0.	0.	0.	0.	0.
6712	1332.	25816.	25818.	21483.	112992.	10917.	0.	0.	0.	0.	0.
68	1	200.	27937.	27938.	64172.	161520.	108244.	0.	0.	0.	0.
68	2	200.	27937.	27938.	57633.	115680.	47730.	0.	0.	0.	0.
68	3	200.	27937.	27938.	42814.	154097.	80548.	0.	0.	0.	0.
68	4	200.	27937.	27938.	4749.	115441.	161292.	0.	0.	0.	0.
68	5	200.	27937.	27938.	0.	31140.	99012.	0.	0.	0.	0.
68	6	200.	27937.	27938.	0.	0.	60274.	0.	0.	0.	0.
68	7	200.	27937.	27938.	0.	103673.	115879.	0.	0.	0.	0.
68	8	200.	27937.	27938.	0.	119657.	111326.	0.	0.	0.	0.
68	9	200.	27937.	27938.	0.	97053.	127615.	0.	0.	0.	0.
6810	200.	27937.	27938.	25086.	109645.	77610.	0.	0.	0.	0.	0.
6811	-2.	27937.	27938.	57172.	138248.	12227.	0.	0.	0.	0.	0.
6812	0.	27937.	27938.	63254.	165557.	69500.	0.	0.	0.	0.	0.
69	1	0.	31153.	31153.	49443.	165611.	131463.	0.	0.	0.	0.
69	2	0.	26312.	26312.	57936.	150339.	121757.	0.	0.	0.	0.
69	3	0.	19199.	19199.	58502.	156011.	55686.	52144.	0.	0.	0.
69	4	0.	30078.	30077.	22743.	152293.	0.	56603.	0.	0.	0.
69	5	0.	30872.	30871.	42126.	173709.	0.	155723.	0.	0.	0.
69	6	0.	23354.	23354.	57076.	67706.	18498.	209749.	0.	0.	0.
69	7	0.	29361.	29362.	29068.	75840.	78036.	38395.	0.	0.	0.
69	8	0.	29041.	19042.	0.	165094.	106967.	206711.	0.	0.	0.
69	9	0.	28310.	28310.	10115.	165543.	83039.	267326.	0.	0.	0.
6910	0.	31031.	31031.	43512.	178701.	178892.	128621.	0.	0.	0.	0.
6911	0.	20674.	20674.	50124.	151689.	59921.	0.	0.	0.	0.	0.
6912	0.	31114.	31114.	60549.	169868.	67302.	0.	0.	0.	0.	0.
70	1	0.	31374.	31375.	60883.	69071.	78075.	0.	0.	0.	0.

FILE: BLUENOSE FT25FO01 A

RUFFING COMPUTER CENTER

PAGE 004

70 2	0.	28606.	28606.	48738.	153275.	68041.	0.	0.	0.	0.
70 3	0.	31734.	31734.	59924.	155279.	100560.	0.	0.	0.	0.
70 4	0.	17318.	17319.	58353.	4343.	84640.	0.	0.	0.	0.
70 5	0.	29842.	29843.	57704.	153312.	23782.	0.	0.	0.	0.
70 6	0.	28648.	28648.	48067.	163120.	9.	0.	0.	0.	0.
70 7	0.	29574.	29575.	0.	167195.	115560.	0.	0.	0.	0.
70 8	0.	23579.	13580.	28114.	167490.	160616.	0.	0.	0.	0.
70 9	0.	12601.	12601.	57841.	164032.	113815.	0.	0.	0.	0.
7010	0.	16197.	16198.	42025.	171547.	101878.	52552.	0.	0.	0.
7011	0.	29170.	29170.	41569.	169329.	180683.	45777.	0.	0.	0.
7012	0.	30189.	30189.	52992.	171566.	216224.	49102.	0.	0.	0.
71 1	0.	29207.	29208.	33709.	172260.	199716.	105297.	0.	0.	0.
71 2	0.	27258.	27258.	40299.	144803.	156339.	156220.	0.	0.	0.
71 3	0.	28116.	28116.	62278.	62378.	216034.	174965.	0.	0.	0.
71 4	0.	28675.	28675.	58822.	0.	134019.	49183.	0.	0.	0.
71 5	0.	30361.	30362.	230.	0.	134521.	47946.	0.	0.	0.
71 6	0.	29026.	29027.	0.	0.	73.	273242.	0.	0.	0.
71 7	0.	26588.	26588.	0.	0.	87.	237206.	0.	0.	0.
71 8	0.	28322.	28322.	1117.	159697.	194295.	259197.	69781.	0.	0.
71 9	0.	22114.	22115.	2.	169591.	220703.	166420.	192519.	0.	0.
7110	0.	20297.	20298.	22501.	172956.	245318.	168996.	154288.	0.	0.
7111	0.	30076.	30077.	46684.	167860.	230856.	284011.	199117.	0.	0.
7112	0.	30928.	30928.	35153.	175234.	212819.	284980.	333221.	0.	0.
72 1	0.	31147.	31148.	48707.	173199.	136874.	278636.	250013.	0.	0.
72 2	0.	28399.	28400.	50785.	165467.	288543.	186990.	210347.	0.	0.
72 3	0.	30792.	30792.	0.	173137.	249138.	290846.	269162.	0.	0.
72 4	0.	17926.	17926.	0.	169647.	235743.	296064.	275504.	24340.	0.
72 5	0.	24346.	24346.	0.	172363.	256468.	305209.	308411.	88720.	33861.
72 6	0.	29050.	29051.	0.	14396.	252018.	153386.	258754.	78870.	133806.
72 7	0.	29358.	29358.	0.	4.	236329.	51009.	162829.	0.	215927.
72 8	0.	29515.	29515.	0.	49222.	58221.	248576.	1555.	52260.	195610.
72 9	0.	29305.	29305.	27496.	168606.	91075.	256217.	220784.	104480.	186512.
7210	0.	30687.	30688.	62364.	174339.	245282.	274346.	211890.	236370.	0.
7211	0.	29981.	29982.	53944.	163317.	230033.	267455.	321689.	280340.	125534.
7212	0.	31138.	31139.	34464.	172411.	257405.	266684.	389846.	273330.	248435.
73 1	0.	30578.	30578.	32476.	173865.	258642.	277186.	360389.	218500.	231687.
73 2	0.	29948.	29949.	40578.	159309.	227658.	232759.	354756.	283520.	267221.
73 3	0.	30011.	30011.	56476.	11205.	257378.	216455.	353118.	242730.	342060.
73 4	0.	29580.	29581.	29818.	39322.	241622.	181603.	366108.	294280.	283621.
73 5	0.	15330.	15330.	-2.	177982.	32533.	1794.	364333.	297670.	332633.
73 6	0.	25963.	25964.	0.	170063.	0.	1599.	344063.	0.	324129.
73 7	0.	29188.	29189.	0.	97712.	116.	84597.	340651.	0.	312396.
73 8	0.	29085.	29086.	0.	141632.	44.	273574.	109429.	25460.	249631.
73 9	0.	23599.	23599.	0.	165435.	41.	178949.	272712.	264870.	0.
7310	0.	15076.	15076.	0.	176298.	0.	290804.	327015.	290670.	126753.
7311	0.	14680.	14680.	0.	171420.	300.	299854.	365858.	308230.	335848.
7312	0.	15237.	15237.	0.	177911.	91.	307249.	304571.	324020.	312173.
74 1	0.	18593.	18594.	0.	176567.	0.	305633.	361429.	349400.	329211.
74 2	0.	27500.	27501.	0.	152139.	0.	266426.	308200.	322660.	324453.
74 3	0.	27201.	27202.	0.	175563.	0.	288532.	347814.	322050.	274368.
74 4	0.	16879.	16879.	0.	72098.	0.	297629.	351324.	274990.	185016.
74 5	0.	12048.	12049.	0.	0.	0.	37160.	281970.	291650.	343759.
74 6	0.	26953.	26953.	0.	121518.	0.	270691.	172313.	118330.	335110.
74 7	0.	28960.	28961.	0.	171635.	0.	296457.	1459.	0.	332243.
74 8	0.	28377.	18377.	0.	115883.	0.	283417.	1637.	98860.	296854.

UNCLASSIFIED

FILE: BLUENOSE FT25FOO1 A

RUFFING COMPUTER CENTER

PAGE 005

74 9	O.	28384.	28384.	O.	171829.	O.	267017.	151500.	259610.	323444.
74 10	O.	30633.	30634.	O.	177839.	O.	259038.	374051.	377600.	332165.
74 11	O.	29008.	29008.	1.	134235.	O.	254715.	295544.	321790.	325009.
74 12	O.	5067.	5067.	O.	170447.	58351.	311668.	359729.	359820.	369235.
75 1	O.	26274.	26275.	O.	159592.	264839.	317065.	380266.	369860.	360097.
75 2	O.	27181.	27182.	O.	161408.	135241.	288865.	348320.	366130.	290211.
75 3	O.	30691.	30692.	O.	159537.	274863.	319412.	370134.	O.	345911.
75 4	O.	16376.	16376.	O.	164385.	252120.	274413.	337428.	3440.	308814.
75 5	O.	16466.	16467.	O.	135094.	103711.	282571.	371686.	221430.	206385.
75 6	O.	27616.	27616.	O.	156143.	O.	264711.	75325.	215640.	324530.
75 7	O.	27785.	27785.	O.	163880.	53938.	296766.	345524.	203950.	316446.
75 8	O.	28023.	28223.	O.	116718.	235921.	82633.	294806.	371610.	324839.
75 9	O.	21526.	21526.	O.	O.	252399.	185607.	345133.	302990.	301278.
75 10	O.	14766.	14766.	O.	O.	272948.	286863.	276150.	351210.	263158.
75 11	O.	16770.	16771.	O.	100981.	260221.	271982.	332905.	323280.	263986.
75 12	O.	29682.	29682.	O.	139587.	272827.	243164.	407348.	153900.	201265.
76 1	O.	29430.	29430.	O.	153148.	172924.	246425.	333329.	344560.	334769.
76 2	O.	28075.	28076.	O.	141186.	233021.	170445.	378977.	332020.	314360.
76 3	O.	29691.	29692.	O.	151813.	119.	283934.	267406.	318240.	339974.
76 4	O.	28218.	28218.	O.	150692.	O.	260125.	267660.	343520.	209562.
76 5	O.	28325.	28325.	O.	156191.	66716.	299543.	347461.	373400.	333085.
76 6	O.	27360.	27360.	O.	137599.	135218.	230611.	48258.	352780.	330455.
76 7	O.	27121.	27121.	O.	99128.	110669.	139669.	121628.	343880.	362886.
76 8	O.	26996.	26997.	O.	67952.	117911.	2268.	324400.	226410.	315615.
76 9	O.	21147.	21147.	O.	9.	212551.	176554.	321995.	O.	40822.
76 10	O.	14395.	14395.	O.	O.	50762.	289755.	336250.	186560.	257516.
76 11	O.	17706.	17706.	O.	O.	153518.	216878.	325452.	338350.	305439.
76 12	O.	28669.	28670.	O.	O.	282271.	286552.	289499.	339910.	317326.
77 1	O.	29243.	29243.	O.	O.	286980.	223157.	340687.	383280.	197125.
77 2	O.	26392.	26392.	O.	O.	259218.	243420.	315915.	338190.	288427.
77 3	O.	17754.	17755.	O.	O.	281477.	241820.	320847.	361530.	310853.
77 4	O.	13472.	13473.	O.	O.	271497.	232505.	304652.	365810.	271501.
77 5	O.	12830.	12830.	O.	O.	266983.	267003.	322304.	294230.	310016.
77 6	O.	26513.	26513.	O.	72456.	263067.	58340.	234532.	239200.	273081.
77 7	O.	28879.	28879.	O.	140883.	228889.	1651.	283985.	82150.	299837.
77 8	O.	19649.	19649.	O.	131342.	35556.	74472.	137193.	144360.	319134.
77 9	O.	20005.	20006.	O.	148509.	O.	230001.	104761.	335080.	264055.
77 10	O.	28737.	28737.	O.	156074.	125821.	272943.	337681.	368410.	269179.
77 11	O.	28671.	28671.	O.	150843.	272927.	269017.	299485.	351400.	301652.
77 12	O.	26076.	28076.	O.	138279.	28739.	285741.	329524.	300550.	301061.
78 1	O.	22667.	22668.	O.	155519.	278760.	291291.	304116.	355440.	272627.
78 2	O.	17654.	17654.	O.	140553.	268059.	264705.	308210.	349620.	284424.
78 3	O.	14931.	14931.	O.	155781.	269247.	282120.	342163.	374550.	307091.
78 4	O.	4395.	4396.	O.	148587.	272493.	285576.	330127.	290502.	310330.
78 5	O.	8325.	8325.	O.	148618.	46180.	268971.	337556.	87720.	68011.
78 6	O.	19421.	19421.	O.	149024.	O.	262703.	322109.	O.	299858.
78 7	O.	14444.	14444.	O.	153285.	23239.	264952.	6112.	O.	313326.
78 8	O.	14210.	14211.	O.	152333.	243917.	21050.	313310.	89790.	308927.
78 9	O.	13972.	13973.	O.	3713.	216791.	94028.	321474.	353170.	269280.
78 10	O.	28737.	28737.	O.	156074.	125821.	272943.	337681.	368410.	269179.
78 11	O.	13910.	13911.	O.	O.	274076.	285764.	328767.	325520.	304962.
78 12	O.	14821.	14821.	O.	O.	274426.	287451.	318780.	185880.	291489.
79 1	O.	14705.	14706.	O.	O.	285420.	295419.	345099.	388960.	301842.
79 2	O.	16288.	16229.	O.	O.	248117.	276369.	291665.	319860.	284677.
79 3	O.	24382.	24383.	O.	O.	244071.	296178.	335406.	366360.	297027.

UNCL. FIED

FILE: BLUENOSE FT25FO01 A

RUFFING COMPUTER CENTER

PAGE 006

79 4	O.	13967.	13967.	O.	O.	273163.	292444.	313287.	338380.	299747.
79 5	O.	660.	660.	O.	O.	259914.	299554.	388053.	283790.	73385.
79 6	O.	427.	427.	O.	O.	251882.	264180.	323138.	352960.	237536.
79 7	O.	19538.	19539.	O.	O.	222765.	302257.	68232.	380510.	236721.
79 8	O.	25785.	25786.	O.	140166.	75158.	248250.	1156.	287930.	307396.
79 9	O.	22061.	22061.	O.	148980.	O.	276429.	7073.	181410.	301296.
7910	O.	23670.	23671.	O.	154937.	33373.	293811.	164228.	O.	258361.
7911	O.	20811.	20812.	O.	151055.	138980.	287885.	334140.	420.	302102.
7912	O.	22295.	22295.	O.	155731.	142119.	269394.	348006.	222090.	310637.
80 1	O.	24150.	24150.	O.	156038.	149620.	193231.	321696.	343970.	284535.
80 2	O.	13449.	13449.	O.	135838.	239584.	17004.	327770.	327390.	139580.
80 3	O.	14362.	14362.	O.	154551.	256125.	176159.	141770.	375710.	312481.
80 4	O.	13390.	13390.	O.	131086.	272241.	265669.	2153.	378350.	287120.
80 5	O.	12994.	12995.	O.	77139.	275084.	185640.	2173.	376170.	299990.
80 6	O.	13607.	13608.	O.	O.	259176.	264142.	2117.	294170.	302180.
80 7	O.	13975.	13975.	O.	87950.	131198.	234330.	2252.	347100.	307938.
80 8	O.	7637.	7638.	O.	147411.	22.	131182.	O.	368600.	288755.
80 9	O.	O.	O.	O.	149499.	153356.	207040.	1515.	372220.	284708.
8010	O.	O.	O.	O.	138204.	279649.	85986.	1597.	382600.	295643.
8011	O.	O.	O.	O.	119898.	282894.	2081.	1569.	238680.	306022.
8012	O.	11388.	11388.	O.	147772.	285323.	258570.	1497.	306260.	290486.
81 1	O.	-2.	28122.	O.	151941.	280982.	307066.	1662.	372010.	312436.
81 2	O.	O.	24370.	O.	131191.	250605.	251779.	1444.	338490.	256628.
81 3	O.	O.	26123.	O.	151571.	255294.	1592.	1443.	376720.	286363.
81 4	O.	O.	27119.	O.	151369.	201602.	136901.	1560.	372830.	156639.
81 5	O.	O.	23326.	O.	68746.	168402.	263940.	1615.	367570.	175532.
81 6	O.	O.	25180.	O.	O.	223751.	171150.	1793.	312550.	283728.
81 7	O.	O.	27222.	O.	95094.	234476.	218779.	2106.	306600.	265892.
81 8	O.	O.	24652.	O.	144990.	166869.	269936.	2137.	39680.	300215.
81 9	O.	O.	24710.	O.	123105.	O.	246782.	1972.	O.	266845.
8110	O.	O.	28134.	O.	123669.	O.	139979.	1573.	51250.	278932.
8111	O.	O.	27467.	O.	150465.	O.	1323.	1189.	195390.	206639.
8112	O.	O.	27560.	O.	154325.	O.	3370.	2007.	241750.	263488.
82 1	O.	O.	28006.	O.	130895.	O.	241019.	2191.	318460.	278056.
82 2	O.	O.	24088.	O.	139267.	O.	251455.	1886.	243310.	260448.
82 3	O.	O.	9474.	O.	149571.	89705.	304314.	1763.	281520.	257134.
82 4	O.	O.	O.	O.	139060.	328434.	292745.	1774.	349120.	291679.
82 5	O.	O.	O.	O.	153360.	50342.	279773.	2257.	316930.	47658.
82 6	O.	O.	O.	O.	143291.	18.	240776.	2223.	370610.	271764.
82 7	O.	O.	7426.	O.	145902.	19.	208976.	2341.	354920.	294156.
82 8	O.	O.	26130.	O.	87714.	O.	1921.	9642.	352620.	278980.
82 9	O.	O.	22661.	O.	114765.	O.	201595.	102764.	364730.	284664.
8210	O.	O.	20846.	O.	95527.	O.	139646.	30410.	134330.	298919.
8211	O.	O.	15862.	O.	148316.	23372.	136550.	83214.	287130.	294724.
8212	O.	O.	26810.	O.	153838.	246635.	288970.	137347.	67030.	307290.
8301	O.	O.	27210.	O.	72813.	260801.	263411.	118162.	343740.	308972.
8302	O.	O.	24000.	O.	123000.	237000.	186000.	107000.	304000.	276635.
8303	O.	O.	27000.	O.	153000.	262000.	297000.	62000.	351000.	284804.
8304	O.	O.	27000.	O.	150000.	9000.	268000.	2000.	342000.	232342.
8305	O.	O.	27000.	O.	46000.	O.	1000.	1000.	337000.	124375.
8306	O.	O.	26000.	O.	63000.	O.	1000.	1000.	163000.	271155.
8307	O.	O.	27000.	O.	152000.	O.	1000.	60000.	O.	278348.
8308	O.	O.	27000.	O.	152000.	94000.	1000.	158000.	O.	275937.
8309	O.	O.	1000.	O.	151000.	241000.	39000.	11000.	O.	269913.
8310	O.	O.	O.	O.	158000.	135000.	143000.	220000.	O.	262689.

UNCLASSIFIED

FILE: BLUENOSE FT25FO01 A

RUFFING COMPUTER CENTER

PAGE 007

8311	O.	O.	O.	O.	152000.	144707.	150342.	257517.	115110.	269623.
8312	O.	O.	4191.	O.	156813.	130589.	79932.	229530.	319680.	280844.

APPENDIX 2

Gas-Graphite Fuel Fabrication Data

1968

Production of fuel destined for the EDF reactors was limited to about 130 tonnes of uranium, and 80 tonnes for Chinon 1.

1969

This was a year of transition. 330 tonnes were produced for EDF.

In 1970 and 1971, CEA will have to supply Saint-Laurent 2, Bugey and Vandellos; production will be in the order of 800 tonnes a year.

1970

620 tonnes produced for graphite-core reactors, like Chinon 3.

Fuels are currently being produced for Saint-Laurent 2, Vandellos and Bugey.

1971

Initial delivery of fuel (natural uranium) was made to Vandellos; no amount given. Since its inception in 1962, CEA has supplied EDF with more than 3,000 tonnes of fuel for the graphite-gas system.

1972

Total supplies to EDF and Vandellos amounted to only 260 tonnes, as opposed to nearly 600 tonnes in 1971. At the same time, there was a 10% decrease in production for G2 and G3.

1973

Production for EDF and Vandellos--585 tonnes-- was more than double that of 1972 (260 t). On the other hand, production for G2 and G3 decreased by half in relation to 1972.

1974

Production for EDF and Vandellos was about 550 tonnes, 10% lower than for 1973.

1975

Production was 680 tonnes of uranium, approaching the maximum produced in France (717 tonnes in 1970). This was 10% more than in 1974, despite the decline in production for G2 and G3. To this is added the production, always important, of fuels needed for G2 and G3.

1976

Production for EDF and Vandellos was 650 tonnes, to which are added the fuels for G2 and G3.

1977

Production for EDF and Vandellos was 570 tonnes, to which are added fuels for G2 and G3.

1978

376 tonnes for EDF and Vandellos.

1979

491 tonnes for EDF and Vandellos.

1980

471 tonnes for EDF and Vandellos, to which the supplies destined for G3 must be added.

A manufacturing plant for fuels for water reactors is under construction; its planned initial capacity is 500 tonnes/year, to be increased to 1,250 tonnes.

APPENDIX 3

UP2 Reprocessing Data

REPROCESSING OF GRAPHITE/GAS FUELS

UP2 PLANT

From 1966 through 1982, the UP2 facility reprocessed 4112 tonnes of fuel from EDF graphite-gas reactors and the Franco-Spanish Vandellos reactor. Until 1974 the facility operated at less than design capacity because capacity exceeded the amounts of irradiated fuel available for reprocessing. The quantities reprocessed grew with fuel deliveries through 1976 (Table 1). Since then oxide fuel reprocessing activities have limited graphite-gas fuel reprocessing to about 6 months per year. Table 2 shows the types of fuel reprocessed since 1966.

TABLE 1

NUGG Fuel Reprocessing at UP2

Year	Delivered*	Reprocessed*	Stored*
1966	53	52	1
1967	150	98	53
1968	166	187	32
1969	235	228	39
1970	197	136	100
1971	101	164	36
1972	291	250	78
1973	430	213	295
1974	555	635	215
1975	532	441	306
1976	326	218	414
1977	333	351	396
1978	388	372	412
1979	238	264	386
1980	160	253	293
1981	185	251	227

* In tonnes of initial uranium

TABLE 2

Types of Metallic Fuel Reprocessed

Type/Weight	Reactor	Quantity Reprocessed (te)			SiCrAl
		U/Mo 0.5% Mo	U/Mo 1% Mo	MoSnAl	
Tubular 10 kg	EDF-1				
	EDF-2				
	EDF-3	191	1816	126	63
	SL-1				
Tubular Graphite-Core 10 kg	EDF-3				
	SL-1				
	SL-2				725
	Vandellos				
Annular 24 kg	Bugey				1192

TRANSPORT OF IRRADIATED FUEL TO THE LA HAGUE REPROCESSING PLANT

B. Lenail
COGEMA, Velizy Villacoublay Cedex, France

H. W. Curtis
Nuclear Transport Limited, Risley, Warrington, United Kingdom

The story of the transport of irradiated fuel to the La Hague reprocessing plant of COGEMA is a story of massive experience, comparable throughout the world only with that of BNFL's Sellafield plant.

Natural uranium fuel transports

The story began as long ago as 1966 with the transport of natural uranium fuel from French Graphite Gas Reactors. These transports have continued at varying annual rates to the present time in relation to the distribution of fuel between La Hague and the natural uranium reprocessing plant at Marcoule. It is expected that all natural uranium transports will ultimately be directed to Marcoule as oxide fuel reprocessing at La Hague increases. The following Table I shows the annual tonnages transported to La Hague.

TABLE I

Metric tons of natural uranium fuel
from graphite-gas reactors

1966	1967	1968	1969	1970	1971	1972	1973	1974	1975
53	150	166	235	197	101	291	430	555	532
1976	1977	1978	1979	1980	1981	1982			
326	333	388	238	160	185	111			

Total - 4451 metric tons

The flask used is of cubic shape of approximately 2.3m wide and a loaded weight of some 54 metric tons. The shielding consists of lead totally enclosed in stainless steel cladding.

Light water reactor fuel transports

Light water reactor transports to La Hague began in 1973 but remained at a level of about 100 metric tons per year until 1981 when the annual amount transported tripled in comparison with 1980.

In 1982 there was a further increase of 60% over 1981. The tonnages transported are shown in Table II.

TABLE II
Metric tons of light water fuel

1973	1974	1975	1976	1977	1978	1979	1980	1981	1982
10	26	97	60	101	92	112	135	405	647

Total - 1685 metric tons

The transports from 1973 to 1980 were almost entirely from European countries outside France, but in 1979 fuel began to arrive from Japan and in 1981, from the large French domestic programme of PWRs.

Light water reactor fuel is transported to La Hague in a large variety of flasks - dry flasks, wet flasks, small 3t tonne flasks designed for road transports up to 110 te monsters transported by rail. A standard range of flasks has now been defined to facilitate a degree of automatic handling in the UP3A plant and the present hybrid family will not be extended. The 58 tonne road flasks have a capacity of approximately one tonne of uranium in irradiated fuel form (3 PWR or 7 elements), and are lead shielded in a stainless steel casing. The standard flasks are of the following types:

TABLE III
La Hague standard flask types

	<u>Loaded Weight</u>	<u>Capacity</u>	
	te	BWR	PWR
TN 17/2	72	17	6
TN 12/2	102	30	12
TN 15/2	110	-	11

The design consists of a thick walled steel cylinder clad internally with stainless steel and externally with multiple copper fins. Fuel is transported dry in these flasks, of which over 50 are now in operation.

The wet flasks weigh 70 tonnes and have a capacity of 17 BWR or 7 PWR elements. A lead liner is enclosed in a thick walled steel cylinder with external circumferential steel fins. The flasks are water filled.

The philosophy of the new flask unloading facilities in the UP3A plant includes two original concepts: unloading in a dry cell in contrast to a pond, and automatic handling. The hybrid family of flasks described above are unsuitable for the new plant but will

continue to be handled in the NPH. Whilst full standardization is desirable, there are many older reactors to be served which, because of dimensional or weight limitations, can not handle the larger standardized flasks.

Fast reactor fuel transports

Irradiated fuel from the Phenix fast reactor has been transported to La Hague since 1975 at a rate of about 1 metric ton of uranium plus plutonium per year. The cylindrical flask weighs 18 metric tons and is lead shielded with external neutron shielding by an annulus of water. Removable fins of copper and stainless steel are fitted in four sections. The capacity of the flask is the equivalent of two dismantled fuel assemblies.

Transport methods to La Hague

Transports to La Hague are effected by road, rail or sea. Road transports for the complete journey are used only for light flasks of the NTL 8 or NTL 9 type which weigh 38 metric tons and are provided with their own semi-trailers. The use of this type of transport is now limited to four reactors in Belgium, Holland, Switzerland and France where dimensional or geographical considerations give the light flasks an advantage. The annual number of road transports to La Hague have been as follows:

TABLE IV

Road transports to La Hague

1973	1974	1975	1976	1977	1978	1979	1980	1981	1982
9	21	90	45	70	54	56	57	74	90

The normal annual number of road transports has now reached equilibrium around 55, but 1981 and 1982 saw an unusual increase due to the removal of fuel from the Gundremmingen 1 reactor, which has been permanently removed from service.

Transports by sea to La Hague are performed from Japan by Pacific Nuclear Transport Limited and from Sweden by SOFRASAM. Special double-hulled ships discharge the flasks in the port of Cherbourg onto rail wagons which are transported 20 km to the rail terminal at Valognes. From Valognes they are handled like all other rail transports to La Hague. The numbers of sea transports to La Hague are as shown in Table V.

TABLE V

Sea transports to La Hague

	1979	1980	1981	1982
Flasks	13	14	36	20
Te U	29	32	99	106

The basic method of transport to La Hague is by rail, since most of the flasks weigh from 80 to 110 metric tons. A special 8 axle rail wagon has been developed for this traffic which is authorised for normal rail freight speeds. The irradiated fuel flask wagons form part of normal freight trains. The trains arrive at the Valognes terminal where they are transferred from the rail wagons to a special road vehicle. The flasks then travel the final 40 km between the Valognes terminal and La Hague along quiet country roads. The La Hague site has no connection to the railway system and the terrain would make such connection difficult and costly. The Valognes terminal has therefore been established to provide a marshalling yard capable of handling many wagons simultaneously, with two travelling bridge cranes of 130 metric tons capacity. The terminal also includes facilities for maintenance of the road and rail vehicles. The annual numbers of rail transports to La Hague are shown in Table VI.

TABLE VI

Rail transports to La Hague

1966	1967	1968	1969	1970	1971	1972	1973	1974	1975
27	75	83	117	98	50	145	215	282	266
1976	1977	1978	1979	1980	1981	1982			
166	177	209	130	99	157	180			

The peaks in 1974 and 1975 correspond to the peaks in the transport of natural uranium. Whilst transports of graphite-gas elements have declined steadily since 1974, transports of light water reactor elements by rail have steadily increased and will continue to do so.

Flask handling at La Hague

All flasks arrive at La Hague by road and are delivered to a trolley loading plant known as AML. Here the flasks are transferred to site trolleys which are used for storage on a large open-air trolley handling unit with a capacity of 45 flasks. The AML is connected to the new pond facility (NPH) which has a storage capacity

corresponding to 2,000 metric tons of uranium, and also to the HAO plant. The average flask handling capacity of NPH is 350 flasks per year working through two separate unloading lines. In NPH, the flask is lowered into the pond and fuel elements are extracted under water. The future UP3A will include a unit which extracts the elements dry from the flasks and transfers them to individual pits prior to underwater storage in the pond.

Fuel elements are stored bare but rigorous tests are carried out to ensure that failed fuel is segregated at the reactor and transported only under special conditions of encapsulation. At the reactor site, procedures exist to identify failed elements by activity measurement in an enclosed environment with a known temperature increase. Where this procedure is not yet in use, tests are made by means of fuel sipping before transport, or sampling of the flask water after loading for wet flasks, or gas sampling in the case of dry flasks. Failure to meet the criteria involves rejection of the fuel at the reactor site.

Transport organisation

With the exception of the sea transports referred to above, all transports to La Hague are performed by COGEMA, for French domestic transports and Nuclear Transport Limited (NTL) for the rest of Europe. NTL is an international organization with branches in England, France and Germany. The management of transport operations from Germany, Belgium, Holland and Switzerland to La Hague is centralized in the Paris office. Most non-French transports originate from Germany where NTL has a base at Hanau. NTL's services commence at the reactor site, where technicians attend to provide advice to the reactor operator, to verify that the fuel elements comply with the COGEMA acceptance criteria, to check the fuel element identification numbers and to accept the flask for transport after it has passed controls on leak-tightness, radiation and contamination. Transport is then organized by the appropriate NTL branch acting in concert with their colleagues who will take over responsibility at an agreed hand-over point.

NTL acts as the sub-contractor of the reprocessor and forms the bridge between the reactor and the reprocessing plant. Statistics such as metric tons transported or number of flask movements sometimes fail to present an adequate picture of the magnitude of the activity. The number of light water reactor irradiated fuel elements transported by NTL is now in excess of 5,000 - the equivalent of more than 30 full reactor cores.

MINISTRY OF RESEARCH AND INDUSTRY
FRANCE

HIGHER COUNCIL FOR NUCLEAR SAFETY

APPENDICES TO THE REPORT
OF
THE WORKING GROUP
ON
THE MANAGEMENT OF IRRADIATED FUELS

DECEMBER 1981 - NOVEMBER 1982

DECEMBER 1981 - NOVEMBER 1982

TABLE VIII: OPERATING PARAMETERS OF LA HAGUE

Année (1)	Tonnage retraité (2)		Taux moyen de combustion (5) MWd/t		Dose collective homme/remes (6)	Temps d'arrêts (mois) (7)
	UNGG (3)	LWREP (4)	UNGG (3)	LWREP (4)		
1969	157,4	-	986	-	222,8	10
1970	244,7	-	1 079	-	372,4	9
1971	126,3	-	2 287	-	362,1	8,5
1972	250,4	-	2 164	-	344,2	5
1973	212,9	-	2 385	-	507,4	8
1974	634,5	-	2 331	-	543,5	4
1975	442,7	-	3 038	-	714,4	4,5
1976	217,8	14,62	2 783	15 803	700,8	5
1977	354,7	19,02	2 947	28 077	673,1	4
1978	371,4	38,22	3 345	27 271	633,8	3
1979	240	79,41	3 590	20 375	561,9	3
1980	252	104,86	3 317	20 980	643,2	3

* Data of La Hague radiation protection department [probably applies only to 1981 -- cut off in original -- translator].

Key: 1. Year
 2. Tonnage reprocessed
 3. GGR
 4. Light-water PWR
 5. Mean burnup, MWd/t
 6. Collective dose, man-remes
 7. Stoppage periods, months

Table n° 1 - REPROCESSING AT LA HAGUE

- Tonnage Reprocessed and Dose Indicators -

Year	Tonnage Reprocessed (tonnes)		Average Burn-up (MW days/tonne)		Collective Dose (man-rem)	Dose/Power Ratio (rem/MWe yr)
	"metal"	"oxide"	"metal"	"oxide"		
1968	189	-	1 170	-	223,3	1,106
1969	158	-	990	-	222,8	1,560
1970	245	-	1 080	-	372,4	1,541
1971	126	-	2 290	-	362,1	1,374
1972	250	-	2 160	-	344,2	0,699
1973	213	-	2 390	-	507,4	1,091
1974	635	-	2 330	-	543,5	0,402
1975	443	-	3 038	-	714,4	0,581
1976	218	14,6	2 783	15 800	700,8	0,916
1977	351	17,3	2 947	26 060	673,1	0,465
1978	372	38,2	3 345	27 270	633,8	0,304
1979	240	79,4	3 590	20 375	561,9	0,248
1980	252	104,9	3 317	20 980	643,2	0,222
1981	250	101,3	3 672	25 420	727,5	0,228
1982	226	153,5	3 720	21 095	602,8	0,162
1983	117	221,3	3 727	23 230	590,7	0,116
1968-1983	4 285	730,5			8 424	0,373

Sources : /ZER79/, /CAS2/ (1969 to 1981)

Z.C. 1983

SECRET
[]

25X1

French Reprocessing Activities

This is a complete list of all the data provided to us by LLNL on oxide fuel reprocessing activities at Cap de la Hague. The column headings have the following meanings:

NUM-ASBL number of fuel assemblies reprocessed

KGU-TOTAL mass of uranium in spent fuel in kilograms

I% U235 weight percent uranium-235 before assemblies inserted into reactor

INSRT DATE month/year assemblies inserted into reactor

DISCH DATE month/year assemblies removed from reactor

BURNUP total irradiation received by assemblies

D%-U235 weight percent uranium 235 in discharged fuel

KG Pu-TOTAL mass of plutonium in spent fuel in kilograms

A blank spot in a column indicates that LLNL does not have data for that parameter.

[]

25X1

25X1

SECRET
[]

25X1

SECRET

25X1

LWR FUEL REPROCESSED AT LA HAGUE
FIRST CAMPAIGN
APRIL - JUNE 1976

NUM- ASBL	KGU- TOTAL	I% U235	INSRT DATE	DISCH DATE	BURNUP MWD/TE	D% U235	KG Pu- TOTAL
MUEHLEBERG (SWITZERLAND)							
1	196	2.39	3/71	1/74	8400	1.62	0.7
12	2346	2.39	3/71	8/74	13000	1.30	12.3
63	12080	2.39	3/71	8/74	14200	1.24	67.7

SECRET

25X1

SECRET

25X1

LWR FUEL REPROCESSED AT LA HAGUE
SECOND CAMPAIGN
NOVEMBER 1977 - MARCH 1978

NUM- ASBL	KGU- TOTAL	I% U235	INSRT DATE	DISCH DATE	BURNUP MWD/TE	D% U235	KG Pu- TOTAL
STADE							
3	1056	2.38	1/72	7/73	15790	1.12	6.4
1	352	3.19	1/72	7/73	18136	1.64	2.3
33	11616	3.38	1/72	6/74	23196	0.78	97.3
16	5632	2.53	1/72	6/74	23726	0.83	47.3
1	352	3.19	1/72	6/74	26427	1.16	2.9
18	6336	2.53	1/72	5/75	27993	0.67	53.7
32	11264	3.19	1/72	5/75	31051	0.94	100.0
4	1408	2.38	1/72	7/73			
			7/74	5/75	21839	0.83	11.8
5	1760	2.18	1/72	7/73			
			6/75	4/76	23000	0.68	14.6
2	704	2.53	1/72	7/73			
			6/75	4/76	25000	0.78	5.6
3	1056	3.19	1/72	7/73			
			6/75	4/76	26237	1.17	8.6
2	704	2.53	9/73	4/76	25000	0.78	5.6
42	14868	3.18	9/73	4/76	31500	0.92	132.8

SECRET

25X1

SECRET

25X1

LWR FUEL REPROCESSED AT LA HAGUE
THIRD CAMPAIGN
DECEMBER 1978 - APRIL 1979

NUM- ASBL	KGU- TOTAL	I% U235	INSRT DATE	DISCH DATE	BURNUP MWD/TE	D% U235	KG Pu- TOTAL
BORSSELE							
30	9420	2.5	6/73	1/75	15000	1.26	47.3
8	2512	2.80	6/73	1/75	16160	1.44	14.9
32	10048	2.80	6/73	2/76	25600	0.93	81.1
5	1570	2.50	6/73	2/76	22900	0.86	13.2
27	8208	3.10	6/73	1/77	30800	0.90	72.5
GUNDREMMINGEN-A							
9	1140	2.20	8/66	7/69			
			7/70	5/73	12214	1.20	5.9
5	621	2.24	7/70	5/73	15597	1.02	3.8
9	1156	2.40	7/70	5/73	15597	1.10	7.1
1	128	2.42	8/69	6/71			
			7/72	5/73	15735	1.13	0.8
1	127	2.20	8/66	5/74	21459	0.73	0.9
1	127	2.20	8/66	7/67	21244	0.74	0.9
23	2939	2.42	8/69	5/74	20271	0.89	20.9
15	1863	2.42	8/69	5/74	20283	0.89	13.3
10	1267	2.20	8/66	7/69	12956	1.16	6.8
16	1987	2.24	7/70	5/74	18160	0.91	13.3

SECRET

25X1

SECRET

25X1

LWR FUEL REPROCESSED AT LA HAGUE
FOURTH CAMPAIGN
DECEMBER 1979 - JUNE 1980

NUM- ASBL	KGU- TOTAL	I&- U235	INSRT DATE	DISCH DATE	BURNUP MWD/TE	D&- U235	KG Pu- TOTAL
MUEHLEBERG							
4	733	2.39	3/71	8/73	5600	1.82	2.2
21	4027	2.39	3/71	8/74	14200	1.24	22.6
2	391	2.39	3/71	10/74	24541	0.73	3.1
6	1165	2.39	3/71	8/74			
			10/74	8/75	19034	0.97	1.3
42	8195	2.39	3/71	8/75	19034	0.97	55.8
70	13459	2.39	3/71	5/76	17875	1.02	88.1
4	782	2.39	3/71	8/74			
			9/75	5/76	17875	1.02	5.1
2	384	2.39	3/71	1/74			
			9/74	5/76	19034	0.97	2.6
WURGASSEN							
91	17745	2.20	10/71	9/76	13581	1.11	99.1
2	390	2.20	10/71	8/77	17590	0.91	2.5
GUNDRERMINGEN-A							
12	1490	2.24	7/70	5/74	18160	0.91	10.0
1	124	2.42	8/69	5/70	14723	1.23	0.7
3	373	2.42	7/71	5/74	16530	1.10	2.3
2	253	2.20	7/72	5/74	23266	0.67	2.0
1	128	2.42	8/69	6/71			
			7/72	5/74	18529	1.01	0.8
1	124	2.42	8/69	6/71			
			7/72	5/74	18541	1.01	0.8
1	128	2.42	8/69	4/72			
			6/73	5/74	19108	0.99	0.9
1	124	2.42	8/69	4/72			
			6/73	5/74	19120	0.99	0.8
1	128	2.42	8/69	5/75	21269	0.86	0.9
13	1615	2.24	7/70	5/75	19530	0.85	11.3
1	128	2.42	8/69	5/70			
			7/71	5/75	20137	0.89	0.9
2	257	2.40	7/71	5/75	18562	1.00	1.7
44	5465	2.42	7/71	5/75	18624	1.01	36.6
3	383	2.42	8/69	6/71			
			7/72	5/75	20018	0.90	2.7
6	745	2.24	7/70	6/71			
			7/72	5/75	17810	0.92	4.9
6	745	2.42	7/72	5/75	15992	1.12	4.5
10	1242	2.40	7/72	5/75	15952	1.11	7.6
1	124	2.42	7/70	4/72			
			6/73	5/75	26547	0.64	1.0

SECRET

25X1

LWR FUEL REPROCESSED AT LA HAGUE
FOURTH CAMPAIGN
DECEMBER 1979 - JUNE 1980

NUM- ASBL	KGU- TOTAL	I% U235	INSRT DATE	DISCH DATE	BURNUP MWD/TE	D% U235	KG Pu- TOTAL
GUNDREMMINGEN-A (cont)							
2	248	2.24	7/70	4/72			
			6/73	5/75	18376	0.90	1.7
2	257	2.40	7/70	4/72			
			6/73	5/75	18973	0.98	1.7
4	514	2.40	7/70	5/73			
			6/74	5/75	18287	1.01	3.4
1	124	2.42	7/71	5/73			
			6/74	5/75	15833	1.13	0.8
10	1242	2.42	7/71	5/76	20104	0.89	8.8
6	745	2.42	7/72	5/76	18263	1.02	4.9
33	4099	2.40	7/72	5/76	18217	1.02	27.1
8	994	2.41	6/73	5/76	16329	1.11	6.1
14	1739	2.42	6/73	5/76	16367	1.10	10.7
1	128	2.40	7/70	5/73			
			6/74	5/76	19819	0.94	0.9
4	514	2.40	7/71	5/73			
			6/74	5/76	18064	1.02	3.4
4	516	2.40	7/71	1/77	21122	0.85	3.7
OBRIGHEIM							
27	7837	3.10	9/68	8/71			
			10/72	9/73	30308	0.92	68.7
3	831	3.10	9/70	9/73	30909	0.89	7.4
1	255	2.85	9/70	9/73	31172	0.73	2.3
1	291	2.50	9/68	8/70			
			9/71	9/72	24495	0.70	2.4
2	554	3.10	9/70	9/72			
			9/73	8/74	27696	1.04	4.6
1	291	2.80	9/68	8/71	24527	0.98	2.3
27	7856	2.50	9/68	8/70			
			9/71	9/72	24495	0.78	63.7
4	1161	3.10	9/68	9/72	29754	0.93	9.0
1	291	3.00	9/70	9/72	18053	1.48	1.9
1	290	3.10	9/68	9/73	37480	0.64	2.8

SECRET

25X1

SECRET

25X1

LWR FUEL REPROCESSED AT LA HAGUE
FOURTH CAMPAIGN
DECEMBER 1979 - JUNE 1980

NUM- ASBL	KGU- TOTAL	I% U235	INSRT DATE	DISCH DATE	BURNUP MWD/TE	D% U235	KG Pu- TOTAL
DOEL-1							
35	9240	2.01	7/74	2/76	13522	0.95	49.9
DOEL-2							
35	9272	1.99	8/75	11/76	13716	0.98	51.0
TIHANGE-1							
39	17745	1.95	4/75	9/76	15562	0.82	108.3
STADE							
32	11264	2.18	1/72	7/73	15305	1.00	66.1
2	704	2.53	1/72	7/73	16177	1.22	4.4
1	354	3.18	9/73	4/76	31500	0.92	3.2
11	3894	3.18	7/74	4/76	21739	1.41	28.3
1	352	3.19	1/72	5/75			
			5/76	4/77	35631	0.76	3.3

SECRET

25X1

LWR FUEL REPROCESSED AT LA HAGUE
FIFTH CAMPAIGN
FEBRUARY - JULY 1981

NUM- ASBL	KGU- TOTAL	I% U235	INSRT DATE	DISCH DATE	BURNUP MWD/TE	D% U235	KG Pu- TOTAL
SENA-CHOOZE							
22	6900	2.96	10/66	6/73	25800	1.02	58.0
28	8800	3.76	10/66	6/73	23200	1.58	66.4
BORSSELE							
1	300	2.50	6/73	1/77	22100	0.89	2.7
5	1600	2.50	6/73	11/77	22500	0.89	12.6
9	2800	2.80	6/73	2/76	25600	0.93	22.8
1	300	3.10	6/73	2/76	26300	1.11	2.5
12	3600	3.10	6/73	1/77	30800	0.90	32.2
1	300	3.3	4/75	2/76	12900	2.10	1.6
4	1300	3.30	4/75	1/77	21000	1.54	8.9
4	1300	2.95	4/75	11/77	33400	0.73	11.8
4	1200	3.10	4/75	11/77	29500	0.93	11.1
10	3100	3.30	4/75	11/77	30000	1.02	29.5
OBRIGHEIM							
1	300	2.50	9/68	8/74	26500	0.70	2.4
6	1700	3.10	9/68	8/74	27500	1.04	14.5
1	300	2.85	9/70	9/73	31200	0.73	2.3
19	5300	3.10	9/70	8/74	27700	1.04	44.0
3	800	3.10	9/70	9/73	30900	0.89	7.4
16	4400	3.10	9/71	6/75	24300	1.20	34.2
2	600	3.10	10/72	6/75	27900	1.03	4.6
STADE							
5	1800	2.18	1/72	4/76	23000	0.68	14.6
2	700	2.53	1/72	4/76	25000	0.78	5.6
1	400	3.19	9/73	4/77	34200	0.81	3.3
4	1400	3.18	9/73	4/77	34100	0.81	13.2
1	400	3.18	9/73	4/77	30600	0.96	3.1
1	400	3.18	9/73	4/77	24500	1.25	2.8
20	7100	3.18	14/74	4/77	29400	1.01	61.2
6	2100	3.18	7/74	4/78	33200	0.85	19.5
4	1400	3.18	7/74	4/78	28200	1.06	12.0
7	2500	3.18	6/75	4/78	29300	1.01	21.4
1	400	3.18	6/75	4/77	24200	1.26	2.7
NECKARWESTHEIM							
44	15700	1.90	5/76	7/77	12800	0.89	89.0
5	1800	1.90	5/76	8/78	20800	0.60	14.4
31	11000	2.50	5/76	8/78	24000	0.81	90.4

SECRET

LWR FUEL REPROCESSED AT LA HAGUE
SIXTH CAMPAIGN
7 DECEMBER - 30 JUNE 1982

NUM- ASBL	KGU- TOTAL	I&- U ²³⁵	INSRT DATE	DISCH DATE	BURNUP MWD/TE	D&- U ²³⁵	KG Pu- TOTAL
DOEL-1							
2	500	2.05	7/74	2/76	13500	0.95	2.9
32	8500	2.85	7/74	2/77	25500	0.96	68.1
DOEL-2							
2	500	3.42	8/75	11/76	11200	2.39	2.5
6	1600	1.99	8/75	10/77	21200	0.65	11.7
22	5800	2.84	8/75	10/77	24100	0.96	46.3
2	500	2.85	8/75	10/77	24400	0.95	4.3
3	800	2.01	2/77	10/77	20900	0.68	2.0
TIHANGE-1							
4	1800	3.10	2/75	9/76	19200	1.50	12.5
3	1400	1.95	2/75	9/76	15600	0.82	8.3
2	900	2.55	2/75	7/76	17400	1.17	6.3
4	1800	1.95	2/75	1/78	24200	0.52	9.8
21	9600	2.55	2/75	1/78	26200	0.76	57.1
TAKAHAMA-1							
44	20200	2.00	3/74	11/75	15600	0.87	124.0
BORSSELE							
8	2500	3.3	4/75	11/77	30000	1.02	23.6
2	600	3.30	4/75	2/76			
			2/77	10/78	30500	1.02	5.4
28	8800	3.30	4/76	10/78	30500	1.02	72.2
9	2800	3.30	2/77	10/78	22500	1.40	20.6
FESSENHEIM							
25	11500	2.10	3/77	3/79	15100	0.96	72.0

SECRET

25X1

SECRET

25X1

LWR FUEL REPROCESSED AT LA HAGUE
SIXTH CAMPAIGN
7 DECEMBER - 30 JUNE 1982

NUM- ASBL	KGU- TOTAL	I% U235	INSRT DATE	DISCH DATE	BURNUP MWD/TE	D% U235	KG Pu- TOTAL
MUEHLEBERG							
1	200	2.39	10/73	5/76	17900	1.03	1.3
8	1600	2.30	9/74	8/77	19400	0.91	10.4
68	12500	2.47	9/74	8/77	21300	0.95	90.1
4	800	2.30	9/74	8/78	20000	0.88	5.2
4	700	2.47	9/74	10/74			
				8/78	22600	0.84	5.2
36	6600	2.47	9/74	8/78	25600	0.76	52.4
16	2900	2.74	9/75	8/78	23900	1.03	22.8
WUERGASSEN							
1	200	2.20	10/71	9/76	13600	1.11	1.1
104	20300	2.20	10/71	8/77	17600	0.91	132.0
23	4500	2.20	10/71	3/79	21200	0.76	32.2
GUNDREMMINGEN-A							
4	500	2.42	7/71	1/77	21300	0.85	3.7
2	200	2.42	7/72	1/77	19900	0.85	1.8
24	2900	2.41	7/72	1/77	19900	0.94	21.3
1	100	2.42	7/71	4/72			
			6/73	1/77	20100	0.89	0.9
4	500	2.41	6/73	1/77	18000	1.03	3.3
OBRIGHEIM							
102	28700				29000		260.0

SECRET

25X1

LWR FUEL REPROCESSED AT LA HAGUE
SEVENTH CAMPAIGN
1 MARCH 1983 - 30 JUNE 1983

NUM- ASBL	KGU- TOTAL	I%- U235	INSRT DATE	DISCH DATE	BURNUP MWD/TE	D%- U235	KG Pu- TOTAL
TINANGE-1							
1	460	1.95	02/75	01/78	24200.	0.52	2.4
9	4120	2.55	02/75	01/78	25628.	0.78	33.8
6	2740	2.55	02/75	01/79	34500.	0.47	26.3
3	1370	3.20	02/75	01/78	28535.	1.07	11.8
9	4120	3.10	02/75	01/79	33700.	0.79	38.6
1	460	3.20	03/78	01/79	11700.	2.11	2.21
STADE							
7	2450	3.18	07/74	03/79	31000.	0.95	22.3
18	6290	3.18	06/75	03/78	30340.*	0.97	56.6
5	1750	3.18	06/75	03/97	33500.	0.84	16.6
4	1400	3.18	06/75	03/79	31000.	0.95	12.7
16	5600	3.18	05/76	03/79	32700.	0.88	52.5
BORSSELE							
1	310	3.30	04/76	10/78	30500.*	1.02	2.7
3	940	3.30	04/76	10/78	30500.*	1.02	8.1
28	8790	3.30	02/77	10/79	31600.*	0.99	79.6
12	3770	3.30	12/77	10/79	24200.	1.37	28.2
GUNDREMMINGEN-A							
4	480	2.40	07/72	01/77	15734.*	1.12	3.0
34	4120	2.40	06/75	01/77	10013.*	1.47	17.5
31	3760	2.41	06/75	01/77	10032.*	1.48	16.0
27	3270	2.41	10/76	01/77	3021.*	2.08	5.2
ISAR-1 (KKI)							
204	37830	1.94	11/77	04/80	12925.	0.95	207.8

SECRET

25X1

SECRET

25X1

LWR FUEL REPROCESSED AT LA HAGUE
SEVENTH CAMPAIGN
1 MARCH 1983 - 30 JUNE 1983

NUM- ASBL	KGU- TOTAL	I&- U235	INSRT DATE	DISCH DATE	BURNUP MWD/TE	D&- U235	KG Pu- TOTAL
BEZNAU 1							
10	3300	3.20	7/75	6/78	27,400	1.03	29.30
1	300	3.21	7/74	5/77			
			6/78	6/79	29,000	1.08	3.1
4	1300	3.04	7/76	6/79	24,800	1.15	11.4
8	2600	3.20	7/75	6/79	34,200	0.88	24.6
8	2600	3.21	7/75	6/79	35,000	0.81	25.1
4	1300	3.21	7/74	5/76			
			7/77	6/79	33,200	0.88	12.2
BEZNAU 2 (Switzerland)							
2	700	3.21	9/73	7/75	19,200	1.61	4.7
1	300	2.50	10/71	7/73			
			8/74	7/76	20,800	0.96	2.8
16	5300	2.78	10/71	7/74			
			8/75	7/76	24,100	1.02	45.1
12	4000	3.51	10/71	7/75	29,200	1.26	36.1
25	8300	3.22	9/73	7/76	24,600	1.30	84.5
11	3600	2.78	10/71	7/75	26,000	0.93	31.7
TAKAHAMA 1/2							
	21000				16,000		130
BUGEY 2							
16	7300	2.10	4/78	4/80	14,400	1.01	40.
NECKARWESTHEIM-1 (FRG)							
1	370	1.90	05/76	07/79	21183.	0.59	2.9
8	2950	2.50	05/76	08/78	24000.	0.81	24.3
7	2580	2.50	05/76	08/80	30000.	0.59	22.3
4	1480	3.20	05/76	08/80	29500.	1.03	12.6
49	18080	3.20	05/76	07/79	32418.	0.90	160.8
1	370	3.20	05/76	08/80	37400.	0.71	3.5
14	5170	3.20	09/77	08/80	29381.	1.03	44.5

SECRET

25X1

LWR FUEL REPROCESSED AT LA HAGUE
SEVENTH CAMPAIGN
1 MARCH 1983 - 30 JUNE 1983

NUM- ASBL	KGU- TOTAL	I% U235	INSRT DATE	DISCH DATE	BURNUP MWD/TE	D% U235	KG Pu- TOTAL
BORSSELE (Netherlands)							
1	310	3.30	4/76	10/78	30,500	1.02	2.7
3	940	3.30	4/76	10/78	30,500	1.02	8.1
28	8790	3.30	2/77	10/79	31,600	0.99	79.6
12	3770	3.30	12/77	10/79	24,200	1.37	28.2
GUNDREMMINGEN-A							
4	480	2.40	7/72	1/77	15,734	1.12	3.0
34	4120	2.40	6/75	1/77	10,013	1.47	17.5
31	3760	2.41	6/75	1/77	10,032	1.48	16.0
27	3270	2.41	10/76	1/77	3,021	2.08	5.2
ISAR-1							
204	37830	1.94	11/77	4/80	12,925	0.95	207.8
STADE							
7	2450	3.18	7/74	3/79	31,000	0.95	22.3
18	6290	3.18	6/75	4/78	30,340	0.97	56.6
5	1750	3.18	6/75	3/79	33,500	0.84	16.6
4	1400	3.18	6/75	3/79	31,000	0.95	12.7
16	5600	3.18	5/76	3/79	32,700	0.88	52.5
TIHANGE-1 (Belgium)							
1	460	1.95	2/75	1/78	24,200	0.52	2.4
9	4120	2.55	2/75	1/78	25,628	0.78	33.8
6	2740	2.55	2/75	1/79	34,500	0.47	26.3
3	1370	3.20	2/75	1/78	28,535	1.07	11.8
9	4120	3.10	2/75	1/79	33,700	0.79	38.6
1	460	3.20	3/78	1/79	11,700	2.11	2.2

SECRET

25X1

APPENDIX 4

CO₂ Reactor Fuel Element Data

CONCEPT, DEVELOPMENT AND RELIABILITY OF
FRENCH CO₂-COOLED REACTOR FUEL ELEMENTS

D. BASTIEN*

1. INTRODUCTION

The natural uranium-graphite-gas reactor series consists of 8 power plants in France, 6 of which are still in operation, and one reactor in Spain.

The first, Marcoule G.2, whose first criticality took place in 1958 and that was shut down on February 1st 1980, had a capacity of 40 MWe. The last one to start up in 1972, BUGEY 1, is 540 MWe net.

Improvements of the nuclear steam supply system have been accompanied by successive transformations of the fuel elements which have now reached a high degree of reliability.

2. DESIGN AND DEVELOPMENT OF FUEL ELEMENTS

Before passing on to the power plant stage France had built an unpressurized air-cooled reactor, G.1, where spectacular deformations of the unalloyed uranium were observed. This fuel consisted of magnesium clad unalloyed uranium rods.

2.1. G.2-G.3 fuel element

For power reactors it was necessary to define a not too deformable uranium alloy and a cladding material behaving well under CO₂ at high temperature.

*

C E A - DEDR - CEN/Saclay - F-91191 GIF-sur-YVETTE - CEDEX -

The choice of cladding material quickly settled on a low-zirconium (0.6 %) magnesium alloy. Easy to transform, amenable to argon arc welding, ductile when hot and not very absorbent neutronically it possessed all the essential qualities required.

Its maximum service temperature still had to be proved compatible with the increased in-pile performance of the fuel elements. This temperature, set first at 400 °C, was gradually raised to 515 °C (Mg-Zr melting point : 660 °C) while at the same time the longitudinal cooling fins gave way to herring-bone fins.

Having given entire satisfaction this Mg-Zr material was kept for all other types fuel elements in the series. Its only disadvantage is its permeability to plutonium, a defect corrected by the interposition of a thin graphite lining between the cladding and the fuel.

For the uranium rods a relatively non-absorbent alloy SICRAL F1 (0.07 % Al, 0.03 % Fe), deforming little under irradiation, was chosen.

2.2. CHINON 1 fuel element

To increase the specific power extracted from the fuel element the rods were replaced by tubes. At given maximum uranium and cladding temperatures it is possible to extract more heat per unit channel length from a tubular fuel than from a rod, which means that for a given reactor power the number of channels necessary is reduced.

Since SICRAL F1 is not mechanically resistant enough to withstand creep under compression a new alloy was needed for this tube closed at both ends by welded caps. A compromise had to be found conciliating neutron absorption, mechanical resistance and swelling properties, and an 0.5 % molybdenum-uranium alloy was finally adopted.

The CHINON 1 reactor, shut down after 10 years' service for economic reasons, was the first one designed with vertical channels in which the fuel elements were stacked directly one on top of another. The ends of the cans were thus subjected to considerable stresses, limiting the possibilities of this type of longitudinally finned fuel element.

.../...

2.3. CHINON 2, CHINON 3, ST-LAURENT 1 tubular fuel elements

To gain more specific power the uranium tube diameter was increased (43 x 23 mm) and consequently the molybdenum content of the alloy had to be raised to 1.1 % to improve its mechanical resistance ; at the same time the can was fitted with herring-bone fins, the geometry of which has gradually been optimised through very detailed thermal studies in which the fin height, profile shape, spacing and angle of inclination were varied. Moreover, the fuel element was housed in an individual graphite sleeve to limit mechanical stresses on the ends, each element supporting only its own weight. This arrangement has contributed greatly to the reliability of the fuel elements, especially at the time of handling which takes place under running conditions.

On the other hand the resistance of this type of fuel was limited by creep in the uranium tube and end caps, and the alloy used was going to be replaced by a quaternary alloy, MOSNAL, containing 1 % Mo, 0.05 % Sn and 0.05 % Al ; just then however a new design of fuel was conceived, a timely event because MOSNAL, loaded in small amounts in ST-LAURENT 1, proved difficult to reprocess industrially.

2.4. Graphite core fuel elements

This kind of fuel element has the same geometry as the tubular fuel and the two are interchangeable, but the new version is different in 2 respects :

- the graphite kernel from the casting process has been left inside the 43 x 23 mm uranium tube (whence its name "graphite core fuel element")
- the uranium alloy is different : since the graphite kernel is there to take pressure stresses, the mechanical properties of the uranium can be less stringent and the U-1.1 % Mo alloy is replaced by SICRAL F1, already used for G2 and G3.

Other component such as plugs, cans, sleeves are the same as those of the tubular element.

These graphite core elements have three main advantages :

.../...

1) Higher burn-up

Whereas for the U-1.1 % Mo tubular element the technological and neutronic limits are practically the same (5 000 MWd/t) the graphite core element, which uses a less absorbent fuel, offers greater neutronic possibilities. It was therefore possible to increase the fuel irradiation level to 6 500 MWd/t without overstepping the technological limits of the element.

This represents a fuel saving of 30 % over and above the 20 % saved by the axial rearrangement of 3 elements out of the 15 contained in each reactor channel.

2) Higher working temperatures and pressures

The working temperature of this type of element (tubular or graphite-core) is limited by the maximum temperature admissible on the uranium. Owing to the presence of the graphite kernel this temperature can be raised from 640 °C to 650 °C and the CO₂ pressure from 26.5 to 28.5 bar, corresponding to a possible increase of about 12 % in the reactor power.

3) Greater safety

Reducing the free volume inside the element reflects to a large extent on how the oxidation of the uranium tube develops after a cladding failure. The presence of the graphite core, chosen non-porous, is thus an important safety factor.

Besides possessing these three advantages the graphite core element is simpler to manufacture than the tubular element and the fuel is therefore noticeably cheaper.

For all these reasons this element was chosen for the first fuel load of ST-LAURENT 2 and VANDELLOS reactors and as replacement element for CHINON 2, CHINON 3 and ST-LAURENT 1.

2.5. BUGEY 1 annular fuel element

To obtain even higher specific powers an annular fuel was designed. The principle is to cool a large uranium tube by outside and inside cladding, which also means that no internal volume remains and high coolant gas pressures can be reached.

.../...

For BUGEY the diameters of the SICRAL F1 uranium tube were fixed at 95x77mm, providing 12 W/g specific power and high reactor power with few channels (2 900 channels for 1 700 MWth at ST-LAURENT 2 against 852 channels for 2 000 MWth at BUGEY 1).

This element took longer to develop. It was necessary in particular to bind cladding and fuel together metallurgically in order to avoid detachment of the inner can in certain thermal transients. This was achieved via an aluminium layer deposited by Shoop process, which diffuses into the cladding and uranium to give a metallurgical bond.

This fuel eventually proved almost as reliable as the graphite core element.

3. RELIABILITY OF FUEL ELEMENTS

3.1. For 51 000 nominal fuel elements loaded in CHINON 1 six cladding failures were observed, representing a failures rate of 10/100 000.

These failures were mainly caused by the stacking method of fuel element loading.

3.2. Of the 211 400 nominal U-1.1 % Mo tubular fuel elements loaded 22 cladding failures occurred, a failure rate of 10/100 000. These were largely due to localized inward tube deformation resulting from uranium creep.

3.3. In spite of its enhanced performances (maximum cladding temperature 515 °C, maximum uranium temperature 650 °C, specific burn-up 6 500 MWd/t) the graphite core fuel only included 7 failures amongst the 466 000 elements loaded, i.e. 1.5/100 000. Manufacturing defects are responsible here.

3.4. The annular fuel element appeared slightly less reliable with 3 cladding failures for 76 500 elements loaded, which represents a failure rate of less than 4/100 000. These again are due to manufacturing faults.

The favorable trend of these figures has been obtained by in-loop and in-pile irradiations of experimental and standard fuel elements, examined afterwards in the CEA hot laboratories, and by strict supervision of their manufacturer COGEMA to maintain the same high standards throughout.

APPENDIX 5

CELESTIN Data

HEAVY WATER TRITIUM/PLUTONIUM PRODUCTION REACTOR FUEL

Celestin-1 diverged on 15 May 1968. Celestin-2 diverged on 30 October 1968. These reactors were originally designed to produce tritium. They are heavy water reactors with a thermal power of 200 MW each. The reactors do not generate electricity.

STAT

The original fuel for the reactors appears to have been a PuAl alloy. It was reported that PuAl fuel from Celestin-1 was reprocessed in the second half of 1970 and that 50 kg of plutonium was recovered. Reprocessing of UAl alloy fuel from Celestin reportedly began in 1973.

STAT

In 1976 the reactors "received a plutonium breeding vocation", like that of the G2 and G3 reactors. The same document, from the early 1980s, stated that the irradiated fuel was stored for "over 9 months".

STAT

APPENDIX 6

Fast Reactor Reprocessing Data

FAST REACTOR REPROCESSING DATA

MARCOULE: SAP plant - 10-30 kg/day capacity

1975	50 kg Fortissimo	MOX (30% Pu)	14-76 GWD/t	6-17 months cool
1976	1,650 kg KNK	UO ₂	3.5-7 GWD/t	
1977-1978	2,300 kg Phenix	UO ₂	38-45 GWD/t	13-33 months cool
1979	150 kg Phenix	MOX (18% Pu)	37 GWD/t	10-30 months cool
	220 kg Phenix	MOX (25% Pu)	36-65 GWD/t	14-43 months cool
1980	840 kg Phenix	MOX (25% Pu)	36-65 GWD/t	14-43 months cool
1981	780 kg Phenix	MOX (25% Pu)	36-65 GWD/t	14-43 months cool
1982	9,000 kg <u>total</u> reprocessed (implies 3 t in 82)			
JAN-JUN 1983	1,600 kg Phenix	MOX (25% Pu)		

CAP DE LA HAGUEAT-1 Plant (capacity 1 - 2 kg/day)

1969-1979	250 kg Rapsodie	MOX (25% Pu)	40-55 GWD/t	6-12 mths cool
	658 kg Rapsodie	MOX (30% Pu)	50-120 GWD/t	5-24 months cool
	177 kg Phenix	MOX (18% Pu)	8-44 GWD/te	18 months cool

UP2 Plant (by dilution with gas graphite fuel)

JUN 79	2,200 kg Phenix	MOX (18% Pu)	21-42 GWD/te	38-50 months cool
OCT 1980				
-JAN 1981	2,100 kg Phenix			
OCT-NOV 1981	1,600 kg Phenix			
1982	0			
NOV-DEC 1983	900 kg Phenix			

bottles previously filled with mixtures of charcoal and graphite.

Overall DFs are measured by a comprehensive monitoring system to assess the limits of the technical feasibility with respect to the cost of each proposed technique. The off-gas treatment plant is supervised from a central control room with computer-assisted operation.

RECOVERY OF URANIUM AND PLUTONIUM

The extraction part of the HERMES facility is housed in a second hot cell complex consisting of ten hot cells divided in two main groups based on the fuel contents and on the activity of the treated solutions and in three analytical cells. Human intervention in some cells for maintenance has been kept as an option.

Basically, the PUREX solvent extraction consists of codecontamination of uranium and plutonium from the bulk of the fission products, partition of uranium and plutonium, followed by final decontamination of uranium and plutonium. Solvent recovery and recycle is an important item in the facility as well as waste concentration, tritium removal, and concentration from the low-level liquid waste (LLW).

Five to 30% TBP in kerosene is used as solvent in the decontamination pulsed column. This column has three feed inlets to parametrically investigate the influence of the residence time and the pulse conditions on the DF and on the plutonium contents of the fission product flow. The feed rate of this column is ~40 l/h and the feed solution is about 1 M in heavy metals.

The choice of the partition column has not yet been defined and will result of the study of two possible reduction methods of Pu(III) to Pu(IV): reduction by hydroxylamine nitrate or by electrolytic reduction.

Final purification of uranium and plutonium is also performed in pulsed columns, the second and the third cycles being performed in the same equipment, with necessary rinsings between the two cycles.

Fission products are concentrated in an evaporator, the distillate of which will be fractionated in LLW and recycled acid in a second evaporator. Climbing film evaporator types equipped with a stripping tower are used, and DFs of 10^5 are expected.

Recognizing that a sodium carbonate wash will probably be inadequate for washing solvent when used with such highly irradiated fuel and will generate too large amounts of waste, salt-free methods will be applied, such as the use of hydrazine carbonate. Other indispensable operations, such as rework of solutions and waste storage, received considerable attention in the planning stage.

CONCLUSIONS

The proposed HERMES facility has been designed under the following bases of selection:

1. Minimum volume of waste is generated through the use of a standard Purex solvent extraction process with non-waste-reducing auxiliary operations and reduction of the cladding material volume.
2. Fluorides used in the system will concern only a little fraction of the fuel solutions and will be removed prior to the addition of these solutions in the main stream.
3. Near-zero release of gaseous fission products to the environment.
4. Great versatility in the processes to be used in the extraction part with the possibility of human intervention.

2. Status of Fast Reactor Fuel Reprocessing in France, Jean Megy, Jean Sauteron, Michel Bourgeois (CEA/CEN-France)

INTRODUCTION

The French program for the reprocessing of fast reactor fuels forms part of the logical implementation of this reactor system, in which the reactor has reached the industrial stage, passing through the following three main phases:

1. Experimental phase, with the Rapsodie reactor at Cadarache. The Rapsodie fuel cycle has been closed several times, thanks to the reprocessing of its fuel in the AT1 facility at La Hague.

2. Demonstration phase, with the Phénix 250-MW(e) reactor at Marcoule. The Phénix fuel cycle is currently closed, thanks to the reprocessing of the core-2 assemblies in the Marcoule pilot plant (SAP = Service des Ateliers Pilotes) and the reprocessing of the core-1 assemblies in UP2 Plant at La Hague. The TOR facility will serve to handle all the Phénix fuels.

3. Industrial phase initiated with the 1200-MW(e) prototype power plant under construction at Creys-Malville in co-operation with FRG and Italy. The PURR (Prototype d'Usine de Retraitement des Rapides-Fast Fuel Reprocessing Plant) is under study for reprocessing of a small series of industrial fast breeder reactors, comprising Creys-Malville.

The French research and development (R&D) programs, specific for fast reactor fuels reprocessing, are oriented toward the PURR project, the TOR project being one of the most important.

FRENCH EXPERIENCE IN FAST REACTOR FUEL REPROCESSING

The quantities of fast reactor fuels reprocessed as of July 1, 1981, in the French facilities are given in Table I.

AT1 Facility- La Hague. The AT1 facility, specially designed to reprocess Rapsodie fuel with a capacity of 1 kg/day, went on stream in 1969 and by July 1979, when it was definitively shut down, had reprocessed more than 1 ton of heavy metals from mixed oxides irradiated to a burnup of 120 000 MWd/ton, and sometimes only slightly "cooled" (5 months, and 1.5 months for a small number of assemblies), thus achieving closure of the Rapsodie fuel cycle. Part of the reprocessed fuel (more than 150 kg) was obtained from mixed oxides of Phénix.

Marcoule Pilot Plant (SAP). The Marcoule Pilot Plant was adapted to reprocess fast reactor oxides. It processed a batch of 50 kg of highly irradiated fuel from Rapsodie/Fortissimo in 1975, a slightly irradiated but far larger batch (1650 kg) from the German KNK reactor in 1976, and a more irradiated (over 45 000 MWd/ton) batch of 2.3 tons of Phénix enriched-uranium fuels in 1977 and 1978. It is currently reprocessing Phénix plutonium fuels from core-2 irradiated to ~55 000 to 76 000 MWd/ton and cooled one year or more. Up to July 1, 1981, nearly 3 tons of Phénix fuels have been reprocessed at a rate of ~10 to 20 kg/day.

However, due to the obsolescence of the present installations and to their extremely limited possibilities in terms of capacity and R&D, the TOR project was launched.

UP2 Plant-La Hague. More than 4 tons of heavy metals of Phénix core-1 fuels have been reprocessed in the UP2 plant, treated by dilution with gas-graphite fuel dissolving solutions after chopping and dissolution in HAO [head end for light water reactor (LWR) fuels].

TABLE I
French Experience in the Reprocessing of FBR Fuels
(on July 1, 1981)

REACTORS	INITIAL COMPOSITION CORE Pu/U + Pu %	AT.1 (La Hague)			BAP (Marcoule)			UP ₂ (La Hague)			TOTAL QUANTITY U + Pu (kg)
		Quantity U + Pu (kg)	GWj/t oxides core	Cooling time ^a (months)	Quantity U + Pu (kg)	GWj/t oxides core	Cooling time ^a (months)	Quantity U + Pu (kg)	GWj/t oxides core	Cooling time ^a (months)	
KMK 1	enriched U				1650	3.5-7					1650
PHENIX CORE 3	enriched U				2300	38-45	13-33				2300
TOTAL ENRICHED U FUELS					3950						3950
HAPSODIE CORE 1	25	250	40-55	6-12							250
HAPSODIE FURTHERSTIMO	30	658	50-120	5-24	50	14-76	6-17				708
PHENIX Pu CORE 1	18	177 ^b	8-44	18	150	37	10-30	4121	21-42	38-50	4448
PHENIX Pu CORE 2	25				2770	36-76	14-43				2770
TOTAL Pu FUELS		1085			2970			4121			8176
TOTAL FBR FUELS		1085			6920			4121			12126

^aCooling time after exit from reactor storage.

^bMixed-oxide only.

THE TOR PROJECT

The TOR facility (Traitement des Oxydes "Rapides" "Fast" Oxide Reprocessing), with an annual capacity of 5 tons of heavy metals of fuels from fast breeder reactors, which is due to be commissioned at the end of 1983, will be a result of renovation, modification, and enlargement of the present pilot plant at Marcoule. The TOR project is designed to:

1. increase the current capacity to enable complete closure of the Phénix fuel cycle, with excess capacity available to reprocess fuels from Creys-Malville or other foreign fast reactors [A contract was signed between Kernforschungszentrum Karlsruhe and the Commissariat à l'Energie Atomique (CEA) for the reprocessing of the three first cores of the German KNK II reactor.]
2. increase the reliability of the equipment and the safety of the facility.
3. considerably expand the R&D resources, to allow for experiments in actual service conditions of most of the techniques that will be used in the PURR facility.

The TOR facility will include the following:

1. A TOR-1 head consisting of new alpha-beta-gamma cells in which the head operations will be performed. There will be two parallel equipment lines:

- a. A main line designed to test the process and equipment on which experience in active conditions has already been gained on a significant scale and over long-term runs. This process line will serve to carry out reprocessing programs for Rapsodie, Phénix, and for other customers.
- b. A set of experimental units that can be positioned on a bypass to the main process line, to test with real fuels the techniques and equipment intended for PURR (mechanical treatments, continuous dissolution, clarification, gas treatment, treatment and packaging of solid wastes).

TOR 1 will be built in the form of an independent building located near the present pilot plant, to which it will be connected to carry out the rest of the process.

2. A unit called TOR-2, associated with finished products, and including particularly storage facilities. This unit completes the arrangements begun in 1977 for the renovation of the final plutonium purification cycle and the liaison with the Marcoule UP1 facility for the transfer of plutonium solutions. The possibility to add a denitration unit for R&D purpose is under study.

- 3. Changes in present installations of the pilot plant in the existing cells (TOR-3) to insert a new first-pulsed column extraction cycle, a new fission product solution concentration, and a new third uranium extraction cycle.

Construction began in April 1980 for TOR-1, and decontamination of the cells associated with TOR-3 was initiated simultaneously. With the TOR facility, the CEA, in addition to the means of closing the Phénix fuel cycle, will possess the indispensable tool for long-term experiments, on a significant scale, of the reprocessing process, and for R&D on components in active conditions, to achieve the confirmation of the options adopted for the PURR facility.

THE PURR PROJECT

The PURR project takes account of the reprocessing of fuel from five 1200/1800-MW(e) class reactors and, obviously, Creys-Malville and Phénix fuels, as well as those from the SNR-300. In the current state of affairs, this means a maxi-

mum capacity of ~130 ton/yr of heavy metals, with a plutonium production of 10 to 16 ton/yr, depending on the type of fuel.

The project has been drawn up on the basis of a plant featuring a single reprocessing line and handling fuels in which the mixed oxide has a plutonium content below 25% ($Pu/U + Pu \leq 25\%$) and that have undergone maximum irradiations of 125 000 MWd/ton of mixed oxides and been cooled for at least one year. Using the preliminary process book supplied by the CEA in May 1980, COGEMA/SGN and CEA teams are currently working on the preliminary project.

R&D PROGRAMS

The CEA, aware of the problems implied by adaptation of the PUREX process to the reprocessing of fast fuels, mounted the necessary R&D efforts very early. At the present time, the feasibility of fast reactor fuel reprocessing has been largely demonstrated, at a significant scale (Table I), on fuels far more difficult to reprocess in most cases than those considered for commercial reactors: higher plutonium concentration in the core, burnup at least equal to previous maxima, very short cooling time, poor storage conditions etc.). Hence, the CEA's R&D programs were aimed at adaptation to the industrial fuel reprocessing stage, with special emphasis on problems associated with the change in scale (high capacities and flow rates, high flux of plutonium and fission products, etc.), with a view to optimizing the overall system.

The R&D programs on fast reactor fuel reprocessing are based on the PURR project, obviously drawing maximum benefit from the very important effort made for industrial LWR fuel reprocessing projects in the short term.

The R&D programs were implemented on four levels:

1. laboratory investigations (Fontenay-aux-Roses) on increasingly irradiated fuels and on potential innovations
2. chemical engineering (Fontenay-aux-Roses) to select the types of unit and to furnish the data required for their industrial extrapolation
3. industrial prototypes (Marcoule): development of all units in full scale in inactive conditions, with all their peripheral systems (gas treatment, waste removal) and with all the technology of the future operation (remote control, monitoring and regulation, servicing, and repair procedures, etc.)
4. pilot plant (Marcoule): pilot plant runs at Marcoule on fast reactor fuels (Phénix) designed to try the processes and types of equipment intended for use in the plant in active conditions and over significant periods.

The main objectives of the R&D programs are linked to mechanical treatment (dismantling of fuel subassemblies, chopping), dissolution (continuous), clarification, extraction, elaboration of PuO_2 , and waste treatment.

CONCLUSIONS

Thus, the CEA continues to devote an intense effort to the reprocessing of fast reactor fuels, with the objective of the construction of the PURR facility. The results have demonstrated that the aqueous method can be applied to these fuels: this is attested to by nearly ten years of operation of the AT1 facility that reprocessed Rapsodie fuel, and the excellent results obtained on large batches of fuels at the Marcoule Pilot Plant and at UP2 Plant.

This effort is also devoted to the passage to industrial scale, thanks in particular to the testing of industrial prototypes and the launching of the TOR project, which will make it possible to reprocess fast reactor fuels on a significant scale from 1984 onward, and to provide major supplementary support for R&D.

(FRANCE) RAPSODIE

RAPSODIE REACTOR

PURPOSE: Engineering test

DATE OF INFORMATION: May 1964

GENERAL

1. Reactor type	Fast breeder type, highly enriched (60%) uranium and plutonium, depleted uranium blanket, sodium cooled	5. Owner and operator	EURATOM — CEA Fast Neutrons Association Projet neutrons rapides, Section de conduite de RAPSODIE
2. Nominal reactor power	20 MW (th) (17 MW in core, 3 MW in blanket)	6. Designer and builder	EURATOM-CEA Fast Neutrons Association Groupement Atomique Associee Atlantique and various firms of the European Community
3. Purpose	Engineering test, operation experiment, fast reactor physics, fast reactor fuel irradiation	7. Present status & construction schedule	Under construction Start of construction July 1961 Reactor critical 1966
4. Location	Centre d'études nucléaires de Cadarache (Bouches-du-Rhône)		

REACTOR PHYSICS

8. Neutron energy and lifetime	Half of fissions 0.40 MeV 9/10 of fissions 0.02 MeV Lifetime 8×10^{-8} sec	10. Neutron flux	<u>41 MW as upgraded</u> At 20 MW: Fast max. 2×10^{14} n/cm ² sec Fast av. 1.25×10^{14} n/cm ² sec
9. Core parameters	Not available Neutron leakage core to blanket: 54%	11. Reactivity balance	Not available

CORE

12. Shape and dimensions	Cylindrical, 38.7 cm diam. x 34 cm high	18. Average power density in core	420 kW/litre (in core)
		19. Burnup	30 000 MWd/t (expected)
13. No. of channels & subassemblies	53 sub-assemblies in core, 350 in blanket	20. Fuel loading and unloading	Unloading by means of rotating plug adjusted to bring loading channel in position Loading cask comes in position above loading channel. Cask replaces used sub-assembly by a new one, and transfers the used element into sealed canister which is carried into a pool by another cask.
14. Lattice	Hexagonal Pitch 50.8 mm	21. Irradiated fuel storage	Pool outside reactor building, room for 189 core sub-assembly canisters and 756 blanket sub-assembly canisters
15. Critical mass	35.7 kg ²³⁹ Pu 3.9 kg ²⁴⁰ Pu 67.3 kg ²³⁵ U 45.4 kg ²³⁸ U	22. Moderator	None
16. Core loading at rated power	Fissionable material 173 kg UO ₂ + PuO ₂ Fertile blanket 8370 kg UO ₂	23. Blanket gas	Argon
17. Average specific power in fuel	115 kW/kg (UO ₂ + PuO ₂)		

FUEL ELEMENT

24. Form and composition	UO ₂ + PuO ₂ pellets Composition UO ₂ : 74 wt.%, PuO ₂ : 26 wt.% Uranium enrichment: 60% Plutonium enrichment: 10% UO ₂ pellets for blanket	25. Cladding	Type 316 L SS cladding, 0.45 mm thick, He bonding
		26. Subassemblies	37 pins per sub-assembly in fuel section 7 pins per sub-assembly in blanket section Hexagonal section, 49.8 mm between parallel faces, 1664.5 mm overall length

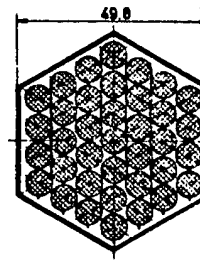
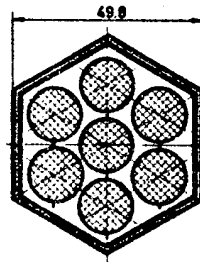
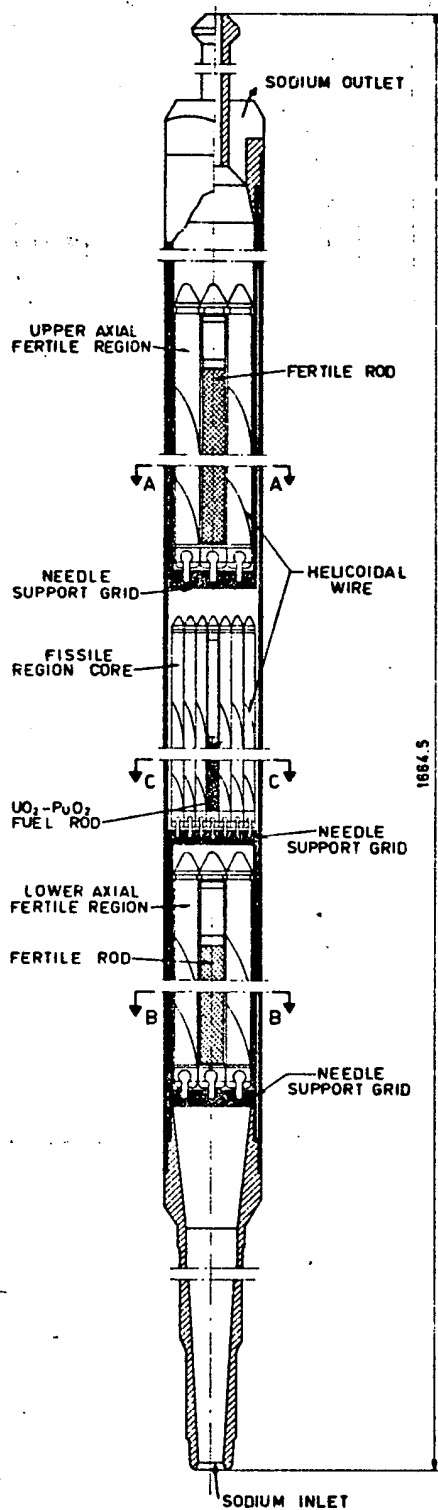

All dimensions in mm

FUEL ASSEMBLY

1864 S

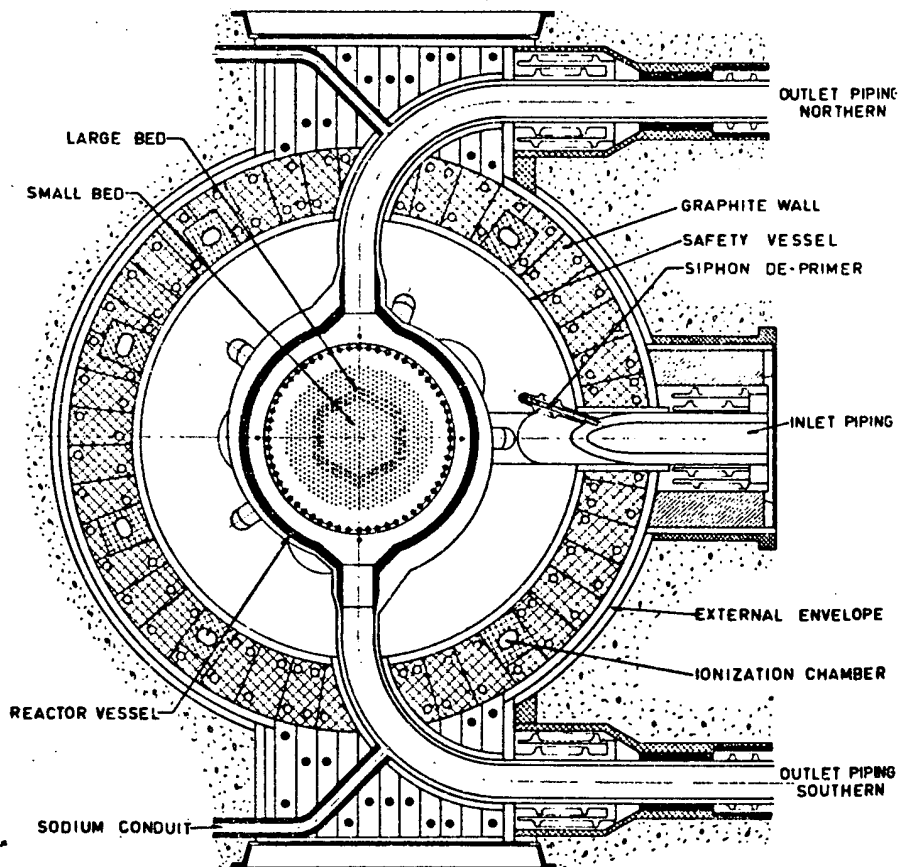

HORIZONTAL SECTION REACTOR RAPSODIE

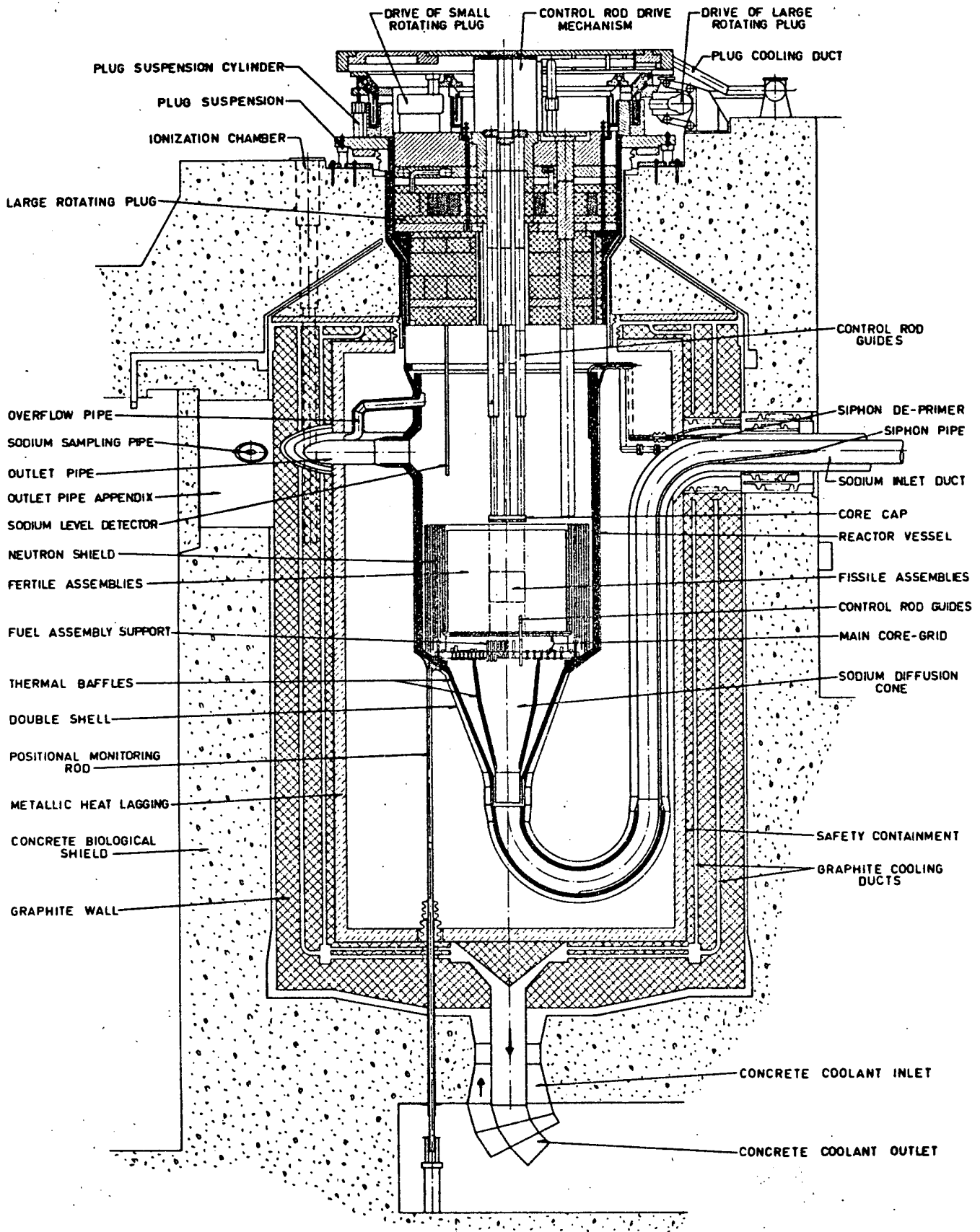

VERTICAL SECTION REACTOR RAPSODIE

27. Heat transfer area	Total area: approx. 14.00 m ²	32. Coolant mass flow rate	Core: 135 kg/sec Total: 183.5 kg/sec
28. Heat flux	Av. 117 W/cm ² Max. 185 W/cm ²	33. Coolant pressures & temperatures	Inlet: 450° C, 2 kg/cm ² Outlet: 540° C atmospheric
29. Fuel element temperatures	Max. fuel: 2000° C Max. cladding: 635° C Film drop, av.: 17° C	34. Hot channel factors	Temperature drop through fuel 1.40 Cladding 1.37 Film 1.32 Temperature rise in coolant 1.15
30. Heat transfer coefficient	1.6 cal/cm ² sec deg C	35. Shut-down heat removal	Natural convection of sodium coolant
31. Coolant flow area & velocity	Total area for core: 347.5 cm ² Av. velocity: 4.6 m/sec Max. velocity: 5.4 m/sec		

CONTROL

36. Control, regulating and safety rods	4 shim-safety rods, boron carbide, cylindrical 450 mm long 2 regulating rods, boron carbide, cylindrical 450 mm long Worth of regulating rods: $0.17\% \frac{\Delta k}{k}$ Speed of shim-safety rods: up 0.2 mm/sec down 1 mm/sec shut-down 1 m/sec Speed of regulating rods: $1 \text{ cm/sec} = 2.5 \times 10^{-3} \% \frac{\Delta k}{k} / \text{sec}$	38. Scram time & mechanism	Magnetic clutch, gravity fall spring assisted Delay time: 0.1 sec Rod travel time: 0.3 sec
		39. Sensitivity of auto. control	No automatic control
		40. Temperature coefficients	Isothermal $-3\% \frac{\Delta k}{k} / \text{deg C}$ (in most pessimistic case)
		41. Burnable poison	B ¹⁰ in control rods, corresponding to $7.24\% \frac{\Delta k}{k}$ initially
		42. Other control, safety & shut-down provisions	None
37. Reactivity addition rate	$2.5 \times 10^{-3} \% \frac{\Delta k}{k} / \text{sec}$		

REACTOR VESSEL & OVERALL DIMENSIONS

43. Form, material and dimensions	Cylinder, type 316 L SS, 1600 mm diameter	44. Working, design & test pressures	Working pressure: 2 kg/cm ² Design pressure: 4 kg/cm ²
		45. Reactor with shielding	8 m diam. x 14 m high

REFLECTOR AND SHIELDING

46. Reflector	Natural UO ₂ , 50 cm thick Blanket UO ₂ pins, SS clad, sodium cooled	48. Shielding	Sides: 60 cm heat resistant borated concrete + 125 cm ordinary borated concrete Bottom: same as on sides Top: 185 cm borated concrete + 65 cm steel Nitrogen cooling Temperatures: max. in ordinary concrete 70° C max. in heat resistant concrete 200° C
47. Radiation levels	25 mr/hr at full power in limited access area Less than 2.5 mr/hr at full power in permanent access area		

CONTAINMENT

49. Type and material	Cylindrical shell with hemispherical head and flat bottom, 25 m diam. x 44 m high Wall thickness: sides 26 to 32 mm top 12 to 15 mm Working pressure: 50 g/cm ² Test pressure: 2.4 kg/cm ² Leakage: 0.1% per day	50. Surroundings	Low population density rural area Nearest village at 6 km Nearest town (10 000 inhabitants) at 20 km
-----------------------	---	------------------	--

COST ESTIMATE

51. Reactor and building	Not available	53. Operating costs	Not available
52. Support facilities	Not available	54. Staff requirements	9 engineers 64 technicians 11 administrative people

adaptés aux grandes dimensions des éléments combustibles. Au cours des années 1971, 1972 et 1973, ces moyens ont été mis en place et rendus opérationnels au Laboratoire d'Études des Combustibles Irradiés (L.E.C.I.) de Saclay pour le transport, le stockage et la télémanipulation ainsi que pour les examens des crayons combustibles ou des assemblages irradiés.

(D.M.E.C.N. - Département de Technologie, Saclay)

D | FILIÈRE DES RÉACTEURS A NEUTRONS RAPIDES

1. RÉACTEUR EXPÉRIMENTAL RAPSODIE / *Fortissimo*

a) Exploitation

Le réacteur a fonctionné régulièrement pendant les six campagnes d'irradiation qui se sont déroulées en 1973. Le milliard de kWh a été dépassé en décembre. Le facteur de charge moyen pour l'année a été supérieur à 65%, avec des valeurs par campagne comprises entre 74 et 99%.

Le « Traitement Centralisé des Mesures et des Signalisations » ayant eu quelques défaillances, il a été décidé de remplacer cet ensemble par un nouveau calculateur, lequel doit être opérationnel en 1974.

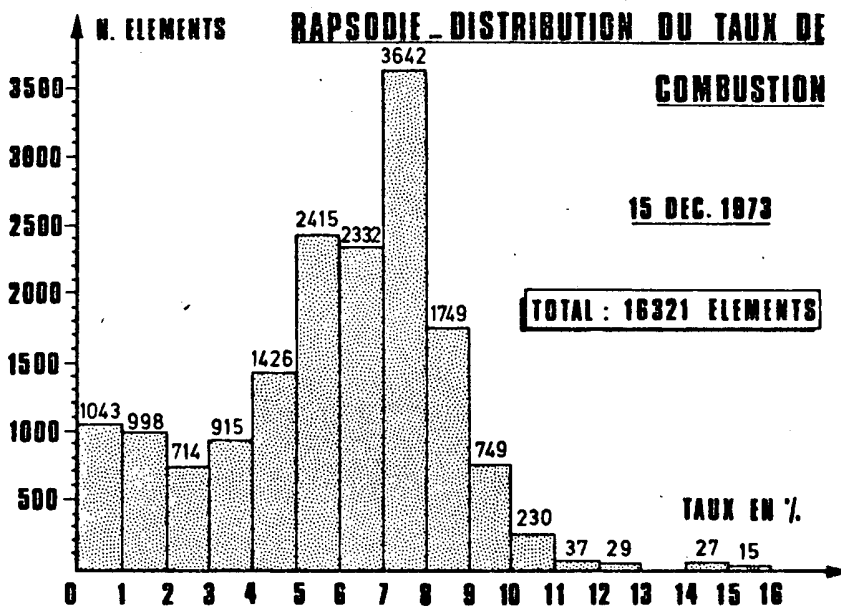

Rapsodie - Distribution du taux de combustion au 15 décembre 1973.

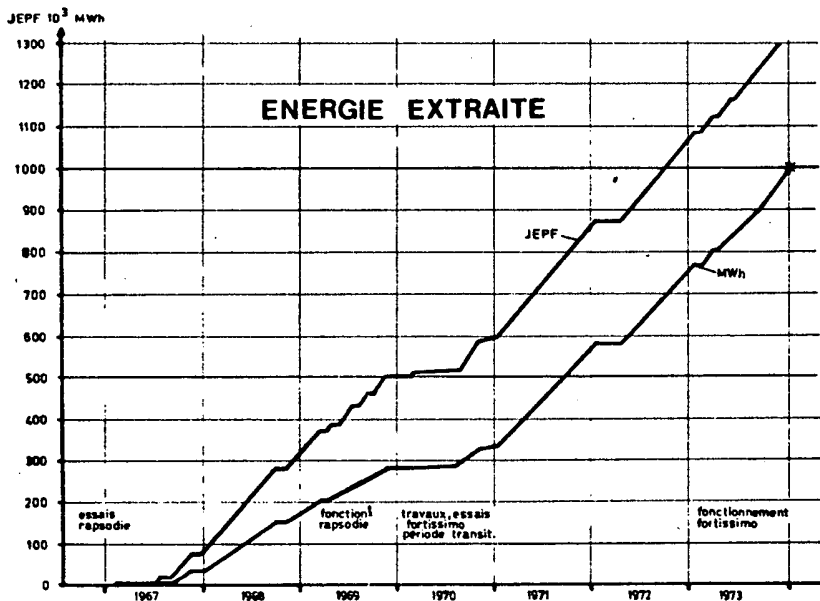

Énergie extraite de Rapsodie au 31 décembre 1973.

(FRANCE) PHENIX

PHENIX

PURPOSE: Prototype Power Production

DATE OF INFORMATION: June 1969

GENERAL

1. Reactor type	Plutonium and depleted uranium, steel and depleted uranium reflected, sodium cooled, fast breeder type	6. Owner(s)	Commissariat à l'énergie atomique (CEA)
2. Number of reactors in the plant	1	7. Operating authority	Electricité de France (EDF)
3. Rated output per reactor	Gross thermal 563 MW Core 507 MW Blanket 56 MW Gross electrical 250 MW Net electrical 233 MW Station use 6.8%	8. Designer(s)	CEA, EDF, GAAA
		9. Main contractor(s)	Not available
4. Net efficiency	41.4%	10. Construction schedule	Start of construction Dec. 1968 Reactor critical 1973 (planned) <i>First power Dec 73</i>
5. Location	Marcoule, France	11. Present status	Under construction

REACTOR PHYSICS

12. Mean neutron energy	Fast, 2 to 300 keV	16. Neutron flux	Max. 7.6×10^{15} n/cm ² s
13. Prompt neutron lifetime	4×10^{-7} s	17. Excess reactivity to compensate for	Temperature and power 1% Burn-up (for 50 days' run) 1.06%
14. Core parameters	Not available		18. Maximum excess reactivity built in
15. Conversion ratio	Conversion ratio (internal zone) 0.54 Breeding ratio (total) 1.16	19. Temperature coefficients	$-4.3 \times 10^{-3}\%$ $\frac{\Delta k}{k}$ /deg C

LEGEND:

- CONTROL ROD
- GRAPHITE
- GRAPHITE
- STEEL
- STEEL
- BORATED GRAPHITE
- ⊙ BORATED GRAPHITE

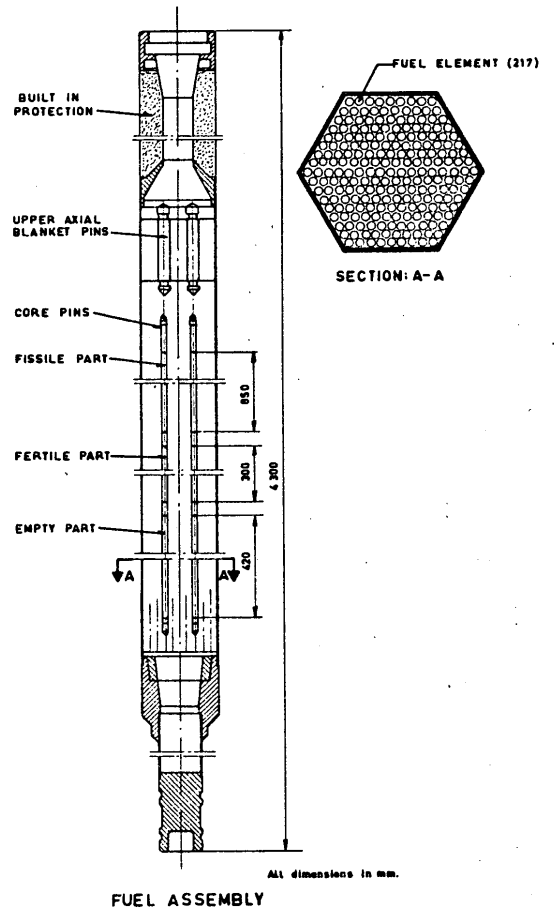
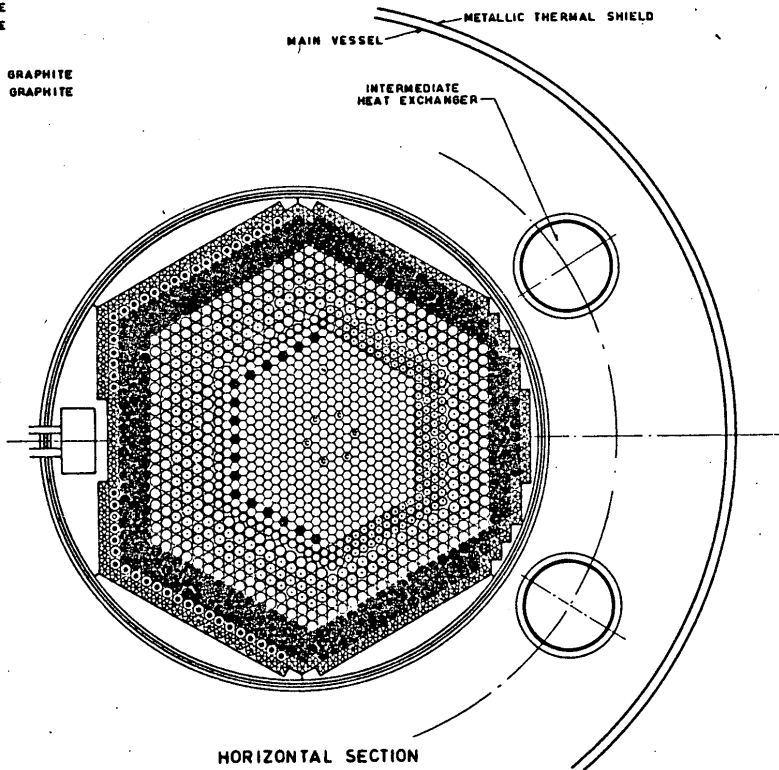

REACTOR PHENIX

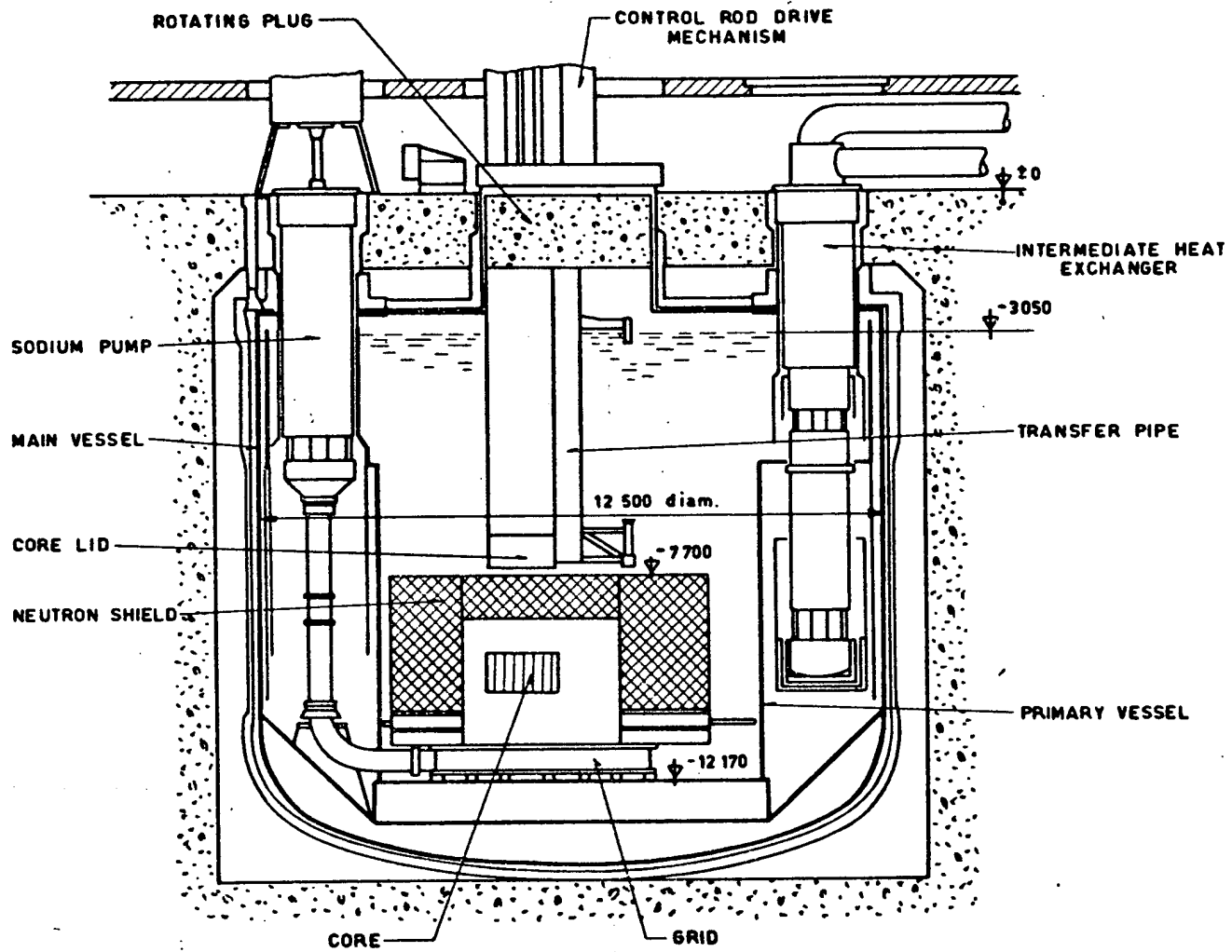

VERTICAL SECTION
REACTOR PHENIX

20. Sh Sanitized Copy Approved for Release 2010/09/01 : CIA-RDP88R01225R000100310003-2 oding

21. Number and size of channels	103 fuel assemblies in two zones, 55 in central zone, 48 in radial zone 90 fertile assemblies in blanket	29. Irradiated fuel storage	Storage vessel adjacent to reactor vessel, filled with sodium, temp. 150°C, capacity for 100 fuel and fertile assemblies
22. Lattice	Triangular Pitch 12.4 cm	30. Refuelling scheme and schedule	6 times annually, each time replacing 15 to 17 fuel assemblies and 8 to 11 fertile assemblies Down-time 10h
23. Critical mass	Initial: 735 kg ²³⁹ Pu equiv. Equilibrium: 728 kg ²³⁹ Pu equiv.		
24. Core loading at rated power	4160 kg fuel or 840 kg ²³⁹ Pu equiv.	31. Arrangement for reprocessing	Not available
25. Average power density in fuel	604 kW/kg ²³⁹ Pu	32. Moderator	Not applicable
26. Average core power density	460 kW/litre		
27. Burn-up	Av. 31 400 MWD/t oxide Max. 50 000 MWD/t oxide (initial) 100 000 MWD/t oxide (planned)	33. Blanket gas	Argon, press. 1 kg/cm ²

FUEL ELEMENT

34. Form and composition	Central and radial zone: PuO ₂ and UO ₂ pellets, 5.5-mm diam., in tubes, active length 85.0 cm, total length 189.3 cm Blanket: UO ₂ pellets, 12.6-mm diam. Depleted (0.2%) uranium Enrichment in Pu [PuO ₂ (PuO ₂ + UO ₂)] in central zone 19.2 vol.% in radial zone 27.1 vol.% Plutonium contains 20% ²⁴⁰ Pu	36. Fuel assembly	Central and radial zone: 217 fuel elements per assembly Blanket: 61 fertile elements per assembly Assembly has a hexagonal cross-section, 12.37 cm across the flats, total length 4.3 m
35. Cladding	Stainless steel type AISI 316, in central and radial zone 0.45 mm thick, in blanket 0.50 mm thick		

CORE HEAT TRANSFER

37. Heat transfer area	Per fuel assembly 3.82 m ² Total 394 m ²	43. Heat transfer coefficient	13.8 W/cm ² deg C
38. Heat flux on the fuel element surface	Av. 143 W/cm ² Max. 208 W/cm ²	44. Coolant mass flow rate at rated power	Through the core 2760 kg/s Per fuel assembly max. 25.7 kg/s av. 22.7 kg/s
39. Coolant film temperature drop	7 deg C	45. Coolant temperatures	Inlet 400°C Outlet 560°C
40. Fuel element temperatures	Max. cladding 700°C	46. Coolant pressures	Inlet 7.6 kg/cm ² Outlet 1.0 kg/cm ²
41. Coolant flow area	Per fuel assembly 41.6 cm ² Total 4300 cm ²	47. Hot channel factors	Temp. drop through cladding 1.17 through film 1.47 Temp. rise in coolant 1.2
42. Channel velocity of the coolant	Av. 6.5 m/s Max. 7.4 m/s	48. Provision for shutdown heat removal	(a) steam generator (b) emergency circuit

CONTROL

49. Basic control features	Control rods	52. Scram time and type of mechanism	Delay time 0.2 s Rod drop time 0.6 s
50. Control, regulating and safety rods	6 safety rods 6 shim rods, annular, boron carbide or tantalum, active length 9.5 cm Total worth of shim rods 6% $\frac{\Delta k}{k}$	53. Automatic control	Not available
		54. Reactivity coefficients	Temperature $-4.3 \times 10^{-3}\% \frac{\Delta k}{k}/\text{deg C}$ Power $-1.3 \times 10^{-3}\% \frac{\Delta k}{k}/\text{deg C}$ Doppler (815°C) $-2.6 \times 10^{-4}\% \frac{\Delta k}{k}/\text{deg C}$
51. Max. rate of reactivity addition	Not available	55. Other shutdown provisions	Not available

REACTOR VESSEL

56. Form and dimensions	Cylindrical primary vessel, 6.76 m diam., containing the core, control rods and lateral neutron shield Cylindrical main vessel, 11.8-m i.d. X 11.5 m high, containing the primary vessel, the intermediate heat exchangers, the sodium pump and the fuel transfer pipe Wall thickness of main vessel: 35 cm	59. Reactor vessel and cladding materials	Not available
		60. Pressures and nominal stress	Not available
57. Wall temperature	Max. 580°C Max. temp. gradient 5 deg C/cm	61. Thermal insulation and/or thermal shield	A double enveloping vessel, surrounding the main vessel with an interspace of 10 cm, covered on the outside with a heat-resistant metallic layer, 2.5 cm thick
58. Integrated neutron flux	Not available		

FLUID FLOW

62. Heat exchangers	6 intermediate heat exchangers, one stage, extended surface 465 m ² each <table border="1" style="margin-left: 20px;"> <tr> <td></td> <td>sodium on primary side</td> <td>sodium on secondary side</td> </tr> <tr> <td>Inlet temp.</td> <td>560°C</td> <td>350°C</td> </tr> <tr> <td>Outlet temp.</td> <td>400°C</td> <td>550°C</td> </tr> </table> 3 steam generators with superheaters Water inlet temp. 246°C Steam outlet temp. 512°C, press. 168 kg/cm ²		sodium on primary side	sodium on secondary side	Inlet temp.	560°C	350°C	Outlet temp.	400°C	550°C	66. Primary coolant purification and losses	Cold trap purification system
			sodium on primary side	sodium on secondary side								
Inlet temp.	560°C	350°C										
Outlet temp.	400°C	550°C										
63. Primary circuit	800 t sodium	67. Primary coolant decomposition and recombination	Not applicable									
64. Primary circuit piping	Not available	68. Secondary circuit	Sodium coolant in 3 loops, 3 vertical pumps, low speed 250 rev/min, high speed 975 rev/min, power consumption 770 kW per unit Sodium flow rate in steam generator 2210 kg/s in superheater 1215 kg/s									
		69. Safety features of the cooling system	(a) Integrated system; pumps, core and intermediate heat exchangers are located in the same vessel (b) The sodium primary circuits are covered by a neutral gas atmosphere (c) Sodium and water are separated from each other by at least 2 walls (d) The steam generators are equipped with vents and isolating devices for the event of sodium-water reaction									
65. Pumps or circulators	3 vertical pumps, with a total capacity of 2760 kg/s, low speed 250 rev/min, high speed 975 rev/min, power consumption 975 kW per unit	70. System for detecting fuel element failures	Monitoring primary sodium coolant after leaving the fuel channels									

71. Ref		arrangement	
72. Shielding and radiation levels	<p>3 types of tubes surrounding the core, radially outwards:</p> <p>(a) 216 hexagonal tubes, filled with iron bars</p> <p>(b) 175 circular tubes, 12.4-cm diam., filled with graphite or steel bars</p> <p>(c) 761 circular tubes, 15.8-cm diam., filled with graphite, bored and graphite or steel bars</p> <p>Concrete at sides, top and bottom, with a rotating plug at top</p> <p>Overall dimensions 14.04-m diam. X 15.48 m high</p>		

SAFETY AND CONTAINMENT

74. Site and surroundings	<p>Located adjacent to Marcoule Centre, between highway and Rhône river, distance to nearest town 2 km</p> <p>Radius exclusion area 0.2 km</p> <p>Population within 20-km radius 250 000</p> <p>Located in earthquake zone</p>	76. Arrangement, materials and dimensions	<p>Rectangular concrete building, 26 X 42 m, 35 m high</p> <p>Wall surrounding the core 2 m thick, upper part 0.25 m thick</p>
		77. Pressure	<p>Working press. -5 g/cm² underpressure</p> <p>Resistant to an overpressure of +40 g/cm²</p>
75. Type of containment	Reactor building with controlled leakage rate	78. Leakage rate	Not available

TURBOGENERATOR

79. Turbine	<p>One single-shaft turbine, condensing type, consisting of four parts: H.P., I.P.-high temp., I.P. + L.P. and L.P., 250 MW, 3000 rev/min</p> <p>Steam flow 751 t/h</p> <table border="0" data-bbox="341 1449 812 1554"> <tr> <td></td> <td>HP-steam</td> <td>IP- and LP-steam</td> </tr> <tr> <td>Inlet temp.</td> <td>610°C</td> <td>610°C</td> </tr> <tr> <td>Outlet temp.</td> <td>308°C</td> <td>28°C</td> </tr> <tr> <td>Inlet press.</td> <td>166 kg/cm²</td> <td>33.4 kg/cm²</td> </tr> <tr> <td>Outlet press.</td> <td>37.9 kg/cm²</td> <td>0.038 kg/cm²</td> </tr> </table>		HP-steam	IP- and LP-steam	Inlet temp.	610°C	610°C	Outlet temp.	308°C	28°C	Inlet press.	166 kg/cm ²	33.4 kg/cm ²	Outlet press.	37.9 kg/cm ²	0.038 kg/cm ²	80. Generator	<p>One generator, 296 MVA, 3 phases, 20 kV, hydrogen cooled</p>
	HP-steam	IP- and LP-steam																
Inlet temp.	610°C	610°C																
Outlet temp.	308°C	28°C																
Inlet press.	166 kg/cm ²	33.4 kg/cm ²																
Outlet press.	37.9 kg/cm ²	0.038 kg/cm ²																
		81. Condenser	<p>One surface type condenser, exhaust press. 0.034 kg/cm²</p> <p>Cooling water flow rate 33 500 t/h, inlet temp. < 22°C, outlet temp. < 30°C</p>															

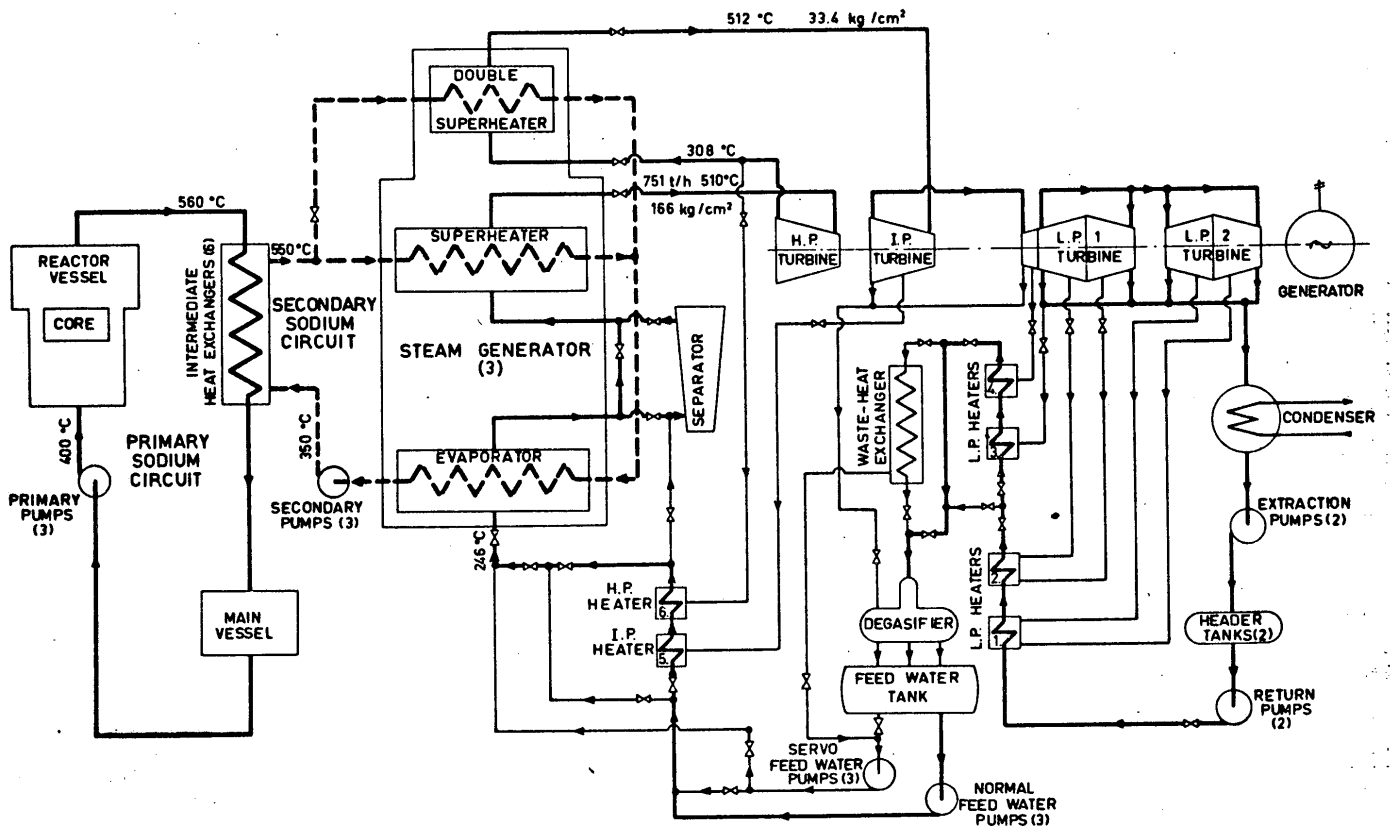

FLOW DIAGRAM REACTOR PHENIX

(FEDERAL REPUBLIC OF GERMANY) KNK

KOMPAKTE NATRIUMGEKÜHLTE KERNREAKTORANLAGE

PURPOSE: Power experiment

DATE OF INFORMATION: May 1966

GENERAL

1. Reactor type	Medium enriched (6%) uranium, zirconium hydride moderated, Na cooled	6. Owner and operator	Gesellschaft für Kernforschung, Karlsruhe, Federal Republic of Germany
2. Number of reactors in plant	1	7. Designers	Interatom, Bensberg near Köln
3. Rated output per reactor	Gross heat 58 MW Gross electrical 21.35 MW Net electrical 19.1 MW Self-consumption 10.5 %	8. Main contractors	Interatom, Bensberg near Köln
4. Net efficiency	33%	9. Present status	Under construction
5. Location	Nuclear Research Centre, Karlsruhe, Federal Republic of Germany	10. Construction schedule	Start of construction 1966 Reactor critical 1970 Full power operation 1970

REACTOR PHYSICS

11. Neutron energy and lifetime	Thermal	14. Neutron flux	thermal average 2.89×10^{18} n/cm ² s fast average 1.3×10^{14} n/cm ² s average radial 0.56 maximum average axial 0.73 maximum
12. Core parameters	Hot γ 1.929 β 0.769 ρ 0.692 c 1.231 k_{∞} 1.264 k_{eff} 1.145 L^2 5.4 cm ² T 51.3 cm ² B^2 0.0424 cm ⁻²	15. Excess reactivity to compensate for	Temperature 0.9% Xe and Sm at rated power 3.3% Burnup 10.9% Void 1.8%
		16. Maximum excess reactivity	10.9%
13. Conversion ratio	0.25	17. Temperature coefficient	Fuel Cold $-1.5 \times 10^{-3} \frac{\Delta k}{k} / \text{deg C}$ Operating temperature $-9.8 \times 10^{-4} \frac{\Delta k}{k} / \text{deg C}$ Moderator $+7.2 \times 10^{-3} \frac{\Delta k}{k} / \text{deg C}$ $+8.18 \times 10^{-3} \frac{\Delta k}{k} / \text{deg C}$ Coolant $-5 \times 10^{-3} \frac{\Delta k}{k} / \text{deg C}$ $-6 \times 10^{-4} \frac{\Delta k}{k} / \text{deg C}$

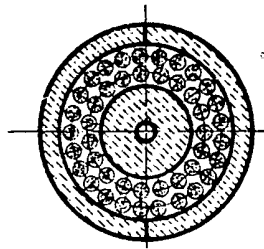

SECTION: B-B

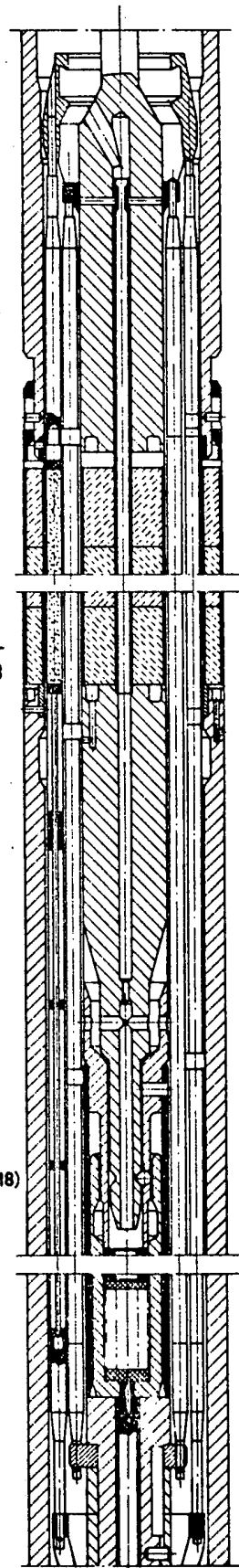

FUEL CHANNEL

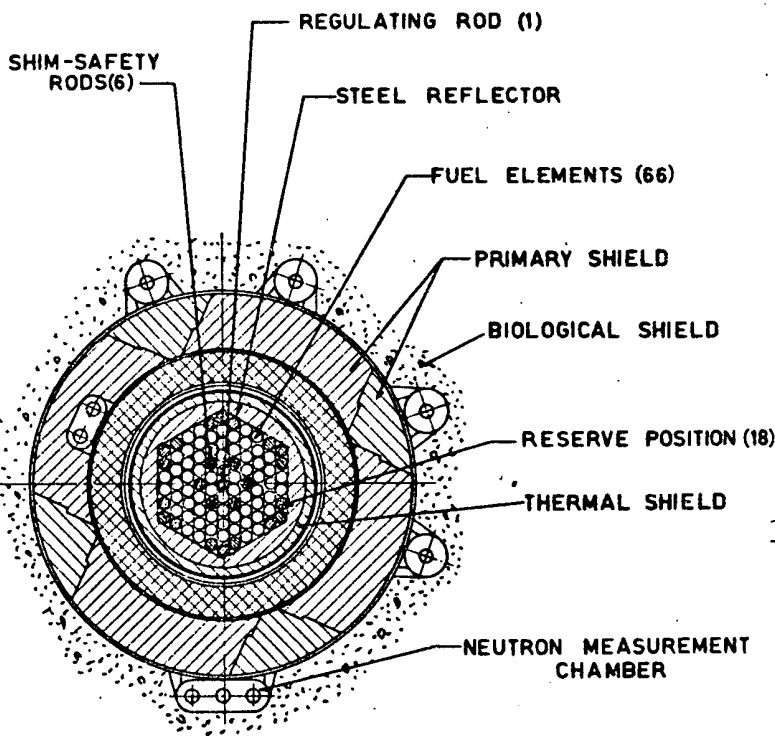

SECTION: A-A

REACTOR KNK

CORE

18. Shape and dimensions	Cylinder, 1175 mm diam., 1050 mm high	25. Burnup	10 000 MWd/t
19. Number of channels and sub-assemblies	91 channels	26. Fuel loading and unloading	Off load refuelling
20. Lattice	Triangular	27. Irradiated fuel storage	120 available positions below sodium storage
21. Critical mass	Not available		
22. Core loading at rated power	1.9 t UO_2	28. Refuelling schedule	835 kg U every 10 months for 10 000 MWd/t burnup or every 6 months for 6000 MWd/t burnup
23. Average specific power in fuel	30.5 kW/kg	29. Moderator	2.57 t zirconium hydride ($Zr H_{1.7}$)
24. Average power density in core	51 kW/litre	30. Blanket gas	Argon

FUEL ELEMENT

31. Form and composition	UO_2 pellets, 8.7 mm diam.	32. Cladding	X 8 Cr Ni Mo Nb 16 13 0.3 mm thick
		33. Sub-assemblies	None

CORE HEAT TRANSFER

34. Heat transfer area	13 650 cm^2 per fuel element 90 m^2 total	40. Heat transfer coefficient	58 000 kcal/ m^2 h
35. Heat flux	Average 15.2 cal/ cm^2 s Maximum 41.4 cal/ cm^2 s	41. Coolant mass flow rate	Through core 240 kg/s Maximum per fuel element 73 kg/s Average per fuel element 36.5 kg/s
36. Film temperature drop	10 deg C	42. Coolant temperatures	Inlet 361° C Outlet 351° C
37. Fuel element temperatures	Maximum fuel 2515° C Maximum cladding 580° C	43. Coolant pressures	Maximum 5.35 kg/ cm^2
38. Coolant flow area	29 cm^2 per fuel element	44. Hot channel factors	Temperature drop through fuel 1.13 Temperature drop through cladding 1.08 Temperature rise in coolant 1.24
39. Channel velocity	Average 2.7 m/s	45. Shut-down heat removal	Air cooling in secondary sodium system

CONTROL

46. Basic control features	Use of control rods	50. Scram time and mechanism	Delay time 1 s Rod drop by gravity fall
47. Control, regulating and safety rods	1 regulating rod B_4C , stainless-steel clad, also used as safety rod, 1050 mm active length 6 shim rods B_4C , stainless-steel clad, also used as safety rods, 1050 mm active length Total worth of regulating and shim rods $13\% \frac{\Delta k}{k}$ Speed of shim rods 2 mm/s Speed of regulating rods 4 mm/s	51. Sensitivity of automatic control	Automatic control effective at 30% power level
		52. Temperature coefficients	
		48. Other control features	53. Burnable poison
49. Reactivity addition rate	Maximum $10^{-3}\% \frac{\Delta k}{k} / s$	54. Other shut-down provisions	None

FLUID FLOW

55. Heat exchangers	2 sodium-sodium heat exchangers 210 m ² surface each Maximum pressure 5.35 kg/cm ² Maximum temperature 551° C Secondary sodium: 8.5 kg/cm ² 539° C	58. Pumps or circulators	2 mechanical free surface pumps driven by 2200-kW direct current motors
		59. Coolant losses and purification	
56. Primary circuit	2 loops	60. Decomposition and recombination	
		61. Cooling system safety	
57. Primary circuit piping	Material: 10 Cr Mo Ni Nb 9 10 Diameters: 200 and 400 mm	62. Fuel failure detection	

REFLECTOR AND SHIELDING

63. Reflector	Type 10 Cr Mo Ni Nb 9 10 steel, 1600 mm diam. 2300 mm high, 130 mm thick	65. Shielding	Radial thermal shield made of type 10 Cr Mo Ni Nb 9 10 steel, 160 mm thick
64. Radiation levels			

REACTOR VESSEL AND OVERALL DIMENSIONS

67. Form, material and dimensions	Cylinder 1900 mm diam., 10 155 mm high, wall thickness 16 mm Material 10 Cr Mo Ni Nb 9 10	70. Engineering features of reactor vessel	Operating temperature 551° C maximum Coolant flow rate 2 x 434 l Na/h Coolant inlet temperature 361° C Coolant outlet temperature 551° C Modulus of elasticity of steel vessel at operating temperature 16 500 kg/cm ² Coefficient of thermal expansion at operating temperature 14 x 10 ⁻⁶ /deg C
68. Working, design and test pressures			
69. Reactor with shielding	3800 mm diam.		

CONTAINMENT

71. Type and material	Steel cylinder 16 m diam., 27.5 m high, 15 mm thick	74. Surroundings		
72. Pressure	Working pressure 20—100 mm H ₂ O Test pressure 3.5 kg/cm ²			
73. Leakage rate	0.5%/d			

TURBOGENERATOR

75. Turbine	1 condensation turbine Steam conditions: pressure 80 kg/cm ² temperature 505° C 5 preheaters Turbine efficiency (including preheaters): 37%	77. Generator	1 three phase synchronous generator, 32 000 kVA cos φ 0.8, 6300 V, 50 Hz, 3000 rev/min
76. Condenser	1 condenser exhaust pressure 0.051 kg/cm ² cooling water temperature 21° C	78. Sub-station and grid	

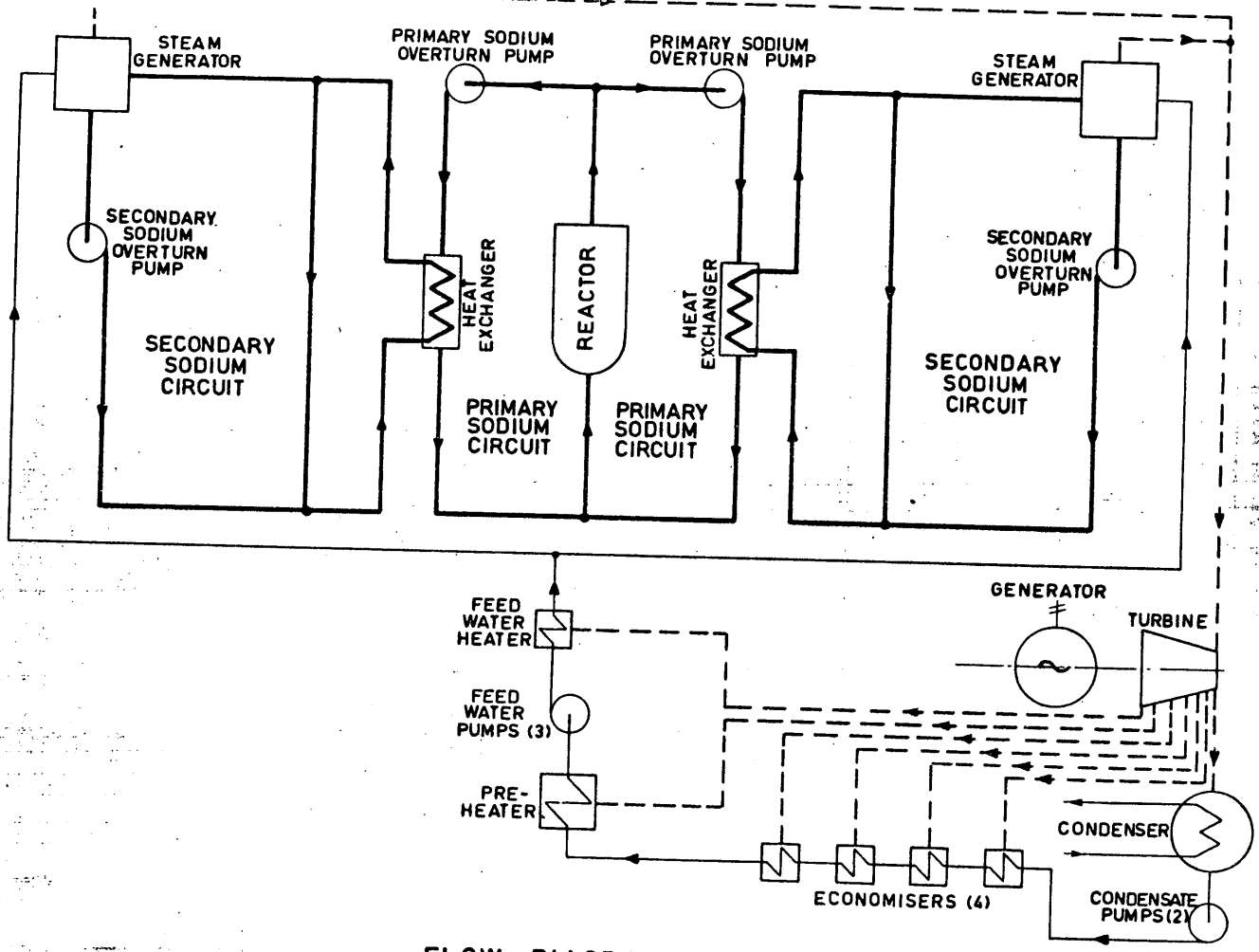

FLOW DIAGRAM REACTOR KNK

325
IAEA Power R. - KNK

Sanitized Copy Approved for Release 2010/09/01 : CIA-RDP88R01225R000100310003-2

COMMISSARIAT DE L'ENERGIE ATOMIQUE

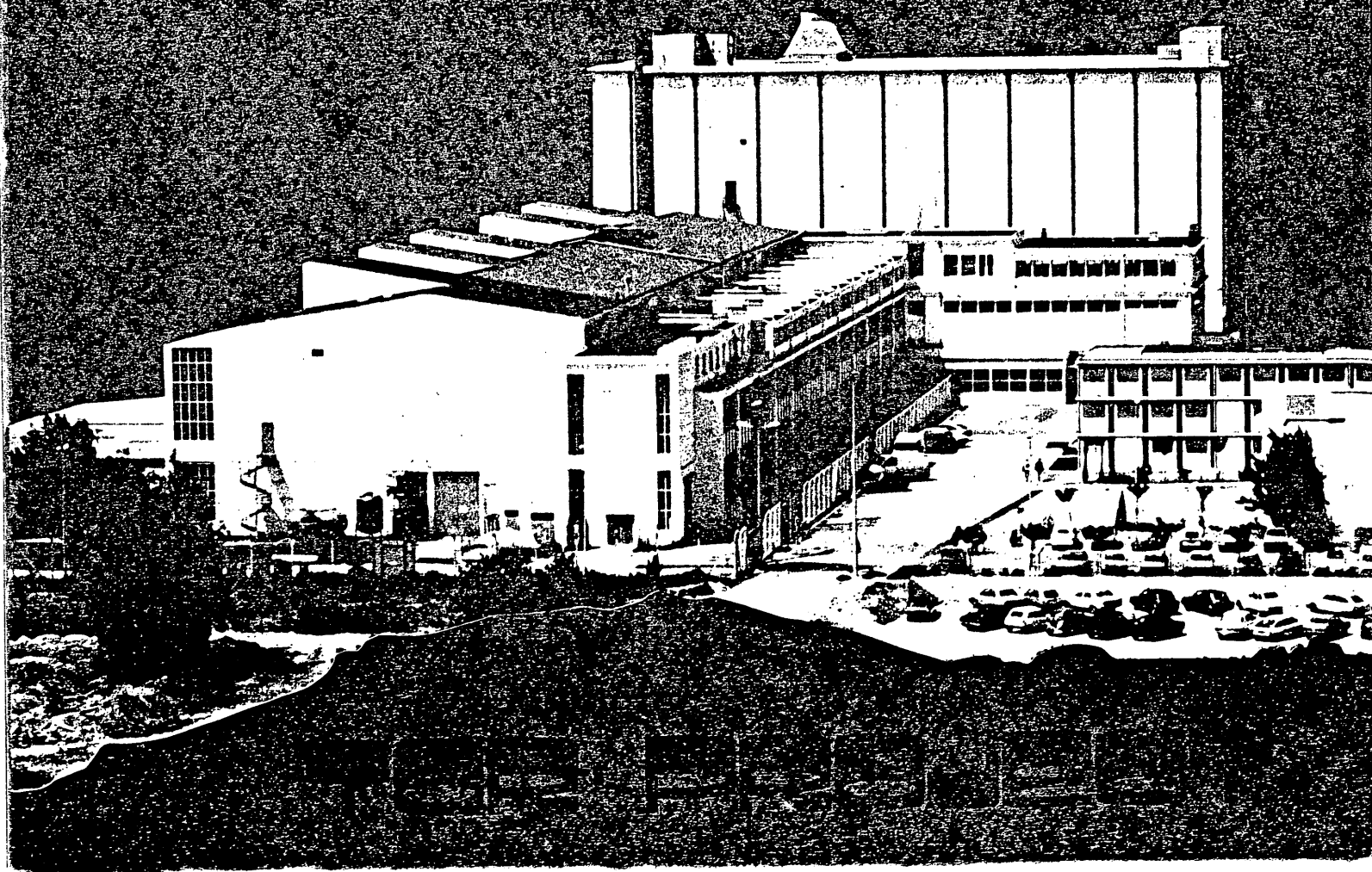

Sanitized Copy Approved for Release 2010/09/01 : CIA-RDP88R01225R000100310003-2

Sanitized Copy Approved for Release 2010/09/01 : CIA-RDP88R01225R000100310003-2

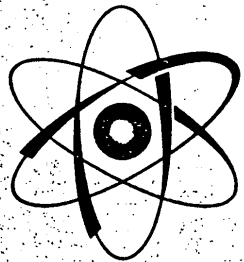

**FAST BREEDER
OXIDES
REPROCESSING**

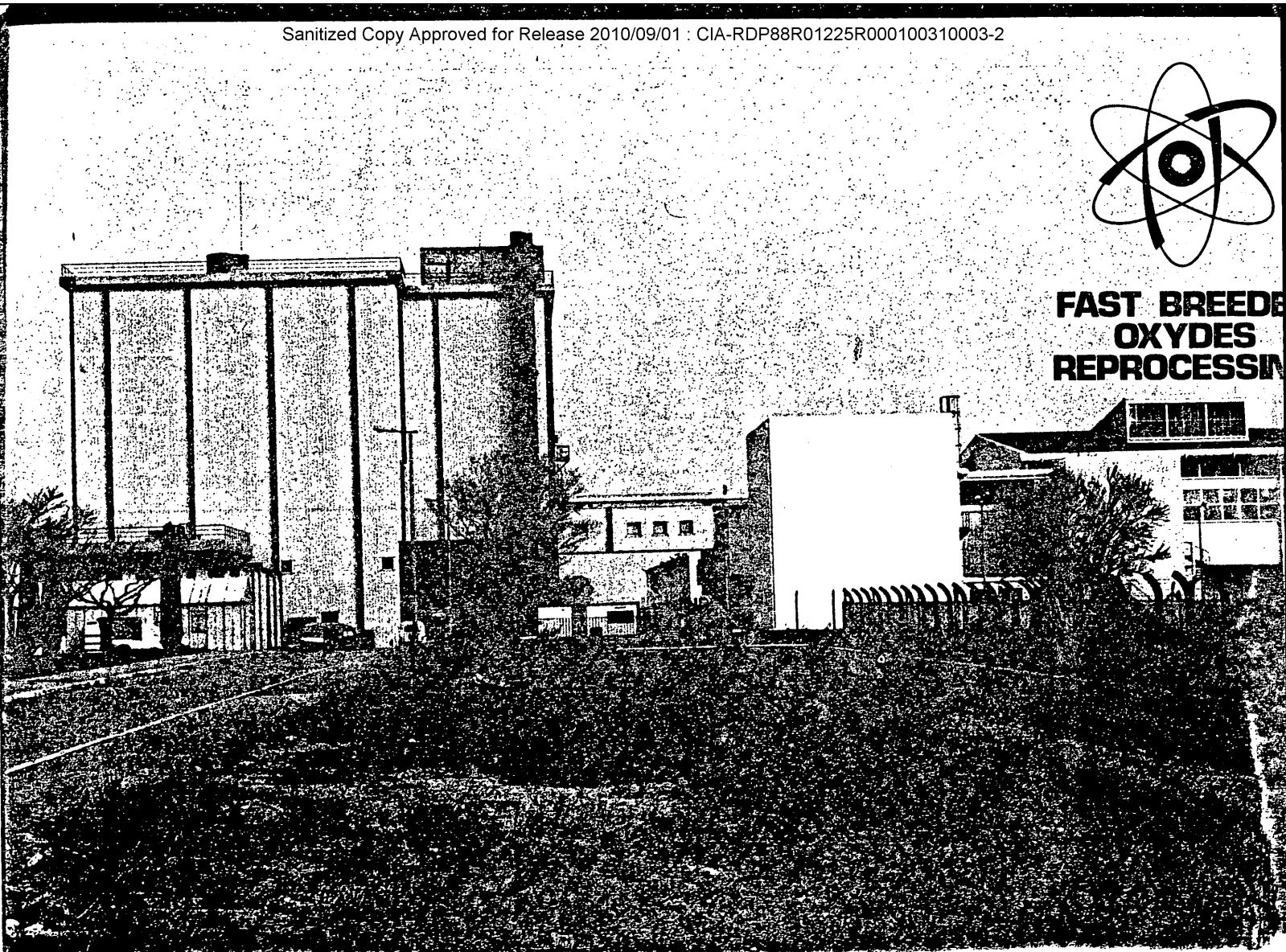

Sanitized Copy Approved for Release 2010/09/01 : CIA-RDP88R01225R000100310003-2

S.A.P. SECTOR LAYOUT

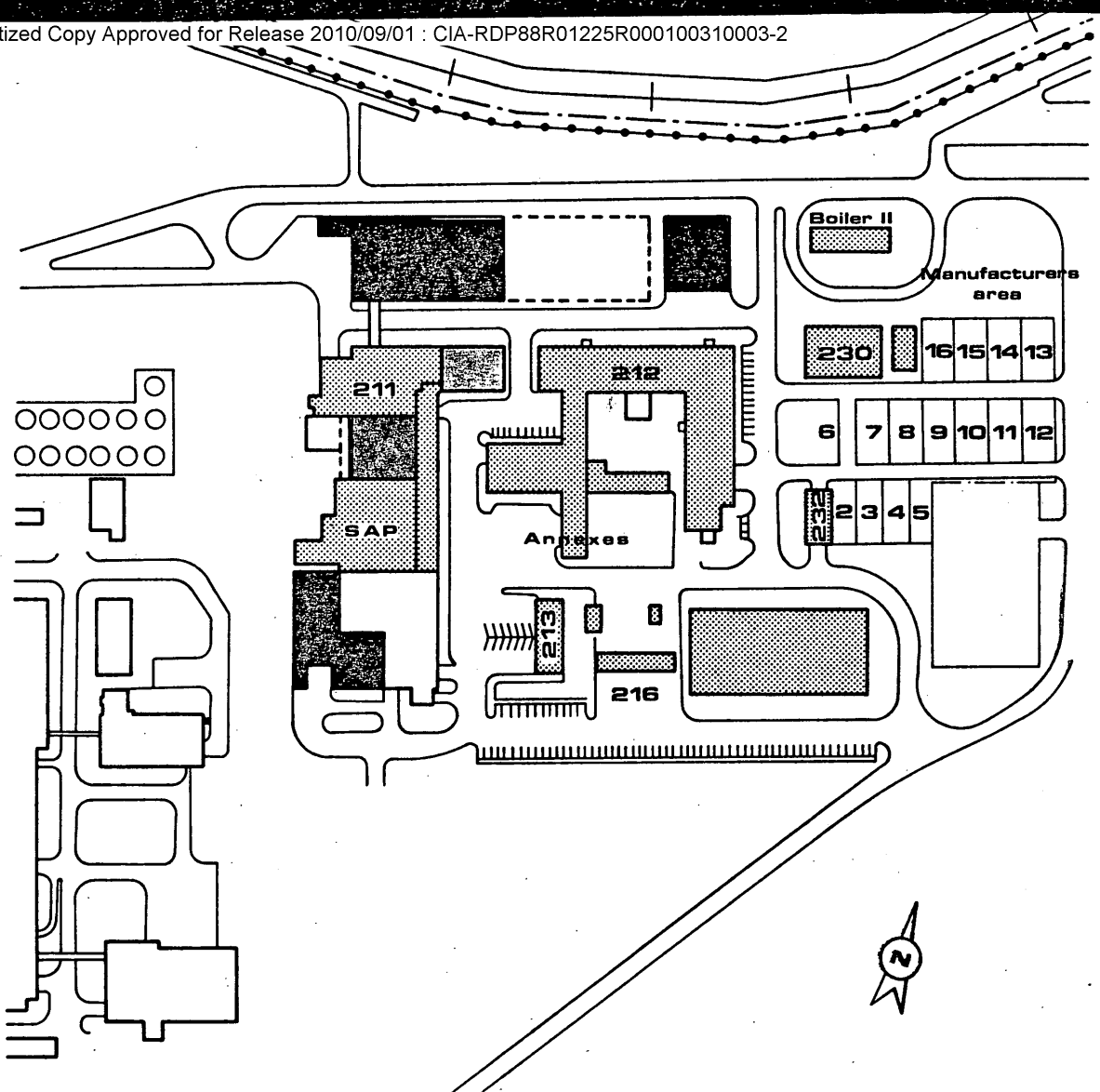

- TOR 1
- TOR 2
- TOR 3
- Test building
- Cost rooms



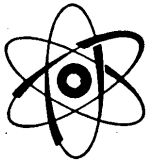

The TOR plant, capable of reprocessing 5 metric tons of fast breeder oxide fuel annually is scheduled to become operational in 1985. It is the result of a series of renovations, modifications and extensions of the existing pilot facility at Marcoule, France. The TOR program will complete the Phenix reactor fuel cycle and will constitute a valuable source of data and experience for designing future plants.

HISTORICAL BACKGROUND

The SAP (Pilot Facility Dept.) was set up in 1960 for spent fuel reprocessing, and has already been modified and extended by a new head-end (mechanical treatment cell and a dissolution) for operational reprocessing of oxide fuels. More than 9000 kg of oxides were reprocessed between 1974 and 1983, permitting recovery of 1300 kg of plutonium; the plant personnel acquired considerable process and technical expertise during this period. However, the throughput capacity and the research and development (R & D) potential of the present facility are too limited, and the decision was made to go ahead with the TOR program.

DESCRIPTION

The plant comprises three basic units :

- the TOR 1 head-end facility, separate from the SAP plant and equipped with highly remote controlled α , β and γ cells designed for mechanical processing, dissolution and clarification for both throughput and R & D purposes;
- the TOR 2 facility for finished products and uranyl nitrate storage
- the TOR 3 facility, consisting of the existing plant modified and completed by the following :
 - a new first extraction cycle,
 - a new fission product concentration unit,
 - a new uranium third extraction cycle,
 - Transfer systems between TOR 3 and TOR 1,
 - on-line analysis stations.

TOR PROJECT

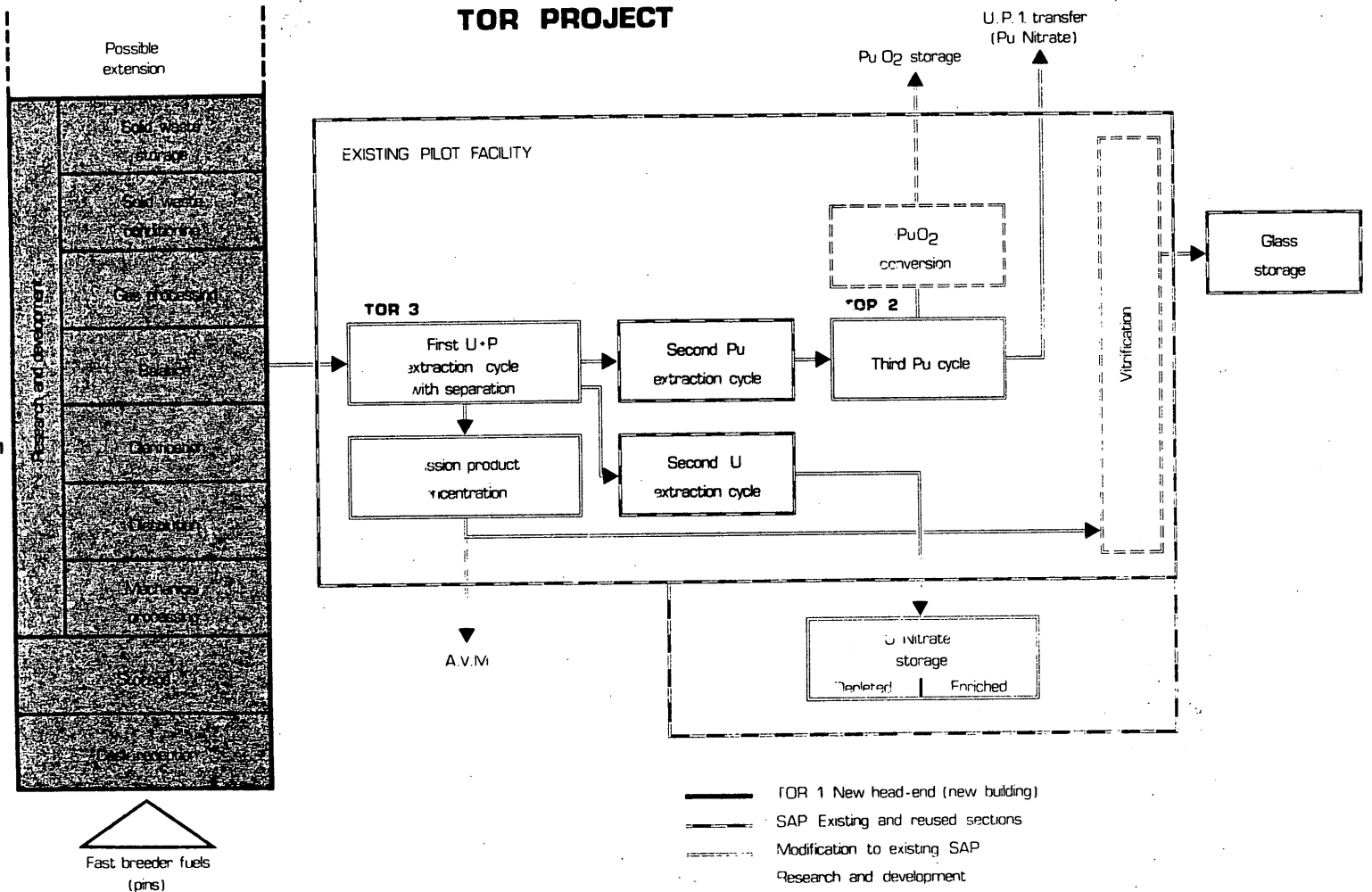

TOR 1 GRAPHIC OF THE FUNCTIONS

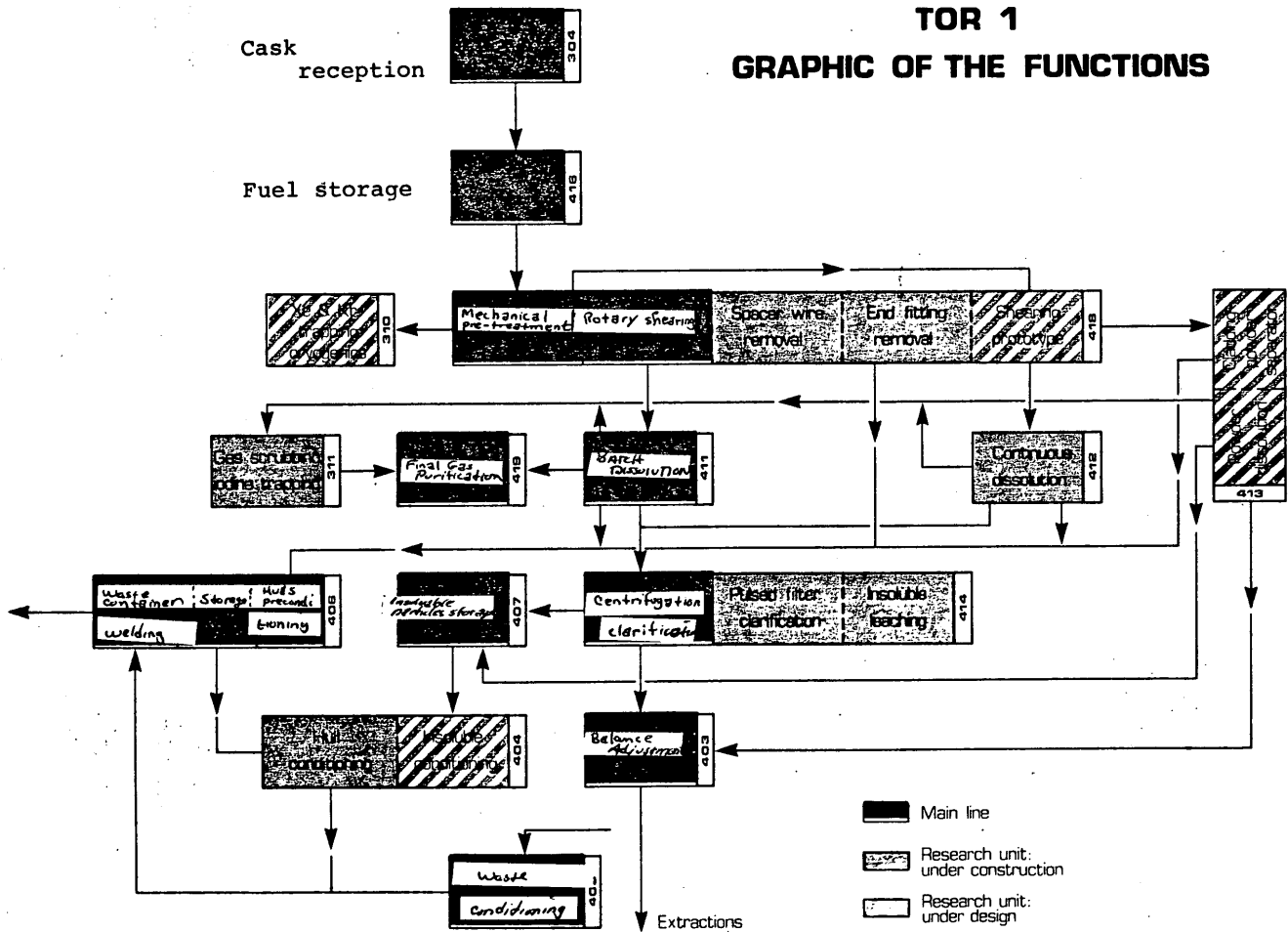

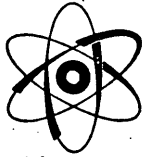

2. RELIABILITY

The question of reliability involves both equipment quality and optimum operating and maintenance procedures.

2.1. Equipment Quality

The main TOR line will only use equipment either already qualified for active service in the SAP or pretested in the TOR test facility. All materials used will have been tested for corrosion resistance and equipment will be built in compliance with the required quality assurance criteria.

2.2. Optimized Operating Procedures

On the basis of 20 years of experience with the SAP, the TOR plant is a completely new design that minimizes down-time during maintenance period and contamination hazards.

Operational hazards are reduced at the design level by provision for waste circulation inside red zones, i.e. without any cask transfer in maintenance areas, and by on-site conditioning of all technological and process wastes.

Extensive use is made of remote handling systems and servicing provisions.

TOR 1 MAIN LINE

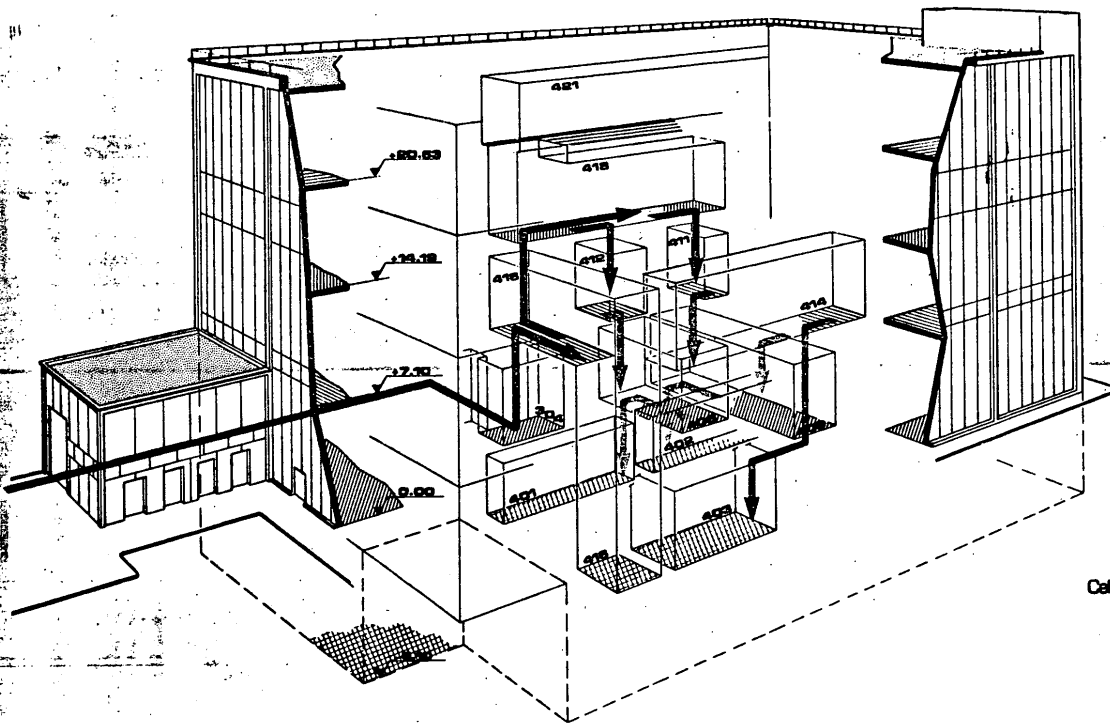

SOLID AND LIQUID FUNCTIONAL CIRCULATION

- Mechanical
- - - Chemical
- · · Waste

- Cell
- 304 Cask unloading lock
 - 416 Fuel storage
 - 418 Mechanical pretreatment
 - 411 Batch dissolution
 - 412 Continuous dissolution
 - 408 Hull conditioning
 - 409 Waste conditioning
 - 402 Waste container transfer corridor
 - 414 Clarification
 - 403 Clarification and effluent storage
 - 421 Maintenance corridor
 - 401 Removal corridor

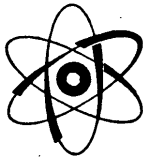

3. RESEARCH & DEVELOPMENT PROVISIONS

R & D facilities have been integrated in the TOR plant in two areas: the production line, and waste processing and conditioning.

3.1. Production

Mechanically, the production line was designed according to a modular concept based on component interchangeability and allowing testing of new equipment.

From a chemical standpoint, the plant was designed so that a number of subsystems can be connected to the main line; these include provisions for continuous dissolution (DCH), pulsed filter clarification and iodine trapping.

The final design is the result of a number of trade-offs between the operational advantage of having the R & D section fully independent of the main line, and budgetary or space limitations that prevent excessive redundancy.

The R & D subsystems will be operated under radioactive conditions on actual fuel after prior inactive operation before being connected to the main process line. The corresponding main line module will then be shut down and placed on standby to resume operation in the event of a malfunction in the test R & D unit.

3.2. Waste Processing and Conditioning

Internal storages will be provided to separate the waste processing and conditioning operations from the production line. Cells with extensive remote handling systems will be provided to develop new techniques under active conditions; e.g. solidification of solid wastes (cladding hulls), cutting up and conditioning of scrap material for removal from the site in suitable form for shipment to a permanent storage facility.

TOR 1 SCHEMATIC

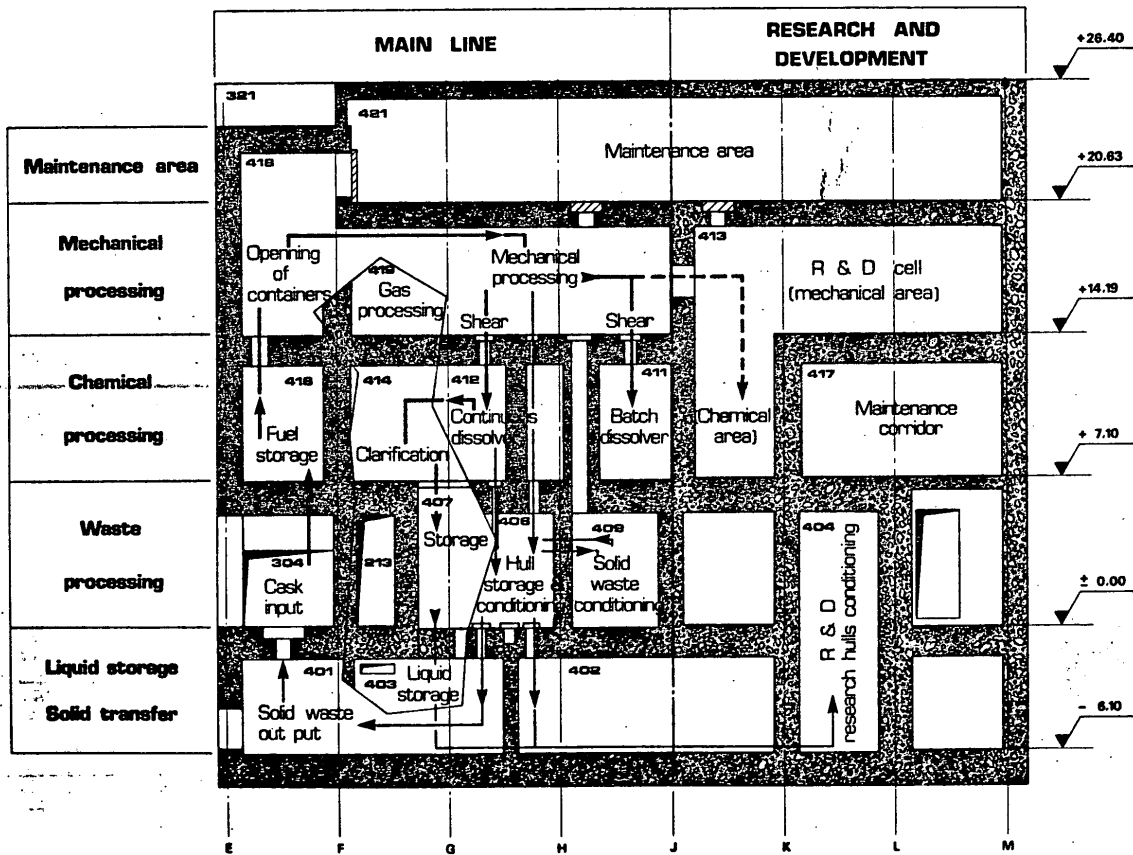

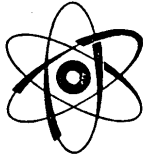

CONSTRUCTION

The TOR plant is being constructed by an integrated work force consisting of CEA personnel from the DERDCA (Applied Chemistry, Wastes and Reprocessing Research Division) and personnel from the Société Générale pour les Techniques Nouvelles (SGN). The program is headed by a CEA project chief and an assistant from the SGN.

CONCLUSION

The TOR facility is designed not only for demonstrating fast breeder fuel reprocessing techniques but also for designing and qualifying new active processes and equipment. This will be achieved through long reprocessing campaigns and by extending the facility with research and development units related to new processes or technologies.

**SOME
PARTICULAR
EQUIPMENTS**

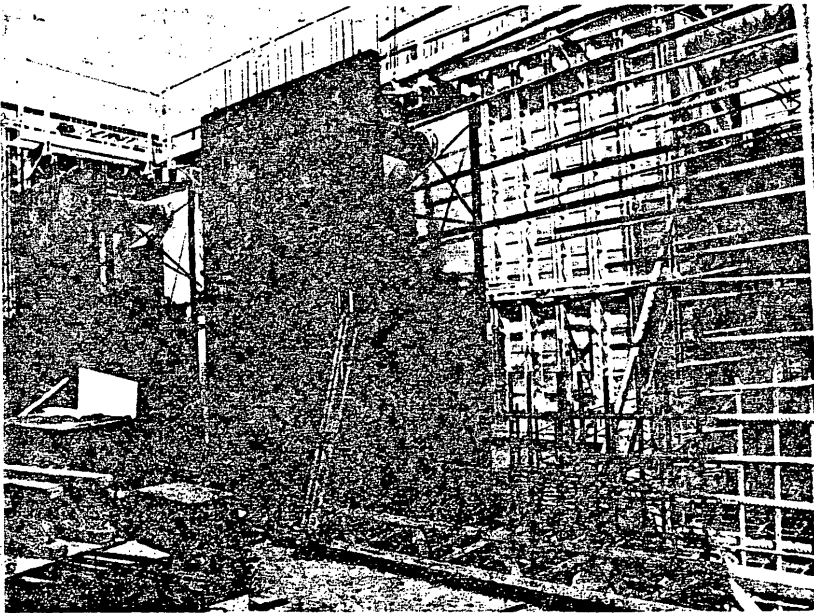

**Level - 6.10 - Cell S.404 (inserts)
Working area**

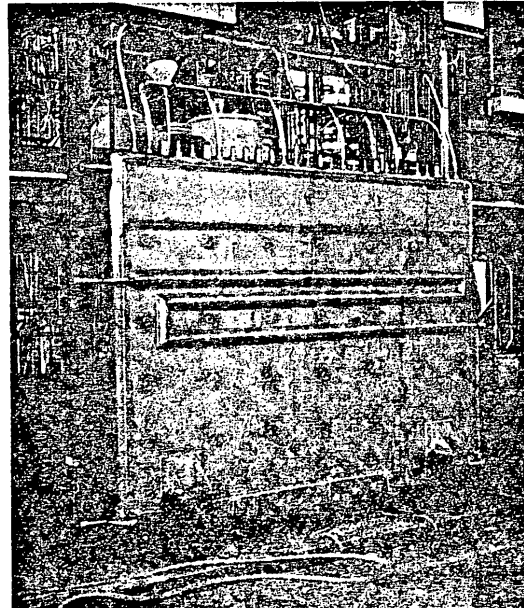

**Test building 215
Slab undergoing test**

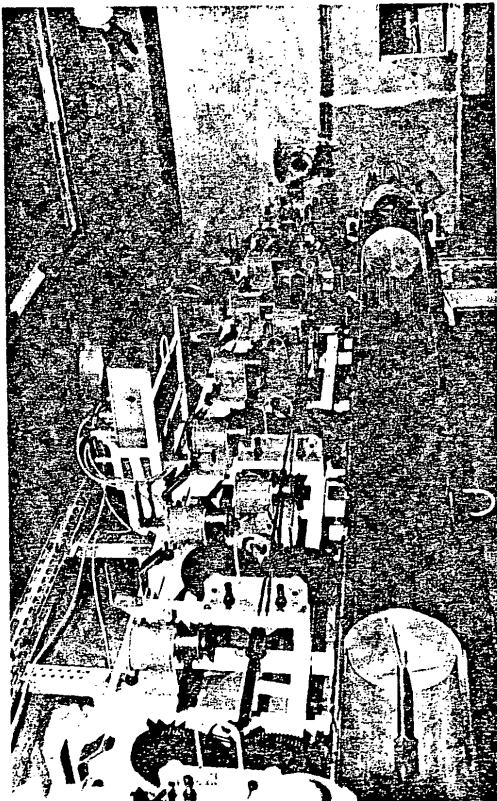

**Mechanical line
Pin transfer**



**Chemical line - Cell S.403
Liquid waste storage**

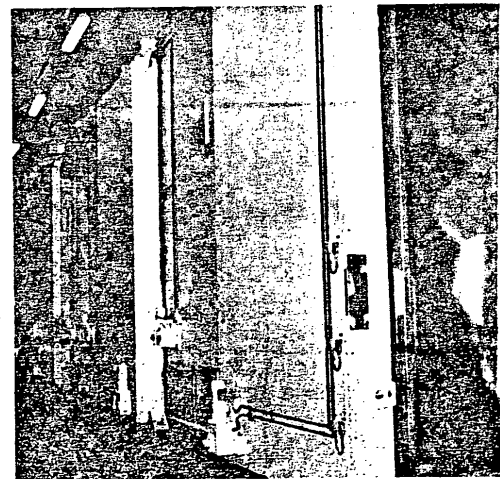

**Corridor 1.410
Access to solid waste treatment cell**

TOR 3

The first extraction cycle and the fission product concentration in TOR 3 have been installed in a SAP cell recovered after decontamination and dismantling. This cell was upped by one meter (tightness and shielding of the box). The works in controlled area have been limited thanks to a 10-ton prebuilt module concept for the chemical installation.

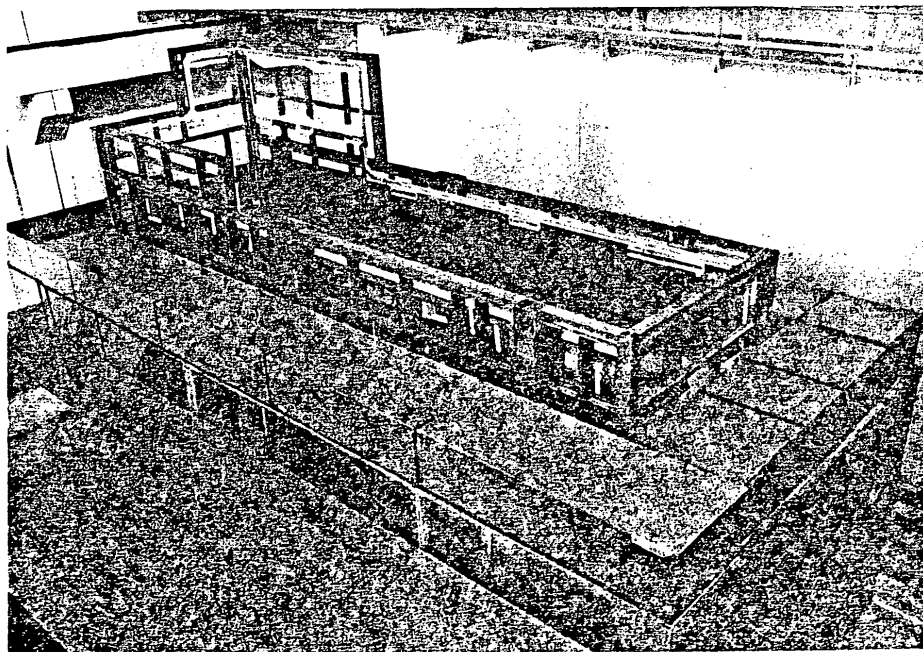

cell roof (raised)

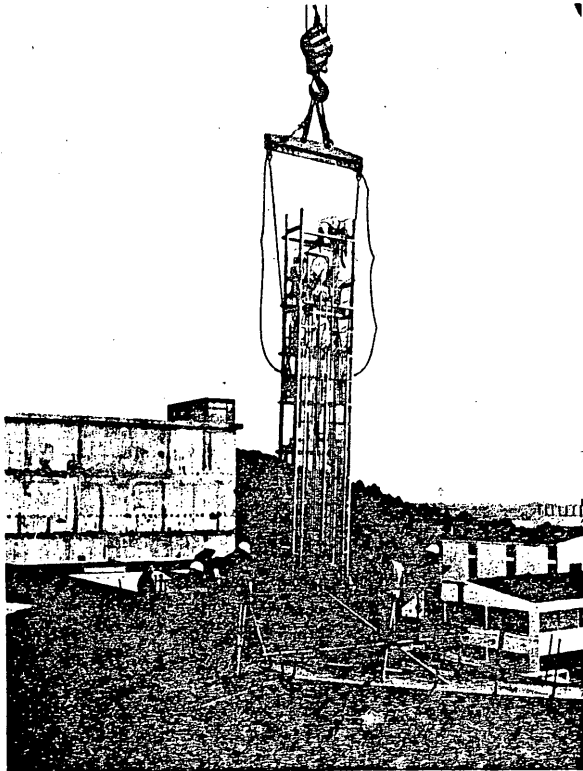

Introduction of one among

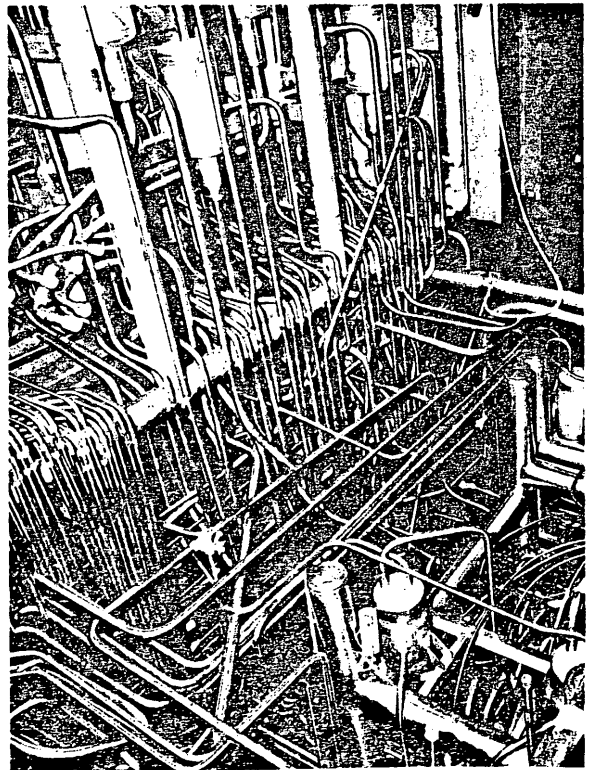

Top view of the inner of the cell 61

INDOOR VIEW POST THE RENOVED CELLS FOR TOR PROJECT



Building 211 : cells top view

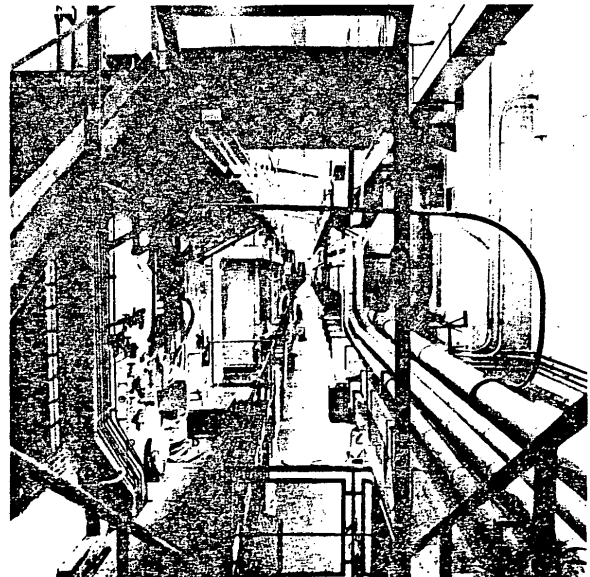

Building 211 : view of hall

APPENDIX 7

Translations from CEA/COGEMA Reports

PLUTONIUM PRODUCTION FROM REPROCESSED FUEL, 1957-1970

Paris CEA ANNUAL REPORT 1957-1970 in French

[1957, pp 35-36]

[Excerpt] The industrial operation of the G1 reactor

(industrial architect: la Societe des Forges et Ateliers du Creusot - SFAC)

began 21 January, 1957, after checking the effectiveness of the repairs resulting from the incident that occurred at the end of 1956. A break in the cladding of a uranium fuel element had caused the partial combustion of this fuel element. In February, an incident in the electrical network feeding the blowers caused two motors to go out of service and the reactor to operate at reduced power for several weeks. In June, tests made it possible to define a cladding shape from which a clearly improved heat exchange coefficient was expected. At the beginning of the summer, the reactor was shut down for the first active decladding tests. The reactor then resumed its operation with a utilization factor on the order of 92 percent.

The experimental power plant runs smoothly, supplying 1200 to 1500 kW of electricity. This current is considered only as a recovery of energy, making it possible to study the design of the future large electronuclear power plants, because the main function of G1 is to supply plutonium.

The decladding lines perfected in July and August 1957 were able to assure the decladding of more than 300 inactive fuel elements by 20 September. The decladding operation on the first active G1 fuel elements began on 24 September. Because of the deformation of the spent fuel elements, difficulties arose which forced the modification of the machines. For the most deformed fuel elements, the decision was made to perform storing and decladding under water, an operation requiring construction of a pool which was completed on 20 December.

The civil engineering work on the G2 reactor ended. During the second half of the year, work began on the assembly of internal mechanisms of the chamber, on carbon dioxide lines and electrical installations. The chamber was finished and the prestress cables were stretched. The internal assembly of the chamber was very far along and stacking of graphite, whose machining was completed in October, can be undertaken in the first quarter of 1958.

The first G2 criticality is planned for July 1958. It will be followed by hydraulic tests of the G3 chamber, then by pneumatic tests of the chamber and circuits of G2. This procedure, which seems slightly complicated, saves, because of the similarity of the reactors, the hydraulic testing of the G2 chamber and makes it possible to gain considerable time. G2 should be set up by the end of 1958.

The repercussion of the budget constraints for the year on the G3 planning should considerably increase the gap of six months initially planned between the criticality dates of the two reactors.

Each of these two plutonium reactors will provide an electrical power production widely exceeding the needs of the Marcoule Center: on the whole, 50,000kW will be brought to the EDF grid.

The industrial architect of the two twin G2 and G3 reactors is the Societe Alsacienne de Constructions Mecaniques (SACM); as such, it assumes coordination of the implementation studies, the controls, assembly and tests. The member companies of the Groupe France-Atome are participating in the G2 and G3 construction they participated in those of the previous G1 and EL3 reactors.

[1959, p 35]

V. Plutonium

[Excerpt] To obtain, in the desired time, the amount of plutonium required by the AEC civilian and military program, a very tight schedule had to be maintained, 1959 being the first year of significant production.

Plutonium is formed in the uranium rods of the Marcoule G1 and G2 reactors during their operation.

The extraction of the plutonium comprises essentially three phases: decladding of the fuel elements; extraction itself; and purification and transformation into metal, completed by recovery of the metal contained in the slags.

[1959 p 37]

1. Decladding of G1 and G2 Fuel Elements

[Excerpt] Since the chemical separation process for plutonium is not able to adapt itself to dissolving--at the same time as the mass of fuel--the magnesium claddings which surround it during its irradiation in the reactors, a decladding operation, intended to extract the uranium from its cladding, must be performed

between the exit of the fuel from the reactors and its entry into the chemical processing plant.

An entire load of uranium from the G1 reactor was decladded in the so-called "pilot decladding" installation between 23 February and 31 August 1959. The fuel elements were stored under water for three months to allow the radioactivity to decrease. The daily capacity for decladding continued to increase. This pilot installation is now in the process of disassembly, as a result of the final decladding installation intended to process the G1, G2 and G3 fuels going into operation.

Several dozen tons of G2 fuels in containers were transported hydraulically by an underground pipe to a storage pool. During the "cooling" of these fuel elements in the pool, inactive tests of the decladding shop followed one another before introducing the active fuel there.

The production operation began on 25 October and was completed on 28 January, 1960, for the first unloaded lot of G2. The rate of production was interrupted by incidents which indicated the need to make modifications in the installations which will be undertaken during the interruption of the decladding corresponding to the shutdown of G2 for several months.

At the same time, the pits for unloading and decladding of the G1 fuel elements were equipped.

2. Extraction and Purification of Plutonium

The plant for extraction of plutonium (industrial architect: Saint-Gobain) had been started up in July 1958, but the shop for purification of plutonium was

still unfinished. This shop was ready on 15 January 1959 and only at that time could the manufacturing be resumed, this time by linking extraction and purification. The experience of the second half of 1958 had made it possible to define the modifications whose validity was also confirmed by the Geneva Conference in September and which were applied at the beginning of 1959. The main points of these modifications related to circuits of solvents for the main extractions and the ion exchangers for purification of the plutonium.

But it was found that improvement of the rate of the dissolution shop was essential, which was obtained as a result of new modifications made during a shutdown in the operation from 4 May to 6 June. At the purification shop, the first ingot of metal was obtained from oxalate on 20 February under satisfactory conditions. But there again, improvement of the rate proved necessary; it was obtained as a result of multiple modifications of detail made from the month ...

[1959 pp 83-85]

III. Reactors for Production of Plutonium and Power

A. G1 Reactor

[Excerpt] For the Marcoule G1 industrial unit, 1959 was marked by two essential facts: 1) intensive operation from January to September, interrupted by monthly unloadings of fuel and 2) the preparation and execution of the annealing of the graphite stack from 25 September to 9 December, 1959.

Except for the time necessary for the unloading of the fuel elements and for the annealing of the graphite, the G1 reactor ran at a 97 percent operating rate.

The unloading operation was performed at a rate of one unloading per month for the first seven months of the year; it was marked by a single incident.

The preparation for the annealing began during the unloading operation in the form of operations for core samplings of graphite and of tests on the blowing circuits. The graphite samplings indicated a stored energy greater than anticipated and resulted in the shutdown date for the reactor being moved up to 25 September, 1959.

After preparations and preliminary tests, the operation began with a nuclear preheating. Then, turning the heaters on caused the thermal shock that brought about the start of the annealing which ended adiabatic, then blowing of air was resumed. This operation gave satisfactory results.

At the same time as restoring the reactor to order after annealing, a revamping of the thorium network was performed to modify the flatness of the flux, and thermocouples were placed in the mass of the graphite, experimentally, in two channels. The flatness of the flux provided a gain on the order of 8 to 10 percent to the power output. The graphite mass thermocouples make it possible to have readings on the temperature of this mass up to the vicinity of the air intake slot.

On 9 December the reactor was started up again for a new production operation which in the normal course of events should be completed in mid-1960.

B. G2 Reactor

The set up of the Marcoule second reactor, begun at the end of 1958, was completed at the end of April 1959. The circuits and installations as a whole were tested

cold and under air pressure for a long time to allow them the delicate and meticulous adjustments. Then, after filling the circuit with 500 cubic meters of carbon dioxide of nuclear purity up to a pressure of 12 kg cold (or 15 kg for the power tight reactor), the hot nuclear tests and the set up began.

One of the last phases of the set up was the "adjustment of the gate valves" which makes it possible to adjust the flow from each channel to the neutron flux that it undergoes.

During this entire operation, the prestressed concrete chamber, a huge cylinder with a wall 3 meters thick, 14 meters inside diameter and 18 m long--this exceptional structure which constitutes one of the main original features of G2--performed in an entirely satisfactory manner.

Since 22 April 1959, the G2 turbogenerator group has delivered current of nuclear origin over the lines of the general EDF grid. The compressors of the reactor, driven by steam turbines are fed directly from heat exchangers made famous under the name of "atomic millipede." The thermal power output of the reactor has reached its nominal value of 200 megawatts and the electric power delivered has exceeded 28 megawatts. It had been decided that the design of G2, plutonium-generating reactor, would be such that the unloading of the spent fuel and its replacement with new fuel elements could be done with the reactor working, which had not yet been done in any country. This unloading operation with the reactor working was performed successfully starting on 20 July, 1959.

However, an incident necessitated the shutdown of the reactor during which various modifications were performed which had been proven necessary during the

first months of operation, particularly on the inside of the chamber for the flow of the carbon dioxide gas.

With these various tests ended, the preliminary operations for a new filling of carbon dioxide gas in the airtight enclosure began on 23 November. After a general inspection for the detection of a break in claddings, the power output of the reactor was gradually raised at the same time as the pressure of the carbon dioxide gas. The thermal power output of 200 megawatts was again reached, starting 10 December. This second period of operation has shown the effectiveness of the modifications made on the inside of the chamber to make a hot spot disappear. The input temperature of the carbon dioxide current in the peripheral channels was able to be raised to reach that of the center of the core (140 to 145 degrees).

The magnesium-zirconium alloy claddings of the fuel elements have been completely satisfactory.

On 14 December, a handling error having caused the melting of the cladding of several fuel elements, the reactor was immediately shut down.

C. G3 Reactor

For the G3 industrial unit, 1959 was the year of the final assembly, the first tests and the installation of equipment and personnel before the set up. The industrial architect of the two Marcoule twin reactors G2 and G3, was the Societe Alsacienne de Constructions Mecaniques (SACM). The member companies of the Groupe France Atome participated in the construction of G3; they participated in those of the preceding G1, EL3 and G2 reactors.

On 1 January 1959 the civil engineering was nearly completed. A large part of the machines and pipes were in place. The concrete chamber was also ready but empty. January was especially devoted to stacking of the graphite. At the end of the stacking, the chamber was finally closed and the last prestress cables stretched.

At the same time, the assembly of the large pipes for carbon dioxide being used for cooling was completed and they were tried at a pressure of 24 kg per square centimeter. With the airtight enclosure completed, new tests were performed.

The G3 reactor went critical on 8 June, 1959. Various tests for blowing mild air were performed in July, August and September on the fully loaded reactor to determine the modifications to be made, both for G2 and G3, to improve the gas flow and to eliminate a hot spot. The corresponding modifications were made both on G2 and on G3. Simultaneously, various modifications were made to the detection of cladding breaks.

The test for resistance of the overall installation to an air pressure of 24 kg per square centimeter was performed successfully at the end of December.

[1960, unnumbered page]

V. - Plutonium

[Excerpt] Urged on by the requirements of the military program, the production of plutonium at Marcoule in 1959 made use, as much as possible, of the G1 reactor whose industrial amounts of spent uranium were reaching maturity before those of G2 and G3 which were to be set up only in 1959 and 1960 respectively.

On the other hand, the plutonium extracted in 1960 came exclusively from the G2 and G3 reactors.

A. Decladding of the Fuel Elements of G2 and G3

Since the temporary installation in which the G1 fuel had been decladded in 1959 was finally abandoned, the new shop ...

[1960, pp 117-118]

[Excerpt] ... the pressure tube are interposed a guide tube and a thermal insulator intended to prevent excessive heating of the pressure tube. The study of these two elements is under way.

The location of the reactor was selected in 1960 at the site known as Monts-d'Arree (Finistere), property of EDF.

The first work was done there. Soil testing and various hydraulic and meteorological studies made it possible to define the limits of the terrain accurately. The AEC will be the tenant at the site of the construction of EL4. If the system proves advantageous, EDF will construct the following reactors.

III - Reactors for Production of Plutonium and Power

A. G1 Reactor

For the entire year of 1960, G1 operated without interruption other than the one corresponding to an unloading operation in autumn.

This quite remarkably smooth operation, combined with the fact that no shutdown for release of Wigner energy accumulated in the graphite stack was necessary in

1960, made it possible for G1 to break its annual production record considerably this year with a figure of 300 million kWh thermal.

A new type of fuel elements for uranium began to be loaded in the reactor in October. This type, comprising a magnesium cladding with 18 longitudinal cooling fins instead of 8 for the former cladding, is intended to replace the former fuel element model entirely. It will make it possible to assure the operation of the reactor at the same power with three cooling air blowers in service instead of four.

The observation, by sampling of graphite cores, of the conditions for the accumulation of Wigner energy in the G1 stack made it possible to clarify considerably our knowledge of this important phenomenon for the graphite-moderated power reactors whose development in France will be assured by the EDF reactor.

B. G2 and G3 Reactors

G2 and G3 are graphite-moderated natural uranium reactors cooled by carbon dioxide under a pressure of 15 kg per square centimeter. The nuclear part of each reactor is enclosed in a prestressed concrete chamber.

Supplying the reactors with carbon dioxide has sometimes been difficult because of shipping problems and competition with the other users of this gas (particularly breweries). An effort was made to reduce the gas leaks as much as possible and in fact, during the year, was quite successful. Further, additional storage of liquid carbon dioxide placed under construction in 1960 will be completed in 1961.

[1961, p 36]

5. Plutonium

[Excerpt] Plutonium continued to be regularly produced in 1961 at the Marcoule Center. If it could be said that 1960 was the year this plant reached maturity, 1961 was the first year of full production, the year which saw the plutonium extraction plant draw alternately from the spent uranium stocks from the three G1, G2, G3 reactors the last of which did not begin substantially to unload its fuel until the end of 1960.

A. Decladding of the Fuel Elements

Further improvements made to some installations of the decladding shop during its shutdown periods in 1961 make it possible now to anticipate its completely smooth running to meet the demands of the dissolution shop of the plant.

One of these improvements consisted in equipping the third and final pit available for the decladding of the G2 and G3 fuel elements with opening and decladding machines. The capacity and the operating safety are thus considerably increased.

Moreover, an expansion of the decladding building built in 1961 facilitates the handling of the drums of spent uranium and, in addition, will allow the possible reception, decladding and processing at Marcoule of fuel irradiated in the EDF reactors at Chinon.

[1961, pp 98-99]

2. Reactors for Production of Plutonium and Power

A. Operation of the Reactors

1. G1 Reactor

[Excerpt] Replacement of fuel elements with 8-fin claddings with those of the 18-fin type which can be done only slowly, as the fuel of this specific low-power reactor matures, led to a certain reduction in the operating power of the reactor in 1961, a year marked also, on 4 June, by a particularly successful operation for release, by annealing, of the Wigner energy of the graphite stack.

The experience of the first two operations performed respectively in 1958 and 1959 made it possible to reduce to 25 days the time for the shutdown of the reactor for the third operation of 1961, whereas the first two had caused operating interruptions of 105 and 75 days.

The operation of the reactor remains entirely satisfactory.

2. G2 and G3 Reactors

These are now the "big producing" Marcoule reactors and their performances for 1961 approach approximately the maximum that is expected of them.

The fuel cladding has continued to show exceptional qualities which are indicated particularly by an extremely reduced frequency of claddings breaks that require the unloading of the corresponding fuel element. In the very rare cases of observed cladding leaks, the system for detecting cladding breaks always functioned with excellent speed and sensitivity which made it possible to avoid any harmful consequence.

Improvements continue on the chambers for unloading the fuel and on the locks for the plugs of the uranium channels which should result in the elimination of several difficulties still encountered on these two important categories of mechanisms.

Finally in 1961, the two reactors were able to operate for long periods at a thermal power 15 percent greater than the maximum power for which they were designed.

The EDF power plants associated with the G2 and G3 reactors have operated normally.

[1962 p 34]

5. Plutonium

[Excerpt] The production of the Marcoule plutonium extraction plant increased considerably in 1962.

This result, which was subject to a prior improvement of the rates of production and of unloading of the G2 and G3 reactors, is connected moreover to the gradual elimination of various limitations of capacity and to the development of intervention methods and maintenance work in a highly contaminated atmosphere. The experience acquired during preceding years directed the efforts of the operators mainly on the shop for the dissolution of uranium. The nature of the processed fuel elements, the conditions for carrying out the dissolution operation limit the life of some pieces of equipment of this shop. It is therefore necessary, either to modify their characteristics to prolong their

service life, or to provide for their periodic replacement as a preventive measure.

The development and execution of these operations, which are made particularly delicate by the radioactive contamination of the shop and the equipment it contains, however, have made it possible to assure a satisfactory continuity in the operation of the dissolution and to improve considerably its overall efficiency.

Simultaneously, the decision was made to construct a new dissolution shop scheduled to go into service in 1964. This decision has led to conducting studies and to performing experiments, which have proven decisive, on a continuous dissolution process which will be considered both for the dissolution shop of the La Hague plant and for the new shop at the Marcoule center.

The extraction sequence used since the beginning has worked extremely satisfactorily, which confirms the value of the design of its batteries of mixer-decanter.

A new purification shop, whose construction had been decided in 1959, was put into industrial operation in 1962. Its production characteristics, homogeneous with those of the future dissolution shop and of the second modified extraction sequence, from now on assure the desired production safety.

[1962, pp 108-110]

2. Reactors for Production of Plutonium and Power

A. Operation of the Reactors

1. G1 Reactor

[Excerpt] Regularity of operation is one of the dominant characteristics of this reactor. Built in 1955-1956, set up in 1957, it is ending its sixth year of industrial operation in 1962. On 31 December 1962, it reached a maximum power of 42.5 MW, the power released during the year being 12,392 MWd, or a total of 59,630 MWd since the beginning of operation.

The objectives which were initially assigned to it -- fast supply of a significant amount of plutonium, testing of a new technique on an industrial scale -- led the builders to consider operating characteristics which have been greatly exceeded by the G2 and G3 reactors.

Despite its modest yield from now on in relation to these latter, it is kept in a normal operating state. Actually, it supplies the production contribution necessary to satisfy the expressed need; on the other hand, it makes it possible to gather useful teachings, particularly on the long-range behavior of the graphite moderators. Thus, the measurements made on the samples removed during 1962 made it possible to slow down the speed of the operations for release of the Wigner energy by annealing.

Tests were made on the shape of the fuel: the old fuel elements with 8 fins were fully replaced by fuel elements with 18 fins to improve the uranium-air thermal exchange.

The unloading installation has undergone profound modifications which make it possible to increase the safety and the speed of the operations for unloading and for conveying the spent fuel to the storage pool.

The G1 production was thus slightly improved in 1962.

2. G2 - G3 Reactors

As far as these reactors are concerned, 1962 was marked by serious progress, on the one hand, in the matter of loading and unloading of the fuel, and, on the other hand, in the matter of production.

The fuel used during the first years of industrial operation -- since 1959 for G2 and 1960 for G3 -- became gradually deformed under the action of the irradiation, then causing difficulties during unloading operations. Several solutions had been considered to eliminate this defect. Tempering the uranium rods before cladding -- the solution finally accepted -- has been performed on an industrial scale since the beginning of 1961.

But 1962 was the first year when the reactor fuel was fully composed of rods processed according to the process indicated above, a process which furthermore had been improved in the meantime.

On the other hand, various pieces of equipment being used for the unloading operations underwent modifications which improve safety and efficiency. Thus, the loading chambers and the locks for the channel plugs were changed or modified.

The loading operations since then are performed under excellent conditions and at an improved rate.

Moreover, the operating regularity of the reactors is also considerably improved and a more accurate knowledge of the conditions and operating characteristics

have made it possible to bring the thermal power of each reactor from 210 to 235 MW since the beginning of 1962.

Studies which were continued during the year, dealing with a suitable improvement of the neutron flux inside the reactor, make it possible to expect a new gain of about 15 MW.

In conclusion, although improvements are still possible or necessary, particularly in the field of maintenance for the refrigeration circuit, it can be considered that the results of 1962 confirm the advantage, for a plutonium-generating reactor, of the horizontal arrangement of the channels and of their loading and unloading while operating.

B. Study and Design of New Reactors

Studies of Systems

1. Pressurized Gas - Graphite - Natural Uranium System

a) EDF Nuclear Power Plants

The AEC continued to provide its assistance to EDF for the three EDF 1, EDF 2, EDF 3 power plants under construction at Chinon.

1. EDF 1 Power Plant

The EDF graphite stacking, performed under the responsibility of the AEC, was completed at the end of March. The first criticality of this reactor took place on 16 September with a reduced load: loaded 365 channels out of a total of 1,148.

In addition to its intrinsic value, this test made possible a final adjustment of the measuring equipment which will be used during the tests which will precede the set up. The AEC provides its cooperation to the EDF for the preparation and use of these tests, which will deal with the reactivity balance of the cold and hot reactor, and the effect of the control rods on the distribution of the neutron fluxes; the AEC, in particular, has studied a method for fast measurement of the flux by semiconductors.

[1963, pp 35-37]

5. Plutonium

[Excerpt] The Marcoule plutonium extraction plant had to face the increase of the power of the reactors and certain quality requirements which considerably increased the amount of fuel to be processed.

Two bottlenecks appeared, limiting the capacity of the unit: the shops for dissolution and purification of plutonium. While a new purification shop decided on in 1960 was put in service in May 1962, the "new dissolution," decided on in 1961, is being assembled; the first tests will begin in the beginning of 1964 and the active operation toward the middle of this same year.

The other shops have succeeded in following steadily increasing work rates and in 1963 greatly exceeded the estimates of 1959 and 1960.

However, since the Marcoule plant has to be able to process, before the La Hague plant is put in operation, spent fuel from the EDF reactors, it was necessary to develop the possibilities of certain shops and to align the rest of the plant to the capacity of the new dissolution.

To increase the capacity of the extraction sequences, it was decided to shut down one of the existing lines for a year for modification, which was able to be made without causing a delay in production.

The increase in the number of lines for concentration of the fission products is also doing well.

Finally, the increase in the uranium concentration capacity has ended. In addition, the alkaline storage of the fission products was replaced by an acid storage in stainless steel tanks and the continuous precipitation of plutonium oxalate was achieved.

During these works, it was able to be found that the initial idea according to which the most active installations could never again be approached by the personnel was mistaken.

Actually, all the necessary operations in the most contaminated rooms were always possible. Sometimes they necessitated long, hard work because the well-known "permanently walled" installations had been designed originally with no concern for arranging them favorably for the interventions. From then on, this teaching of experience has been taken very much into account and the new installations are arranged to facilitate any later intervention.

The waste processing station, the last link in the chemical chain, has succeeded, at the price of some installations, in absorbing the increase in active wastes that the industrial units produce at an ever increasing rate. The most original idea being developed is the concentration of radioactive mud and coating it with tar.

[1963, pp 110-111]

2. Reactors for Production of Plutonium and Power

A. Operation of the Reactors

1. G1 Reactor

[Excerpt] Operation of this reactor located at Marcoule has continued regularly for seven years.

The fourth Wigner annealing operation of the graphite stack was performed satisfactorily in October 1963. It caused only a ten day shutdown, much shorter than during the preceding annealings.

A 10 percent power gain was obtained starting in November 1963, as a result of the temperature increase of 25 degrees C (300 degrees C instead of 275 degrees C) authorized on the claddings of the fuel elements.

2. G2 - G3 Reactors

The improvements made in 1962 to the operation of these reactors, also located at Marcoule, were confirmed in 1963.

The known advantages of prestressed concrete chambers were verified by usage: ease of construction, possibility of high internal pressures; intrinsic nonexplosiveness; in the case of G2 and G3, noninjected cables giving the capability of permanent checking of their voltage and particularly making their replacement possible. An original device for instantaneous measurement of the voltages by means of dynamometric wedges having a vibrating string that are placed under each cable head makes it possible to measure very quickly, from a

centralized control station, the voltages of the 160 cables of each reactor.

The capacity of the loading and unloading system while operating notably exceeds the initial expectations both in tonnage handling and in the number of channels that can be unloaded daily. In particular, it makes it possible to maintain a permanent optimum arrangement of the network of the absorbents of the reactor and thus to bring the average practical power considerably closer to the theoretical maximum power.

The production of electricity has benefited from the increase in the temperature of the carbon dioxide. It normally reaches 80 MW for both reactors (plus 3 MW for G1), making possible, after deducting the consumption of the Marcoule Center, an export on the order of 65 MW on the EDF grid.

To increase plutonium production, every effort was made to improve the effective thermal power of the reactor while approaching as much as possible, the acceptable maximum temperature in the uranium and on the claddings. A new asymmetrical arrangement of the absorbent elements made it possible in particular to improve further the power of G2 and G3 which reached 258 MW.

B. Study and Design of New Reactors -

Studies of Systems

1. Pressurized Gas - Graphite - Natural Uranium System

EDF Nuclear Power Plants

The AEC continues to provide its assistance to EDF for the studies, development and startup of the Chinon EDF 1, EDF 2 and EDF 3 power plants, for the Saint-Laurent-des-Eaux EDF 4 power plant and for the studies of future EDF power plants.

a) EDF 1 Power Plant

While the first criticality took place in 1962 with a reduced load, in 1963 an important experimental program was carried out on the fully loaded reactor, a program in which the AEC actively participated and which made it possible, in particular, to measure the neutron characteristics of the network, the efficiency of the control rods and the distributions of power in the core.

The set up took place in June and EDF announced on 14 June the first linking of the power plant to the grid. During this set up and until the end of the year, the AEC participated in the systematic tests performed by EDF.

The behavior of the fuel elements have given no difficulties so far. The AEC, however, is studying particular improvements which will be made to the elements of the second set.

b) EDF 2 Power Plant

The hydraulic test of the chamber was conducted successfully and according to expectations at the beginning of 1963. The graphite stack was assembled during the last quarter. A test group was made up and the AEC will participate in 1964 in the initiation tests under the same conditions as for EDF 1.

The nuclear computations were resumed taking into account the experimental results obtained on the critical Marius stack; they have made it possible to define the first load of the reactor which will comprise, in particular, several channels loaded with the fuel provided for EDF 3.

Mass production of the fuel started in 1963 at the Annecy plant of the Societe Industrielle des Combustibles Nucleaires and is progresing satisfactorily; the

machining of the graphite jackets is underway at Marcoule; the supply of the first load is planned for toward the middle of 1964.

The confirmation studies on the behavior of the fuel elements have continued; testing outside the reactor -- heat cycling, creep, vibrations -- and irradiation tests as part of a contract concluded between the AEC and the United Kingdom Atomic Energy Authority which made it possible to begin the test in one of the reactors at Chapel Cross (Great Britain) with about fifty elements akin to the EDF 2 elements.

[1964 pp 31-33]

Plutonium

[Excerpt] At the Marcoule plutonium extraction plant, 1964 was marked by the satisfactory entry into service of the new dissolution of the spent uranium and of the improved extraction sequence B, which will make it possible for it to process, in addition to all of the spent fuel from the Marcoule reactors, a certain amount of fuel from the first EDF reactors. These installations were both made with the technical assistance of the Societe Saint-Gobain-Nucleaire as industrial architect.

The new dissolution processed the first spent fuel elements in July. It reached the expected nominal capacity without difficulty, immediately and under good chemical operating conditions. While the former dissolution operated in batch mode, the new one is made according to the continuous dissolution principle, which makes more uniform the operating conditions and the feeding of the extraction shop, which necessarily operates continuously.

In this last shop, one of the lines was abandoned in favor of the second, identical in origin to the first, but transformed in 1963 to increase its capacity and to profit from the considerable improvement in the technology of the mixers-decanter, occurring since the time of the design of the plant. The new dissolution, new extraction line now forms a homogeneous whole in capacity and design, from which an increased operating regularity is expected.

The fluorination and metallurgy shops, which are also the object of a reorganization with the installation of a complete new line for fluorination and production of metal, will be put in service at the beginning of 1965.

The work of a first expansion for storage of the fission products, whose capacity and safety are clearly improved in comparison with the original installation, was completed in 1964. The objective is to have sufficient storage capacity for the liquid fission products to expect that the development under way of new processes for vitrification of the fission products will make it possible to eliminate their storage in liquid form and to provide it in the much more secure form of an insoluble solid.

Contrary to the reactors, made to operate continuously of course, the chemical plant which processes the fuel spent in them is designed for a batch operation by operations separated by necessary shutdowns for all the work of maintenance, modification and improvement. During the shutdown in the summer of 1964, apart from the current maintenance work, a first phase of renovation work for control and regulation was undertaken, work which will continue in other shops during the next shutdowns of the plant. The continual progress made in the electrical and pneumatic equipment which makes up the major portion of the control installations

and the continual research for an improvement in safety have led to the decision to replace them periodically.

[1964, pp 110-112]

2. Reactors for Production

A. Plutonium Reactors

1. G1 Reactor

[Excerpt] The operation of the Marcoule G1 reactor has continued in a very regular manner for eight years.

A new procedure for releasing Wigner energy from the graphite stack by annealing was tested successfully in 1964. It consists in replacing the widely spaced annealings of preceding years with closer operations, at intervals on the order of three months, which eliminates the risk of uncontrolled release of energy and offers the additional advantage of more effectively combating the overall geometric deformation of the stack. Whereas the first annealing in 1958 necessitated a shutdown of the reactor of 100 days, for the seventh, in October 1964, a 24 hour shutdown was sufficient.

The power of the reactor in normal operation has also slightly increased as a result of an improved arrangement of the network of absorbents; it reached 46 MW thermal in November 1964.

2. G2, G3 Reactors

For these two reactors, 1964 corresponds respectively to the sixth and fifth year of continuous power operation. The various incidents which at the beginning of

the operation of these units caused shutdowns harmful to a good efficiency have almost completely disappeared as a result of a continuous adjustment of the installations and an improvement of their operation, obtained often by more or less significant modifications of the original design of the reactor.

Continual testing has made it possible to improve considerably the knowledge of the operating conditions of all the components. Thus, the more detailed data collected on the temperatures of the fuel elements, numbering 36,000 per reactor, have caused a better understanding of the safety conditions and a further slight increase in 1964 of the maximum allowable temperatures on the magnesium cladding of the uranium rods. As a result of the increase in the resultant thermal power, the G2 reactor has reached on the average of a day the record figure of 274 MW, corresponding to a particularly favorable distribution of the load and situation for the irradiations, whereas the initially anticipated power was 150 to 200 MW.

The amount of electrical energy produced could have exceeded the observed figures if the installations, designed for a power limit of reactors very inferior to that now attained, had not been saturated and their instantaneous power consequently reaching a maximum at about 40 gross MW electric.

The efficiency of the reactors, however, was reduced in 1964 by the need to modify the carbon dioxide-water heat exchangers, because of an insufficient sturdiness of the expansion bellows of the very long vertical pipes containing water and steam. This work, directed by EDF to which these apparatus belong, required a shutdown of about three months for each of the reactors. The results of this modification have proved very favorable.

Changes were made to the manufacturing of the fuels intended for these reactors to facilitate their reprocessing (graphite plugs).

Total net production of electricity of the power plants associated with the Marcoule G2 and G3 reactors reached 166 billion kWh on December 31, 1964.

B. CELESTIN Tritium-generating Reactor

The preliminary plan for the Celestin reactor, intended for the production of tritium by irradiation of lithium, was completed in April 1964.

The main contracts were signed or in the process of being signed at the end of 1964. The work on the Marcoule site began in May 1964 and is going on satisfactorily.

3. Power Generating Reactors

A. Graphite-Gas System -- EDF Nuclear Power Plants

1. EDF 1

EDF 1 has been in service at Chinon since 1963. Nominal thermal power (300 MW) was reached in the beginning of 1964. Various incidents, particularly on the blower and on the turbine, led to shutting down the reactor in May to perform the necessary repairs. The power plant was again linked to the grid at the end of September and has functioned since that date satisfactorily at a net electric power of 51 MW.

Three cladding breaks were detected in 1964; the defective elements were unloaded without difficulties and, after examination at the Chinon spent materials shop, were sent to the AEC laboratories. New experimental channels were loaded into the reactor in 1964, including thin pipes of slightly enriched uranium which make possible the study of the creep of uranium.

The AEC completed the study of an improved version of the EDF 1 fuel which will go into industrial production in 1965.

2. EDF 2

The end of work on EDF 2 occurred at the anticipated rate and the criticality took place on 17 August. It was followed by the nuclear tests, with which the AEC was closely associated, and which ended in November; the set up is scheduled for the beginning of 1965.

The irradiations of EDF 2 type fuel elements performed in 1964 in the AEC reactors and, under contract, in an English reactor at Chapel Cross, made it possible to obtain at the end of the year irradiation rates on the order of 3,000 MWd/t without the technological limit being reached. They will continue in 1965.

Tests had shown a slow diffusion of the plutonium through the magnesium-zirconium claddings which did not call into question the technological performance of the fuel element, but was able, however, to cause some difficulty in the use of the reactor because of the increase in the background noise of the system for detecting cladding breaks. Studies have made it possible to eliminate this phenomenon, so that the first load of EDF 2 is composed for a large part of fuel that absolutely does not allow the plutonium to diffuse.

The experimental role of EDF 2 will be as important as that of EDF 1. About a hundred channels have been loaded with experimental elements and including annular elements whose use is considered in the future development of the system.

[1965, pp 29-30]

4. Plutonium

A. Plutonium Production

[Excerpt] In 1965, good performances were obtained for the various industrial installations of the Marcoule Center, hence a notable increase in plutonium production in comparison with previous best years. This favorable result is due to: 1) the very regular operation at high power of the three G1, G2, G3 reactors, 2) the operating regularity of the plutonium extraction plant whose capacity has been clearly increased by the entry into service of the new installations replacing those whose capacity and reliability had appeared insufficient, 3) the very satisfactory operation of the numerous auxiliary services, decladding of the fuel, effluent processing station, maintenance, radioactive intervention team, etc., whose effectiveness improved by experience assists in a very great way the yield of the large production units, reactors and plant.

The Marcoule plutonium extraction plant profited in 1965 from the modifications and renovations of processing shops: new dissolution, extraction line B, line for production of metal achieved in the preceding years. Throughout the year, the overall plant operated in a completely regular manner at the maximum capacity of the new shops. Since its capacity was then greater than the unloaded tonnage from the three Marcoule reactors, it was able in December 1965, to process the spent uranium unloaded from the Chinon EDF 1 reactor, thus contributing to the La Hague plant whose active start up will take place only in the middle of 1966. To do this, the Marcoule decladding installations have had to be adapted by installing in one of the pits of the shop an entirely new device intended to declad the EDF 1 fuel elements.

In 1965 there entered into service in the plant the new integrated line for production of the metal consisting of three glove boxes containing the new continuous fluorination furnace for the plutonium oxalate, the furnace for production by calciothermy, the balance of weight of the ingots and the sampling device. In this new line which produces plutonium ingots of 1000 to 1200 g the number of operations is thus divided by 4 in comparison with the old installation.

The tonnage of processed uranium and the amount of plutonium produced at the plant are, as for the reactors, higher in 1965 than the previous years.

Among the projects in process, there should be cited the replacement of the process for concentrating plutonium by centrifuging with a process for extraction by TBP (tributyl phosphate) solvent in columns; the use is scheduled for 1966.

Finally, the assembly of the installations of the Marcoule Center having now reached a state of equilibrium, it is possible to consider, for the main industrial units, reactors and plant, a gradual reduction of the staff of the units now operated.

[1965, pp 104-106]

2. Reactors for Production

A. Plutonium Reactors

1. G1 Reactor

[Excerpt] In 1965, the tenth consecutive year of its operation, this reactor operated at normal power for 342 days. In particular, the speed of execution of the graphite annealing operation should be noted: 10 hours passed on 16 November, 1965 between the going down and restart bracketing the Wigner annealing. The

first operation of this nature in 1958 had required a shutdown of 110 days. The G1 generating reprocessing set produced 13,370,000 kWh in 1965.

2. G2 - G3 Reactors

G3 has not experienced a shutdown period of more than 15 hours since 8 August 1964. The reactor has operated for the past seventeen months since this date with a load factor of 99.9 percent (31 hours of shutdown in all) and at a power continually greater than the nominal power.

The performances of G2 are slightly less remarkable because of shutdowns necessitated by the replacement of coolers for the primary and secondary circuits for the carbon dioxide. The operating power has always been, as with G3, greater than the nominal power.

The modification of the EDF carbon dioxide-water exchanger has given good results. The short lifespan of the carbon dioxide coolers remains the weak point of these large units: the replacement of the steel pipes with "Admiralty" brass pipes and the change of type of certain coolants (water inside the pipes) should make it possible to reduce the corrosion and improve the cleaning operations.

Although limited by the maximum power of the sets, the electricity production of the associated power plants was 589,360,000 gross kWh, or 550,330,000 net kWh in 1965 (about 0.53 percent of the total French production). Since the beginning, the accrued electric power has reached 2,392,480,000 gross kWh and 2,208,144,000 net kWh as of 31 December 1965.

B. Tritium Reactors - Celestin 1 and 2

The project studies for the Celestin 1 reactor, intended for the production of tritium by irradiation of lithium, were for the most part completed during the

first half of 1965. The only studies remaining in progress are, on the one hand, the thermal and neutron studies intended to define the first load and the performances of the core and, on the other hand, the studies related to the control of the reactor.

Most of these contracts were signed at the end of 1965.

The construction work continued on the Marcoule site throughout the year. According to schedule, the large work will be completed at the beginning of 1966. The manufacturings in plant are occurring satisfactorily.

The preliminary work on Celestin 2, a duplication of Celestin 1, began during the last quarter of 1965. The actual construction of the reactor will begin at the beginning of 1966 next to Celestin 1.

3. Power generating reactors

A. Gas - graphite - natural uranium system

EDF Nuclear power plants

1. EDF 1 (Chinon 1)

EDF 1 operated for the first half of 1965 with two interruptions, one in January because of an incident on the turbine -- broken fins on the medium pressure wheels -- the other in March to allow the unloading of experimental channels. In June, the reactor was shut down for three months to repair the turbine. On this date, the utilization factor of the power plant since the beginning of the year was nearing 85 percent. The electric power had to be reduced from 60 to 45 MW because of the wearing flat of medium pressure wheels of the turbine, performed in January and the gross electrical production for this period rose to about

150,000,000 kWh. The performance of the fuel was satisfactory, no cladding break was reported.

After repairing the turbine, the reactor was again linked to the grid in September, but a new incident occurred on the turbogenerator set -- a loss of oil pressure -- forced shutting down the power plant almost immediately. The necessary repairs required three months, then the reactor was again linked to the grid in December, except for a short shutdown necessitated by the unloading of an experimental element whose cladding had been broken.

The shutdowns of the second half of the year were used to perform normal and experimental fuel unloadings which, after certain difficulties in adjusting equipment, were able to take place satisfactorily. The spent fuels were transported at the end of the year to Marcoule where they will be processed while awaiting the startup of the La Hague plant.

The AEC undertook a pilot production of improved fuel elements, loaded in the reactor in March, and, in cooperation with EDF, the examination of the experimental fuels after irradiation, which provided useful data on the behavior of various uranium alloys. Other studies, related in particular to thermal instrumentation, are continuing in conjunction with EDF.

2. EDF 2 (Chinon 2)

The set up of EDF 2 occurred at the beginning of 1965, the first turbogenerator set was linked to the grid on 24 February, the second on 8 March. The operation continued satisfactorily and the reactor reached 650 MW thermal in April, or 80 percent of nominal power. At the end of the year, the reactor had operated more than 4,000 hours with at least one set linked to the grid and the gross

electrical production rose to about 300,000,000 kWh. It should be noted that one of the sets was shut down from August to November for repair on the bladings of the medium pressure wheels, a preventive measure to avoid the phenomena observed on the EDF 1 turbine. Therefore, only at the end of the year was the reactor able to reach its nominal power.

The AEC continued its studies related to the fuel element. A certain number of elements are being irradiated in an English reactor at Chapel Cross and have reached irradiation rates near 4,000 MWd/t. Other elements were irradiated in the Pegase test loops at Cadarache and the examinations made after irradiation confirmed the good performance of these fuels in the reactor. About a hundred experimental channels, including a certain number loaded with annular elements, are being irradiated in the EDF 2 reactor and so far have had an excellent performance: no cladding break has taken place. The first unloadings of experimental channels were performed in the last quarter of this year and the spent elements will be examined in the beginning of 1966.

[1966, p 51]

F. EDF Nuclear Power Plants

1. EDF 1 (Chinon 1)

[Excerpt] EDF 1 operated linked to the grid for 6,613 hours (276 days) in 1966. The gross electrical power, which at the beginning of the year was 60 MW, was increased to exceed 80 MW (70 MW net) at the end of the year. The gross production of electricity was 438,000,000 kWh and the net production 363,000,000 kWh. The main outages were due, on the one hand, to leaks on the exchangers, which caused a total of 25 days of shutdown, and on the other hand,

to two cladding breaks of fuel elements in May and December; the shutdowns resulting from these breaks were used to unload experimental fuels and lasted a total of 21 days.

The AEC has continued its experimental irradiations programs in EDF 1. New elements were loaded in the reactor and the examination of the spent fuels provided useful information.

2. EDF 2 (Chinon 2)

For the first half of 1966, EDF 2 operated for 144 days, the only significant shutdowns being due to two leaks on one of the main exchangers. For this period, the gross production of electricity was 440,000,000 kWh, the power having had to be reduced several times to make it possible to carry out the tests for adjustment of the devices for loading and unloading of the fuel. At the end of the first half of the year, the reactor was shut down for various maintenance tasks. The power plant was again linked to the grid at the beginning of October and EDF 2 in November reached the gross power of 860 MW thermal and 225 MW electric.

The gross production for the year 1966 rose to more than 600,000,000 kWh for an operation of about 200 days. The performance of the fuel is still satisfactory and no cladding break has been reported since the startup of the reactor.

Experimental fuel elements, some of which coming from several channels loaded with annular elements, were unloaded and examined in the installations of EDF and the AEC; their performance is excellent. The AEC, moreover, in conjunction with EDF, is pursuing studies for the improvement of the thermometry in the reactor.

The spent fuels unloaded from the reactor were transported and reprocessed by the AEC at the La Hague plant.

3. EDF 3 (Chinon 3)

EDF 3 went critical on 1 March 1966. This first criticality, performed on the first full load, 450 tons of natural uranium, was followed by neutron tests. One of the sets was linked to the grid on 4 August, the second on 23 August. At the beginning of September, the reactor was operating at a power of 600 MW thermal corresponding to 140 MW gross electric. On 10 October an accidental shutdown of the grease pumps caused damage to one of the turbogenerator sets. Checks made after the shutdown of the power plant showed serious disorders in the pipes for removal of gas from the circuit for detecting a cladding break and it will not be possible to restart the power plant ...

[1966, pp 129-133]

3. Plutonium

[Excerpt] The plutonium delivery schedule planned for 1966 was met, the amounts of necessary fuels having been unloaded in the desired time for the EDF 1 and EDF 2 power plants. The programs for reactor production will have to be reviewed taking into account the incidents which impeded the operation of EDF 3.

A. Plutonium Production

For the Marcoule center, 1965 was marked by high performances of the production units that led to a large increase in the production of plutonium in comparison with prior years. The year 1966 is characterized by a stabilization of the

production at the already high level of the preceding year, a certain number of work projects on the reactors having required their shutdown.

The plutonium extraction plant showed an exceptional operating smoothness.

1. Plutonium-Generating Reactors

a) G1

The operation of this reactor, which went critical on 7 January 1956, has remained excellent.

The operations of Wigner annealing of the graphite have taken a routine nature. They interrupt the operation only for a dozen hours and are performed about every four months.

Research for improvement of the power has continued with the loading of new fuel elements having curled longitudinal fins which will undoubtedly make possible a power increase of some 5 percent, or 2 to 3 megawatts thermal.

The concern for making the operation of the reactor more economical led to reducing the personnel of the operation team which, from a figure of 82 persons in the beginning, fell to 57.

The generating reprocessing set of G1 produced 14,195,500 kWh gross in 1966, or 10,413,000 kWh net.

b) G2 - G3

These reactors have also had a very smooth operation which has made it possible for them to maintain their high rate of production of 1965. However, the

improvement of the latter was limited in 1966 by the power reductions and the shutdowns following the work on the exchangers and on the carbon dioxide coolers.

As for the exchangers, in July 1966 on G2 and in August on G3 there appeared a malfunction of the steam collector pipes of the medium pressure evaporator banks, due to the erosion by cavitation at a specific point that went as far as piercing the pipe. Since the two reactors comprising a total of 464 pipes were thus threatened, a preventive repair of the unit had to be undertaken under very difficult operating conditions.

Carried out under the direction of EDF, this work was conducted successfully on G3 from the beginning of November to mid-December. It is planned to undertake them under the same conditions on G2 beginning in February 1967.

This shutdown of G3 was used to replace two secondary carbon dioxide coolers; one of these new coolers is the first of the new brass water pipe type whose adoption was decided on in the hope of putting an end to the malfunctions due to the depositing of corrosive muds between the pipes.

A shutdown of G3 in March 1966 was necessary to install two primary coolers with brass pipes and to put a former secondary cooler with steel pipes out of service.

A beginning of corrosion of the circular prestressed cables of the concrete chambers necessitated the stripping off of the parts of the cables coated with concrete. Considering these operations, the performance of these cables gives no worry for the future.

The performance of the fuel, natural uranium clad with magnesium-zirconium, has remained excellent. Claddings breaks are still very rare.

Further, several improvements were made this year to the reactors, to their accessories and to the progress of certain operations, in particular those of loading and unloading.

The new fuel elements with claddings having herringbone fins developed and manufactured in 1966 must be loaded in G3 during the first half of 1967. The addition of thermal power to be expected from it is estimated between 5 and 10 percent.

Taking into account all these elements, the overall judgment that can be made at the end of 1966, on the industrial future of the G2 and G3 reactors is still very favorable. No sign of worrisome again gas appeared which would make it possible to establish a time limit for the normal operation of these units. Particular attention should be paid, however, to the problems of the thinning down of the metal in the gas-steam exchangers. Prestressed concrete chambers, graphite stacks, large pipes for carbon dioxide, essential elements for the life of the reactors, give no sign of abnormal deterioration at the end of 7 to 8 years of intensive and continuous operation.

The production of the associated G2 - G3 power plants in 1966 was 520,383,000 kWh gross, or 489,482,000 kWh net. Since the beginning, the accrued production has reached 2,912,862,000 kWh gross, or 2,697,613,000 kWh net as of 31 December 1966.

2. Plutonium Extraction Plants

a) Marcoule Plutonium Extraction Plant

As in 1965 and with an even larger excess capacity, the plant easily absorbed, in 1966, the tonnage of spent uranium unloaded from the three Marcoule reactors.

This excess capacity made it possible for it in particular to process the 88.5 tons of spent fuel unloaded from the EDF 1 reactor at Chinon.

The operation teams of the plant, constantly bent on perfecting the installations and improving the economy and the safety of the operation, obtained advantageous results in numerous fields in 1966. The main ones are: 1) the satisfactory operation after a very delicate adjustment of the equipment for continuous precipitation of plutonium oxalate according to a technique entirely conceived and developed at Marcoule; 2) the elimination of the current analyses of production of the plutonium purification shop and their centralization in the general laboratory as a result of sending samples by pneumatic conveyer network; 3) the transition from 4 to 2 station teams for the metallurgy shop after the placing in service of the new production line for large plutonium ingots of 1,200 grams; 4) the placing in service of the process for decontaminating ruthenium by lead paraperiodate associated with ferrous hydroxide and nickel ferrocyanide, according to a studied principle and developed at Marcoule, which makes it possible to reduce in a ratio of about 3 the overall activity discharged into the Rhone.

These improvements being added to the progress in the operating techniques (grouping and automation of control panels) have made it possible to achieve considerable personnel cuts in the operation teams.

The processing for the first time in France of large amounts of spent uranium-molybdenum alloy coming from EDF 1 made it possible to find that the industrial rate of the dissolution shop was very slightly reduced in comparison with pure uranium, contrary to what was assumed.

The largest service operation in a very radioactive zone of the plant in 1966 was caused by the discovery of a leak in a weld of the dissolution tank of the new shop that entered into service in November 1964. This malfunction necessitated a decontamination of the tank which lasted two months and then a very delicate operation in a radioactive zone which was completely successful.

Finally, the process for coating in tar conceived at Marcoule came out in 1966 on the placing in operation of the coating shop which obtained excellent results right away. This project is the first of this type operating of a production center at the industrial rate.

b) La Hague Plutonium Extraction Plant (UP 2)

1. Construction

During 1966, the finishing work on roads, green spaces, lighting of the enclosures continued. Acquisition of the lands of the No 2 expansion zone was begun.

The equipment work of the shop for processing the fuels spent in the Rapsodie reactor (AT 1) was finished and various tests made in 1966. The inactive tests with nonspent uranium began in December.

The civil engineering construction site of the new deactivation pool and of the laboratory for statistical inspection of the spent fuels was opened in August 1966.

The study for the project for construction of a manufacturing shop for sources of cesium 137 was undertaken to be completed in 1967. This shop will use cesium 137 extracted from the fission products and fastened on transportable columns at Marcoule.

2. Tests and operation

The overall tests of the UP 2 plant using nonspent uranium took place in April and May 1966 and progressed satisfactorily, making it possible in the beginning of June to start up active tests with fuels spent in the Chinon EDF reactors. This first operation showed the need of some finishing and adjustment work. This was performed in the beginning of the autumn 1966. In November, a second radioactive test operation took place, ending in the production of the first kilograms of plutonium.

The first automatic unit for radiography of the fuel elements on the EDF 2 decladding line has been placed in service.

During the year, the last technological units were placed in service: packaging of the solid wastes, decontamination shop, radioactive laundries.

The test operations carried out in 1966 with the assistance of all the interested departments (building department, plant operating department, industrial architect) showed that the plant will be able to enter in its industrial operation phase starting in 1967.

[1967, pp 124-129]

3. - Plutonium

A. Plutonium Production

[Excerpt] The very satisfactory operating smoothness of the Marcoule industrial units has made it possible, while reaching the highest production figures since the beginning, to direct the efforts at improvement in two main directions:

1. The production costs were able to be reduced in 1967 by cutting operating expenses, on the one hand by efficiently scheduling the work on modifications and improvements in the technical units and by restricting them to the minimum compatible with maintaining safety production, on the other hand, by studying management economy and increase in productivity;

2. A part of the technical personnel were converted back to tasks for studying modifications and additions to be made to the decladding installations and to the plant to adapt them for the possible processing of spent fuels of new types such as the EDF natural uranium type element, the plutonium-aluminum element of the Celestin tritium-generating reactors, the plutonium oxide element of the Phenix breeder reactor.

1. Plutonium-Generating Reactors

a) G1

The operation of this already old reactor has continued without the least incident during the entire year of 1967. Its simplicity and its sturdiness give it the best load factor that could be imagined for a reactor and its total days of shutdown correspond to scheduled shutdowns for unloading of fuel (21 days) and Wigner annealings of the graphite (3 days).

The turbogenerator set using steam produced by the heat of the air leaving G1 produced, in 1967, 15,989,000 kWh gross, or 11,614,500 kWh net.

b) G2 - G3

During the years of starting up and improvement, from 1959 to 1965, the unit thermal power was gradually brought from 200 to 250 MW and the number of shutdown days decreased.

Repair on the G2 exchangers, similar to that made in 1966 on G3 and planned for February 1967, was able to be performed in 35 days despite the complexity and inconvenience of the work. Personnel could enter and work in the exchangers only in full suit fed with fresh air from the outside. The operation of G2 at maximum power was excellent for all the rest of the time.

At G3, two shutdowns, one of 7 days, the other of 14 days, were necessary in 1967, the first caused by the malfunction of the pipework of an exchanger, the other to unjam several fuel channels and to unload thermocouple fuel elements measuring the cladding temperature, fuel elements placed in the reactor at the beginning of loading of the new fuel elements with herringbone fins. Therefore, the G3 reactor was shut down 21 days this year. Its operation was excellent the rest of the time.

The loading of new fuel elements with herringbone fins in G3 took place from January to May 1967 and paid off, as previous studies had led to expect, by a power gain of about 5 percent which made it possible to reach the high power point of 264 MW. These new fuel elements, with which the longitudinal distribution of the neutron flux is slightly modified, also provide the advantage of a wider choice of control rods in the control of the reactor without the flux undergoing deformation. This new type of cladding was definitively adopted and will be placed in the G2 reactor beginning in May or June 1968.

For the remainder, the year was marked by a clear decline in incidents of all sorts to the benefit of the operating smoothness and the decrease in the load of the intervention teams. The annual average number of operating days per reactor was 337.

The production of the associated G2 - G3 power plants in 1967 was 619,600,000 kWh gross, or 584,700,000 kWh net. Since the beginning, their accrued production of electricity has reached 3,532,000,000 kWh gross, or 3,282,000,000 kWh net.

At the end of this year of 1967 and regardless of the length of life that remains to them, the state of the G2 - G3 reactors appears excellent and their ability to provide a high annual production is better than it has ever been.

2. Plutonium Extraction Plants

a) Marcoule Plutonium Extraction Plant

For the plant and its accessories, the year was marked by a perfect operating smoothness, a permanent availability that no operating incident has restricted and with a quadruple capacity from that anticipated in the beginning. The phase for adapting the plant to industrial operating conditions at a high rate is therefore virtually finished as far as the type of fuel for the Marcoule reactors is concerned. Studies have been launched for the possible adaptation of the plant to the processing of fuel elements of other types.

The plant now operates according to the availabilities of fuel unloaded from the reactors in two or three annual operations separated by shutdown periods of several weeks. The tonnage of spent uranium processed in 1967 exceeded those of previous years.

The year was marked by the entry into service of new installations and by a certain number of improvements of processes.

Concentration of the fission products was increased, which reduced by almost 40 percent the volume of the residues to be stored per ton of processed uranium.

The new shop for concentration of plutonium by tributyl phosphate is pulsed columns that entered into service in August 1967 made it possible to eliminate at the same time the second plutonium purification cycle in mixers-decanter and passage over ion exchanger resins. This process makes it possible to cause directly the oxalic precipitation of the plutonium, which still provides an appreciable decontamination and is performed in a continuous precipitation installation.

The continuous furnace for fluorination of the plutonium oxide experienced a period of rather delicate adjustment because the problem of corrosion by hydrofluoric acid had to be solved.

Two installations were made to make it possible to reduce the ruthenium content of the effluents arriving at the waste treatment station. This work made it possible, in practice, to eliminate the "high activity" category of the effluents arriving at this station.

The still incomplete placing into service of the installations for improvement of the decontamination of the effluents discharged into the Rhone has already made it possible to reduce by about a factor of 4 the number of curies discharged by the center.

A new installation for decontamination, by entrainment with steam, of the tributyl phosphate solvent used in the plant entered into service in December 1967.

b) La Hague Plutonium Extraction Plant (UP 2)

1. Construction

A certain number of infrastructure works were undertaken, made necessary by the installation of the following units: 1) the new deactivation pool and the laboratory for examination of the La Hague fuels which will be completed towards the middle of 1968; 2) the shop for manufacturing sources of cesium 137, the building for aqueous corrosion studies, the marine radioecology laboratory, the construction sites which were opened in April and May 1967; 3) the expansion of the radioactive wastes storages consisting of the concentrated solutions of fission products and the resultant muds from the processing of the liquid effluents, and by the magnesium claddings, the graphite jackets, the aluminum containers that will be piled into the silos and trenches.

2. Operation

If 1966 was the year of the first active tests of the UP 2 plant, 1967 is the one for the start of the industrial operation of this unit. The processing dealt with relatively small quantities of spent fuel with a uranium-molybdenum alloy base coming from the Chinon EDF 1 and EDF 2 reactors.

Two operations made it possible to draw valuable lessons on the operations of the various units of the plant.

Thus difficult problems have been solved, such as the stability of the concentrated solutions of fission products coming from the uranium-molybdenum alloys and the development of the cycle for purifying plutonium with trilaurylamine. These results, however, must be confirmed by longer-term operations dealing with more thoroughly spent fuels. Moreover, the excellent decontamination factors obtained in the first purification cycle and the very satisfactory operation of the effluent processing station should be pointed out.

In this respect, the activities discarded into the sea were much less than those authorized for the year.

[1968, pp 35-36]

9. EDF Nuclear Power Plants

a) Chinon 1

[Excerpt] The Chinon 1 power plant has operated linked to the grid for 3,732 hours (156 days). The gross production of electricity has been 315,000,000 kWh and the net production 254,000,000 kWh. The power plant was shut down for four months for a very large unloading of fuel, a period used, on the other hand, for an inspection of some parts of the installation.

The restart was delayed following the discovery of an incident of aeromechanical origin that arose on a fairing of a gas outlet pipe. Among the other incidents that interfered only in a minor way with the operation of the power plant, there can be noted a cladding break that occurred in November. The particularly satisfactory operation of Chinon 1 during the last quarter (availability rate: 95 percent) should be reported.

b) Chinon 2

The utilization factor was on the same order as in 1967; the power plant operated linked to the grid for 6,212 hours (259 days). The gross production of electricity was 1,309,000,000 kWh, the net production 1,134,000,000 kWh. Gross electric power has reached 237 MW, net power 211 MW.

The main incidents that interfered with the operation of the power plant involved the exchangers where quite a few leaks appeared; an incident of aeromechanical

origin affected bleeds for detecting a cladding break in the gas outlet pipes. The loading and unloading apparatus is now satisfactory.

It can be considered that the overall operation of Chinon 2 has been satisfactory, particularly during the last quarter; the troubles encountered on the fuel elements centerers have not had any impact on the operation of the power plant.

c) Chinon 3

The Chinon 3 power plant operated linked to the grid for 5,544 hours (231 days). The gross electric production was 1,084,000,000 kWh, the net production 1,014,000,000 kWh. The incidents that occurred on the experimental fuel element centerers intended for Chinon 2 led to restricting, as a precaution, the flow of carbon dioxide to 70 percent in April, then to 50 percent in December; these restrictions had only a small influence, because of the incidents that occurred in another connection on the main and auxiliary sets and the exchangers. The adjustment of the loading and unloading machines has proven delicate and their operation has given rise to several incidents.

d) Saint-Laurent 1

The year 1968 was devoted to overall tests. Their progress was favorable until a deterioration on the sheet metal protecting the filters of the heat insulator was found in August. This, combined with the strikes of May and June 1968, caused a delay of about five months in the date of the first loading which began in mid-December 1968 and was completed in the first days of January, making it possible for the power plant to go critical for the first time on 7 January 1969.

A team of AEC engineers has continued to participate throughout the entire year in performing the tests.

[1968, pp 96-98]

A. Plutonium Production

1. Plutonium-Generating Reactors

a) G1

[Extract] Taking into account the development of the programs and for reasons of economy, the first French power reactor, G1, was permanently shut down on 15 October 1968. The excellent performances of this reactor should be emphasized, whose load factor during the nine years was near 92 percent, the remaining 8 percent being for the most part due to the unloading of fuel which could be performed only with the reactor shut down. The personnel serving G1 were for the most part transferred to the operation team of the Celestin reactors that needed to be reinforced for the starting of Celestin 2.

b) G2 - G3

The operation of the G2 and G3 reactors was very satisfactory in 1968.

G2 reached a load factor of 95 percent. A certain number of inspections were performed and the "crossbow" rods intended to assure the introduction into the core of a sufficient antireactivity in case of a sudden depressurization accident were installed. During the year, fuel having herringbone cladding was substituted for the fuel having longitudinal cladding, as with G3 in 1967.

For its part, G3 reached a still greater load factor (more than 96 percent), the only significant production loss, outside the strike period, being due to a cladding break on an experimental channel that had to be unloaded. At the end of the year, the unloading of spent uranium began, the lowering of reactivity being compensated by the elimination of the absorbent network used until then, which is reflected by a considerable economic advantage. The operation will continue in 1969 and will be extended to G2.

The production of the power plants associated with G2 and G3 in 1968 was 670,500,000 kWh gross and 633,500,000 kWh net. Since their beginning, their accrued production of electricity has reached: 4,203,000,000 kWh gross, or 3,916,000,000 net.

Because of the good operation of these reactors, the possibility, beyond satisfying the plutonium needs, of their being kept in service as electric generating reactors is being studied.

2. Plutonium Extraction Plants

a) Marcoule Plutonium Extraction Plant

The process modifications are aimed at reducing the radioactivity of the effluents, either by increasing the decontamination factors before sending the solutions to the effluent treatment installation, or by additional operations in this latter unit intended to keep the content of the waste as low as possible.

A solution had to be sought to the problem posed by the gradual reduction over time of the decontamination factor of plutonium during its extraction. The quality of the products has been able to be assured as a result of the good decontamination efficiency of the shop for concentration of plutonium by solvent,

a shop placed in service in 1967. The placing in operation of the pulsating columns was very satisfactory. Its capacity being larger than that of the old concentration shop, its behavior simple and precise, the easier monitoring by reduced staff and increased safety with regard to the risks of criticality make it possible to consider this transformation a success.

The concentration of the column feet of the second extraction cycle and the recovery of nitric acid have considerably reduced the volume of the high and average activity effluents and have improved the economic balance.

The installation for concentration and storage of the carbonated effluents, by facilitating the decrease of ruthenium, also contributed to the significant reduction of the volume of effluents. This development makes it possible to conceive of plants which will be able to "digest" internally the largest part of the radioactivity of their effluents, so as to discharge only greatly reduced volumes containing almost no activity.

b) La Hague Plutonium Extraction Plant (UP 2)

1) Construction

The new storage pools for the spent fuels coming from the Saint-Laurent-des-Eaux reactors have been completed and the pool in service for the Chinon reactors has been covered. The plant is thus suited for reprocessing of the spent fuels of the gas-graphite system. Taking into account the development of the programs, a shop is being studied that can process oxide fuels.

Other work has been performed to make possible an increase in the storage capacity of the wastes and fission products.

2. Operation

These operations of 1968 first of all made it possible to confirm the excellent results obtained in 1967, in the matter of decontamination, the tributyl phosphate extraction cycle and of stability and effectiveness of trilaurylamine for purification and concentration of plutonium, results making it possible to obtain finished products of very high purity and perfectly decontaminated. In addition, they made it possible to increase very considerably the production capacities of all the shops and, in particular, of the decladding shop whose performances were greatly improved by the placing in service of new decladding heads and the modification of the fuels transfer circuits.

The 1968 operations finally made it possible to concentrate large quantities of neptunium 237 in solution, the separation of which will be assured in the Marcoule pilot shop.

As for the analytical control, progress in the matter of productivity was obtained as a result of the research, the development and the systematic utilization of new fast methods.

B. Chemical Studies on Plutonium Production

1. Improvement and Expansion of the Processes for Treating Spent Fuels

The majority of the fuels from the reactors in service (EDF gas-graphite reactors of Rapsodie, Celestin) or to come (heavy or ordinary water reactors, Phenix, submarines) being very different in their composition or their level of irradiation from those that have been processed in France to the present, numerous chemical studies are continuing for their future processing, either in the existing plants or in the expansions or developments of the latter.

The main work involves the new fuels of the EDF power plants, those of the fast neutron system and those of Celestin.

a) Fuels for EDF Reactors

Among the improvements that are being considered to be made to the EDF fuel elements, the most important is the introduction of a graphite core in the uranium rods.

Tests were performed on the prototype machine for drilling these cores under normal operating conditions, on inactive rods; the filtering of the graphite appears satisfactory. After drilling, a not insignificant fraction of the graphite will remain with the uranium; a part of this graphite will be accumulated at the bottom of the dissolution tanks while the other, carried by solutions in the shape of fine particles, is liable to disturb the extraction by solvent. Studies in the laboratory and in semi-industrial installation have made it possible to determine the proper means to eliminate these drawbacks: the graphite decanting to the bottom of the tanks will be able to be truly eliminated by periodic purges with an ejector. What remains in suspension must be separated by centrifuging.

Moreover, since the carbon deposits are able to cause the hot fast corrosion of the stainless steels by nitric acid, the actual tanks will have to be replaced with titanium or zircaloy containers.

b) Fuels of the Fast Neutrons System

At La Hague, the pilot shop for the processing of the mixed UO_2 - PuO_2 fuels of the fast neutrons system is ready to receive the first spent assemblies in the

Rapsodie core. Only the excellent performances of the fuel, kept longer than anticipated in the reactor, have delayed putting this shop into service.

This additional delay was used, on the one hand, at La Hague to finish off the processing and control installations and, on the other hand, at Fontenay-aux-Roses, in a shielded cell, to check the process on several increasingly active fuel points coming from the Rapsodie reactor itself. A method ...

[1969, pp 37-38]

10. EDF Nuclear Power Plants

a) Chinon 1

Chinon 1 has operated without noteworthy incident. The number of breaks in claddings has remained small: three in the year. Despite a scheduled shutdown of more than two months, from 16 July to 24 September, for a large unloading and for maintenance, the power plant has been linked to the grid for 6,025 hours (251 days). Its gross production of electricity was 481,200,000 kWh and its net production 392,000,000 kWh.

b) Chinon 2

The operation of the Chinon 2 power plant during 1969 was excellent. Despite a scheduled shutdown of one month, from 10 June to 12 July, for maintenance, the gross production of electricity for the portion was 1,772,400,000 kWh and the net production 1,548,500,000 kWh, which corresponds to a utilization factor of 0.88. The power plant was linked to the grid for 7,829 hours (326 days), i.e., virtually continually except for the month of shutdown.

The gross and net electric power reached 248 MW and 218 MW respectively during significant periods; these figures should be compared with the nominal powers of 230 MW and 200 MW.

It should be pointed out that from 1 October 1968 to 1 April 1970, the utilization factor of the power plant was also 0.88 which shows the excellent economic speed now reached by Chinon 2.

c) Chinon 3

The operation of the Chinon 3 power plant again this year suffered from the handicap of the power limitations imposed by the exchangers and the fuel elements. It was linked to the grid of 4,844 hours (210 days), its gross production of electricity was 903,500,000 kWh, its net production 862,300,000 kWh.

During the first half of the year, the first half of the exchangers were replaced and beginning in October, the replacement of the second half was undertaken. For the entire year, fuel elements of the type on which the centerer breaks were found in 1968 were replaced with elements having corrugated centerers; the operation will continue in 1970.

d) Saint-Laurent 1

The reactor went critical for the first time on 7 January 1969 and the power plant was linked to the grid on 14 March. The set up was done under excellent conditions and in mid-October gross production reached 1,114,400,000 kWh and net production 1,063,600,000 kWh. The maximum gross power reached was 420 MW.

Then, on 17 October an accident occurred on account of successive errors in the use of the loading-unloading apparatus; a channel being loaded was plugged by a graphite log, which caused this channel to burn up. Molten uranium ran out on

the floor, a support for the stack. Before restarting, it was necessary to remove this uranium to make possible a correct later operation of the installation for detecting cladding breaks.

[1969, pp 101-103]

A. Plutonium Production

1. Plutonium-Generating Reactors

[Excerpt] The G2 and G3 reactors operated smoothly in 1969. Their power, and therefore their plutonium production, was again increased as a result of a mode of loading comprising a certain proportion of spent uranium, and bringing a considerable economic advantage.

G2 reached a load factor of 95 percent. Two short shutdowns of this reactor marked the year: in June for maintenance work, and in November because of the general strike of the AEC.

G3 reached a load factor of 94 percent despite adjustment and maintenance work necessary after twenty months of uninterrupted operation and despite the November strike.

The production of the power plants associated with G2 and G3 in 1969 was 661,000,000 kWh gross and 624,000,000 kWh net. Since their beginning, their accrued production of electricity has reached 4,864,000,000 kWh gross, or 4,540,000,000 kWh net.

2. Plutonium Extraction Plants

a) Marcoule Plutonium Extraction Plant (UP 1)

The metallurgy shop now produces plutonium ingots of 2.5 kg instead of 1.25 kg previously. The number of operations and analyses for control of the finished product is thus reduced by half.

In the same spirit of increasing the productivity, it has been possible to reduce the analytical control of the plant and therefore the number of agents for the continuous control teams.

A pilot installation for decladding spent fuels by sublimation of the magnesium claddings has been developed. This process has the advantage of making possible the decladding of a very varied range of fuels. In addition, it makes it possible to separate the very radioactive wastes from the less radioactive, the latter being able to be directly packaged for coating in tar. In the first test operation of this pilot installation, 2.5 tons of spent fuel were decladded under excellent conditions.

b) La Hague Plutonium Extraction Plant (UP 2)

The year 1969 was marked by three operations for processing spent fuel coming from the three Chinon reactors and having maximum combustion rates of 2,300 MWd/t.

The La Hague plant processed Chinon 3 fuels of a new type for which it appeared that the mechanical decladding was not satisfactory. The technicians were able to solve all the problems connected with the chemical decladding initially anticipated as standby and which strongly suited this type of fuel. In addition, this mode of decladding will be particularly suitable for the fuel of the Bugey reactor.

As in 1968, these operations made it possible to concentrate solutions of neptunium 237.

A process, applicable in UP 2, for separation of the uranium and the plutonium from the Rapsodie fuel was developed in the laboratory for the "Fortissimo" operations.

Tests on a new process for preparing in large quantity uranium nitrate by catalytic reduction with hydrogen were successfully undertaken. Numerous developments of methods and equipment were made to increase the productivity of the laboratories: real time analysis of the mass spectrometers by computer, use of atomic absorption and infrared spectrometry for routine control, automation of the quantity determination of plutonium by calorimetry and of the preparation of samples for the mass spectrometry.

For maintenance, an important effort for optimum use of the proper means made it possible to reduce very considerably the volume of the work awarded to outside businesses.

In the matter of equipment and adjustment work, among others there should be reported in 1969: 1) the completion of the new fluorination-calciothermy line, 2) the putting in service of the installation for dissolution of the oxides and the plutonium wastes, and 3) the putting in service of the new assembly unit of the medium activity plutonium shop.

B. Chemical Studies on Plutonium Production

1. Improvement and Expansion of the Processes for Processing Spent Fuels

a. Improvement of the Decontamination Factors

The process, tested successfully in 1968 at Fontenay-aux-Roses, to chelate the fission zirconium by hydrofluoric ions, responsible for the degradation of the solvent and for the successive lowering of the plutonium decontamination factors, was used on the one hand at the Marcoule plant, and on the other hand, at the processing shop for Rapsodie fuels. In both cases it was possible to obtain satisfactory decontamination factors.

b) Fuels from the EDF Reactors

The contemplated introduction of a graphite core into the uranium rods of the fuel elements of the EDF reactors required a series of studies on the processing to be applied to them during their removal from the reactors: clarification by centrifuging of the dissolution solutions, periodic purging of the dissolution tanks, etc.

The tests on inactive fuels have been completed and the Marcoule pilot shop has been equipped for operations on spent rods which, alone, will be able to foreshadow the actual conditions of the future processings.

c) Fuel from the Fast Neutron System

The AT1 pilot shop built at La Hague to process the spent fuels of the Rapsodie core was radioactive tested with the processing of 220 fuel pins representing 25 kg of mixed UO_2 - PuO_2 mixed oxide, or about seven assemblies. The first dissolution took place on 21 January 1969 and the operation lasted more than a month.

Although the average combustion rate has not exceeded 18,000 MWd/t, drawbacks of the strong concentrations of fission products have appeared: insoluble products (or reprecipitated after dissolution), in particular molybdenum, have proven

very difficult to separate. They have frequently clogged the filters, necessitating numerous and delicate interventions.

Apart from these difficulties, the operations have progressed without significant incident and the efficiency of the process has been greater than 99 percent. The specific activity of the fuels was very variable. The most spent having reached a combustion rate greater than 40,000 MWd/t exhibited, even at the end of the deactivation time, a beta activity of about 6 curies per gram. However, the residual beta activity of the final product, after three extraction cycles, was always less than 0.1 microcurie per gram, which represents an overall decontamination factor greater than 6.10^7 for the most radioactive lots. These excellent results are explained in large part by the effectiveness of the hydrofluoric ion process described above.

d) Study of the Saint-Gobain-Robatel Centrifuge Extractor

In addition to the hydrofluoric ion process, other methods to limit the effects of the chemical and radiolytic degradation of the solvent were contemplated. Extraction equipment was sought making possible very short contact times between the two phases while assuring high deliveries. Thus, Saint-Gobain Techniques Nouvelles and the Robatel Company studied and constructed an original model of a centrifuge extractor.

After several additional developments, a model was tested on the uranium at Fontenay-aux-Roses. In view of the excellent results obtained (yields greater than 99.9 percent), it was decided to continue the tests, on the one hand on special industrial centrifuges with natural uranium at the Le Bouchet plant, and on the other hand on a small model device with radioactive solutions at the Marcoule pilot shop. The two series of tests gave satisfactory results.

e) Corrosion of Material

The modifications made to the fuels and to their processing caused numerous corrosion problems, in particular for the stainless steels used. Adaptations of their composition to that of reactive mediums had to be made. On the other hand, the attack itself on titanium by nitric acid has been shown which makes the use of this metal hazardous in some cases. Zircaloy-2 does not give rise to the same phenomena and thus exhibits a safer behavior.

f) Putting Automatic Control Equipment in Service

Several devices for automatic control of the processes have been proven in radioactivity at the Marcoule pilot shop: diode alpha detectors, krypton 85 detectors to follow the dissolutions, alpha counters with gamma absorption meter for continuous measurement of the density of the radioactive solutions, ...

[1969, unnumbered page]

3. Plutonium

[Excerpt] The year 1969 constituted an important turning point for the reprocessing of spent fuels. The development of the military programs and the new directions of the nuclear power programs led the AEC to launch technical and economical studies on the development of the activities of its two plutonium plants.

The complex that they form will represent a major asset for France when, around 1975, an important European market for reprocessing the fuels from ordinary water reactors will develop. But it is necessary that at that time the plants of the AEC will be in a competitive position from the international point of

view both for the production costs of plutonium extracted from the fuels of the EDF reactors and for the offers of services to foreign clients, and that they also be ready for the reprocessing of the Phenix fuels.

To do this, one of the existing plants will be equipped at the end of the 1971-1975 period with an expansion called "oxide head" making it possible for it to process these fuels.

[1970, page 33]

10. EDF Nuclear Power Plants

a) Chinon 1

[Excerpt] The operation of Chinon 1 was very satisfactory in 1970, the utilization factor reaching 0.75. This year there was no cladding break of the fuel. Despite a shutdown for unloading and maintenance of more than a month and a half, from 26 June to 15 August, the power plant linked to the grid for 6,979 hours (290 days) had a gross production of electricity of 556,200,000 kWh and a net production of 456,1000,000 kWh.

b) Chinon 2

During 1970, Chinon 2 continued to operate very satisfactorily since the utilization factor reached 0.90 as opposed to 0.88 in 1969. Despite a shutdown of a month for maintenance, from 29 March to 29 April, the gross production of electricity was 1,800,600,000 kWh and the net production 1,580,300,000 kWh. As in 1969, the power plant remained continuously linked to the grid except for the shutdown period (7,983 hours or 332 days) and almost always operated at full power. It can be recalled that from 1 October 1968 to 31 December 1970, the

gross and net productions of electricity at Chinon 2 were respectively 4,093 million kWh and 3,486 million kWh.

Only a single cladding break was recorded on an experimental fuel element, and this despite the very high irradiations reached by a significant number of channels (from 6,000 to 7,000 MWd/t for the most irradiated fuel elements).

c) Chinon 3

The power plant continued to undergo the power limitations imposed on the one hand by the vibrations that appeared on the new exchangers, and on the other hand, by the fears of corrosion of certain structures by the carbon dioxide. But on the other hand, the limitations imposed by the fuel elements during 1969 were raised in the first half of 1970.

[1970, pp 97-99]

Plutonium

A. Plutonium Production

1. Plutonium-Generating Reactors

[Excerpt] The operation of the G2 and G3 reactors in 1970 was smooth, with a shutdown for each reactor of three weeks for maintenance. The load factor reached 94 percent.

G3 operated without interruption for a period of 403 days, without incident affecting the operation of the reactor, thus setting a record. The shutdown which occurred after this period was scheduled for several months to perform maintenance work.

The production of electricity of the power plants associated with G2 and G3 in 1970 was 617,000,000 kWh gross and 582,000,000 kWh net. Since the beginning, their accrued production of electricity has reached 5,481,000,000 kWh gross, or 5,122,000,000 kWh net.

2. Plutonium Extraction Plants

The chief preoccupation of 1970 for the Marcoule and La Hague plutonium extraction plants was the necessity of adapting the personnel to the programs planned for the next years; the new starts were facilitated by a policy of urging and redeployment.

a) Marcoule Plutonium Extraction Plant (UP 1)

The Marcoule spent fuels processing plant processed the fuel from G2 and G3 according to expectations. The addition of fluorine ions in the extraction solutions made it possible to improve production, the quality of finished products and to reduce the operating personnel as a result of the shutdown of the high activity installations of the plant each weekend.

In addition, a reprocessing operation for plutonium-aluminum fuel coming from the Celestin 1 reactor, performed during the second half of the year, made it possible to recover 50 kg of plutonium with a very high content of heavy isotopes.

The plant thus confronted with the problem of the processing of the fuels with very high rates of combustion was able to test the capability of the personnel and the installations to process the fuels of this type. The experience obtained was advantageous from the prospect of future processing of the fuels from the electric-generating reactors.

The development of a new process with a base of iron and copper salts made it possible to increase significantly the ruthenium decontamination factor during the processing of the effluents at the Marcoule plant.

The general improvements of the operating conditions brought about a considerable lowering of the volumes of effluents produced. Their coating with tar, well developed on an industrial basis, holds the attention of numerous foreign specialists.

b) La Hague Plutonium Extraction Plant (UP 2)

The technical and economic studies undertaken in 1969 on the development of the reprocessing activities of the La Hague center were continued after the official announcement of the putting into service at the beginning of 1975 of a new installation which will assure the particular operations necessary for the introduction of the fuels from the ordinary water system in the reprocessing cycle existing for those of the graphite-gas system.

Two reprocessing operations for the spent fuels coming from the Chinon reactors were performed in 1970. They furnished advantageous information because the fuels had maximum irradiation rates exceeding 3,000 MWd/t.

The operation of the shops, at high mass deliveries of plutonium, has been satisfactory and the products coming out, spent uranium and plutonium, have always been of very good quality.

The high irradiations have shown the necessity of taking additional precautions and of reducing as much as possible the dead time during which the highly irradiated rods are placed in air.

To facilitate the operation with the personnel provided, the studies and automation work at the plant and in the laboratory have been developed and the improved knowledge of the process has made it possible to reduce very considerably the program of the analyses.

Moreover, the operations for recovery of neptunium have been continued. During rinsings in an alkaline medium of evaporators for fission products, concentrated solutions of cesium 137 have been able to be separated and stored for possible treatments in the cesium 137 recovery shop, Elan II B.

Finally, a first drilling operation of spent fuels with graphite cores occurred in the pilot lines at scale 1 of the decladding shop.

B. Plutonium Supply

The civilian (for the Phenix fast neutron reactor prototype) and military national needs continued to be covered in 1970 by the production of the Marcoule and Chinon reactors. At the same time, the deliveries of Canadian spent fuel continued, in application of the contract signed with the Atomic Energy of Canada Limited.

C. Chemical Studies on the Production of Plutonium

Studies on the Processing of the Spent Fuels

a) Processing of the Fuels from the Fast Neutron System

In 1970, the AT1 shop at La Hague processed 576 Rapsodie fuel pins, irradiated on average at 40,000 MWd/t, or about 50 kg of fuel in all. The cutting fuel pin by fuel pin presented no difficulty. The dissolution per load of 27 or 28 fuel pins was done quickly; its progress was followed by measuring the activity

of the krypton in the gaseous effluents, which made it possible to reduce by a third the previously used boiling time. The a posteriori checking of the claddings by a physical process making it possible to monitor instantaneously the presence of fissile materials with a sufficient sensitivity, shows that they virtually no longer retain any fissile material.

The dissolution liquids contain fine blackish particles in suspension, insoluble fission products very difficult to separate on the present filters of stainless steel sintered on account of very fast clogging. A pulsating filter, under study jointly at Fontenay-aux-Roses and at the Marcoule pilot shop, should eliminate this difficulty, while increasing the decontamination factor.

The use of hydrofluoric acid during the operations for extraction by tributyl phosphate has greatly reduced the precipitates of interphases and has made it possible to obtain the desired decontamination factors: $5 \cdot 10^6$ with ^{95}Zr , 10^7 with ^{95}Nb and 10^6 with ^{106}Ru .

If the shop does not separate the uranium from the plutonium, the overall fissile materials loss carried away with the claddings is less than 1 percent.

12724
CSO: 8119/0016

1972

At the UPl plant at Marcoule:

A campaign focusing on several tons of spent fuels (2,000 to 4,000 MWd/t), SiCrAl type, made it possible to verify that there were no problems as far as handling, chemical procedure, performance or production were concerned.

. . .

The "high activity" plants have been harnessed to reprocess UAl (alloy of uranium and aluminum) fuels from the Celestin reactors and fuels for MTR-type research reactors, both French and foreign: the first run will begin in January 1973.

FRANCE

UNKNOWN

//SCIENTIFIC AND TECHNICAL ACTIVITIES 1974 & 1975//

--/--/1974, 1975, V-----, N-----, pp 18-19, 21

Paris

The Hague Plant Up-2 Nuclear Reprocessing Plant

UNKNOWN AUTHOR in French

[Article issued by the Atomic Energy Commission]

[Excerpt] The essential fact about fiscal year 1974 for the Hague Center was that two production units, UP2 (processing metal fuels) and AT1 (processing of "rapid" oxide fuels at Rhapsody), worked all year at a rate very close to target capacity.

In fact, for the first time since the opening of the Center, UP2 and AT1 were able to utilize a sufficient number of programs to test their real possibilities on a regular long lasting production run. As a result, some particularly useful lessons were obtained as concerns equipment reliability and improved procedural performance as a function of time.

In UP2, nearly 650 tons of radiated fuels, obtained from all the graphite-gas (GG)-natural uranium reactors in service, were processed in the course of two runs. During this period, the following were perfected: the new

assembly line to scurf graphite-core fuel elements, the new dissolver fueling device (PAD), the processing of annular fuels from the plant at Bugey, and the plutonium purification process in the third cycle using tributyl phosphate and hydroxylamine nitrate.

The results obtained were very satisfactory, both in yield and in the clearly improved quality of the finished product. On the other hand, average production capacity has been shown to be particularly sensitive to changes in the nature of fuels and to the reliability of certain equipment. Important improvements in this last field have been obtained and must be followed up. One can assume that the problems involved in processing GG fuels have been solved and that the transfer of these activities to the UPl plant at Marcoule will be made without major difficulties.

Moreover, a receiving run in the pool for bare elements from GG plants of twenty-six oxide fuel flasks obtained from three European ordinary water reactors has shown the delicate problems involved in handling and unloading casks containing fuels in bad condition.

At AT1, more than 200 kilograms of uranium and plutonium fuel from the Rhapsody reactor have been processed, thus exceeding the plant's normal capacity. The radiation rates have reached 85,000 MW j/t. Yields from fissile material have been very remarkable, thanks to the perfecting of new operating conditions in the dissolution and the first cycle extraction stages. These results permit us to consider the possibility of reprocessing

radiated fuels in the rapid neutron system by means of water, even at very high rates of radiation, without losing fissile materials which would be incompatible with a satisfactory yield for the whole cycle.

From the standpoint of equipment, 1974 was noteworthy at the Hague Center for the continued progress in the construction of the HAO (high oxide activity) plant and complementary equipment required for UP2 so as to ensure processing of oxide fuels. With work proceeding according to plan, the following projects were underway at the end of 1974: "cold" testing for flask receiving and fuel storage facilities and the third cycle of uranium purification.

In addition, several projects for ventilation and safety were completed in the plant, aiming especially at improving working conditions and the safety of personnel from radiation.

Finally, as pertains to the field of data processing, the new plant acquired and put into service two T 2000-20 calculators destined to replace a system using 2030 processors.

2. ^{The} ~~LA~~ HAGUE PLANT (UP 2)

The essential facts for 1975 concerned, first of all, the very satisfactory opening of receiving and storage facilities at the new HAO plant, and the "cold" test on shearing, dissolution and purification units in this same location.

At the same time, production runs were carried out at UP2 (metal fuel processing), and at AT1 ("rapid" oxide fuel processing at Rhapsody and Phoenix).

At UP2, nearly 500 tons of radiated fuel obtained from all EDF (Electricite de France) reactors of the GG type were processed in the course of two runs.

It was during this period that the following were perfected: the third cycle of uranium purification in centrifuge extractors, the facility for valence IV uranium production by means of hydrogen catalytic reduction, and the new preparation and automatic distribution unit for reagents of the MAU (uranium medium activity) plant, where uranium - plutonium separation takes place.

The results as a whole have been satisfactory, especially in relation to the rate plutonium is recovered in the form of PuO_2 .

However, several difficulties should be noted as regards decontamination in the first and second cycles of extraction due to the aging of the solvent and increased rates of fuel radiation.

In addition, receiving and storage facilities at HAO (upper illustration) were put into active service in January 1975, and after several improvements in water processing, nearly ninety flasks containing a little less than one hundred tons of oxide fuels obtained from the Franco Belgian reactor SENA, the Phoenix reactor and from several boiling or pressurized water reactors have been received and unloaded under very satisfactory operating and safety conditions.

At AT1 (the "rapid" oxide fuel processing facility), after two very satisfactory processing runs for over seventy kilograms of fuel at "Rapsodie Fortissimo" and Phoenix, operations had to be interrupted because of a break in the detachable link on the transporter bridge of the mechanical cell.

12248

CSO: 8119/1696

1977

The Purex process is the one used at the Hague at the UP-2 plant which began operating in 1966. Since that time the plant has received more than 1,300 transport containers, has processed close to 3,000 tons of irradiated fuels from the electrical power production reactors of the "gas-graphite" reactor system, and as such has produced more than 4,000 kg of plutonium.

French Atomic Energy Commission

NUCLEAR ENERGY APPLICATIONS

Annual Report
1978

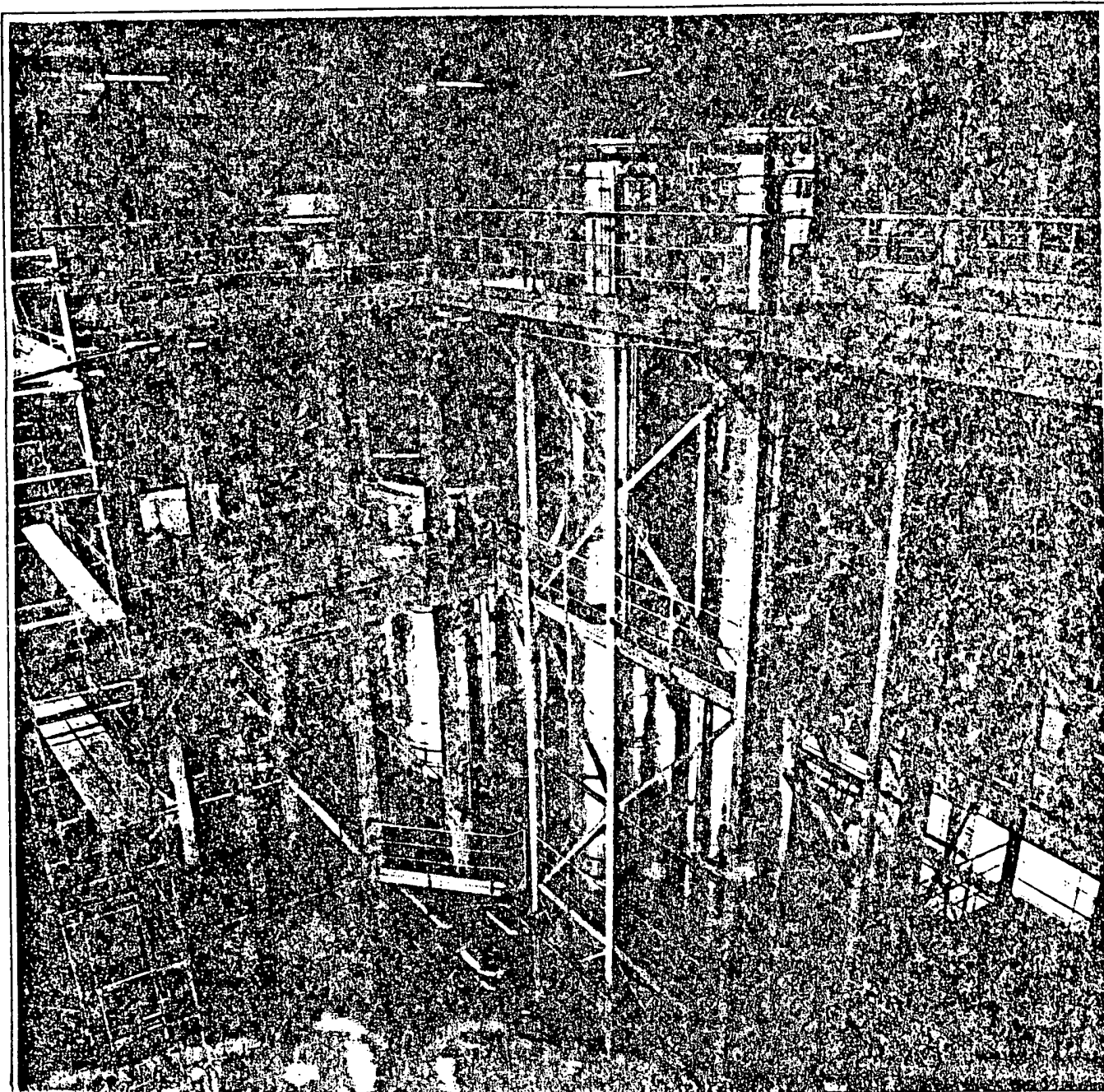

Industry reorganization underway in this area since April, 1976, date of Novatome's creation, is now complete. The last phase of this reorganization was the establishment on March 20, 1978 of the Société de Système Française pour les Réacteurs Avancés (S.Y.F.R.A.), a company whose capital is shared by the CEA (60%) and Novatome (40%). S.Y.F.R.A. is responsible for gathering and reformulating its shareholders' know-how and information in the field of fast neutron reactor systems. The resulting documents constitute the license proposals which the Société Européenne pour la Promotion des Systèmes de Réacteurs Rapides au Sodium, known as S.E.R.E.N.A., a company established under French law, will be in charge of negotiating.

Despite its sound technological lead, France clearly announced that it had no intention of conducting isolated development of fast neutron reactors, which the energy situation makes indispensable for several nations. While taking care to preserve the benefits derived from years of efforts and France's leading role in this field, the CEA has endeavored, in accordance with governmental directives, to develop contacts and promote agreements with domestic and international partners. The industrial agreements associating Novatome for France, N.I.R.A. (1) for Italy and I.N.B. (2) representing a group of West German, Belgian and Dutch industrial concerns, is an illustration of the special ties established among European countries. The negotiations undertaken by S.E.R.E.N.A. should result in industrial and commercial developments involving new partners, through license agreements.

In the field of research and development, agreements range from comparison of general information on fast neutron reactor systems to extensive know-how exchanges and coordination of programs. In addition to the above mentioned organizations, these agreements also involve Great Britain's U.K.A.E.A. (3) the United States Department of Energy, Japan's Power Reactor and Nuclear Fuel Development Corporation and the Soviet Union.

Each year in a slightly broader, more complete context, breeder reactor development comes closer to the goal of alleviating dependence on natural reserves for energy supply.

-
- (1) N.I.R.A.: Nucleare Italiana Reattori Avanzati.
 (2) I.N.B.: International Natrium Brutreaktorbau Gesellschaft, a German company.
 (3) U.K.A.E.A.: United Kingdom Atomic Energy Authority.

Irradiated fuel reprocessing

Closely associated with fast neutron reactor development, the irradiated fuel reprocessing program consists of two basic activities: operation of existing plants and preparation of future industrial-scale facilities.

France's European partners and Japan are also carrying out dynamic reprocessing policies. Thus, the Belgian government signed an agreement in July, 1978 transferring under state control the Mol plant, previously operated by the Eurochemic company, which logically would indicate that a decision will be made to put this plant back in service with a potential capacity of 300 tonnes per year. In Japan, an industrial-scale facility is scheduled for 1990 to replace the Tokai Mura demonstration plant which reprocessed 19 tonnes of fuel in 1978 before shutting down due to an incident. West Germany, where the Wak pilot plant continues to operate satisfactorily, is pursuing studies and preliminary work on construction of an irradiated fuel reprocessing center at Gorleben. In 1978, the firm in charge of building this plant, D.W.K. (1), acquired part of the necessary land and made intensive efforts to secure final approval of the federal government and the state of Lower Saxony. The Gorleben reprocessing plant will have an annual capacity of 1500 tonnes and should be operational by the end of the next decade. It was also in 1978 that the positive conclusions of the public hearing on extension of the Windscale complex were published in Great Britain. The government of this country approved construction of the THORP facility (2), which will have a capacity of 1200 tonnes per year and should be commissioned in the late 1980s.

All of these projects are being carried out in each country according to the spirit of the comprehensive I.N.F.C.E. (International Nuclear Fuel Cycle Evaluation) discussions on improving non-proliferation measures.

In France, research and development has been conducted on extension and renovation of the La Hague UP2 complex. LWR fuel reprocessing capacity of this complex is scheduled to be increased to 650 tonnes annually in 1984 and 800 tonnes at a later date, while maintaining limited capacity for reprocessing some gas-graphite reactor fuel for technical reasons. The decision to build the new UP3A LWR fuel reprocessing plant on the La Hague site has been officially confirmed and studies in progress on this facility include confinement technique improvements facilitating supervision of sensitive materials.

-
- (1) D.W.K.: Deutsche Gesellschaft für Wiederaufarbeitung von Kernbrennstoffen.
 (2) THORP: Thermal Oxide Reprocessing Plant.

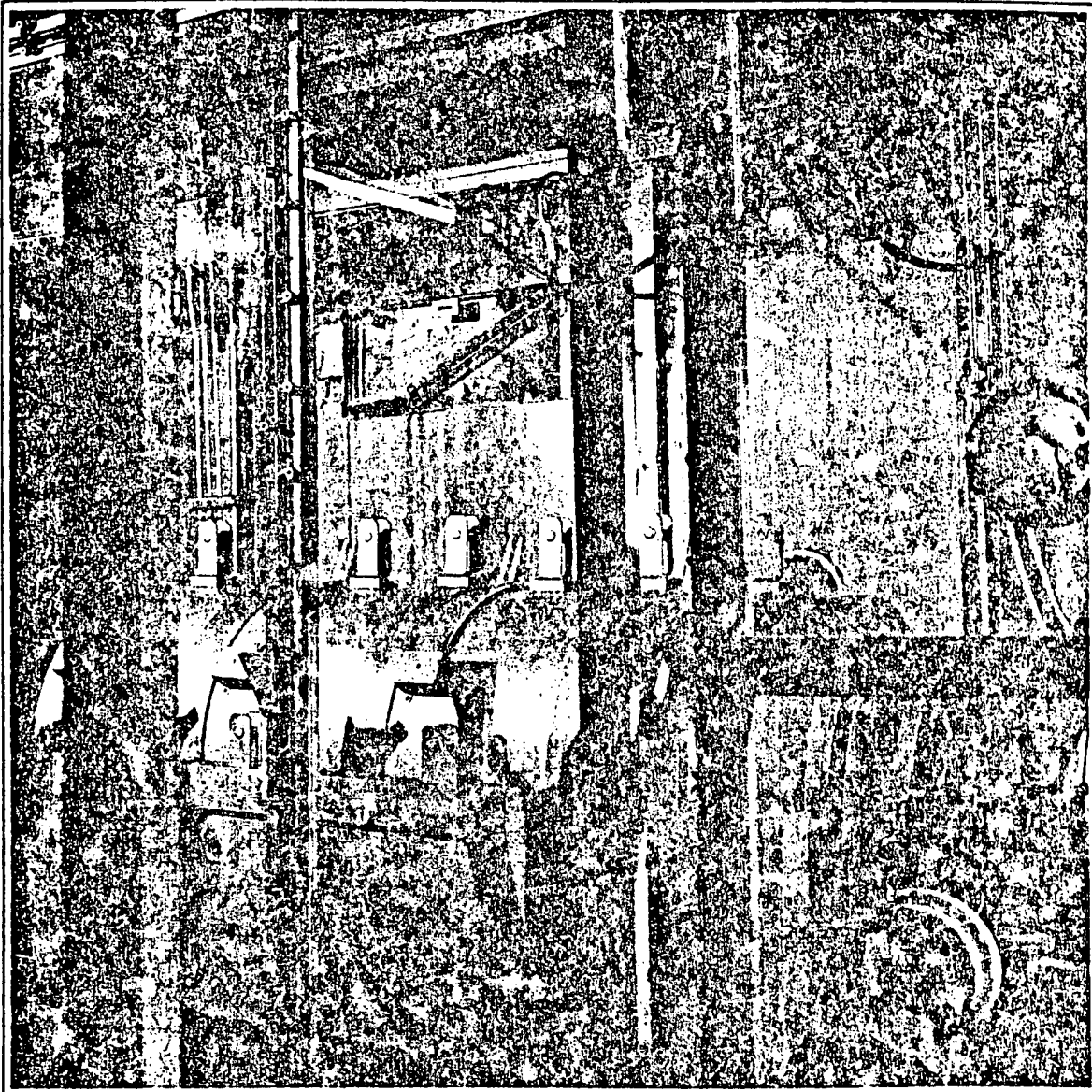

On-line Vitrification Furnace for the New Atlas Facility designed to study gas scrubbing for future on-line vitrification units (Chemistry Division, Radioactivity Engineering Department, at Marcoule).

Special attention is given to constraints related to reprocessing byproducts, primarily by investigating means to limit quantities of waste produced and, for those which are inevitable, by searching for ways to enhance processing and packaging techniques.

The Marcoule Vitrification Facility (AVM Facility) was successfully commissioned in July, 1978, thus demonstrating the validity of the high-level waste solidification process developed by the CEA. Ongoing studies are being carried out to adapt this process to treatment of wastes produced by reprocessing of more intensively irradiated fuels at higher rates in large facilities such as the one installed at La Hague.

A significant proportion of R & D work on reprocessing is being devoted to development of techniques applicable to breeder reactor fuels. The Marcoule pilot facility has successfully repro-

cessed the first (enriched uranium) half-core for the Phénix reactor and implementation of the first UO_2 -PuO₂ (uranium/plutonium mixed oxide) fuel reprocessing program began at the end of the year. These operations thus provide a larger-scale supplement to the experience acquired during ten years of operation of the La Hague AT1 pilot plant.

In addition, mechanical operations constituting the initial phase in reprocessing breeder fuels are being studied intensively and will be the subject of comprehensive prototype experiments.

In order to demonstrate reliability of the reprocessing method employed for these fuels, it was decided in October, 1978 to build a large-scale pilot facility, the TOR (Fast Breeder Oxide Processing) plant, which will be a scaled-up replica of the existing Marcoule plant using part of its equipment. The projected capacity of the TOR plant will permit reprocessing of all Phénix reactor fuel, and

3774

will also provide the possibility to process small volumes of other fast neutron reactor fuels. Construction work has begun and startup of the TOR plant is scheduled for 1984.

To prepare for the next phase, studies began in 1978 on design of the Fast Breeder Fuel Pilot

Reprocessing Plant. Referred to as the PURR plant, this facility will have the capability to reprocess irradiated fuel from the Super-Phénix reactor and subsequent similar-type plants. Commissioning of this plant should be feasible by the end of the next decade.

ACTIVITIES OF THE SOCIÉTÉ GÉNÉRALE POUR LES TECHNIQUES NOUVELLES (S.G.N.)

The Société Générale pour les Techniques Nouvelles is essentially a nuclear engineering firm which became active in 1952 upon receipt of a CEA contract for design and construction of the Marcoule reprocessing plant and ancillary installations.

Originally a Saint-Gobain subsidiary until coming under control of CEA subsidiary Cogema in 1978, the S.G.N. is active in nuclear and chemical engineering, environmental protection and automation. Nuclear activities account for approximately 80% of the company's turnover, which totaled about 200 million francs in 1978.

Engineering work focusses on the fuel cycle back end, particularly design and construction of facilities for reprocessing irradiated fuel elements and radioactive materials. These activities include:

- fuel reprocessing and all related operations, i.e. reception and storage of fuel, processing of decontaminated uranium and plutonium;
- processing of wastes from reprocessing plants, reactors or research centers, for which the S.G.N. utilizes two original CEA processes, namely vitrification (as performed in the Marcoule AVM facility for high-level wastes) and bitumen-matrix encapsulation of medium-level wastes;
- design of medium and long-term processed waste storage facilities;

- design and construction of radioactive materials processing laboratories and research centers (frequently in cooperation with Technicatome for the latter);

- design and construction of special installations or components for radioactive environments, e.g. special gas (iodine or krypton) processing enclosures and fuel element shearing machines.

Most of S.G.N.'s activities in 1978 were related to projects in France, notably the new Cogema reprocessing facilities at La Hague.

The CEA entrusted S.G.N. with design studies on the TOR pilot plant at Marcoule for fast neutron reactor fuel reprocessing.

S.G.N. has also worked for foreign clients on design of research centers, subassemblies and components (Japan, Belgium and Sweden), as well as vitrification facilities based on the CEA process (Germany and Belgium), and this should normally result in future supply contracts.

S.G.N.

An engineering firm with a capital of 26,200,000 francs owned by Cogema (60%) and Saint-Gobain Pont-à-Mousson (40%).

COGEMA

1979

general shareholders
meeting 25 June 1980

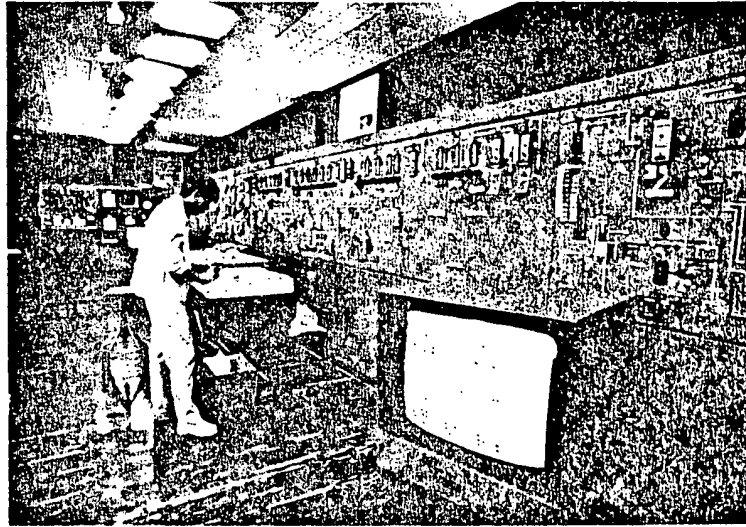

Control room for concentration and storage of fission product solutions (La Hague facility)

reprocessing division

No technical incidents of any significance are to be reported, despite operation at a continuously high rate in both the La Hague and Marcoule establishments.

the La Hague spent fuel processing plant

Spent fuel assemblies processed at La Hague totalled 265 tons from power utility GG reactors, 77 tons from LWRs, and 2.2 tons from FBRs (Phénix and Rapsodie).

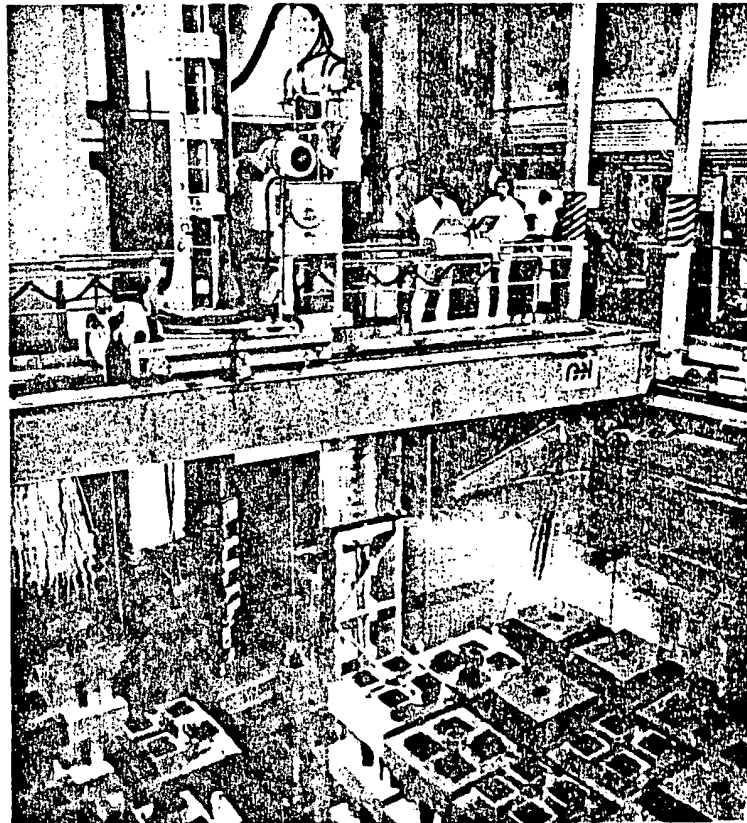

*Storage pond HAO (High Activity Oxide)
(La Hague facility)*

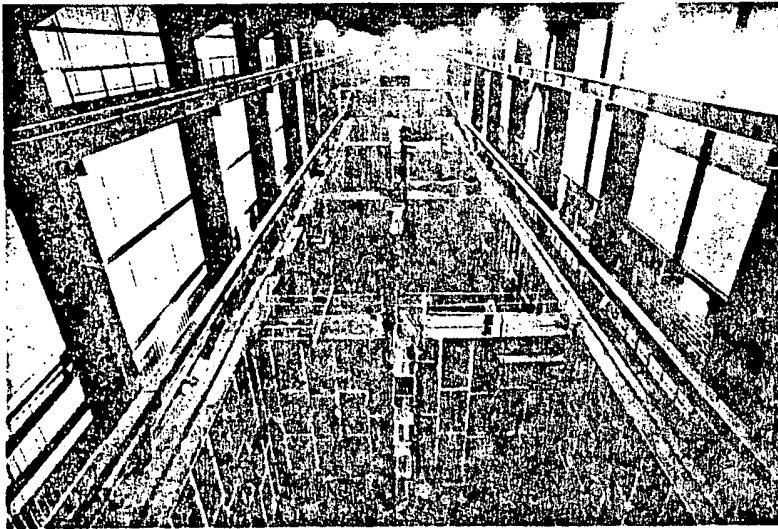

*Construction of the NPH pond.
Capacity: 2 000 tons, light water fuel
(La Hague facility)*

R & D and engineering for expansion of capacity (LWR fuel reprocessing projects UP2 800 and UP3) were actively advanced in 1979, in step with progress in licencing procedures.

The new common fuel storage pool common to UP2 800 and UP3 is now nearing completion, all the heavy civil engineering works and structures having been terminated before the end of 1979.

Files and plans for the other common items are at present being examined by the company in charge of projects engineering, the Société Générale pour les Techniques Nouvelles (SGN).

Application for «recognition of public benefit» of new extensions to the La Hague plant was submitted to the Ministry for Industry by the general administrator of the CEA on March 19th, 1979, with supporting files, and the official public enquiry (local and regional consultation of the public) was closed on June 18th. Information concerning the project was made widely known.

The conclusions of the report established by three experts appointed by the «Préfet» (chief administrative officer of a «Département») of the Manche Département, submitted on the 29th of July, were very favorable.

Finally, the replies to questions raised by the public and local and regional administrative offices, were submitted to the «Direction Interdépartementale de l'Industrie» on October 10th.

Since that time, the licencing procedure has approached conclusion (approval by the «Conseil d'Etat») without any trouble.

The above has of course been accompanied by examination of the preliminary safety reports by the SCISN, the organization entrusted with study and approval of the safety aspects on nuclear base plants.

Entitlement to the special «Grand Chantier» procedure was granted by the authorities. The officer in charge has begun to collect the necessary information while the «Préfet» has started the preliminary phase of program drafting.

Marcoule spent fuel processing facility

280 tons of GG reactor fuel assemblies from the power utility reactors and the Franco-Spanish Vandellos power plant were processed at Marcoule last year, in addition to spent fuel from military sources. The total tonnage was in excess of the load planned at the start of the year.

There was a little trouble in operation of the veteran reactors G2 and G3. As it is known, graphite blocks are subject to swelling under irradiation, which is one of the effects which determine the service life of this facility.

The final shutdown of G2 on February 1st, 1980, was decided at the end of 1979, where as G3 was put back into operation on December 10th, after a scheduled shutdown, and has operated quite satisfactorily since then.

The two Célestin reactors, used mainly to produce plutonium, operated normally throughout 1979.

There is nothing to report of any note concerning the fission product vitrification plant in operation since June 27th, 1978. By the end of 1979, the plant's output was 252 glass-filled drums, for an input of 165 cubic metres.

The plant's design and efficiency continued to attract a great deal of attention, and it was visited by numerous French and foreign nuclear engineers and other specialists.

It was decided last year to invest in new storage pools and decladding shops for GG reactor fuel. A number of other projects are still being considered.

general situation

Spent fuel convoys (another responsibility of our reprocessing division) were numerous last year, and the order book of the reprocessing division is filled to capacity until the start of the next decade.

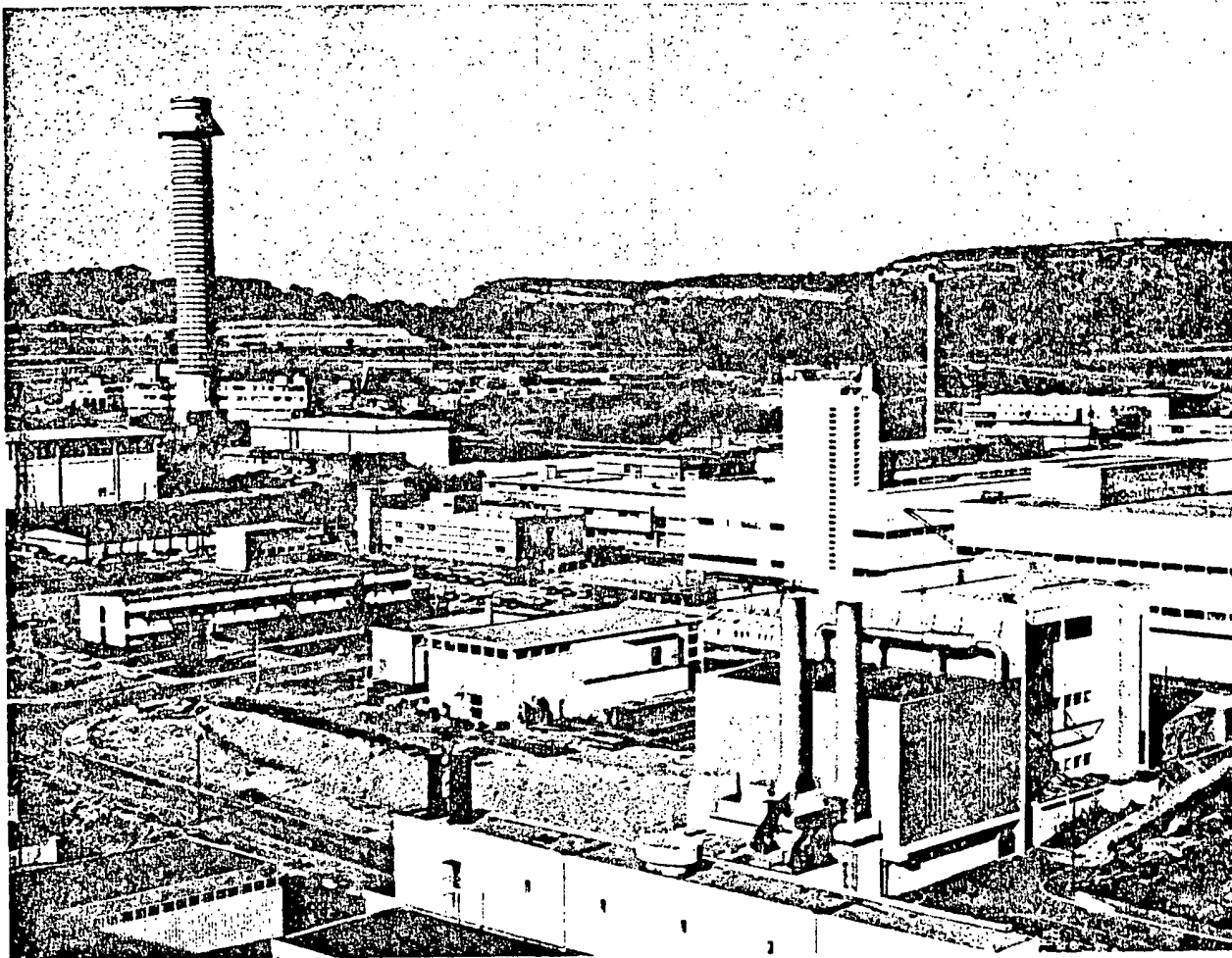

Marcoule facility, vitrification plant at Marcoule and UP₁ reprocessing plant

1980

In 1980 at its two plants in The Hague and Marcoule, Cogema reprocessed:

516 tons of fuel from the plants of the "natural uranium-graphite-gas" reactor system of EDF and from the French-Spanish plant at Vandellós. To this must be added the fuels from the two plutonium-generating reactors G2 and G3;

102 tons of fuel from the regular water reactor system (at The Hague only);

and 1.5 tons of fuel from the Phenix "supergenerator".

FRANCE

COGEMA ANNUAL REPORT FOR 1982

Paris COGEMA RAPPORT ANNUEL 1982, 28 Jun 83 pp 19-25

[Section of the General Nuclear Materials Company's annual report for 1982 dealing with nuclear fuel and reprocessing activities as presented at the regular annual stockholders' meeting on 28 June 1983]

[Text] Nuclear Fuels Division

The year 1982 was marked by the consolidation and organization of structural changes made in 1980 and 1981 in connection with the following:

1. Fuels intended for PWR reactors:

- a) The agreements between COGEMA [General Nuclear Materials Company] and FRAMATOME [Franco-American Atomic Construction Company].
- b) The establishment of FRAGEMA and the CFC as subsidiaries in partnership with FRAMATOME.

2. Acquisition of the SICN.

Fuel for Water Reactors

FRAGEMA and the CFC are general partnerships that were established in 1981 by FRAMATOME and COGEMA as equal partners, the purpose being to better organize their activity in a field that concerns both the boilermaker and the manufacturer of the nuclear cycle.

FRAGEMA's purpose is to design and market fuel for light-water reactors, and in 1982 it managed contracts representing the production of approximately 1,800 fuel assemblies (830 tons of uranium content) and 1,400 clusters.

The qualification program for advanced-type fuel (AFA), which is being carried out in cooperation with the CEA [Atomic Energy Commission], is in the completion phase and will permit the reloading of a power reactor with that fuel in 1984. With technical support from the CEA, FRAGEMA is also preparing for the use of

fuels utilizing gadolinium* as an integrated poison. Those fuels will be loaded into a number of assemblies in 1983.

The CFC, whose purpose is to fabricate fuel, continued construction work on its plant on the Pierrelatte site. The startup of that plant, scheduled for the start of 1984, will result in the industrial production of the first fuel reloads in 1984. The plant produces both standard fuel and advanced fuel (AFA).

Fuels for Breeder Reactors

In 1982, the Nuclear Fuels Division continued construction work on the first core for Super Phenix 1. Using fabrications from the SICN and AGIP-Nuclear [Nuclear Division of Italian National Oil Company], the dummy loading of that reactor took place in July 1982.

Completion of the fissile elements by the CEA Plutonium Shops in Cadarache, of the control assemblies by the SICN, and of the various measuring devices necessary for startup is at an advanced stage and should result in deliveries to the Creys-Malville site in September or October 1983. At the same time, an agreement has been signed with NOVATOME and NERSA covering planning for executing the first two reloads, and procurement of the necessary supplies has started.

Thought is already being given to the post-Super Phenix program, and in that connection, COGEMA continued its preliminary planning for a plant to fabricate fuel for breeder reactors (the FOR project). This phase of planning should be completed in the first half of 1983.

Fuel for Natural Uranium, Graphite-Moderated, Gas-Cooled Reactors

In 1982, COGEMA supplied the EDF [French Electric Power Company] and the French-Spanish HIFRENSA [Spanish-French Nuclear Power Corporation] with 300 tons of standard fuel (for use at Chinon 2, Chinon 3, Saint-Laurent 2, and Vandellós) and 145 tons of fuel for Bugey 1, to which was added G3 fuel from Marcoule.

The corresponding fabrications were provided by COGEMA's usual suppliers, primarily its subsidiary the SICN, Cezus, Lorraine Carbon, Union Carbide France, and the Bologna Ironworks.

SICN Activities

As a result of the gradual winding down of the fabrication program for graphite-gas reactors and the drop in activities related to breeder reactor fuel in connection with delivery of the first core for Super Phenix 1, the SICN made a sizable effort in 1982 to consolidate its diversification activities and develop new fabrications. The following should be noted in particular:

* Gadolinium is used in the fuel as an integrated poison to control reactivity. It permits an increase in specific burn-up and a lengthening of fuel cycles.

At the Annecy facility:

The start of industrial production at a plant manufacturing camshafts for diesel engines and an increase in quartz crystal production.

At the Veurey facility:

The start of a new activity for the production of industrial diamonds.

For the above purpose, COGEMA gave the SICN responsibility for executing the terms of the licensing agreement signed in 1981 between its subsidiary MINERSA and the American Megadiamond firm. A production facility is now being equipped in Veurey. The first press was installed in 1982 after the personnel had gone to the United States to learn the technology. The first synthetic diamond powder was produced in December 1982.

Reprocessing Division

Under the terms of contractual agreements, the Reprocessing Division is responsible for reprocessing spent fuel from the EDF's nuclear power plants and for foreign customers. It also handles the transportation of that fuel between the reactors and the reprocessing plants in La Hague and Marcoule. It is also responsible for the production of plutonium for the Ministry of Defense at special facilities in Marcoule.

This division is also acting as principal in the expansion work underway at the La Hague facility.

La Hague Facility

1. Plant Operation

The La Hague facility continued in 1982 to reprocess spent fuel from the gas-graphite and ordinary water reactors. The quantities of that category of fuel increased considerably. During 1982, the following quantities were reprocessed (in tons of heavy metal--that is, uranium before irradiation):

From EDF power plants using the natural uranium, graphite-moderated, gas-cooled [UNGG] system: 226.1 tons.

From various power plants using ordinary water: 153.5 tons.

In 1982, the plant reprocessed fuel from an EDF ordinary-water reactor (at the Fessenheim power plant) for the first time. The operation took place in very satisfactory technical conditions.

The good results that were achieved prove that the UP₂ plant will be able to reprocess about 250 tons of fuel from ordinary-water reactors annually when it is no longer processing fuels from other types of reactors.

It should be noted, however, that despite the 14-percent increase in the irradiation energy of fuels reprocessed in 1982 ($4,078 \times 10^3$ MWJ) as compared to 1981, the radiological activity of wastes in 1982 was kept at a level comparable to that in 1981 and remained far below the levels authorized by decree. Moreover, the average annual dose received by the personnel directly involved dropped between one year and the next: from 235 mrem per year in 1981 to 215 mrem per year in 1982.

Those results reflect the efforts made to improve operating and maintenance safety in the facilities.

2. Plant Expansion

Following the energy debate in Parliament in October 1981, the authorities authorized COGEMA to continue construction work on the UP₂800 and UP₃ plants in La Hague. As has already been mentioned, that decision was confirmed at the start of 1983 following the conclusion of the first phase of work by the scientific committee headed by Professor Castaing. As far as the engineering is concerned, the SGN firm of industrial architects (and prime contractor) continued its detailed design work for the UP₃ plant's various shops during 1982. The final touches are being put on those designs in cooperation with COGEMA.

Work on the detailed design of the various plants constituting UP₃, part of the UP₂800 unit, and the facilities shared by those two plants was therefore actively pursued in 1982 by the SGN as prime contractor in cooperation with TECHNICATOME, USSI, and TECHNIP. In the course of 1982, 2.5 million hours of engineering were devoted to those plans.

The actual work was essentially resumed in the spring of 1982 in accordance with the government's instructions. It was concerned primarily with the following:

1. Construction of new facilities for concentrating and storing fission products as well as converting and storing plutonium.
2. Construction of Pool C (2,000 tons), work on which progressed very normally with a view to placing it in service toward the end of 1983.
3. Civil engineering work in connection with the new Pool D (2,000 tons) and the To dry discharging shop. This work began in 1982.
4. Construction of the new liquid waste treatment station (STE3), which was started in 1982, as was site preparation work for the UP₃ plant's various shops. The latter consisted of earthwork for the building sites and approaches, excavation for the foundations of some of the shops, and the construction of temporary on-site facilities for the industrial architect and prime contractor (the SGN) and the various contractors.
5. The start of construction on the UP₃ complex with the startup of work for the T₂ high activity shop.

6. In addition, and in cooperation with local and departmental authorities, a number of miscellaneous operations relative to amenities as provided in the "Major Worksite" procedure adopted for the expansion of La Hague were undertaken. They are concerned primarily with facilities for the workers from outside and their families and with improvements to the road system.

In total, as of the end of 1982:

An amount of 5,266 million francs had been earmarked for expansion of the two plants, and 3,092 million francs had been paid out.

Manpower on the worksite totaled 2,100 persons, and their number was continuing to increase at the start of 1983.

Marcoule Facility

As in previous years, the Marcoule facility operated the UP₁ plant in Marcoule and the plutonium-generating reactors and provided support for the units set up by the CEA.

Operation of the Celestin reactors in 1982 does not call for any special comment. As far as the G2 and G3 reactors are concerned, the CEA-UDIN [Central Unit for Downgrading of Nuclear Installations] took over as operator of the G2 reactor on 1 February 1982, COGEMA-Marcoule having completed its work for the permanent shutdown of that reactor as planned with the approval of the IPSN [Nuclear Safety Protection Institute], the agency concerned with safety. The G3 reactor underwent major maintenance in the middle of 1982 in preparation for beginning a new operating cycle.

The UP₁ plant and its associated decladding shop were responsible in 1982 for the reprocessing of the following:

1. Spent fuel from the EDF's UNGG reactors: 113.6 tons.
2. Spent fuel from the UNGG reactor in Vandellos, Spain; 189.4 ^{tons} Fuel from reactors supplying the plutonium required by the Ministry of Defense was also reprocessed.

Once again in 1982, it was confirmed that the pace of reprocessing operations depends on the operation of the mechanical decladding shop. For that reason, the Marcoule plant made every effort to prepare as well as possible for the active startup of the new MAR-400 unit for storing and decladding spent fuel.

In addition to improving operating conditions, that facility will enable the plant to process containerized fuel from the EDF's UNGG reactors at Chinon, something that is not possible at present.

The Marcoule vitrification shop, which is still attracting considerable international interest, produced 179 containers of glass in 1982, corresponding to 135 cubic meters of fission products.

Lastly, work to establish an investment program spread over several years and intended to renovate the plant's production and support facilities continued during 1982, with special attention being paid to the layout of the new liquid waste treatment station.

Transportation of Spent Fuel

As regards the transportation of spent fuel--the tonnage of which, in the case of fuel from ordinary-water reactors, is increasing steadily--1982 was marked by two important events:

1. The opening on 4 May 1982 of the new railroad terminal in Valognes. The result is that packages of spent fuel shipped by rail can be routed from there to La Hague by truck. Designed to meet the future needs of La Hague, this new terminal makes it possible to avoid handling those packages in Cherbourg's immediate suburbs and to reach La Hague by a route that avoids all urban areas.
2. The launching on 3 May 1982 and commissioning in November 1982 of a ship named the "Sigyn." It was built by the Le Havre Shops and Shipyard with financing by Sweden's SKBF [Swedish Nuclear Fuel Supply Company]. The ship, which has a French crew, will carry spent fuel from Swedish nuclear power plants to the port of Cherbourg.

11798

CSO: 8119/0938

FRANCE

EXCERPTS FROM 1983 CEA ANNUAL REPORT; REPROCESSING

Paris CEA ANNUAL REPORT, 1983 in French 1984 pp 24, 27, 28, 83

[Text] Natural Uranium, Graphite-Moderated, Gas-Cooled Reactors

The six reactors of the UNGG [natural uranium, graphite-moderated, gas-cooled] system still in operation represent an installed capacity of 1960 MW(E), to which there must be added 480 MW(E) from the Spanish reactor of Vandellos of which the French Electric Company (EDF) holds 25 percent of the production. In 1983 they produced 6 percent of French electrical energy of nuclear origin, a figure which is the lowest of those recorded to date. This is due in part to the extension of the PWR system, but also to the reduced operation of the UNGG reactors during the past year.

The problems of corrosion of the steels by hot carbon dioxide (temperature greater than 380 degrees C) which appeared particularly in 1982, will give rise, in 1984, to considerable service of Chinon A 3. Moreover, to avoid the loss of reactivity due to hydrogenated deposits of the Eugey 1 reactor, it has been decided to feed it with slightly enriched (0.7 percent) fuel. This solution had been contemplated since the project study when the necessity of injecting methane to fight corrosion of the pile-up of graphite appeared.

For this system, the NEC provides a technical follow-up of the installations and assistance to the user, EDF, as a function of the needs which appear. It plays a special role with regard to the use of the fuels made by Cogema, fuels which retain a very high rate of reliability.

Reprocessing Spent Fuels

In this field, the research and development activities were marked in 1983 by five important stages:

1. The start of construction, at the La Hague site, of the large shops of the future UP 3 plant, which was made possible by the results previously obtained in the laboratories of the NEC and the research offices of SGN and whose development, however, from now on will exert a very strong constraint on the R and D programs to end in the next few years;

2. The completion of the main phases of construction of the TOR [Processing of Fast Oxides] project for expansion and modernization of the Marcoule pilot plant which will allow installation of the equipment, and performance of tests in an inactive medium, starting in 1984;

3. The reorientation of the Cogema plant project for the fuels of the fast neutron system, the size of which was reduced, but whose timetable was met in order to meet the 1986 schedule. This gives priority to research connected with the most specific innovations of the project;

4. The emphasis on the activities directly connected with reprocessing; on the one hand, studies for the management of the "exotic" fuels (experimental, damaged, etc., that cannot go directly through the Cogema plants) and on the other hand, the development of techniques for dismantling operations of the nuclear installations;

5. The beginning of consideration of the recommendations of the Castaing working group, whose report was published at the end of 1982, particularly concerning the research on the thorough reprocessing and on handling of spent fuels, by ways other than immediate reprocessing.

In the field of water reactors, studies on the chemistry of technetium, a destabilizing element for the extractions, and on the use of new reagents, such as hydrazine carbonate, facilitating the handling of wastes, were performed at Fontenay-aux-Roses. A new oxidizing dissolution process for plutonium oxide was developed. The theoretical work of designing the operation for the extractions in pulsed columns progressed.

At Marcoule, the various prototypes of UP 3 equipment were used. The chopper was used to develop, in cooperation with SGN, the most fragile components; the continuous dissolver, "bucket wheel" type, underwent tests for mechanical endurance and for dissolution of uranium oxide; the bank of the ring column was extended and the operation, after coupling the columns, was able to be tested; the prototype of the acid recuperator, under reduced pressure, was installed; a revolving bowl percipitator of plutonium oxide was studied for Cogema.

Other tasks in support of the chemistry activities were also pursued. These include the mechanical reliability studies for the wheel dissolver, research on the materials resistant to corrosion in a nitric medium, particularly on zirconium and its alloys, development of the methods of automatic and remote analysis (by fiber optics), the experimentation at La Hague for the nuclear instrumentations planned for UP 3, particularly to measure the rate of combustion of the assemblies at their entry into the plant.

Moreover, the NEC is conducting activities to promote the modern means of remote operation. In 1983, a mechanical remote manipulator produced by French industry was tested for a long time; the satisfactory results enabled Cogema to pass control of a series of the French supplier. An electronic and programmable remote manipulator, designed by the NEC, is

also being tested to provide many more possibilities for remote operation in the plants.

With regard to the system of fast neutron reactors, the rating of the process for storing spent fuels in water has been brought to term; a plant of this type will be built on the Creys-Malville site.

The process of breakdown by cracking of the hexagonal fuel tubes was successfully tested, for the first time in active medium, on elements coming from the Phenix reactor. Its use is contemplated in the Marcoule ISAI installation, then later, in the Cogema plant project. The continuous dissolution of very spent (100,000 MWd/t) fuel pins was undertaken in a shielded channel at Fontenay-aux-Roses where the behavior during the nitric attack on the various types of cladding was observed. The main effort, devoted in 1983 to specific equipment, dealt with the design study of a continuous dissolver with a helical ramp, a first version of which will be mounted in TOR in parallel with the standard batch dissolver.

In addition to the laboratory research, the NEC contributes significantly to the definition of the basic data on the new Cogema project (MAR 600) intended to reprocess industrially the fuels of the first breeder reactors, by taking over the preliminary study of the process diagrams.

The Marcoule pilot plant (SAP) had a regular operation during the first half of 1983; 1600 kg of uranium and plutonium were dissolved and 300 kg of plutonium extracted. During this period, various measurements and observations were made, including an evaluation of the fission products, followed by neptunium, a test of the trapping of iodine on zeolites, experimentation of the processing of the solvent by hydrazine carbonate. The activity of the SAP was then stopped, the progress of the developments of the TOR project having made it possible to undertake, in the second half of the year, the connections with the rest of the pilot plant. Final construction work and the start-up tests in an inactive medium will be carried out in 1984.

As part of the international cooperation of technology transfer, in addition to the exchanges with Great Britain which occur regularly, negotiations with other countries having plant projects, such as the Federal Republic of Germany and Japan, took place in 1983.

Reprocessing of Spent Fuels

1983 confirmed the expertise acquired by Cogema in the field of reprocessing fuels of the regular water system. The plant at La Hague reprocessed 221 tons of this category of fuel in 1983. Since the HAO [High-Level Oxide Shop] head was placed in service in 1976, the cumulated processed amount represents more than 50 percent of the world tonnage. The installations at La Hague and at Marcoule have, in addition, reprocessed 214 tons of civilian fuel from the UNGG system.

The important program for expansion of the plant at La Hague, undertaken several years ago, was actively pursued in 1983. The new installations of average plutonium activity and the new building for storage of the plutonium were placed in service.

At Marcoule, the unit for storing and decladding of the MAR 400 spent fuel went into the operational phase in September. Moreover, the project for a new station for processing effluents should be presented in 1984. Finally, in the shipping field, Cogema took a 24.26 percent share in the Transnuclear company during the year.

12724

CSO: 8119/14

END

APPENDIX 8

Articles on the French Nuclear Program

JPRS-TND-84-029

27 November 1984

WORLDWIDE REPORT NUCLEAR DEVELOPMENT AND PROLIFERATION

CONTENTS

ASIA

JAPAN

Briefs

End to Plutonium Shipments Urged 1

PEOPLE'S REPUBLIC OF CHINA

Official Relates Nuclear Energy Development
(Li Wen; Beijing Domestic Service, 15 Oct 84) 2

Beijing TV Shows Nuclear Submarines, Missiles
(Beijing Domestic Television Service, 27 Oct 84) 4

PHILIPPINES

Tolentino's UN Trip, USSR Access to Plutonium Disposal
(Vic Barranco; ANG PAHAYAGANG MALAYA, 11 Sep 84) 5

EAST EUROPE

BULGARIA

Kozloduy Nuclear Power Station Announces Job Openings
(VECHERNI NOVINI, 14 Oct 84) 7

Scientists Issue Appeal Against Nuclear Danger
(BTA, 30 Oct 84) 11

HUNGARY

German Sale of Technology for Hungarian Nuclear Power Plant
(NUCLELEC, 11 Oct 84) 12

FRANCE

CFDT VIEWS, PROPOSALS ON MARCOULE, REPROCESSING

Orsay LA GAZETTE NUCLEAIRE in French Jan-Feb 84 pp 2-11

[Text] Introduction

* In view of the deceptive tricks in the energy debates carried on by the authorities when governments of the Right were in power, but also at the end of 1981 for the consultations with Parliament;

* In view of the growth of pressure groups assaulting local public opinion and engaging in acts of blackmail against employment, arguing that the choice is between fast breeder nuclear reactors or unemployment at the Marcoule site, the members of the CFDT [French Democratic Confederation of Labor], an organization which is part of the government majority, decided on 30 April 1983 at its General Assembly, which met at Goudargues in the Department of the Gard to make its point of view known to the public:

—on French energy policy,

—on the situation affecting nuclear electricity generating equipment,

—on the suitability of the RNR [fast breeder reactor] system,

—on the problems raised by the reprocessing of spent radioactive fuel, which CFDT workers are very familiar with, as we deal with them every day,

—and finally on the situation affecting the Marcoule site in this context in order to present concrete and realistic proposals.

As far as the CFDT is concerned, it is essential to state things very clearly: the situation affecting the Marcoule plant is a matter for concern and its future will be seriously endangered if sufficient account is not taken of the views of CFDT members.

This is the reason this pamphlet was prepared.

In doing this the CFDT local union at Marcoule is well aware of not having chosen to present an overly optimistic view of the facility or simplified and overblown slogans.

On the contrary, the CFDT union has deliberately chosen a complex and difficult path to follow:

—telling the truth, which often is disturbing,

—speaking carefully, which it is essential to do in the context of the present crisis,

—displaying an attitude of solidarity in rejecting any narrowly partisan attitude in dealing with a problem which concerns the whole country.

This contribution will therefore be added to the already numerous publications issued by the National Atomic Energy Union (CFDT) and those issued by the CFDT itself, which the local union at Marcoule totally supports.

I - Energy Policy

The possession and control of energy have always preoccupied mankind since governments have been established.

In 1974 the government of Prime Minister Messmer, taking advantage of the petroleum crisis provoked by the multinational oil firms, undertook an extremely ambitious nuclear energy program. After the policy of "everything from oil" the policy of "everything electric, everything nuclear" was initiated.

Since then, while not condemning this recourse to the use of nuclear energy for peaceful purposes, the CFDT has made clear it was opposed to this government program.

Over the years since that time the evolution of events was to prove that the CFDT was right.

1 - Forecasts of Energy Consumption

1.1 - Total Energy Consumption

(a) Historical Background

Since 1970 the official forecasts on the consumption of energy in France have been marked by errors and overestimates, which led those making the forecasts to revise them downwards, as the following table shows:

1.2 - Consumption of Electricity

(a) Successive Forecasts

As in the case of total consumption of energy, the forecasts on the consumption of electricity were overestimated:

Date of the Forecasts	Forecasts
1974 - EDF [French Electric Power Company]	500 GWH [Gigawatt Hours] by 1990 and 1,000 GWH by 2000
1980 - President Giscard d'Estaing and Prime Minister Barre	450 GWH by 1990 and 688 GWH by 2000
1981 - Hugon Report (high assumption)	416 GWH by 1990
1981 - Hugon Report (low assumption)	363 GWH by 1990
Prior to 1980 - EDF	350 GWH by 1985
Present Estimate - EDF	315 GWH by 1985

In reality the consumption of electricity was as follows:

1981	258 GWH
1982	295 GWH

Forecast by the CFDT:

In 1980 the CFDT estimated consumption of electricity by 1990 at 350 GWH.

1.3 - Recapitulation: Adjustment of Forecasts

For the preparation of the Ninth State Plan the forecasters presented the results of their reevaluation of the forecasts for 1990, as published in the Hugon Report. This involved a simple adjustment, but the more precise adjustment should not have led to very different figures. The adjusted forecasts prepared for the Ninth State Plan were as follows:

	1985	1990
Total Energy Consumption in MTEP	192.2	201.0 - 216.5
Electricity Consumption in GWH	295.0	345.0 - 367.0
Coal Consumption in MTEP	25.1	27.4 - 31.2
Hydrocarbons in MTEP (Petroleum and Natural Gas)	107.3	93.2 - 100.4

We note that the figure of 220 MTEP estimated by the CFDT for total energy consumption in 1990 is very close to the revised official estimates and that the figure of 350 GWH for the consumption of electricity is well within the upper and lower limits of the above table.

Once again, we say that the official figures were inflated and that reality has confirmed the correctness of the CFDT forecasts.

Finally, we recall that the revised forecasts reflect an economic growth assumption of 2.2 percent for the period up to 1990 and of 4.6 percent from 1990 to 2000, which is far from zero growth.

2 - Meeting Energy Needs

To meet the energy needs of the country, having in mind the objective of maximum independence of foreign sources, the government has the following resources available to it:

- Hydroelectric power
- Coal
- Hydrocarbons: petroleum and natural gas
- Nuclear energy
- So-called "new" types of energy
- Energy savings

After the phase of "all petroleum-based energy," French governments began the "all nuclear" phase which, in the view of the CFDT, is just as dangerous.

2.1 - Hydroelectric Power

There was no change noted in this area between 1970 and 1980. Power from this source has stabilized at 14 MTEP, which is the same as the forecasts.

2.2 - Coal

There has been a decline in the use of coal, which reportedly will go down from 31.5 MTEP in 1981 to 25.1 MTEP in 1985. This decline comes from a reduction in the consumption of coal for electricity generation by EDF (15.5 MTEP in 1981 and 7.6 MTEP forecast for 1985), caused by overcapacity in nuclear-generated electricity facilities. This falling off in French coal mining, which employed 234,000 miners in 1959 and 61,500 miners in 1980, will continue unless remedial action is taken. This is because at so low a level of production many coal deposits would no longer be exploitable, and the deficits they record would be intolerable for the community as a whole. Coal, which is an unquestionable national source of wealth, after having been the victim of the "all petroleum-based energy" strategy, will be definitively brought to the point of collapse by an "all nuclear" strategy.

2.3 - Hydrocarbons (Petroleum and Natural Gas)

Consumption progressively declined between 1970 and 1974, increased slightly until 1980, and then began to decline again in 1981 and 1982. Consumption went down from 132 MTEP in 1973 (117 MTEP in petroleum + 15 MTEP in natural gas) to 115.4 MTEP in 1981 (90.7 MTEP in petroleum + 24.7 MTEP in natural gas). In 1980 the Barre cabinet forecast consumption of 68 MTEP in petroleum and 42 MTEP in natural gas in 1990. Present forecasts (107 MTEP for 1985 and 100 MTEP in 1990) confirm the decline in the use of hydrocarbons in overall energy consumption. Excess refining capacity and the continued validity of natural gas contracts with foreign countries (Algeria and the USSR) will raise serious problems of employment in the petroleum sector.

2.4 - Nuclear Generation of Electricity

2.4.1 - The Uranium Market

* It is presently very soft, due to the reduction in nuclear programs throughout the world. The price of uranium, contrary to the experience with other sources of energy, has steadily declined for several years, placing several producing countries such as Niger in serious financial difficulty.

* World reserves of uranium are substantial and dependent on the cost of extraction which producers are willing to pay. By contrast the sales price depends on the relationship existing between supply and demand.

* Thus, presently weak demand has led to relaxation in the prospecting effort, which threatens to be harmful in the coming decades.

* An increase in costs will result from this situation, but this will only be temporary and will not raise a question about the importance or even the necessity of nuclear energy programs.

2.4.2 - At the End of 1982 Installed French Nuclear Generated Electricity Centers Were As Follows:

—Older Nuclear Generators	8 Units	2,335 MWe*
—Phenix RNR	1 Units	233 MWe
—PWR [Pressurized Water Reactor]	21 Units	19,060 MWe
TOTAL		21,628 MWe

*MWe are Megawatt Years

About to Enter Into Service:

—PWR 900	4 Units	3,600 MWe
----------	---------	-----------

Units to Enter Into Service Before 1985:

--PWR 900	6 Units	5,400 MWe
--PWR 1300	5 Units	6,500 MWe

Units to Enter Into Service Before 1990:

--PWR 900	3 Units	2,700 MWe
--PWR 1300	13 Units	16,900 MWe
--RNR SPX 1	1 Unit	1,200 MWe

By 1990 total installed capacity will be 57,928 MWe. However, according to the EDF, the available capacity will be 56,000 MWe, taking into account possible stoppages and delays in starting up.

2.4.3 - Load Factor and Available Power of Nuclear Powered Electricity Generators

To achieve the best return, it is necessary for nuclear powered electricity generators to operate from 6,000 to 6,200 hours per year. Therefore, they need to have a load factor of about 70 percent.

Under these conditions the installed nuclear powered electricity generating plant of 56,000 MWe (EDF estimate) by itself will be able to provide all of the electricity which France will need in 1990, or 350 GWh.

This extreme position is impossible to reach because it will be necessary to cover variations in load with oil or coal-fueled electricity generators. In any case it will also be necessary to use the 70 GWh of electricity generated by hydro-power.

It is generally accepted that the role of nuclear generated electricity, taking into account the flexibility required of the electrical network, cannot exceed 70 percent of the total. On the basis of 350 GWh of electricity forecast to be consumed in 1990, nuclear power will not be able to provide more than 245 GWh. That means that nuclear powered electricity generators will operate with a load factor of about 50 percent, which is below the threshold of the most efficient return.

2.4.4 - Consequences

The consequences of having too large a number of French nuclear powered electricity generators will be serious and will lead to a crisis situation. The principal aspects of this crisis include the following:

(a) Underutilization of PWR Reactors

With the 56,000 MWe of capacity of French nuclear powered electricity generators producing 245 GWh annually by 1990 and with a load factor of about 50 percent, there will be considerable economic waste. They will be operating for 4,400 hours per year instead of 6,000 to 6,200 hours per year.

Date of the Forecasts	Forecasts for 1985 *
1970	300.0 MTEP
1973	284.0 MTEP
1974	240.0 MTEP
1975	232.0 MTEP
1978 (High Assumption)	230.0 MTEP
1978 (Low Assumption)	215.0 MTEP
1980	219.0 MTEP
1981	197.0 MTEP
Present Forecast	192.2 MTEP

In reality, the total consumption of energy by year was as follows:

1979	193.5 MTEP
1980	191.7 MTEP
1981	188.0 MTEP
1982	185.0 MTEP

* MTEP: Millions of Tons of Petroleum Equivalent

(b) Positions of the CFDT

Beginning in 1975, on the occasion of the preparation of the Seventh State Plan, the CFDT commented that "it was illusory and dangerous" to forecast a doubling in the total consumption of energy in 15 years and a doubling in the consumption of electricity in 10 years.

The CFDT proposed as an objective the consumption of 220 MTEP by the year 1990, a figure which now looks quite reasonable, considering the actual consumption of energy.

Of course, the assumptions regarding economic growth were more robust. However, the official forecasters were, above all, the producers of energy who inflated their figures to justify an exaggerated scale of investments, to the detriment of other sectors of national economic activity, which by now have been bled white.

(b) Non Use of Coal

Taking into account the 70 GWH of electricity produced by hydropower, there will only be about 20 GWH to be produced by coal, or one-third of the 1981 level. This continues the decline in the use of coal over the 1985-1990 period.

(c) No Use for the Fast Neutron Reactor

As the PWR plant already installed or planned to be installed will be in excess of needs, there will be no energy justification for the development of the RNR system for an additional 1 or 2 decades, and there is a risk that this technology will be obsolete after that.

(d) Little Need for Development of 'New' Forms of Energy

This particularly applies to renewable forms of energy, such as solar power.

(e) Little Incentive for Energy Savings

This will especially be the situation when the EDF will have to sell its surplus electricity generating capacity.

(f) Sale of Electricity to Foreign Countries

There is nothing very certain about this, as it is difficult to imagine a neighboring country or government which would turn itself over, its hands and feet tied, to France, in so vital an area as its supply of electricity. No estimate of potential electricity exports has been developed by the EDF, and potential sales contracts could only be on a short term basis to fill a temporary gap.

2.4.5 - A Crisis Situation

The French nuclear industry, because of the obvious surplus capacity being developed under the program, is moving into a crisis situation:

—Few Or No Immediate Orders for Equipment

The nuclear electricity generating industry (under the program implemented between 1974 and 1981), in the mind of its promoters, was to be split rather rapidly between the domestic and the export market. This has not happened. The export market has not developed, despite the cries of triumph of former Prime Minister Chirac, who wanted to sell nuclear electricity generators to Iran.

This industry is capable of producing six PWR plants per year. In the mind of the forecasters, of the six units per year, four were initially to be built for France and two exported. Ultimately, two would be built for France and four exported, for example.

--In that area there was also an error made in the forecasts.

As it was originally envisaged that the reactors would eventually be replaced after 20 years of operation, the surplus capacity of the nuclear industry therefore threatens to be long lasting.

The foreign market for reactor sales is not very large, and there is competition with a number of foreign companies.

The economic recession explains in part the stagnation in the demand for electricity. However, this does not explain everything and in particular why the role of nuclear energy is not increasing in any country other than France. In fact, many countries have concluded that "betting on nuclear energy" is not worth the trouble of being tempted on so large a scale and that coal is preferable for the generation of electricity.

* Estimated Potential for the Construction of PWR Reactors Too High

With a capability of building six PWR's per year, it is quite clear that the French nuclear industry is moving toward a very serious crisis in economic terms and in social terms as well, due to the consequences for the workers. The government decided on 27 July 1983 to build two PWR's in 1983-84 and one or two PWR's in 1985. Clearly, problems of employment will be raised, and the reconversion of part of this industry should be considered, beginning right now.

* No Foreign Orders

Overall strategy in the nuclear industry has been based on high power units, which are difficult to sell to small countries. It is feared that a market for nuclear generators of the 300 MWe type will not develop or that France will not be able to enter this market.

2.5 - Proposals of the CFDT

The CFDT made reasonable proposals, but no one accepted them. For 1990 these proposals may be found in the following, comparative table, published in 1980 and stated in GWH.

	Barre Estimates (1980)	Hugon Report (1981)		CFDT (1980)
		(High)	(Low)	
Hydroelectric Power	64	65	65	80
Coal	30	20	30	90
Nuclear	330	270	298	140
Heavy Fuel Oil and Various Other Fuels	26	7	23	40
TOTAL	450	362	416	350

Under this CFDT estimate we would have built about two nuclear power units per year, which would have allowed the nuclear electricity generating industry to operate smoothly, reaching a point where the replacement of nuclear power units at the end of their useful lives would have constituted a substantial role. The domestic coal industry would have been allowed a place in the overall energy picture sufficient to prevent the collapse of the coal market. There would have been coal production but also production for coal loading ports, transportation facilities, etc.

At the point where we now stand there is no longer any alternative to reconverting part of the nuclear power industry, which still has several years of work to meet orders presently on hand. It will be necessary to use these years to prepare for other kinds of production, because in addition to the nuclear area itself this reconversion effort involves civil engineering, the electromechanical industry, electronics, data processing, metallurgy, etc. It is therefore possible to find for the nuclear power industry work for the export market involving medium sized developing countries. For example, work that could be done might include:

—Hydroelectric generating plants.

—Thermal-powered electricity generators, particularly those using coal, but also those which use fuel oil or natural gas as fuels.

—The rational use of energy.

—New and renewable forms of energy.

In France the nuclear powered electricity generating industry could contribute to the development of co-generated heating networks involving the rational use of energy.

Rather than spending 10 to 15 billion francs per year to build useless nuclear power plants, wouldn't it be better to help the French nuclear industry to restructure and modernize itself in order to take part in the world market in those sectors where French industry has a certain advantage?

II - The Fast Breeder Reactors (RNR)

1. Characteristics of This System

1.1 - The Official View

These characteristics are stated in energy and political terms and have been broadly disseminated by the French Atomic Energy Commission (AEC), but still in a merely qualitative and incomplete way:

(a) A Very Substantial Increase in Our Reserves of Uranium

This can be achieved by the transmutation of our very abundant supplies of uranium 238 into usable plutonium 239. This involves multiplying our reserves by a factor of 50 to 70 times, making France as rich a country as Saudi Arabia!

(b) Improvement in the Security of Nuclear Energy Production

This involves a reduction in the rate of overall radiation of the workers, based on the results of very encouraging tests of the "Phenix" reactor at Marcoule and on the very small amount of uranium required to be mined.

(c) Self-Sufficiency for France in Our Production of Electricity

This is to be achieved both in terms of technology (the RNR system is specifically French) and of our supply of uranium (upgrading uranium 238).

(d) Possibility of Using RNR's to Burn Plutonium

This would involve burning plutonium and other, long-lived radioactive elements.

1.2 - CFDT Viewpoint

The principal official arguments involve two serious errors. On the one hand they do not set out the advantages of the RNR system in viable, quantitative terms. On the other hand they omit a certain number of aspects of major importance. Also, while accepting the preceding official argument it is essential to set down clearly the impact and the limits of this point of view.

(a) Yes, the RNR's make it possible to make savings on the use of natural uranium. However, the figure of multiplying our reserves by a factor of 50 to 70 times would not be achieved for several centuries and maybe not for 1,000 years. This could only be achieved on the basis of the construction of a very complex and very expensive nuclear industry and would require the processing of enormous masses of plutonium amounting to tens of thousands of tons.

In effect:

* Very precise studies have shown that the gain in natural uranium using RNR's, as plutonium becomes available, would not make it possible to hope for savings of much more than 25 to 30 percent over a period of 80 years, on the basis of our present consumption (see table in paragraph 1.1).

* Studies made by the AEC have even shown that the temporary introduction of RNR's with a low breeding capacity (the "Superphenix" reactors now under study) would be rather negative for the availability of uranium. From this point of view it would be better now to seek to obtain the maximum amount of plutonium produced by the PWR reactors, while uranium is abundant, rather than to burn uranium in the RNR slow breeder reactors.

* Finally, the amounts of plutonium that would need to be processed would be substantial because the energy which is intended to be derived from the very abundant supplies of U 238 would necessarily involve its conversion into an equivalent amount of plutonium.

(b) Yes, the rate of radiation of the personnel working at "Phenix" reactors will be less than that to which EDF workers at the PWR reactors are exposed. However,

in the RNR system radiation problems are not encountered at the reactor itself. The radiation danger is involved in the fuel cycle, outside the reactor.

In fact:

* The manufacture of plutonium-based fuel requires installations involving protected production lines, which turn out plutonium-contaminated technological waste, involving exposure to radiation and contamination for the workers.

* The reprocessing of fuel from the RNR's is characterized by important, specific constraints, which include:

—The need to reprocess the irradiated fuel quickly to reduce the time for holding the plutonium outside the reactor.

—The very high radioactivity of the fuel to be reprocessed, due to the high level of radiation within the reactor and the limited amount of cooling that takes place.

—The amount of plutonium to be reprocessed is very substantial. It is about five times more than that resulting from the cycle of PWR reactors producing electricity. This involves the construction of a retreatment plant for the four RNR units, rather than the UP 3 plant at La Hague [near Cherbourg] used for 20 to 25 PWR reactors (using identical plutonium reprocessing lines).

This mass of plutonium in circulation will lead to losses of nearly proportional amounts of fissile material (of 1 to 1.5 percent losses of plutonium in the waste fuel being reprocessed). Hence, this would involve a reprocessing cycle for the RNR's which would produce more pollution than the PWR's do.

—Moreover, the entry into service of the RNR's would require massive supplies of plutonium from the PWR reactors (about 10 to 11 tons for one RNR and its fuel cycle). This would make reprocessing of PWR fuel an essential operation. Now, it is not clear at present that this operation would be justified from the point of view of the security of stockpiling of radioactive waste. The possibility of not reprocessing these wastes is beginning to be considered very seriously in many countries, which consider this line of action much simpler—and therefore less expensive—and less a source of radiation and pollution. This is because:

* It would not produce technological waste, including certain quantities of waste contaminated by long-lived Alpha elements (presently, a ton of PWR fuel reprocessed at La Hague generates 21 cubic meters of waste at a UP 2 reprocessing unit. For a UP 3 reprocessing unit the anticipated quantity of waste would be less).

* It might make possible a safer kind of long term storage of Alpha particles such as plutonium, neptunium, and americium in a container of U O₂ of fuel irradiated in a PWR which would probably be less soluble, in any case less so than in the case of vitrification in geologically deep locations.

* It would be less of a threat to proliferation, because since the plutonium would not have been removed from the fuel rods, it would not be directly usable to make

nuclear devices for military purposes. It is on the basis of certain of these arguments, for example, that Sweden has withdrawn fuel which was to have been reprocessed at La Hague in order to store the fuel in untreated form in geological sites within its own territory. In the same way West Germany is beginning to feel serious concern over what is to become of the wastes from reprocessing which have been returned to it by COGEMA [reprocessing company] from its plant at La Hague.

—Regarding the collective irradiation of workers due to uranium extraction, the basic dosage due to an RNR would be of the same order of magnitude as that from the use of natural uranium, that is, from 25 to 30 percent over the following 80 years. This relatively slight reduction in radioactivity should be compared with the increase in the dosage due to the end of the RNR cycle: the preparation and withdrawal of radioactive fuel containing large amounts of plutonium and other products of fission.

(c) Yes, the RNR system is essentially French in concept and construction, contrary to the PWR system. However, is this enough of a reason to adopt it no matter what the cost and whatever the conditions? It is appropriate to recall the "Concorde" aircraft affair. In order to sell 14 aircraft in all the French and British taxpayers had to put up 40 billion francs.

From the economic point of view, two important points should be considered: on the one hand, the cost of this system (independent of its usefulness), and on the other hand, the manner in which it would be financed.

(c.1) Cost of the RNR system:

This can be broken down into four important elements:

(1) The price of the reactor, as such. Presently, this is 2.2 times more expensive than a PWR of the same power. ("Superphenix 1" has a power of 1,300 MWe.) This figure could be reduced to a factor between 1.6 and 1.8 times more expensive for a series of four to eight reactors ordered at the same time. However, in any case the cost would be clearly higher for technological reasons (the presence of two sodium circuits, etc).

(2) The price of the installation for the manufacture and reprocessing of fuel. This would involve shielded lines of production for fuel and lower capacity reprocessing plants. The cost of these installations and of related facilities at a given plant site, such as Saint-Etienne des Sorts, comes to almost the same amount of money as the cost of the reactors themselves: the 80 billion francs for this project as a whole breaks down in very rough terms to 46 billion francs for the four SPX reactors and 34 billion francs for the FOR (fuel fabrication plant), the PURR (retreatment facilities), and the stockpiling ponds.

(3) The price of the plutonium needed for the fabrication of the first two cores (the following cores would be reconstituted on the basis of the plutonium recycled at the site). The cost of the plutonium from the first two cores depends essentially on the system used for the retreatment of the fuel from the PWR system:

Viewpoint of the AEC:

The reprocessing of PWR fuel is a necessary evil. Its cost should therefore be fully recovered from the electricity produced by the PWR's. The plutonium derived from reprocessing is thus a byproduct having no particular price or priced very low (60 francs a gram in 1990 and 100 francs a gram in 2000).

The 'American' Viewpoint

The stockpiling of unprocessed fuel is considered less hazardous than the fuel and related wastes after reprocessing. Reprocessing therefore is a necessity related to the development of the RNR system, and its cost therefore should be imputed to the plutonium produced. At 10,000 francs for each kilogram of uranium reprocessed (a realistic cost for the UP 3 reactor), a gram of plutonium comes to about 1,100 francs, or about 12 billion francs for the 11 tons of the first two cores mentioned above and necessary for starting up an RNR reactor. Consequently, this cost is equivalent to the cost of construction of the RNR reactor and the resultant, total cost is twice the initial investment.

4 - The operating cost of the reactors and the plants for the fabrication and reprocessing of fuel elements. This item is not very large, compared to other costs. The PWR and RNR reactors cost about the same in this connection.

The value of the residual uranium recovered from PWR fuel is almost nothing. Therefore, the only benefit to be expected from the RNR system concerns the price of natural uranium and the isotopic work separation units which are saved by using this system. However, the cost of this item does not amount to more than from 10 to 15 percent of the price per kilowatt hour of electricity produced by a PWR and amounts to very little on an overall basis.

(c.2) Financing of the RNR System:

As we have seen, one of the principal characteristics of the RNR system is that it requires the investment of considerable amounts of capital as compared to relatively low operating costs. We also find this same tendency in the PWR system, although to a lesser degree. This required investment of capital is all the more onerous since it takes place long before the entry into service of the reactors (about 10 years). When we recall that the total indebtedness of the EDF as of the end of 1982 was about 150 billion francs, compared to an annual budgetary deficit of about 8 billion francs and that the loans entered into by this public enterprise are principally denominated in U. S. dollars, we can see how dangerous a considerable RNR program would be (about 80 billion francs for the "modest" project at Saint-Etienne des Sorts) for the independence of France and its budgetary equilibrium.

In concluding this economic section, it would be appropriate to recall that:

* The cost of the RNR system is very high in investment terms: from four to six times the cost of the PWR system, according to our initial calculations.

* The need to bring in massive amounts of American capital to finance this system makes the argument that the RNR system is a French system essentially foolish.

* The cost per kilowatt hour of electricity produced, assuming that the plutonium costs nothing, is in the same order of magnitude as electricity obtained from coal (about 33 centimes per kilowatt hour).

* If the strategy of obligatory reprocessing does not turn out to be the right one, the additional cost due to the extraction of the plutonium would multiply the cost of electricity per kilowatt hour by a factor of about two, making it much more expensive than a kilowatt hour of electricity produced by an oil-fired generating plant. (See Table 2 above)

(d) Regarding the last point of the government argument presented above, concerning the possibility of using the RNR reactors as incinerators for plutonium and other long-lived radioactive elements, it would be appropriate to make the following comments:

* The PWR can also burn plutonium, sometimes with greater efficiency in terms of the money spent.

* The very object of the RNR system is not to make the plutonium disappear but, on the contrary, to produce it from our uranium 238 in order to increase the value of our national wealth in terms of natural uranium.

1.3 - The Military Aspects

The RNR system is the only system presently capable of providing plutonium of high isotopic quality (plutonium containing more than 95 percent of isotope 239 in the radial covers) in a quantity sufficient to support the development of our tactical nuclear striking force.

After the shutdown of reactors G 1, then G 2, and soon G 3 at Marcoule, and before we have developed the process of isotopic enrichment of plutonium by laser excitement, the development of the French nuclear striking force will be totally dependent on the proper functioning of the Phenix and later the Superphenix reactors and on the plants reprocessing their fuel: the SAP-TOR shop for the reprocessing of the Phenix and the ISAI installation for dismantling Superphenix fuel, and the UP 1 plant and then the MAR 600 plant now under construction for the reprocessing of this fuel.

This important characteristic of the RNR reactors is certainly at present one of the few, undeniable advantages of this system, although it is rarely, if ever, mentioned in the debates on this reactor system.

However, it should be noted that earmarking for military use the plutonium generated in the radial covers constitutes a fatal blow to the rate of regeneration, originally already slow in this system. It makes even more dubious the prospect of developing this system for civilian purposes. (See the April 1982 issue of ENERGIE magazine on French manufactured equipment and economic information.)

2 - The RNR's in the Global Energy Context

2.1 - Reserves of Natural Uranium

The size of these reserves is regularly a matter of controversy for several reasons. Reserves are traditionally under estimated for military reasons (uranium is a strategic material) and for economic reasons (to maintain the idea of an apparent shortage to keep up the price). A fully detailed inventory of reserves is difficult to prepare.

The volume of these reserves also depends on the costs of production which people are willing to pay: 5 million tons at \$130 per kilogram of uranium or 14 million tons at \$560 per kilogram of uranium, according to the OECD [Organization of Economic Cooperation and Development] in 1978.

Finally, the inventory of reserves of this mineral is far from complete: evidence of this is the discovery of the Roxby deposit officially announced in Australia in 1982. This deposit alone amounts to 1.2 million tons or 30 years of world consumption at the 1982 rate. The uranium contained in phosphate (4.2 million tons in Morocco) and even more in sea water (about 4.5 million tons), which the Japanese plan to extract at the rate of 2,800 tons annually in the year 2000, using barges moored in strong ocean currents.

Regarding the reserves to which France has access—in metropolitan France and through part ownership of uranium ore in foreign countries—these make it possible to satisfy our needs until 2050 on the basis of the requirements of the PWR reactors that will be installed by 1990 (53.6 MWe, or 5,360 tons per year at a load factor of 50 percent). This does not take into consideration:

- * New discoveries in France and overseas.
- * Uranium extracted from phosphate imported as fertilizer (600 tons per year, equivalent to the requirements of two Superphenix RNR reactors of 1,450 MWe).
- * Improvements in the operation of the PWR reactors.
- * Improvements in the process of enrichment by laser excitement.
- * The discovery and development of other reactor systems (RNR's using enriched uranium, spallation reactors, fusion, etc).

2.2 - Consumption of Natural Uranium

Contrary to the situation regarding reserves of uranium, the consumption of natural uranium has been much overestimated on the basis of exaggerated growth in our demand for energy, essentially to justify our PWR reactors and the need to replace them with the RNR reactors.

Forecast of Cumulative World
Requirements for Natural
Uranium in Tons

	By 2000	By 2030
Andre Giraud Estimate (1975)	4 to 6 million tons	24 to 42 million tons
OECD (Beginning of 1982)	1.1 million tons	6 million tons

The present tendency is frankly downward, both on a French national as well as on a world basis (less energy consumption due to energy savings and to a decline in growth, as well as serious cuts in the nuclear power generating facilities planned or under construction in many countries). There is no basis for foreseeing any major change of direction in the coming decades. As a result, it is not reasonable to speak of a uranium shortage before the middle of the next century.

2.3 - Use of Plutonium from Already Functioning Reprocessing Plants (UP 1 at Marcoule, UP 2 at La Hague) or Those Under Construction (UP 3 at La Hague)

The plutonium from these plants finds its natural outlet in the fabrication of the first two cores of the Superphenix RNR reactor at Creys Malville, which should go critical at the end of 1984. In the years to come, if it operates properly, this reactor will consume less than 2 tons of plutonium per year. The surplus output of plutonium from the UP 1, UP 2, and then UP 3 plants can then be "burned" in three different ways:

(a) In other sodium cooled RNR reactors of the Superphenix type, the next generation of this reactor system. This process will be very expensive and is not justified at present, in view of the foreseeable energy prospects (see Chapter I above).

(b) In fast breeder reactors cooled with pressurized water, called submoderated reactors (RSM). These reactors, which are presently under study by the AEC, will probably be less expensive than sodium cooled RNR's, but they combine the disadvantages of the PWR's (high pressure water circuits) and the sodium-cooled RNR's (hexagonal assemblies, the use of 13 tons of plutonium in the cores). They can be made into supergenerators, although they will have a relatively low energy output.

(c) In standard PWR reactors, replacing enriched uranium with plutonium. This solution will not require very substantial study and, by averaging out the added cost of fabrication of plutonium fuel elements, it has the advantage of "burning" the plutonium with a high output of energy. This system is not a supergenerator but, on the contrary, is a plutonium incinerator.

2.4 - Improvements in Nuclear Reactors

The PWR system has achieved a near monopoly over the production of nuclear-generated electricity. A great deal of research has been carried out to reduce the consumption of uranium in these reactors. Among the innovations which should be announced shortly are:

- * The development of AFA assemblies (from Plant Y at Pierrelatte) which can be disassembled and which permit improved combustion of uranium.
- * The development of spectrum variation assemblies (RVS) which make possible savings of natural uranium in the order of 20 to 25 percent (agreement between Westinghouse and Mitsubishi, Framatome studies).
- * An increase in the rate of combustion of the nuclear fuel.
- * The possible use of sodium-cooled reactors using highly enriched uranium (containing 11 percent uranium), making it possible to save hundreds of kilograms of uranium, with no need for reprocessing.

2.5 - Enrichment of Uranium Using the Laser Excitation Process

This is a very promising technique, although it introduces a serious risk of nuclear proliferation. It will probably become available by the end of the century. It has three important advantages:

- * Low cost of the isotopic work separation units (UTS), making it possible to lower the uranium content of the waste products to levels in the order of 0.08 to 0.05 percent and to achieve a reduction of 20 to 25 percent in the consumption of natural uranium. This compares to a uranium content of waste products of 0.20 to 0.25 percent from the gaseous diffusion process.
- * The possibility of obtaining substantial stocks of low quality uranium from the gaseous diffusion plants by lowering the uranium residue from 0.20 to 0.05 percent, making it possible to market considerable quantities of enriched uranium. This would constitute a true strategic stockpile, available on site.

2.6 - The RNR Reactors in the French Nuclear Power Generating System

As we have already seen, since the PWR reactors will be in surplus supply in about 10 years, if not for longer, any present introduction of RNR reactors would not appear to be desirable. It would cost too much at a time of crisis when the shortage is not uranium but rather available capital. French coal mining policy, already on shaky grounds, would be dealt a fatal blow by the introduction of the RNR reactors and would probably never recover.

3 - Conclusions and Proposals of the CFDT

3.1 - There Is No Point in the Development of the RNR System

(a) Neither over the short term, because:

- * of the already large number of PWR reactors, soon to be surplus to our needs.
- * of the low cost of uranium.
- * of our excess uranium enrichment capacity (Eurodif is operating at one-third of its capacity).

- * of the excessive cost of this system and difficulties in financing it.
- * of the constraints imposed by the obligatory and immediate reprocessing of PWR fuel.
- * of the difficulties of other energy sectors such as coal mining.

(b) Nor over the long term because:

- * of the extraordinarily large amounts of plutonium which it will be necessary to handle, with the risks involved in this handling and the waste products which it will generate.
- * of the probably obsolescent character of this system in a few decades.

3.2 - We Must Orient Our Research Effort in Four Directions:

(a) Improvement of our available supplies of natural uranium:

- * by continuing and strengthening prospecting in France and overseas.
- * by developing a system for recuperating uranium from the phosphates which we import.
- * by research into methods of extraction of uranium from sea water.

(b) Improvement in the returns from enrichment of uranium:

- * by lowering, if necessary, the rate of accumulation of waste products from enrichment by the gaseous diffusion process; Eurodif is only operating at one-third of its capacity.
- * by developing a process of uranium enrichment by laser excitation which will make it possible to obtain better returns from our reserves of natural uranium and to use the substantial quantities of spent uranium as a strategic reserve.

(c) Improvement in the functioning of the PWR reactors and in the stockpiling of spent fuel in pools, with the following, principal objectives:

- * lowering the radiation dosages absorbed by the workers at nuclear centers (improvements in shielding materials, detection of cracks in the shielding, the control and elimination of radioactive sludge, etc).
- * increasing the reliability and the security of reactors (study of the resistance of materials to fatigue and thermal shock; improvements in valves; the study of vibration, hydraulic discharges and the behavior of structures; improvements in control and regulation systems, etc.).
- * increasing the capacity of stockpiling pools; making assemblies more compact, dismantling and consolidating fuel elements, identifying stockpiling techniques resistant to seismic disturbances, etc.

(d) Improvements in efficiency and the study of new reactor systems:

* for the PWR's: develop spectrum variation assemblies and expand the rate of combustion of nuclear fuel.

* studies of other systems:

--sodium-cooled reactors using highly enriched uranium which will make it possible to increase our technological lead in this area and save substantial quantities of natural uranium without having recourse to the plutonium cycle.

--PWR reactors able to consume plutonium from the present reprocessing plants more efficiently.

3.3 - Reprocessing Should No Longer Be Considered a Necessary Evil:

--doing everything possible to avoid this expensive, delicate, and even dangerous operation, which generates large amounts of technological waste and which, for all of that, does not provide a long term solution to the problem of radioactive waste.

--studying as soon as possible the solution of not reprocessing nuclear wastes: the basic principles for research and development could be:

* study of a container for storage in a geologically deep site.

* study of the physical chemistry of the dissolution of uranium oxide [U O₂] and of the other components of irradiated fuel rods in geologically deep sites (conditions leading to shrinkage of the rods, low level leaching).

* study of potentially usable geological sites: characteristics and research on the ground.

* establishment of an underground laboratory to make it possible to study under actual conditions the local situations affecting the dissolution of irradiated fuel, the future behavior of dissolved products, the thermal behavior of rocks, etc.

III - The Reprocessing of Irradiated Fuels

1 - Why Reprocessing

1.1 - From the Civilian Point of View

--reprocessing "officially" has a dual objective:

* on the one hand recuperating plutonium in large quantities to supply the RNR system;

* on the other hand improving the condition of the nuclear wastes coming from nuclear plants;

* however, the uncertainties associated with these two objectives often make it impossible to clarify the debate;

* when we speak of the RNR's, it is often said that this system is economically competitive, because plutonium is a byproduct of the reprocessing of nuclear waste and that for this reason this raw material is available at low cost;

* when we speak of the possibility of not reprocessing fuel for reasons of cost or the complexity of the operations, we are then told that reprocessing is needed for the RNR system!

—for the CFDT there is no question of allowing such ambiguities to drag along and to continue such confusion. The RNR system, as we have demonstrated, is not a system for the future. Moreover, it comes completely after the reprocessing of fuel. In no way should it influence decisions concerning reprocessing. The only question which we should answer is therefore: will reprocessing make it possible, yes or no, to improve the conditioning of irradiated fuel over the medium and long term. If the answer is "yes," then what conditions should control this operation and what should the price be?

Clearly, the CFDT cannot answer these questions, which go beyond its knowledge of these matters. On the other hand we consider that these questions can be answered by the AEC and that, in this connection, it should make available the necessary means to answer them and to propose solutions. Among other things, it will be essential for the AEC group to break out of the impasse which it has created around the reprocessing issue. The AEC has always presented this as an urgent and unavoidable matter, whereas there are other solutions which have practically not been studied at all, such as deferring reprocessing until after the process has been improved or stockpiling this material as irradiated fuel, which can result in improved conditioning of the nuclear wastes and may even cost much less.

1.2 - From the Military Point of View

Reprocessing is an OBLIGATORY operation: due to the miniaturization of nuclear warheads, plutonium has now replaced enriched uranium. The military also have a continuing need to obtain supplies of plutonium to renew their warheads (improvement in isotopic quality) or to increase the number of warheads.

The high isotopic content of Plutonium 239 and the quantities needed by the military imply, as we saw previously, the following sequence of operations:

PWR Reactors

Reprocessing of PWR Fuel

Fast Breeder Reactors

Reprocessing of RNR Fuel

Nuclear Bombs

With the future development of enrichment by laser excitation, this sequence will be simplified, as follows:

PWR Reactors

Reprocessing of PWR Fuel

Laser Enrichment

Nuclear Bombs

In each of these cases reprocessing of the fuel from nuclear reactors is considered an essential link in the development of a nuclear striking force. However, the quantitative needs for plutonium are much less in the second scenario above.

As the CFDT has always rejected the idea of atomic weapons for France, it goes without saying that under no circumstances can the CFDT support the idea of reprocessing irradiated fuels as an operation solely justified by military necessity.

After having set out the necessary foundations for the conduct of the debate, we will review the present situation regarding the reprocessing plants in France, with a more detailed study of the situation at Marcoule.

2 - Activities of the Reprocessing Plants

The UP 1 plant at Marcoule went into operation in 1958 with purely military purposes in view. It reprocessed fuel from the G 1 and later from the G 2 and G 3 reactors. The UP 2 plant at La Hague at this time reprocessed the fuel from the EDF UNGG reactors, which are called "old nuclear systems" in the nuclear powered electricity generating system.

Progressively, with the entry into service of the HAO shop at La Hague, the UP 1 plant was reconverted to handle the reprocessing of spent fuel from the PWR reactors, which have been in operation since 1974. The Marcoule plant has been assigned to the reprocessing of fuel from the UNGG reactors, along with its military activities. It should be noted that the "old nuclear systems" in the UNGG plants will have practically ceased operation by the 1990's, which limits the prospects for the UP 1 plant. Moreover, after more than 30 years of operation, this plant will be obsolete, which will make it unusable under conditions of proper security.

The pilot SAP (Pilot Shop Service) at Marcoule is also reprocessing the core of the Phenix RNR, and the covers have been reprocessed by the UP 1 plant. Subsequently, the core of the Superphenix should be reprocessed at the High Speed Oxide Treatment [TOR] plant at Marcoule. The covers will be reprocessed in a shop to be constructed after the ISAI unit now being built at Marcoule.

Thus, we can see clearly the division of tasks which has been worked out between the sites at La Hague (reprocessing of the PWR fuel) and Marcoule (the remaining part of the "old nuclear systems," military purposes, the Phenix, and the Superphenix).

These activities involve some problems and are the Achilles heel of French strategy. Thus, following the parliamentary debate in October 1981 the minister of industry set up, under the Higher Council of Nuclear Security, a scientific commission charged with analyzing the problems involved in the management of irradiated fuel and radioactive waste. This commission, called the Castaing Commission from the name of its chairman, a member of the French Academy of Sciences, included 12 members, one of whom was Jean Teillac, high commissioner of the AEC. The commission's terms of reference, dated 11 December 1981, stated that its role consisted of examining proposals for extensions at the UP 2/800 and UP3 plants at La Hague and to make "appropriate proposals to permit France to maintain the necessary technological skills to ensure the management of irradiated fuels under the best conditions."

The Castaing Commission therefore did not have to express its views on the propriety of the construction program under way at La Hague, nor on the choice of the PWR-RNR nuclear reactor strategy.

For its part the CFDT regretted that the concept of the new plants was definitively decided on and the work begun without waiting for the report of the commission.

3 - Some Conclusions of the Castaing Commission

The report of the commission states that certain improvements have been made in the techniques used in the present plants and notes that working conditions have been improved since 1980 at the plant at La Hague. The commission stated: "These improvements should be a matter for constant vigilance, particularly because a certain number of difficult situations still exist. Technical modifications by themselves will not be enough. It is important to adopt another type of human relations. A greater willingness to listen and an improved dialogue with the workers are required. The people who assume the risks should be associated with the measures taken concerning the reduction of these risks."

Although the commission was silent on Marcoule, the CFDT sees in the lines quoted above an implicit recognition of the CFDT action taken at the two sites to analyze with the workers the problems existing in the plants and to propose solutions.

However, the commission raised numerous questions about the possibility of providing, in the present plants, sufficient protection for the personnel and the environment, as well as regarding the long term management of the nuclear wastes resulting from reprocessing.

Furthermore, the commission confirmed that the storing in a pool of irradiated fuel for several years posed no notable problem. On the contrary, this made it possible to improve reprocessing techniques noticeably.

Improved separation of fission and transuranian products and the implementation of new procedures for compacting technological waste would make possible safer management of the radioactive wastes from reprocessing.

Finally, the Castaing Commission confirmed very clearly that reprocessing should be seriously considered along with the methods of direct stockpiling of irradiated fuels and asked that the following, very detailed studies be undertaken:

--regarding more rapid reprocessing, notably involving improved separation of the different products (long-lived Alpha particles).

--on the procedures for stockpiling irradiated fuel and radioactive waste. It should be possible to remove materials from the stockpile, taking the spent fuel or the waste out for reprocessing or definitive stockpiling.

These studies should make it possible to make a choice, after 1990, between reprocessing, the stockpiling of irradiated fuel, or an intermediate solution making use of the two management procedures.

Moreover, this choice will be linked, as we previously saw, to military or civilian needs for plutonium and to whether or not the RNR system will be continued in the future.

--the right of the CHSCT (Committee on Health, Security, and Improvement of Working Conditions) to intervene to prevent the installation of dangerous equipment or procedures.

--the strengthening of the Radioactive Protection Services and the enactment of legislation guaranteeing their independence, as well as that of other security organisms (the IPSN, SCSIN, and the SCPRI).

--the obligation of informing the management-labor company committee of all new projects and the effective possibility for the committee (on company time) to play a role when technical decisions are made.

--the access to security files in the plants.

The CFDT continues to demand:

--that complete information be provided on the costs related to the management of irradiated fuel.

--that foreign reprocessing contracts be renegotiated and transformed into contracts for medium term stockpiling.

--that the government commit itself to continue studies on all techniques for the management of irradiated fuel.

--that the definition and followup of the program for the management of radioactive waste be turned over to a management structure which is multidisciplinary, independent, and autonomous in terms of the industrial operators of the plants.

--that the Castaing Commission continue its work, and particularly examine the situation affecting the Marcoule plant, and indicate the technologies or installations which do not provide all of the required safety guarantees and regarding which new studies should be undertaken.

IV - Marcoule in the General Context

1 - Activities at the Marcoule Site

There are two, distinct units at the Marcoule site: the Center for Nuclear Studies of the Rhone Valley, which comes under the AEC, and the Marcoule Establishment, which comes under COGEMA.

In March 1983 the Center for Nuclear Studies employed 1,002 workers, while the second establishment employed 2,250 workers (its authorized strength is 2,345). This brings the total number of workers coming under the AEC Group to 3,350. To this total should be added the employees of a certain number of sub-contractors who operate more or less permanently at the site. This brings the total number to more than 4,000 workers.

1.1 - Center for Nuclear Studies of the Rhone Valley of the AEC (CEN-VALHRO)

This center includes essentially:

—the Phenix reactor.

—the Pilot Shop Service (SAP), which is getting further and further away from the idea of a pilot project and is becoming a production unit involved in the reprocessing of the core of the Phenix and, in the near future, in conjunction with the TOR shop, the small-scale reprocessing of the core of the Superphenix.

—the Highly Radioactive Waste Service, which is continuing its work on vitrification of liquid radioactive wastes (SDHA).

—the Industrial Prototypes Service (SPI), which is developing in a non-radioactive atmosphere the principal equipment associated with the UP 3, the future plant to be established at La Hague.

—the Process Industrialization Service, charged with checking and approving AEC reprocessing work.

—the Installation for the Surveillance of Radioactive Assemblies [ISAI] under construction for the Superphenix.

All of these units come under the IRDI (Technological and Industrial Development Reserch Institute). Also present at the Marcoule site are:

—a service coming under the Office of Ionizing Rays (ORIS), which develops, implements, and sells procedures for the medical application of radioactive elements (for more details see Annex 10).

—certain units of less importance which come under the Institute for Nuclear Protection and Security (IPSN):

* the central unit for the dismantling of nuclear installations.

* the laboratory and plant security evaluation service.

* the nuclear security protection and assistance service.

Finally, there is a directorate charged with logistical support. All of the above services employ around 1,000 workers.

1.2 - The COGEMA Establishment at Marcoule

As indicated in the preceding sections, this establishment is charged with supplying the French nuclear striking force with plutonium and with reprocessing irradiated fuel from the "old nuclear systems" of the EDF—that is, the UNGG reactors—in the UP 1 plant which has been in operation since 1958.

It has the following facilities:

—a shop for mechanically removing the shielding from fuel rods, with associated stockpiling pools.

—a reprocessing plant equipped with facilities for handling plutonium for military uses and a unit for the conversion of plutonium into plutonium oxide for civilian uses.

—a shop for the vitrification of highly radioactive liquid effluents (AVM).

Around these production units is a group of other essential shops which provide services both to COGEMA and to the CEN-VALRHO:

—the station for the treatment of effluents.

—the decontamination shop.

—the solid waste compacting shop.

—the analysis laboratory.

—the Radiation Protection Service (SPR).

—the Security Service (FLS).

—administrative and management services.

There are still other services, no less important since, by themselves, they employ about 900 workers, taking care of maintenance, the construction of new units, etc. Finally, let us not forget the G 3 and Celestin reactors, which are devoted to military purposes and which are still functioning.

We note that around the reprocessing plant itself, which operates with about 150 workers, operating 24 hours a day, every day, there is a further group of units which brings the overall total of workers to 2,245 and demonstrates the complexity of the operations.

2 - The Present Situation at Marcoule

2.1 - Reprocessing Radioactive Waste from the UNGG Reactors

The UNGG reactors belong to EDF and are fueled with natural uranium, controlled with graphite rods and cooled with carbon dioxide in gaseous form.

We saw previously that the UP 1 plant at Marcoule took over the reprocessing of the spent fuel from the UNGG reactors from the UP 2 plant at La Hague. The problems related to the rate of combustion of the EDF fuel which the La Hague plant had experienced subsequently came up also at Marcoule and affected the entire process:

* the process of removing the shielding has encountered growing difficulties over the years, and many incidents have occurred, due to mechanical or physical causes, including fuel rods catching fire or exploding, with consequent radioactive contamination of the surrounding area and at times of the workers.

The most recent incident took place on 22 March 1983. There was a fire in the nuclear waste and in the magnesium shielding, followed by a violent explosion which put a premature end to the operation of this installation before the MAR 400 facility was ready to replace it.

The shortfall in the tonnage reprocessed (245 tons planned to be reprocessed in 1983), according to a statement of the directorate of CEN-VALHRO, will amount to at least 100 to 120 tons, provided the startup of the MAR 400 shop goes well.

* The UP 1 plant operated under acceptable conditions for military reprocessing at the low rate of combustion of the G 1, G 2, and G 3 reactors. Since beginning the reprocessing of fuel from the EDF reactors, the plant has also encountered major radiation problems, seriously complicating the maintenance of the installations.

Moreover, this plant went into operation in 1958, and certain, irreplaceable parts essential to its functioning have never had the slightest checkup since that time. It is not clear whether the UP 1 will be able to continue the reprocessing of spent fuel from the "old nuclear reactors" until 1990-1995, which would give it a working life of 37 years. Studies have shown that no one was ready to assume the risk of having it reprocess the Superphenix reactor in the next few years, although at present it is reprocessing the covers of the Phenix reactor under very bad conditions.

* Since the reprocessing of EDF radioactive waste began here, the station for the reprocessing of effluents has rapidly been saturated with radioactive sludge which the shop responsible for coating it with bitumen is no longer able to handle. This is due to the fact that there has been an increase in the rate of combustion and, consequently, in the volume of radioactive sludge in the effluent.

This station is presently functioning under very bad conditions. As it is essential for both the CEN-VALRHO and the COGEMA operations, it is urgent to build another such station. However, it is still necessary for so large an investment to be justified in terms of a future for the center which extends beyond 1985.

At the moment it is intended that a new shop for coating the radioactive sludge with bitumen will be built quickly, because without such action, the Marcoule complex would choke up and be unable to function.

* The vitrification shop: since it went into service this shop has not raised any major problems. As its nominal capacity for vitrification is above the requirements of the UP 1 plant, the time allocated for maintenance operations is sufficient to ensure the satisfactory operation of the installation. However, we note the steady accumulation of technological wastes, and the delicate problem of the overhead gantry, which was not built to nuclear standards and which shows signs of metal fatigue and should be dismantled.

* The other units: they have gone along with the general evolution of the site, in the sense that their activities are closely interdependent. The decontamination shop has been dealing with growing quantities of radioactive materials. The shop for compacting solid wastes is not suitable for wastes contaminated with Alpha particles.

Since 1958 we have also observed a worsening situation in terms of the accumulation of radioactive waste of all kinds at the Marcoule site. This has been one of the consequence of reprocessing irradiated fuel from the EDF:

—the shielding of the fuel rods has accumulated since the beginning of these operations.

—there is a growing number of silos containing barrels of bitumen covered radioactive sludge.

—technological waste has increased in volume, due to the entry into service of the shop for the vitrification of fission products.

—liquid fission products which are vitrified and then stockpiled in pits.

—radioactively contaminated solvents and oil.

—the G 2 reactor has been closed down and awaits dismantling.

—shop 100, formerly the end of the plutonium line in UP 1, has been shut down for many years and contains considerable quantities of plutonium, to which may be added various apparatus dismantled after the end of plutonium production and now contaminated with it; contaminated boxes of gloves, vats, various kinds of equipment, etc.

—many barrels of radioactive waste with a high plutonium content and theoretically available for incinerating and which are waiting for this operation to be carried out. They are stockpiled here or inside the UP 1 reactor.

—ashes rich in plutonium resulting from the incineration of radioactive waste. They are waiting for chemical dissolution and recycling (not much sign of this at present).

—other waste coming from the laboratories.

—concrete contaminated by leaks in the installations.

2.2 - Reprocessing of Phenix Fuel in the SAP [Pilot Shop Service]

* The present production line (TOP), which should have been shut down at the end of July 1983, has never functioned properly. When a new shop for the extraction of plutonium (third plutonium cycle in Cell 65) was placed in service, this shop was faced with one of the hardest jobs for the workers since the establishment of the Marcoule center. It was necessary to cut out a vibrating column in an atmosphere highly contaminated with plutonium! However, the CFDT intervened to postpone this job. The tests made on this column before the installation went critical were cut short for production reasons. Since that time this cell has never functioned properly. It has encountered serious amounts of radiation and contamination of the workers.

The mechanical handling shop of this same installation has experienced major problems, due to the obsolescence of the installations, such as the breakdown of a highly contaminated crane which prevented the operation of the production line for 2 months.

* The new TOR (High Speed Oxide Treatment) line, is due to go into service in 1985 and is now being assembled. There is already reason for concern due to the concept of the TOR 3 shop (in the first extraction cycle), since its complexity and the small space available for it will make servicing very difficult, if not impossible, even before it is placed in operation. The TOR 1 shop has already raised problems, and it is feared that it may be placed in service before the end of the preliminary tests, if it is to begin to function before January 1985.

—The entry into service of this new unit therefore threatens to be problematical, and this will certainly involve considerable problems for the workers who will be assigned to operate it. Moreover, it is regrettable that the workers have practically never been consulted, from the time this unit was first conceived of. However, they will be the ones to bear the burdens of working in that unit.

In view of this situation the CFDT denounces the commercial objectives (bringing in the maximum amount of money to the division) and the publicity devoted to it (showing that we know how to reprocess fuel from a fast breeder reactor). The CFDT further denounces the fact that the AEC has assigned this function to a pilot shop, whose principal function should have been to undertake research and development at a slower rate in terms of reprocessing fuel.

3 - Overall Proposals of the CFDT

3.1 - Overall Situation

We have seen that, apart from the Phenix reactor, all of the activity at Marcoule ultimately depends on a station for the handling of liquid effluents. This station is now almost overwhelmed and has already caused interruptions in production installations, including both COGEMA and AEC facilities.

The former station for removing the shielding from UNGG fuel rods went out of existence, following an explosion of magnesium shielding held in a vibrating transporter and abandoned from September 1982 to March 1983. The CFDT demanded establishment of a committee of inquiry. This facility should have been replaced by a new station for removing the shielding from the fuel rods, called the MAR 400, which will not be able to reprocess radioactive sludge until a new shop is put in place at the head of the UP 1 line, accompanied by a new station for the treatment of effluents.

In May 1983 the reprocessing of spent fuel from the EDF UNGG reactors was totally halted at Marcoule.

The UP 1 plant placed in service in 1958 is threatened with a serious breakdown, which would immediately end the reprocessing of fuel from the EDF UNGG reactors and would involve the paralysis of a large part of the other installations which provide it with support. At present Marcoule is carrying on its activities, balanced on a razor's edge, in the absence of having been provided with the necessary investment funds in a timely manner.

The Pilot Shop Service (SAP-AEC), on which a substantial number of workers also depend for their jobs, was to stop its activities in mid 1983, resuming them with the entry into service of the new TOR installation in 1985. Meanwhile, there will be a problem with the temporary reassignment of the personnel working at this installation. Regarding the longer term, two projects are presently under consideration:

—the MAR 600, a COGEMA unit intended for reprocessing the fuel of the three Superphenix fast breeder reactors.

—the ATALANTE, an AEC research and development unit for the study of the chemistry of reprocessing, intended to replace AEC/DGR installations at Fontenay-aux-Roses (Paris area) which have become obsolete and which are too close to major urban centers.

These two installations, whose entry into service is not anticipated before 1992, also depend in fact on the reprocessing policy which France adopts and on the future of the RNR fast-breeder reactors. The future of the two installations will be closely related to the manner in which the conclusions of the Castaing Commission (under the supervision of the Higher Council of Nuclear Security) are taken into consideration. And we have seen that in this connection the path of wisdom involves taking no hasty action.

Regarding the MAR 600, the following dilemma threatens to come up quickly: should we undertake the construction of this installation as soon as possible, in order to protect employment at Marcoule, whatever the price, or should we wait for the present reprocessing procedures, which are poorly adapted to the long term stockpiling of nuclear waste, to be improved and developed from the industrial point of view? (The problem turns on the need to remove Alpha particles, which will be present in greater quantities in the spent fuel from the RNR reactors.)

3.2 - Proposals by the CFDT

The CFDT and the workers at Marcoule face an extremely complicated problem, which some people simplify in an exaggerated way:

—Ending the short and medium term reprocessing programs and then ensuring the future of the site, which will not only contribute to maintaining jobs at the Marcoule site but will also generate work by subcontractors. In addition, there is the economic impact on the area of the salaries of the workers.

—Adopting the too simple solution of keeping up false hopes such as the construction of four fast breeder reactors, without taking the elementary precaution of including them in a coherent national energy development plan, which would ensure the needs of the country and would take into account all sources of energy, in particular French coal, which, as we previously saw, would be irremediably damaged by too rapid a concentration on nuclear power.

The CFDT is the largest trade union central organization at the Marcoule site, representing almost 40 percent of the workers, including both the AEC and the COGEMA installations. It is one of six trade union organizations represented there. It is the only organization to adopt a policy of truth, precision, and solidarity.

—Truth about the real difficulties involved in the reprocessing of radioactive fuels.

—Precision regarding the manner of considering the problems which are posed simultaneously by the international crisis; the national energy situation; whether the present AEC strategy is well-considered; the reprocessing of nuclear waste, whose industrial feasibility has not been demonstrated; and the handling of nuclear wastes.

—Solidarity among the workers in different sectors of French energy production. They are presently in competition with each other. Let us mention coal as against nuclear energy, both with their train of employment problems. For several years the CFDT trade union at Marcoule has alerted the various directorates and authorities to the precarious situation at the site. As it has been aware of the limitations on its means for investigation into the matter, it has also asked for several years for a committee of experts to come to Marcoule to conduct an inquiry in order to develop an overall view of the situation. This should be done to bring out, through discussions with the workers and their trade unions, credible proposals for the future. This initiative by the CFDT has not yet met with the positive response which the trade union hoped for.

With the entry into power of a government of the Left and the remarkable work of the Castaing Commission the CFDT, through its National Atomic Energy Union (SNPEA/CFDT) and the CFDT itself, reiterates its demand for a "Castaing type" commission to the chairman of the Higher Council of Nuclear Security. Only time will tell whether this demand has been given consideration.

For its part the directorate general of COGEMA, no doubt very concerned about the future of reprocessing of spent fuel from the PWR reactors at La Hague, which

will require enormous investments and will raise financial problems, has turned a deaf ear to problems concerning Marcoule and has refused to enter into direct contact with the CFDT. He has done this in order to undermine and cut short the discussions.

In view of this situation the CFDT thinks that the proposals of the Castaing Commission should be applied to the Marcoule site without delay and followed up by measures that take into account the technical and historical characteristics that pertain to it:

—Reexamine the notion of national defense secrets, with the restrictions on free access to information which they involve, so that such important facts as the rate of loss of plutonium in the nuclear waste or the security reports on the installations will be available to any organization which asks for them. In the same way it should be possible to declassify certain installations (the processing of nuclear waste, for example) which have no "confidential military" aspects about them, in order to facilitate discussion.

—Undertake a cleanup of the site. That is, after an exhaustive inquiry into all the waste that has accumulated since the Marcoule site was established, look into and undertake the treatment necessary for the proper handling of this waste material in a definitive way, or at least a temporary way, with a possible resumption of work if no presently available technical solution is appropriate for the long term. This effort may require substantial, technological resources, as well as considerable amounts of labor. It may be necessary to build new units for this essential reprocessing of nuclear waste.

—Ensuring an end to reprocessing of spent fuel from the UNGG reactors. It may be necessary to close down the UP 1 plant, either to clean things up (one unit has been closed down for several years, due to a substantial level of radioactive contamination), or to update or construct new facilities in order to avoid a definitive halt in activities due to an event like the "22 March 1983" incident in removing the shielding from spent fuel rods.

—Ensuring proper treatment of liquid effluents: the present station is constantly overwhelmed with work and will not last until the 1990-95 time frame. In the same spirit as that mentioned above, let us envisage a "cleanup" of the accumulated nuclear waste and, above all, expedite the construction of a new station. In parallel fashion let us consider and do whatever is possible to recycle liquid effluents in the plants (the UP 1 or the SAP) or in the laboratories.

—In terms of removing the shielding from the spent fuel rods, after the conclusion of the ongoing inquiry requested by the CFDT, do everything necessary to ensure that the new MAR 400, which has not yet completed its tests, is brought into operation.

—Improvements in present procedures: although studies have been conducted in other centers, particularly in Fontenay-aux-Roses, certain complementary work can be conducted in Marcoule by the Chemical Engineering Section of the Production Services, the Bureaus of Research, and the ACE-SAP and SPI services involved.

—Marcoule can also make its contribution to determining the character of the nuclear waste contaminated by Alpha particles, through the experience acquired in the refined plutonium shops of UP 1 and the SAP.

—Study of compacting waste products: Marcoule could undertake a pilot project to study the absorption by the plant itself of its own waste products which could be immediately reconditioned without a need for transportation and handling which is dangerous to the workers and the environment. This kind of installation could be set up on an industrial scale at the UP 3 plant at La Hague.

—Vitrification of fission products: improve the resistance to leaching of the glass products presently used and seriously consider the long term future of the transuranian content in the glass products in the course of fabrication.

—Conditioning containers and connecting tubing for precipitated, radioactive sludge: accelerate studies on the industrial application of processes to replace concrete and bitumen forms now in use (automated fusion into hollow shapes and the use of ceramics so that these can be adapted to future plants—such as the UP 3 and the MAR 600).

—Operation of plants: prepare as quickly as possible a list of incidents, usable both by COGEMA units (UP 2 plant, Works Control Service at the UP 3 plant) and by the AEC, so that all experience obtained from operations can be made use of.

--Development of robotics for nuclear plant applications: creation of a test room for assembling and disassembling units, using telecommunications guidance.

Activities not related to the reprocessing of fuels:

These are presently rather marginal, due to the number of workers they involve. However, they could be developed in a more significant way, in order to diversify activities at a given site and make them less vulnerable to passing phenomena. In effect, there is a potential in this direction, and the resources required to develop this potential are not very substantial (less major investment than in fuel reprocessing). The principal units concerned are:

—ORIS [Office of Ionizing Rays], where the development of the Product Laboratory for Medical Analysis [LAPAM] should include:

- * strengthening the radiation/immunological sector.
- * new activities applying other, non radioactive techniques for medical analysis in vitro.
- * development and fabrication of automated apparatus using biomedical products.

The future of this service, although initially promising, because there is a social need for it, may risk raising some concern among the personnel. Because it is considered "commercially viable," this activity is receiving less and less attention within the AEC-ERIES, a partnership between the AEC and ROBATEL-SLPI. This group will probably be transformed into a subsidiary of the AEC, with capital from the AEC, SGN, EPICEA, etc. This company has always operated with small

resources, mostly provided by the Chemical Engineering Group (GGC) of SAP-AEC. Its area of activity covers:

- the extraction of liquids from liquids and of solids from liquids.
- filtration.
- cracking complex compounds.
- distillation.

It has found outlets in:

- cleaning up pollution: removing phenol compounds, recovering acids, etc.
- the chemical industry: carbon and petroleum chemistry, industrial pharmaceuticals, precious metals, hydrometallurgy involving copper, nickel, chromium, uranium, etc.
- the agricultural and food industry: extraction and purification of vegetable oils, proteins, coloring agents, etc.
- improving the quality of biomass.

Clearly, such a spectrum of activities could lead to important work. However, to do that it would be necessary, in addition to the necessary economic resources, to have the support of a political will to diversify and open out to the world and flexibility in adaptation and organization which the AEC and COGEMA at Marcoule show few signs of having. However, projects which should be encouraged are under way in this direction:

- the treatment of deep sea nodules.
- the construction of an agricultural and food platform in the sea.

Conclusion: the proposals of the CFDT, although they are not exhaustive, have the advantage of already existing. They still need to be discussed, which has never really taken place. Certain work would cost a great deal and would take time. This is one reason more for undertaking immediately work-on projects whose urgency is clear to all. After 25 years of activities essentially oriented toward the military requirements of the nuclear striking force, the Marcoule site can look toward another future.

This future, between now and the year 2000, will involve reprocessing of nuclear fuel, the segregation and handling of nuclear waste, the extension of activities of a non nuclear character, and the contribution of the site to regional development.

CONCLUSION

For more than 10 years the National Atomic Energy Union of the CFDT and the confederation itself, through publications (such as the "Dossier Electronucleaire en

France" [The Question of the Nuclear Generation of Electricity in France], films, and lectures, have tried to open up the subject for public debate.

The CFDT local union in Marcoule, which was not very sensitive to the implications of the arrival of EDF nuclear fuel at the site in 1973-74, has since become aware of the seriousness of the situation. Since then, more and more clearly with the passage of time, the point has been reached where the situation at the site, its current status, and its future were the essential aspects of the debates at the CFDT General Assembly of 30 April 1983.

It was after this assembly that the members of the CFDT union at Marcoule, meeting for an entire day, made the decision to provide more information to all of the workers at the site.

In effect the members of the CFDT union, whether they are engaged in decontamination or operations, whether working on the removal of shielding or in the reprocessing plant, whether they are technicians or engineers, whether they are chemists or mechanics, whether they are functional or maintenance personnel, share the same opinion:

—the situation at Marcoule is precarious. The situation must be brought out more clearly. The condition of the site must be described. It must be discussed. The situation must be made known and brought out of the narrow circle of those who have been initiated into its mysteries. Any solution must involve this.

This pamphlet is therefore not the product of a few militant members of the union but rather it represents the contribution of the CFDT union at Marcoule to the debate on energy and nuclear problems on which the future of the site depends.

The CFDT union, although it is the largest union at the site, does not intend to act as a pressure group to impose a kind of solution by means of force or slogans. It intends to make its contribution to the debate and to make the workers and the authorities aware of the problems existing at the Marcoule site. These problems must be solved if, like the CFDT, the site is to have a future.

If the authorities are unwilling to enter into a discussion, they will be assuming historic responsibilities which may go against the interests of the country and of the generations to come.

5170

CSO: 5100/2505

La Hague, the biggest work site in Europe

(from our special correspondent in La Hague)

Arriving near the La Hague site is an experience, even a shock, with the change in landscape. It is true that it is the biggest work site in Europe and that the infrastructure are at the same scale. For the construction requirements, Cogema set up the economic interest grouping Gifab to operate a concrete batching and mixing plant which can be taken down later. In five years it will produce some 800,000 cubic metres of concrete, a quarter of France's total production in a year.

The main work site - The plant which already exists at La Hague has belonged to Cogema since 1976. Under extensions planned both for French and foreign fuel, two major complexes are being built:

- UP3 A, a plant which is being completely financed by foreign customers and which will eventually include: a cask discharging facility; two pools (C and D) with a capacity of 2,000 tons apiece (the C pool received its first basket of radioactive fuel in April, while the D pool should be in service towards the end of 1985); a T1 shearing/dissolution unit, of which the civil engineering work is currently in progress; four separation units, treatment of fission products, separation of uranium and plutonium (civil engineering in progress); a waste vitrification unit (T7) with a capacity three times greater than that of AVM at Marcoule (civil engineering work started in May 1984); an STE 3/T waste treatment plant. This UP3 complex, the construction

of which is progressing at full speed, will be in service in the middle of 1988, except for the vitrification shop which is due to start up at the end of March 1989.

- UP2 800, the plant which is to come onstream in 1990, two years after UP3. Already several shops of this complex, integrated to the facilities of the current plant, are being built or in some cases have even been completed. The BST 1 plutonium storage shop (completed at the beginning of 1983); the AD1 decontamination shop (completed at the beginning of 1984); SPF 5, the storage unit n° 5 for fission products (due to come onstream before the end of the summer); NCP 1, a facility for concentrating fission products (start up planned for the end of 1984); finally, R7, the UP2 800 vitrification shop for vitrifying fission products resulting from the reprocessing of 800 tons a year of fuel from this plant. The start up is due to take place in a little more than two years.

Facilities that are common to UP3 and UP2 800 - These include the new ST3 waste treatment station, which is due to come into service at the end of 1986; the site, that is to say all the infrastructural facilities which need to be planned around the nuclear buildings (roads and distribution networks, conduits, production and distribution of fluids etc). This work site is

being carried out alongside work being done on the two plants. As part of "major work site" procedure, Cogema is financing a certain number of works and municipal facilities in the region.

A lightning visit - In the pools in 10 metres of water lie the racks containing the radioactive fuel assemblies. The latest of these ponds to come into operation, the C pool, the first facility built in the UP3 extension, is suspended on big neoprene blocks so as to assure an increased safety in the event of an earthquake. The following pools (D and E) are also suspended. Along the wall of the pool can be found the "Nymphéas" built by SGN, which are in fact very sophisticated exchangers designed to maintain the water at a constant temperature and quality.

Everywhere, in the maintenance period (July-August), it is the cleaning and maintenance of the material which produces a sizeable amount of technological waste: cotton, woven paper, polyethylene sheets and industrial grade gloves. The La Hague plant uses 7 million pairs of gloves a year. For the casks there is an outside storage area. Different models can be seen there: cubic casks for graphite gas fuel, cylindrical ones for LWR fuel, including Transnuclear casks or the recent Lemer model. During treatment programmes around one cask is received every day.

Elisabeth Liégeois

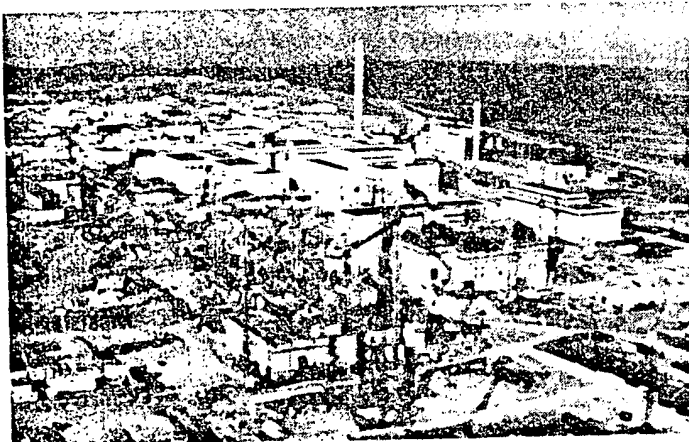

La Hague. Aerial view. UP3 programme: work in progress on the "medium activity" building. (Doc. Cogéma).

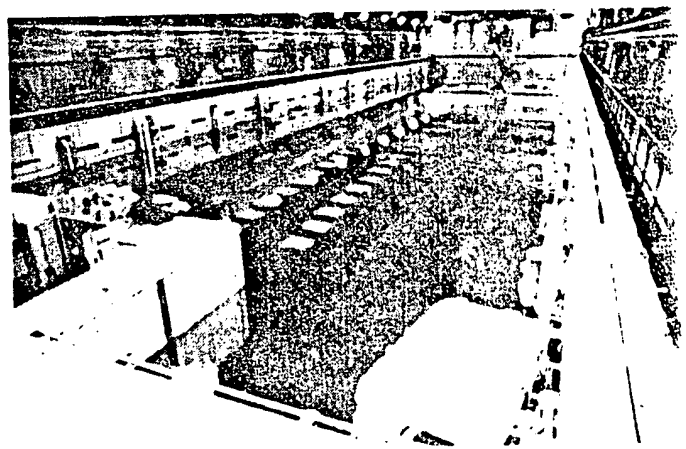

La Hague. Pool C. (Doc. Cogéma).

Cogema affirms its position as world leader in the fuel cycle

Cogema has become the only industrial company in the world which can handle the whole nuclear fuel cycle from mineral prospecting to the reprocessing of radioactive fuels. This position has been attained through a steady investment policy: 10 billion francs of accumulated investments up until the end of 1983, of which 3.5 billions in 1983 alone. Turnover is in constant progress reaching 11 billion francs last year, of which 25 per cent in the export field. The company's cashflow reached at 1.8 billion franc. For the Cogema group as a whole, turnover was 17.63 billion francs compared to 15.2 billions in 1982 with exports at 35 billions compared to 6.7 billions. Cogema employs 9,000 people, which makes a total workforce of 14,000 for the group as a whole.

Natural Uranium. Cogema has access to almost 25 per cent of the world's production/concentration capacities. In France it holds almost 85 per cent of the country's reserves. Outside France it is playing an increasingly active role, in Africa, in Latin America and in North America. In 1983 concentrated uranium supplies represented nearly 8,000 tons, of which 1/4 was for foreign customers. The corresponding production was divided between French mines (nearly 2,500 tU), African mines (4,400 tU) and North-American ones (1,300 tU).

In France Cogema directly operates three mining complexes. In Africa it is associated with various partners in three mines, two of which are in Niger (Somair and Cominak) and one in Gabon (Comuf). In Canada, Cogema is the main shareholder in Amok which exploits fields near Cluff Lake. At the end of last year, a major field containing ore with a high uranium content was discovered at Waterbury Lake (Saskatchewan). In the United States Cogema acquired 80 per cent of the company Pathfinder Mines.

Enrichment. The Eurodif enrichment plant, in which Cogema has a 51.33 per cent stake, has adapted its operating rate to the decline in demand...

At Miramas Cogema has other isotopic separation capacities: from 150 to 200 kg a year of boron 10 and more than 1,000 kg a year of lithium 7. Lastly, Cogema is participating in the major R and D effort undertaken by the CEA on advanced enrichment processes.

Nuclear Fuel. Since 1976 Cogema has been supplying EDF's GCR plants with fuel elements manufactured by its 100 per cent subsidiary SICN. In the field of fuel for

Cogema et participations

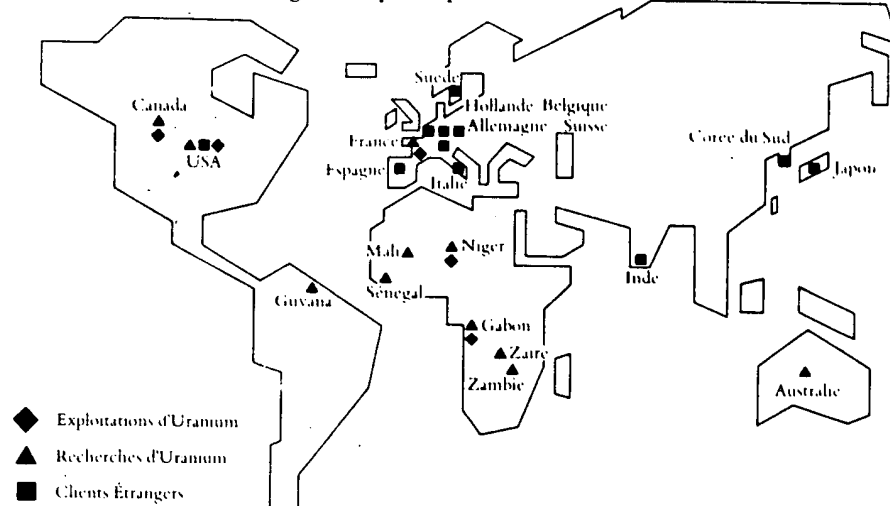

(Doc. Cogéma, 1984).

LWR, following the agreement reached on January 20 this year, Cogema has been given a 25 per cent stake in Eurofuel alongside Pechiney with 50 per cent and Framatome with 25 per cent. Eurofuel itself holds 87 per cent of the capital of FBFC; MMN holds the remaining 13 per cent. Cogema also holds 25 per cent in the company CFC alongside Pechiney with 50 per cent and Framatome with 25 per cent. FBFC operates the three fuel manufacturing plants of Romans, Dessel and Pierrelette and divides up the manufacturing programmes between them. Finally Cogema is a fellow shareholder of Framatome (50/50) in Fragema, which is alone responsible for the design and marketing of the nuclear fuel. Cogema is also responsible for supplying the first core and the two first reloads for Superphenix.

Reprocessing. At the end of 1983 Cogema had reprocessed 5,842 tons of GCR fuel. At the same date, the UP 2 plant at La Hague had reprocessed more than 700 tons of LWR fuel (of which 221 tons in 1983). The plant is currently being expanded. What is more, a new plant (the UP 3 with a planned capacity of 800 tons a year) is currently being built at La Hague with start-up planned at the end of 1988. The UP 2 plant also reprocesses fastbreeder fuel (Phenix) by mixing it with GCR fuel. More than 6 tons had been reprocessed by the end of 1983. Lastly, by the end of 1983 the Vitrification Plant at Marcoule has already produced 867 glass containers, representing 713 cubic metres of high radioactivity fission products.

Special transport services. This department called STS is involved in the design and manufacture of casks, cask management and the transport of radioactive matter. In liaison with STS, a department of radioactive fuels transport (STCI) is responsible, in liaison with STS, for all transport operations in the direction of La Hague and Marcoule. It assures the supervision of development, manufacture and maintenance of casks used for radioactive fuels, plutonium, waste and residues. It operates railway terminals, road transport and the cask maintenance workshop at La Hague.

Future. Cogema has 70 foreign clients, some of whom are in the United States, where it has achieved a spectacular breakthrough. Japan is however the company's most important foreign customer. Cogema also relies on its engineering subsidiaries. Company chairman François de Wissocq expects turnover will fall slightly this year (because of the renegotiation of the contract under which the USSR enriched uranium on behalf of France). But the cashflow will be "substantial". Investments will be increasing considerably this year to reach 5.5 billion francs for Cogema alone and 6 billion for the group as a whole. E.L.

Subscription form see page 106

MARCH 1983

nuclear engineering

INTERNATIONAL

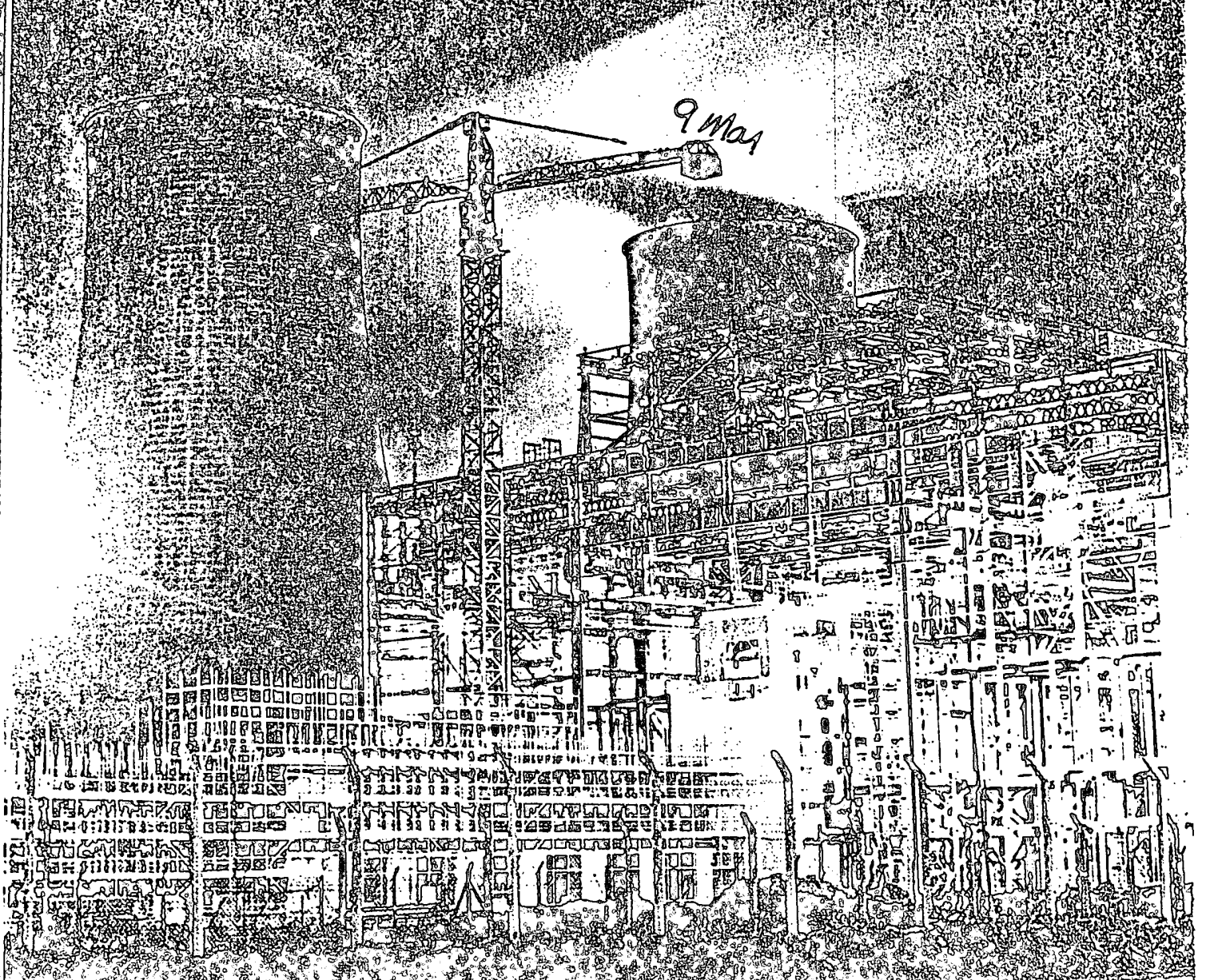

Fuel cycle
Update on Korea

Fuel cycle

Pond 5, however, with a very high civil construction content, it was expected that civil work would interact to a high degree with mechanical and electrical operations. With a large number of contractors on site, the close interlocking of schedules placed great demands on the performance of each and every contractor.

To a considerable extent, BNFL and its contractors succeeded in coping with these inherent problems. However, a number of difficulties were encountered. For example, Balfour Beatty's £75 million contract was delayed due to a combination of exacting concrete work and problems in other areas of construction.

In addition, Pond 5 is a first-of-a-kind facility. The design is original, and, while the overall concept has remained the same since construction began in 1977, there have been changes in detail which have increased the construction workload. BNFL points out, however, that a trade-off had to be made between achieving economies in civil construction and leaving as much time as possible for construction and testing prior to operation.

The demands on civil construction made by the Pond 5 design were also great. The steelwork is supported on large, reinforced concrete bases and is clad in aluminium with a 5m high wall of black facing brick. Internal partition walls are generally of brick except where shielding demands thicker concrete walls. All suspended floors are of reinforced concrete. The floors are generally either granolithic, epoxy resin of polymer finish, with the walls and ceilings fair-faced to a very high standard for ease of decontamination and, where required, for example in the decanning and remote maintenance caves, finished

Materials used in Pond 5 and Sixep

	Pond 5	Sixep
Structural steel, t	10 000	2500
Concrete, m ³	100 000	27 000
Reinforcement, t	15 000	2100
Bricks, number	5 million	-

with a decontaminable chlorinated rubber paint.

A feature of the concrete construction is the degree of complexity introduced by the large numbers of box-outs for viewing ports and instrument penetrations and cast-in-place items for grabs and monitoring equipment. Concrete formed of lead shot having a density nearly four times that of normal concrete, enabled wall thicknesses in some highly radioactive areas, such as the decanners, to be considerably reduced.

The contract for the bays called for all concrete to be watertight. The concrete finally used contained a 70 per cent replacement of ordinary Portland cement by Cemsave, a material which reduces heat generation in the concrete and thus reduces shrinkage and cracking. All pours for the 20 000m³ of water retaining concrete were carefully monitored with thermocouples to ensure that the temperature gradient across the pour did not exceed the 20°C at which thermal cracking could occur.

Water testing of the ponds, which began in April 1982, showed leaks in pond 1 totalling only 39 litres/d through cracks little more than 0.1mm thick. Grouting, involving a special process in which the crack is evacuated and resin injected at low pressure, reduced the leaks to 5 litres/d. This level, BNFL says, is as close to watertight as physically possible in a bay of this sort. □

23 years, and, with expanded facilities, is now used to reprocess gas graphite fuels. UP1 has already reprocessed some 12 000t of irradiated fuels (see table).

The second major reprocessing facility, built at La Hague (UP2), was commissioned in 1966. It was originally intended to handle gas-graphite fuels, but following the introduction of PWRs it was decided to add to the UP2 facility a first oxide head end unit (HAO), which came on stream in 1976.

At the same time, the FBR r and d programme was examining the problems involved in the reprocessing of highly irradiated oxide fuels. From 1966 to 1979 the AT1 pilot fast breeder fuel reprocessing plant dealt with slightly more than 1t of fast breeder fuels, thus demonstrating for the first time the closure of a fast reactor fuel cycle, in this case for Rap-sodie, the FBR research reactor.

The Marcoule pilot plant (Sap), commissioned in 1962 and adapted to reprocess fast breeder fuels in 1974 (Top), has reprocessed around 9t of fast breeder fuels already, ensuring the closure of the fuel cycle for the pilot FBR Phénix. About 6t of Phénix fuels have also been reprocessed in the La Hague UP2 facility (diluted with gas graphite fuels).

In the development of techniques to deal with the waste produced by reprocessing, the first fission products were glassified in 1958. The industrial phase was reached with the commissioning of the Marcoule vitrification facility (AVM) in 1976, which, by the end of 1982 had produced 260t of glass containing fission products derived from the equivalent of more than 350 years of operation of a 1000MWe PWR.

These results are a good illustration of French industrial experience. Nevertheless, many difficulties had to be overcome in achieving the commercialization of these technologies. The HAO unit, for example, which used a technology which had perhaps been developed less systematically than those associated with enrichment or the FBR, proved difficult to operate, largely because of minor but relatively numerous incidents. The problems were inflated because, while in a conventional installation a trivial breakdown, such as that of an electrical switch or a mechanical part, can be rapidly put right, repairs take far longer in a radioactive environment.

Nevertheless, the tonnages reprocessed, which were small at the beginning of the development phase as these problems were encountered, were systematically increased during the late 1970s. The annual capacity of the UP2 facility today may be put at about 250t of standard oxide fuels from French LWRs.

Building on the experience which had

Reprocessing spent fuel in France

By J. Mégy*

The sound current position of French reprocessing technology is the result of a sustained long term innovative effort. Technical problems remain, but the industry is confident that it has the capacity to design and build the large facilities needed by the country's nuclear power programme.

The French nuclear power programme is well advanced. Cumulative spent fuel tonnages are expected to be 2400t by 1985, 8000t by 1990 and 15 000t by 1995.

*Research Division on Reprocessing, Wastes, and Applied Chemistry. Commissariat à l'Énergie Atomique, Fontenay aux Roses, France.

To deal safely and economically with this problem, France has developed her own reprocessing and vitrification technology.

The first large French reprocessing facility was commissioned in Marcoule (UP1) in 1958. It is still in operation after

Fuel cycle

been gained, it was decided in the mid-1970s to expand the LWR fuel reprocessing facility at La Hague by building a new plant (UP3A) which it is hoped will come on stream during 1986. Plans were also made for a new vitrification plant (AVH) to be built at La Hague to come on stream at the same time as UP3A. In addition a 5t/y FBR fuel reprocessing

Fuels reprocessed in La Hague, from 1976 to 1982, tU

	1976	1977	1978	1979	1980	1981	1982
Gas							
graphite	218	351	372	264	253	251	200
LWR	14	17	37	75	102	100	154
Phenix	—	—	—	2.2	1.6	2.1	—

demonstration plant at Marcoule (Tor) is to be commissioned in 1984. Facilities for r and d have also been expanded during the latter part of the 1970s. Ultimately, it is expected that a commercial FBR fuel reprocessing plant (Purr) might be built sometime in the 1990s.

Organization. While the first reprocessing plant was set up at Fontenay aux Roses in 1954, it was not until the late 1970s that the Commissariat à l'Energie Atomique mounted a substantial innovative effort. Between 1976 and 1981 budget allocations increased fivefold (see figure p 42).

To supplement existing facilities, which included laboratories for process r and d and hot pilot installations, the Industrial Prototype Department (Service des Prototypes Industriels) was set up in 1976 for the full scale construction and testing of reprocessing components. Also, a Process Industrialization Department was formed (Département d'Industrialisation des Procédés) to prepare the 'process books' that contain the

French Industrial reprocessing experience to 1982, tU

	Type of fuel		
	Gas graphite	LWR	FBR
UP1 Marcoule	12 000	—	—
UP2 La Hague	4313	500	5.9
AT1 La Hague	—	—	1.1
Sap/Tor Marcoule	—	—	9

data needed to build a reprocessing facility, and to provide permanent liaison between the r and d departments, the Société Générale pour les Techniques Nouvelles (SGN) who carry out the engineering work, and the owners of the reprocessing plants, Cogema.

Future facilities, and in particular the expansion of La Hague, will thus benefit from fully tested techniques, examined and adopted in principle by the Central Safety Department for Nuclear Facilities (Service Central de Sûreté des Installations Nucléaires).

March 1983

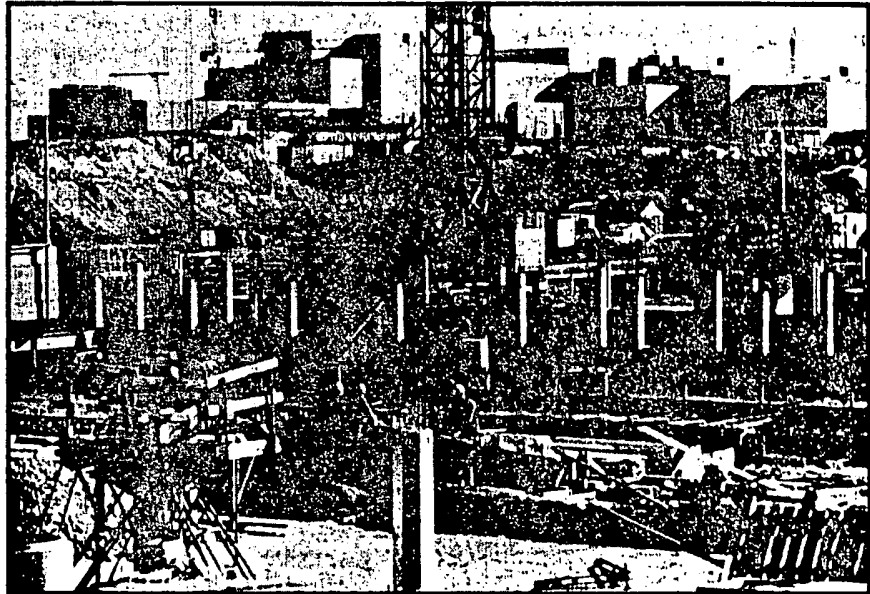

The La Hague reprocessing facility, showing in the background the UP2 plant and in the foreground work proceeding on the UP3A plant.

The organization for dealing with waste is similar to that for reprocessing. The Agence Nationale pour la Gestion des Déchets Radioactifs (known as Andra) owns the storage facilities.

The process. The Purex process is employed in present and planned reprocessing facilities. It is based on the separation of uranium from plutonium and fission products by solvent extraction using tributylphosphate and a diluent (see figure below).

The Purex process which is employed in all French reprocessing facilities.

This process was initially used on the gas graphite natural uranium fuels, and was then adapted to the reprocessing of light water and fast breeder fuels. The problems which are being tackled by the extensive r and d programme currently under way, include:

- At the plant head, the fuel elements are cut by chopping. New choppers are currently undergoing tests for the La Hague expansion and are being investigated for fast breeder fuels.
- In the present facilities, the chopped irradiated fuels are dissolved in boiling nitric acid in a batch dissolver. A continuous rotary dissolver, which is far more efficient and which will be used in the new facilities, is now undergoing full-scale tests.

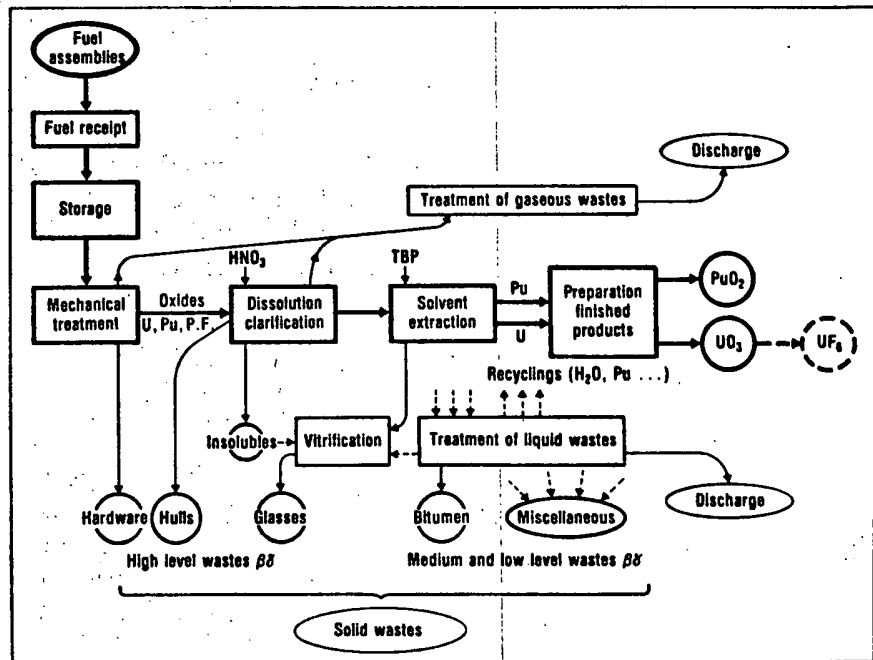

Fuel cycle

● It is very important to clarify the solutions, that is to separate the highly active insoluble fines. New prototype centrifuges and pulsed filters are undergoing tests.

● Chemical engineering research projects on pulsed columns for extraction are currently under way, as well as radioactive extraction cycles on a pilot scale, with cold cycles investigated in full-scale pulsed columns, for the new facilities.

● Work is also under way to improve tributylphosphate solvent processing and recycling. This could mean a significant improvement in process management, both technical and economic.

In general, new designs for components and systems emphasize remote control and remote maintenance and repair. The aim is to achieve very high equipment reliability and operating flexibility, in order not only to reduce personnel doses, but also to improve safety and load factors.

Wastes and effluents. A waste is a release that is processed into solid form and packaged in such a way that its return to the environment can only take place when it is sufficiently diluted to avoid incurring inadmissible risks, as defined by the requirements of the International Commission for Radiological Protection.

An effluent, on the other hand, is a liquid or gaseous waste which is returned immediately to the environment, after treatment if required, in sufficient dilution to eliminate the risk of radioactive exposure.

Programmes under way are designed to reduce the quantities of effluents and wastes by carrying out internal recyclings, by requiring that the materials leave the facilities at a small number of specific and carefully monitored points, and by adopting a specific packaging technique for each category. Hence, for example, iodine 129 leaving the process in gaseous form is trapped and converted to solid lead iodide, and then treated as a waste. Liquid effluents are decontaminated by an effluent treatment station. Technological advances have ensured that releases from the La Hague site will not increase despite the planned expansions.

In reprocessing, apart from uranium and plutonium nearly all the radionuclides are separated during the process and are subsequently found in the form of wastes. Some of these wastes contain α emitters (plutonium and other actinides) with long half-lives and high radiotoxicity. A distinction is made between various categories of waste:

● *Very high activity wastes* containing

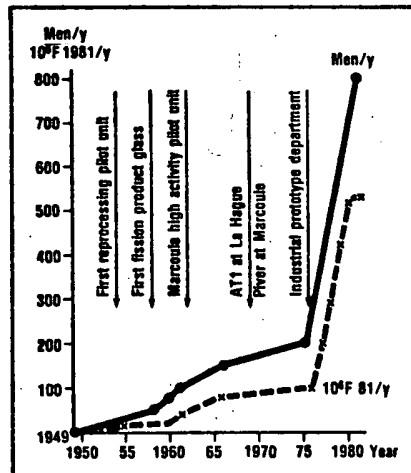

Evolution of the CEA's reprocessing r and d.

nearly all the fission products and actinides other than plutonium, separated during the extraction phase.

● *High activity wastes* such as mechanical treatment wastes (hulls, pieces of clad, ends etc) which still contain high $\beta\gamma$ activity and are contaminated with α plutonium,

● *Low and medium activity wastes* produced at different points of the process, and consisting mainly of wastes of the effluent treatment station. Some of these contain α emitters.

On the whole, about 1 per cent of the plutonium is immobilized in all these wastes. The results already obtained and advances under way in r and d on recyc-

ling and analytical methods will mean a considerable reduction in the quantity of plutonium in wastes produced by future plants.

These wastes are packaged according to their category. The very high activity wastes are packaged in the form of borosilicate glasses by the process developed at the Marcoule Vitrification Unit. Research and tests on glasses are continuing, and the prototypes of the future La Hague vitrification unit are undergoing initial trials at Marcoule. High activity wastes for the future plants will be immobilized in cement. The cementation installations are undergoing trials, the low and medium activity wastes will be immobilized in cement, in thermosetting resin, or in bitumen, depending on the physicochemical characteristics of the material to be immobilized.

After packaging, these wastes are then sent to final storage (after an interim period of varying length) involving: deep storage for wastes containing α emitters above a certain threshold; and surface or subsurface storage for other wastes.

Economics. At present, considering the estimates for the expansion of La Hague, the reprocessing of irradiated light water fuels costs about 1.2 centimes/kWh (not including slightly enriched uranium and plutonium, the utilization of which can cut this cost considerably). □

The options for solidifying low level waste

By M. J. Akins*, G. Costomirist, P. Deletet, R. B. Wilson†

The search for the optimum solidifying agent for low level rad-waste has generated considerable data about the various options available. The conclusion drawn from this data is that there is no universally applicable solidifying system. Individual agents must be matched with particular uses to achieve the best result.

There are generally four types of solidification agents (SA) commercially available to the American nuclear industry for low-level radioactive waste: bitumen (asphalt); portland cement - with or without additives; gypsum cement, with properties essentially the same as cement; and vinyl-ester resin.

Most other systems, which are either still under development or being designed for special applications, are

*Wimpey Gilbert Twickenham England.
†Gilbert/Commonwealth Reading, PA, United States.

variations on these four basic systems. Urea-formaldehyde (u-f) polymer, although once widely used, is a condensation-type polymer, prone to shrinkage and the rejection of substantial volumes of condensation and free water as it cures, making it unacceptable under current waste disposal regulations. It is not therefore considered here.

The majority of radioactive waste currently produced by nuclear facilities consists of demineralizer resins, evaporator concentrates, filter cartridges and powdered resin sludges and dry active waste.

APPLIED NUCLEAR RESEARCH

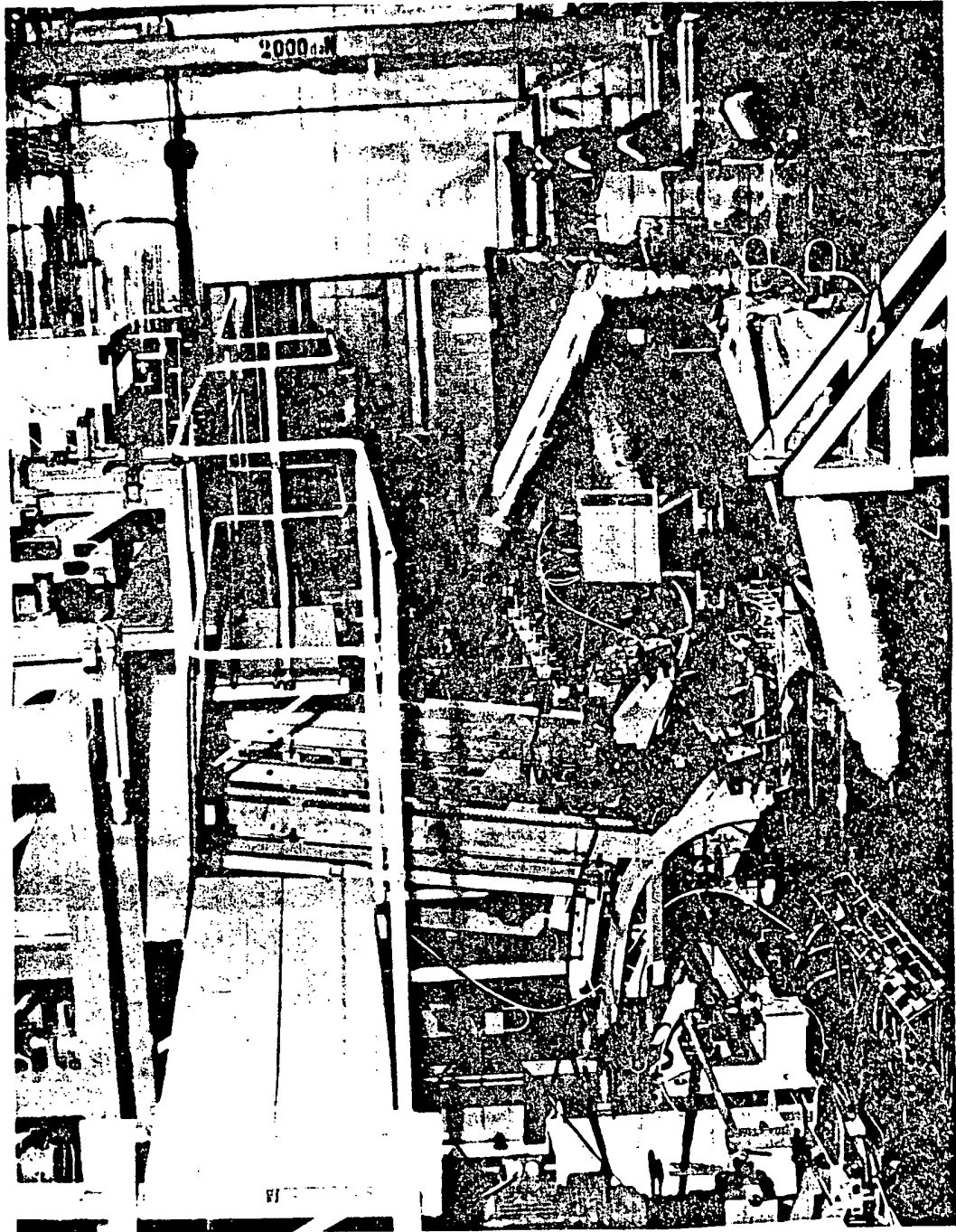

FRENCH ATOMIC ENERGY COMMISSION

Spent fuel reprocessing

R & D in this area included the following milestones in 1983:

- start of construction at La Hague of the large facilities associated with the future UP 3 plant, using data acquired previously in the C.E.A. laboratories and S.G.N. design offices, and which now requires considerable effort to complete relevant R & D programs;
- completion of the main construction phases of the T.O.R. plant to expand and modernize the Marcoule pilot facility, enabling equipment installation and cold testing in 1984;
- preparation of a scaled-down design for Cogema's planned FBR fuel reprocessing plant, but with the same timetable, to provide a report enabling a decision in 1986, making research on the design's most specific innovations a priority;
- emphasis placed on activities directly related to reprocessing, including studies for the management of "exotic" fuels (experimental or damaged and not directly reprocessable in Cogema's plants), as well as development of nuclear facility dismantling techniques;
- initial allowance for recommendations of the Castaing report issued at the end of 1982, particularly with respect to advanced reprocessing research and spent fuel management other than immediate reprocessing.

For water reactors, studies were performed at Fontenay-aux-Roses on the chemistry of technetium, an element that complicates extraction operations, and on the use of new reagents such as hydrazine carbonate to facilitate waste management. A new process was derived for oxidizing dissolution of plutonium oxide and progress was also made on theoretical modeling of waste extraction in pulsed columns.

At Marcoule, a number of UP 3 plant equipment prototypes were operated. A shearing machine was used to develop the most fragile components in collaboration with S.G.N.; a "bucket wheel" continuous dissolver was subjected to mechanical endurance and uranium oxide dissolution tests; an annular column setup was expanded and the columns were interconnected and tested; a low-pressure acid recovery unit was installed; and a revolving-bowl plutonium oxide precipitator was designed for Cogema.

Other ongoing support for chemical activities included: mechanical reliability studies for the bucket wheel dissolver; research on materials capable of withstanding corrosion in nitric acid environments, particularly zirconium and zirconium alloys; development of automatic and remote-control analysis techniques using fiber optics; testing at La Hague of nuclear instrumentation to be used at the UP 3 plant, particularly equipment to measure burnup of incoming fuel assemblies.

In addition, the C.E.A. deployed efforts to promote modern remote-control servicing techniques. In 1983, a mechanical remote manipulator produced by French industry was subjected to extensive testing. Cogema ordered a series of these units from the French supplier in view of the satisfactory results reported for the tests. An electronic programmable remote manipulator designed by the C.E.A. was also tested to develop a broader range of remote servicing capabilities for reprocessing plants.

Qualification of the spent FBR fuel underwater storage process was completed. A facility employing this process will be built on the Creys-Malville site.

A fissuring process for cutting hexagonal FBR fuel tubes was successfully hot tested for the first time using assemblies from the Phénix reactor. Plans call for use of this technique in the I.S.A.I. facility at Marcoule and subsequently in Cogema's projected FBR fuel reprocessing plant. Continuous dissolving of highly-irradiated (100,000 MWd/t) fuel pins was carried out inside a shielded line at Fontenay-aux-Roses to observe the effects of nitric acid on various types

This annular uranium extraction column has an active height of eight meters and is supplied by a metering wheel. It is part of a facility designed primarily to handle waste from future plants with a favorable geometric configuration in a single line.

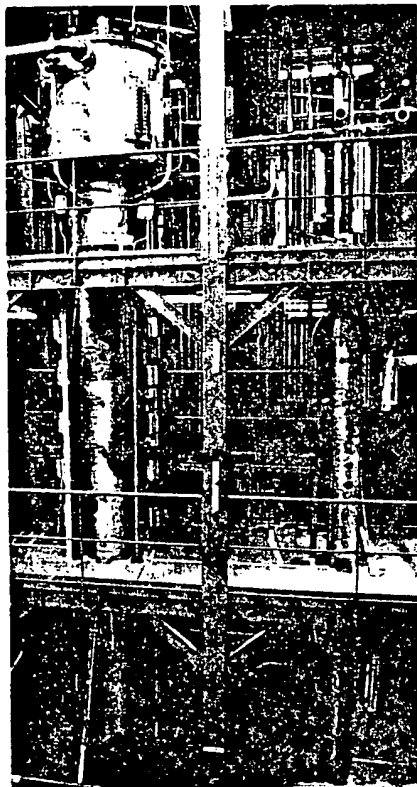

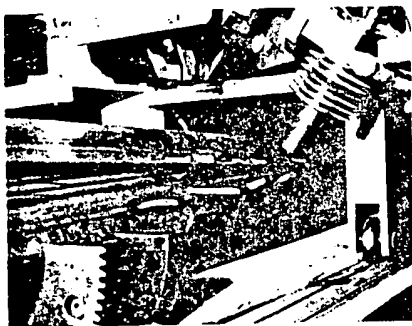

Fuel assembly laser cutting.

of fuel claddings. The bulk of efforts, devoted to specific components in 1983, focused on conceptual design of a helical-type continuous dissolver. An initial version of this dissolver will be installed in the T.O.R. plant in parallel with the conventional batch dissolver.

In addition to laboratory research, the C.E.A. contributed substantially to preparing input data for Cogema's MAR 600 facility, designed to permit industrial-scale reprocessing of fuel from the first FBRs. This included responsibility for preliminary design of process flow diagrams.

The S.A.P. pilot facility at Marcoule operated steadily during the first half of 1983. A total of 1,600 kilograms of uranium and plutonium were dissolved and 300 kilograms of plutonium were extracted. Various measurements and observations were performed during this period including fission product assessment, neptunium monitoring, testing of iodine zeolite absorption and hydrazine carbonate solvent treatment. The S.A.P. facility was then shut down since work on the T.O.R. plant was far enough advanced to enable connection with the rest of the pilot facility during the second half of the year. Construction will be completed in 1984 and followed by cold startup testing.

As part of international technology transfer cooperation efforts, information exchanges with Great Britain advanced normally. However, no major progress was made on negotiations with other nations planning to build reprocessing plants, e.g. West Germany and Japan.

Radioactive waste management

Last year's momentum intensified as new teams were set up within the Waste Research and Development Department created at I.R.D.I. and at I.P.S.N. Additionally, the budget of the Radioactive Effluent and Waste Mission increased 40% in current francs.

The year's highlights included:

- creation of a clay and compound materials laboratory (L.A.M.C.) for research on materials and engineered barriers in storage facilities;
- development of waste volume reduction techniques such as incineration, already demonstrated feasible for use on hot solvents and under study particularly for use on ion exchange resins, or cryogrinding for which a facility at Cadarache has performed satisfactorily under cold conditions;
- performance of design studies on decontamination processes for plant dismantling, using either chemical or electrochemical techniques, as well as gels or blasting jets.

Gels were successfully used in the waste asphalt-encapsulation facility at the Brennilis EL 4 reactor, reassembled after decontamination at Cadarache, and on structural steel from the German Isar boiling water reactor. The Isar structural steel was subsequently returned to West Germany for meltdown.

Significant achievements in vitrification included: excellent performance of the AVH cold prototype calciner for future facilities at La Hague; assistance provided to S.G.N. for startup of B.N.F.L.'s cold prototype at Sellafield in Great Britain; and increased efforts to prepare formulas and technology for high-temperature glass fabrication. Continuous operation for 170 hours of a cold crucible direct induction furnace with a capacity sufficient to accommodate an AVM-type industrial vitrification facility enabled meltdown of two tonnes of glass at crucible temperatures of 1,450 to 1,500 °C.

Additionally, installation of a prototype solid waste treatment system capable of melting fuel rods and incorporating dissolving fines in a metal matrix was

énergie nucléaire

magazine

Revue trimestrielle, remplaçant les numéros spéciaux nucléaires de Techniques de l'Energie

éditée par :

SOCIDOC, BIP
142, rue Montmartre
75002 PARIS
Tél. : 261.83.21.
C.C.P. PARIS 1391797
Télex : 220 528

Directeur de la publication :

Maxime BOUCKALTER

Rédaction en Chef :

Elisabeth LIEGEOIS

Rédacteur permanent :

Gérard FRIDMAN

Chef de la publicité,
et du marketing :
Pierre MORACHE

Chef de publicité :
Pierre KABOUCHE

Maquettiste :
Jeanne PROD'HOMME

Abonnement

France 1 an : 185 F (+ 4 % TVA)
Etranger 1 an : 225 F

SOMMAIRE

N° 7 — AOUT 1984

CYCLE DU COMBUSTIBLE NUCLEAIRE

Pas de vacances pour le nucléaire !	9
Un nouveau Secrétaire d'Etat à l'Energie	11
Cogéma: aujourd'hui et demain, interview de M. François de Wissocq, président directeur général de Cogéma	12
La Hague, le plus grand chantier d'Europe, par Elisabeth Liégeois	16
Cogéma affirme sa position de leader mondial dans le cycle du combustible	21
Le groupe Pechiney dans le cycle du combustible, par Elisabeth Liégeois	25
Framatome: un exercice 1983 satisfaisant, mais... l'horizon s'obscurcit	31
Pompes Guinard: une position de leader mondial pour les pompes nucléaires	34
France: une approche nouvelle dans la gestion des déchets radioactifs, par Gérard Fridman	38
NOUVELLES DU MONDE	
Les perspectives de l'industrie nucléaire américaine, par M. Carl Walske, président de Atomic Forum Inc	45
OCDE: capacité nucléaire et cycle du combustible	48
La C.E.E. va lancer un troisième programme sur les déchets	51
Le sous-sol marin: un cimetière du futur pour les déchets ?	54
LK 100 : emballage de transport pour combustibles irradiés, par Mme Maryvonne Le Paih, Etablissements Lemer et Cie	56
La politique de déclassement de la C.E.E.: l'"Etat de l'art" de Luxembourg, par Gérard Fridman	57
BELGIQUE	
L'accord nucléaire franco-belge	64
La valorisation industrielle du plutonium, par MM. H. Bairiot et S. Pilate (Belgonucléaire)	65
SUISSE	
La Suisse a besoin de l'énergie nucléaire, par M. Ernst Trümpy, président exécutif de Aar et Tessin Electricité	68
La 5 ^e centrale nucléaire	71
Expérience suisse dans le domaine de l'entreposage à sec des combustibles irradiés, par le Dr. C. Ospina, institut fédéral de recherches en matière de réacteurs (IFR)	72
ITALIE	
Le groupe Fiat dans le nucléaire	75
SFEN 92: dîner-débat sur fond d'électricité	77
Notices techniques	78
Bulletin d'abonnement, répertoire des annonceurs	106

see contents in English, page 81

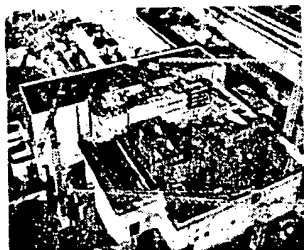

Notre couverture: Vue aérienne des installations de l'Etablissement Cogéma La Hague en exploitation et en construction.

Au premier plan, construction d'un second atelier de réception des châteaux de transport et de piscine de stockage. Vue Est-Ouest. (Doc. COGEMA).

Cogema affirms its position as world leader in the fuel cycle

Cogema has become the only industrial company in the world which can handle the whole nuclear fuel cycle from mineral prospecting to the reprocessing of radioactive fuels. This position has been attained through a steady investment policy: 10 billion francs of accumulated investments up until the end of 1983, of which 3.5 billions in 1983 alone. Turnover is in constant progress reaching 11 billion francs last year, of which 25 per cent in the export field. The company's cashflow reached at 1.8 billion franc. For the Cogema group as a whole, turnover was 17.63 billion francs compared to 15.2 billions in 1982 with exports at 35 billions compared to 6.7 billions. Cogema employs 9,000 people, which makes a total workforce of 14,000 for the group as a whole.

Natural Uranium. Cogema has access to almost 25 per cent of the world's production/concentration capacities. In France it holds almost 85 per cent of the country's reserves. Outside France it is playing an increasingly active role, in Africa, in Latin America and in North America. In 1983 concentrated uranium supplies represented nearly 8,000 tons, of which 1/4 was for foreign customers. The corresponding production was divided between French mines (nearly 2,500 tU), African mines (4,400 tU) and North-American ones (1,300 tU).

In France Cogema directly operates three mining complexes. In Africa it is associated with various partners in three mines, two of which are in Niger (Somair and Cominak) and one in Gabon (Comuf). In Canada, Cogema is the main shareholder in Amok which exploits fields near Cluff Lake. At the end of last year, a major field containing ore with a high uranium content was discovered at Waterbury Lake (Saskatchewan). In the United States Cogema acquired 80 per cent of the company Pathfinder Mines.

Enrichment. The Eurodif enrichment plant, in which Cogema has a 51.33 per cent stake, has adapted its operating rate to the decline in demand...

At Miramas Cogema has other isotopic separation capacities: from 150 to 200 kg a year of boron 10 and more than 1,000 kg a year of lithium 7. Lastly, Cogema is participating in the major R and D effort undertaken by the CEA on advanced enrichment processes.

Nuclear Fuel. Since 1976 Cogema has been supplying EDF's GCR plants with fuel elements manufactured by its 100 per cent subsidiary SICN. In the field of the

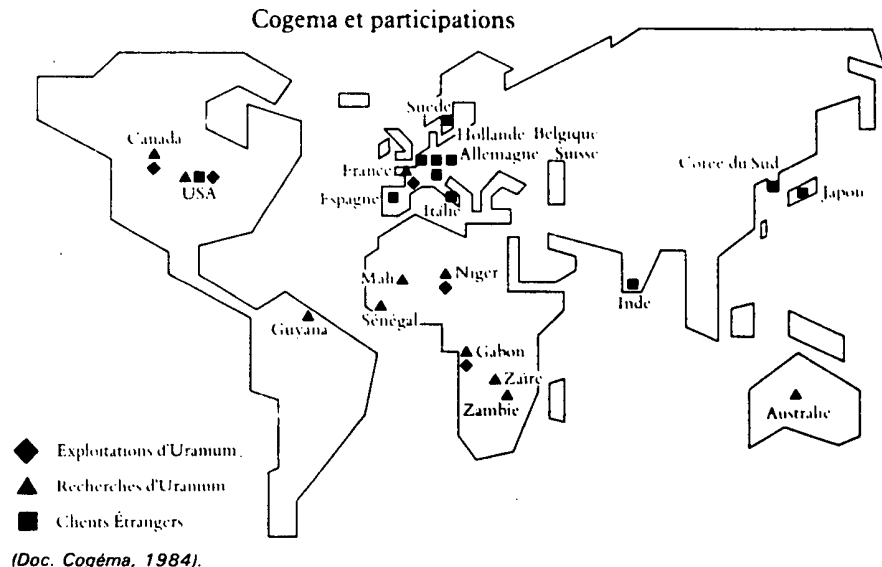

(Doc. Cogéma, 1984).

LWR, following the agreement reached on January 20 this year, Cogema has been given a 25 per cent stake in Eurofuel alongside Pechiney with 50 per cent and Framatome with 25 per cent. Eurofuel itself holds 87 per cent of the capital of FBFC; MMN holds the remaining 13 per cent. Cogema also holds 25 per cent in the company CFC alongside Pechiney with 50 per cent and Framatome with 25 per cent. FBFC operates the three fuel manufacturing plants of Romans, Dessel and Pierrelatte and divides up the manufacturing programmes between them. Finally Cogema is a fellow shareholder of Framatome (50/50) in Fragma, which is alone responsible for the design and marketing of the nuclear fuel. Cogema is also responsible for supplying the first core and the two first reloads for Superphenix.

Reprocessing. At the end of 1983 Cogema had reprocessed 5,842 tons of GCR fuel. At the same date, the UP 2 plant at La Hague had reprocessed more than 700 tons of LWR fuel (of which 221 tons in 1983). The plant is currently being expanded. What is more, a new plant (the UP 3 with a planned capacity of 800 tons a year) is currently being built at La Hague with start-up planned at the end of 1988. The UP 2 plant also reprocesses fastbreeder fuel (Phenix) by mixing it with GCR fuel. More than 6 tons had been reprocessed by the end of 1983. Lastly, by the end of 1983 the Vitrification Plant at Marcoule has already produced 867 glass containers, representing 713 cubic metres of high radioactive fission products.

Special transport services. This department called STS is involved in the design and manufacture of casks, cask management and the transport of radioactive matter. In liaison with STS, a department of radioactive fuels transport (STCI) is responsible, in liaison with STS, for all transport operations in the direction of La Hague and Marcoule. It assures the supervision of development, manufacture and maintenance of casks used for radioactive fuels, plutonium, waste and residues. It operates railway terminals, road transport and the cask maintenance workshop at La Hague.

Future. Cogema has 70 foreign clients, some of whom are in the United States, where it has achieved a spectacular breakthrough. Japan is however the company's most important foreign customer. Cogema also relies on its engineering subsidiaries. Company chairman François de Wissocq expects turnover will fall slightly this year (because of the renegotiation of the contract under which the USSR enriched uranium on behalf of France). But the cashflow will be "substantial". Investments will be increasing considerably this year to reach 5.5 billion francs for Cogema alone and 6 billion for the group as a whole. E.L.

Subscription form see
page 106

La Hague, the biggest work site in Europe

(from our special correspondent in La Hague)

Arriving near the La Hague site is an experience, even a shock, with the change in landscape. It is true that it is the biggest work site in Europe and that the infrastructure are at the same scale. For the construction requirements, Cogema set up the economic interest grouping Gifab to operate a concrete batching and mixing plant which can be taken down later. In five years it will produce some 800,000 cubic metres of concrete, a quarter of France's total production in a year.

The main work site - The plant which already exists at La Hague has belonged to Cogema since 1976. Under extensions planned both for French and foreign fuel, two major complexes are being built:

- UP3 A, a plant which is being completely financed by foreign customers and which will eventually include: a cask discharging facility; two pools (C and D) with a capacity of 2,000 tons apiece (the C pool received its first basket of radioactive fuel in April, while the D pool should be in service towards the end of 1985); a T 1 shearing/dissolution unit, of which the civil engineering work is currently in progress; four separation units, treatment of fission products, separation of uranium and plutonium (civil engineering in progress); a waste vitrification unit (T 7) with a capacity three times greater than that of AVM at Marcoule (civil engineering work started in May 1984); an STE 3/T waste treatment plant. This UP 3 complex, the construction

of which is progressing at full speed, will be in service in the middle of 1988, except for the vitrification shop which is due to start up at the end of March 1989.

- UP 2 800, the plant which is to come onstream in 1990, two years after UP 3. Already several shops of this complex, integrated to the facilities of the current plant, are being built or in some cases have even been completed. The BST 1 plutonium storage shop (completed at the beginning of 1983); the AD1 decontamination shop (completed at the beginning of 1984); SPF 5, the storage unit n° 5 for fission products (due to come onstream before the end of the summer); NCP 1, a facility for concentrating fission products (start up planned for the end of 1984); finally, R 7, the UP 2 800 vitrification shop for vitrifying fission products resulting from the reprocessing of 800 tons a year of fuel from this plant. The start up is due to take place in a little more than two years.

Facilities that are common to UP 3 and UP 2 800 - These include the new ST3 waste treatment station, which is due to come into service at the end of 1986; the site, that is to say all the infrastructural facilities which need to be planned around the nuclear buildings (roads and distribution networks, conduits, production and distribution of fluids etc). This work site is

being carried out alongside work being done on the two plants. As part of "major work site" procedure, Cogema is financing a certain number of works and municipal facilities in the region.

A lightening visit - In the pools in 10 metres of water lie the racks containing the radioactive fuel assemblies. The latest of these ponds to come into operation, the C pool, the first facility built in the UP 3 extension, is suspended on big neoprene blocks so as to assure an increased safety in the event of an earthquake. The following pools (D and E) are also suspended. Along the wall of the pool can be found the "Nymphéas" built by SGN, which are in fact very sophisticated exchangers designed to maintain the water at a constant temperature and quality.

Everywhere, in the maintenance period (July-August), it is the cleaning and maintenance of the material which produces a sizeable amount of technological waste: cotton, woven paper, polyethylene sheets and industrial grade gloves. The La Hague plant uses 7 million pairs of gloves a year. For the casks there is an outside storage area. Different models can be seen there: cubic casks for graphite gas fuel, cylindrical ones for LWR fuel, including Transnucléaire casks or the recent Lemer model. During treatment programmes around one cask is received every day.

Elisabeth Liégeois

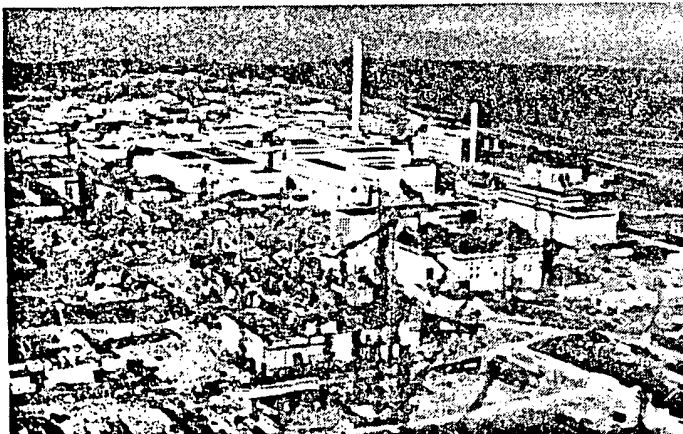

La Hague. Aerial view. UP3 programme: work in progress on the "medium activity" building. (Doc. Cogéma).

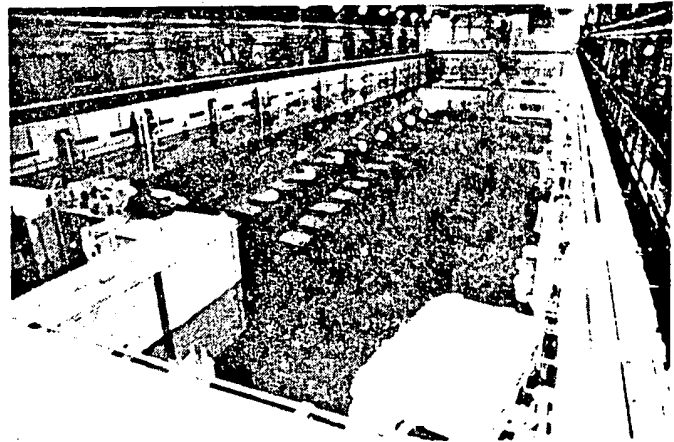

La Hague. Pool C. (Doc. Cogéma).

APPENDIX 9

Marcoule, COGEMA: French Plutonium Site

(Translation)

FRANCE

MARCOULE, COGEMA: FRENCH PLUTONIUM SITE

UNKNOWN

[Text] The Marcoule Mystique (1952-1958)

Marcoule's birth certificate is dated sometime during the winter of 1952-1953, when the [French] Atomic Energy Commission selected a flat stoney hilltop, 15 by 20 meters, bordered on the east by the Rhone [river], for the creation of the first French plutonium production center. The site, dominated by the Dent de Marcoule, a steep hill 220 meters high, is in the canton of Bagnols-sur-Ceze, in the northeast of the Gard departement, at the crossroads of the Languedoc, Provence and Rhone-Alpes regions. The geographic and hydrological reasons that caused its selection had already made it the choice in Gallo-Roman antiquity for the construction of a vast manufacturing and shipping complex for wine amphora from the region.

In 1952, the CEA [French Atomic Energy Commission] was seven years old, seven years that had been used to make up for the delay that France had experienced due to the war in the area of nuclear energy. 70 percent of

of the financial resources of the first five-year plan for industrial development of atomic energy were devoted to the new Marcoule center. Its construction took place in the extraordinary climate that characterizes the work of "pioneers."

This enthusiasm accomplished miracles. The center, built in less than 3 years, was dedicated 10 October 1955 by Mr. Guillaumat and Mr. Perrin. At the beginning of the following year, on 7 January, was the divergence of the G1 reactor, which was built in 18 months. On 25 September 1956 the first French kWh of nuclear origin were produced.

The construction of the G2 reactor began in March 1956 along with its large associated power plant, while construction began on the G3 and the plutonium reprocessing plant.

The Plutonium Route (1958-1969)

Marcoule entered the production phase. During this period, plant activity was basically devoted to the production of the nuclear material required for the first generation of devices for the French deterrent power.

Some key dates:

—January 1958: Startup of the UP1, first French reprocessing plant;

--July 1958: divergence of the G2 and entrance of the first load of irradiated uranium into the plant;

--20 February 1959: production of the first plutonium lingot;

--15 May 1967 and 30 October 1968: divergence of the two Celestin reactors, designed to supply the tritium used for thermonuclear arms.

During this period, facilities for waste treatment, storage of fission products (1960) and the bitumen coating shop (1966) were created at the same time.

Starting in 1969, after 12 years of uninterrupted expansion, Marcoule went through a difficult period: needs for "strategic" plutonium were falling off and the reprocessing capacity exceeded needs, due to the delays of the nuclear electricity program.

Therefore, a diversification of the firm's activity was undertaken: reprocessing of fuels from European research reactors, production of radioactive elements, miscellaneous services.

The only notable success during that time when France was rethinking its nuclear future: the construction of the Phenix.

This reactor, the industrial prototype of the "fast neutron" type diverged on 31 August 1973 and produced its first billion kWh on 23 October 1974.

Marcoule Today

The rebirth of Marcoule can be dated from 1975. That year, the French nuclear apparatus was simplified and organized. On 19 January 1976, COGEMA [General Company for Atomic Materials] was born, since the CEA had obtained the agreement of the government to "give to its industrial means in the fuel cycle the form of a full-fledged company." On 1 June of the same year, Marcoule became an establishment of the reprocessing branch of COGEMA.

Despite the inevitable problems raised by such a change, the first signs of relaunching were quickly perceptible: investments, activity programs, hiring of a young and qualified personnel (2,579 workers on 31 December 1979 compared to 2,096--CEA plus COGEMA--3 years earlier). During this period, COGEMA alone recruited 664 persons.

In order to live in the present, Marcoule is creating a new image, of which the principle traits are the following:

The Reactors

The G1, G2 and G3 reactors responded to the desire to associate with a considerable plutonium production--the first purpose of Marcoule--a significant production of electricity.

At the present time only G3 remains in operation, with G1 having been shut down in October 1968 for economic reasons and G2 in February 1980, the twentieth anniversary of its going on line. The perfect regularity

of operation that always characterized this reactor gave it the world record for continuous operation.

Its load factor was an average of 82.5 percent for its first 20 years. During that period, G3 produced 5,269 billion kWh. In normal operation, G3 and its twin brother G2 produced about 600 million kWh annually, or the equivalent of 140,000 TOE (tons oil equivalent).

The industrial irradiation reactors Celestin 1 and Celestin 2 were built in 1967 and 1968 to produce tritium, the heavy hydrogen isotope used for the requirements of the nation's thermonuclear armament and designed to serve other irradiations for the production of radioactive elements and transuranians.

With a power of about 200 MWe each, they are cooled and moderated with heavy water and supplied with either enriched uranium or with plutonium.

These two reactors exhibit a high degree of safety in operation and their flexibility in adapting to extremely diverse production for industrial, medical and pharmaceutical use (cobalt 60, Pu 238 for cardiac stimulators, specifically) has been remarkable. Since 1976, these irradiation tools have received a plutonium breeding vocation whose purposes are identical to those of the G reactors.

The breeder reactor Phenix, installed on the north end of the Marcoule site, is a plant related to the CEA-Rhone valley firm and run by a joint

CEA-EDF team. Placed in operation in 1974, Phenix is the intermediate step between the experimental reactor Rapsodie and the 1200 MWe commercial prototype Super-Phenix being constructed at Creys-Malville (Isere) which is supposed to diverge at the end of 1983.

Reprocessing

When France chose the "plutonium route" in 1952 and decided to make Marcoule a complete center for the production of plutonium, the plan was to associate a product extraction plant with the primary reactors. This last extraction link, what is now called the "reprocessing" link, is today composed of a unit made up of storage pools, cladding removal facilities and the reprocessing plant itself.

There are four storage pools where the short-lived radioactivity of the fission products, which are particularly radioactive, is allowed to decay before the operation of reprocessing irradiated fuels from reactors begins.

Fuel from the G reactors is stored from 5 to 6 months. [Fuel] elements from the Celestin reactors is stored over 9 months, and the fuels from the EDF [French Electricity Company] reactors of the natural uranium graphite gas type (UNGG) is stored over a year.

Cladding removal is the operation which consists of removing the cladding from the irradiated uranium bars prior to their entry into the plant

itself. Considerable modifications, which are aimed at the improvement of working conditions and process reliability, have been made in the operation of this shop.

In 1983, MAR 400 will relay the current facility for the processing of fuels from the EDF reactors, integrating the experience acquired in the operation of similar facilities at La Hague and Marcoule, specifically in three areas:

--dry unloading of casks in a shielded cell with robotization of the cask decontamination operations;

--the creation of two storage pools;

--doing the mechanical processing of the fuel cartridges in shielded cells using remote control.

The reprocessing of irradiated fuels, the purpose of which is to separate materials that can be recycled from the radioactive wastes, is done at Marcoule in plant UPl which uses the Purex process. This process, developed during the first world war by the Americans, is today the most widely used in the world. It is characterized by a succession of separation in an aqueous medium of the products placed in solution and uses the property of certain solvents to extract uranium and plutonium selectively.

At first, the plant received exclusively the fuel bars from the G reactors. Year after year, the facilities have been improved. Today UPl has carried out the first phase of its evolution which now makes it possible for it to reprocess a portion of the UNGG fuels from the EDF reactors and, in the near future, all of the fuels from this reactor type.

The fission products from fuels reprocessed at Marcoule represent about one percent of the weight of the irradiated fuel and almost all of its radioactivity, or about 99 percent.

Their storage was done at the beginning, and continues to be done, in specially designed vessels built for this purpose. Their inspection is very stringent and numerous safety measures guard against any defect.

But that can only be a temporary solution for a few decades. The long-term safety of the storage (as well of the handling and transportation) require the solidification of these products, which are in the form of concentrated acid solutions, after reprocessing. Glass has been selected as the final material.

In fact, the glass selected, a borosilicate, lends itself particularly well to incorporation of all of the oxides of fission products, or about 40 elements. Vitrification also has the advantage of reducing the waste volume, which is variable depending on the type of fuel involved. Finally, this glass, because of its very low lixiviation [leeching] rate, which

reflects its very low solubility, is the ideal material to eliminate practically any risk of contamination of the environment.

The nominal production capacity of the AVM, which is about 200 containers per year, was determined to satisfy the regular needs of the plant and also to absorb, over several years, the liquid stock of fission products that has been accumulated over a period of about 20 years.

The storage of the containers filled with radioactive glass, which are not contaminants, but rather extremely irradiating, takes place in 220 wells 10 m high, each capable of holding 10 containers. These wells are constructed in a concreted envelope, in an enclosure contiguous to the AVM. The total capacity of the storage hall is 330 m^3 of glass. It covers the operating needs of 11 1000 MWe PWR reactor units for 10 years.

From its inauguration in 1978 until May 1981, the AVM vitrified 380 m^3 of concentrated solution of fission products representing the equivalent of 7,300 tons of fuel. In all, 172 tons of radioactive glass, packaged in 506 containers have been produced.

Thanks to the demonstration made by the proper industrial operation of the AVM, the predominant position of France is the basis of considerable commercial fallout. To date, contracts involving the continuous vitrification process have been signed with FRG, Belgium and the United Kingdom.

The Marcoule reprocessing plant is completed by laboratories whose basic purpose is to monitor the production of the plant and by the industrial chemical engineering department, created to assist the production services in the study and development of processes and new techniques.

The cultural and athletic clubs in Marcoule offer numerous activities and are open to the local population since 40 percent of their 4,500 members are from outside the [Marcoule] firm. The plant also has relations with schools and the university (700 visits and 50 annual apprenticeships, payment of a FR 400,000 apprenticeship tax, lectures at the facilities, participation in the university-industry association) and the socio-professional organizations (the Nimes Chamber of Commerce and Industry, the Gard Committee for Economic Expansion and Productivity).

Relations are also excellent with the wine-producing community. This renowned vineyard, with the appellation "Cotes du Rhone" (wines from Chusclan, Orsan, Tresques) is the oldest in France, With 890 growers and 6920 hectares planted with vines, the canton of Bagnols-sur-Ceze is in the second rank in the departmental inventory, after that of Vauvert. Both from the production standpoint and from the standpoint of production surface, being near Marcoule has never brought any harm to this famous vineyard.

In sum, the average financial flow induced by the Marcoule economic activity is on the order of Fr 350 million per year (1980 economic conditions), almost all of which benefits the immediate vicinity.

Marcoule Tomorrow

Marcoule believes in the future because it has been able to forge its own future. An early worker in the great French nuclear thrust, the firm could have rested on its laurels. In 1976, with the appearance of COGEMA, it decided to wake up, to get back into the mainstream.

This effort that has been made already assures that it will continue on to the end of the century. While the reprocessing activity is still half civilian and half military, construction to increase the capacity of the plant will allow it to relay La Hague in treating all of the fuels from the EDF UNGG reactors, until its extinction around 1995.

All of the facilities under construction or planned bear witness to Marcoule's will to live.

--MAR 400 (storage and cladding removal of fuels).

--New continuous oxalate shop (end of the reprocessing process).

--New station for the treatment of liquid effluents.

--New water network and electrical supply.

--Renovation of the laboratories assuring the on-line monitoring of the reprocessing plant.

PICTURE CAPTIONS

- P. 1 G2 and G3 under construction. While the G1 reactor was designed to allow quick construction, the G2 and G3 reactors are the fruit of the experience acquired on this first prototype.
- P. 2 The G2 and G3 reactors. Each building could house three Arcs de Triomphe side by side. G3 is the only one still in operation.
- P. 3 The industrial irradiation reactors Gelestin 1 and 2. They manufacture tritium as well as products for medical and pharmaceutical use.
- p. 4 The breeder reactor Phenix
(top)
- p. 4 Handling of a cask for the transport of gas-graphite fuels
(lower left) after their use in the reactor.
- p. 4 The storage pool. The fuel cartridges are stored here at least
(lower right) 5 months in order for their radioactivity to decay.
- p. 5 The UPl reprocessing plant where the separation of uranium, plutonium
(top) and fission products is done. It processes irradiated fuels from gas-graphite power plants.

- p. 5 The cladding removal facility. The irradiated fuels have their
(bottom) magnesium cladding removed with a hydraulic jack.
- p. 6 UPl interior view: reprocessing control board
(top)
- p. 6 Exterior view of the fission products vitrification shop (AVM).
(middle) This is where the fission products are incorporated in glass.
- p. 6 Glass pouring during inactive tests done in the pilot shop.
(bottom)
- p. 7 In this storage hall containers containing vitrified fission products
are stored. (Here, an exhibit container).
- P. 8 MAR 400 during construction.
- p. 9 MARCOULE: REGIONAL CROSSROADS Marcoule is at the crossroads of the
Rhône-Alpes, Languedoc and Provence regions.

TECHNICAL DATA SHEETS

P. 3 (top)

G3 Reactor

Reactor Building Dimensions: Height 50 m

Length 75 m

Width 45 m

Fuel: Load: 130 tons natural uranium in magnesium-clad bars. Diameter 3.1 cm,
length 28.2 cm.

Moderator: 1,200 tons of graphite bars

Cooling: Carbonic gas, pressure 15 kg/cm²

Input temperature: 140°

Output temperature: 320° to 365°

Power: 38 MWe

P. 3 (bottom)

Celestin 1 and 2: Industrial irradiation reactors. They produce tritium
and plutonium

Power: 200 MWe each

Fuel: Enriched uranium or plutonium

Moderator: Heavy water in closed circuit.

Rate 9,000 m³/hr

Cooling: Heavy water

p. 4 (left)

Phenix Breeder Reactor, begun in 1968, placed in service in 1974

Power: 250 MWe

Fuel: Mixed oxide of uranium and plutonium UO_2-PuO_2

Moderator: None

Cooling: Liquid sodium

Input temperature: 400°

Output temperature: 560°

p. 4 (right)

THE BREEDER REACTOR

The principle: the breeder reactor uses plutonium 239 as the fissile material and uranium 238 as the fertile material. Once the reaction has started, the uranium 238 placed around the core is transformed into plutonium 239 by capture of a neutron.

Contribution: Its provides a solution for energy supply. It uses two by-products of thermal reactors: the depleted uranium discarded by the enrichment plants or by the reactors and the plutonium. It ups the energy efficiency of natural uranium, which it alone consumes completely, by a factor of 50. Once the reactdon has started, it allows production of more plutonium than it consumes.

p. 5

GAS-GRAPHITE POWER PLANTS

UP1: reprocessing plant for irradiated fuels from gas-graphite power plants.

St-Laurent-des-Eaux I: 480 MWe

St-Laurent-des-Eaux II: 515 MWe

Chinon II: 200 MWe

Chinon III: 480 MWe

Bugey I: 540 MWe

Marcoule G3: 38 MWe

p. 6

AVM: Fission product vitrification shop

Vitrification capacity: 200 containers per year

Storage capacity: 380 m³ of glass in 220 wells 10 meters high

From 1978 to May 1981: 172 tons of radioactive glass have been produced.

9969

CSO: 8119/0983

La « mystique de Marcoule » (1952-1958).

L'acte de naissance de Marcoule se situe dans le courant de l'hiver 1952-1953, lorsque le Commissariat à l'Énergie Atomique choisit pour implanter le premier centre de production de plutonium français, une terrasse caillouteuse de 15 à 20 mètres de niveau, longée à l'est par le Rhône. Le site - dominé par la Dent de Marcoule, colline abrupte de 220 mètres - se trouve dans le canton de Bagnols-sur-Cèze, au nord-est du département du Gard, au point de jonction des régions Languedoc, Provence et Rhône-Alpes. Les raisons géographiques et hydrauliques qui l'ont fait élire, l'avaient déjà fait choisir dans l'antiquité gallo-romaine pour l'installation d'un vaste complexe de fabrication et d'expédition d'amphores de vin de la région.

En 1952, le CEA avait sept ans. Sept années employées à rattraper le retard pris par la France dans le domaine de l'énergie nucléaire durant la guerre. 70% des ressources

financières du premier plan quinquennal de développement industriel de l'énergie atomique sont affectées au nouveau centre de Marcoule. Sa construction se déroule dans le climat extraordinaire propre aux travaux de « pionniers ».

Cet enthousiasme fait des miracles. Le centre, construit en moins de trois ans, est inauguré le 10 octobre 1955 par MM. Guillaumat et Perrin. Au début de l'année suivante, le 7 janvier, divergence du réacteur G1, dont la construction s'est faite en 18 mois. Le 25 septembre 1956 sont produits à Marcoule les premiers kWh français d'origine nucléaire.

En mars 1956 commence l'édification du réacteur G2, avec sa grande centrale associée, tandis que sont ouverts les chantiers de G3 et de l'usine de retraitement de plutonium.

La voie du Plutonium (1958-1969).

Marcoule entre dans la phase de production. Pendant cette période, l'usine est essentiellement axée sur la production de la matière nucléaire nécessaire à la première génération d'engins de la force de dissuasion française.

Quelques dates clé :

- janvier 1958 : démarrage de UP1, première usine française de retraitement ;
- juillet 1958 : divergence de G2 et entrée dans l'usine de la première charge d'uranium irradié ;
- 20 février 1959 : production du premier lingot de plutonium ;
- 15 mai 1967 et 30 octobre 1968 : divergence des deux réacteurs Célestin, destinés à fournir le tritium utilisé pour l'armement thermonucléaire.

Parallèlement, sont mises en place, au cours de cette période, les installations de traitement des déchets, le stockage des produits de fission (1960) et l'atelier d'enrobage de bitume (1966).

À partir de 1969, après douze années d'expansion ininterrompue, Marcoule traverse une période difficile : les besoins en plutonium « stratégique » sont en baisse et la capacité de retraitement est excédentaire du fait du retard pris par le programme électro-nucléaire.

Aussi, une diversification de l'activité de l'établissement est-elle entreprise : retraitement des combustibles des réacteurs de recherche européens, production de radio-éléments, prestations de services divers.

Seule réussite notable, dans ce temps où la France repense son avenir nucléaire : la construction de Phénix.

Ce réacteur, prototype industriel de la filière « neutrons rapides » diverge le 31 août 1973 et produit son premier milliard de kWh, le 23 octobre 1974.

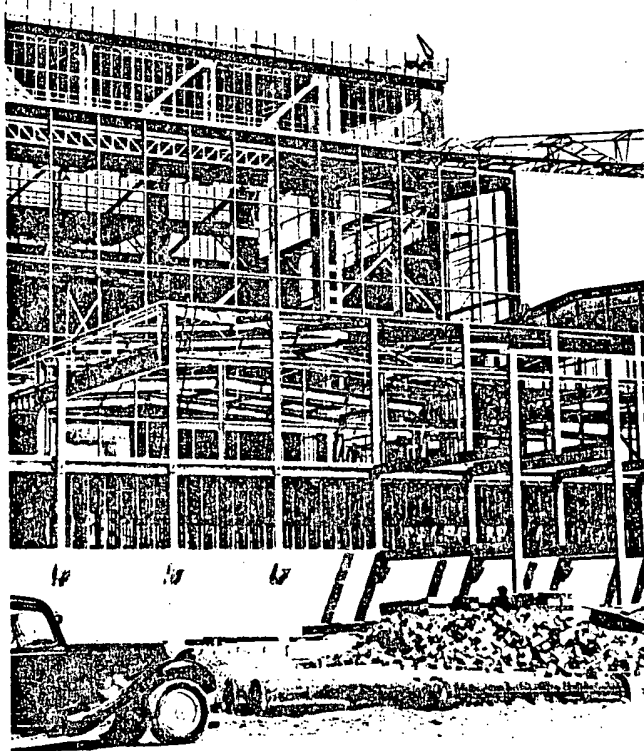

G2 et G3 en cours de construction. Alors que le réacteur G1 a été conçu de manière à permettre une réalisation très rapide, les réacteurs G2 et G3 sont le fruit de l'expérience acquise sur ce premier prototype

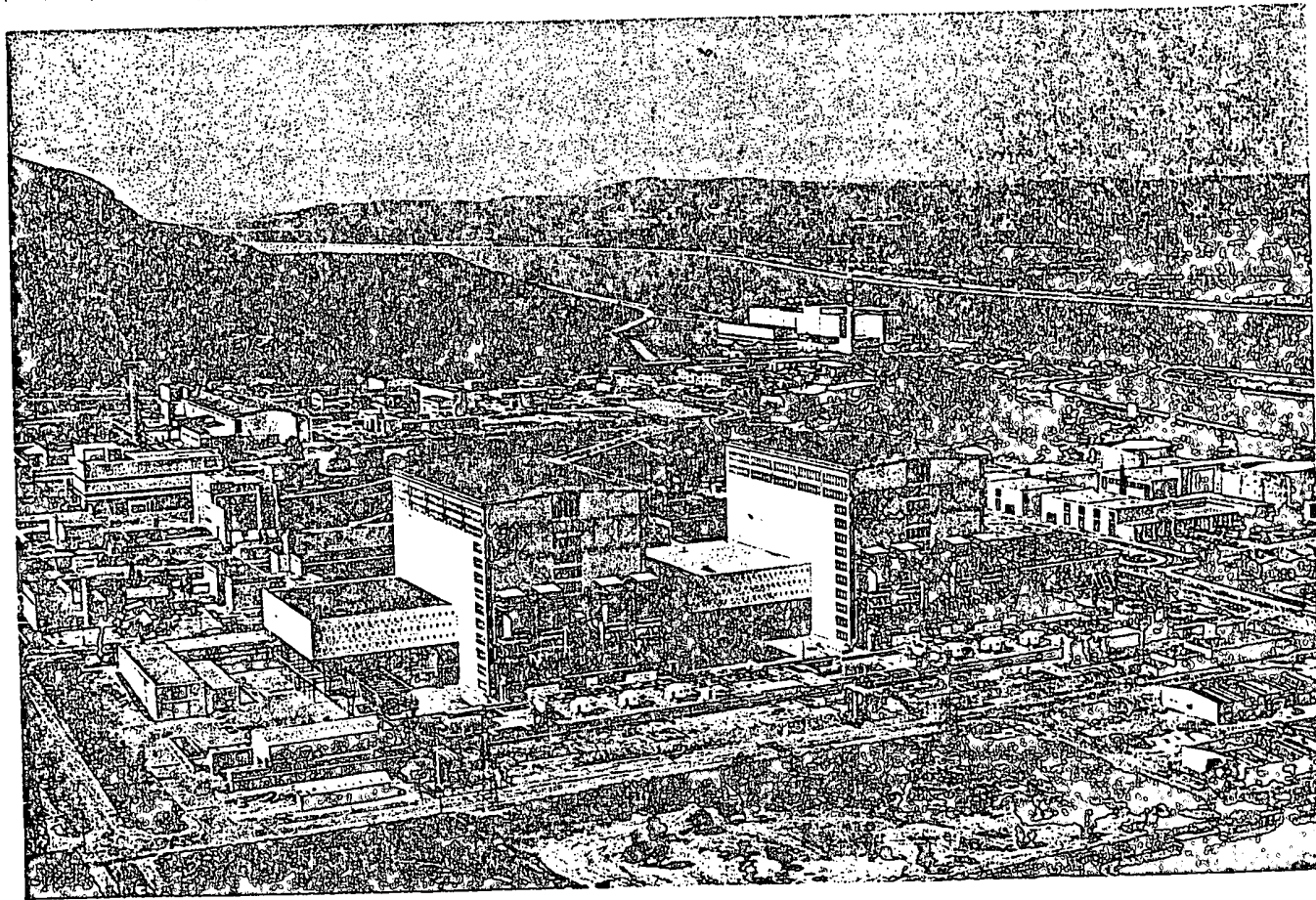
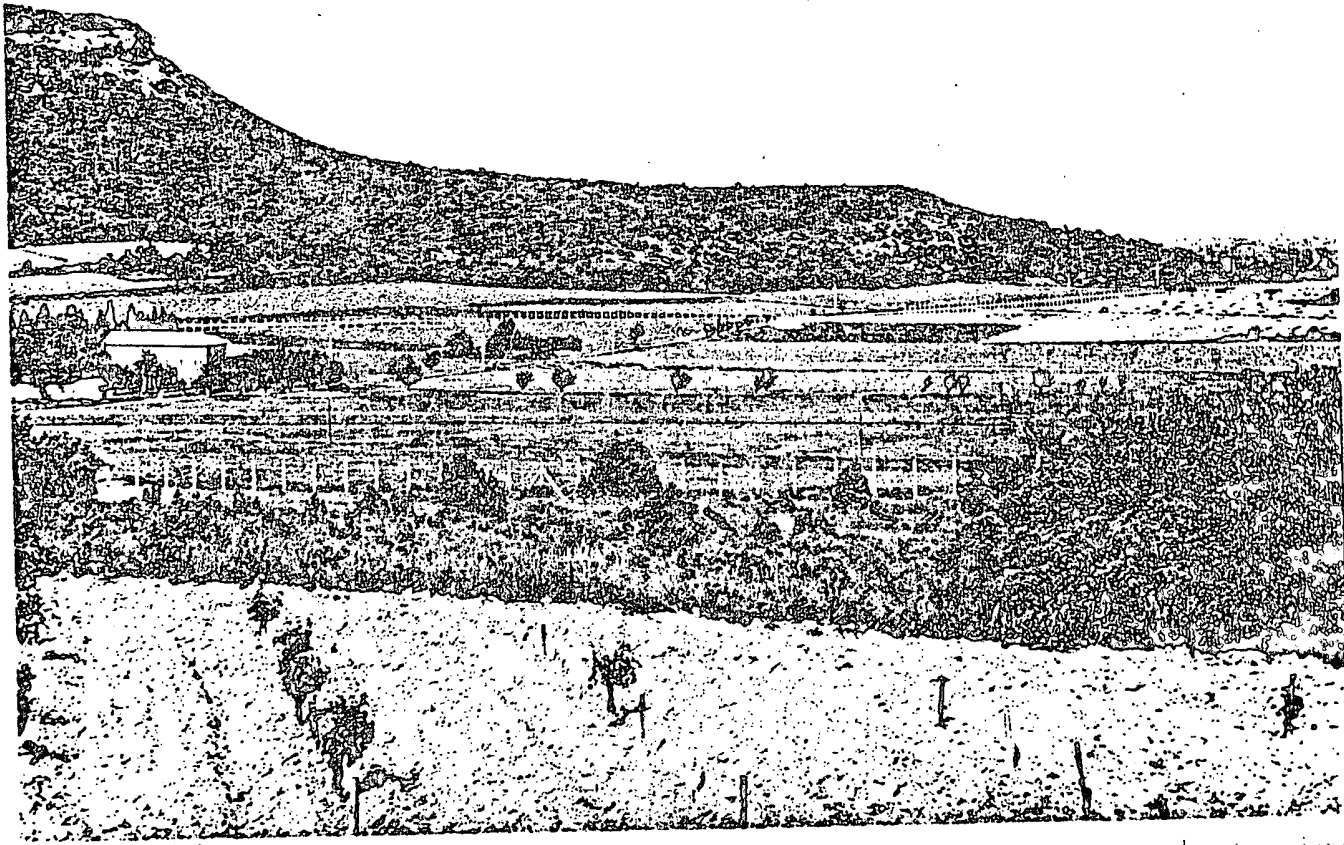

Le redémarrage de Marcoule peut être daté de 1975. Cette année-là, le dispositif nucléaire français est simplifié et ordonné. Le 19 janvier 1976, la Cogéma voit le jour, le CEA ayant obtenu l'accord du gouvernement pour « donner la forme d'une société de plein exercice à ses moyens industriels du cycle du combustible ». Le 1^{er} juin de la même année, Marcoule devient un établissement de la branche retraitement de la Cogéma.

En dépit des inévitables problèmes posés par une telle mutation, les premiers signes d'une relance sont rapidement perceptibles : investissements, programmes d'activité, embauche d'un personnel jeune et qualifié (2579 agents au 31 décembre 1979 contre 2096 - CEA plus Cogéma - trois ans plus tôt). A elle seule, la Cogéma a recruté dans cette période 664 personnes.

Marcoule, pour vivre au présent, se dessine un nouveau visage, dont voici les traits principaux :

Les réacteurs.

Les réacteurs G1, G2 et G3 répondaient au désir d'associer à une production importante de plutonium, finalité première de Marcoule, une production significative d'électricité.

A l'heure présente seul G3 reste en fonctionnement, G1 ayant été arrêté en octobre 1968 pour des raisons économiques et G2 en février 1980, le vingtième anniversaire de son couplage au réseau. La parfaite régularité de marche qui a toujours caractérisé ce réacteur lui a valu de détenir le record du monde de fonctionnement continu.

Son facteur de charge est en moyenne de 82,5% pour ses vingt premières années. Au cours de cette période, G3 a produit 5269 milliards de kWh. En fonctionnement normal, G3 et son frère jumeau G2 produisaient environ 600 millions de kWh par an, soit l'équivalent de 140000 Tep (tonnes d'équivalent pétrole).

Les réacteurs d'irradiation industrielle Célestin 1 et Célestin 2 ont été construits en 1967 et 1968 pour produire du tritium, isotope lourd de l'hydrogène utilisé pour les besoins de l'armement thermonucléaire national, et conçus de façon à pouvoir servir d'autres irradiations, pour la production de radioéléments et de transuraniens.

D'une puissance d'environ 200 MWe chacun, ils sont refroidis et modérés à l'eau lourde et alimentés soit avec de l'uranium enrichi soit avec du plutonium.

Ces deux réacteurs manifestent une grande sûreté de fonctionnement et leur souplesse

d'adaptation à des productions très diverses à usage industriel, médical et pharmaceutique (cobalt 60, Pu 238 pour les stimulateurs cardiaques notamment) a été remarquable. Depuis 1976, ces outils d'irradiation ont reçu une vocation plutonigène dont les finalités sont identiques à celles des réacteurs G.

Le réacteur surgénérateur Phénix, implanté au nord du site de Marcoule, est une usine relevant de l'établissement CEA - Vallée du Rhône et confiée à une équipe mixte CEA - EDF. Mis en exploitation en 1974, Phénix est l'étape intermédiaire entre le réacteur expérimental Rapsodie et le prototype

commercial de 1200 MWe Super - Phénix, en cours de construction à Creys-Malville (Isère) et qui doit diverger à la fin de 1983.

Le retraitement.

Lorsqu'en 1952 la France a choisi la « voie du plutonium » et décidé de faire de Marcoule un centre de production de

plutonium complet, le plan prévoyait d'associer aux réacteurs primaires une usine d'extraction du produit. Ce dernier maillon d'extraction, disons maintenant « de retraitement », est aujourd'hui constitué d'un ensemble formé de piscines de stockage, d'installations de dégainage et de l'usine de retraitement proprement dite.

Il existe quatre piscines de stockage où, avant que ne commencent les opérations de retraitement des combustibles irradiés en provenance des réacteurs, on laisse décroître la radioactivité des produits de fission à vie courte, particulièrement actifs.



Les réacteurs G2 et G3. Chaque net-polluant apporte, côte à côte, trois arcs de triomphe comme celui de l'Étoile à Paris. G3 reste seul en exploitation.

Le séjour est de 5 à 6 mois pour le combustible des réacteurs G, de plus de 9 mois pour les éléments provenant des réacteurs Célestin, et de plus d'un an pour les combustibles des réacteurs EDF de la filière uranium naturel graphite gaz (UNGG).

Le dégainage est l'opération qui consiste à débarrasser de leur gaine les barreaux d'uranium irradiés avant leur entrée dans l'usine proprement dite. D'importantes modifications - qui vont dans le sens d'une amélioration des conditions de travail et de la fiabilité du procédé - ont été apportées au fonctionnement de cet atelier.

En 1983, MAR 400 prendra le relais de l'installation actuelle pour le traitement des combustibles des réacteurs EDF, en intégrant l'acquis de l'expérience d'exploitation d'installations similaires à La Hague et à Marcoufè, notamment dans trois domaines :

- le déchargement à sec des châteaux dans une cellule blindée avec robotisation des opérations de décontamination des châteaux ;
- la création de deux piscines de stockage ;
- la réalisation des opérations de traitement mécanique des cartouches de combustible dans des cellules blindées à télécommande.

Le retraitement des combustibles irradiés qui a pour but de séparer les matières recyclables des déchets radioactifs est effectué à Marcoule dans l'usine UP1 qui utilise le procédé Purex. Ce procédé mis au point durant la première guerre mondiale par les Américains est aujourd'hui le plus répandu dans le monde. Il se caractérise par une succession de séparations en milieu aqueux des produits mis en solution et utilise la propriété de certains solvants d'extraire préférentiellement l'uranium et le plutonium.

L'usine a reçu exclusivement, dans un premier temps, les barreaux de combustible des réacteurs G. Année après année, les installations ont été améliorées. Aujourd'hui UP1 a mené à bien la première phase de son évolution qui lui permet de retraiter dès maintenant une partie des combustibles UNGG des réacteurs EDF et, dans un proche avenir, l'ensemble des combustibles de cette filière.

Les produits de fission issus des combustibles retraités à Marcoule représentent environ 1% du poids du combustible irradié et la quasi totalité de sa radioactivité, soit environ 99%.

Leur stockage s'effectuait au départ - et continue de l'être - dans des cuves spécialement conçues et élaborées à cet effet. Leur surveillance est très sévère et de nombreuses sécurités parent à toute défaillance.

FICHE TECHNIQUE

Réacteur G3

Dimension de la nef : Hauteur 50 m
Longueur 75 m
Largeur 45 m

Combustible : Charge : 130 tonnes d'uranium naturel en barreaux gainés de magnésium. Diamètre 3,1 cm, longueur 28,2 cm.

Modérateur : 1 200 tonnes de barres de graphite.

Refroidissement : Gaz carbonique, pression 15 kg/cm².
Température d'entrée : 140°.
Température de sortie : 320° à 365°.

Puissance : 38 MWe.

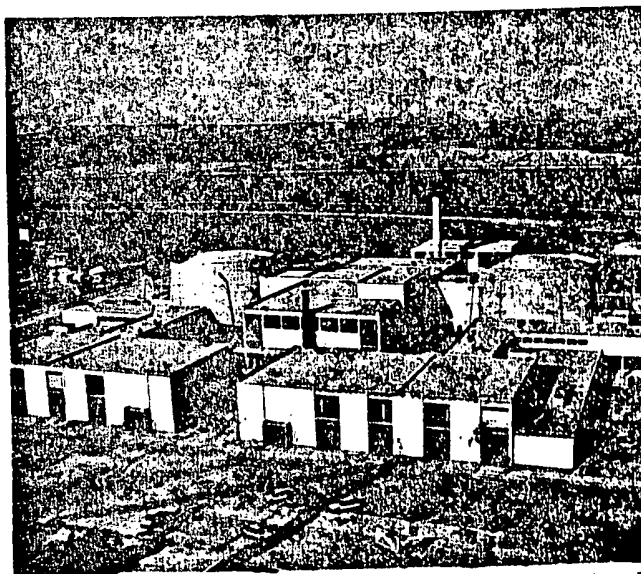

Les réacteurs d'irradiation industrielle Célestin 1 et 2. Ils fabriquent du tritium mais aussi des produits à usage médical et pharmaceutique.

FICHE TECHNIQUE

Célestin 1 et 2 : réacteurs d'irradiation industrielle.
Ils produisent du tritium et du plutonium.

Puissance : 200 MWe chacun.

Combustible : Uranium enrichi ou Plutonium.

Modérateur : Eau lourde en circuit fermé.
Débit 9 000 m³/h.

Refroidissement : Eau lourde.

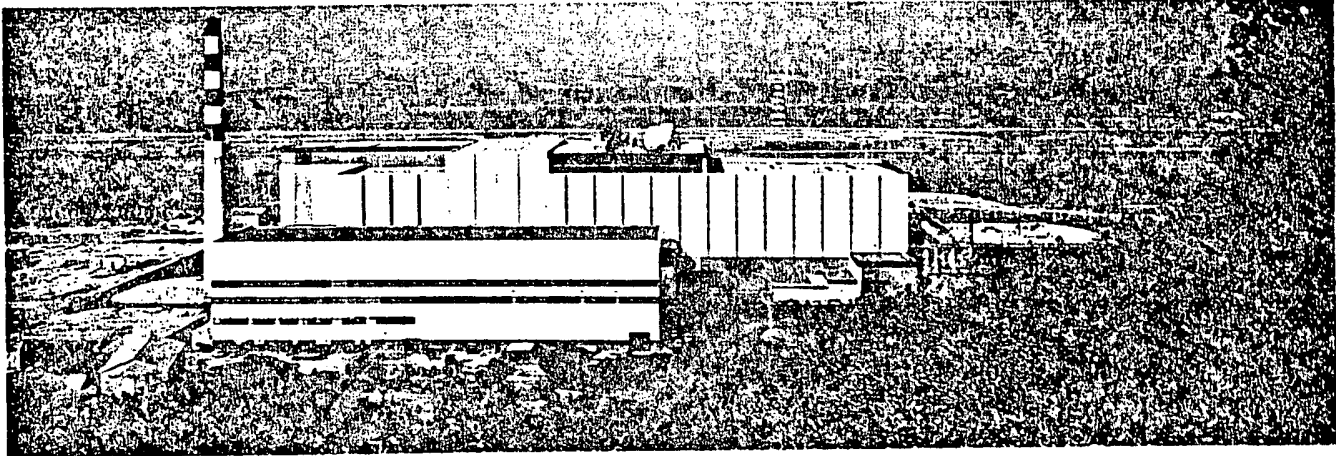

FICHE TECHNIQUE

Surgénérateur Phénix :
commencé en 1968,
mis en exploitation en 1974.

Puissance :	250 MWe.
Combustible :	Oxyde mixte d'uranium et de plutonium UO ₂ -PuO ₂ .
Modérateur :	Aucun.
Refroidissement :	Sodium liquide. Température d'entrée : 400°. Température de sortie : 560°.

LA FILIÈRE DES SURGÉNÉRATEURS

Le principe : le surgénérateur utilise comme matière fissile du plutonium 239 et comme matière fertile de l'uranium 238.

Une fois amorcée la réaction, l'uranium 238 disposé autour du cœur, se transforme en plutonium 239 par capture d'un neutron.

Son intérêt : il apporte une solution en matière d'approvisionnement énergétique.

- Il utilise deux sous-produits des réacteurs thermiques : l'uranium appauvri rejeté par les usines d'enrichissement ou par les réacteurs, et le plutonium.
- Il multiplie par 50 le rendement énergétique de l'uranium naturel qu'il est seul à consommer totalement.
- Il permet une fois la réaction amorcée de produire plus de plutonium qu'il n'en consomme.

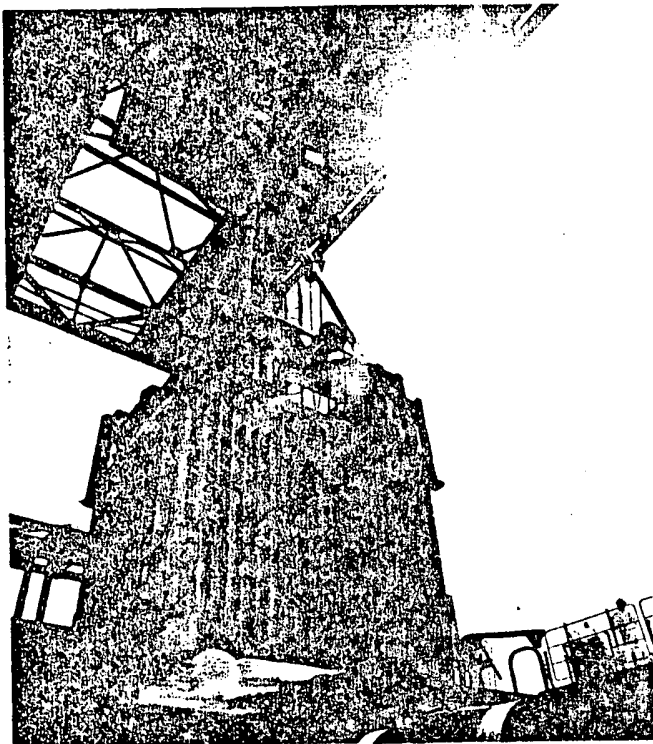

Entretien d'un convoyeur servant au transport des combustibles graphite-gaz après leur passage dans le réacteur.

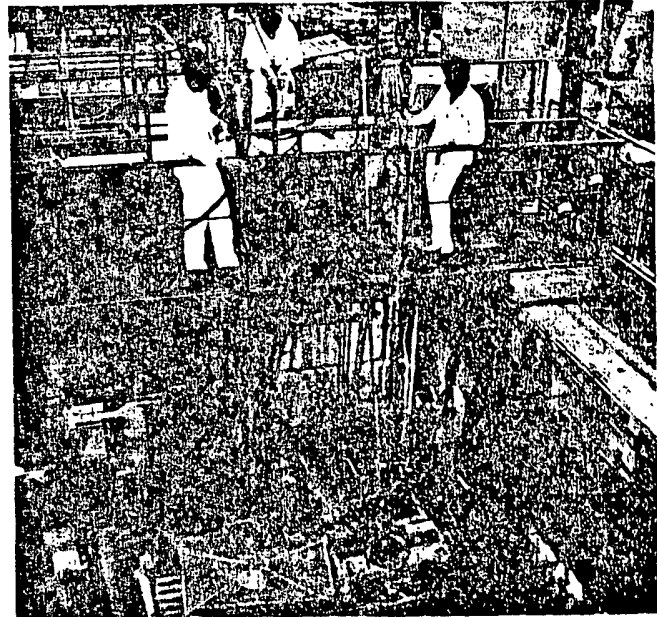

La piscine de stockage des cartouches de combustible y séjournent au moins 5 ans avant que la radioactivité décroisse.

Mais il ne peut s'agir là que d'une solution provisoire sur quelques décennies. La sûreté à très long terme du stockage (ainsi que la manutention et le transport) imposant la solidification de ces produits - qui se présentent à l'issue du retraitement sous forme de solutions acides concentrées - le verre a été choisi comme matériau final.

En effet, le verre choisi - un borosilicate - se prête particulièrement bien à l'incorporation de l'ensemble des oxydes de produits de fission, soit une quarantaine d'éléments. La vitrification présente également l'avantage d'aboutir à une réduction du volume des déchets, variable en fonction du type de combustible choisi. Ce verre enfin, du fait de son très faible taux de lixiviation - qui traduit sa très faible solubilité - est le matériau idéal pour éliminer pratiquement tout risque de contamination de l'environnement.

La capacité nominale de production de l'AVM - qui est d'environ 200 conteneurs par an - a été déterminée de façon à satisfaire les besoins réguliers de l'usine mais aussi de manière à résorber, en quelques années, le stock liquide de produits de fission accumulé en une vingtaine d'années.

Le stockage des conteneurs remplis de verre radioactifs - qui sont non contaminants, mais par contre très irradiants - s'effectue dans 220 puits de 10 m de hauteur, pouvant recevoir chacun 10 conteneurs. Ces puits sont construits dans une enveloppe bétonnée, dans une enceinte contiguë à l'AVM. La capacité totale du hall de stockage est de 330 m³ de verre. Elle couvre les besoins de l'exploitation de 11 tranches de réacteurs PWR de 1000 MWe pendant 10 ans.

Depuis son démarrage en 1978 jusqu'en mai 1981, l'AVM a vitrifié 380 m³ de solution concentrée de produits de fission représentant l'équivalent de 7 300 tonnes de combustible. Au total 172 tonnes de verre actif, conditionnées dans 506 conteneurs ont été produites.

LES CENTRALES GRAPHITE-GAZ

UP1: usine de retraitement des combustibles irradiés en provenance des centrales graphite-gaz.

St-Laurent-des-Eaux I: 480 MWe.
St-Laurent-des-Eaux II: 515 MWe.

Chinon II: 200 MWe.
Chinon III: 480 MWe.

Bugey I: 540 MWe.

Marcoule G3: 38 MWe.

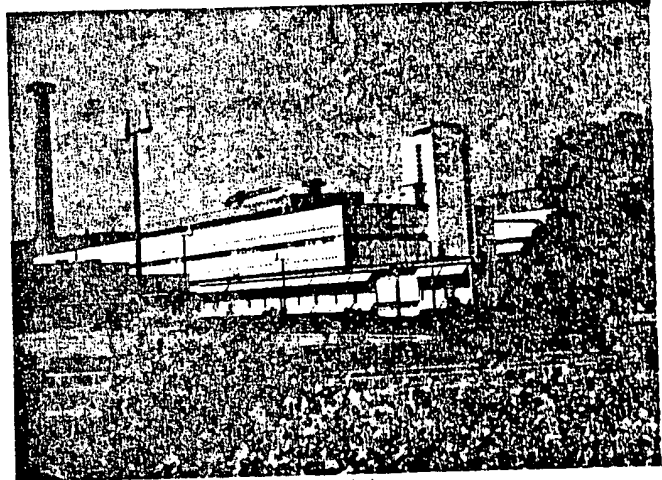

Le nouveau bâtiment de l'usine de retraitement des combustibles irradiés de l'AVM, en construction, devant les bâtiments existants de l'usine de retraitement des combustibles irradiés de l'AVM.



Le hall de stockage des déchets radioactifs de l'AVM, en construction, devant les bâtiments existants de l'usine de retraitement des combustibles irradiés de l'AVM.

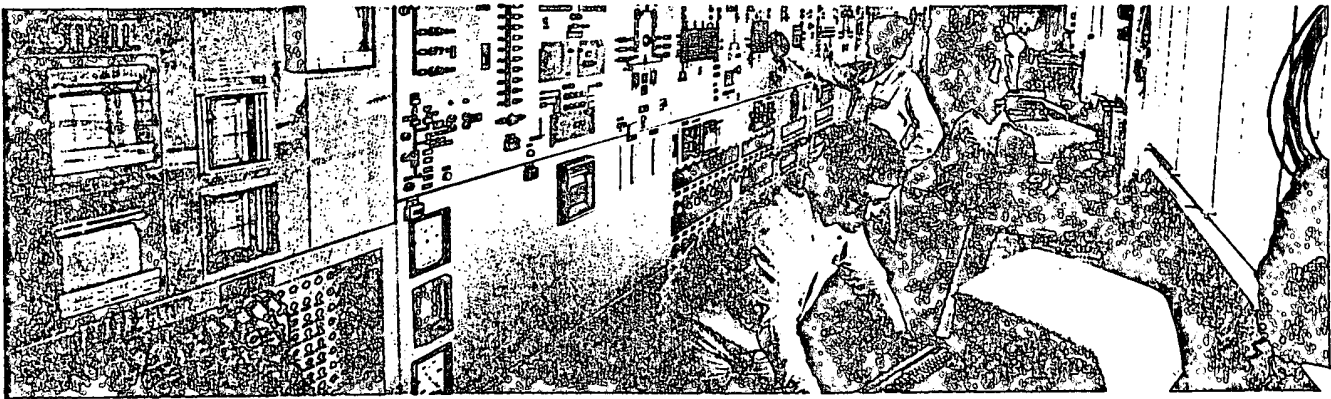

Vue d'ensemble d'un bureau de commande et de maintenance.

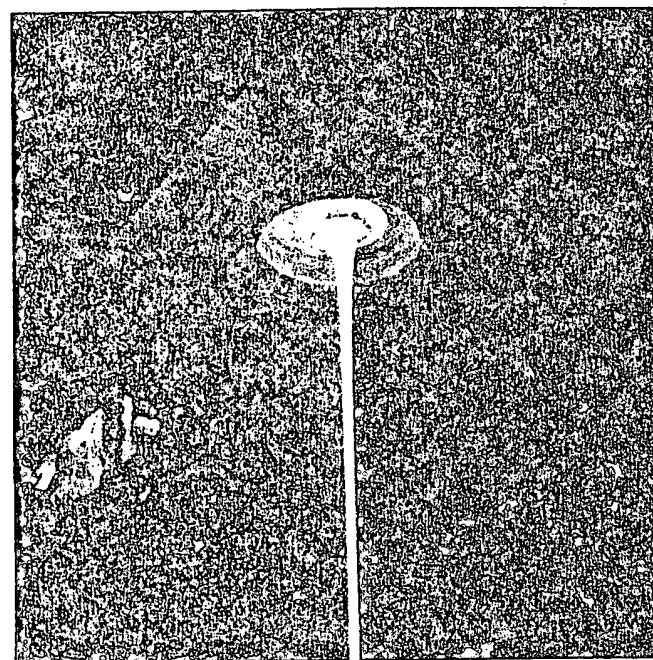
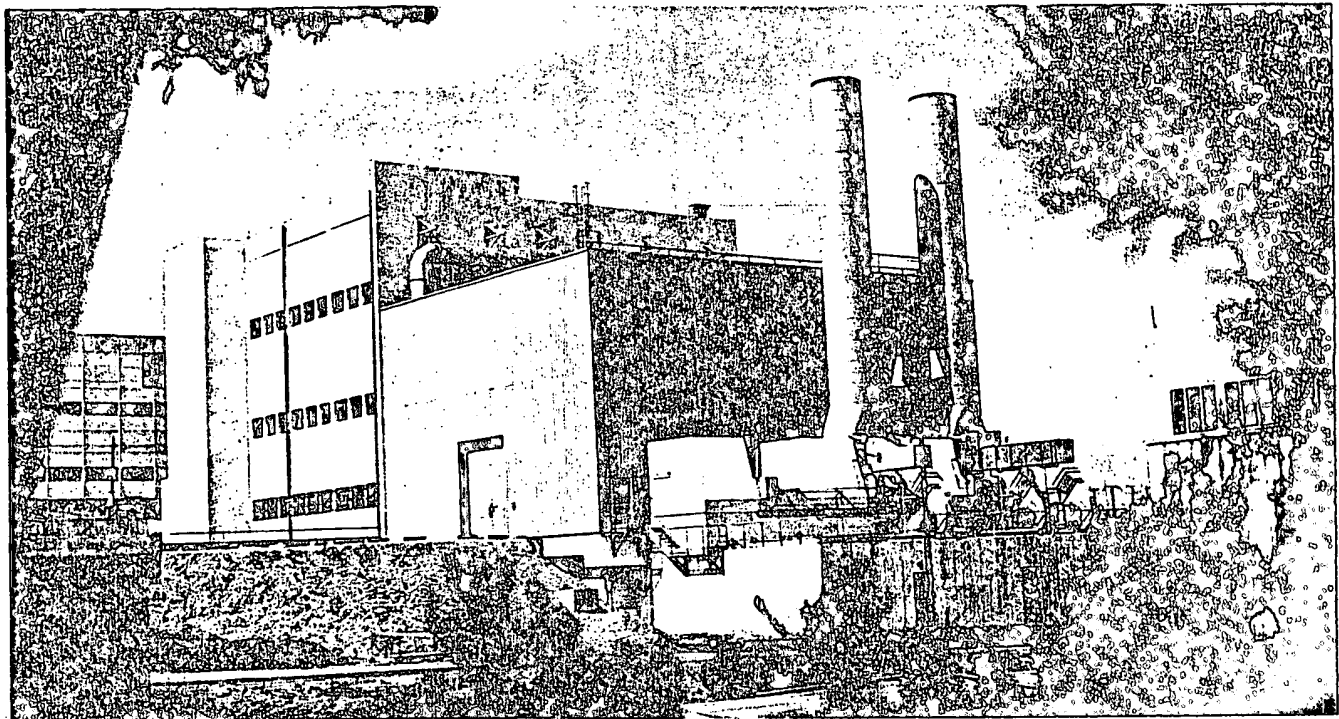

FICHE TECHNIQUE

AVM : atelier de vitrification des produits de fission.

Capacité de vitrification : 200 containers/an.

Capacité de stockage : 380 m³ de verre dans 220 puits de 10 mètres de hauteur.

De 1978 à Mai 1981 : 172 tonnes de verre actif ont été produites.

La position prédominante de la France, grâce à la démonstration apportée par le bon fonctionnement industriel de l'AVM, est à l'origine de retombées commerciales importantes. A ce jour des contrats mettant en œuvre le procédé de vitrification continue ont été signés avec l'Allemagne, la Belgique et la Grande-Bretagne.

L'ensemble retraitement de Marcoule est complété par les laboratoires dont la mission essentielle est de contrôler la production de l'usine et par la section du génie chimique industriel, créée pour assister les services de production dans l'étude et la mise au point de procédés et de techniques nouvelles.

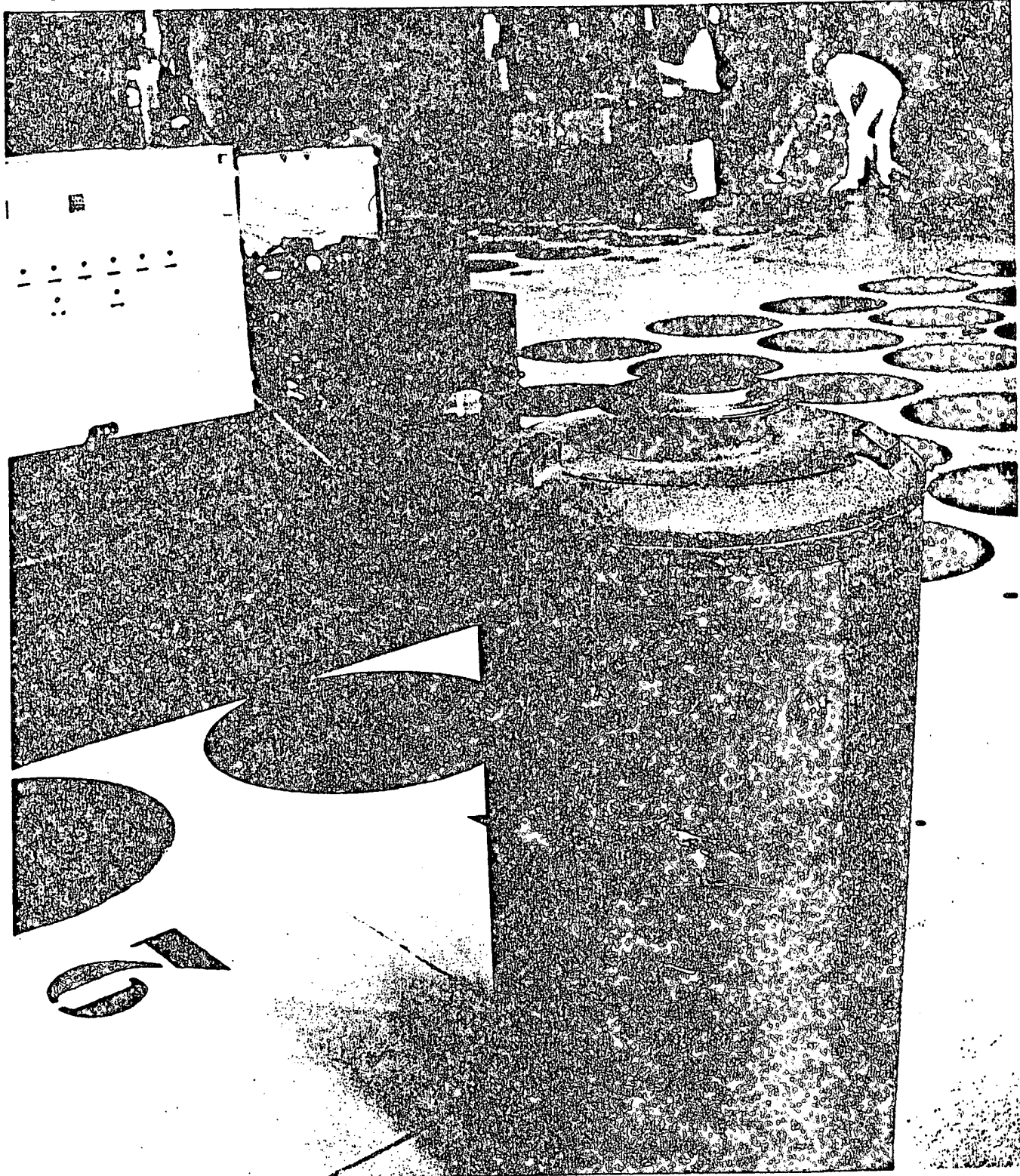

Dans ce hall de stockage sont entreposés les contenants renfermant les produits de la fusion vitrifiée.
(A l'arrière-plan, l'opérateur).

Pour fonctionner les installations doivent disposer de supports de types différents.

Les supports nucléaires spécifiques.

La station de traitement des effluents liquides (STEL) : elle traite les eaux résiduaires produites au cours du retraitement. Elle dispose de citernes et de bassins pour stocker les effluents, d'une centrale de pompage, d'un ensemble de réacteurs-décanteurs, d'une station d'enrobage et de casemates de stockage provisoire. Un projet de rénovation complète de cette station est en cours d'élaboration.

Les ateliers de décontamination du matériel (ADM) : ils sont chargés de traiter les matériels contaminés pour permettre leur réutilisation. Ainsi, la cellule polyvalente de l'ADM lourd, qui vient d'être refaite, peut accueillir des matériels d'un poids de 60 tonnes, tels que les châteaux de transport d'EDF.

L'atelier de conditionnement des déchets solides (CDS) : il reçoit, pour sa part, les appareils ou matériaux à éliminer. Ils sont démontés, tronçonnés et compactés dans des fûts avec enrobage de béton. Le CDS va faire l'objet d'une rénovation actuellement en cours d'étude.

Le service de protection contre les radiations (SPR) : il est chargé de la protection du personnel, de l'application des normes de sécurité et du contrôle de la radioactivité des installations.

Il dispose à cet effet de laboratoires d'analyses, de réseaux de détection fixes et d'appareils portatifs individuels ou de zone.

Grâce à l'ensemble des moyens de prévention mis en place et à la rigueur observée dans leur travail par les agents, les doses individuelles absorbées sont limitées et restent strictement inférieures aux normes fixées par la réglementation. Leur valeur moyenne est de 300mRem ou 3 millisievert, (mSv), soit 1/16^e de la dose maximale admissible pour les travailleurs directement affectés aux travaux sous rayonnements.

Il convient de rappeler qu'en France la dose moyenne annuelle provenant de la radioactivité naturelle est de 125 mRem ou 1,25 mSv.

Les supports techniques.

Les supports techniques sont constitués par tous les ateliers, bureaux et magasins divers qui concourent au fonctionnement des installations. Il s'agit pour l'essentiel :

- du bureau d'études au sein des services techniques, qui a pour mission la réalisation ou le suivi des études de génie civil ou mécanique.
- du poste électrique qui assure l'alimentation en énergie et en fluides (1700 m³/h d'eau en débit moyen).
- des ateliers de chaudronnerie, d'électronique, de mécanique, etc.
- du magasin général qui assure avec ses annexes l'approvisionnement en pièces de rechange, fournitures et produits chimiques.

Les supports généraux.

Les moyens informatiques et bureautiques sont utilisés pour gérer le combustible, le procédé, les magasins de pièces de rechange, ils sont aussi utilisés pour la gestion du personnel. Au total

20 ordinateurs, 17 micro-ordinateurs et un terminal lourd de calculs scientifiques, relié au réseau CISI (Cadarache, Saclay) sont utilisés.

Le service médical du travail est chargé de la surveillance systématique du personnel.

Il dispose d'un complexe comportant un bâtiment principal et un bloc de décontamination. En cours de réalisation, un nouveau bâtiment permettra de prendre en compte l'accroissement d'activité du service, de garantir l'unicité de la qualité de la médecine (entreprises et groupe CEA), et de mettre en œuvre les nouvelles techniques en ce domaine.

Le laboratoire d'analyses médicales, doté de l'instrumentation la plus moderne, procède aux diverses analyses liées à la surveillance médicale des agents.

Les effluents résiduaires sont traités dans la Station de Traitement des Effluents Liquides (STEL).

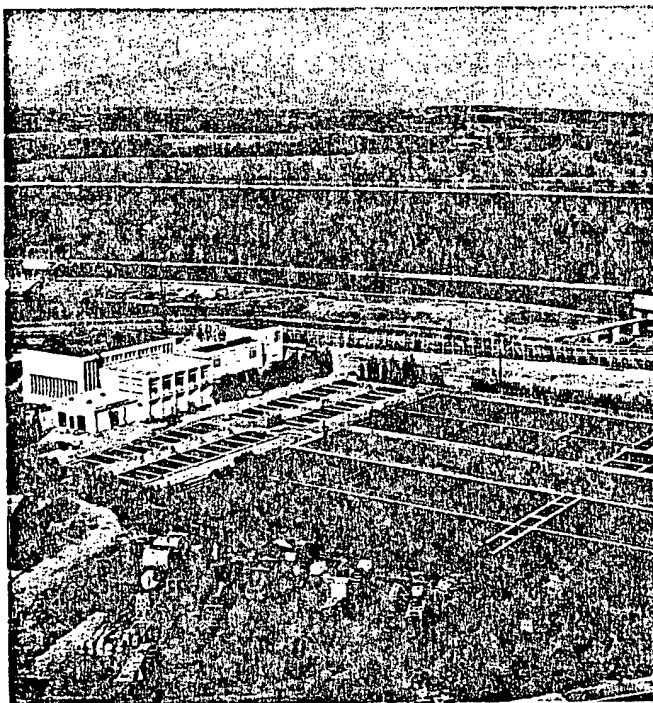

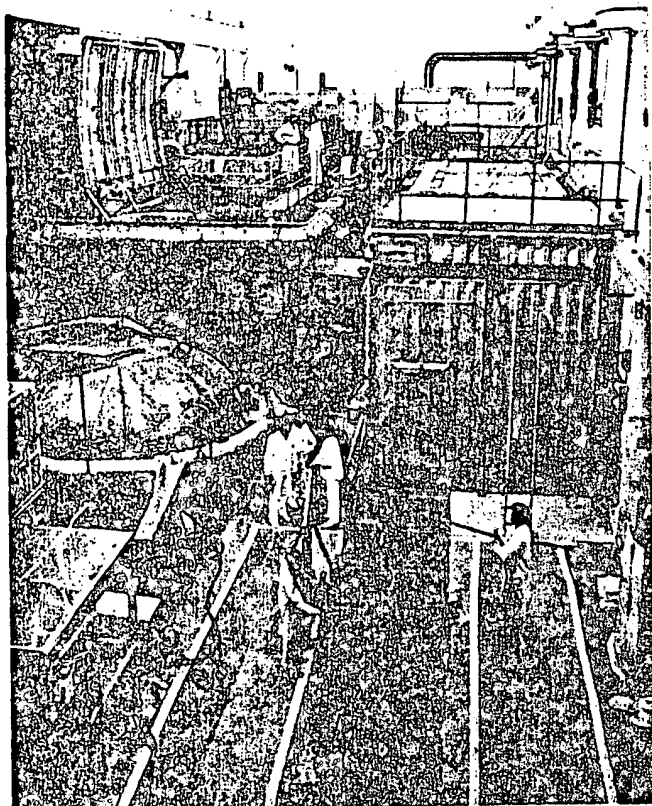

Vue générale du hall de l'Atelier de Décontamination d'Alger (ADDA).

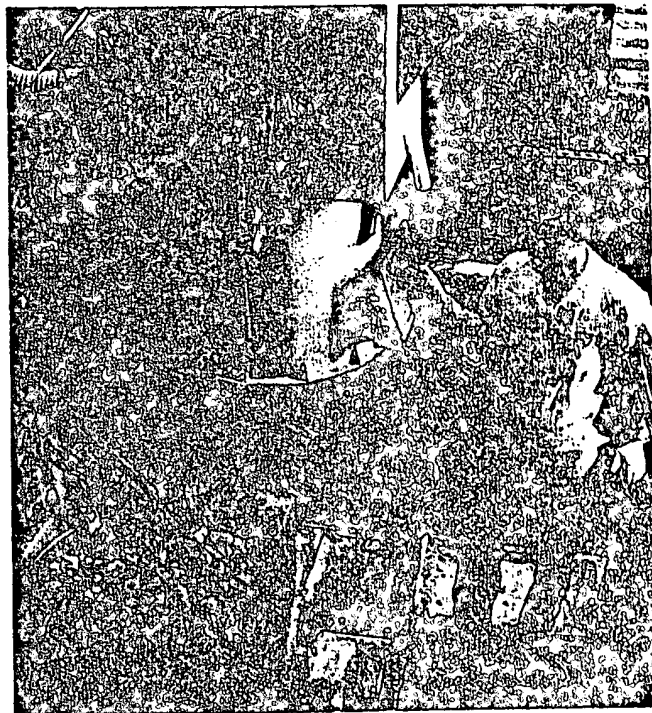

Conditionnement des Déchets Solides (CDS) à gravillonnage des fûts compactés.



L'agent chargé du centre est chargé de la surveillance systématique du personnel. Ici contrôle d'un agent.

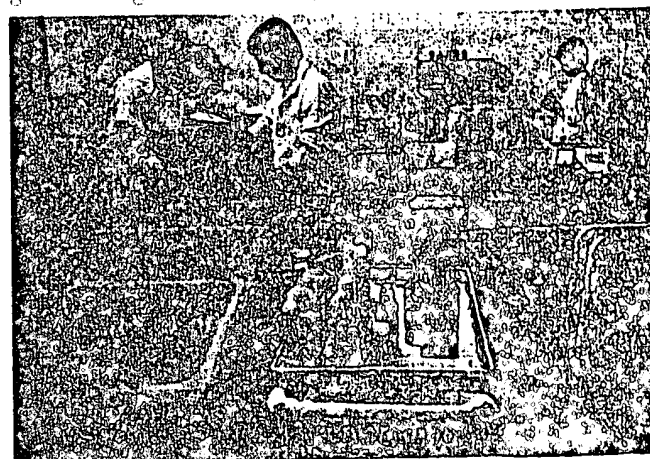

Le personnel du centre est chargé de la surveillance systématique du personnel. Ici contrôle d'un agent.

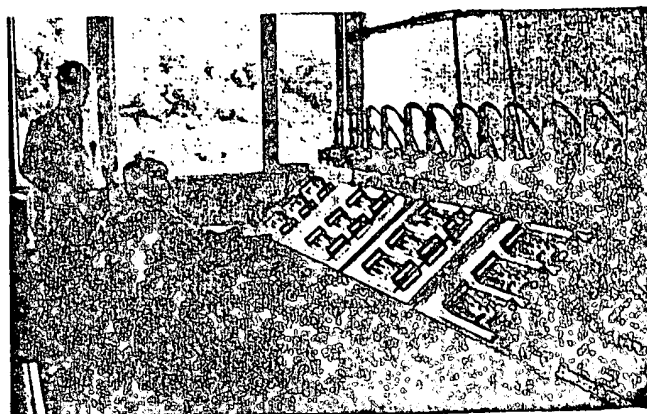

Passeurs automatiques d'échantillons.

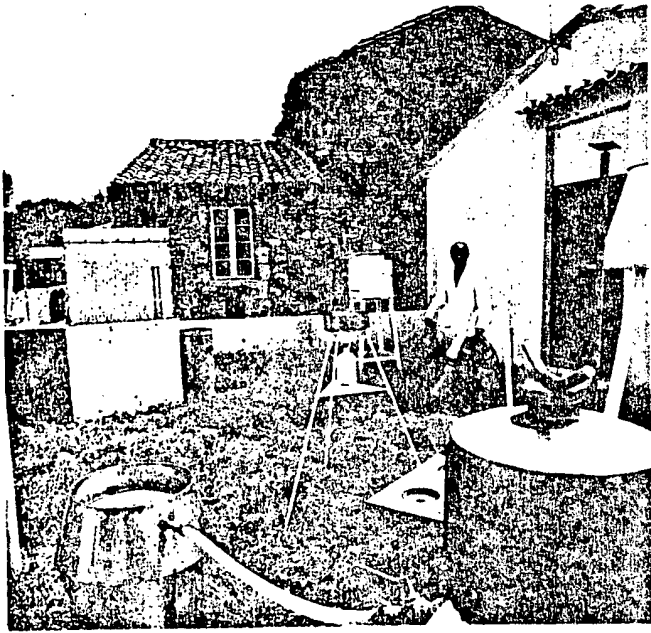

Analisis us ed am l'ins...
m... les combite are a...

Biologiques classique...
vans le...
... ..



Le laboratoire de chimie.

D'importants moyens militaires.

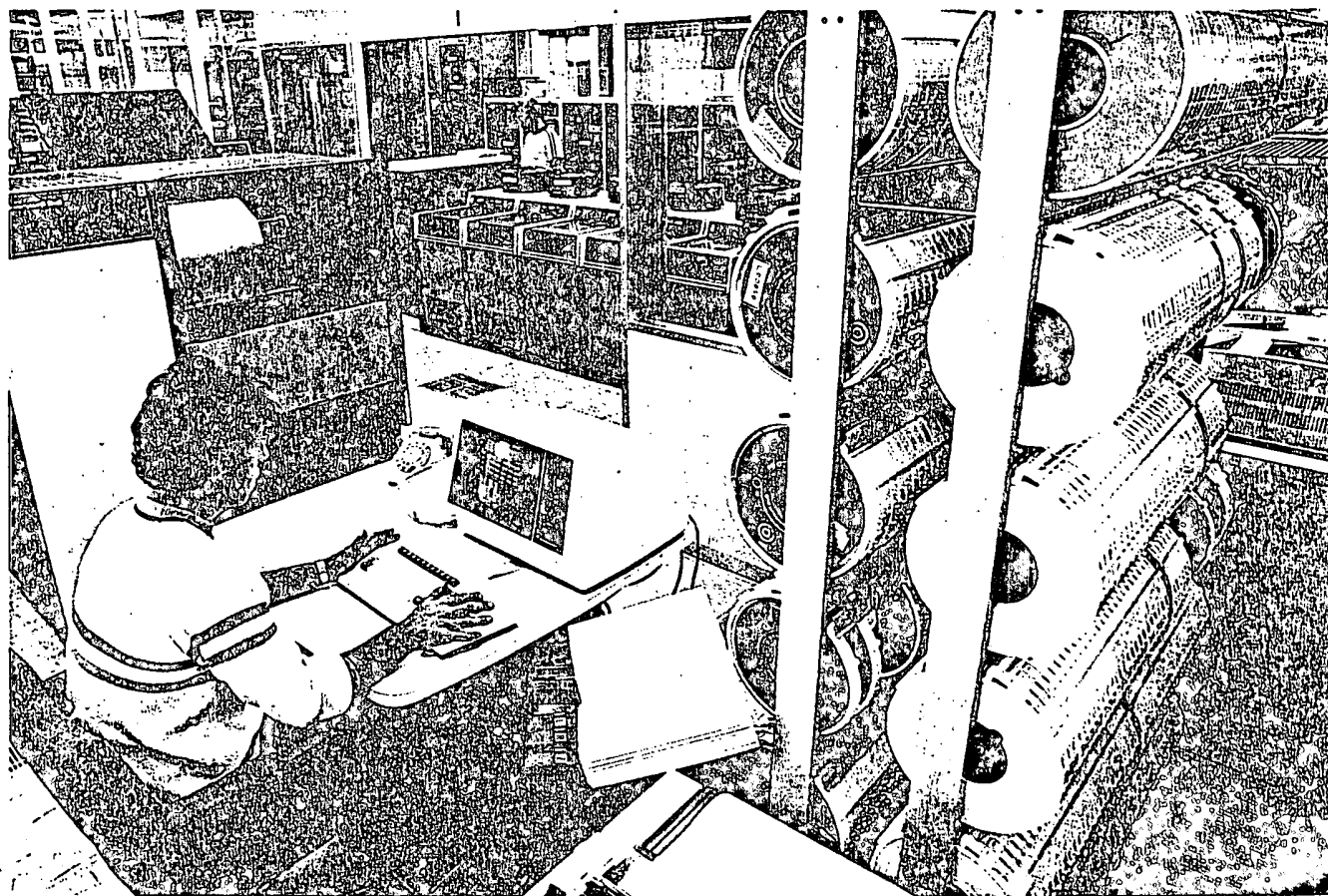

Un environnement respecté.

Respecter l'environnement: tel a toujours été le mot d'ordre primordial pour les responsables de Marcoule. Dans ce domaine ils ont toujours eu une position d'avant-garde ainsi qu'en témoigne la réalisation d'installations qui constituaient en France autant de « premières » techniques: atelier de récupération des acides, atelier de bitumage des boues, atelier de vitrification des produits de fission.

Un établissement comme Marcoule, aux installations nucléaires très diversifiées, est amené à rejeter dans l'environnement des effluents gazeux et liquides. Bien entendu, des règles strictes permettent de limiter quantitativement la production et le rejet de tels effluents.

C'est pour s'assurer que leur impact est quasiment nul et ne modifie en rien l'équilibre naturel de la région que sont effectués de façon permanente des prélèvements d'échantillons dans un rayon d'une dizaine de kilomètres et à l'intérieur même de l'établissement. Le service de protection contre les radiations (SPR) exerce cette mission de surveillance sous le contrôle du service central de protection contre les rayonnements ionisants (SCPRI). Cet organisme qui relève du Ministère de la Santé est chargé de la surveillance et de la protection des travailleurs et de la population. Les effluents gazeux sont d'abord analysés à la source, c'est-à-dire dans les cheminées qui les émettent. Ensuite sont opérées des mesures de la radioactivité des poussières et des gaz

contenus dans l'air qui est contrôlé par neuf stations, dont quatre installées sur le site.

Les effluents liquides sont analysés avant rejet. Deux stations automatiques surveillent en permanence les eaux du Rhône en amont et en aval de l'établissement. Des prélèvements volants de sédiments, de poissons, de végétaux sont opérés jusqu'au delta et des prélèvements d'échantillons de la nappe phréatique sont effectués à partir de 144 puits situés dans l'enceinte du site et de 12 puits situés à l'extérieur.

Le SCPRI, de son côté, procède à des contrôles réguliers sur les eaux du Rhône.

La densité de ces contrôles et l'attention dont ils font l'objet sont un gage de sécurité confirmé par un environnement intact après vingt cinq ans d'activité sur le site.

Une région mise en valeur.

Le bon voisinage consiste, bien sûr, à ne pas gêner ses voisins, mais aussi à participer à leur vie en partageant leurs joies et en les aidant dans les moments difficiles. Marcoule a su trouver avec son environnement humain ce difficile équilibre qui fait

qu'il est très présent sans être trop pesant. Cette réussite, bien sûr, s'observe surtout dans la vie de tous les jours, même s'il faut faire le détour par quelques chiffres pour en donner une idée.

Ainsi doit-on savoir que 60% des agents Cogéma habitent dans le canton de Bagnols-sur-Cèze et que leur installation a donné un essor significatif à la vie de bien des communes locales.

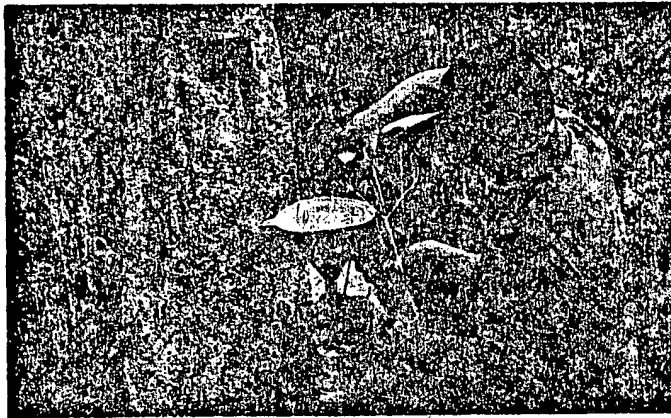

Un agent du Service de Protection contre les Radiations (SPR) prélève de l'eau dans la nappe phréatique et des végétaux autour de l'usine.



Les associations culturelles et sportives de Marcoule proposent de très nombreuses activités et sont largement ouvertes à la population locale puisque 40% de leurs 4 500 adhérents sont extérieurs à l'établissement. Celui-ci entretient également des rapports suivis avec l'enseignement et l'université (700 visites et 50 stages annuels, versement d'une taxe d'apprentissage de 400 000 francs, conférences dans les établissements, participation à l'association université-industrie) et les organismes socio-professionnels (Chambre de commerce et d'industrie de Nîmes, Comité d'expansion économique et de productivité du Gard).

Les relations sont excellentes également

avec le milieu de la viticulture. Ce vignoble réputé, d'appellation « Côtes du Rhône » (vins de Chusclan, Orsan, Tresques) est le plus ancien de France. Avec 890 exploitations et 6920 hectares plantés en vigne, le canton de Bagnols-sur-Cèze se situe au deuxième rang dans l'inventaire départemental, après celui de Vauvert. Tant au plan de la qualité qu'au plan des superficies de production, le voisinage de Marcoule n'a jamais porté préjudice à ce vignoble renommé.

Au total, le flux financier moyen induit par l'activité économique de Marcoule est de l'ordre de 350 millions de francs par an (conditions économiques 1980) dont la quasi totalité bénéficie au voisinage immédiat.

MARCOULE DEMAIN.

Marcoule croit en l'avenir parce qu'il a su se forger son propre avenir. Artisan de la première heure de la grande percée du nucléaire français, l'établissement aurait pu doucement s'assoupir dans sa gloire. En 1976, avec l'entrée en scène de la Cogéma, il a choisi de se réveiller, de se replacer dans le courant de la vie.

Cet effort qui fut fait lui assure déjà d'aller jusqu'à la fin du siècle. Si l'activité de retraitement est encore pour moitié civile et pour moitié militaire, les travaux d'augmentation de la capacité de l'usine vont lui permettre de prendre le relais de La Hague pour traiter l'ensemble des combustibles des réacteurs EDF de la filière UNGG, jusqu'à son extinction à l'horizon 1995.

De cette volonté de vie de Marcoule, témoignent encore toutes les installations en construction ou en projet :

- MAR 400 (stockage et dégainage des combustibles).
- Nouvel atelier oxalate continu (fin du procédé de retraitement).
- Nouvelle station de traitement des effluents liquides.
- Nouveau réseau d'eau et d'alimentation électrique.
- Rénovation des laboratoires assurant le contrôle en ligne de l'usine de retraitement.

Porteuse d'avenir est aussi l'installation à Marcoule de l'ensemble TOR (traitement des combustibles oxydes des réacteurs à neutrons rapides).

En prenant en charge le retraitement des combustibles de cette nouvelle génération de réacteurs de type Super-Phénix, Marcoule ouvre son horizon bien au-delà de l'an 2000.

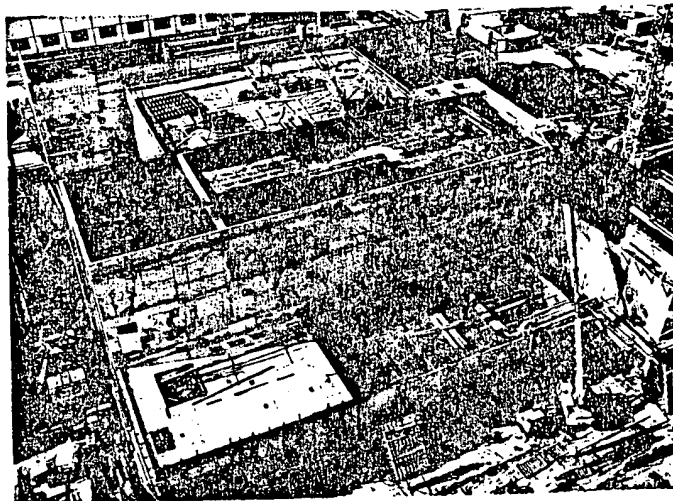

MAR 400 en cours de construction.

APPENDIX 10

COMMISSION OF THE EUROPEAN COMMUNITIES:
Discharge Data

COMMISSION OF THE EUROPEAN COMMUNITIES



**Radioactive effluents
from
nuclear power stations
and
nuclear fuel reprocessing plants
in the European Community**

**DISCHARGE DATA
1972-1976
RADIOLOGICAL ASPECTS**

prepared by F. LUYKX and G. FRASER

APRIL 1978



DIRECTORATE-GENERAL EMPLOYMENT AND SOCIAL AFFAIRS
Health and Safety Directorate

S U M M A R Y

The report presents the available data on radioactive gaseous and liquid effluents discharged by nuclear power stations and nuclear fuel reprocessing plants in the European Community from 1972 to 1976. Discharges are expressed both in absolute terms and relative to the net production of electricity from the fuel.

On the basis of the discharges recorded for 1976 the resulting maximum exposure of members of the population is quantified and compared with the dose limits prescribed by Euratom radiological protection standards and with the exposure resulting from natural radioactivity.

It is concluded that there is no case in which a discharge could have given rise to an exposure exceeding the relevant prescribed limit. Not only did the possible maximum exposures incurred by individuals leave an appreciable safety margin relative to that limit but, for the vast majority of installations, they were comparable with or were considerably lower than the geographical and temporal variations in exposures resulting from natural radioactivity.

Where environmental levels have been detectable the measured results have of course been used but, with few exceptions, the levels have remained less than the very low limits of detection currently possible. In general, where theoretical models are used to evaluate exposure, they are designed to give conservative results and hence it is likely that the true exposures are even less than those calculated.

Address for correspondence :

Commission of the European Communities
Directorate-General Employment and Social Affairs
Health and Safety Directorate - DG V F/2
Bâtiment Jean Monnet
Plateau du Kirchberg

LUXEMBOURG

ANNUAL DISCHARGE OF KRYPTON-85 FROM NFRPs

Facility	Discharge Limit (Ci/year)	Activity released (Ci/year)				
		1972	1973	1974	1975	1976
Eurochemic	6.3×10^6 (a)	2.0×10^5	2.2×10^5	1.0×10^5	-	-
WAK	3.5×10^5 (bc)	6.8×10^4	2.5×10^4	$< 8.5 \times 10^2$	4.3×10^4	8.6×10^4
La Hague		2.4×10^5	2.3×10^5	7.2×10^5	6.6×10^5	3.5×10^5
Marcoule		4.7×10^4	1.3×10^5	1.1×10^5	1.0×10^5	9.2×10^4
Eurex	4.5×10^4	-	4.7×10^3	4.3×10^3	-	-
Dounreay	(d)					
Windscale	(d)	1.2×10^6	8×10^5	8×10^5	1.2×10^6	1.2×10^6

(a) The annual limit quoted is derived from a maximum authorized discharge rate of 0.2 Ci/sec.

(b) All limits are reviewed annually as part of Karlsruhe site effluent coordination plan.

(c) 2.5×10^5 Ci in 1974 and 1975.

(d) Authorizations for British NFRPs place no limits on the quantities but require that the best practicable means be used to minimize the amount of radioactive material discharges.

16. "Nuclear Power and the Environment; the Government's Response to the 6th Report of the Royal Commission on Environmental Pollution", Cmnd 6820, HMSO, London (1977)
17. HUBER O. and EICKELPASCH N., "Studie über die Strahlenexposition in der Umgebung des Kernkraftwerkes Gundremmingen durch die betrieblichen Abgaben radioaktiver Stoffe in der Abluft", STH-3/75, Bundesgesundheitsamt, Neuherberg (1975)
18. SCHWIBACH J. et al., "Methods and results of radioactivities released from nuclear power plants", STH-5/77, Bundesgesundheitsamt, Neuherberg (1977)
19. WINKELMANN I. et al., "Bericht über die in Filterproben aus der Abluft-Überwachungsanlage von Kernkraftwerken in der Bundesrepublik Deutschland im Jahre 1976 nachgemessenen Einzelnuclide", STH-4/77, Bundesgesundheitsamt, Neuherberg (1977)
20. RIEDEL H. and GESEWSKY P., "Zweiter Bericht über Messungen zur Emission von Kohlenstoff-14 mit der Abluft aus Kernkraftwerken mit Leichtwasserreaktor in der Bundesrepublik Deutschland", STH-13/77, Bundesgesundheitsamt, Neuherberg (1977)
21. Data provided by the Comité technique interministériel pour l'EURATOM
22. ESTOURNEL R. et al., "Expérience pratique de la surveillance des rejets gazeux dans les usines de retraitement françaises", p. 155, Doc. V/2266/78 *, CEC Luxembourg (1978)
23. CLARKE R.H., personal communication (1978)
24. KELLY G.N. et al., "The predicted radiation exposure of the European Community resulting from discharges of krypton-85, tritium, carbon-14 and iodine-129 from the nuclear power industry to the year 2000", Doc. V/2676/75, CEC, Luxembourg (1975)
25. FRIGERIO N.A. and STOWE R.S., "Plutonium and uranium emission experience in U.S. nuclear facilities using HEPA filtration", p. 457, Proc. of Seminar on High Efficiency Aerosol Filtration, Aix-en-Provence 1976; Doc. V/835/77, CEC, Luxembourg (1977)
26. HOWELLS H., "Windscale and Calder Works - radioactive waste disposals and associated environmental monitoring data, 1976", HP/ER/76, British Nuclear Fuels Limited (1977)
27. LARKIN M.J., "Liquid and airborne effluents from Windscale nuclear fuel reprocessing plant", p. 29, Doc. V/2266/78 *, CEC Luxembourg (1978)
28. HERRMAN R., personal communication (1978)
29. BERG R. and SCHUETTELKOPF H., "Die Messung der Verteilung in und der Abgabe von I-129 aus der Wiederaufarbeitungsanlage Karlsruhe", p. 81, Doc. V/2266/78 *, CEC Luxembourg (1978)
30. SCHUETTELKOPF H. and HERRMANN G., "¹⁴CO₂-Emissionen aus der Wiederaufarbeitungsanlage Karlsruhe", p. 189, Doc. V/2266/78 *, CEC Luxembourg (1978)

COMMISSION OF THE EUROPEAN COMMUNITIES

7 SEP 1984

**Radioactive effluents
from nuclear power stations
and nuclear fuel reprocessing plants
in the European Community**

**DISCHARGE DATA
1976 □ 1980
RADIOLOGICAL ASPECTS**

F. LUYKX and G. FRASER

MARCH 1983

document no.

DIRECTORATE-GENERAL EMPLOYMENT, SOCIAL AFFAIRS AND EDUCATION
Health and Safety Directorate

TABLE XIII

ANNUAL DISCHARGE OF KRYPTON-85 FROM NFRPs

Facility	Discharge Limit (Ci/year)	Activity Released (Ci/year)				
		1976	1977	1978	1979	1980
WAK	2.5×10^5 (a)	8.57×10^4	1.15×10^5	3.36×10^4	5.06×10^4	3.24×10^4
La Hague	1.3×10^7	3.5×10^5	6.71×10^5	7.86×10^5	6.43×10^5	8.25×10^5
Marcoule	1.6×10^6	9.2×10^4	1.17×10^5	3.08×10^5	2.80×10^5	5.35×10^5
Downreay	(b,c)	-	-	-	-	3×10^3
Sellafield	(b)	1.2×10^6	8×10^5	7×10^5	9.4×10^5	8.4×10^5

(a) Management allocation within the overall site provisions; the WAK allocation for krypton-85 was 3.5×10^5 Ci prior to 1980

(b) There is no quantified limit; the authorization requires that the best practicable means be used to minimize the discharge of radioactive substances

(c) Noble gas discharges are not monitored. Prior to 1980 reprocessing was confined to Downreay Fast Reactor (DFR) and HTR fuel. It was assumed for DFR fuel that all noble gases escaped into the reactor coolant and were then released from the reactor; in consequence discharges from reprocessing are assumed to be "nil". HTR fuel contains little krypton-85.

Fuel from the Prototype Fast Reactor (PFR) was first processed in 1980 and it is assumed that all krypton-85 generated in the fuel is released on reprocessing. Thus the 1980 discharge value corresponds to the calculated krypton-85 inventory.

TABLE XVI

ANNUAL DISCHARGE OF TRITIUM TO ATMOSPHERE FROM NFRPs

Facility	Discharge Limit (Ci/year)	Activity discharged (Ci/year)				
		1976	1977	1978	1979	1980
WAK	1×10^3 (a)	102 (c)	190	125	167	80
La Hague	6×10^4 (d)	49	304	112	193	246
Marcoule	2.7×10^5 (e)	120	75	1 712	1 912	2 172
Dounreay	(b)					
Sellafield	(b)	1.2×10^4	8×10^3	6×10^3	7.8×10^3	6.8×10^3

(a) See foot-note (a) to Table XIII.

(b) See foot-note (b) to Table XIII.

(c) Calculated result based on later experimental work.

(d) Limit introduced 22.10.80

(e) Limit introduced 20.05.81