

KUSKOVA, N.K.

Effect of the composition of natural waters on the composition
of absorbed bases of rocks. Trudy Inst. geol. i razrab. gor.
iskop. 1:308-313 '60. (MIRA 14:1)
(Rocks, Sedimentary) (Water, Underground)

IL'YEV, F.I.; KUSKOVA, N.K.; PAKHOLOVA, K...

[Methods of chemical analysis of mineral raw materials]
Metody khimicheskogo analiza mineral'nogo syr'ya. Moskva, Nedra. No.8. 1965. 287 p. O487.18.01

VASIL'YEV, P.I.; KUSKOVA, N.K.; PAKHOMOVA, K.G.

[Methods for the chemical analysis of minerals] Metody
khimicheskogo analiza mineral'nykh syr'ya. Moskva,
Nedra, No.9. 1965. 66 p. (MIRA 18:7)

1. Moscow. Vsesoyuznyy nauchno-issledovatel'skiy institut
mineral'nykh syr'ya.

S/115/63/000/003/005/010
E194/E455

AUTHORS: Yefremova, R.I., Kuskova, N.V., Levina, L.N.,
Matizen, E.V.

TITLE: Temperature measurements with copper-constantan
thermocouples

PERIODICAL: Izmeritel'naya tekhnika, no.3, 1963, 25-28

TEXT: Although they are less accurate than platinum resistance thermometers, copper-constantan thermocouples are often used in laboratories. A convenient standard calibration table for these thermocouples is not possible because the properties of constantan wire depend on both its origin and its diameter. Seven grades of constantan wire made into couples with copper gave at 100°C differences in thermal emf's of up to 300 to 400 μV, which is equivalent to about 10°. Several coils of constantan of various grades were selected and calibrated so that individual couples made up from these coils should not require calibration. The thermocouples were calibrated at reference points of boiling oxygen, sublimation of CO₂, melting of ice, and boiling of water, naphthalene and sulphur. The boiling points of hydrogen and
Card 1/2

Temperature measurements ...

S/115/63/000/003/005/010
E194/E455

nitrogen were also used. Platinum resistance thermometers were used to check the reference points. Several copper-constantan thermocouples were made up from constantan from each of the various coils and from mean values of thermal emf's at the reference points tables were drawn up of thermal emf as a function of temperature at intervals of $100 \mu V$ and in the temperature range from -260 to $-188^\circ C$ at 5 and $10 \mu V$ intervals. For many purposes this suffices as a calibration of the constantan. Errors in measuring the temperature with these thermocouples without further calibration are tabulated and the mean error between -250 and $+400^\circ C$ does not exceed 0.5% of the value of the temperature measured in $^\circ C$. At low temperatures this error may be considerable. The properties of one batch of constantan varied considerably over its length. To measure with a better accuracy the couples must be calibrated individually; this is particularly important for temperatures below $-180^\circ C$. The importance and origin of stray emf's is discussed. The influence of plastic tensile strain and twisting on the thermal emf's of couples is discussed; it is shown that annealing of the constantan wire by passage of current can have considerable influence on the thermal emf. There are 6 figures and
Card 2/2 1 table.

CHEN, W.; KUSKOVA, T.A.

Use of difference method in calculating rate of flow of
a viscous incompressible liquid. *Siber. mat. VI. 1977* 2:100-107
1978. (USSR 1978)

KUSKOVA, V. F.

"Characteristics of the Streptococci of the Oral Cavity." Sub 18 Dec 51,
Central Inst for the Advanced Training of Physicians.

Dissertations presented for science and engineering degrees in Moscow
during 1951.

SO: Sum. No. 480, 9 May 55.

KUSKOVA, V.F.

Pathogenic properties of streptococci of the oral cavity.
Stomatologiya no.1:24-27 Ja-F '54. (MLRA 7:1)

1. Iz kafedry mikrobiologii (zaveduyushchiy - professor P.F. Belikov) Moskovskogo meditsinskogo stomatologicheskogo instituta (direktor - dotsent G.N.Beletskiy).
(Streptococcus) (Mouth--Bacteriology)

KUSKOVA, V.F.

Investigating the most effective surgical scrub techniques used in dental polyclinics. 1. Bacteriological evaluation of surgical scrub techniques used in polyclinics. Stomatologiya no.5:35-37 S-0 '55. (MLRA 9:2)

1. Iz kafedry mikrobiologii (sav. prof. P.F. Belikov) Moskovskogo meditsinskogo stomatologicheskogo instituta (dir. dots. G.N. Beletskiy)
(ANTISEPSIS AND ASEPSIS
surg. scrub in dent.)
(DENTISTRY, OPERATIVE
surg. scrub in)

KUSKOVA, V.F.

Role of the cerebral cortex in immunogenesis. Biul. eksp. biol. i
med. 40 no.12:40-42 D '55 (MLRA 9:3)

1. Iz kafedry mikrobiologii (zav.-prof. P.F. Belikov) Moskovskogo
meditsinskogo stomatologicheskogo instituta (dir.-doktment G.N.
Beletskiy)

(AGGLUTINATION,
eff. of conditioned reflex reactions & sleep)

(REFLEX, CONDITIONED,
conditioned immun. reactions)

(SLEEP, effects,
on agglut. titer)

KUSKOVA, V.F.

Search for an effective method for treating the surgeon's hands at a stomatological polyclinic. Stomatologiya 38 no.3:62 My-Je '59. (MIRA 12:8)

1. Iz kafedry mikrobiologii (zav. - prof.P.F.Belikov) Moskovskogo meditsinskogo stomatologicheskogo instituta (dir. - dotsent G.N.Beletskiy).

(SURGERY, ASEPTIC AND ANTISEPTIC)

KUSKOVA, V.F.; MOROZOVA, L.V.

Microbiological investigations following treatment of teeth with ultrasound. Stomatologiya 40 no.1:27-29 Ja-F '61. (MIRA 14:5)

1. Iz kafedry mikrobiologii (zav. - prof. P.F.Belikov) i ortopedicheskoy stomatologii (zav. - prof. V.Yu.Kurlyandskiy) Moskovskogo meditsinskogo stomatologicheskogo instituta (dir. - dotsent G.N. Beletskiy).

(TEETH—MICROBIOLOGY)
(ULTRASONIC WAVES—PHYSIOLOGICAL EFFECT)

L 08793-67 EWT(m)/EWP(j) IJP(c) WW/RM
ACC NR: AP6030843 (A, N) SOURCE CODE: UR/0191/66/000/009/0010/0011

AUTHOR: Gel'fman, Ya. A.; Zemlyanskiy, N. N.; Lauris, I. V.; Syutkina, O. P.; Kuskova, V. P.; Panov, Ye. M.

ORG: none

TITLE: Stabilization of polyvinylchloride by organotin oxanes

SOURCE: Plasticheskiye massy, no. 9, 1966, 10-11

TOPIC TAGS: vinyl chloride, polymer, tin compound, organotin compound, organometallic compound, solid mechanical property, heat resistance

ABSTRACT: The effect of organotin oxane-type additives [$\text{CH}_3\text{COO}(\text{C}_4\text{H}_9)_2\text{SnO}$, $\text{CH}_3\text{COO}[(\text{C}_4\text{H}_9)_2\text{SnO}]_4\text{OCCH}_3$, and $[\text{C}_{11}\text{H}_{23}\text{COO}(\text{C}_4\text{H}_9)_2\text{Sn}]_2\text{O}$] on the thermal stability of polyvinylchloride was investigated. The aging characteristics of the stabilized PVC was tested according to GOST 10226-62 and the decomposition temperature was tested according to the GOST5960-51 standard. It was found that the PVC stabilized with organotin oxanes had a thermal stability comparable to that of PVC stabilized with conventional R_2PbX_2 stabilizers. It was also found that the organotin oxane stabilizer based on acetic acid was as effective as that based on lauric acid. Orig. art. has: 2 tables.

SUB CODE: 11/ SUBM DATE: 00/ ORIG REF: 004/ OTH REF: 004

Card 1/1 not

UDC: 678.743.22:678.048.9

ORLOVSKIY, N.V.; KOTELNIKOV, V.I.; KUCHEVA, Y.S.; GEROVLYANICH, M.P.

Work of the PT-2-30 Three-level paw on 5000 Hz soils. Trud
Biol. Inst. Sib. otd. AN SSSR no.9:200-212 1962 (MIRA 17:8)

BEREZNEGOVSKAYA, L.N.; KUSKOVA, Z.R.

Effect of gibberelic acid on belladonna. fiziol. rast. 10 no.6:716-
719 N-D '63. (MIRA 16:1)

1. Tomsk Medical Institute.

KUSKOVA, Z.R.

Methodology for the quantitative determination of atropine
in the leaves of belladonna and datura. Apt. delo 14 no.1:69
Ja-F '65. (MIRA 18:10)

1. Tomskiy meditsinskiy institut.

KUSKOVA, Z.R.

Effect of gibberellin on belladonna. Fiziol.rast., 12 no.4:631-
637 J1-Ag '65. (MIRA 1F:12)

1. Kafedra botaniki i farmakologii Tomskogo meditsinskogo
instituta. Submitted March 9, 1964.

BEREZNEGOVSKAYA, L.N.; KUSKOVA, Z.R.

Amino acid and alkaloid dynamics in belladonna as affected by
its development. Nauch. dokl. vys. shkoly; biol. nauki no.2:
165-169 '65. (MIRA 18:5)

1. Rekomendovana kafedroy botaniki i farmakognozii Tonskogo
meditsinskogo instituta.

KUSKOVSKIY, V.S.

Using the water balance of springs in calculating the base
flow of rivers of the Gornyy Altai. Izv. Alt. otd. Geog. ob-va
SSSR no.5:76-77 '65. (MIRA 18:12)

1. Sibirskiy nauchno-issledovatel'skiy institut energetiki.

KUSKULA, Karel; MAYER, Vilem, in.

Complexometric determination of aluminum in nonmetal materials.
Hut listy 18 no.10:735 0 '63.

1. Vitkovicke zelezarny Klementa Gottwalda, n.p., Ostrava.

KUZ'MIN, Ye., starshiy dispetcher-tehnolog; VASIL'YEV, Ye., brigadir
gruzchikov; TIMOFEYEV, A., starshiy kranovshchik; KUSLAP, A.,
starshiy kranovshchik; KHVOSTOVA, D.M., red.; KIRSANOVA, N.A.,
tehn.red.

[New equipment in the port of Riga] Novaya tekhnika v Rizhskom
portu. Izd-vo VTsSPS Profizdat, 1958. 54 p. (MIRA 12:3)
(Riga--Harbor) (Loading and unloading)

RUS. IR, M.I.

KUSLIK, M. I.

Stump and the amputee. *Khirurgia, Moskva* No. 11, Nov. 50.
p. 20-3

1. Of Leningrad Scientific-Research Institute of Protheses,
Leningrad.

CIWL 20, 3, March 1951

KUSLIK, M. I.

Medicine

Precision method of drawing Rose-Nelaton's line., *Khirurgiia.*, no. 12, 1951

9. Monthly List of Russian Accessions, Library of Congress, March 1952, Incl.

RUSLIK, M. I. Prof.

Spine - Abnormalities and Deformities

"Scoliosis and its surgical therapy."
Khirurgiya no. 6, 1952.

Monthly List of Russian Accessions, Library of Congress, October 1952. UNCLASSIFIED.

1. KUSLIK, M. I., Prof.
2. USSR (600)
4. Knee Joint - Surgery
7. A typical resections of the knee joint in gunshot wounds.
Khirurgia No. 3, 1952.

9. Monthly List of Russian Accessions, Library of Congress, January 1953, Unclassified.

KUSLIK, M. I.

Scapula

Osteoplastic fixation of the scapula in paralysis of its muscles, Vest. khir.,
72, No. 3, 1952.

9. Monthly List of Russian Accessions, Library of Congress, October 1952, Uncl.

KARPENKO, N.P.; KUSLIK, M.I., professor, zaveduyushchiy.

Knock knee (genu valgum). Vest.khir. 73 no.5:12-17 S-0 '53. (MLRA 6:11)

1. Kafedra ortopedii i protezirovaniya Gosudarstvennogo ordena Lenina Leningradskogo instituta usovershenstvovaniya vrachey im. S.M.Kirova (for Kuslik).
2. Ortopedicheskoye otdeleniye Tsentral'nogo gosudarstvennogo travmatologicheskogo instituta im. R.R.Vredena. (Leg--Abnormities and deformities)

KUSLIK, M.I., professor

Diagnosis of injuries of the nerve trunks of the upper extremities
enclosed plaster casts. Khirurgiia no.8:69-70 Ag '54. (MLRA 7:11)

(ARM, innervation,
inj., diag.)

(WOUNDS AND INJURIES,
arm nerves, diag.)

KUSLIK, M.I., professor.

Hypoplastic arthroses of the hip joint. Ortop.travm.protez.,
Moskva no.1:7-11 Ja-F '55. (MLBA 8:10)

1. Iz Kafedry ortopedii i protezirovaniya Gosudarstvennogo
instituta usovershenstvovaniya vrachey im. S.M. Kirova i
Leningradskogo nauchno-issledovatel'skogo instituta travma-
tologii i ortopedii.
(HIP, diseases,
arthrosis deformans)

100/100
KUSLIK, M. I., zasluzhennyi deyatel' nauki, prof. Leningrad. 100,
Leningrad pr., d. 61, kv. 198.

Roman Romanovich Vreden; on the 20th anniversary of his death.
Vest.khir.75 no. 5:130-134 Je '55. (MLRA 8:10)
(BIOGRAPHS,
Vreden, Roman R.)

KUSLIK, M.I., professor, zaslushennyy deyatel' nauki (Leningrad, 100,
Lesnoy pr., d. 61, kv. 198)

Surgery for complications of poliomyelitis [with summary in English,
p.158] Vest.khir. 77 no.9:3-19 S '56. (MLRA 9:11)

1. Iz kafedry ortopedii i pro esirovaniya (sav. - prof. M.I.Kuslik)
Leningradskogo ordena lenina nstituta usovershenstvovaniya vrachey
im. S.M.Kirova i ortopeicheskogo otdeleniya (sav. prof. Ya.S.Yusevich)
Leningradskogo instituta travmatologii i ortopedii.

(POLIOMYELITIS, compl.
surg. corrections)

KUSLIK, Mikhail Isaakovich, zasluzhennyi deyatel' nauki, prof.;
ABRAKOV, L.V., red.; KHARASH, G.A., tekhn.red.

[Orthopedic treatment of spastic paralysis] Ortopedicheskoe
lechenie spasticheskikh paralichei. [Leningrad] Gos.izd-vo med.
lit-ry, Leningr. otd-nie, 1957. 113 p. (MIRA 10:12)
(Paralysis, Spastic)

KUSLIK, M.I., zasluzhennyy deyatel' nauki, professor

Determination of the extent of hip abduction for functional lengthening of the extremities in ankylosis and contracture of the hip joint.
Ortop., travm. i protez. 18 no.1:57-58 Ja-f '57. (MIRA 10:6)

1. Iz kafedry ortopedii i protezirovaniya (zav. - prof. M.I.Kuslik)
Gosudarstvennogo instituta usovershenstvovaniya vrachey im. S.M.Kirova
(dir. - prof. N.I.Blinov) i ortopedicheskogo otdeleniya (zav. - prof.
Ya.S.Yusevich) Leningradskogo nauchno-issledovatel'skogo instituta
travmatologii i ortopedii (dir. - prof. V.S.Balakina)

(HIP, dis.

ankylosis & contractures, determ. of angle for surg.
correction)

(CONTRACTURE

hip, determ. of angle for surg. correction)

KUSLIK, M. I., zaslushennyy deystel' nauki, prof. (Leningrad)

"Instruction in walking with orthopedic apparatus without a knee
lock; therapeutic exercise and massage in postpoliomyelitic paralysis".
by N.A. Shenk. Reviewed by M. I. Kuslik. Ortop. travm. i protez.
19: no. 3: 79 My-Je '58 (MIRA 11:7)

(ORTHOPEDIC APPARATUS)

(PARALYSIS)

(SHENK, N.A.)

MUSLIX, M.I., prof., zasluxhennyy deyatel' nauki

Closed injuries of the biceps brachii tendons and their treatment
[with summary in English]. Khirurgiia 34 no.7:98-101 JI '58
(MIRA 11:9)

1. Iz kafedry ortopedii i protezirovaniya Leningradskogo ordena
Lenina instituta usovershenstvovaniya vrachey imeni S.M. Kirova
(dir. - prof. N.I. Blinov) i Leningradskogo instituta travmatologii
i ortopedii (dir. - prof. V.S. Palakina).

(ARM, muscles and tendons
biceps brachii inj., etiol. & ther. (Rus))

KUSLIK, M. I., (Prof.) -- Leningrad

"Surgical Treatment of Giant Cell Tumors (Osteoblastoclastomas."

Report submitted for the 27th Congress of Surgeons of the USSR, Moscow,
23-28 May 1960.

KUSLIK, M.I., zasluzhennyy deyatel' nauki, prof.; TARUSHKIN, O.V., starshiy nauchnyy sotrudnik

Electrostimulation of the muscles in spastic paralysis. Ortop. travm.i protez. 21 no.4:34-37 Ap '60. (MIRA 13:9)

1. Iz ortopedicheskogo otdeleniya i fiziologicheskoy laboratorii Leningradskogo nauchno-issledovatel'skogo instituta travmatologii i ortopedii (dir. - prof. V.S. Balakina) i kafedry ortopedii gosudarstvennogo instituta dlya usovershenstvovaniya vrachey (dir. - dotsent A.Ye. Kiselev).

(PARALYSIS, SPASTIC)

(ELECTROTHERAPY)

ARENDR, A.A., prof.; ARKHANGEL'SKIY, V.V., kand. med. nauk; BOGDANOV, F.R., prof.; BONDARCHUK, A.V., prof.; KOPYLOV, M.B., prof.; KORNEV, P.G., zasl. deyatel' nauki RSFSR, prof.; KUSLIK, M.I., prof.; LEYBZON, N.D., doktor med. nauk; MAKAROV, M.I., kand. med. nauk; NIKOL'SKIY, V.A., prof.; PODGORNAYA, A.Ya., doktor med.nauk; RAZDOL'SKIY, I.Ya., prof.[deceased]; ROSTITSKAYA, V.I., kand. med.nauk; TUMSKOY, V.A., kand. med.nauk; UGRYUMOV, V.M., prof.; FISHKIN, V.I., kand. med. nauk; KHRAPOV, V.S., kand. med. nauk; CHIKOVANI, K.P., prof. [deceased]; SHLYKOV, A.A., prof.; PETROVSKIY, B.V., prof. zasl. deyatel' nauki RSFSR, otv. red.; YEGOROV, B.G., zasl. deyatel' nauki RSFSR prof., red. toma; MIRONOVICH, N.I., doktor med. nauk, zam. red.; PARAKHINA, N.L., tekhn. red.

[Manual on surgery] Mnogotomnoe rukovodstvo po khirurgii. Moskva, Medgiz. Vol.4. [Neurosurgery; the sequelae of lesions of the central nervous system. Diseases of the spine, the spinal cord and its membranes. Diseases of the vegetative nervous system] Neirokhirurgiya; posledstviia povrezhdenii tsentral'noi nervnoi sistemy. Zabolevaniia pozvonochnika, spinnogo mozga i ego obolochek. Zabolevaniia vegetativnoi nervnoi sistemy. 1963. 667 p. (MIRA 16:10)

1. Deystvitel'nyy chlen AMN SSSR (for Petrovskiy, Yegorov, Kornev). 2. Chlen-korrespondent AMN SSSR (for Bogdanov).
(NERVOUS SYSTEM—SURGERY) (SPINE—SURGERY)

KUMIN, Mikhail Ivanovich, M.D. (1911-1971).
KUMIN, Yu. Ia., ed.

[Surgical treatment of plant cell tumors] (in Russian)
skoe ischenie gigantokletchnykh opukheli. Leningrad,
Meditsina, 1961. 270 p. (MIRA 144)

KUSLIK, M.I., prof., zasluzhenny deyatel' nauki RSFSR

Experience in conservative surgical treatment of giant cell
tumors. Khirurgia 40 no.5:107-114 My '64. (MIRA 18:2)

1. Kafedra ortopedii i protezirovaniya Instituta ordena Lenina
usovershenstvovani a vrachey imeni Kirova (dir.- dotsent S.N.
Polikarpov) i Leningradskogo instituta travmatologii i ortopedii
(dir.- prof. V.S. Balakina).

KARPENKO, G.V. [Karpenko, H.V.]; KUSLITSKIY, A.B. [Kuslyts'kyi, A.B.];
BABEY, Yu.I. [Babei, I.U.I.]

Effect of the density of ShKh15 steel made with electric
slag and vacuum refining on its cyclic strength. Dop.
AN URSR no.8:1063-1066 '64. (MIRA 17:8)

1. Institut mashinovedeniya i avtomatiki AN UkrSSR.
2. Chlen-korrespondent AN UkrSSR (for Karpenko).

L 11327-65 EWT(m)/EWP(w)/EWA(d)/EWP(t)/EWP(b) MJW/JD

S/0021/64/000/008/1063/1066

ACCESSION NR: AP4043731

AUTHOR: Karpenko, G. V. (Corresponding member AN UkrSSR); ~~Kuznetsov, A. B.~~
(~~Kuznetsov, A. B.~~); Babey, Yu. I.

TITLE: Effect of the density of electroslag and vacuum-melted, ball-bearing, ShKh15 steel on its fatigue strength

SOURCE: AN UkrSSR. Dopevidi, no. 8, 1964, 1063-1066

B

TOPIC TAGS: ball bearing steel, ShKh15 steel, electroslag melted steel, vacuum melted steel, steel fatigue strength, steel density, steel purity

ABSTRACT: The effect of nonmetallic inclusions and density on the fatigue strength of ball-bearing ShKh15 steel [AISI E52100] has been investigated. The steel was made by: 1) melting in an open electric arc furnace, 2) electroslag melting, 3) electroslag and subsequent vacuum melting, 4) electroslag and subsequent double vacuum melting, 5) double vacuum melting, and 6) double vacuum melting from virgin charge materials. All the steels prepared had a standard chemical composition and a hardness of 61-63 HRC after quenching. Density was measured in quenched and fatigue strength, in annealed specimens.

Card 1/2

L 11327-65

ACCESSION NR: AP4043731

Fatigue tests revealed no definite relationship between the presence of individual nonmetallic inclusions in ShKh15 steel and its fatigue strength. The density-fatigue strength test data show that fatigue strength increases as the steel density increases, and that the influence of the density is more pronounced in steels with fewer nonmetallic inclusions. In steels with practically identical amounts of nonmetallic inclusions, fatigue strength increased 23% with an increase in density from 7.7990 to 7.8116 g/cm³, or ~0.15%. Hence, for a more complete evaluation of the serviceability of ball-bearing steel, both the content of nonmetallic inclusions and the steel density should be taken into account. Orig. art. has: 2 figures and 1 table.

ASSOCIATION: Instytut mashynoznavstva ta avtomatyky AN URSR (Institute of Machine Science and Automation, AN URSR)

SUBMITTED: 16Dec63

ATD PRESS: 3100

ENCL: 00

SUB CODE: MK, IE

NO REF SCV: 008

OTHER: 003

Card 2/2

L 19623-65 EPA(a)-2/EWT(m)/EWP(w)/EWA(d)/EWP(v)/T/EWP(t)/EWP(k)/EPA(bb)-2/
EWP(b) Pf-4/Pt-10 ASD(f)-2/AFMDC/ASD(m)-3 MJW/JD/WB/EM

ACCESSION NR: AP4047507

S/0129/64/000/G10/0028/0031

AUTHOR: Karpenko, G. V.; Meverson, I. L.; Babay, Yu. I.; Tabinskiy, K. P.; Kuslitakiy, A. D.

TITLE: Corrosion and corrosion fatigue resistance of Kh17N2 and SN3 steels

SOURCE: Metallovedeniye i termicheskaya obrabotka metallov, no. 10, 1964, 28-31, and bottom half of inert facing p. 40

TOPIC TAGS: stainless steel, steel corrosion, steel corrosion fatigue, precipitation hardenable steel, Kh17N2 steel, SN2 steel, steel corrosion resistance, steel corrosion fatigue resistance, anticorrosion coating, 30% varnish

ABSTRACT: The corrosion and corrosion fatigue of Kh17N2 (0.12% C, 17.23% Cr, 1.84% Ni) and SN3 (0.09% C, 16.91% Cr, 4.71% Ni, 3.31% Mo) stainless steel have been investigated. Steels were heat-treated to a hardness of 38--40 and 40--42 HRC, respectively. The test results showed that the SN3 steel has a higher corrosion resistance than the Kh17N2 steel, e.g., by 2.5 times in 53% sulfuric acid. The SN3 fatigue strength in air

Card 1/3

L 19623-65
ACCESSION NR: AP4047507

3

is 10% higher than that of the Kh17N2 steel. In a 3% sodium-chloride solution, the fatigue strength of both steels decreases by about the same factor, compared with that in air (see Fig. 1 of the Enclosure) and at $N = 2 \cdot 10^7$ cycles, is about 2 times lower than that in air. This confirms the absence of a direct relation between the corrosion resistance and the corrosion fatigue resistance of the metal. The SN3 steel is preferable to Kh17N2 steel for compressor blades working in aggressive media. Coating with 302 varnish (composition unidentified) increases by 1.5 times the corrosion fatigue strength of Kh17N2 and SN3 steels. Orig. art. has: 2 figures.

ASSOCIATION: Fiziko-mekhanicheskiy institut AN UkrSSR(Physiomechanical Institute AN UkrSSR)

SUBMITTED: 00

ENCL: 01

SUB CODE: MM

NO REF SOV: 009

OTHER: 000

Card 2/3

L 19623-65

ACCESSION NR: AP4047507

ENCLOSURE: 01

σ dan/mm²

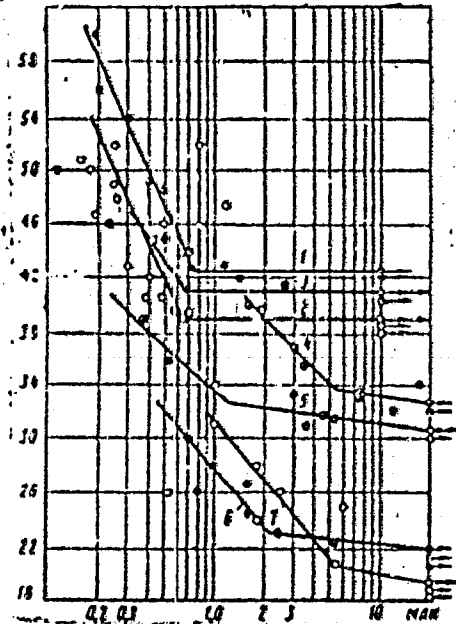

Fig. 1. Fatigue curves of uncoated (1,6) and 302 varnish-coated (4) SN3 steel, and uncoated (2,7) and 302 varnish-coated (3) Kh17NZ steel in air (1,2,3) and in a 3% solution of sodium chloride (4,5,6,7).

Card 3/3

L 21446-65 EWT(m)/EWP(w)/EWA(d)/T/EWP(t)/EWP(b) MJW/JD

ACCESSION NR: AT4049945

S/2723/64/000/003/0107/0118

AUTHOR: Kuslitskiy, A.B.; Babey, Yu. I.; Serebriyskiy, E.I.; Mizetskiy, V.L.;
Borisov, A. YA.; Kirpenko, G.V. (Corresponding member AN UkrSSR)

TITLE: Effect of the hardening temperature on the fatigue strength of ShKh15 steel from
electroslag and vacuum refining

SOURCE: AN UkrSSR. Fiziko-mekhanicheskii institut. Vliyaniye rabochikh sred na
svoystva materialov, no. 3, 1964, 107-118

TOPIC TAGS: steel fatigue strength, hardening temperature, electroslag steel, vacuum
smelted steel, steel purity/ Shkh 15 steel

ABSTRACT: This study was prompted by the lack of data concerning the physical and
mechanical properties of electroslag steel (see, e.g., B. Ye. Paton, B.I. Modovar,
Yu. V. Latash, Stal', no. 11, 1962) and by the inconclusive results concerning such
properties of vacuum smelted steels (see, e.g., H.B. Nudelman, J. Sheehan, A study
of the effect of melting practice on the fatigue behavior of high-strength steel. Armour
Res. Foundat., Chicago, 1951). The maximum cyclic hardness of ShKh15 steel was
tested after a. electroslag smelting followed by vacuum smelting (very pure ShKh15 -

Card 1/2

L 23446-65

ACCESSION NR: AT4049945

6

free from nonmetallic admixtures); b. the same as (a) but less pure (ShKh15S); c. electroslag smelting only (ShKh15Sh); d. ordinary smelting in an open electric oven (ShKh15); e. double vacuum arc smelting of pure steel (ShKh15Ch); and f. the same as (e) with an ordinary smelt (ShKh15D). The optimum hardening temperature for the ShKh15S and ShKh15D steel was 850C while all the other steels showed maximum cyclic hardness after hardening at 840C (all samples were annealed at 150C during a 2-hour period). The cyclic hardness of the air-hardened ShKh15 steel from different types of smelts depended on the presence of nonmetallic admixtures as well as on its density. An increase in purity and in density led to a 25-30% increase in fatigue strength. "The degree of contamination of the steel with non-metallic impurities was evaluated by Engineer N.I. Zakhodskaya; Engineer B.F. Ryabov took part in developing and setting up the system of automatic furnace temperature control." Orig. art. has. 3 figures and 5 tables.

ASSOCIATION: none

SUBMITTED: 00

ENCL: 00

SUB CODE: MM

NO REF SOV: 020

OTHER: 004

Cont 2/2

L 23066-65 EWT(m)/EHA(d)/EWP(t)/EWP(b) MJW/JD

ACCESSION NR: AT1049946

8/2723/64/006/003/0119/0123-4
23
21AUTHOR: Kuslitskiy, A.B.; Mindyuk, A.K.TITLE: Corrosion stability of ShKh15 steel from electroslag and vacuum smelts / 6

SOURCE: AN UkrSSR. Fiziko-mekhanicheskiy institut. Vityaniye, obochikh sred na svoystva materialov, no. 3, 1964, 119-123

TOPIC TAGS: steel corrosion, electroslag melting, vacuum melting, ball bearing steel, steel impurity/steel ShKh15

ABSTRACT: Ball bearing steel ShKh15 from different types of smelts was investigated for corrosion resistance. The samples were ShKh15 steel smelted in the ordinary way, steel smelted by electroslag melting with subsequent vacuum smelting and containing some nonmetallic admixtures (ShKh15S) (the same steel as ShKh15S except with a lower content of nonmetallic impurities (ShKh15P)) and steel smelted once by electroslagification (ShKh15Sh). The results (see Fig. 1 of the Enclosure) show that the corrosion stability of hardened steel ShKh15 prepared by the ordinary, electroslag or vacuum smelting exhibits a 20-30% larger corrosion stability than steel annealed over the same period of time (3 hours). Contamination by nonmetallic admixtures affects the corrosion stability significantly. The corrosion stability of cleaner ShKh15Sh and ShKh15P steels exceeds

Card 1/17

L 23066-65

ACCESSION NR: AT4049946

the corrosion stability of less pure ShKh15 and ShKh158 smelts by 25-30%. Among various nonmetallic components left after the above-mentioned types of smelting, oxides and silicates reduced the corrosion stability of the ball bearing steel more significantly. Globular and spot impurities and sulfides caused less marked ill-effects. Orig. art. has: 1 figure and 4 tables.

ASSOCIATION: none

SUBMITTED: 20Jun63

ENCL: 01

SUB CODE: MM

NO REF SOV: 002

OTHER: 000

Card 2/3

L 23067-65 EWT(m)/FWP(w)/EWA(d)/T/FWP(t)/EWP(b) MJW/JD/WE

ACCESSION NR: AT4049048

S/2723/64/000/003/0130/0134

AUTHOR: Kuslitskiy, A. B.; Babey, Yu. I.; Serebriyskiy, E. I.; Mizetskiy, V. L.; Borisov, A. Ya.

TITLE: Corrosion resistance and fatigue strength of annealed ShKh15 steel from electroslag and vacuum smelts 26/6

SOURCE: AN UkrSSR. Fiziko-mekhanicheskiy institut. Vliyaniye rabochikh sred na svoystva materialov, no. 3, 1964, 130-134

TOPIC TAGS: steel corrosion, steel fatigue strength, steel annealing, saline corrosion, electroslag melting, vacuum melting, steel impurity/steel ShKh15 6

ABSTRACT: While the physical and mechanical properties of annealed ShKh15 steel are known to a considerable extent, the resistance to fatigue had not yet been sufficiently investigated. Since the work described earlier by the same authors (AN UkrSSR. Fiziko-mekhanicheskiy institut. Vliyaniye rabochikh sred na svoystva materialov, No. 3, 1964, 107-118) indicated that the differences in smelting technology result in variations in the admixture content of the samples, they now investigated the effects of these nonmetallic admixtures on the static hardness characteristics, fatigue strength, and corrosion resistance of various annealed steels. The results show that: 1. ShKh15 steels from
Card 1/3

L 23067-65

ACCESSION NR: AT4049048

ordinary, electroslag and vacuum smelts in the annealed state have approximately equal static hardness and fatigue strength in air; 2. in a corrosive medium, double vacuum-smelted steel and pure samples from single electroslag smelts with a subsequent vacuum smelting show the best fatigue properties (see Pt. 1 of the Enclosure). Orig. art. has; 2 figures and 2 tables.

ASSOCIATION: none

SUBMITTED: 00

ENCL: 01

SUB CODE: MM

NO REF SOV: 007

OTHER: 000

Card 2/3

L 23067-65

ACCESSION NR: AT4040948

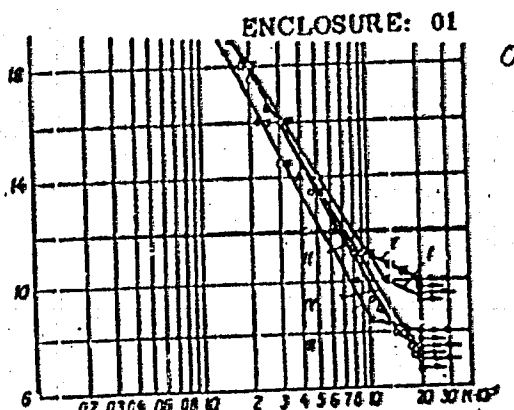
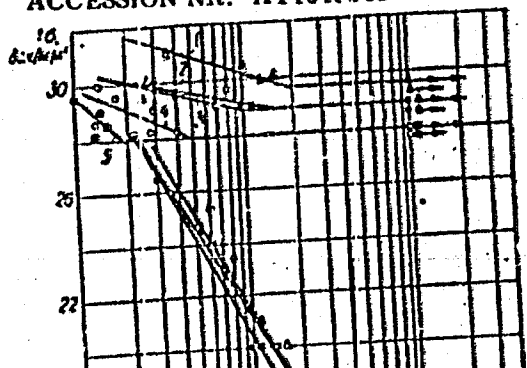

Fig. 1. Fatigue curves of annealed ShKh15 steel of various types, tested in air (Arabic numerals) and in 3% aqueous saline (Roman numerals): 1, I - ShKh15 steel prepared by a single electroslag smelting followed by a single vacuum smelting and containing less non-metallic impurities than in 2/II; 2, II - ShKh15S steel, prepared as in 1, I but containing more non-metallic impurities; 3, III - ShKh15Sh steel prepared by a single electroslag smelting; 4, IV - ShKh15 steel prepared in the usual way; 5, V - ShKh15Ch steel, prepared by double vacuum melting from an especially pure furnace charge.

Card 3/3

L 1439-66 EWT(m)/EPF(c)/ENP(w)/EJA(d)/T/ENP(t)/ENP(z)/ENP(b)/ETC(m) MJW/JD/WW/WB
ACCESSION NR: AP5022405 ⁶⁰⁸ UR/0369/65/000/004/0477/0480
_{61B}

AUTHOR: Yefimenko, Yu. M.; Kuslitskiy, A. B.; Chaban, D. V.; Karpenko, G. V.;
Mcvchan, B. A. _{44,55} _{44,55} _{44,55} _{44,55} _{44,55}

TITLE: Effect of the electron beam smelting on properties of the ShKh15 ball bearing steel ₆

SOURCE: Fiziko-khimicheskaya mekhanika materialov, no. 4, 1965, 477-480

TOPIC TAGS: electron beam, ball bearing, smelting furnace

ABSTRACT: The effect of electron beam smelting on mechanical properties of the ShKh15 ball bearing steel was studied in order to compare the effectiveness of this technique with the effectiveness of the vacuum and slag smelting techniques. The electron beam smelting was conducted in a U-143 unit under $5 \cdot 10^{-4} - 5 \cdot 10^{-5}$ mm Hg. As a result of this smelting treatment the oxygen content dropped from 0.0040 to 0.0007%, nitrogen from 0.007 to 0.0013%, hydrogen from 0.0001 to 0.00004%, SiO₂ from 0.0008 to 0.0004%, Al₂O₃ from 0.0270 to 0.0018%, FeO from 0.0007 to 0.0001%, and CaO from 0.0005 to 0.0001%. Electron beam smelted steel improved: resistance to cyclic deformation, corrosion resistance, and fatigue limit (33% increase). ₆

Card 1/4

L 1439-66

ACCESSION NR: AP5022405

7
The mechanical strength of ShKh15 steel (σ in kg/mm^2) as a function of frequency of cyclic deformation (in millions of cycles) N , is shown in fig. 1 of the Enclosure. The corrosion resistance of ShKh15 steel in 53% H_2SO_4 solution is shown in fig. 2 of the Enclosure. Orig. art. has: 3 figures, 5 tables.

ASSOCIATION: Institut elektrosvar'ki im. Ye. O. Patona, AN UkrSSR, Kiev (Institute of Electric Welding, AN UkrSSR); Fiziko-mekhanicheskiy Institut, AN UkrSSR, L'vov (Physico-Mechanical Institute, AN UkrSSR) 14.55

SUBMITTED: 24Mar65

ENCL: 02

SUB CODE: KM

NO REF SOV: 004

OTHER: 000

Card 2/4

L 1439-66

ACCESSION NR: AP5022405

ENCLOSURE: 01

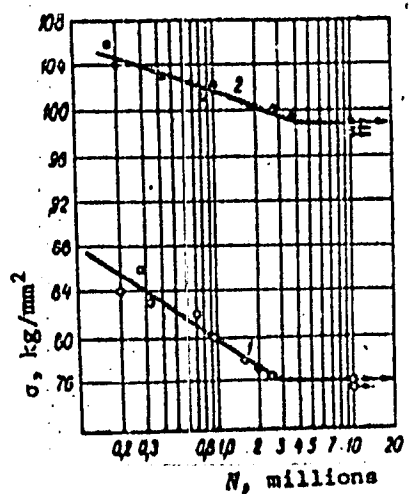

Fig. 1. 1--initial ShKh15 steel; 2--electron beam smelted ShKh15 steel.

Card 3/4

L 1439-66

ACCESSION NR: AP5022405

ENCLOSURE: 02

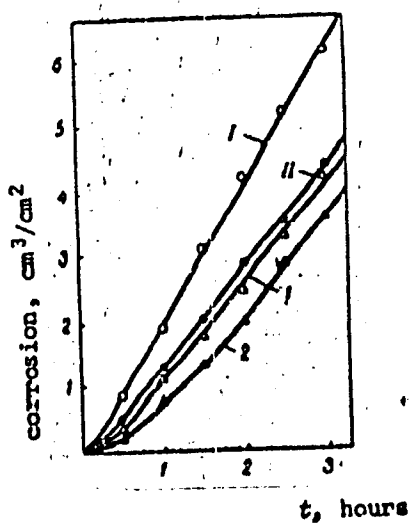

Fig. 2. 1--annealed steel; 2--tempered steel; I, 1--untreated steel; II, 2--electron beam melted steel.

Card 4/4

OP

L 40906-65 EWT(m)/EWP(w)/EPF(c)/EWA(d)/I/EWP(t)/EWP(z)/EWP(b) KJW/JD/WB
ACCESSION NR: AP6009278 8/0369/65/001/001/0027/0031

AUTHOR: Euslitskiy, A.B.; Mindyuk, A.K.; Rudenko, V.P.; Ryabov, B.F.

TITLE: Corrosion resistance and corrosion-fatigue strength of hardened ShKh 15 steel

SOURCE: Fiziko-khimicheskaya mekhanika materialov, v. 1, no. 1, 1965, 27-31

TOPIC TAGS: steel corrosion, steel fatigue strength, hardened steel, corrosion resistance, electroslag melting, electroslag refining, vacuum melting/shKh 15 steel

ABSTRACT: Comparative corrosion-resistance and corrosion-fatigue strength tests were made on samples of ball-bearing steel with different degrees of contamination by nonmetallic impurities and different densities. Six types of ShKh 15 steel (made by six different technological variants) were thus tested. A 3% NaCl solution was used as the corrosive medium. The corrosion resistance of electroslag and vacuum steels was found to be virtually the same and somewhat greater than that of the ordinary variety made in an open arc furnace. The 3% NaCl corrosive medium sharply decreased the cyclic strength of hardened steel. Steels subjected to electroslag remelting were found to be somewhat better in this regard. Fatigue tests on the six types of steel showed that the more aggressive the corrosive medium or more severe the testing conditions (preliminary

Card 1/2

31
30
B

L 40906-65

ACCESSION NR: AP5009278

corrosion of the samples), the smaller the difference in the properties of these types, i.e., the less they differed from one another. Orig. art. has: 3 figures.

ASSOCIATION: FMI AN Ukr SSR, Lvov

SUBMITTED: 20Jul64

ENCL: 00

SUB CODE: MM

NO REF SOV: 006

OTHER: 000

llc
Card 2/2

KUSLITSKIY, A.B.

Effect of the impurity of metal on the cyclic strength of
hardened steel. Fiz.-khim. mekh. mat. 1 no.2:203-208 '55,
(MIRA 18:6)

1. Fiziko-mekhanicheskiy institut AN UkrSSR, L'viv.

L 60255-65 EPP(c)/EPP(n)-2/EWP(z)/EWT(m)/EWP(b)/T/EWA(d)/EWP(w)/EWP(t)

Pu-4 IJP(a) KJW/JD/JG/WB

UR/0369/65/001/002/0214/0217

ACCESSION NR: AP5012645

AUTHOR: Il'ina, G. V.; Kuslitskiy, A. B.; Starovoytov, Yu. A.

TITLE: The effect which composite alloying with manganese, tungsten and molybdenum has on corrosion fatigue strength and corrosion resistance of ShKh 15 steel

SOURCE: Fiziko-khimicheskaya mekhanika materialov, v. 1, no. 2, 1965, 214-217

TOPIC TAGS: corrosion resistance, steel corrosion, fatigue strength, alloy steel

ABSTRACT: Previous tests show that reducing non-metallic inclusions does not affect the hardenability and heat resistance of ShKh 15 steel. This work considers the effects of composite alloying with molybdenum (0.4-0.6%), tungsten (1.0-1.2%) and manganese (0.9-1.2) on certain properties of ShKh steel. The alloy was designated ShKh 15VNG. The steel was produced by two-arc vacuum melting. Purity tests show that ShKh 15VNG melted by this method is only a little less pure than ShKh 15 steel. Optimum melting conditions are described. Tests showed that alloying with manganese, tungsten and molybdenum improves the maximum hardness of the steel and greatly increases creep resistance. Tables are given comparing the mechanical properties and toughness of the steels. Fatigue test results are given and compared.

Card 1/2

L 60255-65

ACCESSION NR: AP5012655

with ShKh 15 steel fatigue curves. Corrosion fatigue test results are given. It was found that composite alloying of ShKh 15 steel with 1.0-1.2% tungsten, 0.4-0.6% molybdenum and 0.3-1.2% manganese, somewhat increases its hardenability, markedly increases heat resistance and toughness, causes an increase in cyclic strength in air, substantial rise in corrosion resistance in H₂SO₄ and does not greatly affect corrosion fatigue endurance in 3% NaCl solution. Orig. art. has: 3 figures, 2 tables.

ASSOCIATION: FMI AN UkrSSR, Lvov

SUBMITTED: 21Sep64

ENCL: 00

SUB CODE: MM

NO REF SOV: 009

OTHER: 000

Card 2/2 *lpr*

KULITSKIY, A.B.; RYABOV, B.F.

Chamber for fatigue tests of rotating specimens in an atmosphere
of vapors or heated air. Fiz.-khim. mekh. mat. 1 no.2:247-
248 '65. (MIRA 18:6)

1. Fiziko-mekhanicheskiy institut AN UkrSSR, I'vov.

(11)

L 12183-66

EWT(m)/EWA(d)/EWP(t)/EWP(z)/EWP(b) MJW/JD

ACC NR: AP5028376

SOURCE CODE: UR/0369/65/001/005/0583/0587

AUTHOR: Kuslitskiy, A. B.; ^{4/55} Kachmar, Z. F.; ^{7/11} Yefimenko, Yu. M.; ^{4/55} Chaban, D. V. 57

ORG: Physics-engineering Institut, AN UkrSSR, L'vov (Fiziko-mekhanicheskiy institut AN UkrSSR); Electric Welding Institute im. Ye. O. Paton, AN UkrSSR, Kiev (Institut elektrovarki AN UkrSSR) B

TITLE: The effect of nonmetallic inclusions on the strength of hardened ShKh15 steel during hydrogenation 14

SOURCE: Fiziko-khimicheskaya mekhanika materialov, v. 1, no. 5, 1965, 583-587

TOPIC TAGS: steel property, hydrogenation, metal strength, nonmetallic inclusion, martensite steel, ball bearing steel, *SOLID MECHANICAL PROPERTY*

ABSTRACT: The authors determined the effect of impurities in martensite (HRC = 61-63) ball bearing steel on its mechanical properties during hydrogenation. The hydrogenation process sharply reduces the strength of steel of all methods of preparation, depending on the impurity content in the steel. An increase in the quantity of nonmetallic inclusions decreases the strength of the steel. The existing methods of qualitative and quantitative analyses of the content of non-metallic inclusions (metallographic and electrolytic separation) do not provide
Card. 1/2

2

L 12183-66

ACC NR: AP5028376

sufficient reliability in the investigation of the higher grades of steel made by vacuum, molten slag electric process, and the electron-beam remelting methods. The most unfavorable nonmetallic inclusions are brittle particles, such as minute titanium inclusions and silica particles, which are not detectable by metallic-graphic analysis. The most effective method of removing the nonmetallic inclusions and gases from the steel is the electron-beam remelting process. Orig. art. has: 2 figures and 3 tables.

SUB CODE: 11 / SUBM DATE: 11Apr65 / ORIG REF: 009 / OTH REF: 004

Card 2/2

L 14415-66 EWP(z)/EWT(m)/EWP(b)/T/EWA(d)/EWP(w)/EWI(t) MJW/JD/WB
ACC NR: AP6002126 (N) SOURCE CODE: UR/0369/65/001/006/0732/0733

AUTHOR: Tkachev, V. I.; Kripyakevich, R. I.; Kuslitskiy, A. B.; Kreymerman, G. I.

58
54
B

ORG: Physicomechanical Institute AN UkrSSR, L'vov (Fiziko-mekhanicheskiy institut AN UkrSSR)

TITLE: Effect of the purity of steel and corrosion medium on low-cycle fatigue

SOURCE: Fiziko-khimicheskaya mekhanika materialov, v. 1, no. 6, 1965, 732-733

TOPIC TAGS: steel, corrosion, durability, hydrogen embrittlement, sulfuric acid, sodium chloride, stress concentration

ABSTRACT: The effect of the content of nonmetallic inclusions on the low-cycle fatigue of annealed ShKh15 steel produced by various processes was studied in air and in corrosive media (3% NaCl solution; 0.1 N H₂SO₄ solution; 0.1 N H₂SO₄ solution with cathodic polarization at current density $D_c = 10 \text{ A/dm}^2$ corresponding to hydrogen absorption). Tests in air showed a marked divergence in the values of the durability of the purest and most contaminated steel. In the neutral medium, the durability drops by 15-25% while the effect of purity diminishes. In the acid medium, the durability drops even more (by 25-30%). Under hydrogen absorption conditions, the durability is at its minimum (about 60% of the value in air),
Card 1/2

2

L 14415-66
ACC NR: AP6002126

and its dependence on the purity is slight; this is because the formation of brittle cracks causes a decrease in durability. As the corrosiveness of the medium increases, the influence of steel purity of low-cycle fatigue levels off, probably because additional stress concentrators which are more effective than the nonmetallic inclusions are formed. During hydrogen absorption, the inclusions act as sources of cracks. Orig. art. has: 2 figures.

SUB CODE: 11 / SUBM DATE: 17Jun65 / ORIG REF: 003

Card 2/2

L 21923-66 EWA(h)/EWT(m)/T/EWA(d)/EWP(w)/EWP(t) IJP(c) IPI
ACC NR: AF6014622 SOURCE CODE: UR/0133/65/000/002/0151/0153

AUTHOR: Kuslitskiy, A. B.; Babey, Yu. I.; Karpenko, G. V.; Serebriyskiy, E. I.;
Mizetskiy, V. L.; Borisov, A. Ia. 53

ORG: none 50

TITLE: Influence of nonmetallic inclusions and metal density on the fatigue strength
of electroslag and vacuum remelted ShKh15 steel 18

SOURCE: Stal, no. 2, 1965, 151-153 16

TOPIC TAGS: nonmetallic inclusion, bearing steel, steel, electroslag melting,
vacuum melting, density, steel microstructure, fatigue strength, annealing/ShKh15
bearing steel

ABSTRACT: Very strict requirements have been set forth as to the purity of ShKh15
ballbearing steel for manufacturing precision instrument bearings. These requirements
can only be satisfied by special technology, e. g., by means of vacuum-arc and
electroslag remelting (VAR and ESR). The degree of purity as to nonmetallic inclusions
is not the same for different methods of remelting. The metal also differs in density.
The authors of this paper investigated the relationship of both nonmetallic inclusions
and density to fatigue strength of ShKh15 steel which was processed by six different
methods: I and II-ESR+VAR (steel ShKh15P and ShKh15S); III-ESR (steel ShKh15Sh);
IV--conventional melting in an open arc furnace (ShKh15); V--double VAR of a steel
smelted from pure charge materials; and VI--double VAR of ordinary billets. As to

Card 1/2

UDC: 669.15

L 21923-66

ACC NR: AP6014622

3

chemical composition, the steel of all the melting methods conformed to GOST 801-60.¹ Nonmetallic inclusions content was measured according to the scale of ChMTU 236-60.¹ Density was measured by hydrostatic weighing of 20 samples from each of three melts (after quenching and low tempering). The samples were fatigue tested by the rotating beam method using an NU machine at 50 cps. Samples for fatigue testing were turned from 18-20 mm annealed rods which were then heated to 840-850 C, oil quenched, and tempered at 150°C for 2 hours. The method used for evaluating contamination of the steels did not make it possible to establish a definite relationship between the content of individual forms of nonmetallic inclusions melted by the different methods and their fatigue limit, but, in general, the fatigue strength was lower for those steels which had a higher inclusion content. Of all the methods used it was found that electroslag remelting yields a denser microstructure and, consequently, a higher fatigue strength. Therefore, density of ballbearing steel should be considered as one of the most important factors of its quality and be rigidly controlled in the production of highly reliable bearings. Orig. art. has: 3 figures and 1 table.
[JPRS]

SUB CODE: 11, 13, 20 / SUBM DATE: none / ORIG REF: 010 / OTH REF: 006

Card 2/2 nmt

L 37941-46 FBI(m)/P(w)/I/ESP(t)/111 LP(c) D
ACC NR: AP6023448 (N) SOURCE CODE: UR/0369/66/002/003/0336/0339

AUTHOR: Kuslitskiy, A. B.; Kreymerman, G. I.; Kokotaylo, I. V.; Starovoytov, Yu. A.; Karpenko, G. V.; Tkachev, V. I.

ORG: Physicomechanical Institute, AN UkrSSR, L'vov (Fiziko-mekhanicheskiy institut AN UkrSSR)

TITLE: Effect of metallurgical factors on the low-cycle fatigue in various media

SOURCE: Fiziko-khimicheskaya mekhanika materialov, v. 2, no. 3, 1966, 336-339

TOPIC TAGS: steel, low alloy steel, nickel containing steel, vacuum-degassed steel, low cycle fatigue, steel fatigue strength, steel fatigue life/12KhN3A steel
steel structure

ABSTRACT: Low-alloy 12KhN3A structural steel, conventionally cast or vacuum degassed, was hot-rolled into 40 mm plates or 3 mm sheets, hardened, and tempered to a tensile strength of 100 dan/mm², and tested for fatigue strength in the air, in a 3% NaCl aqueous solution, and in the same solution with applied cathodic polarization, the latter to promote a hydrogen absorption. A constant-amplitude, symmetrical bending at a frequency of 0.8 cps was used in the tests. The test results showed that vacuum-degassed steel had a longer fatigue life in all the investigated media than the conventionally cast steel, especially in the tests in the NaCl solution with cathodic polarization. The embrittling effect of hydrogen and, correspondingly, the difference in the fatigue life increased with increasing amplitude. Longitudinal

Card 1/2

L 37-41-55
ACC NR: AP6023448

specimens had a longer fatigue life than that of transverse specimens. With increasing amplitude, the difference in the fatigue life of longitudinal and transverse specimens increased substantially in tests in the air, and less so in tests in NaCl solution, but noticeably decreased in the NaCl with cathodic polarization. Sheet specimens had a slightly higher fatigue life than that of plate specimens in the air and in NaCl solution, but lower in NaCl with cathodic polarization. Orig. art. has: 1 figure. [MS]

SUB CODE: 11/ SUBM DATE: 05Feb66/ ORIG REF: 002/ ATD PRESS: 5047

Card 2/2 11/11 P

L 42319-66 EWT(m)/ENP(w)/T/EWP(t)/EIL IJP(c) JD/WB

ACC NR: AP6020916

SOURCE CODE: UR/0369/66/002/002/0192/0194

44
B

AUTHORS: Tkachov, V. I.; Kripyakovich, R. I.; Kuslitskiy, A. B.

ORG: Physico-Mechanical Institute, AN UkrSSR, L'vov (Fiziko-mekhanicheskiy institut AN UkrSSR)

TITLE: Influence of preliminary hydrogenation and corrosion on the low-cycle fatigue of steel

SOURCE: Fiziko-khimicheskaya mekhanika materialov, v. 2, no. 2, 1966, 192-194

TOPIC TAGS: steel, alloy steel, hydrogen embrittlement, metal aging / 08kp low carbon steel, ShKh15 carbon steel
CORROSION RATE, HYDROGENATION, LOW CARBON STEEL, CARBON STEEL

ABSTRACT: The low-cycle (plastic) fatigue of annealed low-carbon steel 08kp and of high-carbon steel ShKh15 was studied. The study extends the results of an earlier investigation by B. I. Tkachov and R. I. Kripyakovich (Fiziko-khimicheskaya mekhanika materialov, 1965, No. 6). The experimental procedure followed is described by V. I. Tkachov and Yu. I. Baboy (Fiziko-khimicheskaya mekhanika materialov, 1966, No. 2). The hydrogenation and corrosion of 2.5 x 5 mm specimens was carried out in 3% NaCl at a current density of 3 amp/dm². The experimental results are presented graphically (see Fig. 1). It was found that the decrease of plastic strength due to corrosion and hydrogenation bears a different character: corrosion leads to irreversible changes, whereas changes brought about

Card 1/2

L 42319-66

ACC NR: AR6020916

Fig. 1. Influence of the period, τ , of preliminary corrosion and hydrogenation on the number of cycles N for complete destruction of steel specimens G8kp (a) and ShKh15 (b) respectively. 1 - preliminary hydrogenation; 2 - same, but followed by two hours of aging at 100C; 3 - preliminary corrosion.

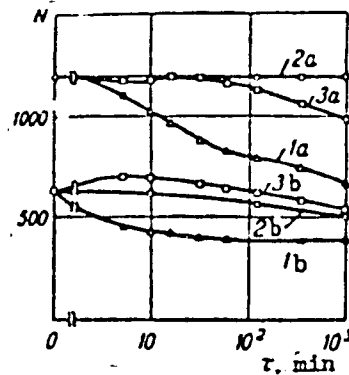

by hydrogenation may be reversed by hydrogen desorption. The rate and degree of strength recovery depend on the composition of the steel; carbon and alloying elements decrease the tendency towards recovery. It is suggested that plastic fatigue experiments constitute a more sensitive method for determining hydrogen than the rupture experiments. Orig. art. has: 2 graphs.

SUB CODE: 11/ SUBM DATE: 19Jan66/ ORIG REF: 004

Card 2/2 *ldh*

L 04911-67 EFT(d)/EFT(m)/EFT(w)/EFT(t)/EFT(c) EFT(d) EFT(d)
ACC NR: AP6029688 SOURCE CODE: UR/0369/66/002/004/0464/0467

AUTHOR: Tkachev, V. I.; Kripyakevich, R. I.; Kuslitskiy, A. B.; Kreymerman, G. I.

(RG: Physics-Engineering Institute, AN UkrSSR, L'vov (Fiziko-mekhanicheskiy Institut AN UkrSSR)

TITLE: Effect of stress concentration on low-cycle fatigue in media

SOURCE: Fiziko-khimicheskaya mekhanika materialov, v. 2, no. 4, 1966, 464-467

TOPIC TAGS: stress concentration, material deformation, corrosive strength, hydrogenation, cyclic strength, fatigue strength

ABSTRACT: The effect of the amplitude of total deformation, ϵ , and of stress frequency, ν , on the low-cycle fatigue of specimens was studied with concentrators of stress, represented by 1 mm holes in the flat samples. The latter were tested in air and in corrosive and in hydrogenating environments. Concentration of stress resulted in a marked decrease of service life under low-cycle fatigue as compared with conditions of uniform stress distribution. The value $N(\epsilon)$, N being the number of cycles, showed the same basic dependence upon conditions as under uniform stress. The value of critical deformation decreased at a concentration of

Card 1/2

L 01941-67

ACC NR: AP6029688

stress. The dependence of the effective coefficient of stress concentration on deformation amplitude and stress frequency was determined by the ratio of the environment factors for uniform stress and concentrated stress, respectively. Orig. art. has: 3 figures.

SUB CODE: 11/ SUBM DATE: 03Mar66/ ORIG REF: 001/ OTH REF: 011

kh

Card 2/2

MALINOVSKIY, F. F.

PA 30/4978

USSR/Chemistry - Friedel-Crafts Reaction Sep 48
Chemistry - Ketones, Synthesis

"Synthesis of Aliphatic-Aromatic Ketones by
Friedel-Crafts Reaction," M. S. Malinovskiy, F. F.
Kuslova, Stud, Lab Org Chem, Gor'kiy State U, 2pp

"Zhur Obshch Khimii" Vol XVIII, No 9

Using acids instead of their anhydrides or acyl
chlorides in reactions with toluene, 27-36%
yields of p-tolyl alkyl ketones were obtained in
presence of aluminum chloride. Acids included
acetic, butyric, isobutyric, and isovaleric.
Submitted 9 May 47.

30/4978

NEKHAYEV, S.; KUSLYAK, V.

Strengthen control over the operation of specialized subcontractors.
Fin. SSSR 17 no. 10:60-62 0 '56. (MLRA 9:11)
(Construction industry--Finance)

KUSLYAKOV, B.A.

KUSLYAKOV, B.A.

Modification of conditioned vestibulo-motor reflexes following
labyrinthectomy in dogs. *Fiziol.zhur.* 43 no.3:271-278 Mr '57.

(MIRA 10:8)

1. Laboratoriya interotseptivnykh uslovykh refleksov Instituta
fiziologii im. I.P.Pavlova AN SSSR, Leningrad

(LABYRINTH, effect of excision,

on vestibulo-motor conditioned reflexes in dogs (Rus))

(REFLEX, CONDITIONED,

vestibulo-motor, eff. of labyrinthectomy (Rus))

(VESTIBULAR APPARATUS, physiology,

vestibulo-motor conditioned reflexes in labyrinthectomized
animals (Rus))

KUSMAN, Ye. (Minsk)

A homemade spring clamp. Radio no.12:27 D '62.
(Springs (Mechanism))

(MIRA 16:3)

L 23614-66 EWT(d)/EWP(v)/EWP(k)/EWP(h)/EWP(l)

ACC NR: AP6009554

SOURCE CODE: UR/0413/66/000/005/0109/0110

AUTHOR: Raykhman, Ya. A.; Kusman, Ye. A.; Kuz'michev, G. P.

ORG: none

11

TITLE: A micromanipulator. Class 49, No. 179586

13

SOURCE: ¹⁴ Izobreteniya, promyshlennyye obraztsy, tovarnyye znaki, no. 5, 1966, 109-110

TOPIC TAGS: micromanipulator, microdissection, microinjection, electromagnet

ABSTRACT: This Author's Certificate introduces: 1. A micromanipulator for moving a tool in three dimensions by a control lever hinged to the framework with a drive connected to a two-coordinate table which supports the tool and a handwheel which moves in the horizontal plane on a plate in the framework. The device is designed for fast preliminary motion and exact adjustment of the tool by making the drive from the control lever to the two-coordinate table in the form of a system of two separately connected electromagnets: one for coarse and one for fine motion. The first electromagnet is connected through a hinge to the control lever and the second is connected to a pantograph. One of the hinges on the pantograph is connected to the electromagnet for coarse adjustment and the other is connected to the framework. 2. A modification of this micromanipulator in which the two-coordinate table may be fixed in a definite

UDC: 621.86.076

Card 1/3

12

L 23614-66

ACC NR: AP6009554

1--magnet for coarse motion; 2--magnet for fine motion; 3--clamping magnet; 4--pantograph mechanism; 5--armature of the clamping magnet; 6--working table; 7--roller; 8--pulley; 9--cable; 10--control handwheel; 11--ring; 12--cam

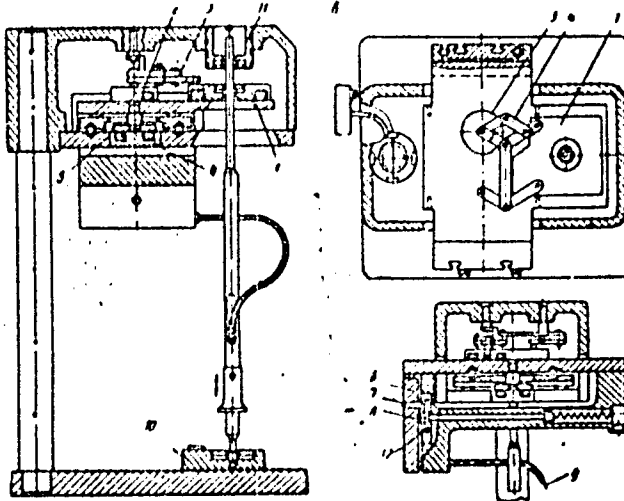

position by a clamping electromagnet in the framework. This electromagnet acts on an armature which is mounted on the two-coordinate table and connected to the electromagnet for coarse and fine adjustment in such a way that both these electromagnets are

Card 2/3

L 23614-66

ACC NR: AP6009554

disconnected when the armature is connected. 3. A modification of this micromanipulator in which the tool is moved in the vertical plane by a special mechanism made in the form of a working stage. This stage is supported by a roller on a specially shaped cam in the framework with a pulley which is connected by a cable to the control hand-wheel. 4. A modification of this micromanipulator in which the scale of motion for the two-coordinate table is preset by changing the lever arms. In the framework is a threaded ring with a ball support for the control lever.

SUB CODE: 13/

SUBM DATE: 19Aug63/

ORIG REF: 000/

OTH REF: 000

Card 3/3 *FV*

KUSMARTSEV, V. S.

Kusmartsev, V. S. "It is time to produce high-quality textbooks on general technical disciplines", Vestnik vyssh. shkoly, 1949, No. 5, p. 14-17.

SO: U-4630, 16 Sept. 53, (Letopis 'Zhurnal 'nykh Statey, No. 23, 1949).

AUTHOR: Kusmartsev, V. S., Dotsent 3-5-10/38

TITLE: Questions of Instruction Relating to the Course "Machine Parts"
(Voprosy prepodavaniya kursa "Detali mashin")

PERIODICAL: Vestnik vysshey shkoly, Nr 5, 1957, p 32-33 (USSR)

ABSTRACT: The existing textbooks and school aids for the Machine Parts course were prepared for machine building vuzes and tekhnikums, and, therefore, do not meet the program requirements of other vuzes and tekhnikums giving the above mentioned course. For this reason Professor N. A. Spitsyn's recommendation to prepare special textbooks designed to fulfill the program requirements of separate schools is justified.

ASSOCIATION: The Stalingrad Engineering Institute of Urban Economy (Stalingradskiy institut inzhenerov gorodskogo khozyaystva)

AVAILABLE: Library of Congress

Card 1/1

PHASE I BOOK EXPLOITATION

SOV/5306

Kusmartsev, Vasilii Sergeyevich

Avtomatika proizvodstvennykh protsessov (Automation of Industrial Processes) [Rostov-na-Donu] Rostovskoye knizhnoye izd-vo, 1960. 95 p. 2,000 copies printed.

Reviewers: V. A. Obratsov and A. F. Rakov; Ed.: I. V. Zhrebkov;
Tech. Ed.: Ye. A. Abramova.

PURPOSE: This booklet is intended for personnel working in branches of industry which use automatic devices. It may also be useful to students of technical institutions of higher education and *tekhnikums*.

COVERAGE: The booklet deals briefly with the theory and design of hydraulic, pneumatic, electric, and combined automatic regulators and their components. The various fields of application of automatic devices are also considered. No personalities are mentioned. There are 9 references, all Soviet.

Card 1/4

KUSMARTSEVA, L.V.

Surgical setting of an old dislocation of the basilar phalanx
of the second finger of the right hand. Zdravookhranenie 4
no. 1:53-55 Ja-F '61. (MIRA 14:2)

1. Iz kafedry obshchey khirurgii (zav. - prof. N.L. Gladyshevskiy)
Kishinevskogo meditsinskogo instituta.
(FINGERS--DISLOCATION)

KUSMARTSEVA, L. V.

"Ischemic Disorders in Intra-arterial Blood Transfusion"

report submitted at the Society of Surgeons of the Moldavian SSSR, 1960

So: Zdravookhraneniye, Kishinev, No. 2, March-April 1961, pages 61-64

VELIKORETSKIY, D.A.; LORIYE, K.M.; FINKEL', I.I.; GRIGORCHUK, Yu.F.;
BERGER, L.Kh.; UTROBINA, V.V.; KHARCHENKO, V.P.; MESHCHERYKOV, A.V.,
student V kursa; OBEREMCHENKO, Ya.V., kand.med.nauk; NIKITIN, A.V.;
MUKHOYEDOVA, S.N.; KUSMARTSEVA, L.V., assistant; KUZNETSOV, V.A.,
dotsent; KUKHTINOVA, R.A., assistant; BONDARENKO, Ya.D. (g. Fastov);
KUNTASOVA, L.V. (g. Fastov); PEVCHIKH, V.V.; CHURAKOVA, A.Ye.;
BABICH, M.M.; KUZ'MIN, K.P.; PAVLOV, S.S.; SHEVLYAKOV, L.V., kand.
med.nauk; IGNAT'YEVA, O.M.; ZEYGERBAKHER, G.A.; GUTKIN, A.A.;
POLYKOVSKIY, T.S.

Resumes. Sov.med. 25 no.11:147-152 N '61.

(MIRA 15:5)

1. Iz Instituta grudnoy khirurgii AMN SSSR (for Velikoretskiy, Loriye, Finkel').
2. Iz bol'nitsy No.3 Gorlovki Stalinskoy oblasti (for Grigorichuk).
3. Iz Tyumenskoy oblastnoy bol'nitsy (for Berger, Utrobina).
4. Iz Karatasskoy rayonnoy bol'nitsy Yuzhno-Kazakhstanskoy oblasti (for Kharchenko).
5. Iz Gospital'noy khirurgicheskoy kliniki I Moskovskogo ordena Lenina meditsinskogo instituta imeni Sechenova (for Meshcheryakov).
6. Iz kliniki propedevticheskoy terapii Stalinskogo meditsinskogo instituta na baze oblastnoy klinicheskoy bol'nitsy imeni Kalinina (for Oberemchenko).
7. Iz kliniki gospital'noy terapii Voronezhskogo meditsinskogo instituta (for Nikitin, Mukhoyedova).
8. Iz kafedry obshchey khirurgii kishinveskogo meditsinskogo instituta (for Kusmartseva).

~~(Continued on next card)~~

BUDAGYAN, I.N., insh.; KUSMAUL', K.V., insh.

Kaluga Synthetic Perfume Combine. Masl.-zhir. prom. 23 no.12:11-13
'57. (MIRA 11:?)

(Kaluga--Perfumes, Synthetic)

KUSMAUL', Konstantin Vasil'yevich; MOISEYENKO, A., red.; GALITSKIY, B.,
tekhn.red.

[Synthetic Odorous Substances Combine is an enterprise of
collective efficiency promotion] Kombinat SDV - predpriatie
kollektivnoi ratsionalizatsii. Kaluzhsk, Kaluzhskoe knizhnoe
izd-vo, 1958. 62 p. (MIRA 12:9)
(Odorous substances)

BUDAGYAN, S.A.; KUSMAUL', K.V.

Prospects for the development of the Kaluga Combine of Synthetic
Perfumes. Masl.-shir.prom. 25 no.2:7 '59. (MIRA 12:2)
(Kaluga--Perfumes, Synthetic)

KUSMAUL', K.V.; KANNER, B.L., red.; SPERANSKAYA, A.A., tekhn.red.

[Safety measures in the maintenance and repair work in chemical plants] Tekhnika bezopasnosti pri remontnykh rabotakh v khimicheskikh tsekhakh. Moskva, Gos.nauchno-tekhn.izd-vo khim.lit-ry, 1960. 59 p. (MIRA 13:9)

(Chemical plants--Safety measures)

KUSMAUL', K.V., inzh.; SOSNOVSKIY, N.Kh.

Barrel tilter. Masl.-zhir.prom. 28 no.4:42-43 Ap '62.
(MIRA 15:5)

1. Kaluzhskiy kombinat sinteticheskikh dushistykh veshchestv.
(Material handling--Equipment and supplies)

KUS'MENKO, K.N.; PLUZHNIKOV, V.Kh.

Lunar occultations of stars observed at the Kharkov Observatory in
1959. Astron. tsir. no.208:29-30 Ja '60. (MIRA 13:11)
(Occultations)

BOGOLEPOV, Yu., inzh.; KUSMERSKIY, F., inzh.

International testing of land improvement machinery. Tekh.v sel'khoz.
21 no.3:44-46 Ag '61. (MIRA 14:7)
(Agricultural machinery--Testing)

24(5)

FRANS I BOOK EXPLOITATION 807/1944

Научный институт горного дела

Научные проблемы развития и рационального использования полезных ископаемых (Scientific Problems in Developing and Exploiting Mineral Deposits) Moscow, Izd-vo AN SSSR, 1959. 111 p. 3,000 copies printed. Prints slip inserted.

Reep. No. 1. N.V. Mal'nikov, Corresponding Member, USSR Academy of Sciences; Ed. of Publishing House: Yu.F. Vasil'yev; Techn. Ed.: P.S. Lashina.

Summary: This book is intended for coal and ore mining engineers. Coverage: The collection of articles reports on the results of scientific studies conducted by members of the Institute of Mining in the USSR on problems of developing and exploiting mineral deposits. The book is divided into two parts. Part I treats the development and exploitation of coal deposits, the scientific bases and principles applied in exploitation methods, and methods for different natural conditions in selecting exploitation in underground deposits in the use of modern mechanized methods of coal. Part II is devoted to problems in the development and exploitation of ore deposits, the draining and mining methods used in underground deposits in the area of the Kuznetsk Basin (Kuzak Magnetskie Zemli), the open pit mining method used in exploiting the rich DTA area, the determination of size of ore, and further ore dressing. The book is dedicated to Academician Lev Dmitriyevich Zhelezakov, mining engineer. The articles are accompanied by diagrams, tables, and bibliographic references.

TABLE OF CONTENTS:

Scientific Problems (Cont.)	807/1944
Shuryayev, I.P. Certain Observed Regularities in Ground Swelling in Preliminary Shaft Work in the Donbas	103
Trumbacher, V.P., and L.A. Zhorykin. Study of Wall Stress Conditions for Mechanized Support in the Donbas (Moscow Basin)	111
Salomolais, V.I. Analytical Method of Determining the Basic Parameters for Coal Shafts	124
Rosenzweig, B.A. Technique of Determining the Length of a Longwall for Flat Coal Seams of Small and Moderate Thickness	136
Rus'kikh, I.A. Establishing Emillage Parameters in Hydraulic Coal Exploitation of Flat Seams of Average Thickness	152
Burakov, A.M. Variable Factors in the Development of an Area by Cutting Shafts, Headings, or Stallroads	165
Goussier, A.A. Selective Approach in Working Stopes on Steeply Pitching Seams in the Donbas	177

Cont 2/7

~~10(2)~~ KUZ'MICHEV, K. V.

10(2)

PHASE I BOOK EXPLOITATION SOV/1308

Kirillov, Ivan Ivanovich, Rakhmiyel' Mordukhovich Yablonik, Lev Vasil'yevich Kartsev, Ivan Grigor'yevich Gogolev, Ryurik Vladimirovich Kuz'michev, Gennadiy Ivanovich Khutskiy, Rostislav Ivanovich D'yakonov, Viktor Dmitriyevich Pshenichnyy, and Aleksandr Aleksandrovich Tereshkov

Aerodinamika protochnoy chasti parovykh i gazovykh turbin (Aerodynamics of Steam and Gas Turbine Flow-Passage Areas) Moscow, Mashgiz, 1958. 246 p. 4,500 copies printed.

Ed.: Kirillov, I.I., Professor, Bryansk Institut of Transport Machine Building; Reviewer: Shubenko, L.A., Corresponding Member, USSR Academy of Sciences; Tech. Ed.: Gerasimova, D.S.; Managing Ed. for Literature on General Technical and Transport Machine Building (Mashgiz): Ponomareva, K.A., Engineer.

PURPOSE: This book was written for engineers working on the design,

Card 1/6

Aerodynamics of Steam and Gas Turbine Flow-Passage Areas SOV/1308

manufacture and operation of steam and gas turbines. It may also be useful to students of special courses.

COVERAGES: The authors analyze physical phenomena connected with flow through the stages of impulse steam and gas turbines. They give the results of experimental investigation of stages with full and partial supply of the working medium. The basic results obtained are for high - and medium-powered turbines. Results of the investigation of a new low-powered turbine are also given. Practical recommendations for the design of the flow passage area of steam and gas turbines are given, based on the investigation of effect of various design measures on the efficiency coefficient of stages. The investigation was made in the BITM (Bryansk Institute of Transport Machinery Building). The following sections were written by members of the Chair of Turbine Construction of the BITM: Professor I.I. Kirillov, Docent, Candidate of Technical Sciences, paragraphs 1, 2, 13, 16; Docent

Card 2/6

Aerodynamics of Steam and Gas Turbine Flow-Passage Areas SOV/1955

R.M. Yablonik, Candidate of Technical Sciences, paragraph 9; I.I. Kirillov and R.M. Yablonik, paragraphs 3, 4, 5; L.V. Kartsev, Candidate of Technical Sciences, paragraphs 6, 7, 19; L.V. Gogolev, Candidate of Technical Sciences, paragraphs 10, 11; R.V. Kuz'michev, Candidate of Technical Sciences, paragraph 8; G.I. Khutskiy, Candidate of Technical Science, paragraphs 12, 14, 15; R.I. P'yakov, paragraph 17; V.D. Pshenichnyy, Engineer of the Kirov Plant, paragraph 18; A.A. Tereshkov, Engineer of BITM, paragraph 19. The Leningrad Metal Plant, Khar'kov Turbine Plant, Kabush Turbine Plant and Leningrad-Kirov Plant contributed to the development of experimental work on turbines for BITM. The bibliography consists of 23 references, 22 of which are Soviet, and 1 is German.

TABLE OF CONTENTS:

Preface

3

Card 3/5

Aerodynamics of Steam and Gas Turbine Flow-Passage Areas 307/1300

Principal Symbols 5

Ch. I. Experimental Stands and Testing Methods 9

- 1. Problems of experimental testing of the flow-passage area of a turbine 9
- 2. For air breathing experimental turbines 12
- 3. Method of investigating rotating models of turbine stages 21

Ch. II. Stages With a Full Supply of the Working Medium 39

- 4. The degree of reaction and the escape of steam in stages of an impulse type 39
- 5. Effect of special design features of impulse turbine stages on losses of energy 55
- 6. Structure of the flow in open axial clearances in a stage of an impulse turbine 84
- 7. Structure of the flow with steam induction at the root of an impulse stage 97

Card 4/6