

COUNTRY Soviet Union REPORT NO.

TOPIC Observations in Moscow-Khimki

25X1A

25X1A

EVALUATION [redacted] PLACE OBTAINED [redacted]

DATE OF CONTENT [redacted] 25X1C 25X1A

DATE OBTAINED [redacted] DATE PREPARED 31 May 1950

REFERENCES

PAGES 5 ENCLOSURES (NO. & TYPE) 1 sketch on ditto

REMARKS



25X1X

1. Plant No 301

a. Location: On the western border of Moscow-Khimki air-field.

b. Plant history: The plant had a branch plant in Mybinsk. Before the war small fighters were built. [redacted] not know whether this production was continued.

25X1A

c. The plant was managed by a Soviet general.

d. Work force: 500 in each of the three shifts and 100 IV's employed in the morning shift only.

e. Rate of production: No details available. Several aircraft shipments left the plant every week by rail. The engines were delivered from Mybinsk.

f. Description of the aircraft type produced in Plant No 301: Probably a fighter trainer, fitted with a radial engine, four-bladed propeller, low-wing monoplane with straight wings and rounded wing tips. Single-rudder assembly mounted at rear of fuselage, about 40 cm high. Elevator assembly formed as rear end of fuselage, same figuration as wings. One-axle landing gear retracting rearward, tail wheel; front section of fuselage considerably shorter than section aft of wings. Cockpit beginning at leading edge of wings fairing into fuselage;

CLASSIFICATION CONFIDENTIAL [redacted]

25X1A

ILLEGIB

Approved For Release 2002/08/15 : CIA-RDP83-00415R010900070007-6

Approved For Release 2002/08/15 : CIA-RDP83-00415R010900070007-6

CONFIDENTIAL-

[Redacted]

25X1A

5. Plant No 456:

Production of V-2 propellant charges.

6. Plant No 293: Located between Plant No 456 and the launching tower, experiments with booster propulsion units attached to the undersides of single and twin-engine conventional aircraft.

25X1A

[Redacted] Comment: The factual report confirmed previous information on the Ohimki plants. ** In previous reports it was stated that besides V-1 fuselages also Yak-7 aircraft were being produced.

[Redacted]

25X1A

c. The data on Plant 456 [Redacted] [Redacted] are confirmed. The schematic location sketch is also in agreement with previous information.

25X1A

25X1A

25X1A

25X1A

* [Redacted] Comment: [Redacted] the old German V-2 was being built in the plant, but that experiments for a new composition of the propellant charges were being made at the laboratory.

CONFIDENTIAL-

[Redacted]

25X1A

CONFIDENTIAL

[REDACTED]
1/Annex

25X1A

Legend to Annex:

- 1 Workshop
- a Administration, two stories
 - b Magazine
 - c Lane dividing the installation into two sections
 - d Workshop in which about 30 new German machine tools were installed about the Summer of 1948 (lathes, milling and boring machines).
 - e [REDACTED] laboratory
 - f [REDACTED] bureau
 - g Room with apparatus, no details available
 - h Workshop with about 20 lathes and presses. Cylindrical aluminum bodies were manufactured. No details available.
 - i Instruction room furnished with six V-2s which arrived from Germany in late 1947. German and Soviet engineers daily experimented with the V-2s.
- 2 Boiler house
- 3 Propellant charges laboratory
- 4 Launching tower extending 3 meters below ground and 9 meters above. The tower was 6 meters square and of reinforced concrete. A winding stair led to a point two thirds up the tower from where gangways led to the two compartments furnished with a large number of measuring instruments. Above these compartments were two rooms furnished with one aluminum container each 2 meters high and 1½ meters in diameter. The container, the contents of which were unknown, were connected to the compartments below. The V-2 propellant unit was cylinder shaped and tapered to one end. The unit was of aluminum and had many aluminum tubes and other devices attached to it.
- 5 A bunker with a surface area 10 x 6 meters filled with steel bottles and measuring instruments was beside the launching tower.

25X1X

25X1X

CONFIDENTIAL

[REDACTED]
25X1A



CONTROLLED DISTRIBUTION

Annex to (

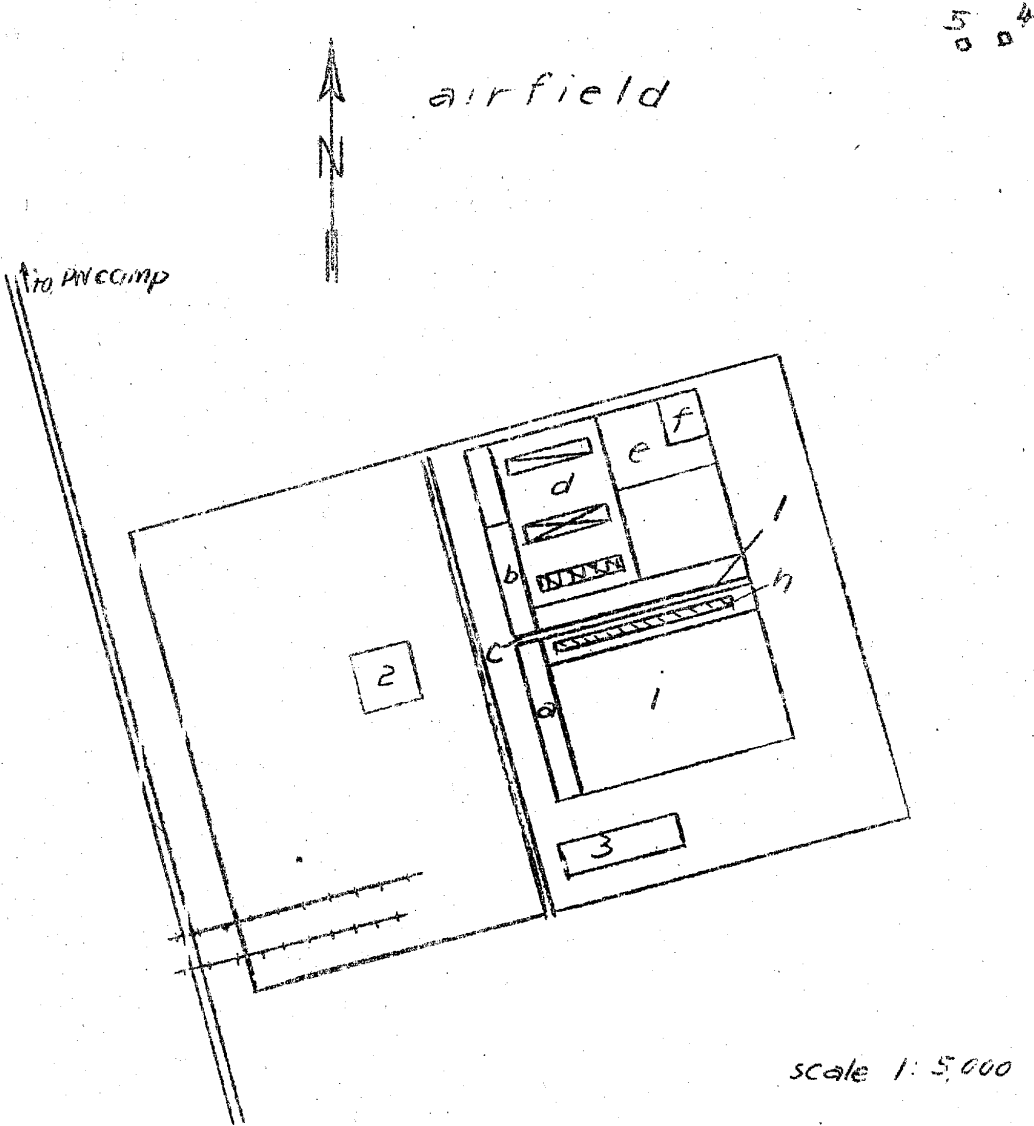
Layout Sketch of the V-weapons Plant in Moscow-Khimki

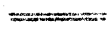
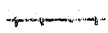
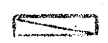
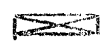

scale 1:5,000

-  Streets
 -  Spurtracks
 -  Lathes
 -  Boring machines
 -  Milling machines
 -  Small lathes
- Legend: See report

CONFIDENTIAL

SECRET

COUNTRY Soviet Union REPORT NO. _____
TOPIC Airframe Plant No 23 in MOSCOW - MILIT

EVALUATION 25X1A PLACE OBTAINED 25X1A

DATE OF CONTENT 25X1C

DATE OBTAINED 25X1C DATE PREPARED 20 December 1949

REFERENCES _____

PAGES 2 ENCLOSURES (NO. & TYPE) _____

REMARKS _____

25X1X

1. Location: See references.
2. Construction work: Only repair work on damaged buildings was observed.
3. Equipment with machinery: In early 1946 the machinery was returned from the Ural Mts. It was supplemented by dismantled German machinery and US equipment.
4. Work force: Civilian workers and uniformed engineers and air force officers in equal numbers.
5. Production: *
 - a. Three twin-engine aircraft per day.

Description: Midwing monoplane, radial engine, double rudder assembly, glazed nose turret fitted with a machine gun pointing rearward, turret about the length of the wing chord. A step fitted with a machine gun was visible between the wings and the rear of fuselage. Main landing gear with dual wheels, tail wheel.

b. Assembly of radial engines. _____ production of tail units in this workshop. An officers' school was established in this workshop early in 1948. Aircraft models were taken into the workshop _____ for this purpose. 25X1A

6. Various aircraft observed _____ 25X1A

- a. Two helicopters, which seldom flew.
- b. Various experimental aircraft (designated as such by the Soviets), including a jet fighter.
- c. A four-engine bomber, which was said to be produced as a prototype in the plant _____ 25X1X

_____ 25X1A
CLASSIFICATION SECRET _____

SECRET

2

25X1A

25X1A

a. The capacity of the plant was not exhausted by the production of three aircraft per day. The presence of the many engineers and officers and of the experimental aircraft either indicated the conversion of the plant to a developmental plant or the establishment of a technical school.

b. The output in the assembly hall was so small that possibly only repair work was performed there.

c. Standard work quotas were not prescribed. At special workers' meetings the necessity for high quality work was stressed. This would support the assumption of an experimental plant.

25X1A

Comment:

a. The production at the MOSCOW-BILL Aircraft Plant No 23 of TU-2 aircraft or of a modified version, (further development of this type) is confirmed for early 1948. The production of three aircraft daily is considered correct for that date.

b. The conspicuous step mounted on the lower side of the fuselage was mentioned in other reports as a ventral turret for machine gun. This would indicate a modification in the design of the fuselage, since this step, or turret, was not observed with the first aircraft of this type.

c. So far the production of experimental aircraft has not been reported although such a production is possible.

d. The most probably interpretation of the data of this report seems to be that the pertinent aircraft were models required for the technical school apparently established there. Flying with four-engine aircraft or jet fighters is hardly possible considering the 3,300-foot runway of the airfield which is not adaptable to expansion.

25X1A

SECRET

25X1A

WIRELOX 10

COUNTRY Soviet Union REPORT NO. _____

TOPIC Dzerzhinski Locomotive Repair Plant in VORONEZH

EVALUATION 25X1A PLACE OBTAINED _____

DATE OF CONTENT 25X1C 25X1A _____

DATE OBTAINED _____ DATE PREPARED 18 January 1950

REFERENCES _____

PAGES 1 ENCLOSURES (NO. & TYPE) 2 blueprints

REMARKS _____

25X1X

[Redacted box]

1. Location:

On the northern side of the freight station of VORONEZH (39°12'N/51°40'E), Voronezh Oblast (see Annex 1).

2. Plant installations:

The plant covers a site of 2,700 x 900 feet. The installations were partly destroyed during the war. Some of the plant departments had resumed production as early as September 1945. A power station has been under construction since 1947, an administration building since 1949. The latter is not yet equipped (for plant layout see Annex 2)

3. Work force:

About 3,000 Soviet workers, including 40 percent women in addition to 150 P's employed for construction purposes.

4. Mission:

General overhauling of locomotives.

25X1A

[Redacted] Comment:

a. Report and the attached sketches represent the latest status of the previously known locomotive repair plant in VORONEZH. The location of the plant is correctly stated. On aerial photograph [Redacted] the plant is entered under figure "V".

25X1A

b. The attached sketch (Annex 2) and its legend presumably present a correct picture of the location, size and type of construction of the individual plant installations. The sketch, with regard to all essential plant workshops, is in agreement with one attached to a previous report.

2 Annexes: 1. Location of the "Dzerzhinski" Locomotive Repair Plant in VORONEZH

2. Installation of the "Dzerzhinski" Locomotive Repair Plant,

CLASSIFICATION SECRET [Redacted]

25X1A

SECRET

25X1A

1/2/5/6/7/8

Refer to Annex 2

- 1 Three-story administration building, 180 x 90 feet with a 150-foot wing
- 2 Gas plant, 120 x 60 feet; [redacted] not yet in operation. [redacted] laying of pipe lines in the direction of the factory. The pipes had a diameter of about 2 1/2 feet.
- 3 Lathe department, 120 x 60 feet
- 4 Foundry, 180 x 90 feet, equipped with five furnaces. A forge was set up in the western section of the building.
- 5 Power station, 180 x 90 feet, equipped with three steam boilers and a large turbine. This turbine had previously been stored in the open and had apparently come from the BANGSBUK railroad repair shop, as inferred from its inscription. The transformer section is housed in the power plant.
- 6 Tenter department, 200 x 60 feet, with a row of horizontal coal-working machines.
- 7 Pressing shop, 100 x 60 feet, with a metal press 10 feet high. Sheet metal fittings for locomotives were pressed here.
- 8 Dress hall, kitchen and rest exchange, 120 x 75 feet.
- 9 Boiler forge
- 10 Assembly hall with large crane. Instructions and machine tools placed along the walls of the hall (buildings 9 and 10: 120 x 75 feet).
- 11 Coal dump
- 12 Scrap dump
- 13 Iron materials dump.

25X1X

25X1A

SECRET

25X1A

Location of the "Dzerzhinski" Locomotive Repair Plant
in VORONEZH

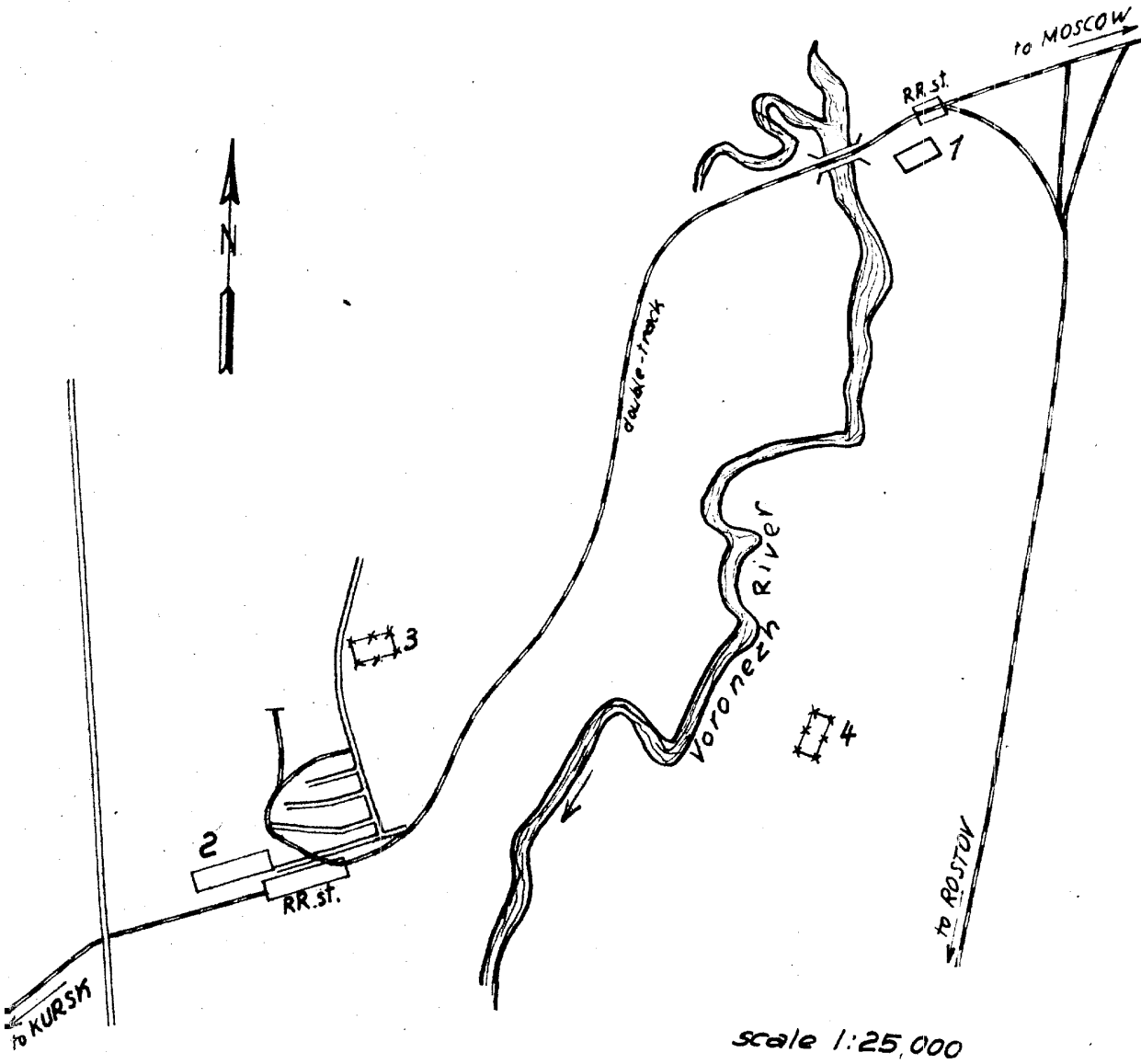

Legend:

- 1 Waggon repair plant
- 2 Locomotive repair plant
- 3 and 4 PW camps

CONTROLLED DISTRIBUTION

Annex 2
Approved For Release 2002/08/15 : CIA-RDP83-00415R010900070007-6

Installations of the "Dzerzhinski" Locomotive Repair Plant in VORONEZH

Legend: See report

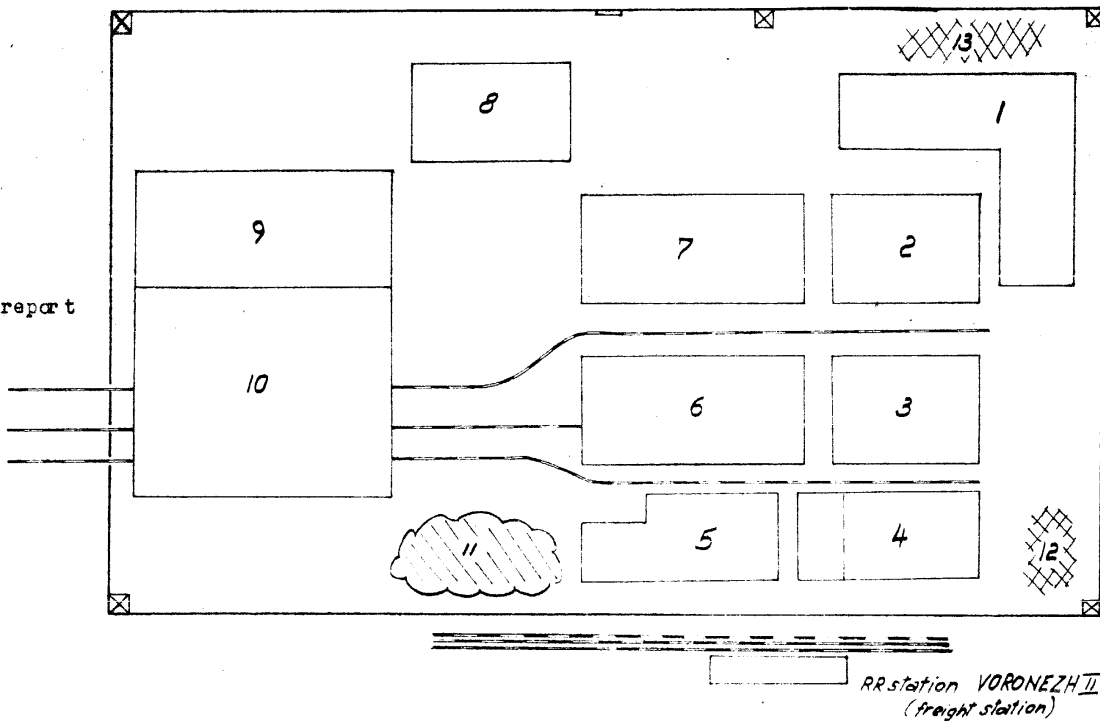

not to scale

COUNTRY Soviet Union REPORT NO.

TITLE Dzerzhinsk Locomotive Repair Plant in VORONEZH

25X1A

EVALUATION [] PLACE OBTAINED []

DATE OF CONTENT [] 25X1A []

DATE OBTAINED DATE PREPARED 28 November 1949

REFERENCES

PAGES 5 ENCLOSURES (NO. & TYPE) 1 Blueprint

REMARKS

25X1A
25X1A

25X1X

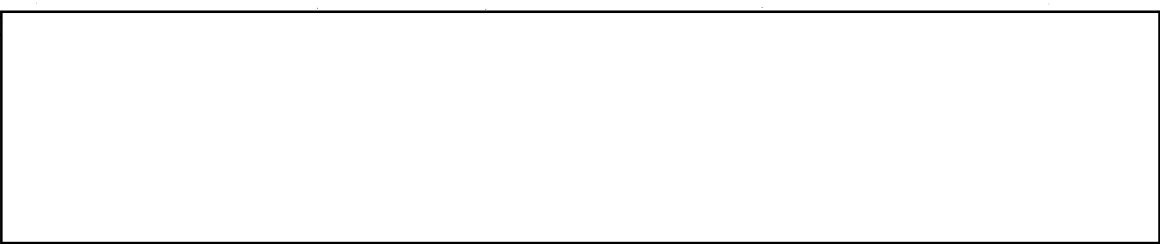

1. Location

At the northwest edge of VORONEZH (55°20'N/28°28'E).

2. Plant Area

About 500 acres.

3. Traffic Facilities

Double spur tracks leading to the main line (wide-gauge line) divided the plant in half. Only the part to the east was covered with buildings.

4. Plant Installations (the following enumeration corresponds to the numbers of the sketch).

Departments recorded:

(1) Assembly Shop

Completed in the Fall of 1946. Area: 650x260 feet. Installation: A heavy crane with an estimated 8-ton load capacity for dismounting and mounting of locomotive parts.

Some vertical turning and boring machines (of German and British make) and other machines had the inscription "RB-Ausbesserungswerk HALLE" (Reichsbahn Repair Plant in HALLE - II 52/D 92).

CLASSIFICATION

SECRET []

25X1A

25X1A

SECRET

2

Four wide-gauge tracks led into the workshop. Under these tracks were the assembly pits with drain pipes to the sewage system at the northern side of the workshop. The pits, 5 to 6 feet deep, extended over one third of the workshop.

(2) Old repairshop

Used for supplementary work such as welding, drilling and turning.

(3) New construction

It was completed in rough brickwork and said to be equipped with machines (lathes, etc.) from the DALLE Reichsbahn repair plant.

Tenders were scheduled to be repaired here.

(4) Water Basin

Used also for the supply of the power plant. Measurements: 650x650 feet at the top and 8 feet deep.

(5) Pipe system

Three iron pipes about 32 inches in diameter led from the water basin to the power plant. The pipes were supported on above-ground frames about 16 feet high.

(6) Power plant

Details are not available. Rough brickwork smoke stack, about 160 feet high. Completed early in 1947.

(7) New construction

This was not completed and covered an area about 26-x130 feet. It will allegedly serve to house the gas works.

(8a) through (8c) Workshop

It was the first workshop in operation (in 1944). No details are available.

5. Work force and working time

About three hundred Soviet workers. Work was done in three eight-hour shifts.

6. Production

a. Locomotives and tenders were repaired. The locomotives (generally designated Lizenz locomotives) had 10 axles, 4 having wheel sets 6 feet in diameter, 6 axles had wheel sets of smaller dimensions. They were marked "F 20".

The tenders of the locomotives had four (perhaps six or even eight) axles and small wheels. The tenders were modern and suitable for long runs. The coal was supplied to the locomotive by a spiral conveyor. The locomotives and tenders were mounted on undercarriages built for Russian wide-gauge tracks. [redacted] this design requires a higher coal consumption than that of the German express train locomotives.

25X1A

SECRET

25X1A

25X1A

SECRET [REDACTED]

b. Three to four locomotives were repaired simultaneously in workshop No. 1 in three or four days, if no other repair work was done. Repair work normally consisted of cleaning and de-rusting boilers and pipes. New pipe parts were installed and locomotives repainted, if required. The repaired locomotives left the workshop and the plant under their own power.

25X1X

7. Location

Opposite the VORONEZH (55°20'N/28°38'E) passenger railroad station.

8. Plant Area

About 1,500 x 650 feet.

9. Traffic Facilities

Four tracks to the main line.

10. Plant History

The plant existed before World War I as indicated by British workshop constructions of 1911. The Soviets destroyed the plant when they retreated in World War II. Reconstruction started in 1944 and production was resumed at the end of 1946.

11. Plant Installations (the following enumeration corresponds to the numbers of the sketch)

Only one sketch was made [REDACTED]

25X1A

Departments recorded:

(1) Assembly shop

Steel frame structure with two track installations, 300x150 feet. Installation: Assembly pits were under the tracks. There were two ceiling traveling crabs. Machine tools were on both sides of the workshop.

(2) Workshop for dismantling locomotives

A steel frame structure, 300x115 feet. Two ceiling traveling crabs.

(3) Workshop

Carpentry, depot for instruments and punching shop.

(4) Cooling water basin

SECRET [REDACTED]

25X1A

25X1A

SECRET [REDACTED]

4

(6) Power plant
A four-story stone building; 80x50 feet. A new turbine was installed in the Summer of 1947.

(5) Water pipeline to the power plant

Still under construction.

(7) Gas works with coke production

(8) Workshop building

a. Mechanical workshop. Installation: automatic machines, turret lathes, horizontal and vertical drilling machines, milling machines and planers.

b. Repairshop for tenders. Installation: Two ceiling cranes.

c. Destroyed workshop section.

12. Work Force and Working Time

About 250 P's employed in one day shift mainly for reconstruction work. Soviets worked in the production departments in three 8-hour shifts.

13. Production

a. Repair work (including boiler repairs) on freight train locomotives of the types FD-20, FD-21 and FD-22 (with one set of small running wheels, five sets of large driving wheels and one six-axle tender).

b. Work on four to six locomotives was done simultaneously. After repair, about five locomotives were coupled and towed out of the workshop by one engine.

December 1945 to December 1949

14. Output for October 1947: 27 heavy locomotives.

Until early May 1948

15. Locomotive repairs, turning of wheels and mounting of tires. [REDACTED] also mentioned a forge, a lathe shop and a hardening shop. [REDACTED]

25X1A

July 1946 to September 1948

16. Monthly output in 1948: 18 to 25 locomotives.

June 1945 to March 1949

17. Monthly output: 23 locomotives, mainly long-distance locomotives "J3".

25X1A

SECRET [REDACTED]

25X1A

SECRET-

[REDACTED]

25X1A

5

25X1A

[REDACTED] Comment:

The reports confirm and supplement each other in all essential points.

25X1A

[REDACTED]

1 Annex: Plant Layout of the Dzerzhinsk Locomotive Repair Plant in VOROZHEH

SECRET-

[REDACTED]

25X1A

Plant Layout of the "Dzerzhinsk" Locomotive Repair Plant in VORONEZH

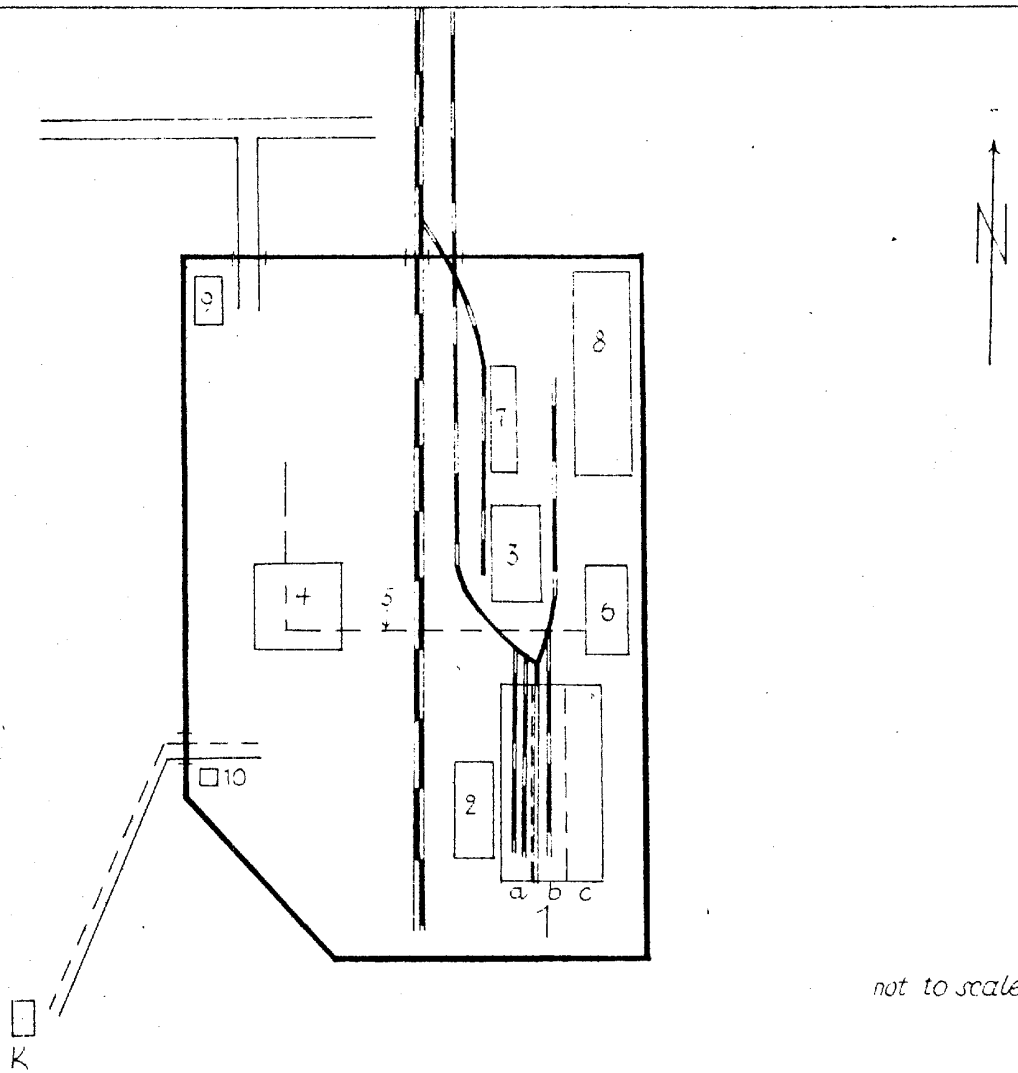

Legend:

- 1 New locomotive repair shop
- 2 Old locomotive repair shop
- 3 New tender repair shop
- 4 Square-shaped water basin
- 5 Pipe system (triple pipe set) aboveground and underground
- 6 Power plant with new smokestack
- 7 Building under construction, gas works
- 8 Old workshop
- 9 Guardhouse
- 10 Sentry-box
- K Kitchen for PWs

INTELECON

COUNTRY: Soviet Union REPORT NO. _____

TOPIC: Komintern Redger Plant in Voronezh

EVALUATION: [] 25X1A PLACE OBTAINED: [] 25X1A [] 25X1A

DATE OF CONTENT: [] 25X1C

DATE OBTAINED: [] 25X1C DATE PREPARED: 31 May 1950

REFERENCES: _____

PAGES: 2 ENCLOSURES (NO. & TYPE): 2 sketches on ditto

REMARKS: _____



25X1X

1. Location:

In the northwestern town section of Voronezh (39°12' E / 51°40' N), Voronezh Oblast, north of the Electro-signal Plant and west of an arterial road to the north-northwest.

2. Plant installations:

The reconstruction of the plant, destroyed by the retreating Soviets, started in 1945. The plant designation was to be changed in 1948 but it was again called Komintern in 1949. Some plant buildings were still under construction in April 1949. Most of the plant buildings were iron frame structures with brickwork or concrete and roofs of concrete slabs. The modern machinery was of American, Czech and German origin. The building of the factory-owned power plant was completed in March 1949 and one of the two projected turbines was fitted. The steel foundry had two manually fired open-hearth furnaces. For plant layout see annex.

3. Work force:

No details available.

CLASSIFICATION: CONFIDENTIAL

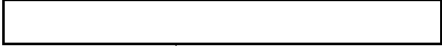

25X1A

CONFIDENTIAL

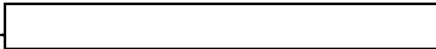

25X1A

- 2 -

4. Production:

Mass production of caterpillar power shovels and all component parts except for electric motors. Shovel capacity 1 cbm. The annual output in 1948 was 50 power shovels.** The plant also produced caterpillar chassis, rotating rings, chain links and cog wheels. For sketch of power shovel see Annex 10.2.

25X1A

*



Comment:

The report confirms and supplements previous information on the plant, the location of which is sufficiently determined from war-time and post-war records.

25X1A

**



Comment:

Annex 2 is a valuable sketch of the power shovel produced at the plant. The attached sketch essentially agrees with a previous sketch but gives more details.

2 annexes, sketches on ditto.

CONFIDENTIAL



25X1A

CONFIDENTIAL

25X1A

- 1 -

Legend to Annex 1:

- 1 Plant kitchen
- 2 Tool department, solidly constructed stone building with iron-structure roof, 60x15x6 meters
 - a Administration and management office annex
- 3 Three-story laboratory under construction, 45x14 meters
- 4 Projected garage and gasoline filling station for 15 trucks
- 5 Steel foundry, 160x45 meters with two open-hearth furnaces, 4x8x10 meters
- 6 Cast iron foundry, 140x50 meters, first half completed in March 1949, second half to be completed in early 1950. Equipped with two cupola furnaces, a transformer for two planned electric furnaces, molding shop with two dies, two electric cranes of 20-ton capacity and railroad track the length of the building.
- 7 Workshop, 100x30 meters with model-making carpenter shop and apartments, completed in 1947. Installations were often changed; was planned to be assembly shop
- 8 Assembly shop, steel structure, 80x30 meters under construction
 - a Transformer station with four transformers
- 9 Forge, 80x12 meters, in operation since late 1948 with one electric annealing furnace, six coal burning forging places, 1 electric forging hammer, 1,000 kg, three electric forging hammers, 350 kg, and four mobile electric cranes, 15 to 20 tons
- 10 Power plant, 40x12x6 meters, completed in 1949, installation of the pneumatic steam boilers and two turbines planned. One (English) turbine was fitted. Total capacity 600 kws according to a Soviet engineer.
- 11 Cooling tower
- 12 Mechanical department, 100x100 meters, with two workshops; A completed in 1947 with 25 modern machine tools, workshop B equipped with 60 modern machine tools completed in late 1948.

25X1A

CONFIDENTIAL

25X1A

CONFIDENTIAL

25X1A

- 2 -

The department had eight mobile electric cranes up to 15-tons capacity. All PWs were withdrawn from here in 1947

- 13 Projected workshop, 100x60 meters, steel structure
- 14 Plant entrance
- 15 3 - meter high slag stone walls
- 16 apartment houses

CONFIDENTIAL

25X1A

CONFIDENTIAL

25X1A

- 3 -

Legend to Annex 2:

- A Caterpillar chassis
- B Rotary ring
- C Weight compensation
- D Motor
- E Gear
- F Cabin
- G Arm
- H Shovel

CONFIDENTIAL

25X1A

CONFIDENTIAL

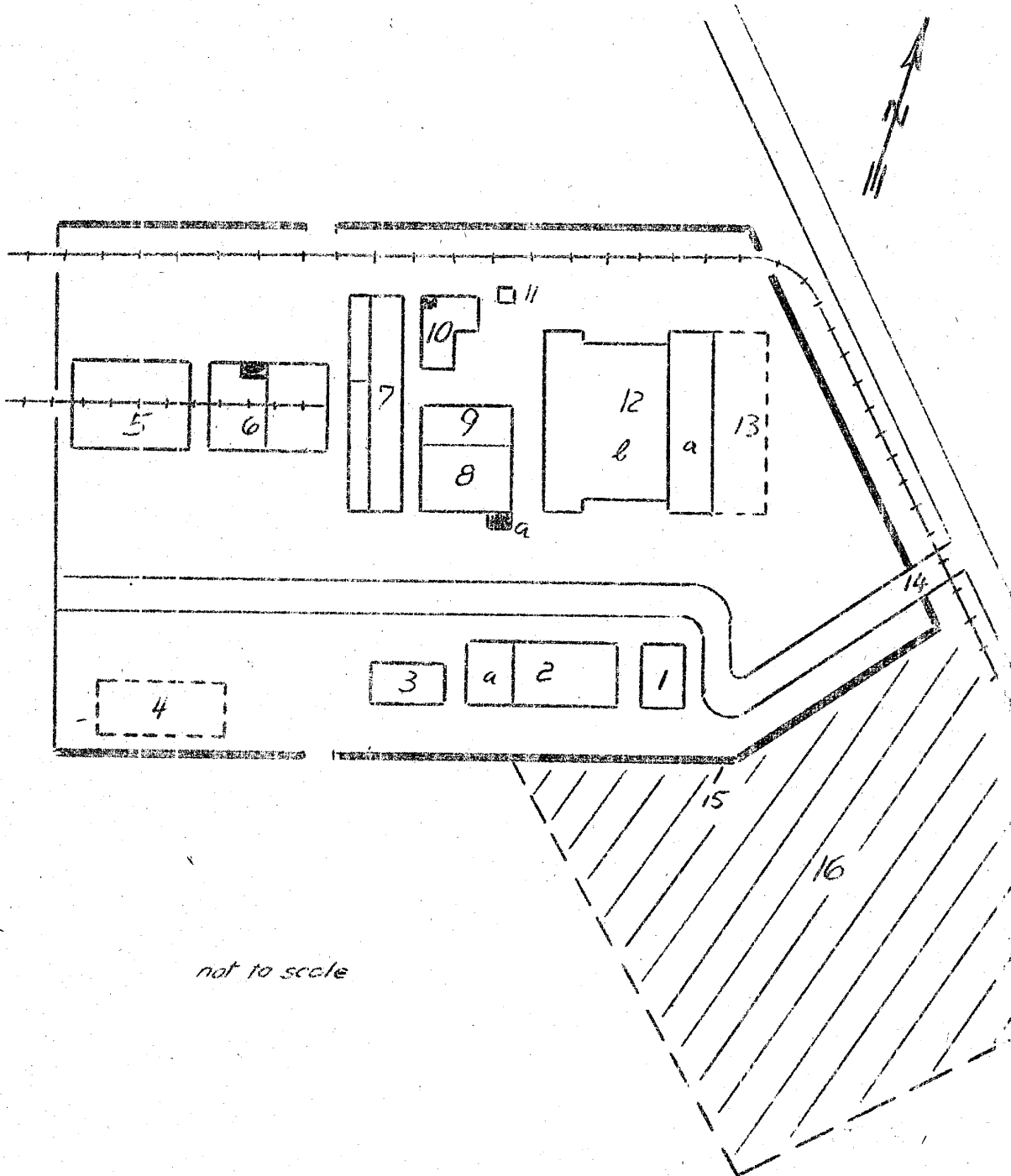

CONFIDENTIAL

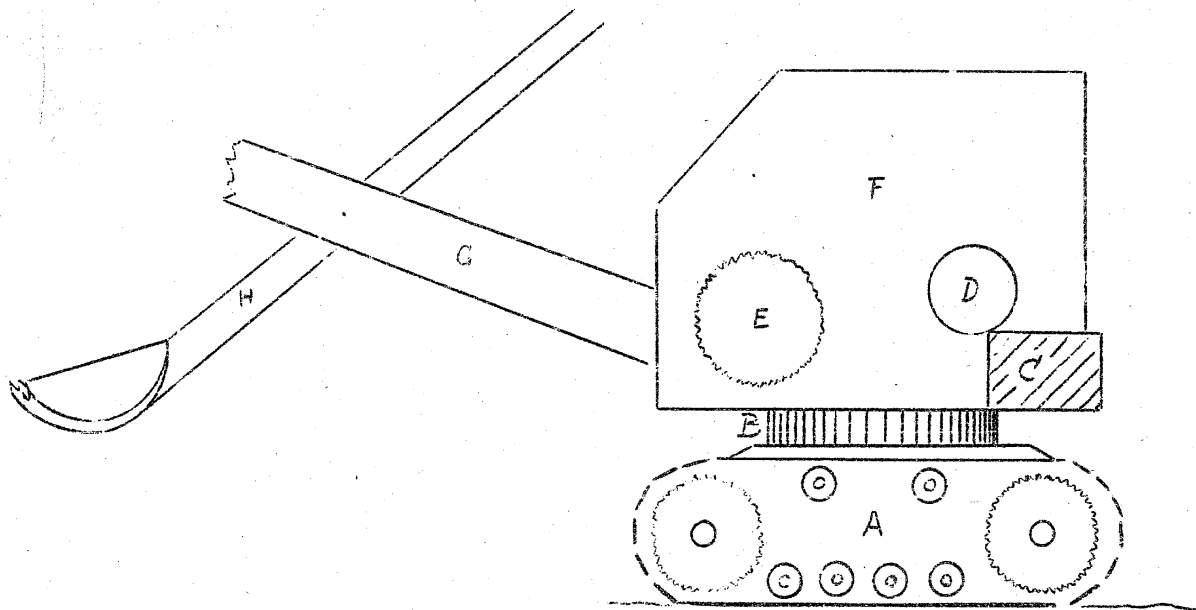

INTELETYPE TO

Soviet Union REPORT NO.

TOPIC Expansion of Rubber Plant in Voronezh

25X1A

25X1A

EVALUATION 25X1A PLACE OBTAINED

DATE OF CONTENT

DATE OBTAINED DATE PREPARED 20 April 1950

REFERENCES

PAGES 2 ENCLOSURES (NO. & TYPE) 1 blueprint

REMARKS

25X1C

25X1X

1. Location: The newly constructed annex of the rubber plant in Voronezh (39°12'N/51°28'E), Voronezh Oblast, is in the southeastern part of town, about 300 meters east of the power plant, which is immediately adjacent to the river.

2. Plant installations:

a. The plant is an old installation, destroyed during the war. Reconstruction was started in 1944. Production was started in the old section of the plant in September 1947.

b. Construction of the plant annex was started in April 1948 and not completed at the end of the time of observation.

c. There was a railroad connection. The plant covered a total area of about 1,000 x 500 meters. Power was supplied by a power station west of the plant.

d. The machinery for the new installations was part of the dismantled machinery from the Luna Plant in Schkopau, Germany. The machines were installed by Soviets. After they were set up, GIs were not permitted to enter plant installations.

e. For plant layout, see annex. The annex under construction was separated from the old plant by a wooden fence. GIs were not allowed the old section of the plant.

3. Work force: 800 GIs and 400 Soviets worked on the construction of the plant annex. The work force of the old section of the plant is not known

25X1A

4. Production:

a. In the old plant: Latex rubber.

25X1A

CLASSIFICATION CODE: UNCLASSIFIED

CONFIDENTIAL [REDACTED]

25X1A

- 2 -

b. Operation of Department 16, part of the new section of the plant, was scheduled to start by the end of September 1949 (presumably a basic product for latex rubber)

25X1A

[REDACTED] Comment:

Rubber Plant BR2 was previously reported * and was mentioned in reports on other installations in Voronezh. The location of the rubber plant as given here corresponds with previous information. Details on the new section of the plant are reported for the first time [REDACTED]

25X1A

1 Annex, Blueprint, Rubber Plant in Voronezh.

CONFIDENTIAL [REDACTED]

25X1A

CONFIDENTIAL

25X1A

- 1 -

Legend to Annex:

- A Rubber plant
- 1 Old plant section
 - 2 Plant department 16, 30 x 30 x 23 meters, the machinery was installed at the time of observation. Production was scheduled to start in September 1949.
 - 3 Plant department 22a, 20 x 12 x 3 meters, pump station for "Masol", nine tanks, a tenth was being installed. Dimensions of tanks: each 9 meters high and 2.5 meters in diameter.
 - 4 Plant department 15, new structure, 40 x 30 x 25 meters, six furnaces, carbide production.
 - 5 Plant department 22b, 20 x 12 x 3 meters, pump station for "Masol", ten tanks, same as under 10 3 above.
 - 6 Transformer station, 15 x 10 x 9 meters.
 - 7 Plant department 25a, 10 x 10 x 15 meters, pump station, for the purpose of pumping the liquid material to the different plant sections, was being installed.
 - 8 Plant department 26, 20 x 20 x 7 meters, six tanks, partly still under construction at the time of observation.
 - 9 Plant department 25, 40 x 30 x 25 meters, agitation plant.
 - 10 Plant department 28, 40 x 30 x 25 meters, the rollers for the processing of crude rubber were being installed.
 - 11 Through 16 excavations, each 40 x 30 meters, for additional workshops.
 - 17 Construction site.
- B Power plant, four large smokestacks
- C Housing project, still under construction
- D Temporary bridge
- E Destroyed bridge, according to Soviet statements the bridge was to be rebuilt in 1949.
- F Meadow

CONFIDENTIAL

25X1A

CONTROLLED DISTRIBUTION

Approved For Release 2002/08/15 : CIA-RDP83-00415R010900070007-Annex to

Rubber Plant in Voronezh

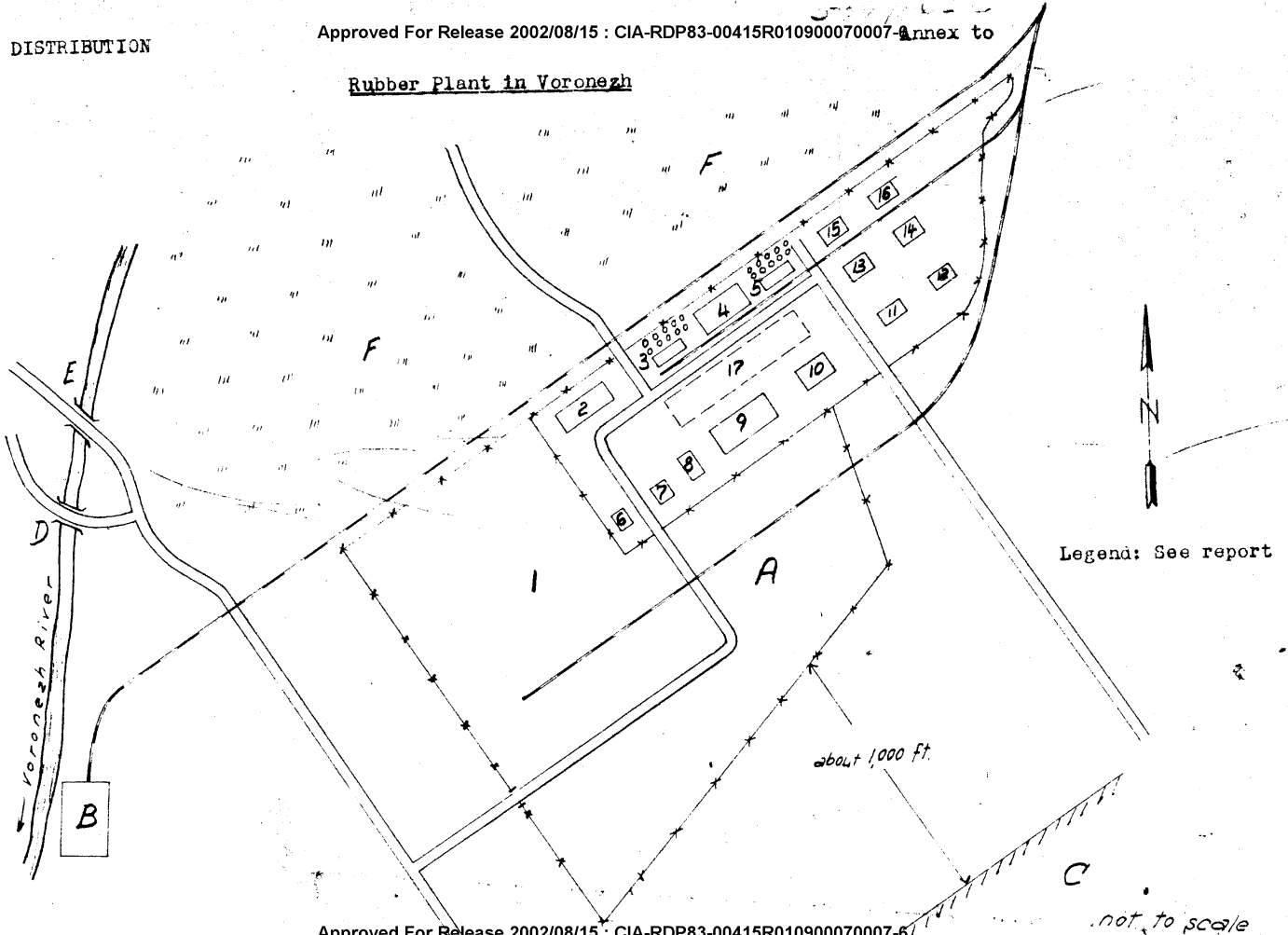

Approved For Release 2002/08/15 : CIA-RDP83-00415R010900070007-61

not to scale

COUNTRY U S S R REPORT NO. _____

TOPIC Aircraft Engine Depot near Penza

CONFIDENTIAL

25X1A

25X1A

EVALUATION 25X1A PLACE OBTAINED

DATE OF CONTENT 25X1C

DATE OBTAINED DATE PREPARED 29 June 1950

REFERENCES _____

PAGES 1 ENCLOSURES (NO. & TYPE) _____

REMARKS _____

25X1X

25X1X

1. a train from Kazan to Penza (45°00'E/53°11'N) when it stopped about 15 km from Penza. The railroad line passed through a woods at this point. A large loading ramp was east of the line. A fairly large camp with tents and wooden buildings was on both sides of the line. Many in-line engines were seen near the track and on the loading platform.

25X1X

the aircraft engines were standard V-type in-line engines. *

25X1A

* Comment. Report of the camp indicates that it was a temporary installation, probably dating back to the war. A major supply depot of the Soviet Air Force was located in Penza during the war. The local airfield seems to have been improved. See

CONFIDENTIAL
CLASSIFICATION

25X1A

INTRODUCED

COUNTRY Soviet Union REPORT NO. _____

TOPIC IVCT Glass Factory

EVALUATION 25X1A PLACE OBTAINED 25X1A

DATE OF CONTENT 25X1C 25X1A

DATE OBTAINED DATE PREPARED 9 February 1950

REFERENCES 25X1C

PAGES 1 ENCLOSURES (NO. & TYPE) 2 Blueprints

REMARKS _____



25X1X

1. Location:

In the town center of IVOT (34°10'E/53°41'N), Orel Oblast, about 1,5000 feet east of a lake.

2. Plant installations:

The factory is an old installation of the glass industry with its center in DYATKOVO. War damages were slowly reconstructed. A wide modernization started in April 1946, observed only the dismantling of the obsolete machinery. A narrow-gauge railroad connection was available. The plant covered about 1,800x900 feet (for plant layout see Annex).

3. Work Force

Three hundred Soviet laborers and 300 PEs working three shifts.

4. Production

Window glass, glass plates up to three inches thick and glass wool.

25X1A

Comment:

This is the first information on a previously unknown glass factory.

- 2 Annexes: 1.) Glass Factory in IVOT
- 2.)

CLASSIFICATION SECRET



25X1A

Glass Factory in IVOT.

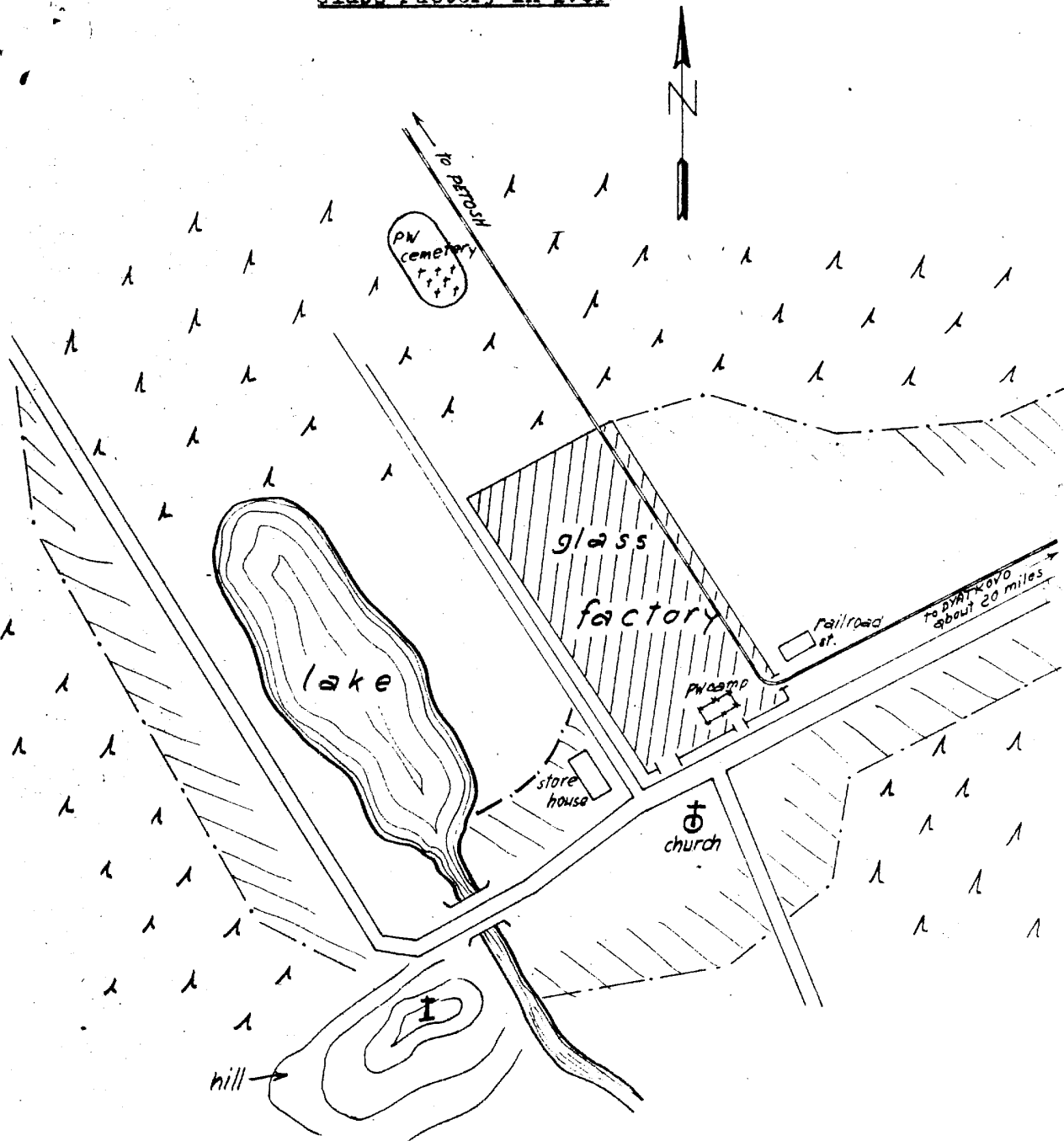

Glass Factory in IVOT

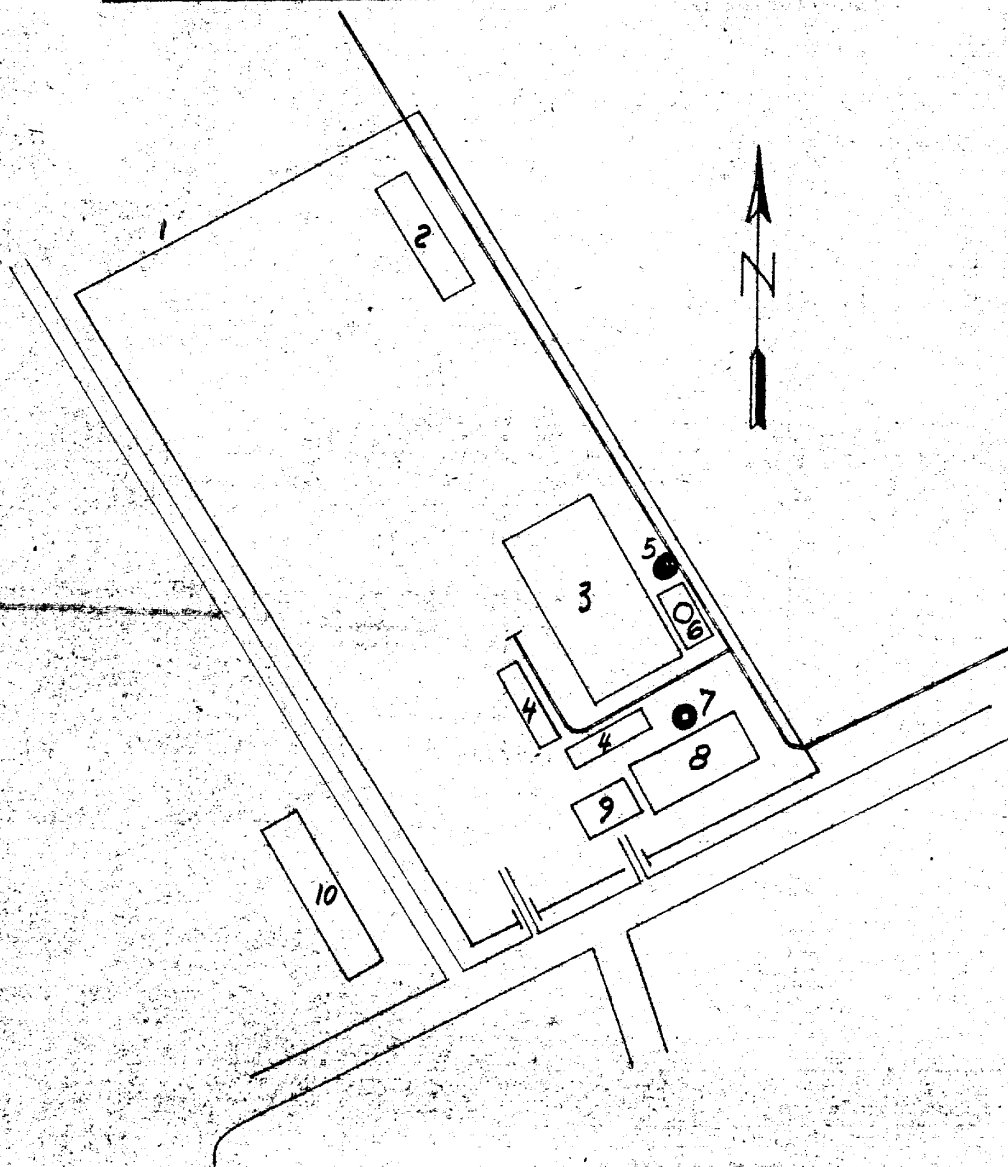

Legend:

not to scale

- 1 Wooden fence
- 2 Sawmill with two frames
- 3 Main workshop, 450x150 feet
- 4 Two mixing shops, 150x45 feet
- 5 Iron smokestack, 60 feet high
- 6 Heating and wood gas generating plant
- 7 Old smokestack
- 8 Workshop, 2/3 of which are destroyed
- 9 PW camp
- 10 Food store, about 360 feet long

INTL: 54

CLASSIFICATION SECRET

25X1A

Approved For Release 2002/08/15 : CIA-RDP83-00415R010900070007-6

COUNTRY Soviet Union REPORT NO.

TOPIC Optical Plant No 393 in ARSNOGORSK

EVALUATION 25X1A PLACE OBTAINED 25X1A 25X1A

DATE OF CONTENT 25X1C

DATE OBTAINED PREPARED 18 January 1950

REFERENCES _____

PAGES 3 ENCLOSURES (NO. & TYPE) 1 Blueprint

REMARKS _____

25X1X

1. Location: see references
2. Layout: See sketch.
Workshop equipment after 1947; dismantled machines, etc., from the Zeiss firm, JENA.
3. Labor:
3,000 Soviets, 500 German specialists of the Zeiss firm, JENA; 1 shift.
4. Production:
 - a. arial cameras, binoculars, microscopes, spectacle glasses, observation-slit, boxes for armored motor vehicles.
 - b. Other items were also produced there, 25X1A
what they were.
5. A German professor read lectures to about 60 to 80 Soviet students at the "Technical High School".

25X1X 6. made the following independent statements:

- a. Soviet labor, stated by Soviets: 10,000 persons.
- b. Two shifts
- c. The buildings, called "Secret Factories I and II" were officially termed "work part" 35 and 50 respectively. A fitter's shop and forge were observed on the ground floor, class rooms and drawing rooms were on the first floor.

CLASSIFICATION SECRET

25X1A

25X1A

Comment:

a. report on the important optical plant No 393, north of PLYERGO near LR SHCHERSK, the former optical plant No 69, was previously made (see references)

25X1A

Report: Date of information: Labor: Shift

25X1A

*	<input type="text"/>	20,000	3
*	<input type="text"/>	Day shift 7,000 and 2 shifts with small-	3
**		5,000 and 120 German specialists	

25X1A

Subject report:	<input type="text"/>	3,000 plus 500 German specialists	1
-----------------	----------------------	-----------------------------------	---

25X1A

Subject report:	<input type="text"/>	10,000	3
-----------------	----------------------	--------	---

Working at full capacity, the number of workmen in the plant is estimated at about 6,000 to 8,000 men.

Legend to annex:

- 1 Building, 5 stories, manufacture of lenses; searchlight on roof
- 2 Workshop
- 3 Workshop, searchlight on roof
- 4 Forge and painter's shop (varnishing shop)
- 5 Iron store
- 6 Foundry and molding shop
- 7 Store
- 8 Joiner's shop
- 9 Storage place for German dismantled goods
- 10 Coal and peat depot.
- 11 Boiler house I
- 12 Large depot
- 13 Gasoline cellar
- 14 Gasoline depot
- 15 Administration and garages (motor vehicle repair shop)
- 16 "Technical High School", new building
- 17 Joiner's shop
- 18 Repair shop for motor vehicles not belonging to plant
- 19 "Secret factory II", searchlight on roof
- 20 "Secret factory I", with boiler house
- 21 Printing house.

annex: Optical Plant No 393 in LR SHCHERSK

SECRET

25X1A

CONTROLLED DISTRIBUTION

Annex to

Optical Plant No. 323 in KRASNOGORSK.

(Legend: See report)

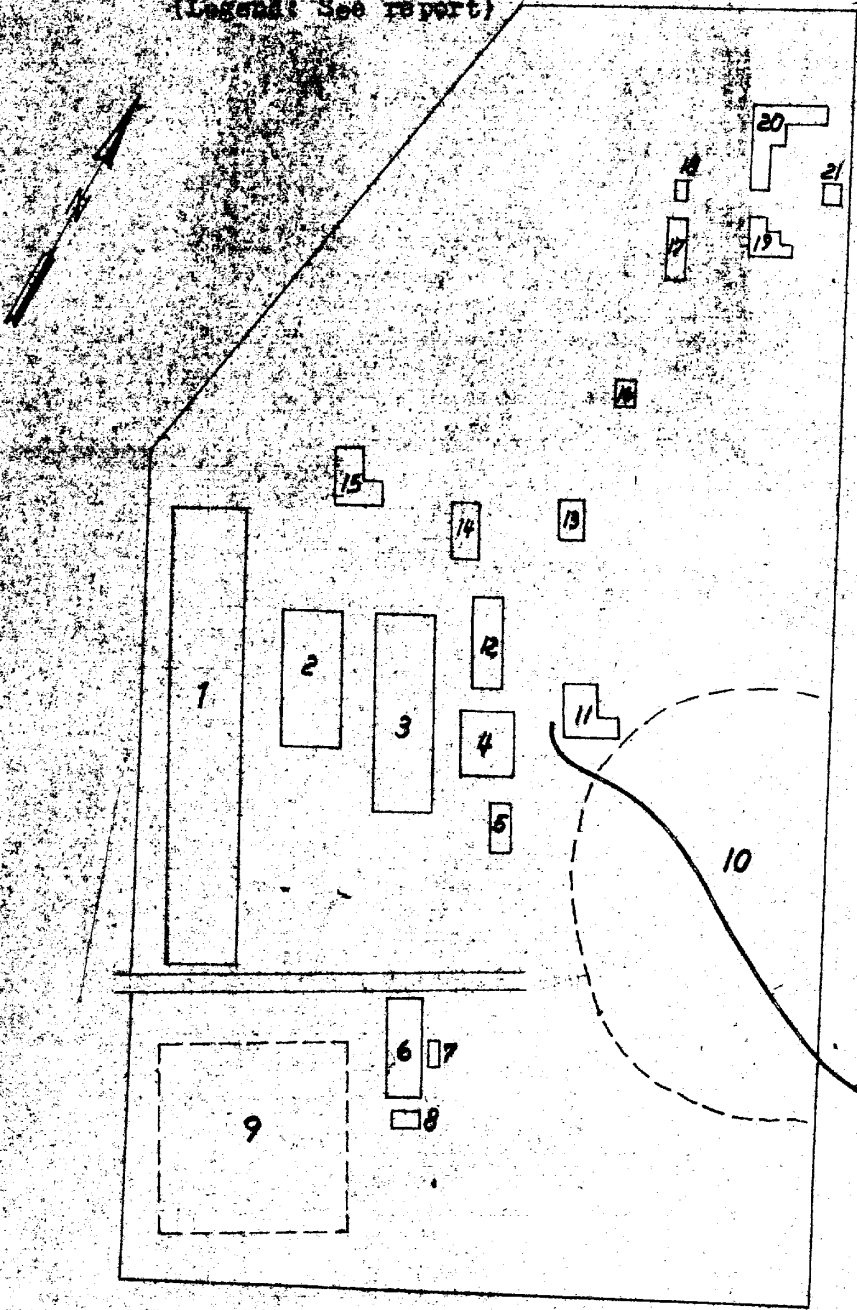

scale = 1:5,000

COUNTRY Soviet Union REPORT NO.

TOPIC Steel Plant in Kulebaki

EVALUATION 25X1A PLACE OBTAINED 25X1A 25X1A

DATE OF CONTENT 25X1C

DATE OBTAINED DATE PREPARED 28 March 1950

REFERENCES 25X1C

PAGES 1 ENCLOSURES (NO. & TYPE)

REMARKS

25X1X



1. Location:

Southwest of the railroad station of Kulebaki (42°32'E/55°25'N), Gorki Oblast.

2. Plant installations:

The largest plant building is the foundry, 90 x 36 meters. All buildings are of stone and about 10.5 meters high; some are covered with glass roofs. A mobile power station (eight railroad cars) was parked in the plant area and supplied the power.

3. Work force:

Three shifts with a total of 15,000 laborers, most of them convicts.

4. Production:

Wheels for locomotives and railroad cars, turbine wheels, tubes with square cross section, 2.7 meters long, the walls about 7 cm thick.

25X1A

Comments:

a. This report supplements previous information on the steel plant in Kulebaki. Data on the dimensions of the largest plant building were confirmed by an earlier report. *

b. The plant location was covered by an aerial photograph 25X1A (see Annex of previous report *). new constructions or enlargements. It can therefore be assumed that the aerial photograph illustrates the present status of the plant.

CLASSIFICATION CONFIDENTIAL 25X1A

COUNTRY Soviet Union REPORT NO

TOPIC Railroad Car Factory in Kalinin.

EVALUATION 25X1A PLACE OBTAINED 25X1A

DATE OF CONTENT 25X1C 25X1A

DATE OBTAINED DATE PREPARED 21 April 1950

REFERENCES _____

PAGES 1 ENCLOSURES (NO. & TYPE) 1 Blueprint

REMARKS _____

RETURN TO CIA LIBRARY



25X1X

1. Location:

In the western part of Kalinin (35°55'E/56°51'N), Kalinin Oblast, on the northern bank of the Volga River.

2. Installations:

a. The factory covers 1,100 x 1,900 meters. The installations seemed to be in good condition. The workshops are solid structures with black wooden roofs and are painted brick color.

b. The plant has a single-track railroad connection with several branches in the plant area. (Location and layout sketch see Annex).

3. Work force:

Three shifts with 1,000 Soviets each, including 60 percent women.

4. Production: Pullmann coaches.

25X1A

Comment:

a. This is the first information with detailed data on the railroad car factory in Kalinin.

b. The attached sketch is very schematic and entirely wrong as regards the course of the Volga River. The location of the plant and of the neighboring objects was reproduced more correctly in a previously received town sketch *.

CLASSIFICATION CONFIDENTIAL

25X1A

COPY OF ENCLOSURE IN LIBRARY

CONFIDENTIAL

25X1A

Annex

Legend to Annex:

- A Railroad car factory
- 1 Assembly shop, brick building, 54 x 135 meters
- 2 Guardhouse
- 3 Sawmill, brick buildings, 36 x 54 meters, with four frames
- 4 Post exchange, wooden shed, 36 x 135 meters
- 5 Brick assembly shop, 54 x 135 meters
- 6 Brick foundry, 36 x 108 meters, with two brick smokestacks, each 21 meters high, five furnaces
- 7 Assembly shop, same as 5
- B Forced labor camp
- C Railroad bridge, two tracks
- D Road bridge, wooden structure resting on two stone piers
- E Power plant
- F Peat dump of the power plant
- G Road bridge, similar to D
- H Cadet school
- I MVD Headquarters
- K War academy
- L PW Camp No 7384

CONFIDENTIAL

25X1A

CONFIDENTIAL

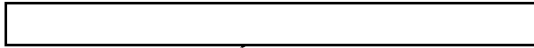

25X1A



25X1A

1 Annex: Location and Layout Sketch of the Kalinin
Railroad Car Factory.

CONFIDENTIAL



25X1A

INTELOFAX 5

COUNTRY Soviet Union REPORT NO.

TOPIC Electrosignal Plant in VORONEZH

EVALUATION 25X1A PLACE OBTAINED 25X1A 25X1A

DATE OF CONTENT 25X1C

DATE OBTAINED 25X1C DATE PREPARED 10 January 1959

REFERENCES

PAGES 1 ENCLOSURES (NO. & TYPE)

REMARKS

25X1X



- 1. Installations: The war damages of the plant were repaired by 1947. The plant has one workshop, 150 x 70 feet, and three other buildings including a five-story structure.
- 2. Work force: A total of 1,200 Soviets including about 70 percent women, working three shifts.
- 3. Production: Radio sets. One large freight car was loaded every two days in the Summer of 1947.

25X1C

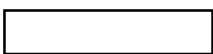

25X1A

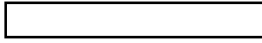
- 4.  the following statements:

c. Installations:

One workshop, 300 x 660 feet
 Ten smaller buildings, including
 One newly constructed building 65x65 feet
 one newly constructed building 200x65 feet, three stories
 one five-story brick building, 265x100 feet.

b. Work force: 2,000 to 3,000 Soviets; no details available on the number of shifts.

25X1A

 Comment:

- a. Information on the electrosignal Plant in VORONEZH was previously transmitted in a comprehensive report. *
- b. According to the present report, the radio plant was still being expanded in late 1948.
- c. "Repair of war damages by 1947" as mentioned in this report means only that on that date production was partly resumed, a fact which was confirmed by previous information.

CLASSIFICATION SECRET



25X1A

Approved For Release 2002/08/15 : CIA-RDP83-00415R010900070007-6

25X1A

Next 1 Page(s) In Document Exempt

Approved For Release 2002/08/15 : CIA-RDP83-00415R010900070007-6

HELLOFAX 5

COUNTRY Soviet Union REPORT NO. _____

TOPIC Plant No 300 in MOSCOW

EVALUATION 25X1A PLACE OBTAINED 25X1A 25X1A

DATE OF CONTENT _____

DATE OBTAINED _____ DATE PREPARED 19 December 1949

REFERENCES 25X1C

PAGES 2 ENCLOSURES (NO. & TYPE) 3 Blueprints

REMARKS _____

[Redacted]

25X1X

1. Location:
See Annexes 1 and 2
2. Designation:
according to Soviets, Plant No 300.
3. Plant History:
According to Soviets, the plant was the former Czarist Mint, which was rebuilt after 1941. Packed machinery was observed in the yard.
4. Work Force: About 1,200 Soviets in one shift.
5. Observations Made at Paulage Missions:
 - a. Many machine tools with various metal scraps were observed in the workshops. It was inferred that no quantity production was going on. (Many aluminum, copper, brass, and steel chips were seen).
 - b. Wheels of 120 centimeter diameter, thought [Redacted] to be turbine parts, were observed. 25X1A
 - c. The engine test stands were almost always in operation. It was particularly noted that each engine had to be started from 3 to 8 times before it began running. The running time did not exceed 5 to 10 minutes. The test stands were mostly enveloped in smoke. One time all workers had to leave the buildings as special experiments were made at the test stands. Only a deafening noise was heard.
6. Rumors:
Soviets stated that the plant was a turbine test plant and that wind tunnel with a diameter of 2 to 2½ meters was available.

SECRET-

[Redacted]

25X1A

Comment:

a. Plant No 300 had only been known before from [Redacted] report.+ and press reports of November 1948 (Neue Zuericher Zeitung). 25X1X

b. [Redacted] 25X1A

c. [Redacted] 25X1C

d. From all the gathered data it is inferred that Plant No 300 is located within the curve of the Moskva River extending farthest to the southwest near the VEROYEVNI GORY elevated Railroad Station. The two bridges (railroad and road bridge) are entered on the town map as Bridge No 506 and as Frunze II Bridge.

e. [Redacted] 25X1A

- 3 Annexes: (1) Plant No 300 in MOSCOW
 (2) Installations of Plant No 300 in MOSCOW
 (3) Location of the Czarist Mint [Redacted] 25X1C

25X1X

SECRET-

[Redacted]

25X1A

Plant No. 300 in MOSCOW

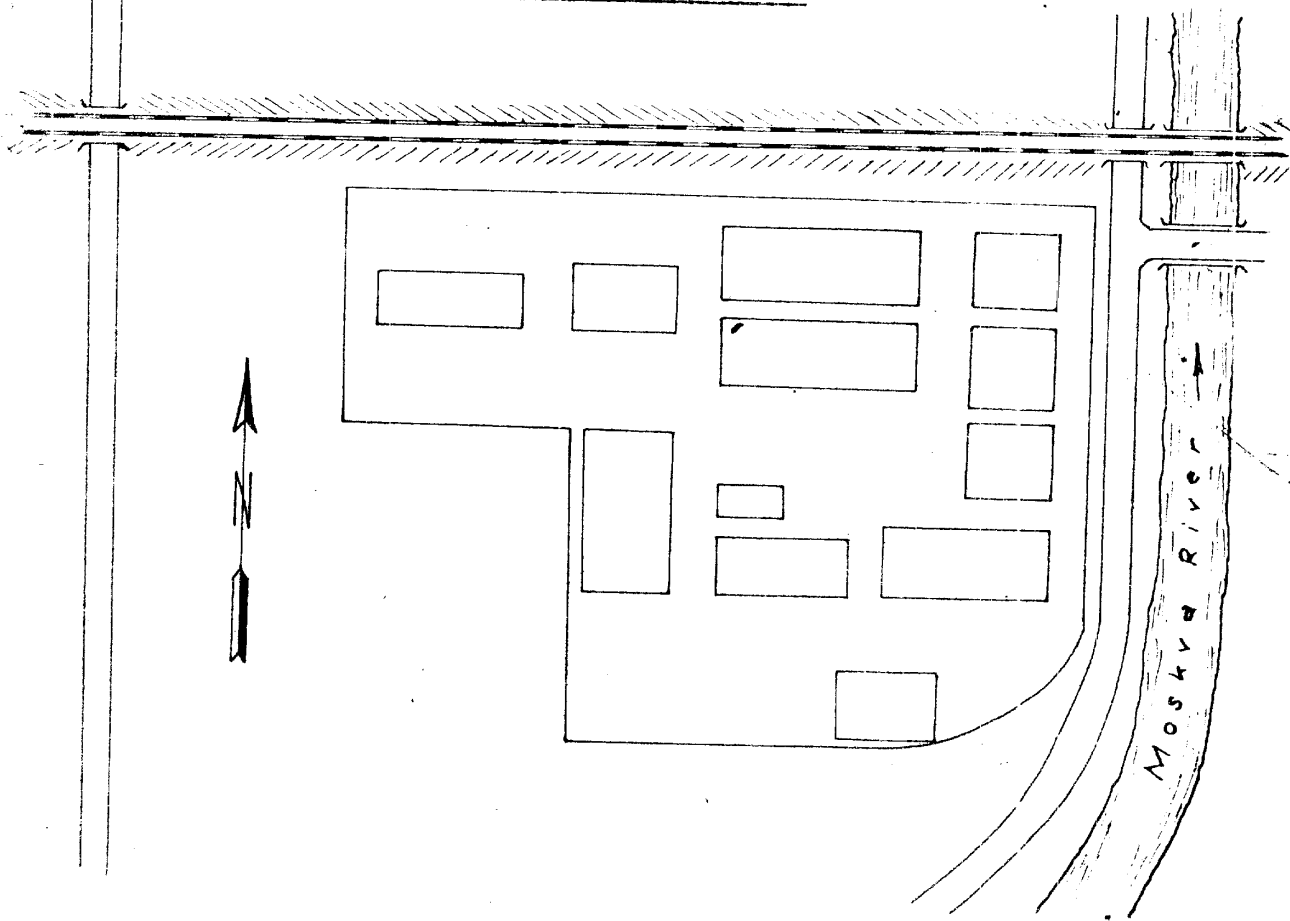

Installations of Plant No. 300 in MOSCOW

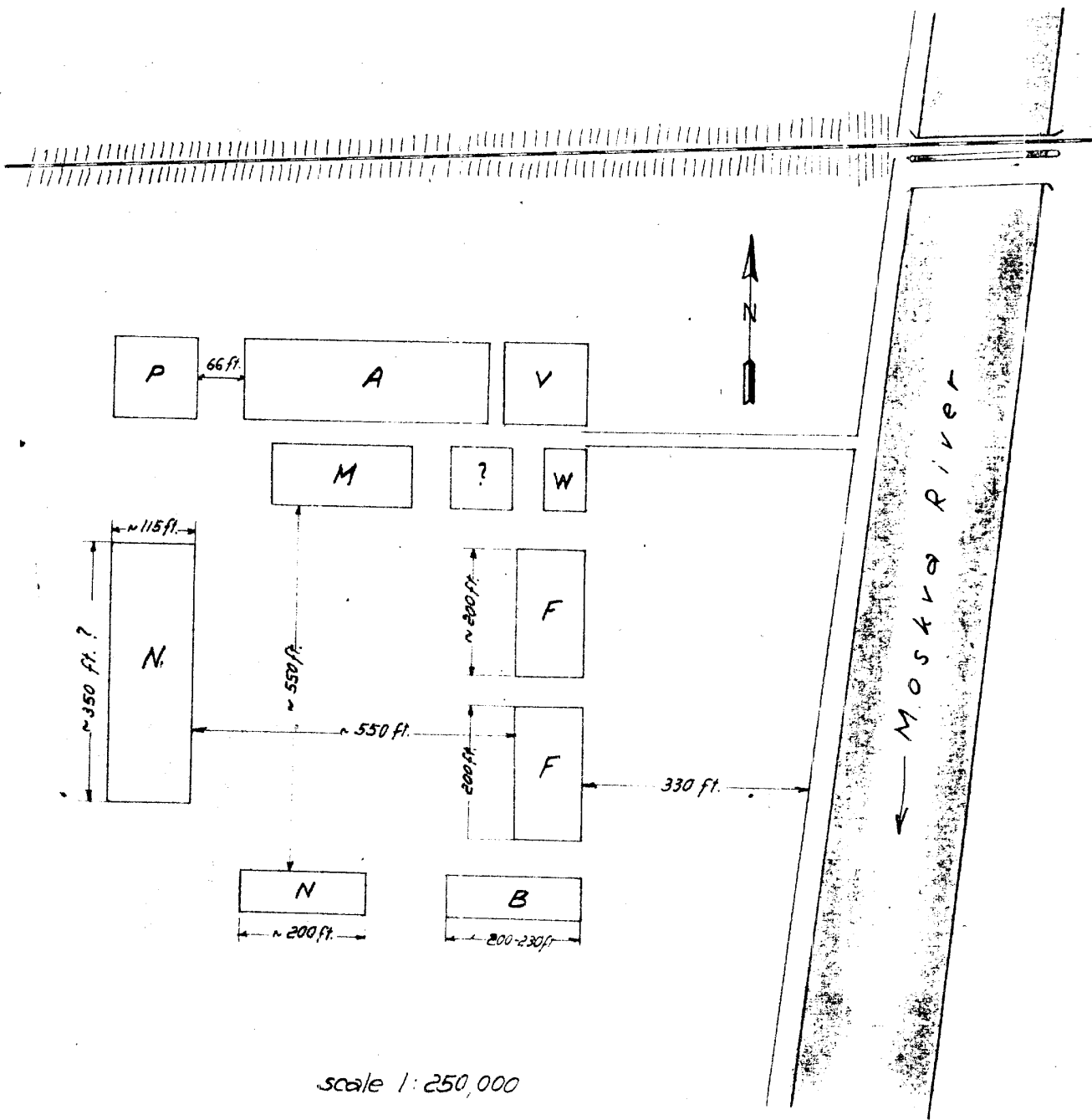

scale 1:250,000

Legend:

- | | | | |
|---|-------------------------------|---|------------------------------------|
| M | Mint | P | Engine test stand |
| A | Old plant building | F | Factory building |
| N | New building | V | Administration building |
| B | Old building with a flat roof | W | Presumably administration building |

Location of the Czarist Mint

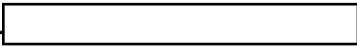

25X1X

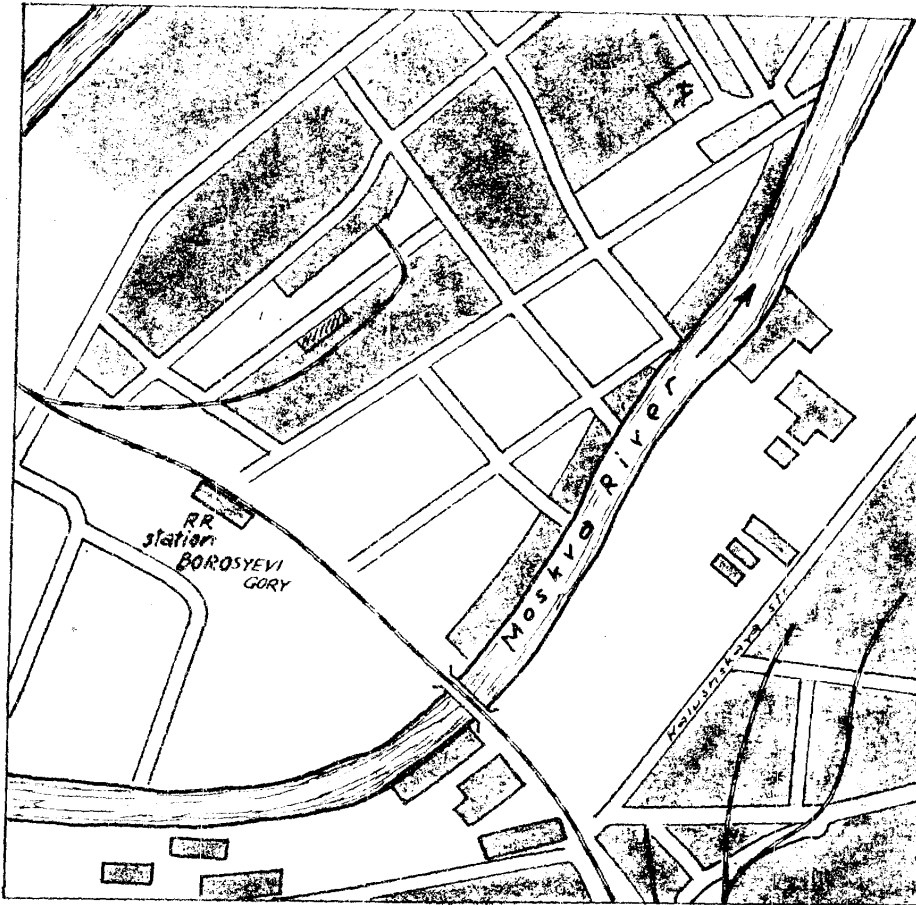

scale 1:20,000

COUNTRY Soviet Union REPORT NO.

TOPIC Aircraft engine Plant No. 500 in MOSCOW-TUSHINO

EVALUATION [redacted] 25X1A PLACE OBTAINED [redacted] 25X1A

DATE OF CONTENT [redacted] 25X1A [redacted]

DATE OBTAINED 25X1C DATE PREPARED 30 November 1949

REFERENCES

PAGES 3 ENCLOSURES (NO. & TYPE) 25X1A

[redacted]

[redacted]

25X1X

1. Location:

MOSCOW-TUSHINO (37°25'N, 55°50'W). The plant was bound on the north by the Chodnya Canal. And a road bridge crossed the canal near the northwest corner. A hydro power station was located about 500 feet west of the northwest corner of the plant.

2. Numerical designation of plant: No. 500 (according to [redacted])

3. Size: about 2,600 x 1,650 feet (rough estimate).

4. Railroad connection: single-tracked siding.

5. Buildings: Brick structures. The workshops were covered with glass roofing, the administrative buildings with sheet metal roofs. No new constructions.

6. Work force:

a. Estimate according to [redacted] a total of ten thousand working three eight-hour shifts.

b. Percentage of women: 30 per cent.

c. Age: Half of the personnel were 20 to 30 years old.

3. The workers were housed in the factory-owned settlements east of the plant and in the town of MOSCOW.

25X1X

SECRET

e. German experts: About 70 to 80 German engineers and their families arrived in December 1947/January 1948.

25X1X

[redacted] they had come from the Junkers plant in Dessau.

[redacted] they were to soon move to OMSK.

7. Production:

a. Heavy aircraft radial engines. [redacted] that the engines were taken from the test stand to a hall and packed in boxes. The shipping box was about 13 x 6 x 7 feet.

25X1A

The shipping boxes did not occur regularly. Sometimes one box was loaded in the morning and two boxes in the afternoon and then only after half or a whole day's interval a new shipment was due.

b. Rusty engines were stored at a scrap dump.

c. Test stands were in operation day and night.

d. Supply of semi-finished goods was not observed nor [redacted] From the fact that metal borings (steel, copper and brass borings) were collected in the plant area and burnt by PWs and that electro sintering furnaces were installed and small gear wheels made at the plant, [redacted] all engine parts were produced in the plant.

25X1A

e. By-products such as milk cans and cooking-pots of aluminium were produced in a workshop near the northwest corner of the factory.

8. "Huge" quantities of scrap consisting of engines, fuselages and other aircraft parts were stored over all the plant area.

9. An estimated 80 to 100 piles of aluminium bars of 20 to 30 bars each were distributed throughout the factory area.

10. A coal train of 13 to 20 cars (60 tons each) for the boilerhouse arrived every three or four days.

11. Security measures: High board fence with watchtowers at the corners; by day, patrols outside and inside the factory; armed civilian guards.

12. No air defense equipment or AAA emplacements.

13. Factory-owned vehicles were not at the disposal of the plant.

25X1A

[redacted] Comment:

1. The factory designated as Aircraft Engine Plant No. 500 is, no doubt, identical with the former Engine Plant No. 32 north of FUCHINO airfield. This plant was also designated as Plant No. 500 in former reports by [redacted] as plant number 32 became vacant after this factory had been transferred to the KATAM

25X1X

SECRET

25X1A

SECRET

aircraft engine plant in the Fall of 1941, it is possible that a new plant number, i.e. No. 500, was assigned to the plant which was established on the premises of the former factory.

2. Before the plant was evacuated its work force numbered about five thousand workers. The number was indicated at about three thousand for the period between 1945 and the beginning of 1948. The reported number of ten thousand, therefore, appears greatly overestimated.
3. Plant No. 500 is the development and production plant for Diesel engines. The Diesel section of the Junkers plants, headed by GERLACH was transferred to this place. There, besides other projects, the development of the Jumo-224/26 plant is being done. Most of the former reports covering the same period of observation stated that 12-cylinder in-line engines, liquid-cooled, were produced. Only in one report mention was made of 14-cylinder radial engines. However, as the reported dimensions of the transport boxes for the 12-cylinder in-line engines were greatly exceeded by those stated for the radial engines it can be assumed that though the dimensions appear overestimated the engine in question may actually be a heavy type radial engine. A box 13 feet long appears rather high even for a jet plant furnished with complete mounting jig.

SECRET

COUNTRY: Soviet Union REPORT NO.

TOPIC: Aircraft Engine Plant No 500, Moscow-Tushino

EVALUATION: 25X1A PLACE OBTAINED: 25X1A

DATE OF CONTENT: 25X1C 25X1A

DATE OBTAINED: DATE PREPARED: 17 March 1950

REFERENCES:

PAGES: 2 ENCLOSURES (NO. & TYPE):

REMARKS:

25X1X

1. Location: The aircraft engine plant is in Moscow-Tushino, north of the military airfield.

25X1X

2. [Redacted]

- a. About 120 German engineers and skilled workers of Dessau are working in this factory. They were drafted for five year contracts, and live in houses near the plant with their dependents.
- b. The factory produced in-line V engines to its maximum capacity.
- c. The Russian s seized the designs and blueprints of the 4,000 - HP engine in Dessau, but the designer fled to the Western Zone and offered his services to the Americans.
- d. The factory is being converted to the production of this engine, but the conversion had not yet been successfully completed.*

25X1X

3. [Redacted] did not know the names of the engineers.

4. Working time: Three eight-hour shifts.

25X1A

[Redacted] Comment :

Aircraft engine plant No 500 in Moscow-Tushino (formerly No 62) described in several previous reports. Gerlach worked in this plant with the Diesel Section of Junkers, Dessau, on Diesel engine 224 which is designed for a performance of 4,000 HP. In addition to the construction of an experimental series of Jumo 224, German engine

SECRET

[REDACTED]

25X1A
25X1A

[REDACTED]

models were overhauled or stripped. The previously reported light metal smelting furnaces served this purpose.

* The production of an engine, conversion to which had not been successfully completed, probably means the JUMO 224, which is to be mass-produced. Its actual production met with difficulties, according to available reports.

Transfer of the Gerlach group to Kuibyshev in 1948 may be an indication of the failure of this developmental project, but this

[REDACTED]

25X1A

SECRET

[REDACTED]

25X1A

Approved For Release 2002/08/15 : CIA-RDP83-00415R010900070007-6

25X1A

Next 1 Page(s) In Document Exempt

Approved For Release 2002/08/15 : CIA-RDP83-00415R010900070007-6

COUNTRY Soviet Union REPORT NO.

TOPIC Aircraft engine plant No 500 in Moscow-Tushino

EVALUATION [] 25X1A PLACE OBTAINED [] 25X1A [] 25X1A

DATE OF CONTENT [] 25X1C

DATE OBTAINED [] DATE PREPARED 12 April 1950

REFERENCES 25X1C

PAGES 1 ENCLOSURES (NO. & TYPE)

REMARKS

RETURN TO CIA LIBRARY

25X1X

- 1. Location: north of the Moscow-Tushino airfield.
- 2. Work force: 2,500 Soviets, working three shifts; only one or two shifts in some departments. A group of 15 to 20 engineers and skill workers of the Junkers firm in Dessau was employed.

25X1A

- 3. Production: large in-line engines, definitely not radial. []
[] Six to eight engines packed in boxes were on the loading ramp every day for shipment by rail. Dimensions of the boxes were 2 x 1.5 x 1.5 meters. No details on output. []

25X1A

- 4. Aircraft engine test stands were in operation day and night.

25X1A

[] Comment:

25X1A

Report [] is forwarded because it supplies confirmatory evidence that the Tushino plant was not converted to the production of jet power plants in mid-1947.

COUNTRY YELLOW
YELLOW

Soviet Union REPORT NO.

TOPIC Aircraft Accessories Plant No 219 in KOSCOV-BALASHIKHA

EVALUATION [redacted] 25X1A PLACE OBTAINED [redacted] 25X1A 25X1A

DATE OF CONTENT [redacted] 25X1C [redacted]

DATE OBTAINED DATE PREPARED 19 December 1949

REFERENCES

PAGES 1 ENCLOSURES (NO. & TYPE)

REMARKS

25X1X

[redacted]

1. Location:

Near the village of GORENKI (37°54'10" E/55°48' N).

2. Name:

Plant No 219 (Soviet statement).

3. Layout:

Plant was damaged or not yet finished. Construction work finished in May 1949. There is a foundry.

4. Labor:

Three thousand Soviets working in three shifts.

5. Production:

- a. Casings for E-motors, about 60 each day shift.
- b. Motor blocks for aircraft engines.
- c. Component parts (screws, bushings, etc.)
- d. Refuse of foundry, 30 to 40 percent.

6. After 1 February 1948 PWs were no longer admitted to workshops.

25X1A [redacted] Comments

It is inferred from previous reports that the reconstruction of the plant was practically completed, and the manufacturing was started on that date.

25X1A

[redacted]

HELLOFAX 5

25X1A

COUNTRY U.S.S.R. REPORT NO. 1

TOPIC Podolsk Accumulator Factory

EVALUATION [] 25X1A PLACE OBTAINED [] 25X1A

DATE OF CONTENT [] 25X1C [] 25X1A

DATE OBTAINED [] 25X1C DATE PREPARED 27 June 1950 []

REFERENCES

PAGES 2 ENCLOSURES (NO. & TYPE) 1 - sketch on ditto

REMARKS



25X1X

1. The Podolsk Accumulator Factory was directly opposite the main station of Podolsk (37°33'E/55°27'N) Moscow Oblast, east of the railroad line. An ammunition plant was 2 km southeast, about 1 1/2 km east of the road to Tula. [] reported the location as in the southern town section, east of the railroad station, opposite a large railroad line to Moscow. The plant had the no 684.

25X1A

2. Batteries for motor vehicles, radio transmitters and receivers were produced. Casings made of plastic similar to bakelite were delivered to the plant, which produced 10 to 15x20x30 cm lead plates, mostly using wasted accumulators.

3. During the war the plant was transferred to Chumery and in 1945 returned to Podolsk. It was constantly enlarged and had the following departments in 1942: smelting shop, a manually operated and an American revolving foundry, a chemical department, a pressing shop for plates, an assembly shop, a test charging shop and a drying chamber. **

25X1A

25X1A

CONFIDENTIAL



New American machines arrived up to the middle of 1947. The other 50 percent of the machinery were dismantled German installations.

- 4. Five hundred laborers including 60 rws were employed in 1948.
- 5. Approximately 6,000 motor vehicle batteries (215) were produced each week. The casings came from a Podolsk bakelite plant. ***

25X1A

* Comment. This is the first report on an accumulator plant in Podolsk which according to location data and sketch, is the previously known "Tin Plant" (See aerial photograph taken on 17 January 1943, The location of the plants No 1 through 3 is given on Annex. Except for the cable plant the installations reproduced on the Annex were also shown by the aerial photograph. A locomotive plant on the aerial photograph south of the accumulator factory is not entered on attached sketch. The various plant dimensions reproduced on the Annex are incorrect.

25X1A

25X1A

** Comment. This is the only information available on the plant layout.

25X1A

*** Comment. A bakelite factory is reported for the first time.

1 Annex: Sketch.

CONFIDENTIAL



25X1A

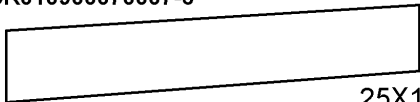

25X1A

Podolsk Accumulator Factory

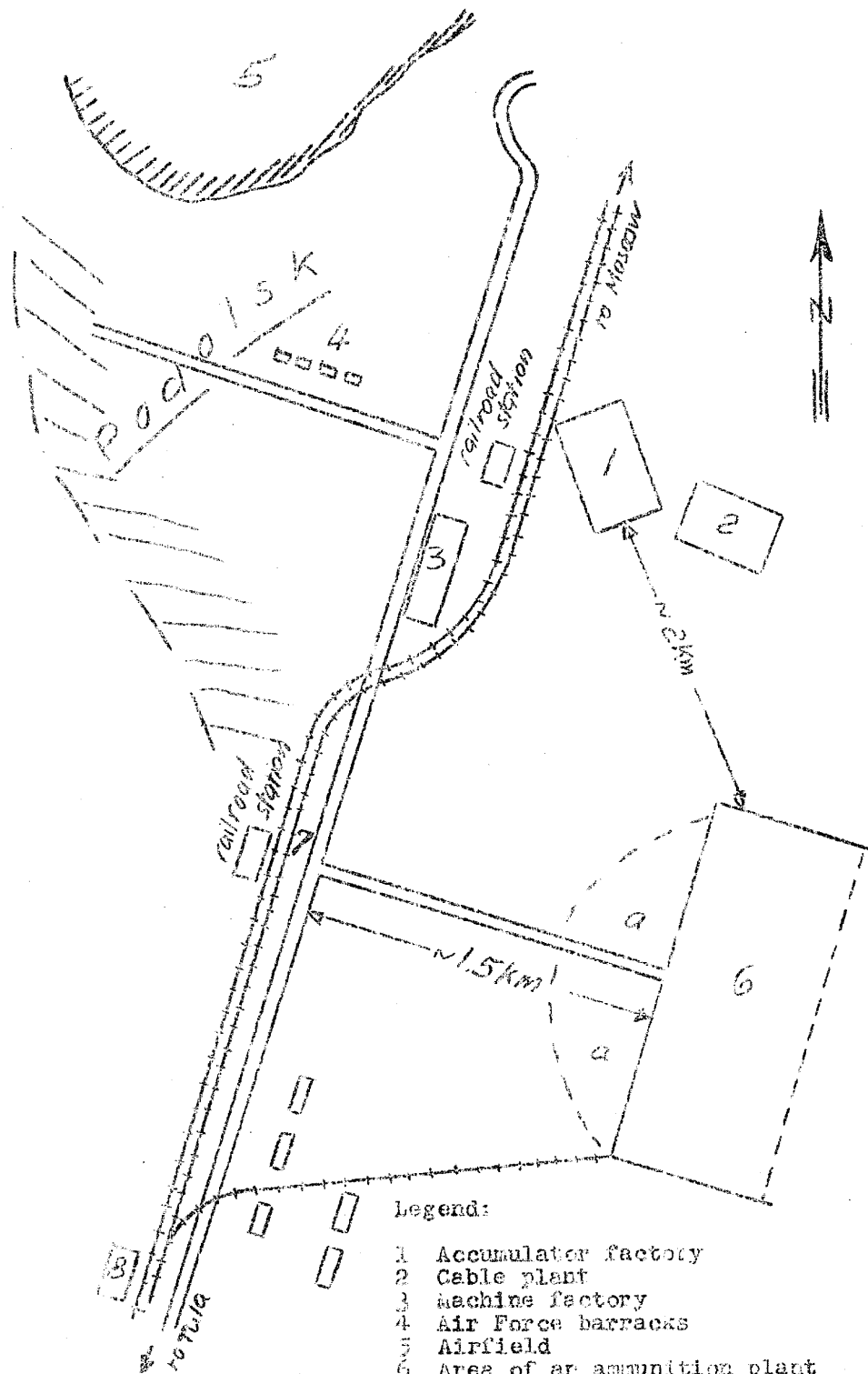

Legend:

- 1 Accumulator factory
- 2 Cable plant
- 3 Machine factory
- 4 Air Force barracks
- 5 Airfield
- 6 Area of an ammunition plant
- a laborers' settlement
- 7 Large road to Tula
- 8 Suburb railroad station

CONFIDENTIAL



25X1A

COUNTRY U.S.S.R. REPORT NO. _____

TOPIC Information on Plant No 455 in Kostino 25X1A

EVALUATION 25X1A PLACE OBTAINED 25X1A

DATE OF CONTENT 25X1C

DATE OBTAINED _____ DATE PREPARED 12 December 1951

REFERENCES _____

PAGES 1 ENCLOSURES (NO. & TYPE) 1 - sketch on ditto

REMARKS _____

RETURN TO CIA LIBRARY

25X1X

1. Plant No 455 was located in Kostino (55°54'N/37°52'E), Moscow Oblast. The plant covered an area of about 300 x 400 meters. During the war, aircraft parts were manufactured there. In 1946, the plant was converted to peace-time production. Residents of Kostino said in the middle of 1947 that the plant would soon be reconverted to armament production in conjunction with Plant No 88 in Moscow-Kaliningrad. *

25X1A * Comment. For location sketch of Kostino, see annex. Although the location and estimated size of the plant do not agree with referenced report, the same plant is probably indicated. In 1941, Plant No 455 was temporarily transferred to Kusnetzk together with Plant No 472. in 1946 25X1A that aircraft parts were again manufactured there. See . In January 1947, German engineers were allegedly seen there. It is believed that, since the summer of 1947, Plant No 455 has been a subsidiary plant for Plant No 88, Kaliningrad where V-2 missiles were being manufactured.

CLASSIFICATION CONFIDENTIAL

25X1A

Location Sketch of Plant No 455 in Kostino.

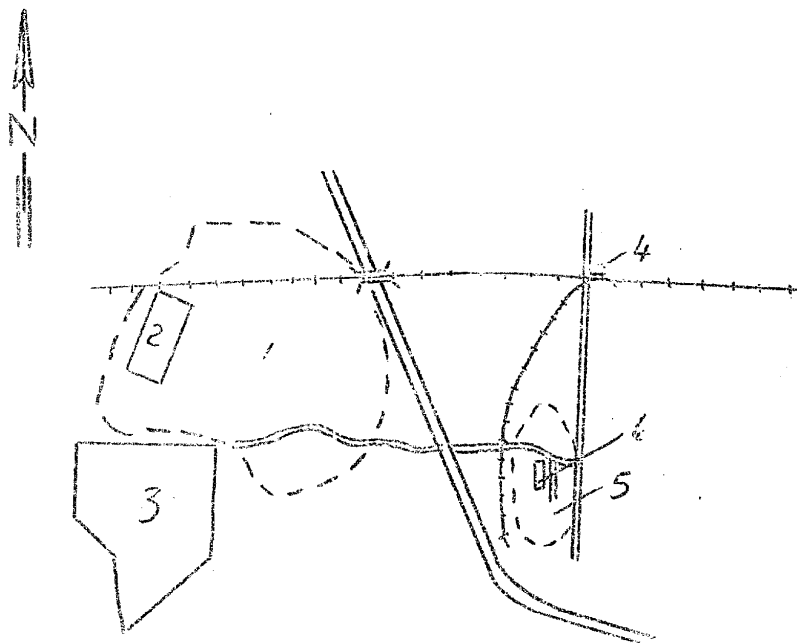

Not to scale

Legend:

- 1. Moscow-Kaliningrad.
- 2. Plant No 88, manufacture of V-2 missiles.
- 3. Airfield.
- 4. Boishovo railroad station.
- 5. Kostino.
- 6. Canal.

COUNTRY U.S.S.R. REPORT NO. [redacted]

TOPIC Aircraft Engine Plant No 45 in Moscow 25X1A [redacted]

EVALUATION [] 25X1A PLACE OBTAINED [redacted]

DATE OF CONTENT [redacted] 25X1C 25X1A

DATE OBTAINED [redacted] 25X1C DATE PREPARED 29 November 1951

REFERENCES

PAGES 1 ENCLOSURES (NO. & TYPE)

REMARKS

[redacted]

25X1X

1. Aircraft Engine Plant No 45 is located in Moscow, Stalinskaya Quarter. In 1945 and 1946, the production installations at the plant were repaired. Component parts for piston aircraft engines were manufactured, but there was no mass production of piston engines. Trucks occasionally carried spare parts away packed in boxes or individual aircraft engines stored in the plant area. The test stands of the plant were in operation, but they were probably used by other plants which had their engines trucked to and from the test stands. The first component parts of jet engines were seen in mid-1947. According to [redacted] they were of a radial type, probably the Rolls Royce Merit type. No mass production of jet engines was [redacted] nor did statements by Soviet laborers indicate such production. *

25X1A

25X1A

2. At the end of 1947 or the beginning of 1948, [redacted] with the following inscription in workshop 13, the experimental welding shop: "Laborers, technicians, engineers, the Red Army expects your cooperation in Project R.D. 45." Soviet laborers called this engine "reaktivni Dvigatel." **

25X1A

25X1A * [redacted] Comment. The reported dates for the manufacture of jet engines are believed to be not quite correct. [redacted]

25X1X

25X1X [redacted] it must be assumed that the construction of a duplicate of the German axial compressor jet engine started in Plant No 45 in 1947. See [redacted] and [redacted]. However, it appears correct that the Merit type engine was already manufactured in this plant in the summer of 1948, since this information was confirmed [redacted]. See [redacted]. It is estimated that mass production of Merit type engines started in the spring of 1949.

25X1A

25X1A
25X1X *** [redacted] Comment. [redacted] the presence of placards with inciting slogans concerning the construction of jet engines. See [redacted]. In this connection, a TR-1 jet engines was mentioned. If this information is recorded correctly it would indicate a change-over of the plant production to a Merit version with the Soviet designation R.D. 45.

COUNTRY U.S.S.R.

REPORT NO.

25X1A

TOPIC Airframe Plant No 156 in Moscow

EVALUATION 25X1A

PLACE OBTAINED 25X1A

DATE OF CONTENT 25X1C

DATE OBTAINED DATE PREPARED 20 February 1952

REFERENCES

PAGES 2 ENCLOSURES (NO. & TYPE) 6 - 5 sketches on ditto. 25X1A

REMARKS 25X1A



25X1X

1. Plant No 156 in Moscow was located on the western bank of the Yaussa River, just south of Krasnokassarmennaya Ulitsa. An air force general, Hero of the Soviet Union, was plant director. The plant had an estimated work force of 2,000 laborers working two 12-hour shifts and produced airframe models or development series of airframes. (1)

25X1A 2. saw assembled airframes but inferred from wing and fuselage parts that frames for a swept-back jet fighter and for aircraft with straight wings, plexiglass nose, and cockpit were constructed in the plant. Four fuselages and eight wings were simultaneously being worked on. They were moved on mobile cradles from station 1, the skeleton construction department, to station 2, the planning department. About 30 men worked at each cradle. Except for the control brackets, no accessories were installed in the fuselages. Fuselages and wings were disassembled and shipped by truck. The production was very irregular; therefore, the output was not determined. (2)

3. The wings were attached to the fuselage by four cap nuts. The swept-back jet fighter was fitted with tubular wing spars, 30 to 40 mm in diameter, each wing being provided with two spars, one upper and one lower. These spars extended about two thirds of the length of the wing. The outer third of the wing was assembled in rib construction. (3) The aircraft with straight wings was fitted with one double T beam of casted aluminum. Frame members, ribs, and outer skin were connected by rivets. Rivets were treated with liquid air and then dipped into a rubber solution. The outer skin was spliced. (4) Blisters were seldom observed. The use of adhesive fillers was not observed. During the assembly process the individual members were held by tension clamps and screw clamps. The type of work done and the individual production of structural members indicated that the airframes produced were experimental or development models.

4. A stability test was performed in 1947. The front section of the fuselage of the aircraft with straight wings was cut off aft of the cockpit and sealed by a bulkhead (lid). At first, a box was placed in the nose and filled with water. By means of sticks and markings the bending of the nose was determined. Then a water hose was connected to the nose, hermetically sealed, and water was forced into the fuselage section including the cockpit. Before any deformations were noticed, the bulkhead was turned loose and the tests were

Legend.

- A Yaussa River
- B Kresnotassarmennaya Ulitsa
- C Plant No 156
1. Guardhouse.
 2. Boiler house, 15 x 30 m.
 3. Main workshop, construction department for wings and fuselages, brick building, 60 x 120 x 70 meters.
 - a. Middle section with arched roof. The roof was a steel structure covered with wood and had no sky lights. The hall was equipped with jigs and fixtures for assembling wings and fuselages, and 50 to 60 metal processing machines including bending machines, boring machines, milling machines, grinding machines, work benches, cutting machines etc. Production lines were not available.
 - b. Two-story section with arched wooden roof. For breakdown see Annex 2.
 - c. Two-story section with arched wooden roof. For breakdown see Annex 3.
 4. Compressor station, old brick building, 4 x 8 meters, with flat concrete roof and large windows. There was one compressor. The station was equipped with a small workshop and a small store for spare parts.
 5. Transformer station, plastered brick building, 10 x 30 meters, with a flat roof. There were two large and eight small subsections on each side of the building. The installation was fenced in and guarded. Open-air lines were not seen.
 6. Molding shop, foundry, drop forge, and cast polishing shop; old brick building, 10 x 30 meters, with flat roof. For details, see Annex 4.
 7. Oil dump, old open-air installation, with semi underground tanks protected by a roof. An electric pump was located beside the roof. Oil arrived by tank trucks. An overground fuel line led to the drop forge. During the winter the dump was heated with steam.
 8. Administration building and lathe shop, brick building, 120 x 50 meters, three stories. The ground floor housed a lathe shop with approximately 20 modern and old lathes, 20 milling machines, four horizontal grinding machines and an autogeneous welding machine. Stores and offices were located on the ground floor also. The lathe shop did repair work and produced screws etc. The second floor housed a kitchen and mess hall, a dispensary, a department producing fuel tanks (according to Soviet statements), and probably a plexiglass shop. [REDACTED] transports of gummed cellulose, plastic material slabs, and bales of foam rubber about 5 mm thick. Boxes, which according to Soviet statements, contained fuel tanks were observed. However, tanks were not installed in fuselages and wings of the aircraft produced in the plant. The production of plexiglass was inferred from observations of waste material from this department which was burned in the boiler house, and the shipment of plates, 5 mm thick to the magazine. The third floor housed a museum with aircraft models, the director's office, and the construction department. Museum was

25X1A

CONFIDENTIAL [REDACTED]

25X1A



was the designation used by the Soviet workers.

9. Garages and stalovaya. *

* no translation given.

25X1A

CONFIDENTIAL



Annex 2 to



25X1A

Airframe Plant No. 156 in Moscow, Section b of Main Workshops

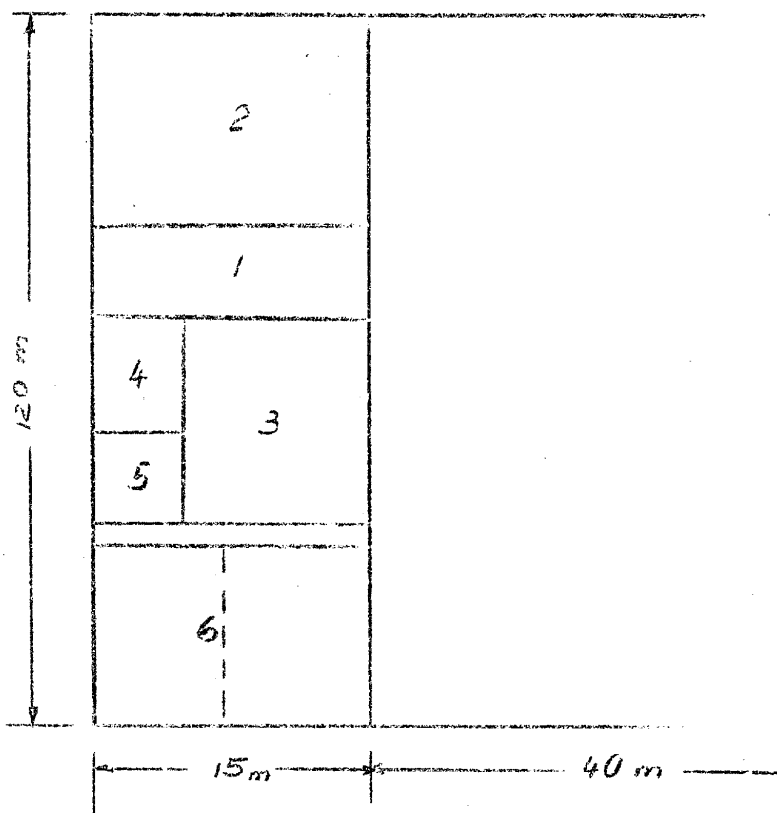

Legend: See next page.

not to scale

CONFIDENTIAL

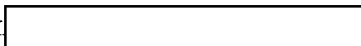

25X1A

Legend:

Ground Floor

1. Hall leading to middle section of the building.
2. Pattern making carpenter shop equipped with planing machines, band saws, glue presses etc for the production of moulds for the foundry and of models to form the skin for wings and fuselages.
3. Store for materials and semi-finished products.
4. Paint shop equipped with 10 to 12 paint sprayers, wooden parts were sprayed with a transparent varnish, moulds for the foundry were painted red or black, presumably to indicate the use of different materials.
5. Office.
6. Machine shop, about 15 x 20 meters, subdivided into sections by a wire fence. Lathe shop, equipped with 25 to 30 old Soviet lathes for screws, nuts, bolts, and joint pieces for control brackets. The metal processing shop was equipped with 8 to 10 small and large milling machines, 5 shaping machines, 5 or 6 planing machines, 10 boring machines, one mobile and one stationary horizontal boring machines, 4 modern horizontal grinding machines, 4 cylindric grinding machines etc. The machines were old but in a good shape. The workshop was equipped with electric lorries for shipment of processed parts to the assembly and to the stores.

The second floor housed dressing rooms, drafting offices, mess hall, and a store for spare parts.

CONFIDENTIAL, [REDACTED]

25X1A

CONFIDENTIAL

Annex 3 to

Airframe Plant No. 356 in Moscow, Section c of Main Workshop

A (Ground Floor)

B (Second Floor)

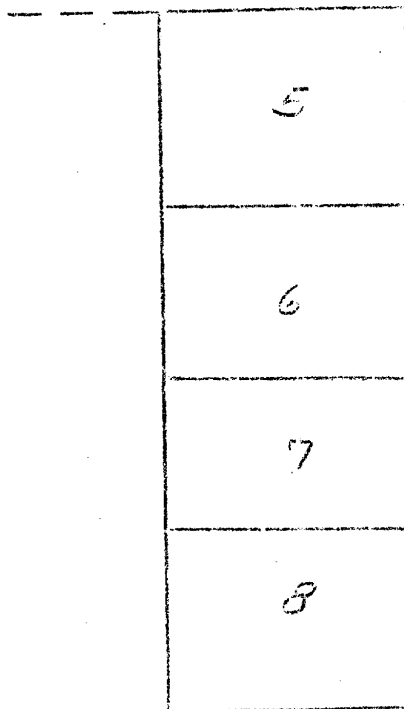
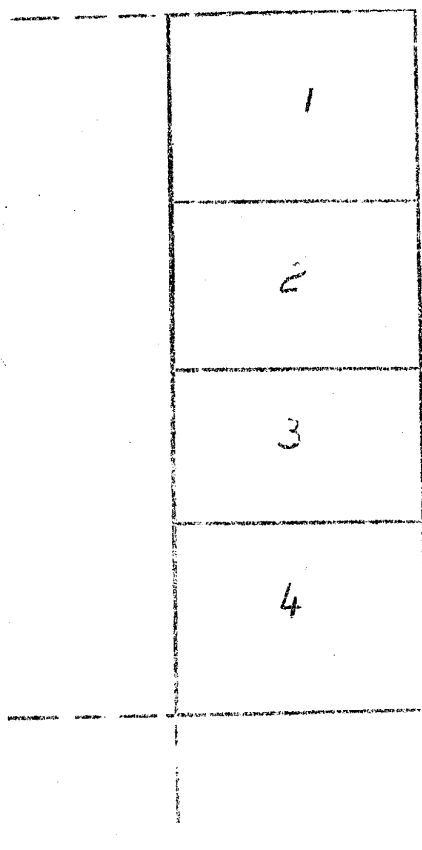

Legend: See next page.

not to scale

CONFIDENTIAL

Legend:

A Ground floor

1. Electric workshop and store.
2. Welding shop with 18 to 20 cabins equipped with 8 electric welding apparatus, and several connections for gas welders. [redacted] an unusual flame, different from carbide gas flames. The section worked on ammunition boxes [redacted]
3. Workshop producing ribs and frame members, equipped with 12 straightening machines, about 4 automatic plate shears for sheets 1 to 1.8 mm thick. The section produced U and Z shaped profiles.
4. Galvanizing shop, appeared obsolete and was equipped with 9 or 10 baths 1 x 2.5 meters. The electric switchboard was also in this department. The section processed aluminum sheets, about 100 x 180 cm and 1 mm thick, which were to be taken for the outer skin of the wings. After being degreased the sheets were provided with a protective coating which had a dark golden sheen. Aluminum sheets of the same length or width but 1 to 3 mm thick were provided with a protective coating of an ochre colour. [redacted] this material to be less resistant; food boxes, map cases etc were produced from it. Other aluminum sheets of the same size got a protective coating similar to silver bronze. These sheets were finally dipped into a bath and provided with a black coating. [redacted] that this material was used for bracings and concluded that it was very resistant.

25X1A

25X1A

25X1A

25X1A

B First Floor

5. Room, use of which is unknown.
6. Kitchen.
7. Store with welded parts.
8. Room, use of which is unknown.

CONFIDENTIAL [redacted]

25X1A

25X1A

CONFIDENTIAL [REDACTED]

[REDACTED] 25X1A

discontinued. (5)

[REDACTED] Comments.

25X1A

- (1) The plant location was confirmed by a previous report. See The street just north of the plant was the Radio Street and its extension southeast of the bridge over the Yaussa River was Krasnokassarmennaya Ulitsa. For plant layout, see Annex 1. The sketch does not correspond with an aerial photograph. For a better layout of plant, see [REDACTED]. For a reproduction of the firm plate, see Annex 5. Hero of the Soviet Union, General Georgiev was previously reported to the plant director. See [REDACTED].
- (2) For layout of individual workshops, see Annex 2 to 4. The reported activities seem to be credible and confirm Zavod 156 as an experimental plant. Plant 156 was known as a section of the Zagi Institute.
- (3) As there are four cap nuts and only two spars reported, the description of the wing is not clear. Only two cap nuts would be required to fasten two spars. Furthermore, it is not understood what type of construction [REDACTED] is referring to by rib construction, and why the spars should not extend to the wing tips.
- (4) [REDACTED]
- (5) The experiment was probably the testing of a pressurised cabin.

25X1A

25X1C

CONFIDENTIAL [REDACTED]

25X1A

Annex 1 t

Plant Layout of Airframe Plant No. 156 in Moscow

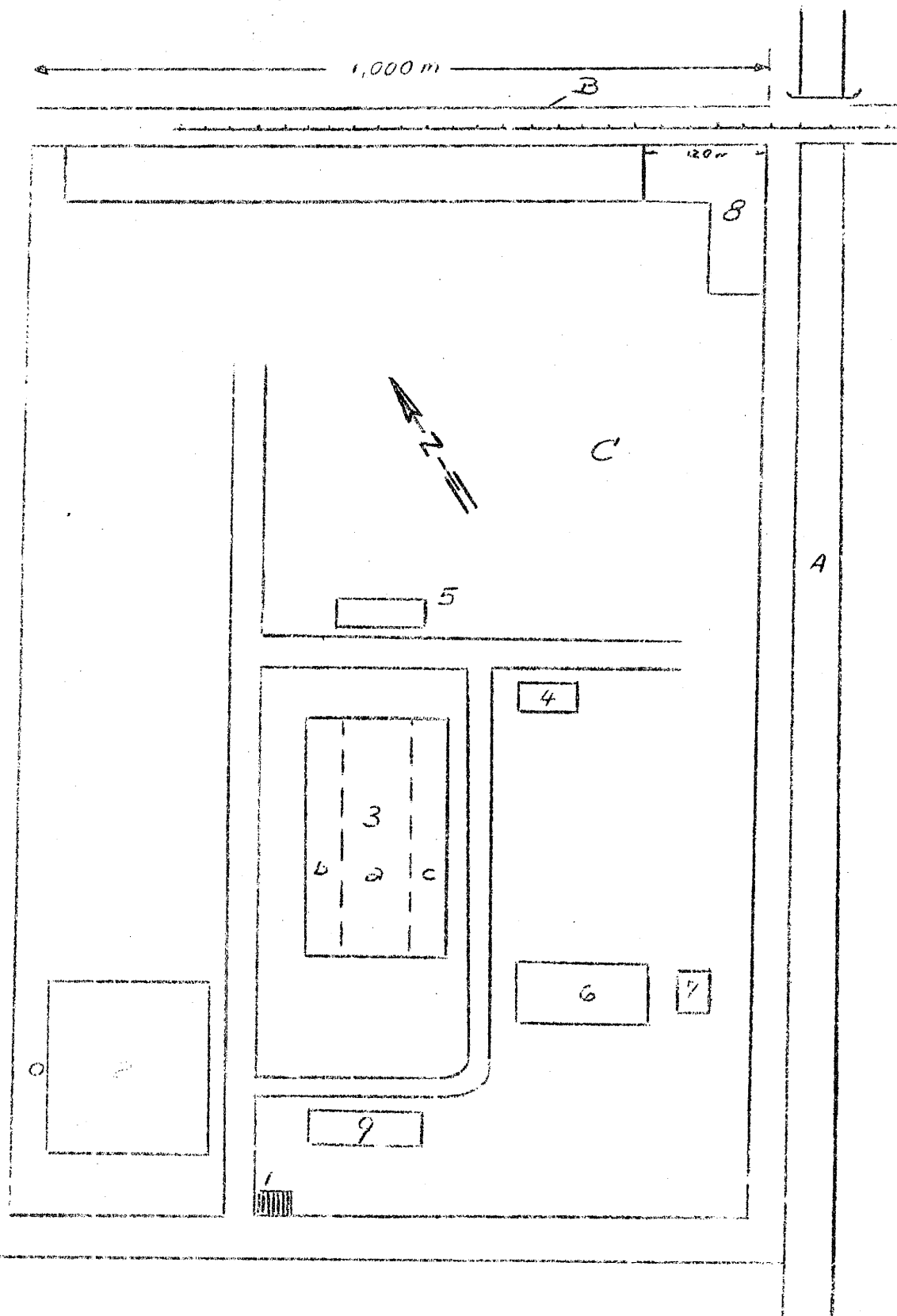

Legend: See next page.

not to scale

25X1A

CONFIDENTIAL

Annex 4 to

Airframe Plant No. 156 in Moscow, Lathe Shop, Loulding Shop, and Iron Forge.

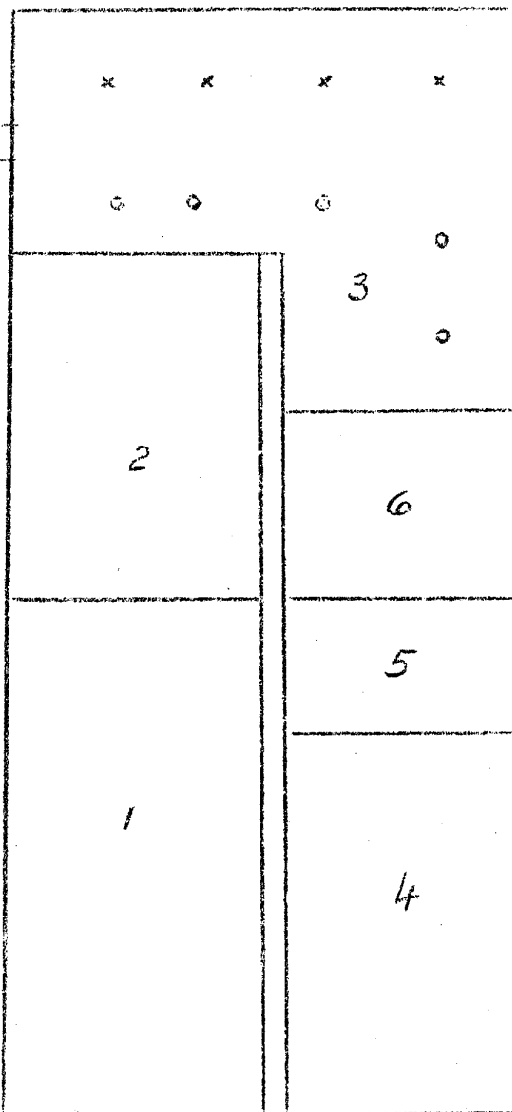

x = Oil furnaces

o = Hydraulic hammers

Legend: See next page.

not to scale

CONFIDENTIAL

25X1A

25X1A

CONFIDENTIAL [REDACTED]

ANNEX 4 TO

25X1A

2

Legend:

1. Molding shop equipped with 2 pneumatic stamping machines, 1 mixer similar to a concrete mixer, 2 electric drying stoves which indicated a temperature of 120° C, and 1 mold sand dressing machine. The models were made of wood and aluminum. The shop appeared outdated. [REDACTED] models for yokes and supports for rollers. 25X1A
2. Foundry equipped with 5 or 6 electric and 15 oil fueled casting furnaces with a capacity of 30 to 40 liters each. Aluminum bars and scrap were melted. Admixtures were not determined.
3. Drop forge equipped with 4 oil fueled annealing furnaces, 1 trolley, 2 large hydraulic hammers, 2 small hydraulic hammers, and an additional large hydraulic hammer which was not in operation. Raw material was shipped on truck. Aluminum bars, square and rectangular in section, were processed. No details are available.
4. Cast polishing shop, equipped with pneumatic hammers and a riddle.
5. Office.
6. Storage for casting models.

CONFIDENTIAL [REDACTED]

25X1A

25X1A

CONFIDENTIAL



Annex 5 to



25X1A

Trade Mark

of airframe Plant No. 156 in Moscow

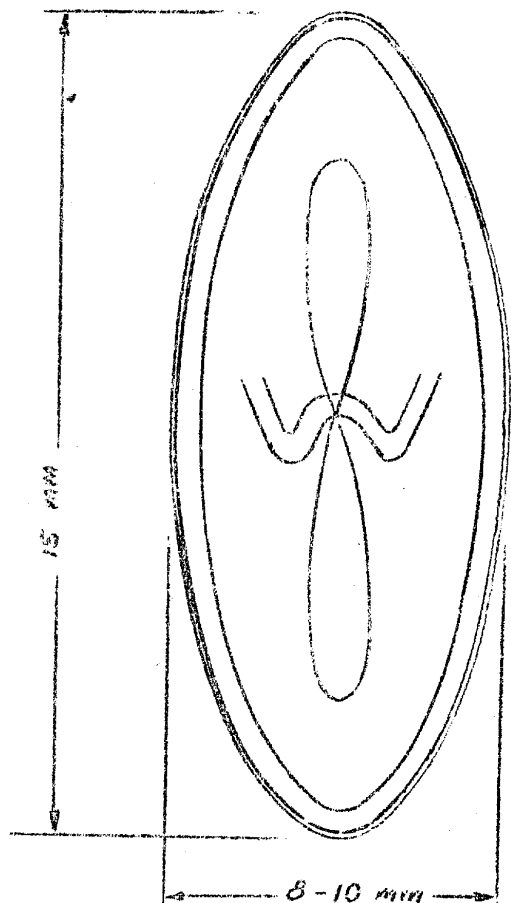

not to scale

CONFIDENTIAL

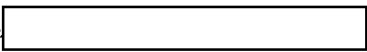

25X1A

25X1A

CONFIDENTIAL/ [REDACTED]

of the plant are still under reconstruction. The plant number "507" is reported for the first time.

b. The plant location is the same as previously reported. According to older records, the northern part of the plant is a former ammunition plant, where the rayon plant was transferred after the war.

c. The reproduction of the plant layout on attached sketch is rather diagrammatic. [REDACTED] From comparison with a previous sketch it can be assumed that the essential plant buildings are correctly reported as to their location. No details are available on the type of construction of the various buildings.

d. [REDACTED] reported the production of rayon for parachutes. [REDACTED] observed the production but only heard about it. [REDACTED]

1. Annex : Rayon Plant in Klin.

25X1A

Legend to Annex

Rayon Plant in Klin.

- 1 Garage
- 2 Three workshop buildings
- 3 Building, 200 x 120 m, with four workshops, manufacturing of fibers from cellulose
- 4 So-called paper department, cellulose plates are reduced to fibers
- 5 Power plant, 100 x 40 m, with two peat fueled boilers and two turbines. Annex at the northwest side of the building; according to Soviet statements, two additional turbines are to be installed here. Foundations were completed in the September 1949.
- 6 Old workshop, partially destroyed, used as storage.
- 7 Newly constructed workshop, 100 x 120 m, the northwest section in operation since May 1949. The southeast section was almost completed by September 1949. Machinery was being installed. Assumed to be a spinning mill.
- 8 Annex to No. 7, foundations under construction in September 1949
- 9 Garage.

CONFIDENTIAL/ [REDACTED]

25X1A

CONTROLLED DISTRIBUTION

SECRET

Annex to (Air)

Rayon Plant in Klin

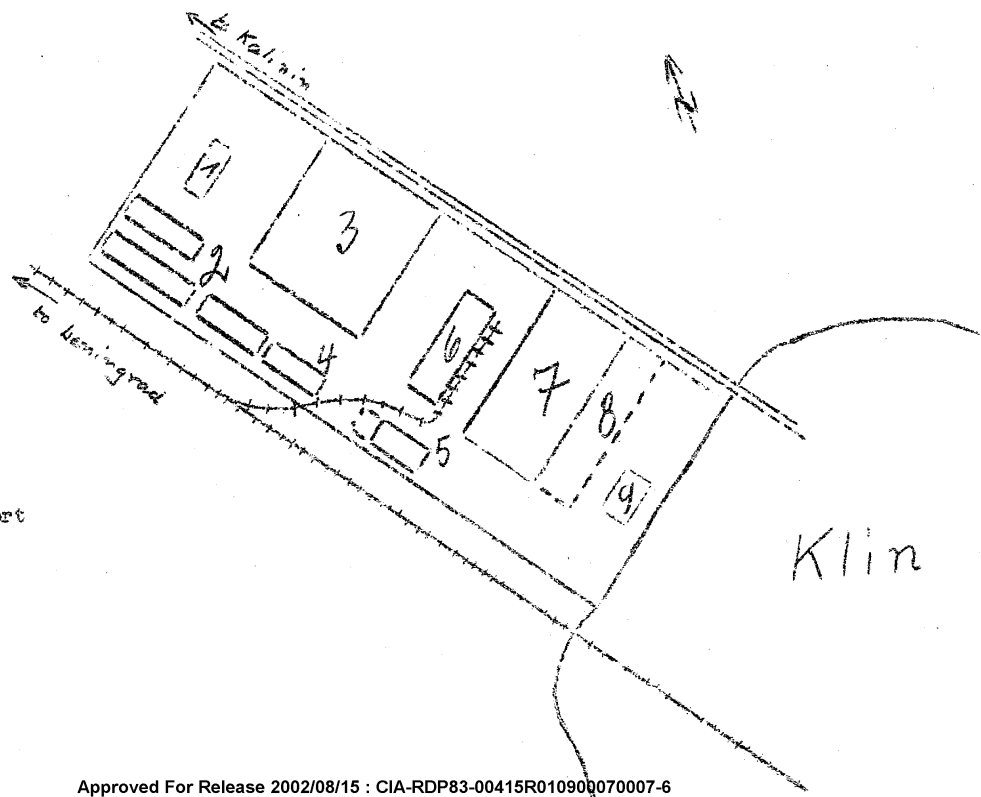

Legend: See report

COUNTRY Soviet Union REPORT NO. _____

TOPIC Rayon Factory No. 507 in Klin 25X1A

EVALUATION 25X1A PLACE OBTAINED 25X1A

DATE OF CONTENT 25X1C

DATE OBTAINED DATE PREPARED 11 May 1950

REFERENCES 25X1C

PAGES 2 ENCLOSURES (NO. & TYPE) 2 Sketches on Ditto

REMARKS _____

RETURN TO CIA
LIBRARY

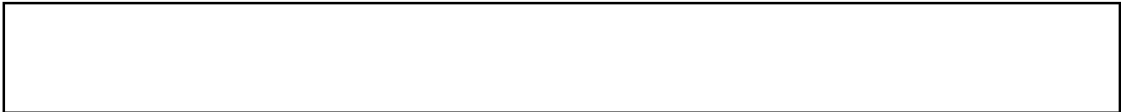

25X1X

1. Location :

Northwestern town border of Klin (36°45'E/56°21'N), Moscow Oblast, between the town and the railroad line to Kalinin.

2. Plant installations :

The plant, Soviets said, was constructed in 1933 and was still being enlarged at the time of observation. For status of constructions in June 1949 see Annex 1. The plant-owned power source also supplied the town with electricity. A railroad connection was available.

3. Work force :

Eight hundred men and 2,700 women working three shifts.

Production :

War-time production, parachute rayon (Soviet statement); present production rayon fibers and fabrics, similar to footless stockings, 25 cm long, 6 cm in diameter; parachutes for flares Boxes with fibers daily left the plant. Bale packages of cellulose arrived from Finland and Germany; acid came from Germany.

25X1A

CONFIDENTIAL

25X1A

25X1A

 Comment :

- a. The plant location was previously clarified.
- b. Attached sketch seems to approach facts as it agrees with a previous diagrammatic sketch * on the location of the essential plant buildings. The main production shop and power plant are reproduced for the first time.
- c. The production data are of special interest. Previous information, reporting a peace-time production of parachutes, seems incorrect. The above reported stocking-like fabrics are believed to be technical bandages for struts, spars etc, rather than parachutes for flares.

2 Annexes : Plant Layout of the Mayon Plant no. 507 in Klin.

CONFIDENTIAL

25X1A

25X1A

CONFIDENTIAL

25X1A

Annex

Legend to Annex 1 and 2

- 1 Repair shop, brick building, 40 x 12 x 6 meters, with carpenter shop and fitting shop
- 2 Laboratory, four-story brick building, 15 x 10 x 10 meters
- 3 Administration building under construction
- 4 Cellophane department under construction
- 5 Large "capron" fiber manufacturing workshop, brick building, 140 x 90 x 8 meters, (see also Annex 2).
- 6 Tearing installation for cellulose, 90 x 10 x 8 meters
 - a Tower, 25 meters high
- 7 Cellulose stores
- 8 Chemical department, five-story brick building, 20 x 15 x 15 meters
- 9 Old garage and repair shop, 30 x 10 x 6 meters, two stories
 - a Three-story section, 15 meters high
- 10 Water tower, 15 meters high, ground diameter 10 meters, top diameter 7 meters
- 11 Material stores, brick building, 25 x 10 x 8 meters
- 12 Guard house
- 13 Three entrances
- 14 Surveyed construction site
- 15 "Capron" fiber department No. 2, iron structure, 140 x 60 x 15 meters
 - a Five-story office annex

The machinery came from the Hamel spinning mill in Hirschberg. The workshop has been in operation since November 1943.
- 16 Bare structure of annex, iron structure, 144 x 60 x 15 meters

CONFIDENTIAL

25X1A

25X1A

CONFIDENTIAL

25X1A

(
Annex

- 17 Garage, 50 x 40 x 10 meters, capacity 60 motor vehicles
- 18 Slag dump
- 19 Water tower, 5 x 5 x 10 meters
- 20 Pump station, brick building, 25 x 10 x 3 meters
- 21 Lime mill
- 22 Power plant, brick building 80 x 50 x 18 meters, six stories, with four boilers and three turbines, (see also Annex 2).
- 23 Peat and coal dump.

CONFIDENTIAL

25X1A

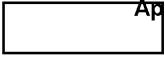

DISTRIBUTION

CONFIDENTIAL

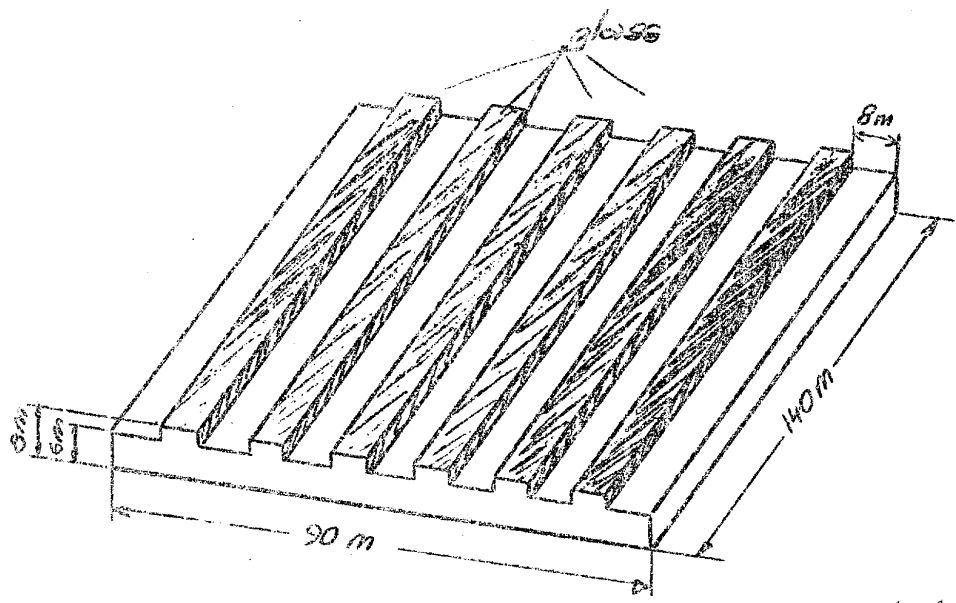
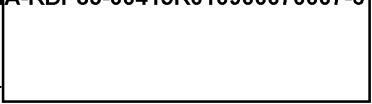

scale 1:1,000

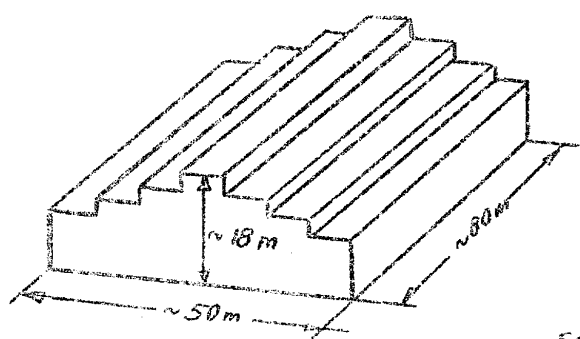

scale about 1:1,000

CONFIDENTIAL

COUNTRY U.S.S.R. REPORT NO.

TOPIC Hydro-Power Plant under construction near Gorodets.

25X1A

EVALUATION 25X1A PLACE OBTAINED 25X1A

DATE OF CONTENT 25X1C

DATE OBTAINED 25X1C DATE PREPARED 3 July 1950

REFERENCES

PAGES 2 ENCLOSURES (NO. & TYPE)

REMARKS

RETURN TO CIA LIBRARY

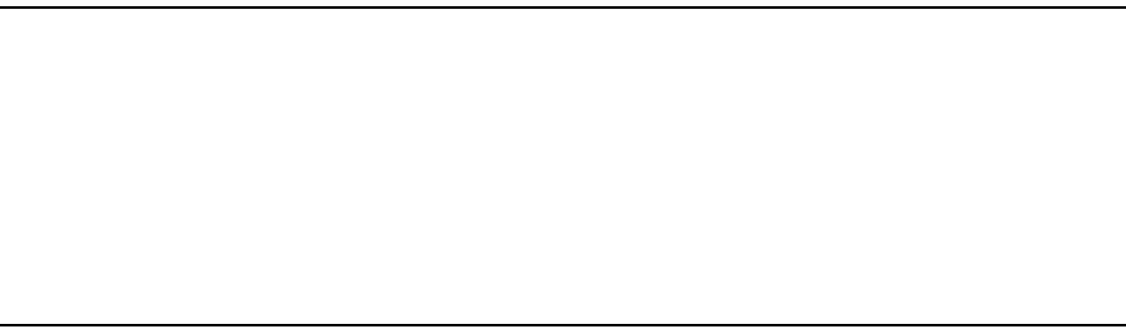

25X1X

1. A new dam for a large hydro-power plant was under construction near Gorodets (43°28'E/56°03'N), Gorki Oblast, on the Volga River, about 18 kilometers from Balakhna. Soviets stated that the plant will be larger than the Zaporozhe Power Plant. In mid-1949 the dam had reached such a height that it was clearly visible from Balakhna. The bare structures of roofless buildings at the dam heads were also identified from that distance. Convicts and free Soviets did the construction work. About 3,000 laborers from Balakhna arrived daily at the construction site by truck during mid-1949. Placard advertisements asked for voluntary laborers. Due to the strenuous labor, poor quarters, food and salary, only a few workers were expected to volunteer for those jobs.

2. The dam and the power plant will be the largest of their kind in Europe. Half of the project was to start operation in 1950, and full operation was planned for 1952. No details were available on the construction. A railroad line under construction on the western bank of the Volga River was observed from the Balakhna railroad station. The construction extended upstream, and 2 or 3 kilometers of the railroad embankment were completed by October 1948. Special railroad cars that tipped, and which, according to their inscriptions, were manufactured in Koenigsberg, were to be used for the further construction of the railroad line.

25X1A

25X1A

CONFIDENTIAL

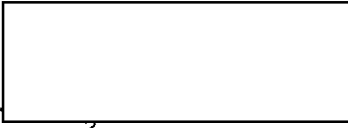

2

3. The construction project, about 18 kilometers north of Belakhna, was designated Volgastroi. It was known [redacted] to be a dam with hydro-power plant under construction. [redacted] German engineers working on this project [redacted] 20 German engineers with their families were drafted from the Soviet Zone of Germany to work here. [redacted] it was said that if the new hydro-power plant was completed within the program of the next Five-Year Plan, the bottleneck in the power supply will be overcome within this period. *

25X1A

25X1A

25X1A

* [redacted] Comment. The new hydro-power plant under construction is reported for the first time. The corresponding statements of the [redacted] No details are available on location and type of construction.

25X1A

25X1A

CONFIDENTIAL

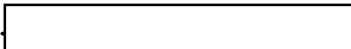

25X1A

COUNTRY Soviet Union REPORT NO.TOPIC Yaenz Electromotor Plant No 655, Yaroslavl

25X1A

EVALUATION 25X1APLACE OBTAINED DATE OF CONTENT

25X1C

25X1A

DATE OBTAINED DATE PREPARED 12 May 1950

REFERENCES

PAGES 1 ENCLOSURES (NO. & TYPE) 1 sketch on ditto

REMARKS

RETURN TO CIA
LIBRARY

25X1X

1. Location: In the northern town section of Yaroslavl (39°52'E/
57°37'N), east of the automobile plant.
2. Plant installations: Seventy percent of the plant area (about 5.0
x 3.0 meters) is built up. The war damages were completely re-
paired, and the plant was ready for full operation. There was a
railroad connection. For plant layout, see Annex.
3. Work force: About 3,000 laborers, 60 percent women and 25 percent
minors, working three shifts; 140 P.M.s also worked one of these
shifts.
4. Production: Electric motors, with armature diameter varying from
15 to 110 cm. Monthly output: 600 motors of various sizes, 1,000
irons, 1,000 table ventilators and 20 to 25 boxes resembling trans-
formers per month. Production data were obtained while packing
and loading products. Taped wire was the only component part not
manufactured at the plant.

25X1A

 Comment:

a. The location of the Yaenz (or Yageaz) Plant was known from other information. This report gives the latest information. Though merely diagrammatic, the attached plant layout seems correct when compared with a previous sketch. The type of building construction is reported for the first time.

b. During the war, the plant was important to the air armament industry. It now seems to be producing for civilian use. No details are available on the types of motors and implements produced.

1 Annex: Plant layout of Yaenz Electric Motor Plant No 655, Yaroslavl.

CONFIDENTIAL

Annex

25X1A

Legend to Annex:

- 1 Apprentices' quarters, stone building covered with tarred roofing paper, 50 x 10 x 5 meters
- 2 Laundry
- 3 Wire drawing shop, brick building covered with tarred roofing paper, 40 x 10 x 7 meters, equipped with five armature winding machines and one large wire drawing machine, 8 to 9 meters long. Some of the 7-mm copper wire is flat and some semicircular.
- 4 Foundry, three-story brick building covered with tarred roofing paper, 65 x 40 x 9 meters, equipped with two coke-fueled furnaces, four trolleys, one large molding machine, 10 small, manually-operated molding machines, one mixing machine, four polishing drums, and three manually-operated milling machines. The model-making carpenter shop was on the second floor.
- 4a Coke and iron depot, iron and brick building with cement slab roof, 60 x 40 x 7 meters.
- 5 P. camp No 7276/48
- 6 Park, with Lenin monument
- 7 Administration building, three-story brick building with red brick roof, 50 x 15 x 9 meters
- 8 Main plant building, 120 x 100 x 8 meters, iron and brick structure with glazed shed roof; included fitting shop, press cutting shop, die making shop, motor manufacturing shop, iron and ventilator production shop, electric repair shop, packing shop, and motor storerooms.
- 9 Boiler house, 50 x 30 x 9 meters, brick building with red roof and 40 to 45-meter brick smokestack.
- 10 Forge and hardening shop, brick building covered with tarred roofing paper 30 x 20 x 5 meters
- 11 Brick building, 60 x 30 x 10 meters, three stories, with kitchen, messhall, club and motion picture theater.

CONFIDENTIAL

25X1A

CONTROLLED DISTRIBUTION

Plant layout of the Yaemz Electromotor Plant No. 655
in Yaroslavl

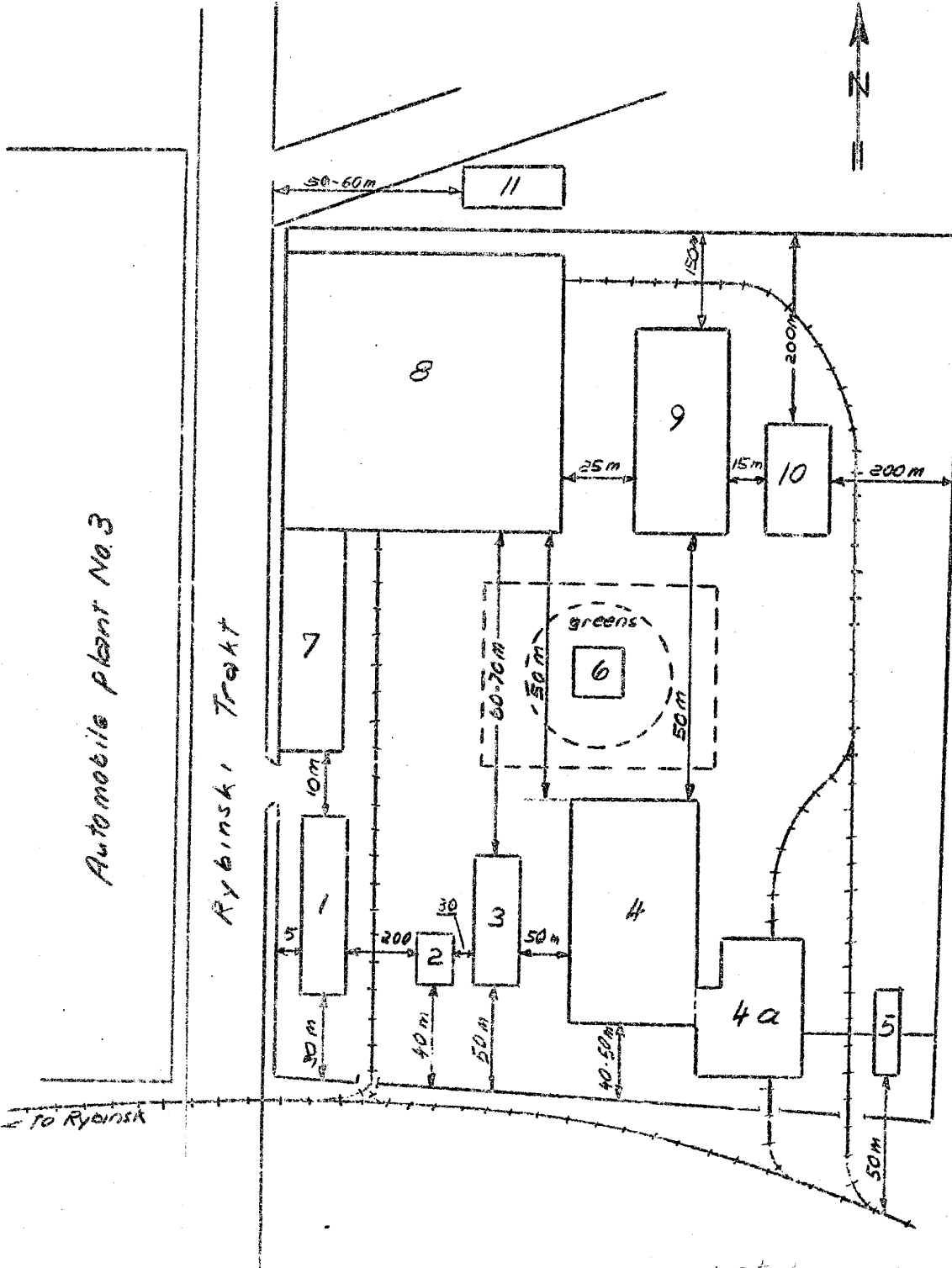

For legend see report

CONFIDENTIAL

COUNTRY U.S.S.R. REPORT NO.

TOPIC Railroad Car Factory and Repair Plant in Kanash

25X1A

EVALUATION [] 25X1A PLACE OBTAINED [] 25X1A []

DATE OF CONTENT [] 25X1C

DATE OBTAINED [] DATE PREPARED 4 January 1952

REFERENCES

PAGES 2 ENCLOSURES (NO. & TYPE) 1 sketch on ditto

REMARKS

RESEARCH LIBRARY

ILLEGIB

25X1X

1. The railroad car plant was about 3 km northwest of the outskirts of Kanash (55°30'N 47°30'E) Chuvash SSR. A spur track, entering from the west and branching into two main tracks, led from the Kanash railroad station to the plant. There was also a highway between the town and the plant. *
2. The plant covered an area of about 1,200 x 350 meters. The plant comprised two workshops for railroad car repair and assembly and included a painting shop, a foundry with a molding shop, a forge, a machine shop and several auxiliary and secondary installations. Power was supplied from a plant-owned coal-fired power station equipped with a boiler installation. The power station was used only to supply the plant and the surrounding residential barracks buildings. **
3. In 1947, all kinds of freight cars, one third of them oil tank cars, were overhauled and repaired in the plant. In the summer of 1947, a sporadic production of 20-ton flatcars was also started. In 1947, a weekly average of 30 railroad cars was overhauled. The wheels and axles were supplied from the outside and were processed and mounted in the machine shop. The remaining component parts were produced in the plant itself. No expansion of the plant was observed. ***
4. The supply of raw materials and semi-finished products was irregular. Incoming shipments comprised six to eight 20-ton freight cars per month, loaded with wheels and axles, round and polygonal iron, and sheet metal. Five to seven carloads of coal arrived weekly. The coal consumption of the forge amounted to 40 to 50 tons weekly.
5. In 1947, about 1,200 workers were employed in the plant. Work was done in two eight-hour shifts. There was an occasional three-shift schedule in the forge. In 1947, the number of PWs employed in the plant was about 300.

25X1A

25X1A

* [] Comment. [] the plant was located 2 km north of the outskirts of the town. The Kanash-Kazany (55 45'N/49 08'E) railroad line passed near the western edge of the plant. There are spur tracks running through the plant from east to west. At the eastern edge of the plant, the tracks curve in a southerly direction to the Kanash railroad station. This is not indicated in the Annex.

CLASSIFICATION CONFIDENTIAL []

25X1A

25X1A

CONFIDENTIAL



- 2 -

25X1A

** [redacted] Comment. For layout sketch of this plant, see Annex. This information generally agrees with previous information, although the dimensions of the second assembly and painting shop are larger than previously reported. The information on the foundry has not been previously reported.

25X1A

*** [redacted] Comment. The Kanash Railroad Car Repair Plant was built between 1935 and 1937 and was scheduled to have an annual capacity for the repair of 2,500 freight cars. The weekly repair rate of 30 cars, i.e., 1,560 cars annually,

25X1A

[redacted] would indicate that the capacity of the plant is not fully utilized.

CONFIDENTIAL



25X1A

Layout Sketch of the Kanash Railroad Car Repair Plant

LEGEND : see next page

ANNEX

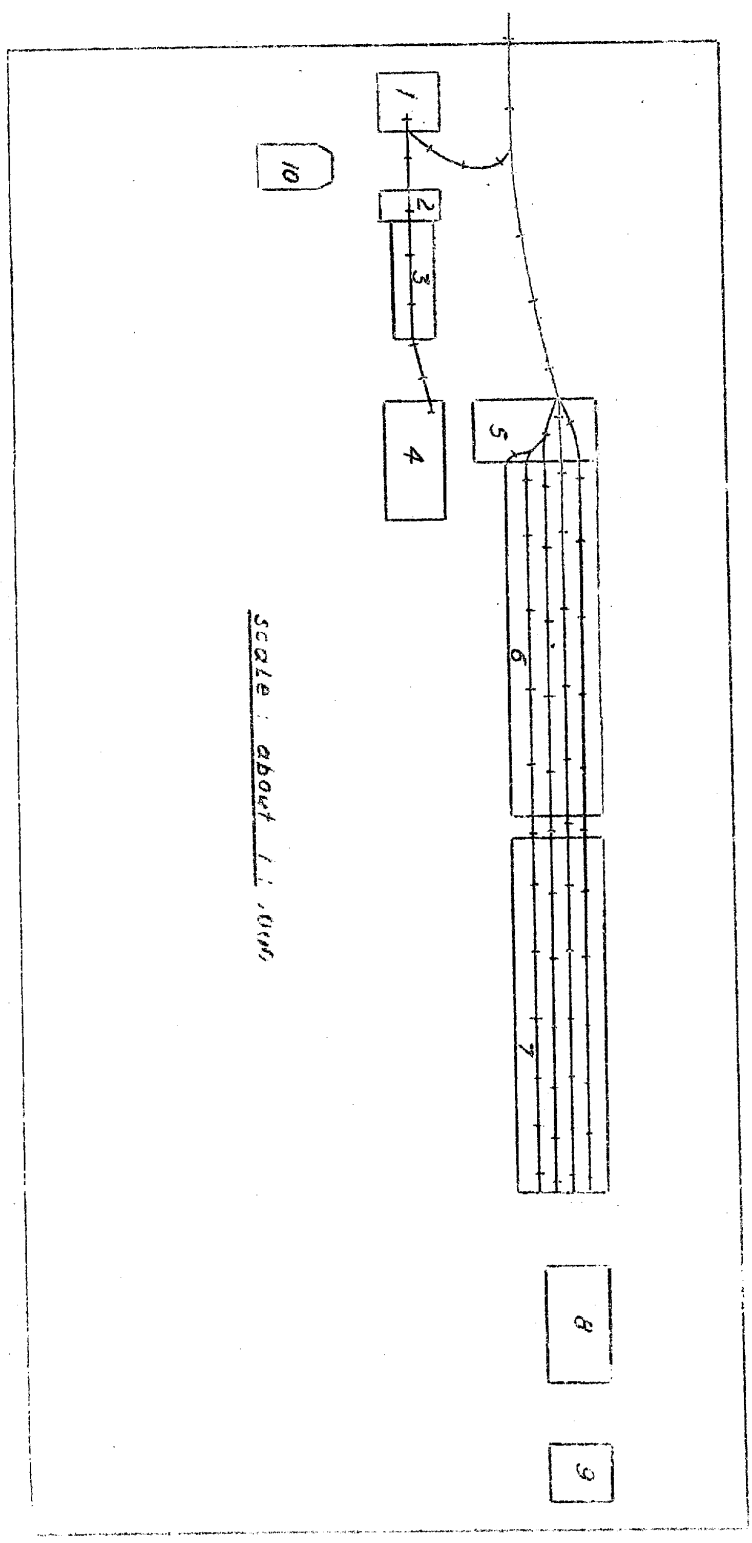
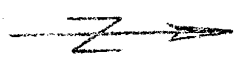

CONFIDENTIAL

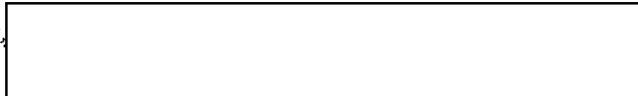

Annex to

Legend:

1. Foundry and molding shop, about 50 x 50 meters, equipped with two smelting furnaces with a capacity of seven tons each.
2. Rough-processing department, about 50 x 25 meters. Production of this department included buffer plates and railroad car frames.
3. Forge, about 100 x 70 meters. It was equipped with 4 coal-fired annealing furnaces, about 4 x 2 meters, each 2 meters high; 2 smaller furnaces; 2 large and 5 small steam hammers. This forge produced buffers, hooks and parts of undercarriages.
4. Machine shop, about 100 x 50 meters. It was equipped with eight lathes for wheels and axles, a device for mounting wheels, and about 20 different small machine tools. There was also a spare parts depot.
5. Rust removing department, about 100 x 50 meters. This shop removed rust from wheels, axles and other parts. The department also had a small forge and a workshop for the production of springs.
6. Repair and assembly shop, about 300 x 50 meters. Railroad cars were repaired and overhauled. There was space for 32 railroad cars with eight cars placed on each of the four tracks.
7. Assembly shop and railroad car painting shop, about 300 x 50 meters. Cars were assembled and repaired, and completed cars painted.
8. Warehouse for storing and drying timber.
9. Sawmill.
10. Power station.

CONFIDENTIAL



25X1A

COUNTRY U.S.S.R. REPORT NO. _____

TOPIC Weapon Plants No 535 and 536 in Tula

EVALUATION 25X1A PLACE OBTAINED 25X1A

DATE OF CONTENT 25X1C

DATE OBTAINED DATE PREPARED 21 November 1951

REFERENCES _____

PAGES 2 ENCLOSURES (NO. & TYPE) 1 - sketch on ditto

REMARKS _____

RETURN TO CIA LIBRARY

25X1X

1. Weapon Plants No 535 and 536 were on the western outskirts of Tula (37°37'E/51°11'N). They were affiliated plants and had a narrow-gauge railway connection. Both plants were old installations which were re-equipped, mainly with German machinery, after the war. Late in 1949 only a small amount of building work was being done in Plant No 536, while brisk building activity was observed in Plant No 535. The exact extent of the construction work was not known. *

2. Products of the plant were observed in storage places and during unloading. The production of Plant No 535 consisted of 85- or 100-mm AT guns, which the Soviets called new guns; light AA guns estimated to be between 30 and 50 mm, and 120-mm mortars. The production of Plant No 536 consisted of machine guns, pistols, submachine guns, light AT rifles, and hunting rifles. 25X1A

the weapons produced were models known from wartime. could not even estimate the production of Plant 535. Occasionally up to 100 AT and AA guns were on stock. Every day at noontime the products manufactured in Plant No 536 were packed in boxes and loaded into two freight cars of the narrow-gauge railroad line. The total number of boxes was 90 to 100, each weighing about 100 kg. The boxes were 150x60x50 cm, 120x60x50 cm, and 90x50x50 cm. Despite the differences in sizes, the weight of each box was about the same. Two were 25X1A required to carry one box. The outgoing shipments of both plants were loaded in Plant No 535. Most of the shipments went by rail and only rarely by truck.

3. Incoming shipments consisted only of raw materials such as metal bars, rods and strips, and lumber for boxes. Plant 536 supplied the Plant 535 with screws, nuts, semi finished materials for breechblocks, axles and base plates for mortars, and cut raw materials.

4. Power was supplied by a high-tension line, allegedly from a power plant in or near Tula. the number of employees of both plants totaled 15,000 to 16,000 usually working in two shifts although in some departments three shifts were worked. in the end of 1949, there were 10,000 employees in Plant No 536 and a considerably smaller number in Plant No 535. Thirty to fifty percent of the workers were female. The plants were surrounded by a high wooden fence and armed guards. There were fire departments in both plants.

CLASSIFICATION

CONFIDENTIAL

25X1A

[REDACTED] 25X1A

CONFIDENTIAL [REDACTED]

25X1A

- 2 -

25X1A

[REDACTED] Comment. For location and layout sketch, see Annex. The track installations as shown in sketch are incorrect. The railroad line crosses the Upa River on the westernmost bridge. The wide-gauge spur track connection with Plant No 535 comes from the west. There is a narrow-gauge railroad line between Plant No 536 and Plant No 535.

CONFIDENTIAL [REDACTED]

25X1A

CONFIDENTIAL

Annex to

Legend:

- A. Tula town area.
- B. Upa River.
- C. Three bridges crossing the Upa River.
- D. Branch of the Upa River.
- E. Weapon Plant No 535:
 - 1. Material dumps.
 - 2. Production workshop.
 - 3. Heating plant.
 - 4. Firing ranges.
 - 5. Area with 10 to 15 small workshops.
- F. Weapon Plant No 536:
 - 1. Material dumps.
 - 2. Production workshops. There may be 4 workshop buildings, instead of only 2 as shown.
 - 3. Heating plant.
 - 4. Underground fuel depot.
 - 5. Workshops and administration buildings.
 - 6. Transformer station.

CONFIDENTIAL

25X1A

LEGEND: see next page

25X1A
Approved For Release 2002/08/15 : CIA-RDP83-00415R010900070007-6 ~~LINEA~~ 7

CONFIDENTIAL

25X1A

Location and Layout Sketch of Weapon Plants No 535 and No 536 in Tula

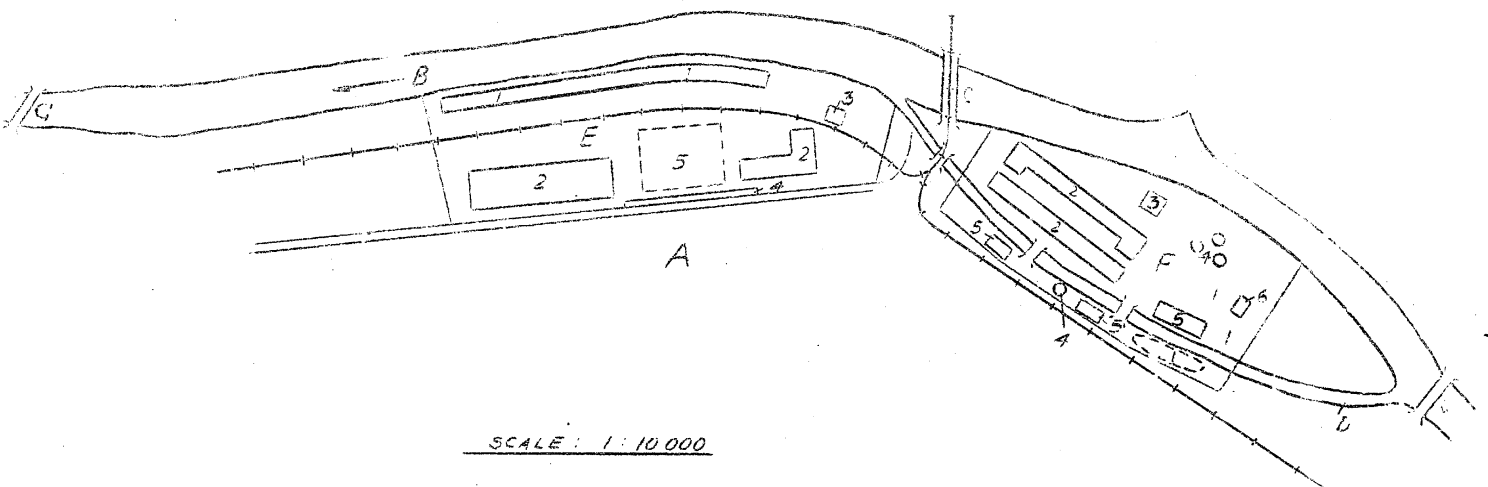

CLASSIFICATION CONFIDENTIAL

25X1A

COUNTRY U.S.S.R.

REPORT NO.

TOPIC Locomotive and Railroad Car Repair Plant in Velikiye Luki

25X1A

EVALUATION 25X1A

25X1A

PLACE OBTAINED

DATE OF CONTENT 25X1A

DATE OBTAINED DATE PREPARED 17 October 1951

REFERENCES

PAGES 7 ENCLOSURES (NO. & TYPE) 2 - sketches on ditto

REMARKS

RETURN TO CIA LIBRARY

25X1X

1. The locomotive and railroad car repair plant in Velikiye Luki (56°20'N/30°32'E) was south of the railroad station in the southern part of the town. There were spur tracks to the main railroad line. The plant was built between 1906 and 1910. These dates were seen inscribed on the locomotive repairshop. During World War II the locomotive repair department suffered only slight damage and resumed operations late in 1947. The railroad car department was severely damaged and reconstruction was still under way late in 1948. The reconstruction of this department followed the original layout, except for minor extensions. The equipment included a large quantity of German machinery. The plant area was 800 to 1,000 meters long and about 200 meters wide. Details regarding the railroad car repair department were not available. Power was supplied from the municipal power plant. *
2. Late in 1948, three to four locomotives were repaired monthly in the locomotive repair department. The rate was scheduled to be increased as soon as the personnel had familiarized themselves with the new machinery. Railroad car repairs were not observed. The small parts needed for the repairs were produced in the plant itself.
3. The number of workers employed in the locomotive department was reported to be 200 in one shift. The sawmill had 30 employees. The number of employees of the railroad car department was not known. No information was available as to whether work was done in one shift or in several shifts.

25X1A

* Comment. For location sketch of the plant, see Annex 1. This sketch is based on a map of August 1944 on a scale of 1:300,000, and on information from For layout sketch of the plant, see Annex 2, based on information from This sketch gives only rather general information.

2 Annexes: Two sketches on ditto.

CLASSIFICATION CONFIDENTIAL

25X1A



Location Sketch of the Locomotive and Railroad Car Plant in Velikiye Luki

Legend:

- 1. Velikiye Luki railroad station.
- 2. Locomotive and railroad car repair plant.
- 3. Railroads.

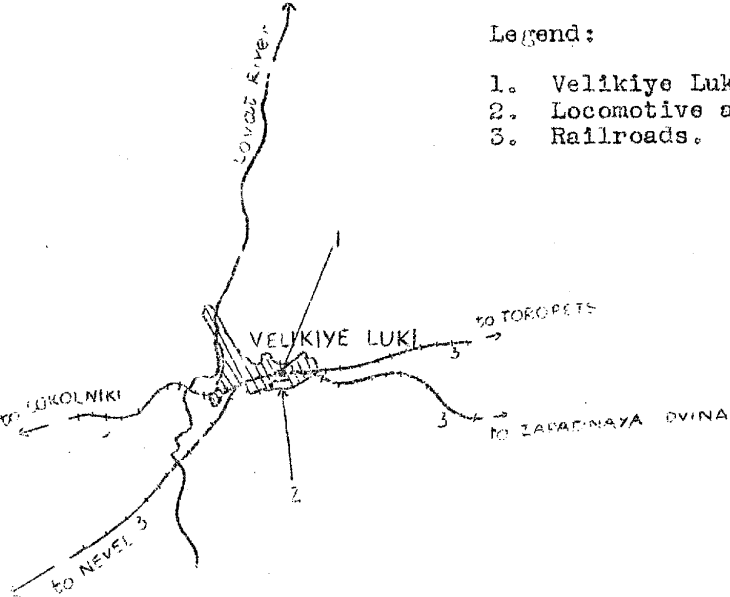

Scale 1:300,000

Annex 2 to

Layout Sketch of the Velikiye Luki Locomotive and Railroad Car Repair Plant

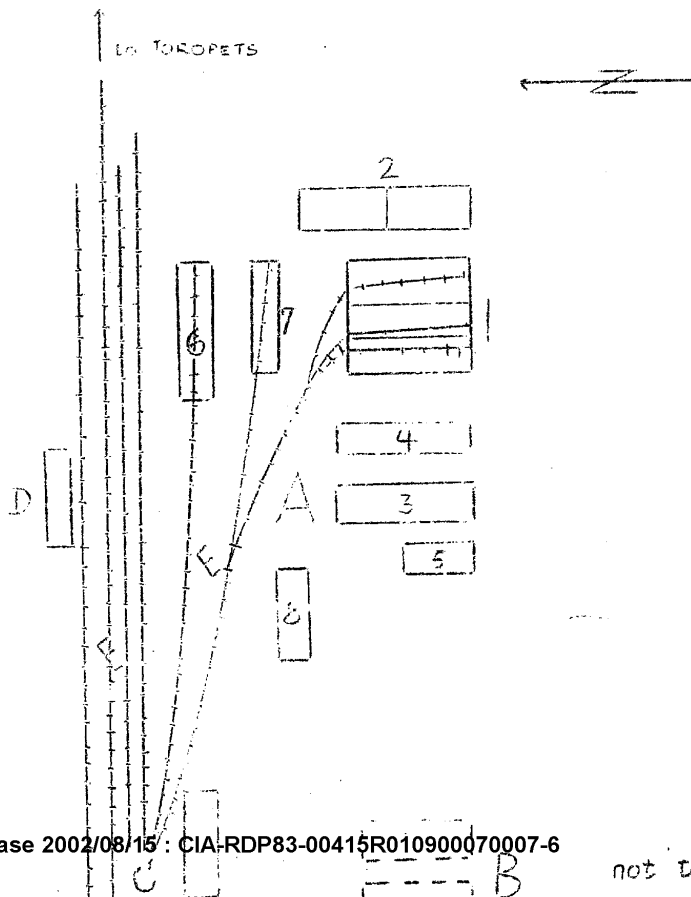

CONFIDENTIAL

Annex 2 to

- 2 -

Legend:

- A. Locomotive repair department.
 1. Assembly shop.
 2. Two machine shops used for repairwork and for manufacturing parts. The equipment included a 6 meter long cylinder lathe, two vertical turning and boring mills and several small lathes.
 3. Foundry.
 4. Forge and pressing shop. The equipment included a press for mounting the tires on the wheels.
 5. Boilerhouse.
 6. Parking shed for locomotives.
 7. Parking shed for locomotives, new structure.
 8. Motor vehicle repair department.
- B. Railroad car department, under construction.
- C. Sawmill equipped with 2 frames of 6 to 8 blades each, and 15 woodworking machines. The sawmill supplied lumber to repair plant and to the building projects in the town.
- D. Volikiye Luki railroad station.
- E. Railroad and spur tracks.

CONFIDENTIAL

25X1A

COUNTRY U S S R REPORT NO. _____

TOPIC Aircraft Engine Depot near Penza

EVALUATION 25X1A PLACE OBTAINED 25X1A 25X1A

DATE OF CONTENT 25X1C

DATE OBTAINED DATE PREPARED 29 June 1950

REFERENCES _____

PAGES 1 ENCLOSURES (NO. & TYPE) _____

REMARKS _____

RETURN TO CIA LIBRARY

25X1X

25X1X

1. a train from Kazan to Penza (45°00'E/53°11'N) when it stopped about 15 km from Penza. The railroad line passed through a woods at this point. A large loading ramp was east of the line. A fairly large camp with tents and wooden buildings was on both sides of the line. Many in-line engines were seen near the track and on the loading platform.

25X1X

the aircraft engines were standard V-type in-line engines. *

25X1A

* Comment. Report of the camp indicates that it was a temporary installation, probably dating back to the war. A major supply depot of the Soviet Air Force was located in Penza during the war. The local airfield seems to have been improved. See

CONFIDENTIAL

CLASSIFICATION

25X1A

COUNTRY U.S.S.R. REPORT NO. _____

TOPIC Yaroslavl Automobile Plant

EVALUATION	<input type="checkbox"/> 25X1A	PLACE OBTAINED	<input type="checkbox"/> 25X1A	<input type="checkbox"/> 25X1A
DATE OF CONTENT	<input type="checkbox"/>	25X1C	<input type="checkbox"/>	
DATE OBTAINED	<input type="checkbox"/>	DATE PREPARED	9 May 1951	

REFERENCES _____

PAGES 2 ENCLOSURES (NO. & TYPE) 1 - Sketch on ditto

REMARKS _____

RETURN TO CIA LIBRARY

25X1X

- The Avto-Zavod Automobile Plant is located in the northwest outskirts of Yaroslavl (57°35'N/39°50'E), north of the railroad. The plant has spur tracks. Power is supplied from Yaroslavl. (1)
- The plant was still under construction in June 1949. A new workshop building had been completed and another building, allegedly a new boiler-house, was completed in rough brickwork. The new foundry was under construction and an additional new workshop building was planned to be completed by the end of 1949. At the time of observation, the plant covered an area of about 1,500 x 500 meters. When the building projects have been completed the plant area will be allegedly be increased to 5,000 x 5,000 meters. the plant comprised a foundry, a molding shop, several latheshops, a pressing shop, an annealing shop, a punching shop, a forge, assembly shops, a test stand, technical designing shops and offices, warehouses, and fuel tanks. (2)
- Early in 1949, the plant produced 70 to 80 two-axle trucks monthly, which were used by the Red Army as prime gun movers. There was also a test production of individual units of heavy trailers to be used for the transportation of tanks. Six to eight engine blocks, always of the same type, were cast per shift in the foundry in addition to other castings.
- The total number of workers in the automobile plant was . The foundry employed about 400 to 500 workers and about 500 more were employed in the recently completed workshop (Building No. 2). Work was generally done in one shift but there was a two-shift schedule in the foundry. (h)

25X1A

25X1A

25X1A

Comments.

- The reported plant is obviously the famous YaAZ (Yaroslavlskiy - Avto-Zavod) No 3, the location of which has been identified by aerial photographs and city plans.

25X1A

SECRET

2

25X1A

- (2) For sketch of plant layout see annex. The information on the departments under construction corresponds with that given in However, the construction of the boilerhouse is new information. The underground room, previously reported to be under construction, appear to be sand bunkers according to this report. The sand bunkers serve for storage of molding sand. The indicated future plant area of 5,000 x 5,000 meters appear to be considerably overestimated. Construction activities are mainly confined to the old plant area, covering about 200,000 square meters.
- (3) The reported 1949 monthly production of 70 to 80 two-axle trucks is very low. According to Soviet publications, the automobile plant had an annual capacity of 2,500 trucks in 1937. A production goal of about 17,000 motor vehicles was planned to be achieved in 1949 by plant expansion, and about 25,000 motor vehicles were to be produced in 1950. The main production was shifted from the two-axle 5-ton trucks to three-axle 7-ton trucks and 12-ton trucks as well as prime movers with a capacity of 45 tons.
- (4) It seems hardly credible that there was only a one-shift schedule in the automobile plant. It appears more probable that work was done in three shifts.

1 Annex: One sketch on ditto.

SECRET

25X1A

SECRET

25X1A

Annex to
- 2 -Legend:

1. Workshop building, 150 x 120 meters, 20 meters high.
 - a. Foundry and molding shop, equipped with two US-made electric furnaces (E), 2 to 2½ meters high with an inside diameter of 2 meters; three coke furnaces (K), 1 to 1.5 meters high with an inside diameter of 1 meter; and five trolleys.
 - b. Sand bunker equipped with a heavy trolley.
 - c. Administrative offices.
2. New workshop building, 220 x 180 meters, 10 to 12 meters high.
 - a. Four-story section containing offices and technical designing rooms.
 - b. Final assembly shop.
 - c. Latheshop equipped with about 200 modern lathes, shaping machines, automatic machines and jointing planes, some of them of German make.
 - d. Empty room.
 - e. Pressing shop equipped with two American pressed roaching as high as the roof of the workshop and probably used in manufacturing fenders.
 - f. Pressing shop equipped with smaller presses.
3. Machine shop building, 180 x 100 meters, 10 to 12 meters high. This building housed an annealing shop, a dieshop and a latheshop equipped with vertical turning and boring machines, 3.5 meters high and 0.80 meter in diameter, as well as multiple drilling machines similar to vertical turning and boring mills, with a diameter of 0.80 meter.
4. Workshop building, 120 x 80 meters, 10 meters high.
 - a. Chassis assembly shop.
 - b. Engine test stand.
5. New workshop building, still partly under construction, 100 x 100 meters.
 - a. New foundry under construction. Pillar bases and heating flues were being built.
 - b. Four-story office building. Completed at the time of observation.
6. Forge, 60 x 60 meters, 6 meters high.
7. Punching shop, 80 x 80 meters, 6 meters high.
8. Filling station and gasoline warehouse, 4 x 4 meters.
9. Two fuel tanks, 15 meters high and 10 meters in diameter.
10. Workshop building under construction, 250 x 120 meters, 22 meters high. Future use unknown. It was anticipated this building would probably be completed by the end of 1949.

SECRET

25X1A

SECRET

25X1A

Annex to
-- 2 --Legend:

1. Workshop building, 150 x 120 meters, 20 meters high.
 - a. Foundry and molding shop, equipped with two US-made electric furnaces (E), 2 to 2½ meters high with an inside diameter of 2 meters; three coke furnaces (K), 1 to 1.5 meters high with an inside diameter of 1 meter; and five trolleys.
 - b. Sand bunker equipped with a heavy trolley.
 - c. Administrative offices.
2. New workshop building, 220 x 180 meters, 10 to 12 meters high.
 - a. Four-story section containing offices and technical designing rooms.
 - b. Final assembly shop.
 - c. Latheshop equipped with about 200 modern lathes, shaping machines, automatic machines and jointing planes, some of them of German make.
 - d. Empty room.
 - e. Pressing shop equipped with two American presses reaching as high as the roof of the workshop and probably used in manufacturing fenders.
 - f. Pressing shop equipped with smaller presses.
3. Machine shop building, 180 x 100 meters, 10 to 12 meters high. This building housed an annealing shop, a dieshop and a latheshop equipped with vertical turning and boring machines, 3.5 meters high and 0.80 meter in diameter, as well as multiple drilling machines similar to vertical turning and boring mills, with a diameter of 0.80 meter.
4. Workshop building, 120 x 80 meters, 10 meters high.
 - a. Chassis assembly shop.
 - b. Engine test stand.
5. New workshop building, still partly under construction, 100 x 100 meters.
 - a. New foundry under construction. Pillar bases and heating flues were being built.
 - b. Four-story office building. Completed at the time of observation.
6. Forge, 60 x 60 meters, 6 meters high.
7. Punching shop, 80 x 80 meters, 6 meters high.
8. Filling station and gasoline warehouse, 4 x 4 meters.
9. Two fuel tanks, 15 meters high and 10 meters in diameter.
10. Workshop building under construction, 250 x 120 meters, 22 meters high. Future use unknown. It was anticipated this building would probably be completed by the end of 1949.

SECRET

25X1A

25X1A

SECRET

Annex to

- 3 -

Legend cont'd:

11. Rough brickwork structure, 70 x 60 meters, allegedly a new boiler-house.
12. Open terrain.
13. Double-track main railroad line.
14. Single-track spur line.

SECRET

25X1A

SECRET

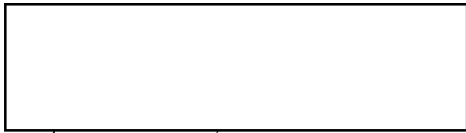

25X1A

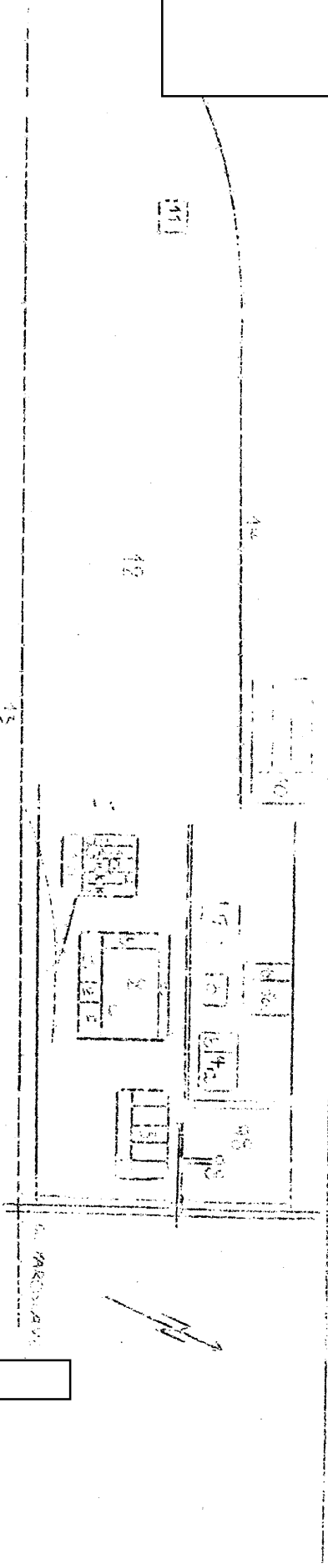

SECRET

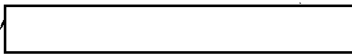

Legend see next page.

COUNTRY Soviet Union REPORT NO. _____

TITLE Yaz No 3 Motor Vehicle Plant in Yaroslavl 25X1A

EVALUATION [redacted] 25X1A PLACE OBTAINED [redacted] 25X1A [redacted]

DATE OF CONTENT [redacted] 25X1C

DATE OBTAINED [redacted] 25X1C DATE PREPARED 2 May 1950

REFERENCES _____

PAGES 2 ENCLOSURES (NO. & TYPE) 1 Blueprint

REMARKS _____

[redacted]

25X1X

1. Location :

In the northern section of Yaroslavl (39°52'E/57°37'N), Yaroslavl Oblast, west of the Volga River and the electric motor plant, and north of the large railroad line.

2. Plant installations :

The plant is an old installation which has ^{been} considerably enlarged by many new constructions since 1945. Power is supplied by a power plant near the Volga River, east of the plant. A railroad connection is available. For plant layout see Annex.

3. Work force :

Three shifts with an estimated 2,000 laborers each, 40 percent women. This number does not include the PWs and Soviet convicts working on the construction.

4. Production :

Main production 7-ton trucks, two-axle, with plant manufactured Diesel engines.
 Ten-ton trucks, three axles, with the same type of Diesel engines.
 Short 10-ton trucks, with three axles, equipped with rope winches and motor fire engine mounted behind the cabin.
 Diesel engines. The production of 5-ton trucks stopped in 1947.

25X1A

CONFIDENTIAL

25X1A

25X1A. [redacted] statements on the foundry (item no. 3 on sketch): The bare structure of the building, about 100 x 45 m, was completed during the winter of 1948/1949. Excavations were dug inside the hall during the Spring of 1949. [redacted]

25X1A

25X1A [redacted] a forge was to be installed.

25X1A [redacted] Comment :

a. The report contains additional details on previously reported enlargements in the automobile plant of Yaroslavl. The statements seem credible. It is reported for the first time that the production of 5-ton trucks stopped in 1947 and that only the manufacture of heavy trucks was continued.

b. [redacted]

25X1A

[redacted] excavations were made in a workshop for the intended construction of a forge. [redacted] reported a new foundry under construction. It still remains unclarified whether the excavations are for the installation of heavy machine tools or for top-secret air raid shelters.

25X1A

[redacted]

25X1A

Annex : "YAZ" No. 3 Motor Vehicle Plant in Yaroslavl.

CONFIDENTIAL

25X1A

CONFIDENTIAL

25X1A

Annex

Legend to AnnexMotor Vehicle Plant in Yaroslavl

- 1 Workshop with three sections :
 - a Forge, about 150 x 60 m
 - b Hardening shop, 30 x 60 m
 - c Gear department, about 200 x 30 m, also manufacture of valve seatings
- 2 Assembly and machine shop, total dimensions about 200 x 130 feet
 - a Assembly shop
 - b Seven machine shops
 - c New pressing shop, [REDACTED]
 - d New hardening shop, [REDACTED]
 - e New administration with seven stories
- 3 Foundries, total dimensions about 150 x 150 m
 - a Old foundry with two furnaces and an office
 - b New foundry with several electric furnaces
- 4 Three storage sheds with iron
- 5 Main gate
- 6 Two administration buildings, each 35 x 15 m
- 7 Fire department
- 8 Diesel department, about 120 x 100 m, consists of four workshops with six test stands for engines
 - a Five-story wing for administration
- 9 Boiler house, 10 x 30 m
 - a Old section
 - b New section with two new boilers of German origin
 - c Concreted coal yard
- 10 Frame fitting department and spring forge, about 65 x 65 m
- 11 New building, 130 x 130 m

25X1A

CONFIDENTIAL

25X1A

25X1A

CONFIDENTIAL

Annex

- a Administration, three stories, almost completed
 - b Projected new forge, foundations for large steam hammer completed and the walls partially completed (16 m)
 - c Workshop, foundations and walls completed as on No. b above
 - d Several workshops with foundations
- 12 Second gate
 - 13 Building under construction with two longitudinal sections, each 200 x 50 x 24 m, and a middle section, 50 x 35 x 15 m, partially completed
 - 14 Three sectional building under construction, 30 x 30 x 10 m, almost completed
 - 15 New boiler house, about 30 x 30 m
 - 16 Canal under construction to the Volga branch located 4 km from here, about 1 km completed, 20 m wide, 3 m deep
- B Soviet hard labor camp
 - C Cement mixing shop under construction
 - D Engineers depot, with pontoons and other engineer equipment. This depot will be cleared out, [redacted] to [redacted] 25X1A
make more space for the motor vehicle plant.
 - E Mechanical Factory of the Yaroslavl Construction Trusteeship, with construction office, forge and designing office.

CONFIDENTIAL

25X1A



VAZ No. 3 Motor Vehicle Plant in Yaroslavl

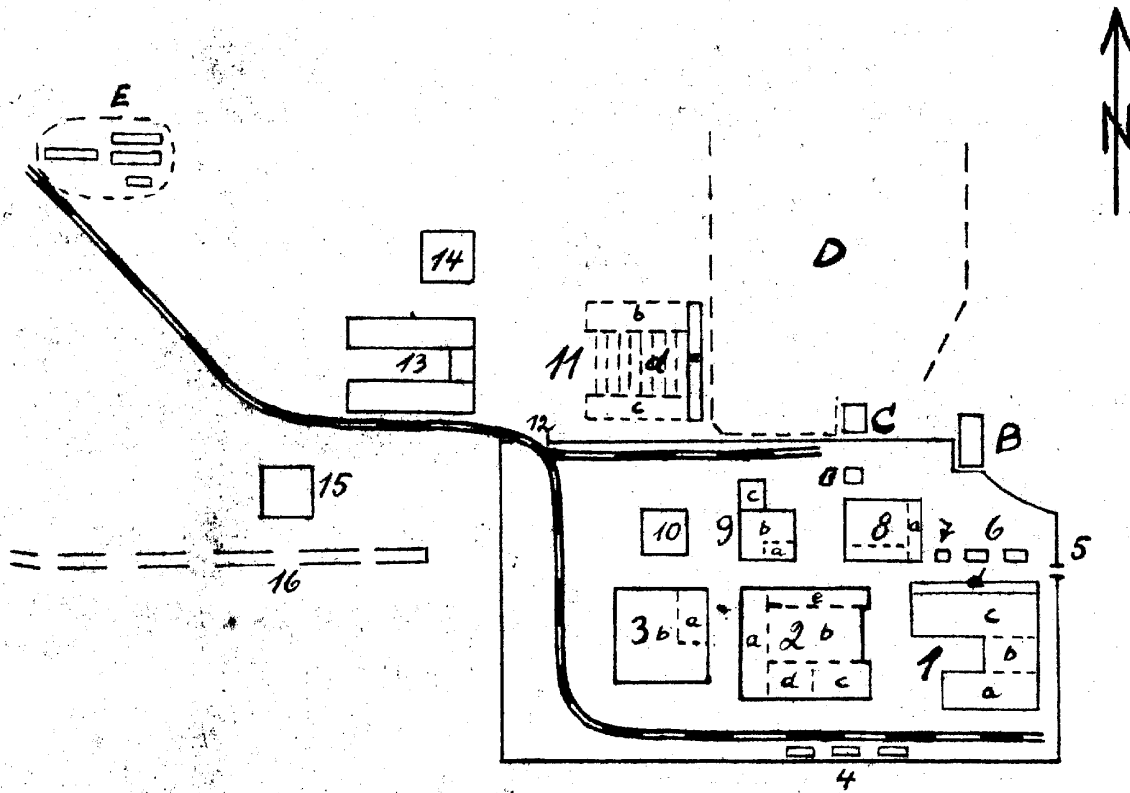

Legend: See report

not to scale

CONFIDENTIAL

CLASSIFICATION

U.S.S.R.

REPORT NO.

TOPIC Plant under construction near Domodedovo, east of Podolsk

25X1A

EVALUATION: 25X1A PLACE OBTAINED: 25X1A

DATE OF CONTENT: 25X1C

DATE OBTAINED: DATE PREPARED: 27 June 1950

REFERENCES: ()

PAGES: 2 ENCLOSURES (NO. & TYPE): 1 - sketch on ditto

REMARKS

25X1X

1. The plant is about 6 to 7 km east of Domodedovo (37°42'N/55°29'N) Moscow Oblast (about 20 km east of Podolsk). *
2. The construction which was supervised by a Lt. Colonel of the Soviet Army, started in 1945 with a wood working department operating for construction requirements of the plant and other installations. * The bare structures of two metal processing workshops were completed and partially installed with machinery in October 1947. Dismantled German metal processing machines, including precision working machines arrived in 1946 and 1947. Machines which were not installed were stored in boxes out-doors in the plant area. The precision machines included ball bearing manufacturing machines such as are in operation at the Fichtel and Sachs firms. A foundry was being installed in one of the two workshops. The plant area covered 400x250 meters and had narrow-gauge plant railroad in addition to a standard-gauge railroad connection to the Domodedovo station.
3. About 600 to 1000 inmates of the camp and 100 Soviets worked on the construction along with a varying number of Soviet engineers, laborers and convicts. **
4. Production: The machinery indicated that the plant will be able to produce all types of fuses.

CLASSIFICATION

25X1A

25X1A

CONFIDENTIAL

25X1A

25X1A

Comment. Although the period of observation dates back to 1947 the report is forwarded as other information mentioned the allegedly planned construction of V-weapons plants in the Podolsk area. It cannot be determined and is doubted that the plant under construction near Domodedovo is to produce V-weapons. Only the Soviet Lt. Colonel in charge of the supervision might be a slight indication as to such a plant purpose. It is assumed that an aluminum and pig iron foundry south of Domodedovo reported in and the above reported plant are identical. For plant location and layout see Annex.

25X1A**

Comment. With the P. Camp No 6306 near Domodedovo being reported the location of the plant under construction and other details seem credible.

1. Annex: Sketch.

CONFIDENTIAL

25X1A

25X1A

25X1A

~~CONFIDENTIAL~~

1/Annex

Legend to Annex

1. Fenced in area of AW camp No 6306
2. Circular saws
3. Automatical wood processing shop
4. Carpenter shop
5. Finished products storage
6. Drying chamber
7. Boiler house with three boilers
8. Thirty meter high smokestack
- 9 and 10. Saw frames
11. Transformer station, twice enlarged during the period of observation
12. So-called white staff (labor management)
13. So-called red staff (disciplinary authorities)
14. Water tower
15. Spare parts depot
16. Workshop, 150 x 30 x 7 meters, with stored machines
17. Workshop, 150 x 30 x 7 meters (see special sketch)
 - a. Molding shop
 - b. Foundry, presumably for aluminum and pig iron
 - c. Electric welding shop
 - d. Lathes
 - e. Drilling machine
 - f. Automatically working machines including grinding machines
 - g. Shapers
 - h. Work benches.

~~CONFIDENTIAL~~

25X1A

Plant under Construction near Domodedovo, East of Podolsk

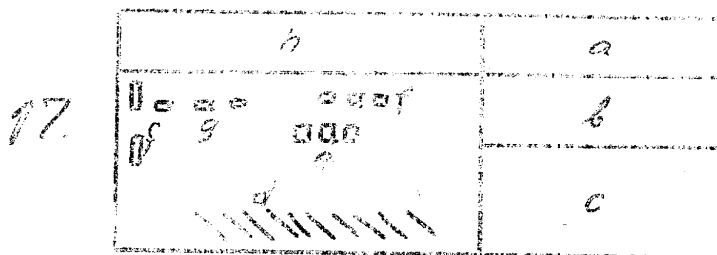
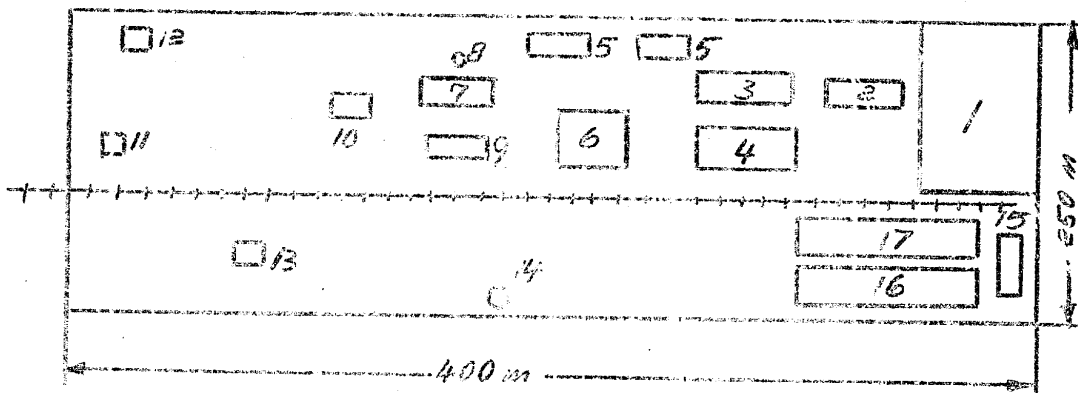
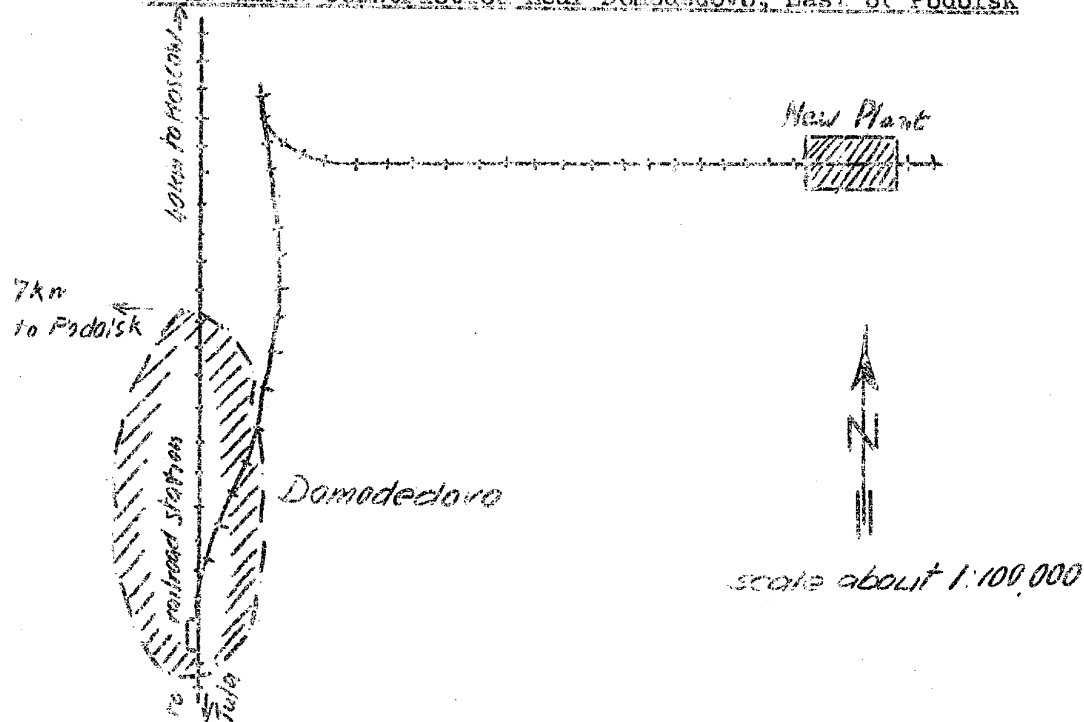

Legend: See report

not to scale

CCUNY/HELLOPAX 5 Soviet Union REPORT NO. _____

TOPIC Crystal Plant in Dyatkovo

EVALUATION 25X1A PLACE OBTAINED 25X1A 25X1A

DATE OF CONTENT 25X1C

DATE OBTAINED DATE PREPARED 21 February 1950

REFERENCES 25X1C

PAGES 1 ENCLOSURES (NO. & TYPE) 2 blueprints

REMARKS _____

[Redacted]

25X1X

1. Location

The plant is south of the market square of Dyatkovo (34°20'E/53°37'N), Chel Oblast. For location see Annex 1.

2. Plant Installations

The plant covered an area of about 600 x 450 meters. It suffered only minor war damages and was the center of the glass industry in the Bryansk area. Three buildings in the plant center were not reconstructed. Power supply came from a power plant outside the factory area. A narrow-gauge railroad connection was available. For plant layout see Annex 2.

3. Work Force

About 2,000 laborers, including 100 PWs, work was done in three shifts.

25X1X

25X1X

4. Production

Glass ware for civilian use.

25X1A

Comment:

This is the first information on the crystal plant in Dyatkovo. a town map (Annex 1) which is of special interest, even if containing only few industrial installations. There are no other reports available on the airfield in the southeastern section of the town which is under construction.

25X1A

- 2 Annexes: 1.)
- 2.) Crystal Plant in Dyatkovo

SECRET

1 / Annex 1

Legend to Annex 1

- 1 PW Camp No 326/4
- 2 Glass store
- 3 Garrison
- 4 Office building
- 5 Food store
- 6 Hospital
- 7 Sawmill
- 8 Railroad station
- 9 Station of narrow-gauge railroad
- 10 Underpass
- 11 Two party buildings
- 12 Fire department
- 13 Hospital
- 14 Post office
- 15 Bank
- 16 Market square
- 17 State owned warehouse
- 18 Warehouse
- 19 Crystal plant
- 20 Bazaar
- 21 Bare structure
- 22 Warehouse
- 23 Lenin square
- 24 Technical school
- 25 Planned airfield

SECRET

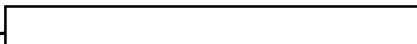

25X1A

Crystal Plant in DYATKOVO

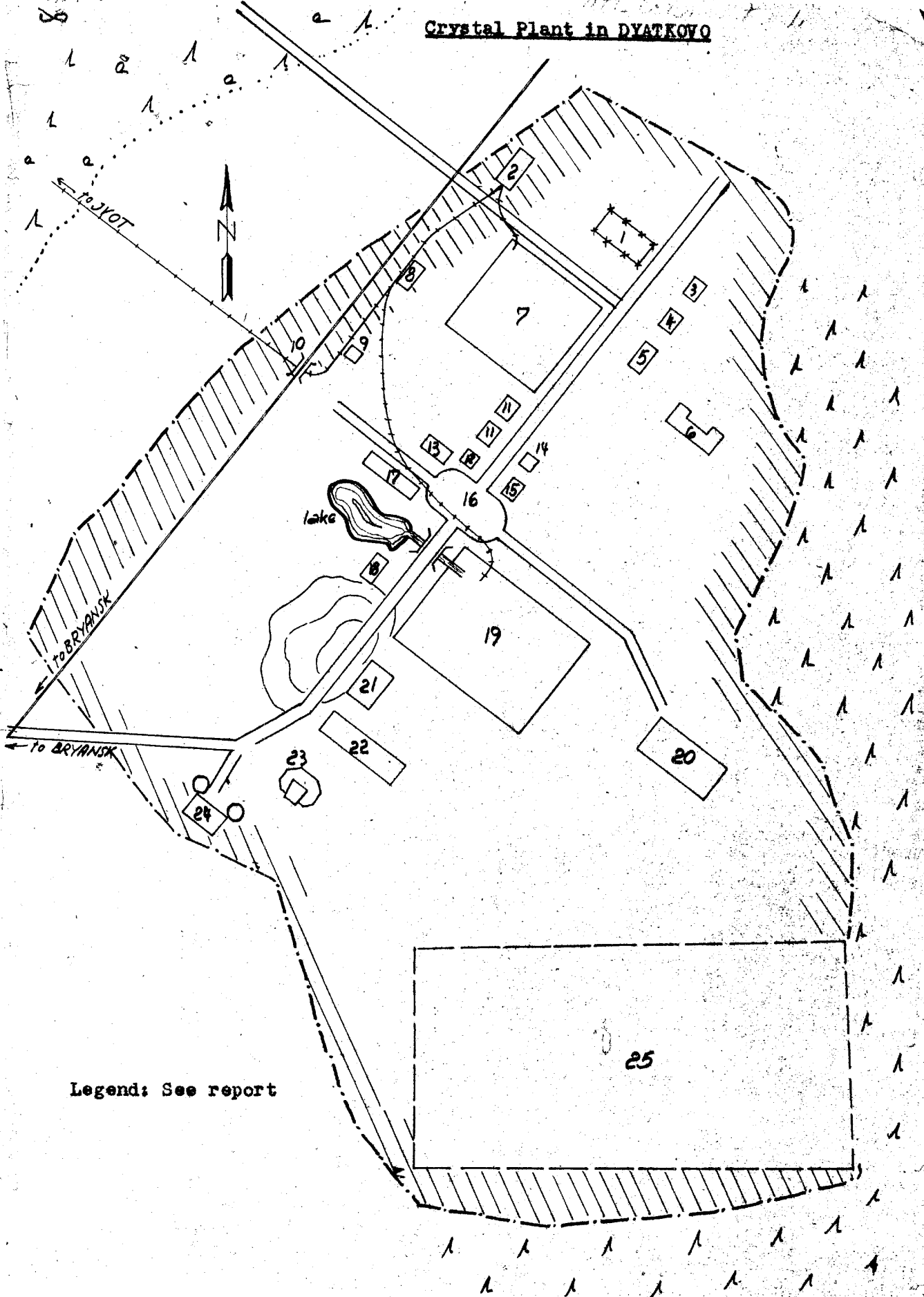

Legend: See report

not to scale

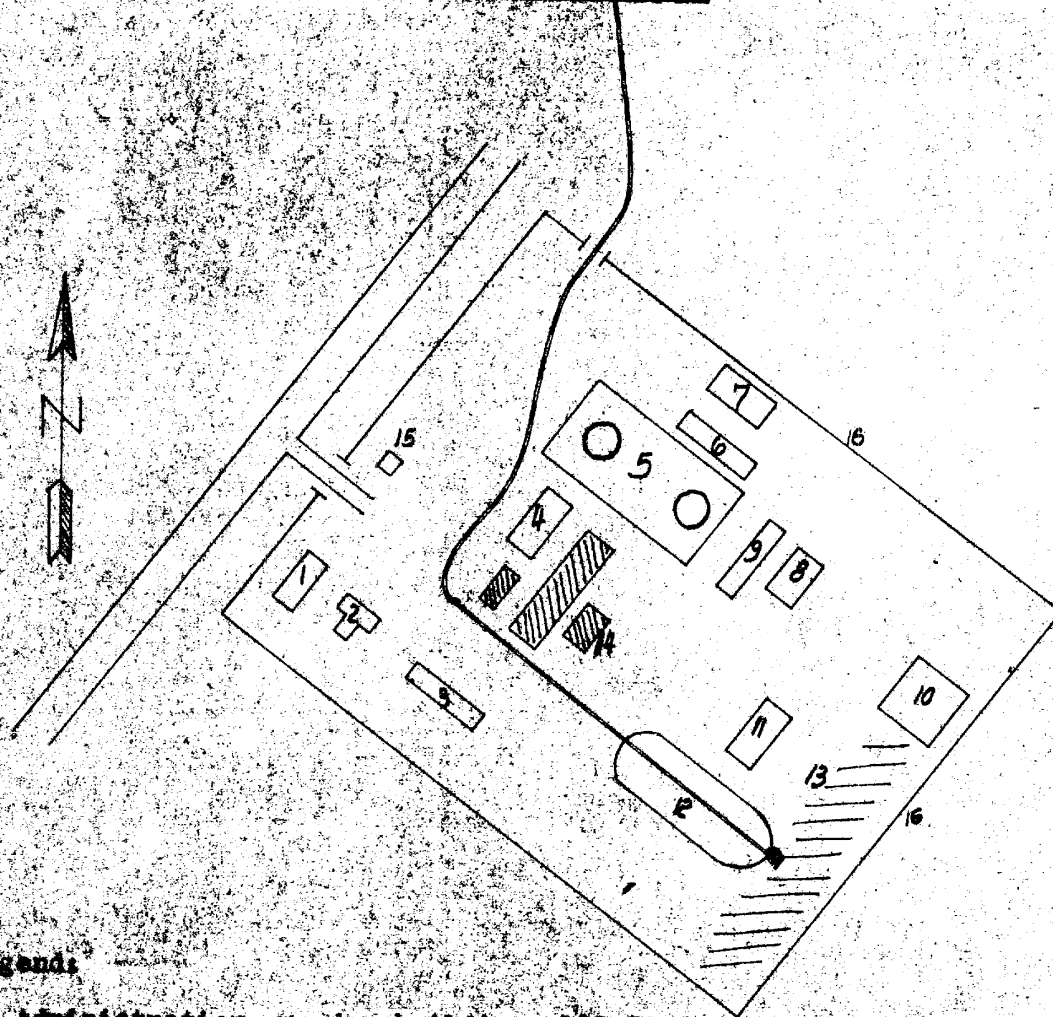
Crystal Plant in DYATKOVO

Legend:

- 1 Administration, wooden building, 120x30 feet
- 2 Mess hall, stone structure
- 3 Garages, stone structures, 240x60 feet
- 4 Mixing plant, stone structure, 120x60 feet
- 5 Main manufacturing shop, stone building, 450x180 feet with two sackstacks
- 6 Crystal cutting shop, stone building, 150x30 feet
- 7 Molding shop
- 8 Polishing shop, stone structure, 120x60 feet
- 9 Plant warehouse, stone structure, 180x30 feet
- 10 Sawmill with two frames
- 11 Glass painting shop, stone building, 120x45 feet
- 12 Main loading station
- 13 Timber dump
- 14 Destroyed buildings
- 15 Plant entrance with guard house
- 16 Wooden fence

not to scale

INTELLIGENCE

COUNTRY [redacted]

REPORT NO.

Alroad Car Factory in Kalinin.

25X1A

EVALUATION [redacted] 25X1A PLACE OBTAINED [redacted] [redacted]

DATE OF CONTENT [redacted] 25X1C 25X1A [redacted]

DATE OBTAINED [redacted] DATE PREPARED 21 April 1950

REFERENCES

PAGES ENCLOSURES (NO. & TYPE) 1 Blueprint

REMARKS

[redacted]

25X1X

1. Location:

In the western part of Kalinin (35°55'E/56°51'N), Kalinin Oblast, on the northern bank of the Volga River.

2. Installations:

a. The factory covers 1,100 x 1,900 meters. The installations seemed to be in good condition. The workshops are solid structures with black wooden roofs and are painted brick color.

b. The plant has a single-track railroad connection with several branches in the plant area. (Location and layout sketch see Annex).

3. Work force:

Three shifts with 1,000 Soviets each, including 60 percent women.

4. Production: Lullmann coaches.

25X1A

[redacted] Comment:

a. This is the first information with detailed data on the railroad car factory in Kalinin.

b. The attached sketch is very schematic and entirely wrong as regards the course of the Volga River. The location of the plant and of the neighboring objects was reproduced more correctly in a previously received town sketch *.

CLASSIFICATION CONFIDENTIAL

[redacted]

25X1A

CONFIDENTIAL

25X1A

Annex

Legend to Annex:

- A Railroad car factory
- 1 Assembly shop, brick building, 54 x 135 meters
- 2 Guardhouse
- 3 Sawmill, brick buildings, 36 x 54 meters, with four frames
- 4 Post exchange, wooden shed, 36 x 135 meters
- 5 Brick assembly shop, 54 x 135 meters
- 6 Brick foundry, 36 x 108 meters, with two brick smokestacks, each 21 meters high, five furnaces
- 7 Assembly shop, same as 5
- B Forced labor camp
- C Railroad bridge, two tracks
- D Road bridge, wooden structure resting on two stone piers
- E Power plant
- F Peat dump of the power plant
- G Road bridge, similar to D
- H Cadet school
- I MVD Headquarters
- K War academy
- L IT Camp No 7384

CONFIDENTIAL

25X1A

CONFIDENTIAL

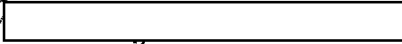

25X1A

25X1A

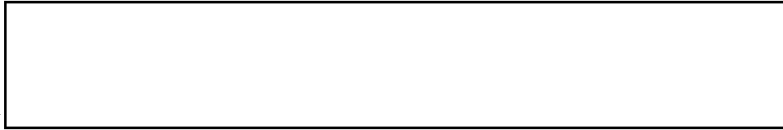

1 Annex: Location and Layout Sketch of the Kalinin
Railroad Car Factory.

--

CONFIDENTIAL

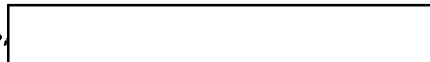

25X1A

Location and Layout Sketch of the Kalinin Railroad Car Factory.

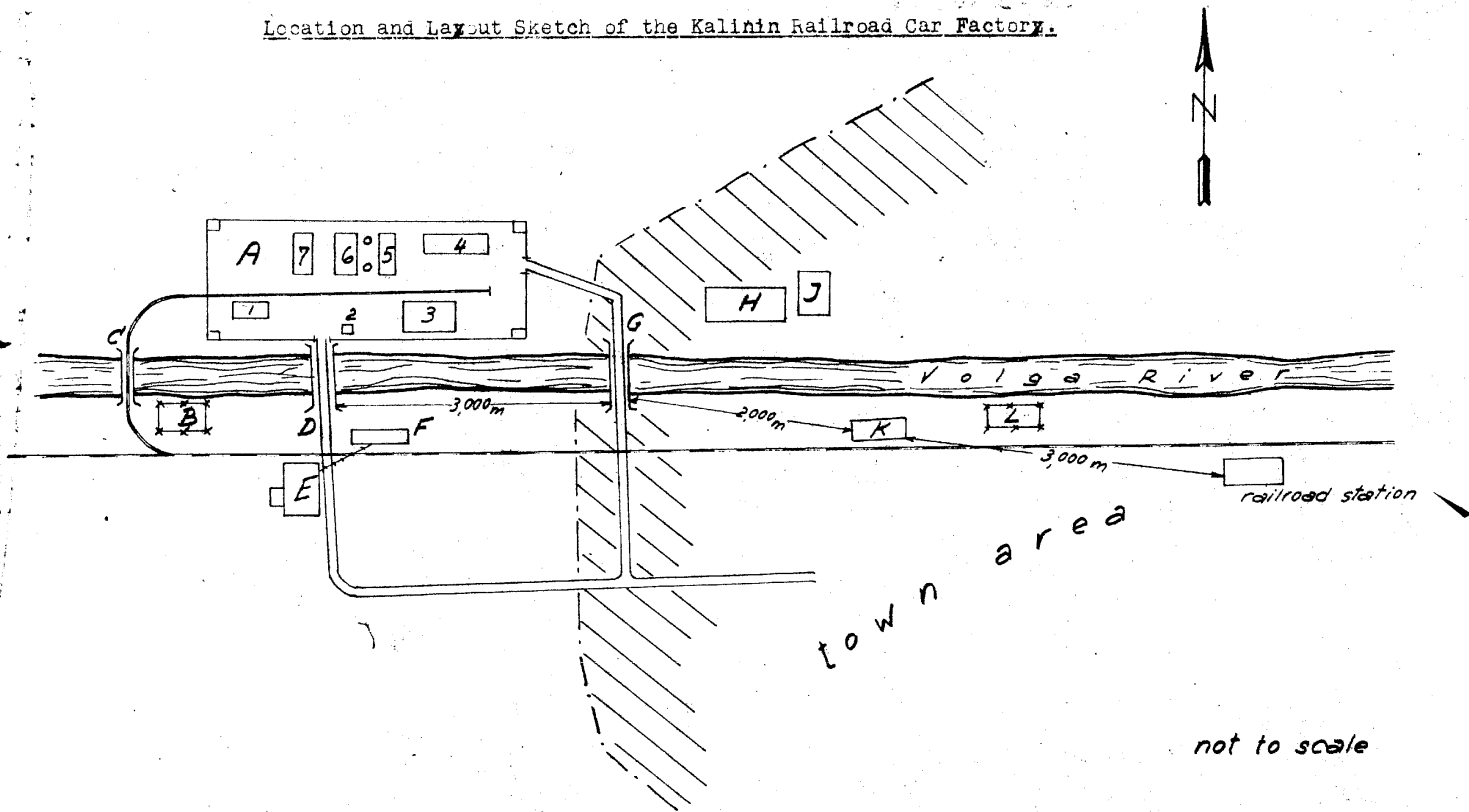

COUNTRY Soviet Union REPORT NO. _____

TOPIC Factory with Power Plant Under Construction in Kaluga

25X1A

EVALUATION 25X1A PLACE OBTAINED

DATE OF CONTENT 25X1C 25X1A

DATE OBTAINED DATE PREPARED 24 April 1950

REFERENCES _____

PAGES 2 ENCLOSURES (NO. & TYPE) 2 sketches on ditto

REMARKS _____

25X1X

1. Location:

About 1.6 km NW of the town center of Kaluga (56° 18' 54" N), Tula Oblast, and about 1.9 km east of a valley with a tributary of the Oka River. The railroad line to Moscow passes about 0.9 km north of the plant.

2. Plant Installations:

a. According to Soviet statements the construction of the plant started in 1944. The bare structures of 10 workshops were completed before the war. After the war other workshops and the power plant were constructed. The workshops are of red brick and have flat roofs. They are all of the same type of construction and measure about 47 x 7.5 x 7.5 meters. Since the distances between the workshops are equal, the road net in the plant is rectangular. The power plant and the administration building are higher than the other plant buildings and thus vary from the type of construction of the buildings which are numbered from 1 to 11.

b. A railroad connection was laid in 1947.

c. Machinery was installed in all workshops after early 1948, with the exception of the four vacant buildings, located mostly in the south. The production was to start in 1950. Construction work on roads and railroad tracks in the plant area, and interior work on the workshops progressed slowly for lack of materials and machines. The 1.8-meter barbed-wire fence around the plant area was replaced by a wall of the same height. For location and plant layout see Annex.

3. Work force:

Four thousand Soviet laborers, of whom 1,000 were women, and 2,000 German POWs doing construction work.

4. Production:

The planned production was not known assumed, from the type of machinery observed, that the production of the plant might possibly be small machines, electric apparatus, electrotechnical items and

25X1X

CLASSIFICATION CONFIDENTIAL

25X1A

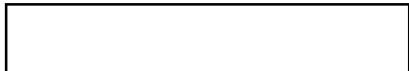

measuring instruments. (He saw small complicated machine tools for precision mechanic, electrotechnical apparatus and measuring instruments). The [redacted] the plant was to be a perfume factory and a paper mill for the requirements of Moscow.

25X1X

25X1A

[redacted] Comment:

a. This plant and a previously reported plant are most probably identical.

b. The location was confirmed by [redacted] and can be considered correct.

25X1A

c. The diagrammatic layout of the different plant buildings is assumed to be a fact. The same layout could be derived from a previous incomplete sketch.

2 Annexes: factory with power plant under construction in Muzuga (2 sketches on one ditto)

CONFIDENTIAL

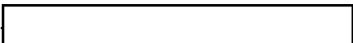

25X1A

1/Annex 1 and 2



Legend to Annexes:

Sketch No 1

- A New plant under construction
- B Teckmann Plant
- C Camp with canteen buildings
- D Woods

Sketch No 2

- 1 Administration building, No 21 of the plant, larger and higher than the average size buildings in the plant
- 2 Nineteen workshops of the same size, 27 x 7.5 x 7.5 meters, red brick structures with concreted floors, doors of steel sheets (plates). The four workshops furthest to the south are vacant.
- 3 Workshop No 16, so-called motor plant, equipped with numerous sheet-metal processing machines
- 4 Power plant, 36 x 23.5 x 24 meters, four-story concrete structure, completed in 1947, not in operation. The second floor houses the three American turbines and the fourth floor the generators. The boilers are fueled with coal dust. Coal bunkers are in the area around the power plant.  the machinery came from 25X1X Goerlitz and Dresden.
- 5 Gate No 1
- 6 Gate No 2

CONFIDENTIAL

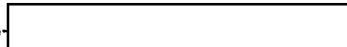

25X1A

25X1A

Approved For Release 2002/08/15 : CIA-RDP83-00415R010900070007-6

Sketch A.

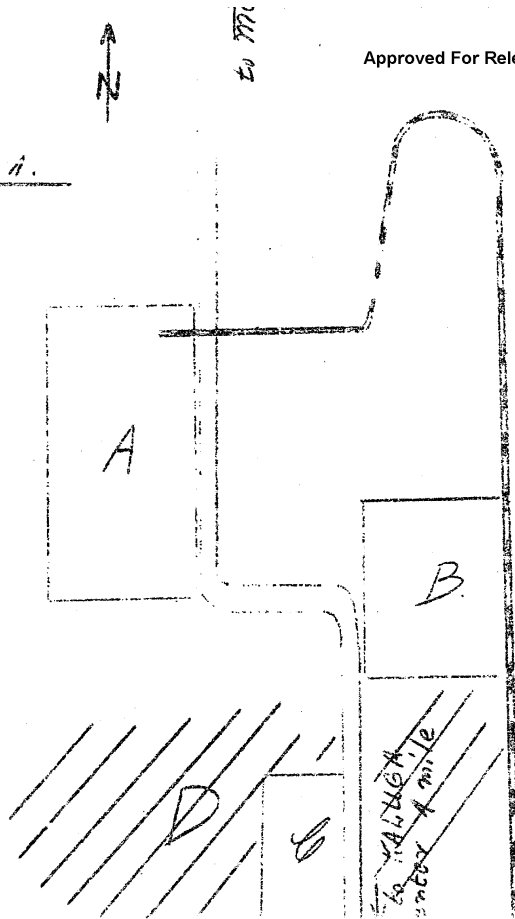

Sketch 2.

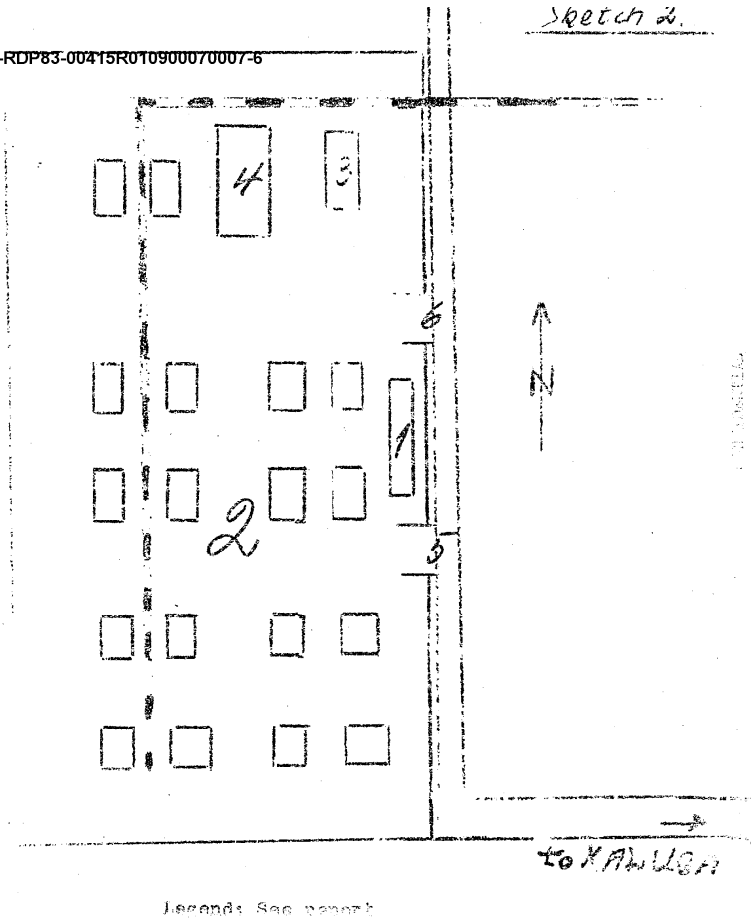

Legend: See report

Approved For Release 2002/08/15 : CIA-RDP83-00415R010900070007-6

Approved For Release 2002/08/15 : CIA-RDP83-00415R010900070007-6

25X1A

Next 1 Page(s) In Document Exempt

Approved For Release 2002/08/15 : CIA-RDP83-00415R010900070007-6

COUNTRY Soviet Union

REPORT NO.

TOPIC VORONEZH Aircraft Engine Plant

25X1A

EVALUATION 25X1A

PLACE OBTAINED

25X1A

DATE OF CONTENT

DATE OBTAINED

DATE PREPARED 12 February 1950

REFERENCES

PAGES 2 ENCLOSURES (NO. & TYPE)

REMARKS

RETURN TO CIA LIBRARY

[Redacted]

25X1X

1. Location the southwest edge of VORONEZH (39°10'N 51°39'N). The plant bordered on the southwest by a small factory airfield and on the north by a large industrial plant.

2. Numerical designation No. 18.

25X1A

3. Plant installations [Redacted] could not give a survey. It stated that reconstruction work had not been completed yet. New constructions were not observed.

4. Work force 1,500 to 2,000 workers in one day shift; number of shifts unknown.

25X1A

5. Production aircraft engines. [Redacted] observed the loading of 300 x 170 x 150 cm boxes. On the basis of knowledge acquired [Redacted] in line engines were produced and overhauled.

25X1A

6. [Redacted]

25X1A

ILLEGIB

[Redacted] Comment:

Information on the VORONEZH aircraft engine plant (former numerical designation No. 18) was contained in various previous reports. One of these reports was of a more recent date (dated covered until May 1949)*. From all this information it was inferred that the VORONEZH plant produces engines of the Bell type. But according to this report it has to be assumed that this plant also includes at least one repair department for in-line engines (compare the reported size of the boxes).

CLASSIFICATION

SECRET

25X1A

SECRET/CONTROL

[REDACTED]

25X1A

b. The work force indicated as about 1,500 to 2,000 per shift agrees with former reports.

c. The numerical designation No. 156 was mentioned for the first time in connection with this plant. The former No. 16 of the VORONEZH plant was re-assigned to the new KAZAN aircraft engine plant after the plant was transferred in December 1941. [REDACTED] reported No. 156 as being assigned to the SSAGI experimental plant west of the MOSCOW aircraft engine plant No. 45. [REDACTED]

25X1A

25X1A

[REDACTED]

SECRET

[REDACTED]

25X1A

COUNTRY Soviet Union

REPORT NO. [redacted]

TOPIC Observations at the Moscow-Tushino Aircraft Engine Plant No. 500 25X1A

EVALUATION [redacted] 25X1A PLACE OBTAINED [redacted] 25X1A

DATE OF CONTENT [redacted] 25X1C [redacted]

DATE OBTAINED [redacted] DATE PREPARED 17 April 1950

REFERENCES 25X1C

PAGES 2 ENCLOSURES (NO. & TYPE)

REMARKS

RETURN TO CIA LIBRARY

[redacted]

25X1X

1. Location: On the northeastern border of Tushino, about 1 km due north of the Tushino railroad station. The northern front of the plant borders on a branch canal of the Volga-Moskva Canal. The plant covered a site about 400 meters square. The plant area was surrounded by a board fence and watch towers and was guarded by civilian guards.

2. Engine test stand:

a. The construction of an engine test stand on the northwestern side of the plant outside the plant area was begun in October 1948 and completed in March 1949. The test stands were installed by the Soviets without the help of PAs.

b. [redacted] employed in the plant said they had seen jet fighter engines taken to the test stand.

c. The test stand was a three-story brick building 50 meters square. It was put into operation in June 1949; the roar of running engines was constantly heard.

3. Work force:

[redacted] estimated the number of workers assigned to one shift at 400 to 500, 40 percent women. Work was done in three shifts.

25X1X

25X1A

CONFIDENTIAL



4. Electric power supply:

Power was supplied by high tension lines leading to the northern corner of the plant from a lock about 100 meters west of the bridge over the branch canal. For this reason [redacted] power was produced there. The lock was guarded by the navy. The difference of the water level at the lock was about 1 meter. In the northern corner of the plant a site about 80 meters square was fenced in; about 20 power transmission line masts were on this site.

5. German technical personnel:

a. About 120 engineers and skilled workers of the former Junkers Aircraft Plant in Dessau and their dependents lived in Tushino; 30 to 40 of them worked in one group in the aircraft engine plant. A chief engineer from Wuerttemberg was particularly remembered.

b. [redacted] dependents of these Germans. All of them had been deported to Tushino in 1948. The entire German group was transferred to Kuibyshev in September 1949.

6. Production:

Jet fighter power plants, according to [redacted] who had personally seen the jet engines. Other types of engines were presumably also manufactured.

[redacted] Comment:

a. [redacted] information is noteworthy. The observation of the newly built test plant outside the plant area is in agreement with previous information.

b. The observations made in the plant [redacted] added weight to the assumption that part of the plant is being converted to the production of jet engines.*

[redacted] observation of such engines at the test stand cannot be ignored.

c. The reported transfer of Gerlach and his group to Kuibyshev is confirmed. On the basis of available information it is assumed that the development by Gerlach of a Diesel engine Jumo-224 did not lead to the expected success. The transfer of this group might possibly be in some connection with the conversion of the Tushino plant to the production of jet engines.

*

CONFIDENTIAL



25X1A

REF ID: A66094 5

COUNTRY Soviet Union REPORT NOTOPIC Aircraft Accessories Plant in KOSTINO

25X1A

EVALUATION 25X1A

PLACE OBTAINED

25X1A

DATE OF CONTENT

DATE OBTAINED

DATE PREPARED 25 November 1949REFERENCES 25X1CPAGES 2 ENCLOSURES (NO. & TYPE) 1 blueprint

REMARKS

25X1X

1. Location:

Immediately south of KOSTINO (37°52'E/55°54'N), Moscow Oblast. KOSTINO is situated about three to six miles north of the outskirts of MOSCOW and one to two miles south of the subway station, BOLSHEVO.

2. Plant history:

Comparatively new factory. No building operations, except the installation of new machines, partly of German origin. work was stopped during the war.

3. Layout:

Size about 3,300 x 2,000 feet; 13 buildings, including production shops.

- a. One workshop 330 x 200 feet
- b. One workshop 650 x 250 feet
- c. Five one-story workshops, each about 180 x 90 feet.

4. Labor force:

About 2,000 to 3,000, presumably working three shifts.

5. Production:

- a. Wings with landing flaps and ailerons (see Annex, No 1) parts of tail unit.
- b. Telescopic struts (see Annex, No 2)
- c. Airplane instruments and instrument panels
- d. Three-bladed air screws, about 10 feet in diameter,

CLASSIFICATION CONFIDENTIAL

25X1A

CONFIDENTIAL

[Redacted]

25X1A

25X1A

[Redacted]

maximum blade thickness about 10 inches

e. Fuel tanks

f. Other component parts: Steering columns, steering ropes, reverse segments etc.

6. Component parts:

a. Re 5c: A finished instrument panel, upper range from left to right was seen. Gasoline pressure gauge, oil pressure gauge, two altimeters; underneath: clock, artificial horizon, speedometer. At right-hand side between the two rows there are the landing gear control and compass.

b. Re 5 e: Of rubber, 32 x 28 x 16 inches, filling sleeve with bayonet closure.

7. Production:

Eight to ten railroad carloads daily

[Redacted]

25X1X

25X1X

[Redacted]

8. Boilershop and railroad sidings were available.

25X1A

[Redacted] Comment:

25X1X

[Redacted] this is the only report on the KOSTINO accessories factory, unknown until now. From the detailed description of the production of this plant it can be concluded that tricycle landing gears with nose wheels are manufactured here, the main-wheels of which retract into the wings toward the outside. It is not known for what type of aircraft these parts were manufactured. Planes equipped with this type of landing gear were repeatedly observed on various airfields, but the type of aircraft was not identified.

1 Annex: Aircraft Accessories Plant in KOSTINO

CONFIDENTIAL

[Redacted]

25X1A

Aircraft Accessories Plant in KOSTINO

Legend:

- 1 a Wing seen from below
- A Wing of light metal
- B Recess for landing gear
- C Landing flap
- D Aileron
- 1 b Section through 1 a
- E Bracing of light metal, partially also of plywood

Sketch No.1.

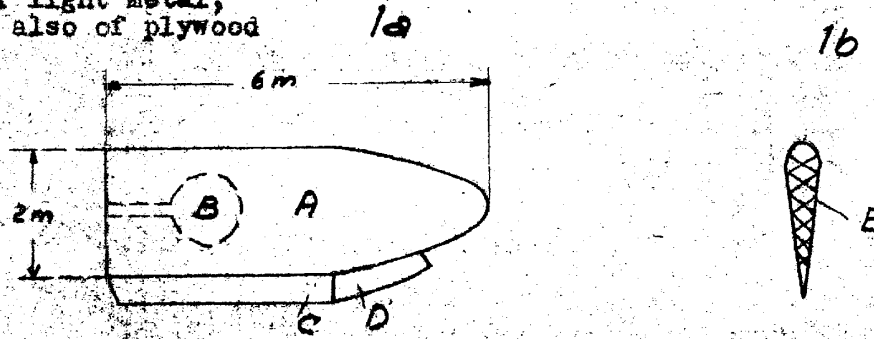

Sketch No.2.

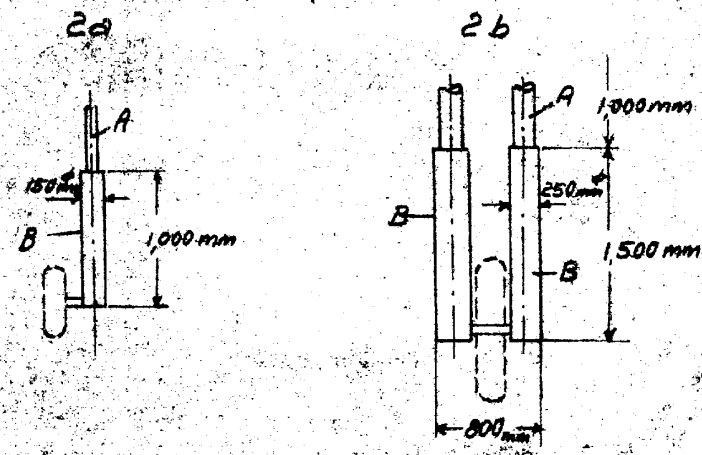

Legend:

- 2 a and 2 b Components of landing gear
- A and B Telescopic struts



4. Production:

Inter alia armor plates and circular tracks.

- 5. The kulebaki steelworks border on the railroad station so closely that the tracks of the railroad station are in the plant area.
- 6. Work department 1 produced wood gas. (The building was about 45 x 27 meters). Work department 2 was the foundry. It consisted of a workshop about 69 x 37 1/2 meters with a plate-covered arched roof. The installation had six open-hearth furnaces, 7 1/2 x 4 1/2 x 3 1/2 meters, walled up. Work department 5 was the hammering department producing wheels for locomotives and railroad cars.
- 7. Electricity was generated in an American power train of several railroad cars.
- 8. For partial plant sketch and horizontal plan of the foundry see Annex 1.

25X1A

Comment:

a. Only part of the kulebaki metallurgic plant is covered by the above report. From a comparison with the aerial photograph attached as Annex 2 it is concluded that the reported plant buildings are presumably in the southern part of the area. The largest building there extending from northwest to southeast may be the foundry with the arched roof  did not furnish any information on observed new buildings and the plant did not suffer war damage, it is inferred that the aerial photograph taken in 1942 approximately corresponds with the present state of the plant. From the aerial photograph it is evident that the track system of the railroad station actually overlaps the plant area. Probably most of these tracks are spur tracks of the plant joining the tracks of the railroad station on the eastern side of the plant.

25X1A

25X1A

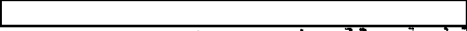
b.  whether the number of the open-hearth furnaces was actually doubled. In case the quantity of the furnaces had been increased so much, the capacity of the plant would essentially have been raised. The raw steel capacity of the open-hearth furnaces amounted to about 250,000 tons in 1943, when seven Martin furnaces were in operation. Besides raw steel, the plant produced rolled steel, steel girders, sheet metals, armored plates, wheel tires, profile irons and gas pipes in 1943. Fifteen thousand workers were employed in March 1943.

c. Power generating by a power train of seven cars had not been started at the plant before the end of the war. The required electricity had been supplied by the Malakhna power plant until late in 1943.

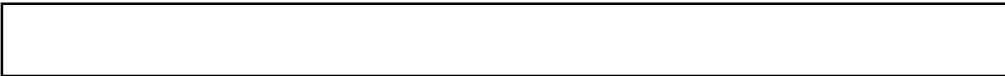

25X1A

- 2 Annexes: 1. Blueprint, Southern part of the Plant "Kirov"
- 2. Photo, Metallurgic plant, Kirov.

Legend to Annex 1:

- 1 Plant department 1, 45 x 27 meters, wood gas generating station
- 2 Heating station, 36 1/2 x 18 meters, with two brick smokestacks and several sheet metal smokestacks



CONFIDENTIAL

- 3 -

25X1A

- 3 Plant Department 2, foundry, 90 x 37½ meters, with arched plate roof
- 4 Forge, 43 x 27 meters
- 5 Rolling mill, 73 x 45 meters
- 6 Plant Department 5, hammer department, 73 x 45 meters

Layout of foundry:

- a Six open-hearth furnaces
- b Two traveling cranes ~~charging the furnaces~~
- c Traveling crane for the distribution of castings
- d Narrow-gauge track

CONFIDENTIAL

25X1A

Southern Part of the Plant "Kirov"

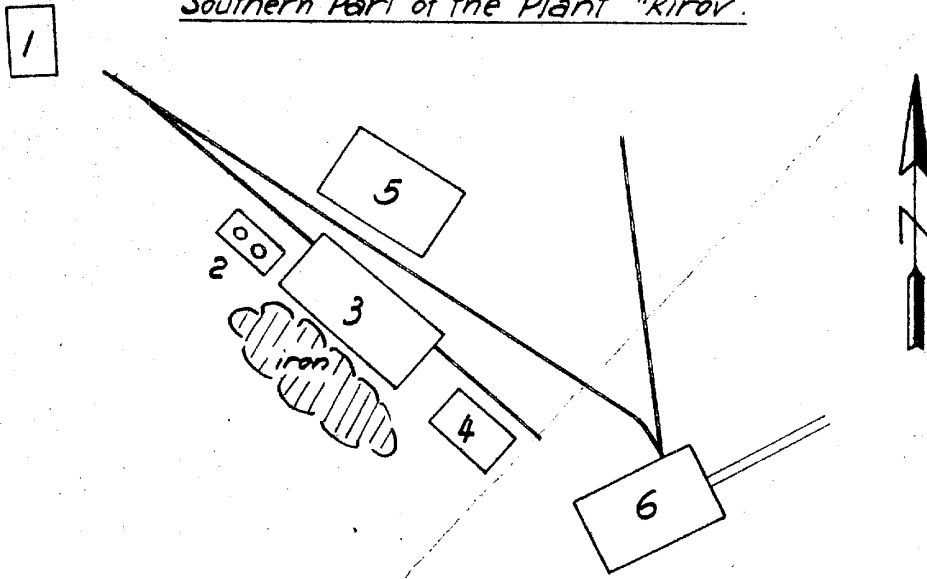

scale: about 1:4,000

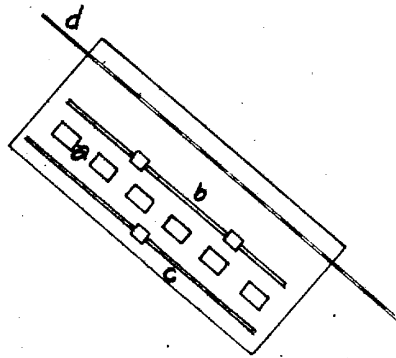

scale 1:2,000

Legend: See report

COUNTRY Soviet Union REPORT NO. _____
 TOWNSHIP Lyubertska Farm Equipment Manufacturing Plant No 722 in Lyubertska

EVALUATION 25X1A PLACE OBTAINED 25X1A 25X1A

DATE OF CONTENT _____ 25X1C

DATE OBTAINED _____ DATE PREPARED 3 April 1950

REFERENCES 25X1C

PAGES 3 ENCLOSURES (NO. & TYPE) 1 blueprint

REMARKS _____

25X1X

1. Location:

The Farm Equipment Manufacturing Plant No 722 is on the town boundary of Lyubertska (39°40'E/54°40'N), Moscow Oblast, about 20 km southeast of Moscow, directly southwest of the railroad mainline to Kolonna. An airfield is south of the plant and directly south of the highway to Moscow.

2. Plant installations:

The plant, covering an area of about 320 x 450 meters, is an old installation. The buildings are in a mediocre condition. A railroad connection is available. Power and steam are supplied by a plant-owned power station. For plant layout see Annex.

3. Work force:

A total of 7,500 civilian workers and 650 PWs working three shifts.

4. Production:

The plant manufactured shells during the war. During 1945 and 1946 the plant was converted to peacetime production: Grass cutters, grain binders, hemp binders and transmissions for combines.

25X1A

Comment:

a. This report furnishes information on the latest status of the Farm Equipment Manufacturing Plant No 722. The location and the plant layout as reported confirm previous reports.

b. According to a report in the Soviet newspaper Izvestija, dated 2 August 1949, this plant produces an automatic grass cutter equipped with a blade 10 meters long and a cutting capacity of 6.55 hectares per hour.

1 Annex: blueprint, Farm Equipment Manufacturing Plant No. 722 in Lyubertska.

CLASSIFICATION CONFIDENTIAL

25X1A

Legend to Annex:

- [REDACTED]
- 1 Main gate and guard
 - 2 Plant department No 26, two-story brick building, 54 x 22½ x 13½ meters, model making locksmith and carpenter shops, quarters for apprentices
 - 3 Park
 - 4a Testing department and laboratory, material testing
 - 4b Locksmith repair shop (4a and 4b one brick building, 54 x 22½ x 13½ meters)
 - 5 Iron structure with brick masonry, 54 x 22½ x 13½ meters housing:
 - a Department No 6, plant repair department and mechanical department
 - b Department No 23, construction office
 - c Compressor station, three compressors
 - 6 Iron structure with brick masonry, 54 x 22½ x 13½ meters, housing:
 - a Mechanical shop for assembly and testing of new constructions
 - b Department No 14, foundry with two large cupola furnaces, molding shop, die processing shop and sheet metal smokestack, 30 meters high
 - c Fire department
 - 7 Brick building, 54 x 22½ x 7½ meters, housing:
 - a Ambulance
 - b Electrical repair shop
 - 8 Power plant, steel structure with masonry, 54 x 30 x 10 meters, brick smokestack, 30 meters high. Power and steam supply for the plant
 - 9 Coal storage
 - 10 Garage, brick structure, 36 x 13½ x 4½ meters
 - 11 Lumber drying shop, 18 x 18 x 4½ meters, brick structure
 - 12 Lumber and coal storage
 - 13 Tin and iron storage
 - 14 Iron structure with masonry, 54 x 27 x 9 meters, housing:
 - a Department No 1, forge and press cutting shop
 - b Grinding shop with six electric hardening furnaces; blades for the reaping machines are produced here

CONFIDENTIAL



- 15 Iron structure with brick masonry, 63 x 45 x 16 $\frac{1}{2}$ meters, housing:
 - a Mechanical shops and assembly departments, production of wheels, shafts, axles, bolts and screws etc.
 - b Assembly of grass cutters
 - c Carpenter shop and mechanical section, woodworking shop for farm equipment machinery
 - d Fire tower, 36 meters high used by the nearby fire fighting unit
- 16 Park
- 17 Iron structure with brick masonry, housing: 63 x 22 $\frac{1}{2}$ x 10 meters:
 - a Department No 13, foundry for heavy major machine parts, two large cupola furnaces, molding and cleaning department
 - b Transformer station
- 18 Iron structure with brick masonry, housing:
 - a 1. Camp No 7859 and registration office
 - b Department No 18, ground floor: storage for finished grass cutters and spare parts, shipping department and paint shop; second floor: department No 30, production of transmissions for grass cutters and combines. Department No 30 was set-up between July 1948 and February 1949. Production was started in March 1949.
Third floor: lath for spare parts
Fourth floor: quarters for plant workers
- 19 Oil storage, several 100 barrels of oil are stored there, each barrel containing 200 liters
- 20 Filling station
- 21 Core making department, brick structure, 18 x 9 x 7 $\frac{1}{2}$ meters
- 22 Iron structure with brick masonry, wooden roof, housing:
 - a Department No 9, foundry for small parts with two cupola furnaces, molding section and polishing shop
 - b Large annealing furnace, a conveyer belt goes through the furnace. Chain links, spare parts, cogwheels etc. are packed into a metal box, this box is then put on the conveyer belt and slowly runs through the furnace. The parts are later cooled and then go to the respective plant departments.
- 23 Gate No 2

CONFIDENTIAL

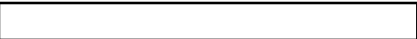

CONTROLLED DISTRIBUTION

Approved For Release 2002/08/15 : CIA-RDP83-00415R010900070007-6

Farm Equipment Manufacturing Plant No. 722 in USSR-131

Annex to

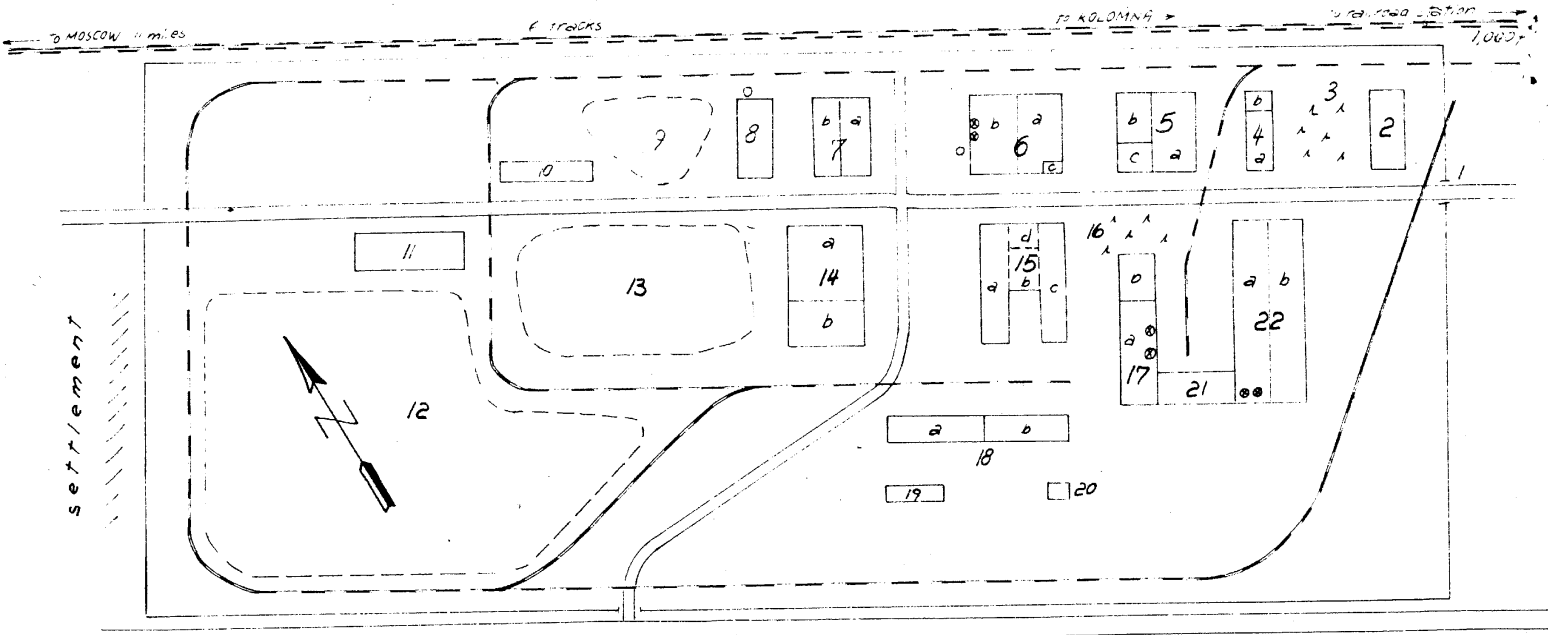

settlement

airfield

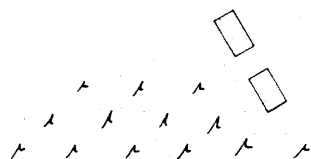

Legend: See report

not to scale

COUNTRY Soviet Union REPORT NO

TOPIC Steam Engine Plant in LYUDINOVO

INTELFORM 5

25X1A 25X1A

EVALUATION [redacted] 25X1A PLACE OBTAINED [redacted] [redacted]

DATE OF CONTENT [redacted] 25X1C

DATE OBTAINED DATE PREPARED 18 January 1950

REFERENCES

PAGES 4 ENCLOSURES (NO. & TYPE) 1 Blueprint 25X1X

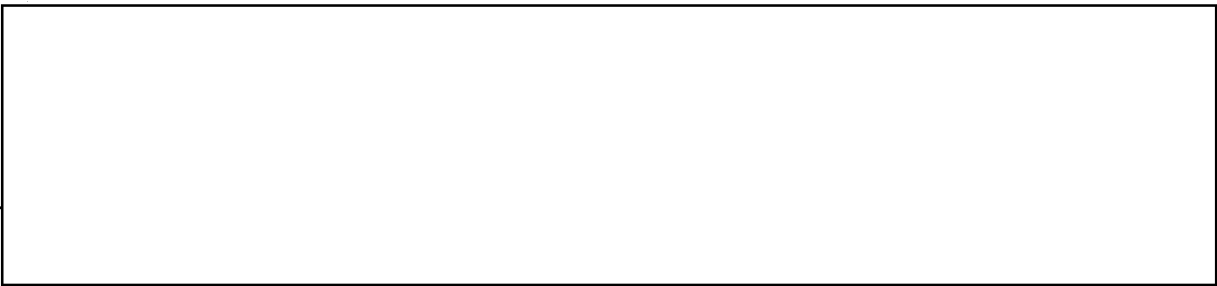

1. Location of the Plant and Traffic Facilities:

On both banks of the Lepolod River, at the outlet of this river from Lyudinovskoye Lake. The plant is bordered by the town of LYUDINOVO (53°52' N/34°25' E) on the west, south and east. LYUDINOVO is located at the BRINSK-LIROV railroad line. East of this line is a branch line from GURZHEL, traversing the plant to the north (see Annex).

2. Plant History

a. The plant is said to be very old. The Red Army blasted the plant during its retreat in 1941. Almost all buildings were reconstructed, reequipped and in operation by October 1947. Only the storage dam with turbines, the power station and some workshops were still under construction. [redacted] Recon- 25X1A
struction was completed in June 1948 [redacted]

b. Most of the machines were of German make and were in good condition [redacted]

c. T 34 tanks and shells were allegedly produced in the plant during the war [redacted]

d. According to [redacted] large crankshaft benches, parallel planing machines and similar machines were installed in the plant in 1947. [redacted] believes this machinery to be an indication of projected tank production. According to [redacted] ammunition 25X1A
will be produced when the plant is completed.

3. Plant Installations:

(The following enumerations correspond to the numbers of the sketch. The plant installations were determined according to the sketches [redacted])

(1) Foundry [redacted]

Installation: several steel furnaces [redacted] 25X1A

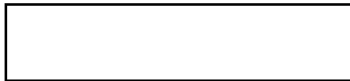

25X1A

indicated two furnaces [redacted] three or four cast furnaces and [redacted] six open-hearth furnaces)

25X1A

Production: Heating pipes and radiators (8 inches in thickness). [redacted] wheel sets, connecting rods and [redacted] shells and [redacted] parts were allegedly manufactured during the war (large stacks of this material were still stored in front of work- shop [redacted] annex) in June 1948)

25X1A

25X1A

25X1A

Installation: One forging furnace, one pneumatic hammer

25X1A

Production: Steam boilers for locomobiles. The front boiler plates were treated in a press [redacted]

25X1A

25X1A

(3) Forge [redacted] Installation: Four forge fires [redacted], three steam hammers [redacted]

25X1A

Production: Single parts such as bolts and screws.

(4) Assembly department [redacted]

25X1A

Installation: It was divided lengthwise into subsections. One half of the building was a two-story structure [redacted]

25X1A

Installation on the second floor: Eight to ten vertical turning and boring machines [redacted] five bench

25X1A

planers, six drilling machines with swinging arm (vertical type, eight drill heads), eight hydraulic presses (including one Ger- man press of several tons pressing capacity) [redacted]

25X1A

Three "V.B.M." benches (fully automatic operation with push- button switch, feed and leadscrew) [redacted]

25X1A

Production: The locomobiles were assembled in this department and the measuring instruments installed. The engines were painted and their pressure resistance checked on boiler test stands [redacted]

25X1A

(5) Storage dam [redacted] The dam (with turbine plant, according to [redacted] was under construction during the time of observation.

25X1A

25X1A

(6) Power station [redacted] Installation: Hydro-power station. The main building had an additional four or five cantonment buildings. The station was under construction [redacted]

25X1A

The power station was scheduled to be in operation by 1 January 1950. Feed canals from the lake to the turbines were excavated and concreted in June 1948. Two large locks were built between the power station and the lake. The water was detoured in a 100-foot wide canal, passed under the power station and returned in side canals to the river bed. The difference in elevation between the lake and the power station was about 25 feet [redacted]

25X1A

25X1A

25X1A

(7) Sawmill and carpentry [redacted] Installation of the sawmill: two frame saws [redacted] Installation of the carpentry: Planers, boring and milling ma- chines. A total of 20 machines was in this shop [redacted]

25X1A

25X1A

Production: Work in these shops was done for plant requirements.

25X1A

SECRET [redacted]

Steam Engine Plant in LYUDINOVO

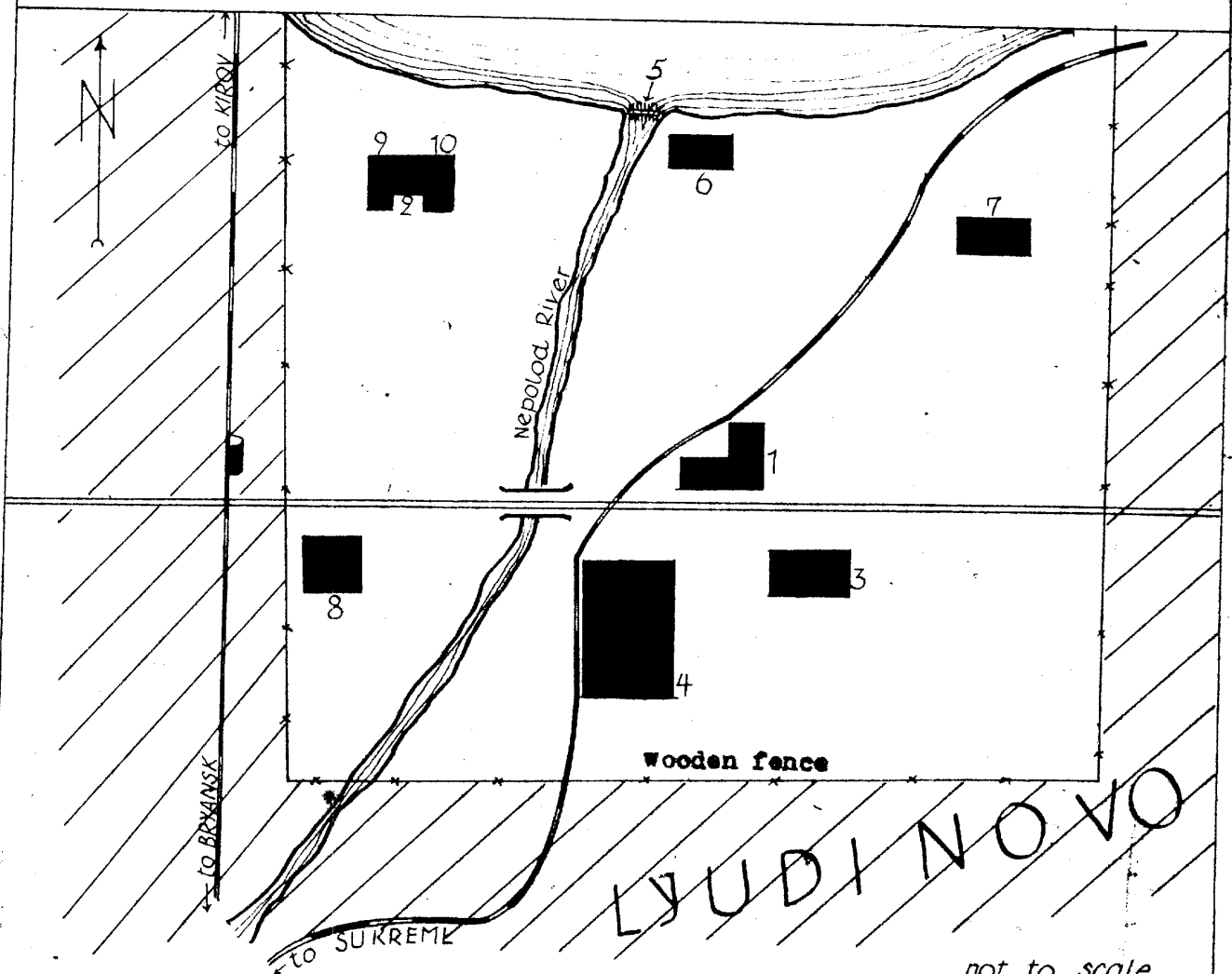

not to scale

Legends:

- 1 Foundry
- 2 Boiler forge
- 3 Forge
- 4 Assembly department
- 5 Dam
- 6 Power station
- 7 Sawmill and carpentry
- 8 Administration
- 9 Workshop building
- 10 Workshop building under construction

ILLEGIB

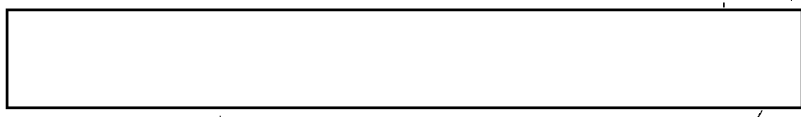

CLASSIFICATION SECRET [REDACTED]

COUNTRY Soviet Union REPORT NO. [REDACTED]

TOPIC Automobile Factory in Lyudinovo

EVALUATION [REDACTED] 25X1A PLACE OBTAINED [REDACTED] 25X1A [REDACTED] 25X1A

DATE OF CONTENT [REDACTED] 25X1C

DATE OBTAINED [REDACTED] DATE PREPARED 28 March 1950

REFERENCES [REDACTED]

PAGES 3 ENCLOSURES (NO. & TYPE) 1 Blueprint

REMARKS [REDACTED]

25X1X

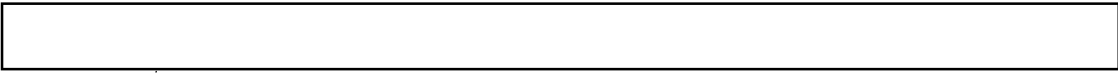

1. Location:

South of Lyudinovo is a lake, about 1,000 x 1,500 meters, at the northeast corner of the plant. The outlet of the lake runs through the plant.

2. Traffic facilities:

The plant is connected by tracks with the Soviet-gauge Vyasma-Bryansk railroad line and with the narrow-gauge railroad line, running to the east.

3. Size:

About 1,000 x 1,000 meters (a walk along the edge of the plant takes 15 minutes).

4. Layout:

a. Boiler forge: About 100 x 100 meters, equipped with several steam hammers, forging places and lathes. The boilers were formerly riveted. Since the commitment of German PWs they were electrically welded.

b. Large foundry and mouldry: About 100 x 100 meters, a high building with glass roof, equipped with four steel furnaces which are charged with iron and steel ingots as well as with scrap, coke, and limestone. [REDACTED] the proportion of the mixture and the capacity of the furnaces. Fly wheels, gear wheels, connecting rods etc. were cast.

25X1A

c. Small nonferrous metal foundry: About 100 x 30 meters, equipped with two liquid tar-fueled furnaces with blowers. Small parts as bearings, taps, screws, threads and other

SECRET

[Redacted]

25X1A

25X1A

[Redacted]

nonferrous metal products were manufactured. [Redacted]

25X1X

25X1X

d. Mechanical workshop, about 100 x 100 meters, equipped with 100 modern lathes of all kinds, including revolving lathes, some of them up to 20 meters long (time of installation: 1947). Only 10 of these lathes were in operation. The parts cast in section B, were finished here.

e. Small mechanical workshop: About 80 to 60 meters, equipped with several modern German machines of which only some were used. Russian civilians were trained on these machines by German PWs. Parts cast in sections B and C were finished here.

f. Assembly shop: About 100 x 100 meters. Assembly of locomobiles which were shipped from there via the Soviet-gauge railroad line.

g. Administration building and power plant: About 20 x 40 meters. The power plant is coal-fueled. [Redacted]

25X1X

25X1X

h. Garage: About 60 x 20 meters, for about 20 motor vehicles of the plant.

i. Dam: The lake is dammed in its southwestern corner by a dam about 50 meters long and 20 meters wide which was completed in 1947.

25X1X

[Redacted] it is planned to build a hydro-power plant. The construction of this plant had not started in 1947.

6. Production:

Locomobiles for agriculture are manufactured in the plant. About 90 to 100 locomobiles left the plant every month.

25X1X

[Redacted] The reported quantity also agrees with the number of units manufactured in the foundry.

From the following facts [Redacted] that the production of tanks was to start in October 1947:

25X1A

a. At several places parts of T34 tanks (scrap) were still lying around.

b. The plant manufactured tanks before and during the war.

c. In the course of 1947 modern machines were installed in several sections which are not used for the construction of locomobiles.

SECRET

[Redacted]

25X1A

25X1A

SECRET [REDACTED]

25X1A

[REDACTED]

d. Several Russian workers, trained on the new machines, stated that the machines are destined for the production of tanks.

e. All ICBMs were removed from the plant in October 1947.

7. Security measures:

The plant was guarded by MVD units. The entire plant was surrounded by a wooden fence reinforced by barbed wire. Every 100 meters a watch tower had been erected.

1 Annex: Locomobile Factory in Lyudinovo.
(location and layout, sketch [REDACTED])

25X1A

SECRET [REDACTED]

25X1A

CONTROLLED DISTRIBUTION

Approved For Release 2002/08/15 : CIA-RDP83-00415R010900070007-6

Annex

Locomotive Factory in
LYUDINOV

Legends

- a Boiler forge
- b Large foundry and mouldry
- c Small foundry
- d Mechanical workshop
- e Small mechanical work-shop
- f Assembly shop
- g Administration building & power plant
- h Garage
- i Dam
- k PW Camp No. 7109/1

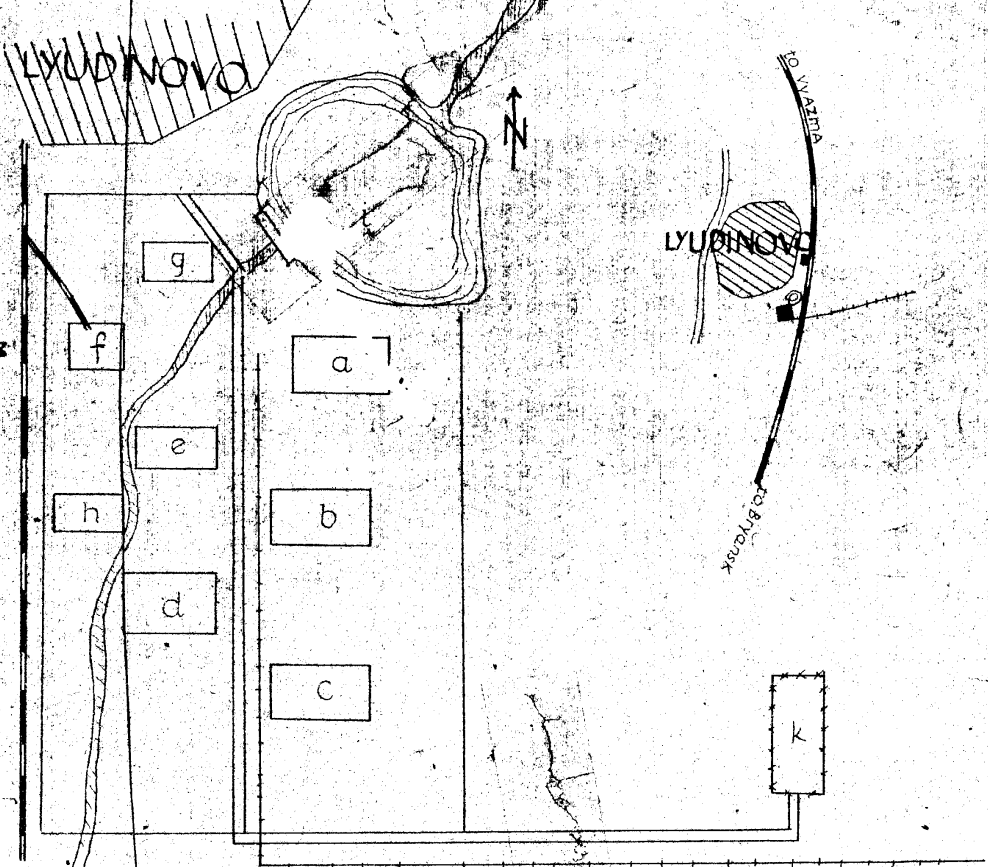

CONFIDENTIAL

COPY Soviet Union

REPORT NO.

TOPIC Orel Power Plant

25X1A

EVALUATION [] 25X1A

PLACE OBTAINED

25X1A

DATE OF CONTENT

25X1C

DATE OBTAINED

25X1C

DATE PREPARED 18 April 1950

REFERENCES

PAGES 2

ENCLOSURES (NO. & TYPE) 1 Blueprint

REMARKS

[Redacted]

25X1X

1. Location :

About 1 1/2 km northwest of the Orel (36°05'E/52°53'N), Orel Oblast, Main Station, between the railroad line to Moscow and the Oka River, and about 730 meters north of the former tank plant Zavod No. 9. A 36 meter wide gorge is between the power plant and Zavod No. 9.

2. Plant installations :

The power plant is comprised of the following two sections : Plant No. 1, completed in 1945, equipped with one boiler and one turbine, and Plant No. 2, completed in November 1948, equipped with two boilers and one turbine. The two plants are adjoining.

a. [Redacted] that the construction of an additional plant (No. 3) was planned to start in January 1950. This new power plant was to be attached to Plant No. 2. A railroad connection was available. For plant layout see Annex.

3. Work force :

Since the completion of plant No. 2 three shifts, each with about 25 laborers and an additional 10 employees, working in the administration.

4. Capacity :

Plant No. 1 : 2,000 Kws

Plant No. 2 : 6,000 "

Scheduled capacity of plant No. 3 : 6,000 Kws.

CLASSIFICATION CONFIDENTIAL

25X1A

CONFIDENTIAL

25X1A

2

25X1A

Comment :

Since there are no other records available on the power plant of Orel,

I Annex : Power Plant of Orel.

Legend to Annex :

A. Power plant

- 1 Unloading platform with coal bunker
- 2 Scale house
- 3 Slanting elevator
- 4 Power plant No. 1, 350 x 23 x 13½ meters, brick structure with flat roof covered with concrete slabs
 - a. boiler, 4½ x 3½ x 2½ meters
 - b. Turbine, Elliot make, 2,000 kws, 3,000 rpm
 - c. Switching station with automatic switching installations of US origin, General Electric make
 - d. Administration
- 5 Power plant No. 2, 650 x 18 x 13½ meters, brick structure with flat roof covered with concrete slabs
 - a. Two boilers, type Billeystoker, each 3½ x 4½ x 2½ meters
 - b. Turbine in horizontal position, Elliot make, 3,000 rpm
 - c. Generator 6,000 kws
 - d. Condenser
 - e. Switching station with four automatic switching installations from General Electric
- 6 Distributor
- 7 Electrical pumping station, 9 x 7½ meters for clean water
- 8 Slag dump
 - a. narrow-gauge railroad
- 9 Cooling plant with three separated concreted basins, each 135 x 45 x 2½ meters equipped with spraying installation

- B. Zavod No. 9
- C. Hood working factory
- D. Various storage sheds
- E. Engineer barracks
- F. Wooden bridge
- G. Railroad bridge
- H. PW camp No. 7263/1.

CONFIDENTIAL

25X1A

CONTROLLED DISTRIBUTION

Approved For Release 2002/08/15 : CIA-RDP83-00415R010900070007-6 Annex to
Power Plant of OREL

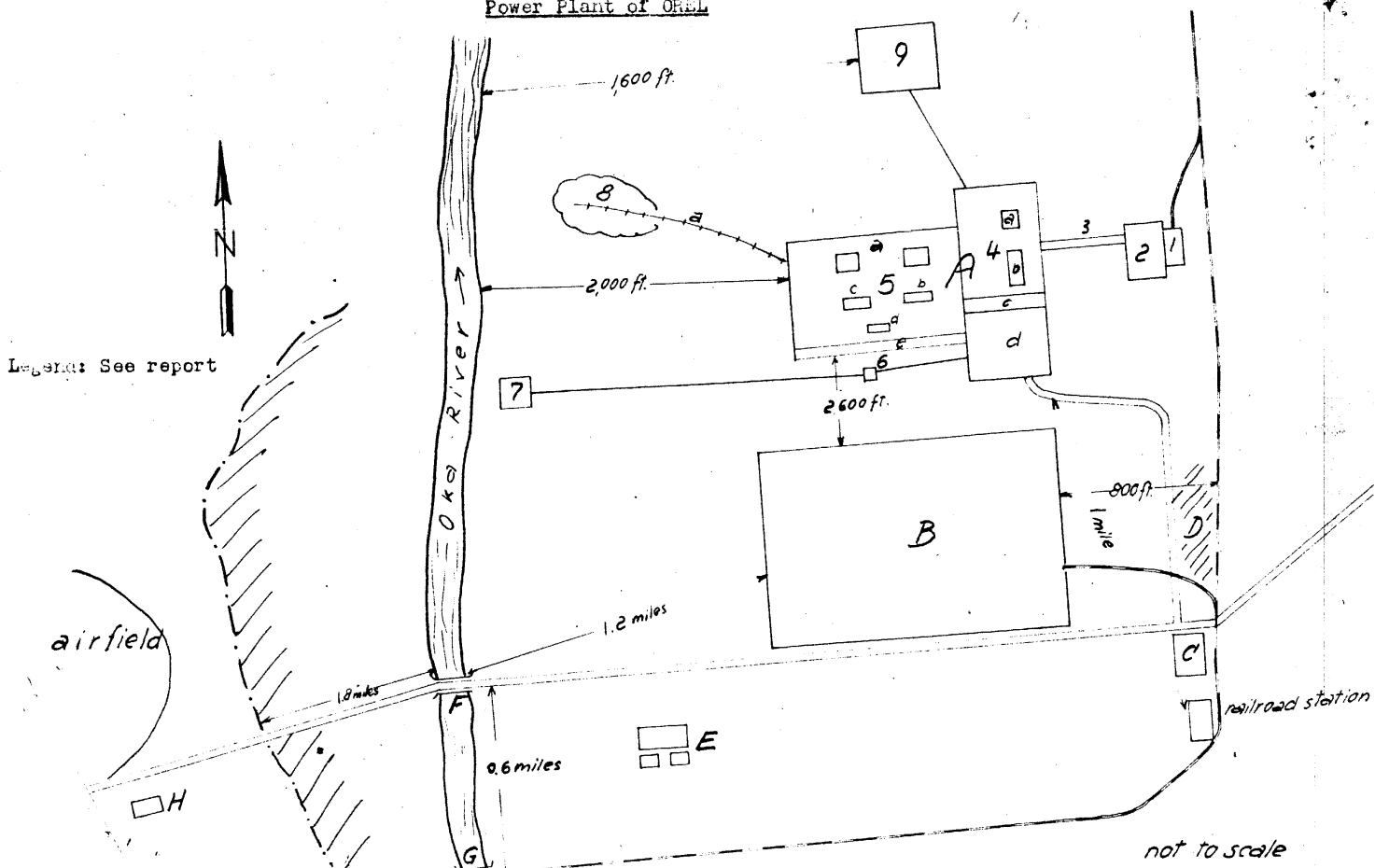

CLASSIFICATION

25X1A

COUNTRY Soviet Union REPORT NO.

TOPIC Orel Power Plant

EVALUATION 25X1A PLACE OBTAINED 25X1A 25X1A

DATE OF CONTENT 25X1C

DATE OBTAINED 31 March 1950

REFERENCES 25X1C

PAGES 2 ENCLOSURES (NO. & TYPE)

REMARKS

RETURN TO CIA LIBRARY

25X1X

[Redacted]

1. Location :

On the northwestern outskirts of Orel (38°05'E/52°58'N), Orel Oblast, about 250 m west of the railroad line to Moscow, and 600 m east of the Oka River, the Savod No. 9 Plant is farther to the south.

2. Plant installations :

The plant, a new installation, was constructed in two sections. The smaller plant was completed and started operation, in 1945. The construction of the larger plant started immediately afterwards and was completed by 1948. The small plant is equipped with one boiler and a turbine. The large plant had two boiler installations of US make. With the large section in operation, the small section operated only temporarily as a substitute. Water for the boilers came from the Oka River and was first pumped through a purifying installation in the large plant section. It was learned [redacted] that the construction of a third plant was planned to start in January 1950. [redacted] observed the arrival of large boxes, presumably with machine parts, which were stored in the plant. [redacted] connection between the boxes and the plant construction.

3. Work force :

No details available.

4. Capacity :

Small power plant, 2,000 kws.

25X1A

CLASSIFICATION CONFIDENTIAL [redacted]

CONFIDENTIAL

[REDACTED]

25X1A

2

Large power plant, 6,000 kw.

The power was directed to the town, the industrial installations^a and to the railroad.

25X1A

[REDACTED] Comment :

The Orcl power plant has been reported twice recently. This report confirms the previous statements. Location and plant layout are thus clarified and can be considered facts. A good sketch of the location and plant layout was furnished [REDACTED]

25X1A

[REDACTED]

25X1A

CONFIDENTIAL

[REDACTED]

25X1A

COUNTRY Soviet Union REPORT NO. _____

TOPIC Orel Power Plant

EVALUATION 25X1A PLACE OBTAINED 25X1A 25X1A

DATE OF CONTENT 25X1C

DATE OBTAINED DATE PREPARED 31 March 1950

REFERENCES 25X1C

PAGES 2 ENCLOSURES (NO. & TYPE) _____

REMARKS _____

**RETURN TO CIA
LIBRARY**

25X1X

1. Location :

500 m northwest of the Orel railroad station (36°05'E/52°53'N), Orel Oblast, in the northern town section, 500 m from the Oka River.

2. Plant installations :

Excavations for the construction of the power plant started in February 1945. A small power plant was first constructed, the bare structure of which was completed in early 1947. The construction of a larger power plant, west of the small one, was planned a short time later. The completion of the new power plant was scheduled for 1950. A railroad connection is available.

3. Work force :

350 PWs and 50 Soviet working on the construction.

4. Capacity :

No details available.

25X1A Comment :

The report is forwarded although the time of observation is back to as it is a valuable supplement to previous information. The statement of the according to which a large power plant was constructed west of the previously known power plant, is confirmed.

25X1X
25X1A

25X1A

CLASSIFICATION CONFIDENTIAL

CONFIDENTIAL

[REDACTED]

25X1A

25X1A

[REDACTED] stated that the construction of the new power plant was completed by November 1943.

[REDACTED]

25X1A

CONFIDENTIAL

[REDACTED]

25X1A

COUNTRY Soviet Union REPORT NO. _____

TOPIC Rulon chemical plant in pzerzhinsk-Igumnovo

EVALUATION 25X1A PLACE OBTAINED 25X1A 25X1A

DATE OF CONTENT _____ 25X1C

DATE OBTAINED _____ DATE PREPARED 3 April 1950

REFERENCES _____

PAGES 2 ENCLOSURES (NO. & TYPE) 2 Blueprints

REMARKS _____

**RETURN TO CIA
LIBRARY**

25X1X

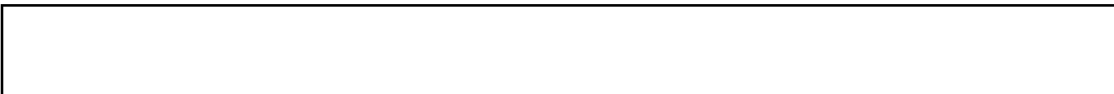

1. Location:

northeast of Igumnovo (43°38' E/56°14' N), Gorki Oblast, about 30 km west of Gorki, north of railroad line and road Gorki-Moscow.

2. plant installations:

a. The Rulon Chemical Plant is comprised of two sections, the eastern one of which existed before 1939 and produces plexiglass.

b. The construction of the western section started in September 1947. Boilers from the Leuna plant in Horseburg were installed here. The essential parts of this section were completed by the middle of 1949. After the first scheduled deadline on 1 May 1949 was not met for unknown reasons, operation was planned for late 1949.

25X1A

c. The total length of the plant is about 3½ km. obtain details on the eastern section. A railroad connection is available. Power was supplied through underground transmission lines by the power plant, located on the other side of the railroad line. for plant layout see annex.

3. Work force:

600 to 800 Pys and several hundred Soviet laborers working on the construction. Labor for the production had not arrived in July 1949. Only a few, presumably foremen, were appointed to their future jobs.

4. Production:

The eastern plant section produces plexiglass. any details on the intended production of the western section which

25X1A

CLASSIFICATION CONFIDENTIAL

25X1A

COPY OF ENCLOSURE IN LIBRARY

CONFIDENTIAL

25X1A

was under construction. According to [redacted] it was [redacted] gasoline. 25X1X

25X1A

[redacted] Comment:

a. The combined chemical plants in Dzerzhinsk are known from prewar times. They are east of town, on both sides of the railroad line to Gorki. The limits of the individual plants were not definitely determined at the end of the war.

To indicate the location, the sketch supplied by [redacted] 25X1A [redacted] is transmitted as Annex 2. [redacted] reported on the 25X1A power plant and also furnished a presumably correct diagrammatic survey of the arrangement of the individual installations.

Both sketches agree on the location of the Rulon plant.

b. The fact that, in recent years, the plant was modernized by the installation of machinery from the German Leuna Plants, was known. New constructions are reported for the first time, a fact which makes report particularly valuable.

c. The "old" plant section [redacted] 25X1A is reproduced on a German aerial photograph, dated July 1942. At that time the plant was designated No 148. 25X1A

[redacted] 25X1A

e. A Pravda issue of the Summer of 1949 stating that the plant mainly produced bulletproof safety glass for the air armament industry confirms the reported production of the old factory.

2 Annexes: (1) Rulon Chemical Plant in Dzerzhinsk-Igumovo
(2) Chemical Combine Dzerzhinsk.

25X1A

CONFIDENTIAL

25X1A

Annex I

Legend to Annex

A. Gulon Chemical Plant

1. Department No 108, 60x27 meters, equipped with two large boilers
2. Department No 112, 54x18 meters, distributor system for the steam pipeline from the power plant
3. Department No 105, 54x18 meters, power station with transformers, compressors and switchboards. Stirring plant with square basins, insulated with asbestos and peat slabs.
4. Department No 104, 36x13½ meters with 30 meter high smoke-stack, probably boiler house; three furnaces were constructed here
5. Department No 102, 54x18x30 meters, equipped with four steel boilers in vertical position, purpose unknown
6. Department No 101, 72x36x37½ meters, six stories. The middle section is not roofed, the workshop is equipped with various kinds of boilers.
7. Pumping station, connected to department No 101 and the boilers north of the pumping station by above ground pipelines.
8. Four outdoor boilers, 4½ meters, 7 meters in diameter. Two boilers are brick lined, all four boilers are separately fenced in and surrounded by 1½ meter earthen wall.
9. Twenty pumping points in a shed with railroad tracks going through. Twenty additional pumping points are on both sides of another railroad line outdoors. Both spur tracks end shortly beyond the pumping points.
10. Building, purpose unknown
11. Four boilers in vertical position, 4½ meters high, 10 to 12 meters in diameter, constructed of five mm thick sheet metal, insulated with glass wool, on stout concrete foundations. The area is surrounded by an earth wall, 1.6 meters high. Three parallel underground pipelines lead to No 13.
12. Pumping station with several electric motors, presumably pumping station of No 9 above
13. About 16 boilers [redacted] each 3½ meters high and 3½ meters in diameter. The area was surrounded by a six feet high earth wall.

25X1A

CONFIDENTIAL

25X1A

CONFIDENTIAL

[redacted]
S/annex 1

25X1A

- 14 Department No 103, 72x27x36 meters, five stories. All stories house various boilers
- 15 Department No 106, 54x18 meters, equipped with three large boilers, 13½ meters high and 6 meters in diameter [redacted] A sur- face pipeline leads from here to No 17. 25X1X
- 16 Department No 118, 36x13.5 meters, pumping station for cooling water, equipped with several rotary pumps and on either side of the station one concreted basin, each 12x4½x4½ to 5 meters.
- 17 Department No 119, cooling tower, about 36 meters high and 13½ meters in diameter with pipeline connection to department No 105 (item No 3), department No 106 (item No 15) and department No 118 (item No 16).

All plant departments are interconnected by underground pipelines, 3 to 13½ mm in diameter. The above ground pipelines rest on iron pillars and are recorded on sketch (as far as

25X1A [redacted]
18 area of the old plant

19 P. Camp No 7117/7

B power plant

C Java Chemical Plant.

CONFIDENTIAL

[redacted]
25X1A

CONFIDENTIAL

1/Annex 2

25X1A

Legend to Annex

- 1 Yulinin Chemical Plant
- 2 Stroi Chemical Plant
- 3 Oka Chemical Plant
- 4 power plant
- 5 Metalmost Plant (presumably mechanical department of the power plant)
- 6 Yava Chemical Plant
- 7 Kulon Chemical Plant and PW camp
- 8 Sky scrapers
- 9 Large bakery
- 10 PW camp.

CONFIDENTIAL

25X1A

CLASSIFICATION

25X1A

COUNTRY Soviet Union

REPORT NO.

TOPIC Plant No 837, Treatment of Precious Stones in UGLICHEVALUATION 25X1A

25X1A

25X1A

PLACE OBTAINED

DATE OF CONTENT

25X1C

DATE OBTAINED

DATE PREPARED 3 January 1950

REFERENCES

PAGES 2 ENCLOSURES (NO. & TYPE)

REMARKS

**RETURN TO CIA
LIBRARY**

25X1X

1. Location:

About $\frac{1}{2}$ mile north of UGLICH ($38^{\circ}20'E/57^{\circ}31'45"N$) on the east side of the road to RYBINSK. There was a wood north of the plant and a factory about $\frac{1}{2}$ mile to the SW.

2. Size: 0.6x0.6 miles.3. Layout:

Administration. Manufacture: Building 320x100 feet, four stories, boilerhouse, garage, modern installation originating from Switzerland.

4. History:

The plant was constructed between 1939 and 1948. Production started in July 1946.

5. Name: R.T.K. 2, Plant 837 (from Soviets).6. Management: NIKOLIOV Chief Manager, BABINSKI Subchief.7. Labor:

3,000 Soviets, in 2 shifts.

8. Production:

Valuable jewels were shaped, which were used for high-grade precision instruments, compasses and watches and/or chronometers. For high-grade instruments corundum was used, for less sensitive instruments, agate stone.

b. Rubies and sapphires (synthetic) were supplied by Switzerland up to November 1947 but since then came from BITTERFEID according to Soviets. The degree of hardness was 8 to 9. The

CLASSIFICATION SECRET

25X1A

SECRET [REDACTED]

25X1A

agate stone is a natural stone found in the Ural and the Caucasus. These stones were round, oval, triangular, rectangular in shape with spiky edges.

c. The stones were shaped on machines of very good technical quality. The boring, drilling and polishing materials used were chiefly diamonds and tripoli. Diamonds for technical purposes were also manufactured in the plant. More detailed information was not available. The plant had its own wire drawing mill where the thin wire required for the working process was made.

d. The round stones, used for the high-grade instruments, (measurement instruments, compasses and watches chronometers), had the following diameters: 1; 1.2; 1.4; 1.6 and 0.2 mm. They were 0.47 to 1.5 mm thick. The calibers of the bore of these stones was from 0.08 to 0.65 mm. The stones, required for the watchmaking industry, were mostly intended for export to the USA and Switzerland. The monthly production of the 5th section, [REDACTED] was [REDACTED] about 750,000 stones monthly. The total production of the plant was about 3 million stones. [REDACTED] a sister plant was located in Leningrad and called L.T.K.L.

9. Current was supplied by the UGLICH power plant.

10. No railroad connection. Shipping was done by trucks.

25X1A

[REDACTED] Comment:

The present report partially confirms a former report, in which the dismantling of the BAKLIN Quartz Melting Plant and its transfer to Leningrad were reported as well as the supply of quartz crucibles from the re-erected plant for the manufacture of synthetic precious stones to BIRELITIN.

The report shows that the demand for stones for the instrument-making industry can only be met by imports, especially from the Soviet zone. This will also account for the purchases of precious stones in Switzerland and the Netherlands, which will be made possible by exporting stones shaped for use by the watchmaking industry.

SECRET [REDACTED]

25X1A

COUNTRY

Soviet Union

REPORT NO.

ILLEGIB

TOPIC

Machine Factory in Uzlovaya

25X1A

25X1A

EVALUATION

25X1A

PLACE OBTAINED

DATE OF CONTENT

25X1C

DATE OBTAINED

DATE PREPARED

7 March 1950

REFERENCES

25X1C

PAGES

2

ENCLOSURES (NO. & TYPE)

2 Blueprints

REMARKS

25X1X

1. Location:

The Ussmu Plant for mining machinery is in the south-east part of Uzlovaya (38°09'E/53°58'N), Moscow Oblast, about 450 meters southeast of the Tula-Stalinogorsk road, about 0,6 km south of the railroad station.

2. Plant installation:

The plant covered an area of about 450 x 600 meters. The construction, started in 1947, was, by September 1949, not completed for most of the installations. The large workshops are iron structures with concrete lining. The smaller buildings were brick structures, some of them plastered. Electric current came via an open-air power transmission line from the direction of Stalinogorsk. Railroad connection was available.

For location see Annex 1.

For plant layout see Annex 2.

3. Work force :

Several hundred PWs doing construction work. No details were available on the number of laborers in the production.

CLASSIFICATION

SECRET

25X1A

SECRET [REDACTED]

25X1A

2

Work was done in three 8-hour shifts.

4. Production :

Production started in the Summer of 1945. Elevator towers, conveyor belts, shaking chutes and other unidentified machines.

25X1A

[REDACTED] Comment :

The Uzlovaya Plant for mining equipment has been unknown before. [REDACTED]

25X1A

- 2 Annexes :
1. Machine Factory in Uzlovaya
 2. Machine Factory in Uzlovaya.

Legend to Annex 2 (

- 1 Assembly shop, 225 x 108 x 18 meters, iron structure with concrete lining
- 2 Administration, 45 x 18 meters, four-story plastered brick building
- 3 Fire department, 27x 18 meters, bare brick structure with tower
- 4 Entrance and two small guard houses
- 5 Stalin monument
- 6 Boiler house, 54 x 36 x 10,5 meters, bare brick structure, with smokestack, 30 meters high
- 7 Workshop under construction, 225 x 108 meters, iron structure with concrete lining, called workshop No.4
- 8 Workshop No. 5 under construction, 360 x 90 meters, iron structure with concrete lining
- 9 Construction office, 36 x 22,5 meters, three-story plastered brick building
- 10 Foundry under construction, 225 x 108 meters, iron structure with concrete lining, which so far only contained three concreted pits, 2,7 meters deep, together as long as the hall
- 11 Workshop No. 2 under construction, 225 x 108 meters, iron structure with concrete lining
- 12 Annex to assembly shop under construction, 72 x 27 meters, iron structure with concrete lining.

SECRET [REDACTED]

25X1A

Machine Factory in UZLOVAYA

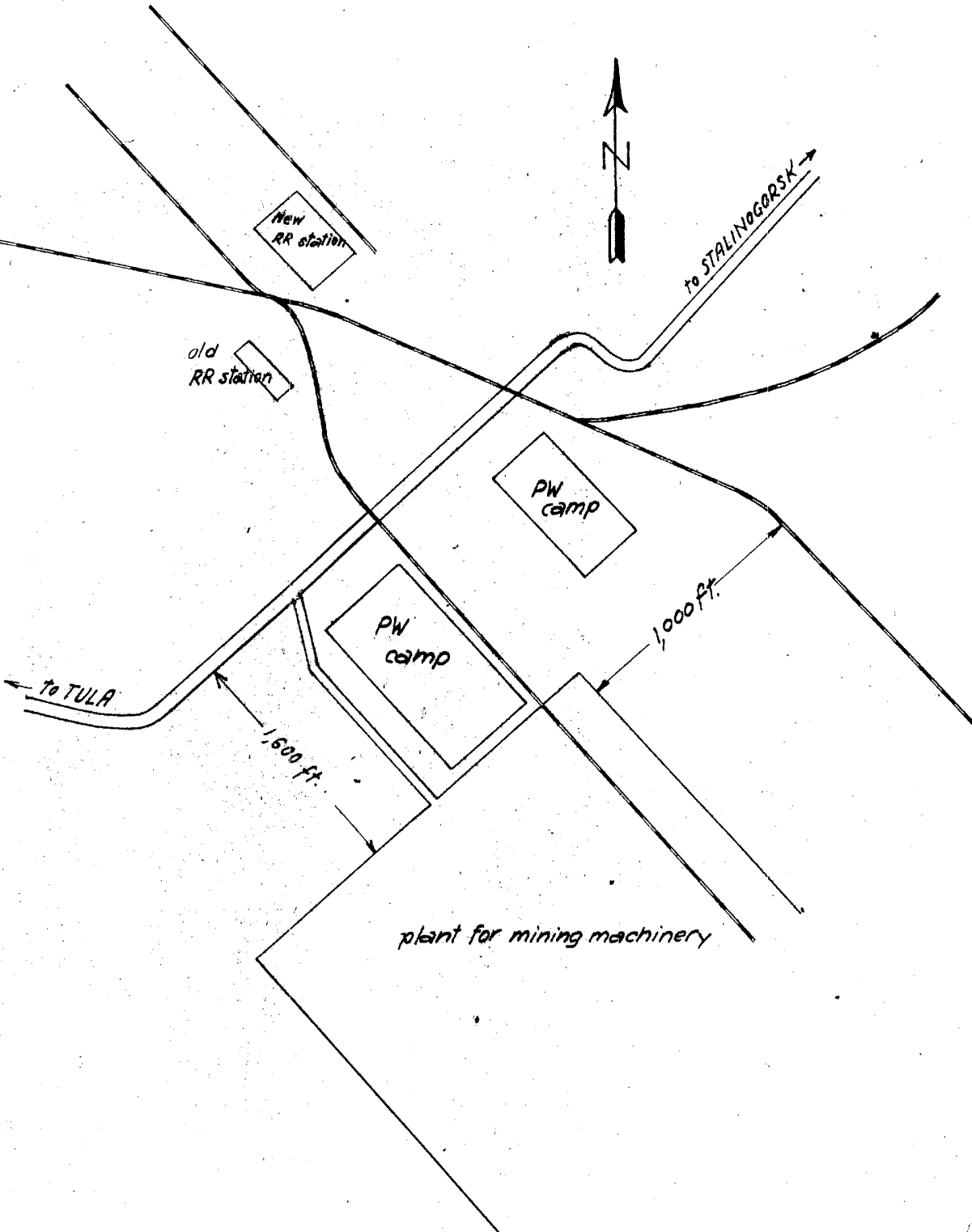

not to scale



ILLEGIB

Machine Factory in UZLOVAYA

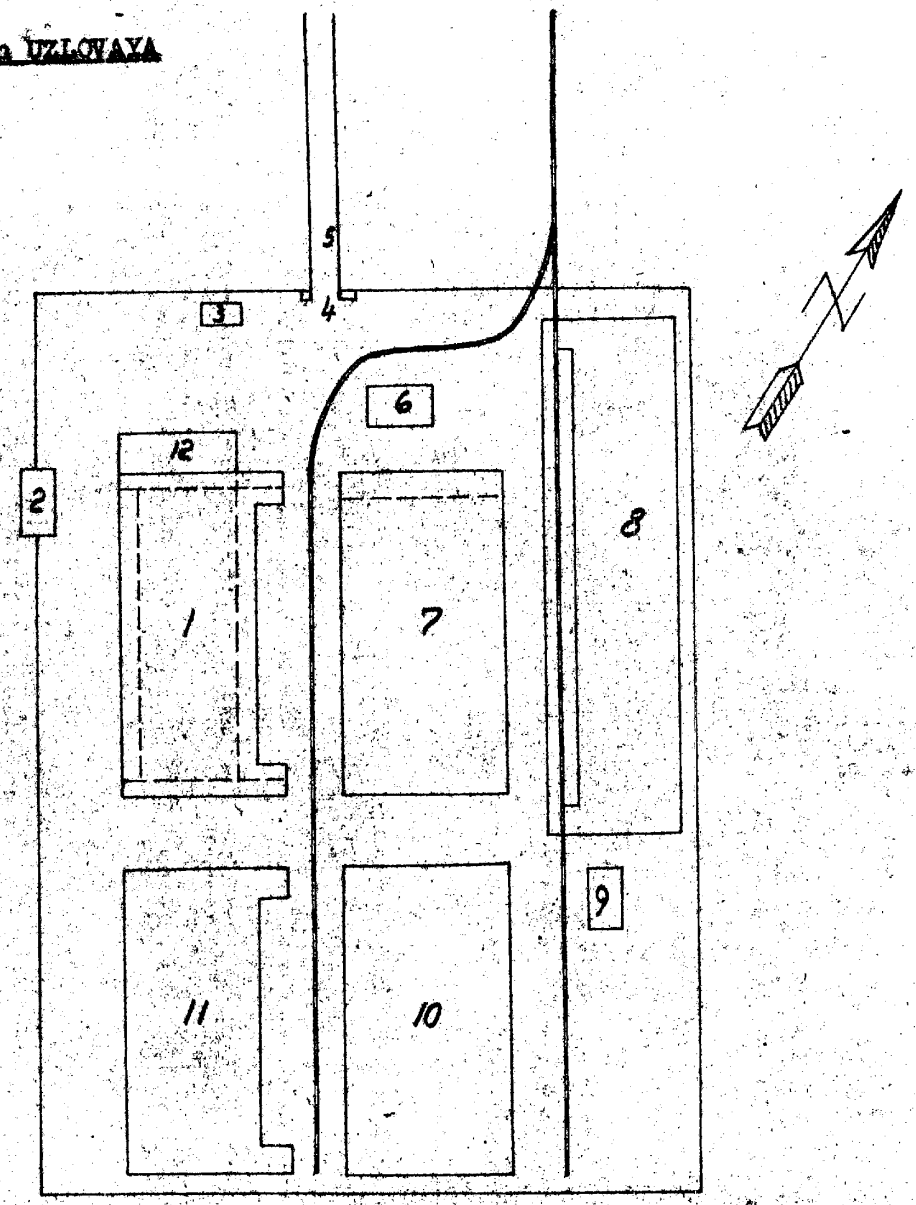

Legends: See report

not to scale

CONFIDENTIAL

ILLEGIB

CLASSIFICATION	[REDACTED]	25X1A	25X1A
COUNTRY	Soviet Union	REPORT NO.	
TOPIC	Machine Tools Plant in KOLOMNA		
EVALUATION	[REDACTED] 25X1A	PLACE OBTAINED	[REDACTED]
DATE OF CONTENT	[REDACTED]	25X1C	
DATE OBTAINED	[REDACTED]	DATE PREPARED	17 November 1949
REFERENCES	25X1C		
PAGES	5	ENCLOSURES (NO. & TYPE)	1 Blueprint
REMARKS			

[REDACTED] 25X1X

1. Location

The plant, designated Savod Terek No. 7 [REDACTED] is located about 1.8 miles south of the town center of KOLOMNA (38°45'E/35°05'N), Moscow Oblast, on the northern bank of the Oka River (see Annex).

25X1A

2. Plant Layout

The old plant area is 2,000 feet square. During the war, the machinery was transferred to the Ural Mountains and was not returned. The former machinery was replaced by thousands of machines dismantled in the Soviet Zone of Germany, some of which are still stored in boxes in the plant area.

PWs were employed for the construction of settlement houses in March 1948. Two months later they had to do excavation work in connection with the expansion of the plant. The new buildings extend westward over 3/5 miles. According to Soviets, the eventual expansion in this direction is to be 5 miles. The fabrication shops to be erected there were reportedly dismantled at the western German "Schless and de Vries" Firm.

Production in the eastern plant section started in 1948. The plant has a spur track (see Annex).

3. Work Force

About 4,000 workers working in three shifts in addition to about 1,400 PWs and some Soviet foremen employed for construction work.

4. Production

Machine tools.

CLASSIFICATION

SECRET [REDACTED]

25X1A

SECRET- [REDACTED]

25X1A

25X1A

[REDACTED] Comment:

a. From the data on the location of this previously known plant it is assumed to be the former Voroshilov Gun Factory in KOLONNA, and an aerial photograph taken in 1942 was attached to a former report.

b. The report confirms the westward plant expansion. The mentioned photograph shows that such an expansion is possible.

The designation "Savod Terek No. 7" was mentioned for the first time. The attached sketch is in agreement with available information as to the distribution and purpose of the industrial departments located in the eastern section of the plant. Essentially new details are reported relative to the western plant section.

c. The report confirmed previous information that machine tools are now being produced in the plant.

This assumption is also confirmed by the transfer of workshops of the western German Schiess and de Vries Firm, which manufactured machine tools. According to available information, sections of this firm have been allocated to the Soviets as reparations.

d. The report is considered credible. [REDACTED]

25X1A

Legend to Annex

Section A in operation. Section B, building site.

1. Garage
2. Emergency generator
3. Entrance and administration building
4. Transformer station
5. Boiler house, 150x90 feet, with wing, 5 boilers
6. Forge, 300x90 feet
7. Construction bureau and technical department in charge of waterpipes and heating installations, 300x90 feet, steel and slug stone structure
8. Four-story building, 300x90 feet. Electric motor repair shop
9. Foundry and moulding shop with two cupola furnaces set up in the summer of 1948
10. Machine shop and class room called "Tekhnikum" in addition to offices, 360x270 feet
11. Assembly hall and mechanical workshop, 360x300 feet, with
 - a. Metal-working machines and
 - b. Assembly hall
12. Pattern shop and carpentry for packing material
13. Slug stone and concrete stone factory
14. Foundry for large machine parts with three furnaces
15. P' Camp No. 7889
16. Building site, 1,800x360 feet. The steel skeleton frames and the foundations for the girders are completed. The walls were being added and foundations for numerous large machines were under construction. The workshop is to have three large and one small department and is to be about 80 feet high. The roof is to be provided with glass windows.

SECRET- [REDACTED]

25X1A

25X1A

SECRET [REDACTED]

- 17 Two four-story administration buildings, about 200x50 feet, still without roofs. Target date for the completion of the buildings is June 1949
- 18 Workshop similar to item 16 above. The steel frame was being set up. From the observation that moulds were being unloaded there [REDACTED] this shop was perhaps to be a foundry
- 19 Large coal dump, allegedly a two-year supply
- 20 Slag stone and concrete stone factory
- 21 Boiler house
- 22 Locksmith's shop
- 23 Carpentry
- 24 Sawmill
- 25 Materials dump
- 26 Excavation work for a planned boiler house with six boilers.

25X1A

1 Annex: Machine Plant in KOLMONA

SECRET [REDACTED]

25X1A

Approved For Release 2002/08/15 : CIA-RDP83-00415R010900070007-6
Machine Plant in KOLOMNA, Moscow Oblast

