

Declassified in Part - Sanitized Copy Approved for Release 2013/11/27 : CIA-RDP80T00246A073700210001-0

50X1

Page Denied

Next 1 Page(s) In Document Denied

Declassified in Part - Sanitized Copy Approved for Release 2013/11/27 : CIA-RDP80T00246A073700210001-0

INFORMATION REPORT INFORMATION REPORT

CENTRAL INTELLIGENCE AGENCY

This material contains information affecting the National Defense of the United States within the meaning of the Espionage Laws, Title 18, U.S.C. Secs. 793 and 794, the transmission or revelation of which in any manner to an unauthorized person is prohibited by law.

S-E-C-R-E-T
NO FOREIGN DISSEM

50X1

COUNTRY	USSR	REPORT	
SUBJECT	Circuit and Wiring Diagrams for the Soviet RP-5 [SCAN ODD] Airborne Intercept Radar	DATE DISTR.	17 August 1964
		NO. PAGES	1
		REFERENCES	
DATE OF INFO.			
PLACE & DATE ACQ.			

THIS IS UNEVALUATED INFORMATION. SOURCE GRADINGS ARE DEFINITIVE. APPRAISAL OF CONTENT IS TENTATIVE.

1. [redacted] two English-language albums of diagrams for the Soviet RP-5 [SCAN ODD] airborne intercept radar [redacted] 50X1-HUM
2. The descriptions of the albums are as follows:
 - a. Attachment I. Radar Station RP-5, Circuit Diagrams. No publishing data available. The album contains 31 schematic diagrams of the various units of the RP-5.
 - b. Attachment II. RP-5 Radar Station, Wiring Diagrams. Published in 1959. This album is made up of 31 wiring diagrams which show connections between units, connections between components of each unit, and points of connection on each component. 50X1-HUM

Distribution of Attachments: (for retention)

OSI:	1 copy
ORR:	1 copy
Army:	2 copies
Army/FSTC:	2 copies
Navy:	1 copy
Navy/STIC:	1 copy
Air:	2 copies
Air/FTD:	5 copies
SAC:	1 copy (previously forwarded)
DIA:	2 copies
NSA:	6 copies

50X1-HUM

GROUP 1
Excluded from automatic
downgrading and
declassification

S-E-C-R-E-T
NO FOREIGN DISSEM

STATE	DIA	ARMY	NAVY	AIR	NSA	/ab/	NIC	OCR	SAC
	Air/FTD		Army/FSTC		Navy/STIC				

(Note: Field distribution indicated by "#".)

INFORMATION REPORT INFORMATION REPORT

50X1-HUM

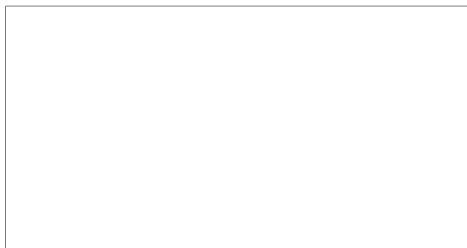

Declassified in Part - Sanitized Copy Approved for Release 2013/11/27 : CIA-RDP80T00246A073700210001-0

50X1-HUM

Page Denied

Next 1 Page(s) In Document Denied

Declassified in Part - Sanitized Copy Approved for Release 2013/11/27 : CIA-RDP80T00246A073700210001-0

SECRET
NO FOREIGN DISSEM

50X1

RADAR STATION RP-5
CIRCUIT DIAGRAMS

(English Language)

SECRET

NO FOREIGN DISSEM

GROUP 1
Excluded from automatic
downgrading and
declassification

S-E-C-R-E-T
NO FOREIGN DISSEM



50X1

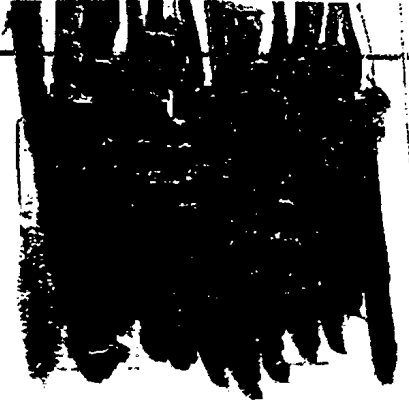

Secret

RADAR STATIC RP-5

CIRCUIT DIAGRAMS

Contains:
Pages 35
Diagrams 201 sheets

S-E-C-R-E-T
NO FOREIGN DISSEM

S-E-C-R-E-T
NO FOREIGN DISSEM

50X1

<u>Index of Drawings</u>			
No.	Name	Drawing No.	Page
1.	Circuit diagram of the measuring aerial unit	AR16-1-0-000	5
2.	Circuit diagram of the transmission-reception unit	AR18-2-0-000	6
3.	Circuit diagram of the reception indicator unit	AR18-3-0-000	7
4.	Circuit diagram of the indicator unit	AR18-4-0-000	8
5.	Circuit diagram of the junction box	AR18-5-0-000	9
6.	Circuit diagram of the distributing box	AR18-6-0-000	10
7.	Circuit diagram of the time base unit	AR18-7-0-000	11
8.	Circuit diagram of the coordinate transformation unit	AR18-8-0-000	12
9.	Circuit diagram of the amplidyne unit	AR18-9-0-000	13
10.	Circuit diagram of the angular tracking unit	AR18-10-0-000	14
11.	Circuit diagram of the range unit	AR18-11-0-000	15
12.	Circuit diagram of the supply and azimuth time base unit	AR18-12-0-000	16

S-E-C-R-E-T

NO FOREIGN DISSEM

S-E-C-R-E-T
NO FOREIGN DISSEM

50X1

Item	Name	Drawing No.	Page
13.	Circuit diagram of the high voltage supply unit	AR18-12a-0-000	17
14.	Circuit diagram of the unit of servo-amplifiers	AR18-14-0-000	18
15.	Circuit diagram of the aerial change over unit	AR18-15-0-000	19
16.	Circuit diagram of the tracking aerial unit	AR28-16-0-000	20
17.	Circuit diagram of the control panel	AR18-19-0-000	21
18.	Circuit diagram of the artificial horizon unit	AR18-21-0-000	22
19.	Circuit diagram of the junction box	AR18-22-0-000	23
20.	Circuit diagram of the unit of protection against asynchronous pulse disturbances	AR18-25-0-000	24
21.	Circuit diagram of the unit of automatic independent warning of air to air collision	AR18-26-0-000	25
22.	Circuit diagram of the unit "Night - Day"	AR18-24-0-000	26
23.	Circuit diagram of the assembly No.9	AR18-17-7-000	27
24.	Circuit diagram of the filter box	AR18-17-9-000	28
25.	Circuit diagram of the assembly No.12	AR18-17-12-000	29
26.	Circuit diagram of the assembly No.13	AR18-17-13-000	30

- 3 -

S-E-C-R-E-T

NO FOREIGN DISSEM

S-E-C-R-E-T
NO FOREIGN DISSEM

50X1

Item	Name	Drawing No.	Page
27.	Circuit diagram of the junction box	AR18-17-15-000	31
28.	Circuit diagram of the T box	AR18-17-16-000	32
29.	Circuit diagram of the junction box	AR18-17-17-000	33
30.	Circuit diagram of the assembly No. 6	AR18-17 and 22-000	34
31.	Circuit diagram of the junction box	AR18-17 and 23	35

S-E-C-R-E-T
NO FOREIGN DISSEM

S-E-C-R-E-T
NO FOREIGN DISSEM

50X1

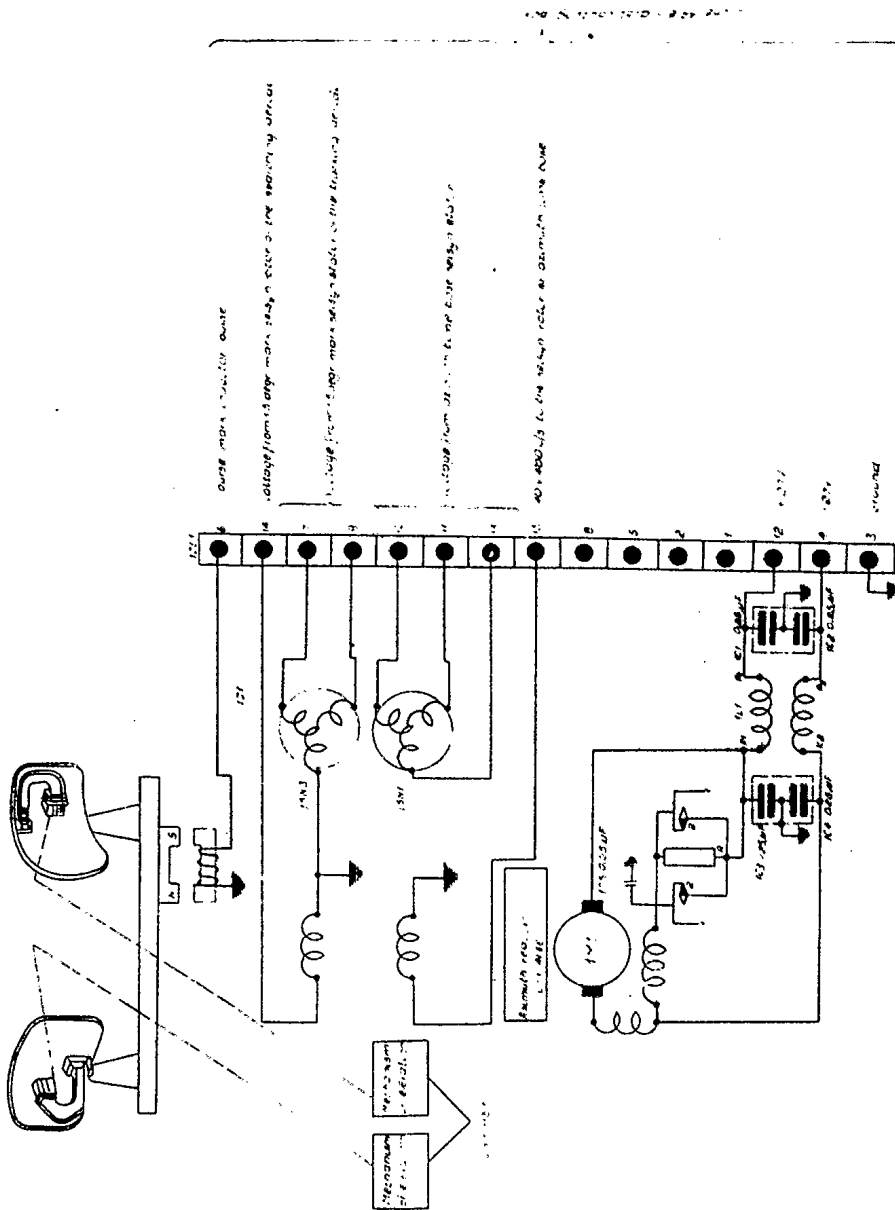

S-E-C-R-E-T

NO FOREIGN DISSEM

S-E-C-R-E-T
NO FOREIGN DISSEM

50X1

Circuit diagram of the
transmission-reception
unit

AR18-2-0-000

S-E-C-R-E-T
NO FOREIGN DISSEM

6

S-E-C-R-E-T
NO FOREIGN DISSEM

50X1

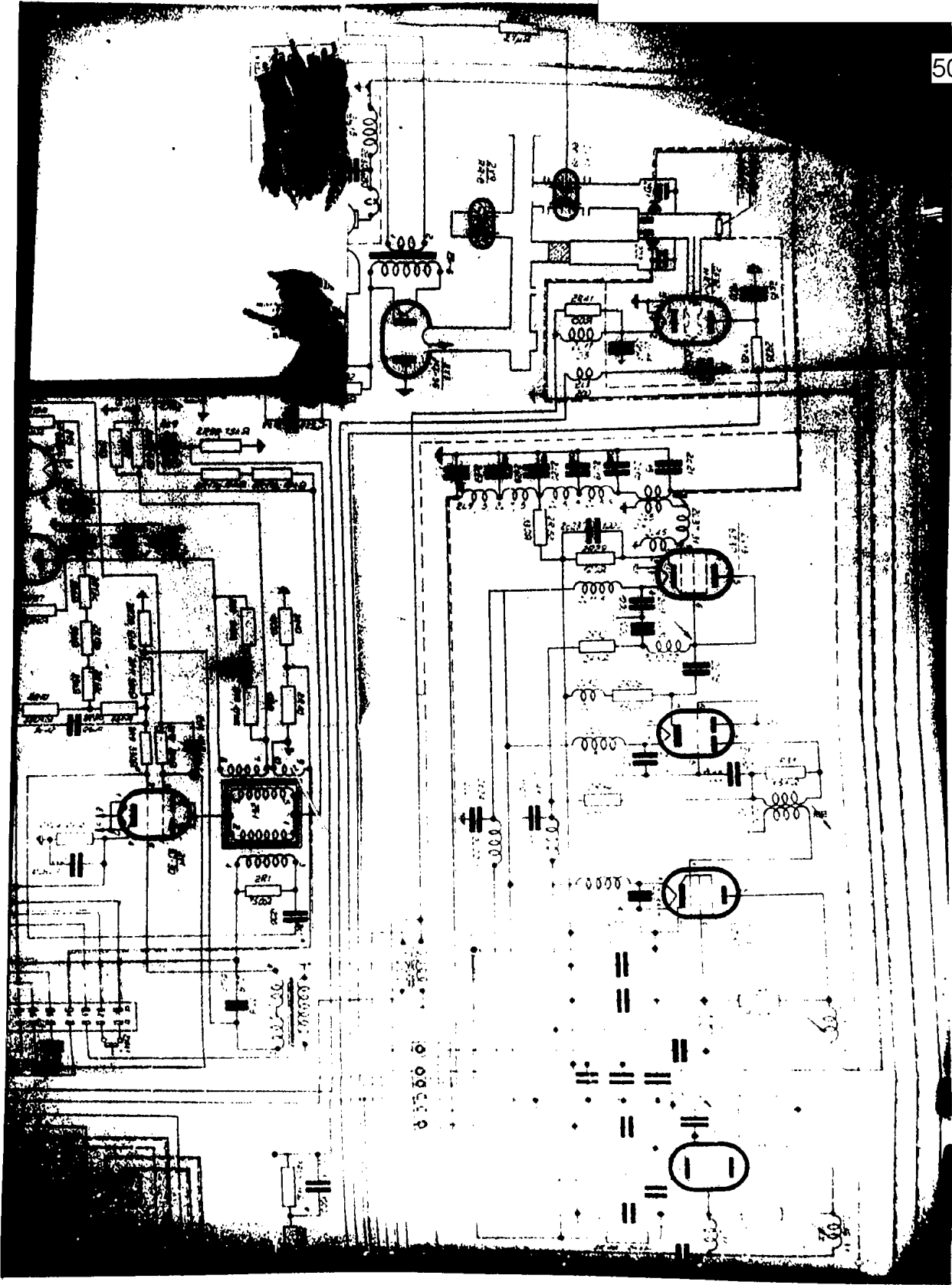

S-E-C-R-E-T
NO FOREIGN DISSFM

S-E-C-R-E-T
NO FOREIGN DISSEM

50X1

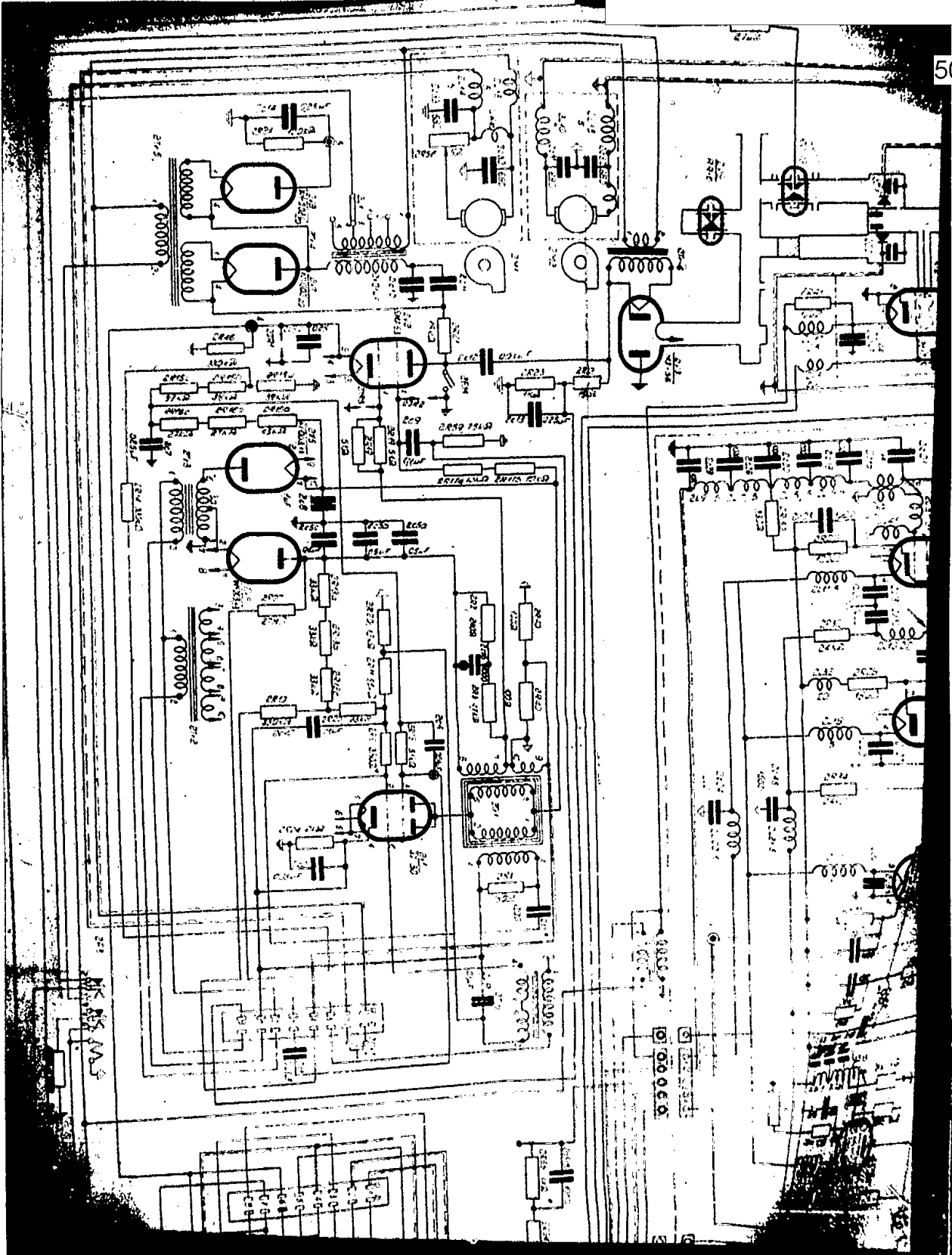

S-E-C-R-E-T
NO FOREIGN DISSEM

S-E-C-R-E-T
NO FOREIGN DISSEM

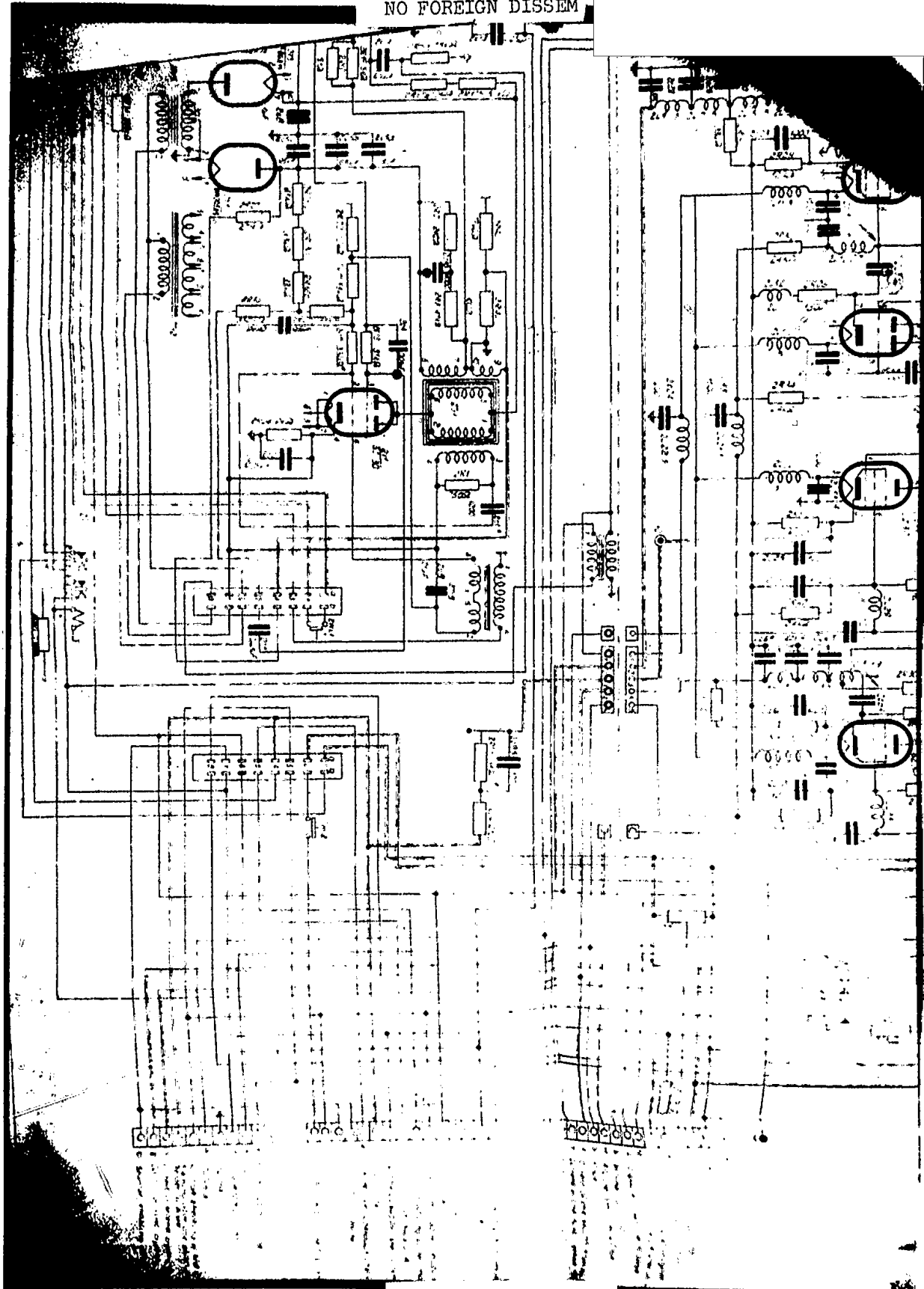

S-E-C-R-E-T

NO FOREIGN DISSEM

S-E-C-R-E-T
NO FOREIGN DISSEM

50X1

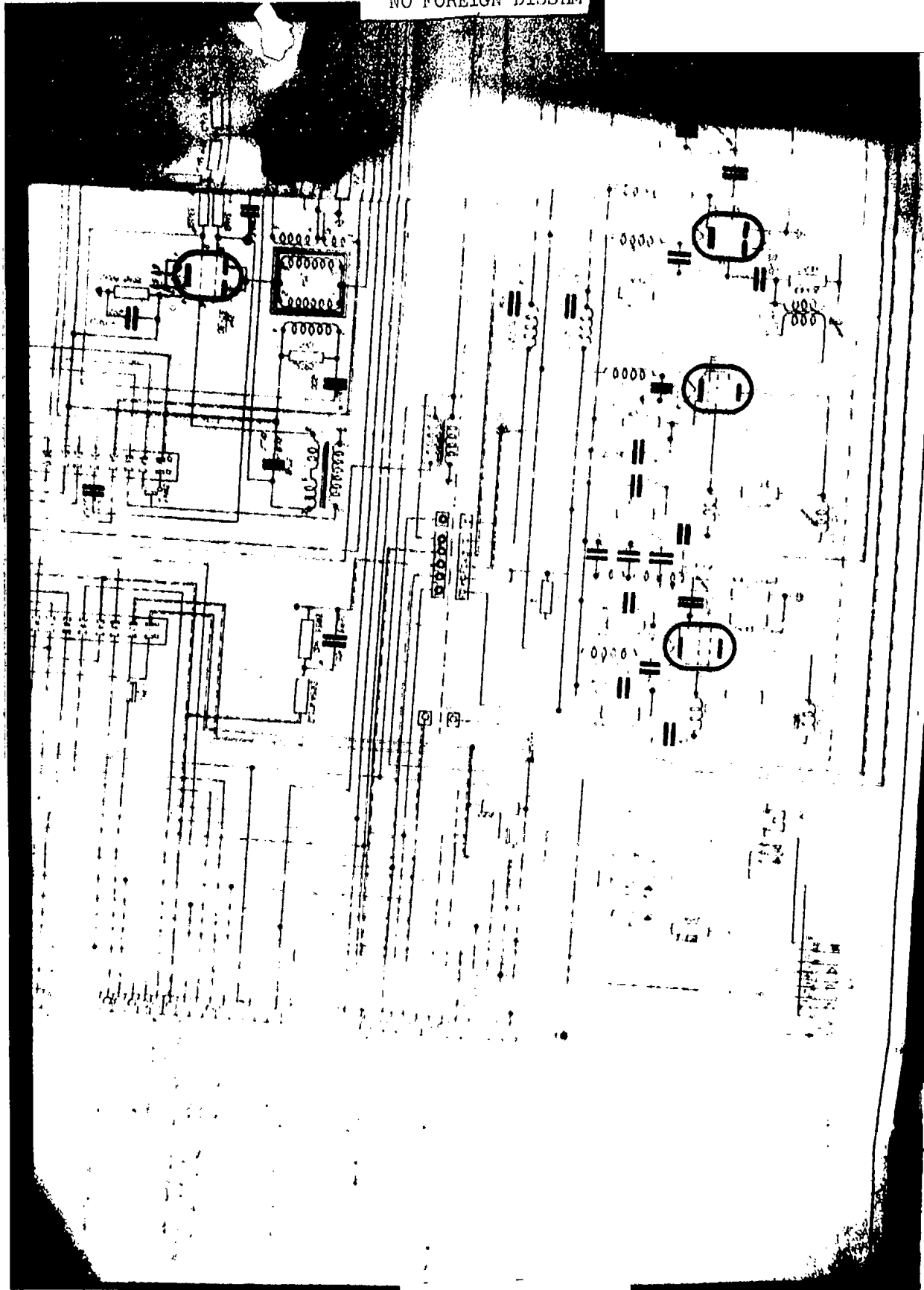

S-E-C-R-E-T
NO FOREIGN DISSEM

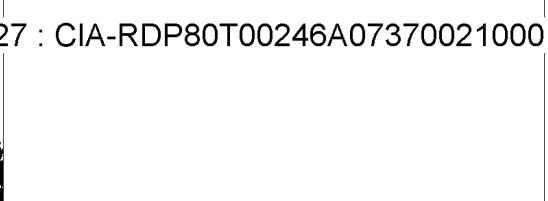

50X1

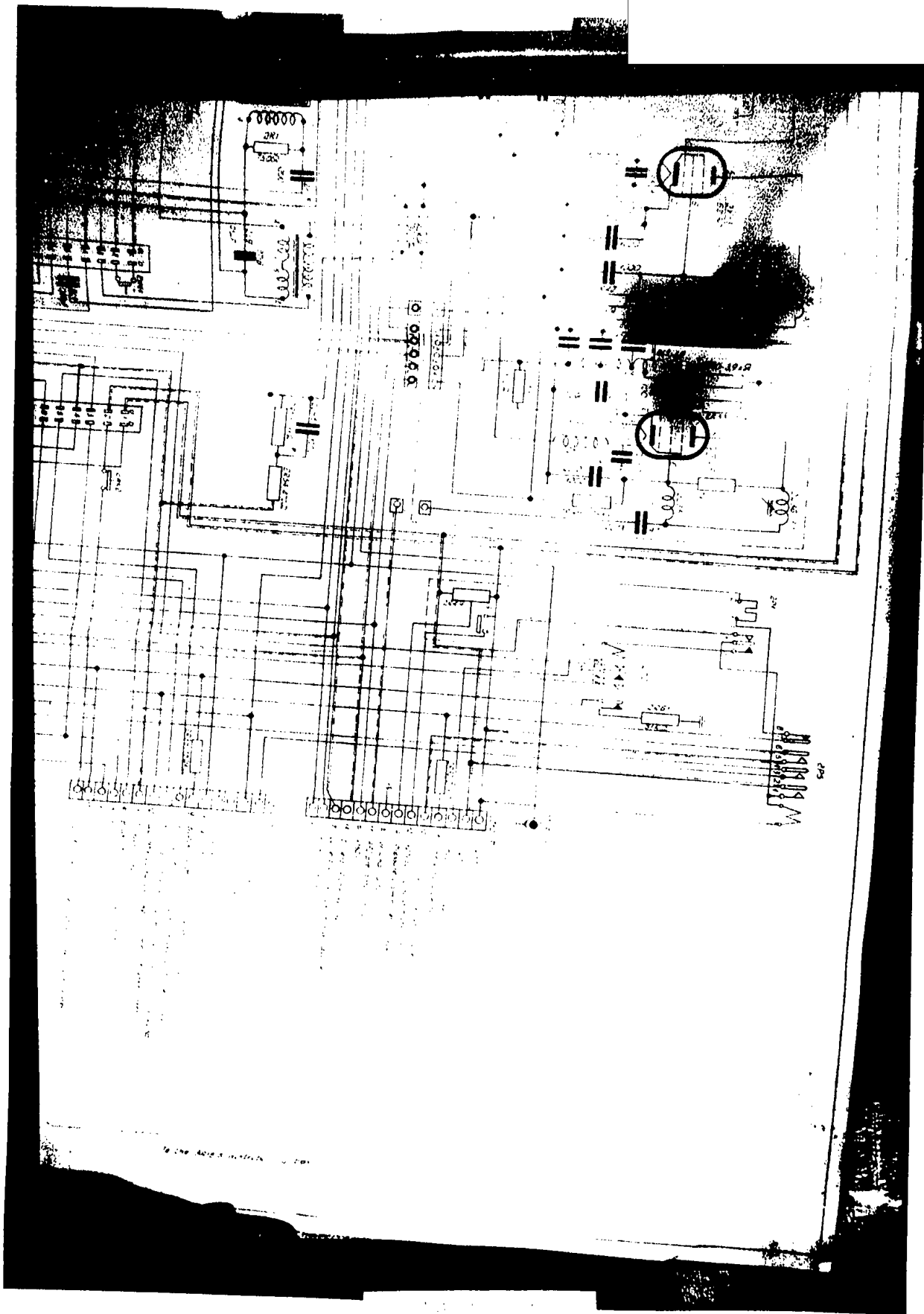

S-E-C-R-E-T
NO FOREIGN DISSEM

50X1

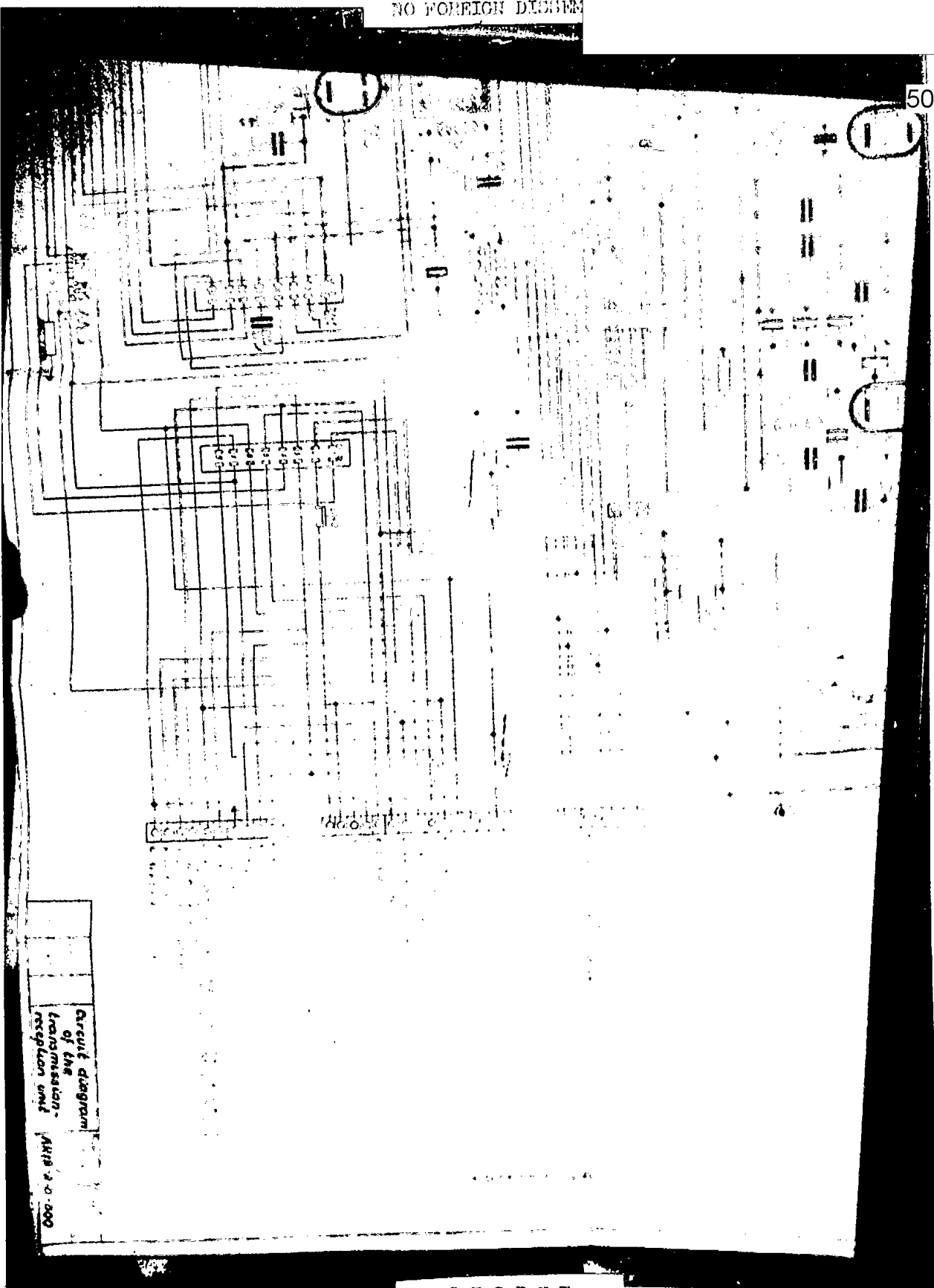

000.0.0.000
 Circuit diagram
 of the
 transmission
 reception unit

S-E-C-R-E-T
NO FOREIGN DISSEM

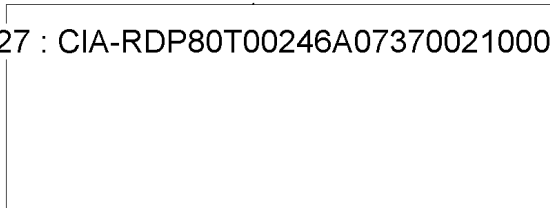

S-E-C-R-E-T
NO FOREIGN DISSEM

50X1

	<i>of the reception indicating unit</i>	<i>Drawing NO AR18-3-0-000</i>
--	---	------------------------------------

S-E-C-R-E-T
NO FOREIGN DISSEM

S-E-C-R-E-T
NO FOREIGN DISSEM

50X1

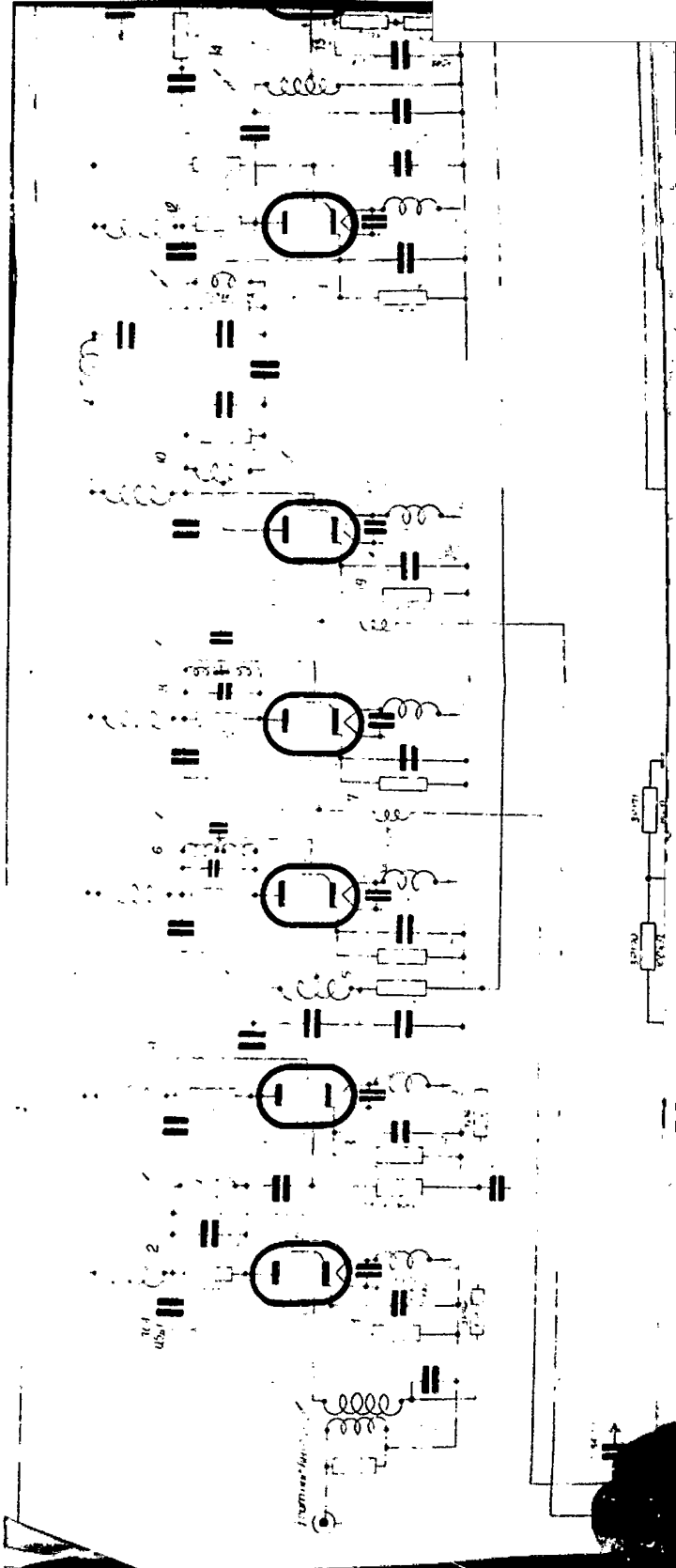

S-E-C-R-E-T

NO FOREIGN DISSEM

S-E-C-R-E-T
NO FOREIGN DISSEM

50X1

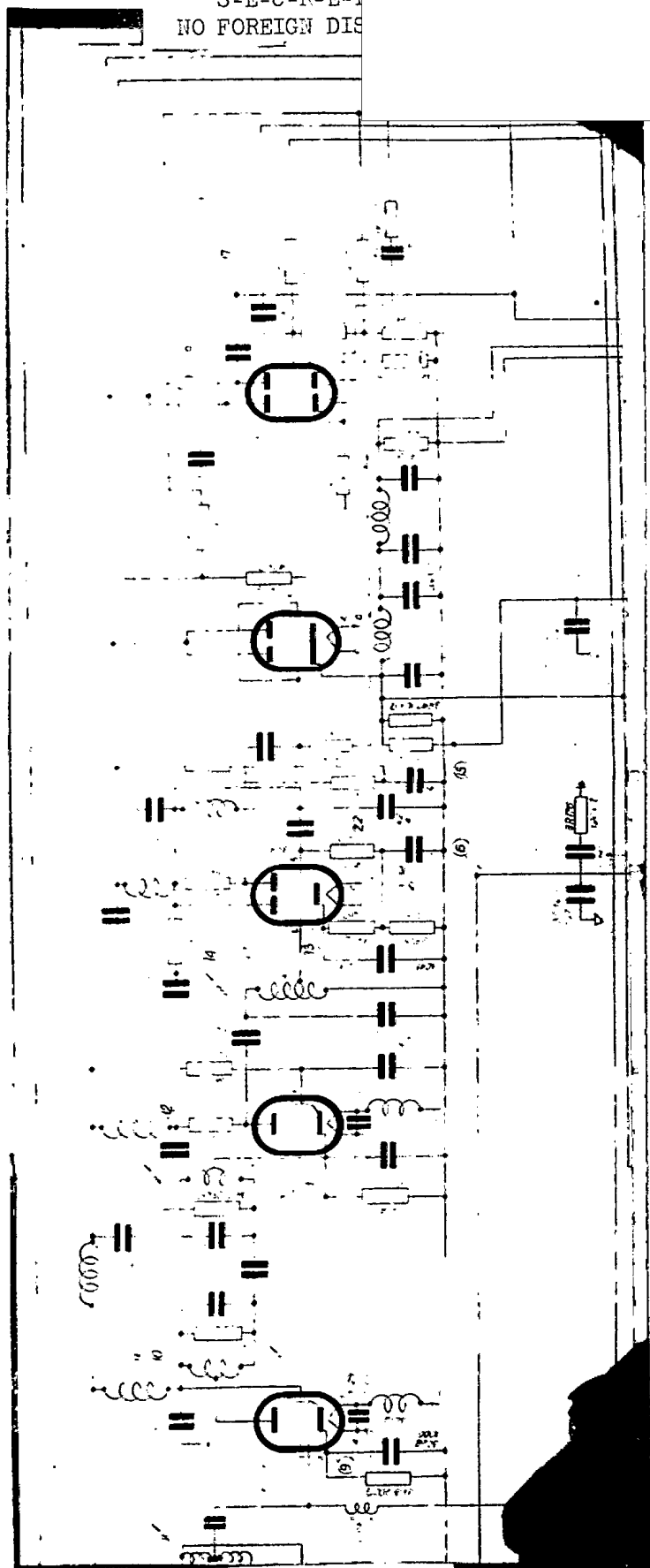

S-E-C-R-E-T

NO FOREIGN DISSEM

S-E-C-R-E-T
NO FOREIGN DISS

50X1

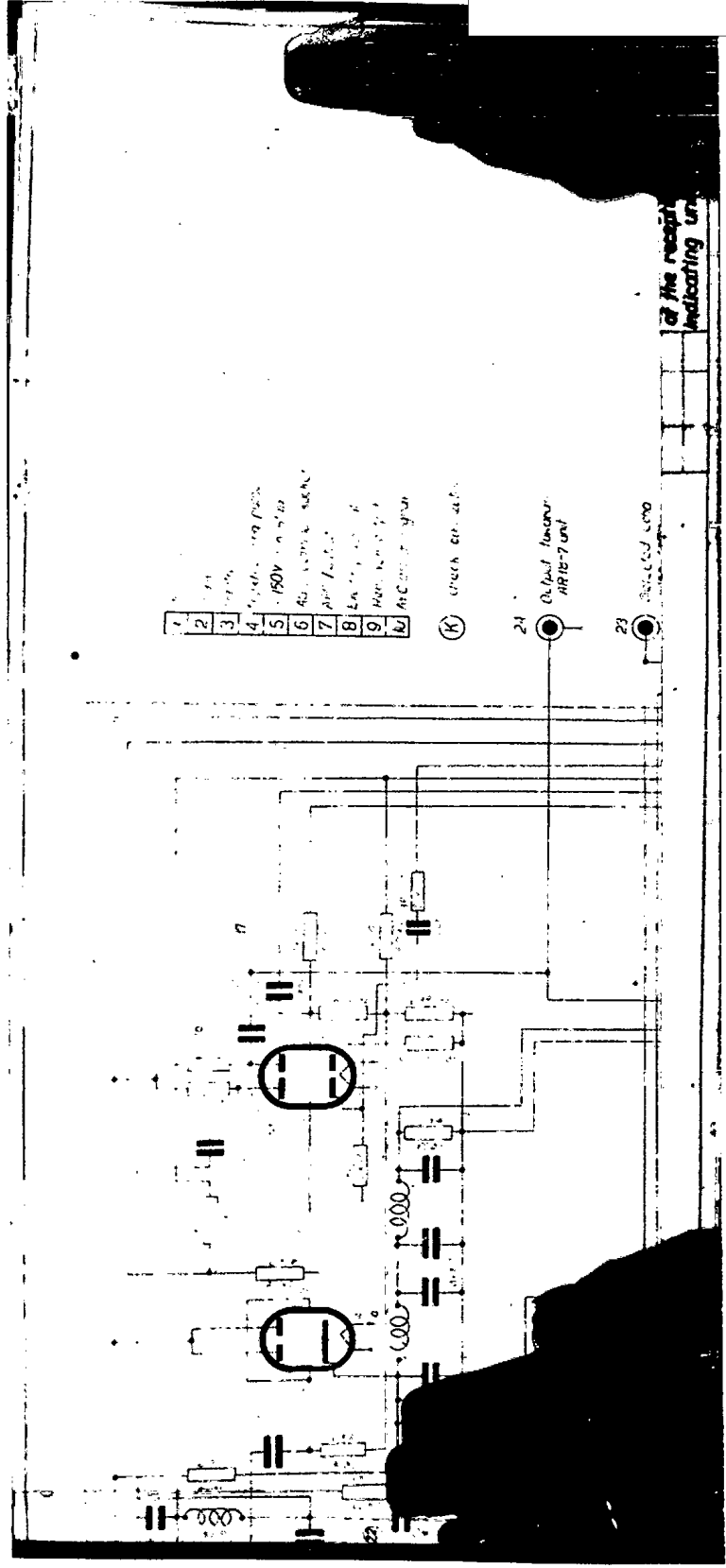

S-E-C-R-E-T
NO FOREIGN DISSEM

S-E-C-R-E-T
NO FOREIGN DISSE

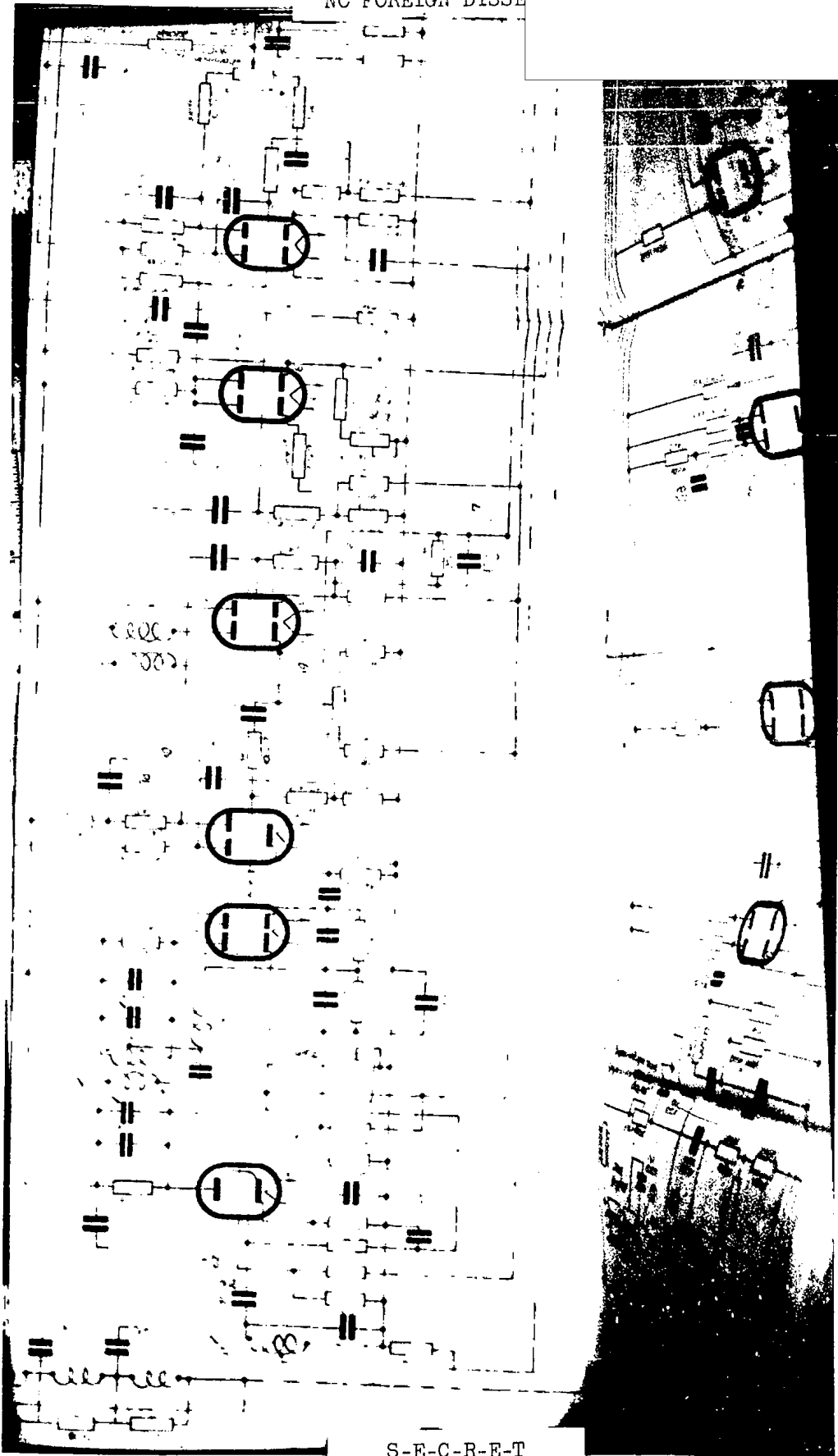

50X1

S-E-C-R-E-T

NO FOREIGN DISSEM

SECRET
NO FOREIGN DISSEM

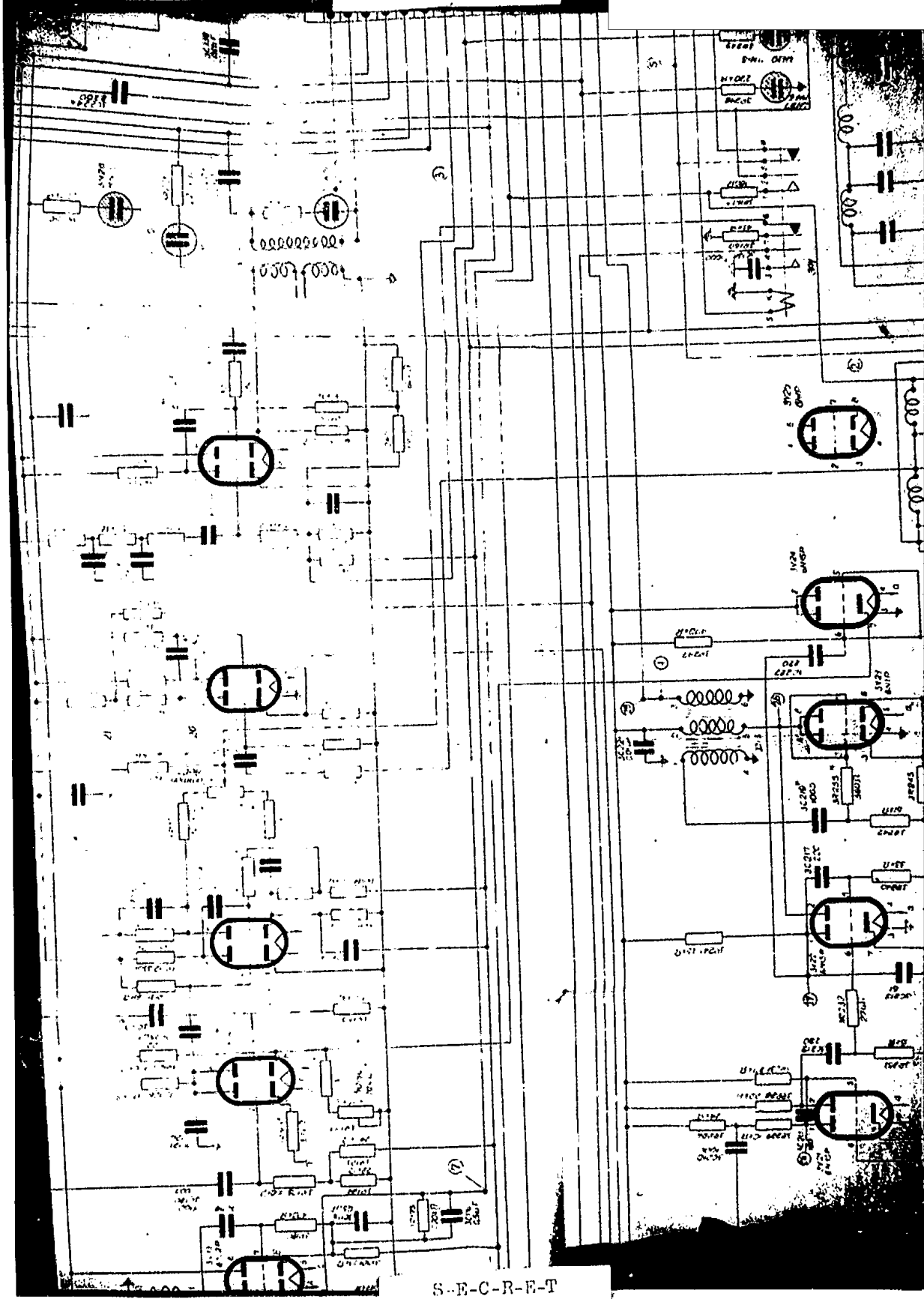

50X1

SECRET

NO FOREIGN DISSEM

S-E-C-R-E-T
NO FOREIGN DISSEM

50X1

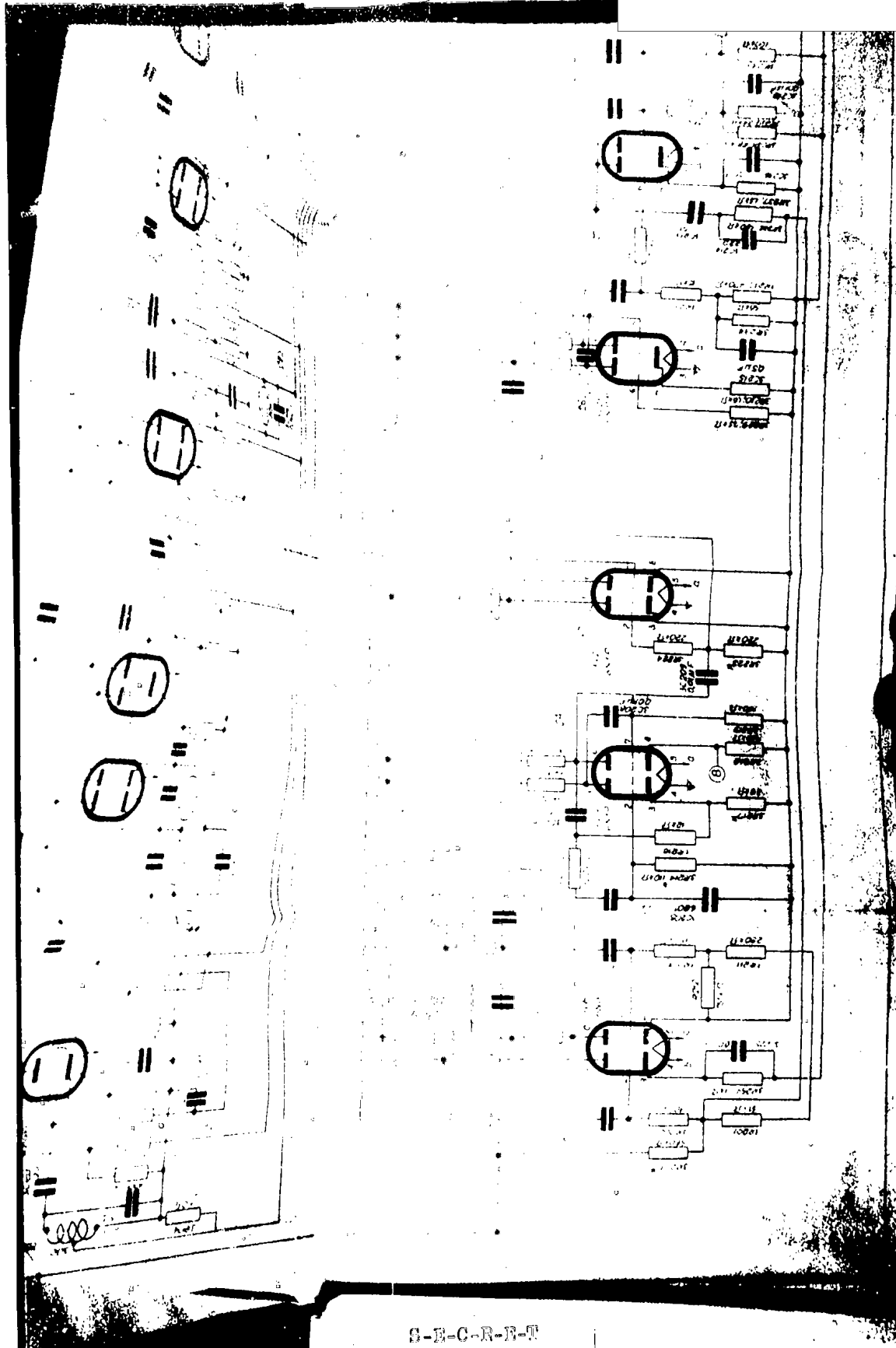

S-E-C-R-E-T
NO FOREIGN DISSEM

S-E-C-R-E-T
NO FOREIGN DISSEM

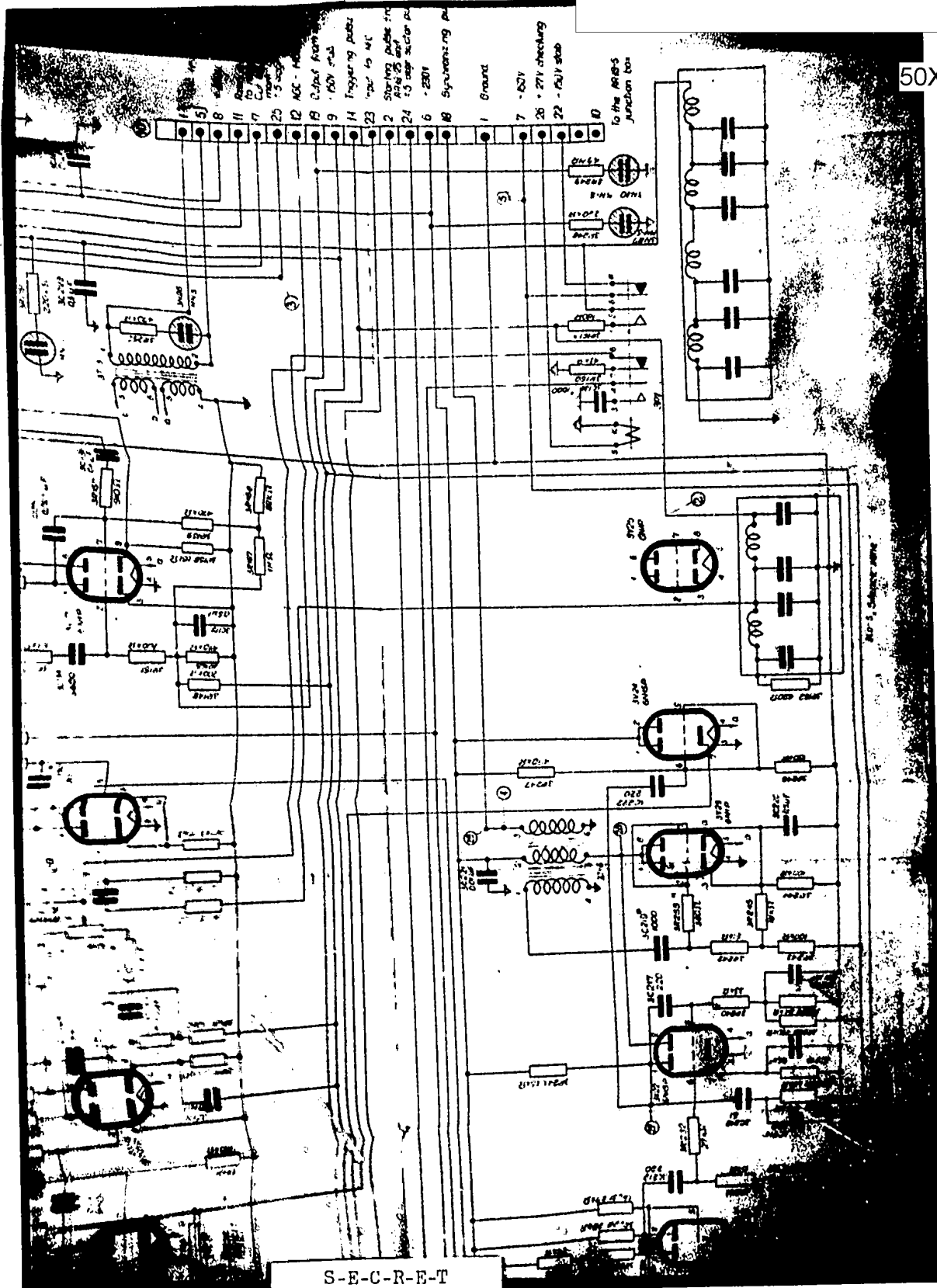
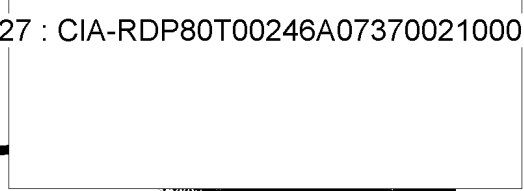

50X1

S-E-C-R-E-T
NO FOREIGN DISSEM

S-E-C-R-E-T
NO FOREIGN DISSEM

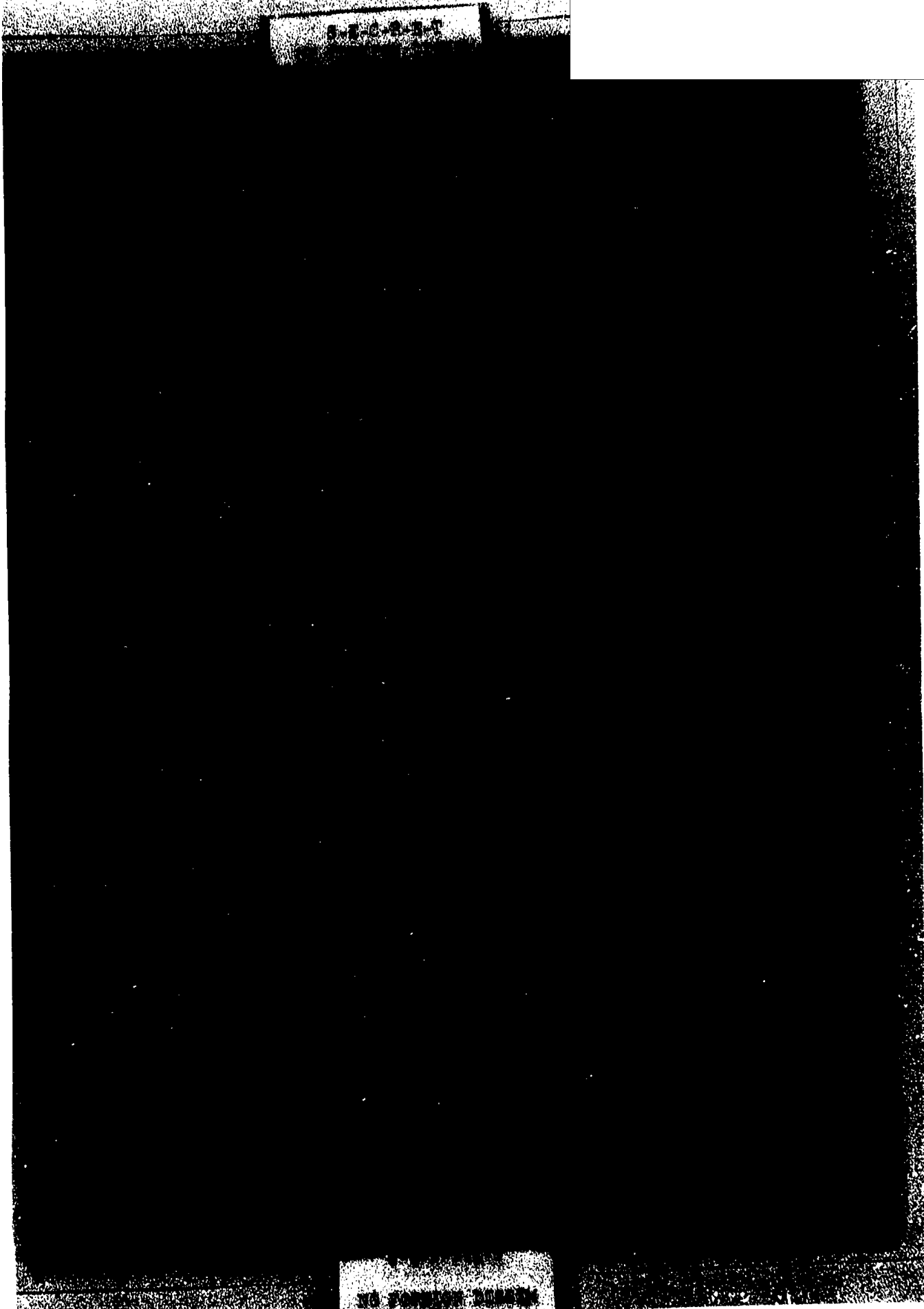
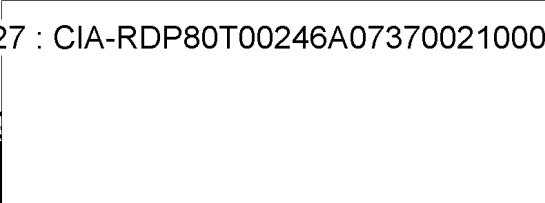

50X1



SECRET

50X1

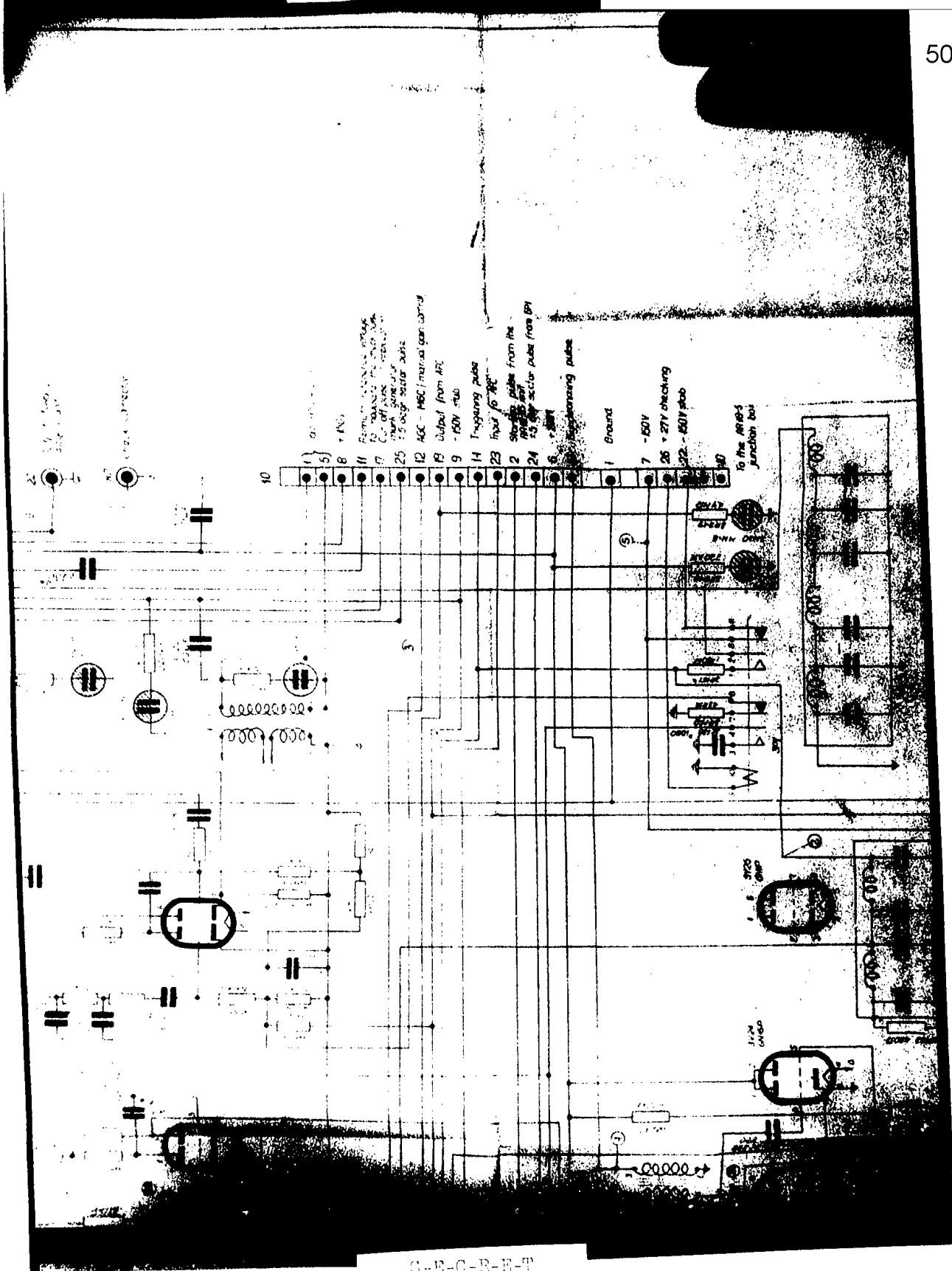

G-E-C-R-E-T

77 POSITION DRAWING

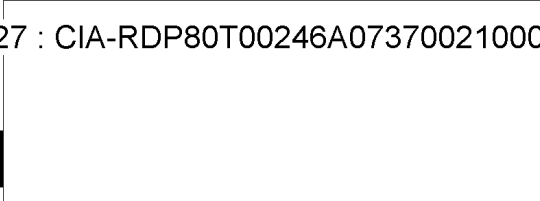

50X1

Page	1
Sheet	1
Drawing No.	ARH-30-006
Circuit diagram of the reception indicating unit	

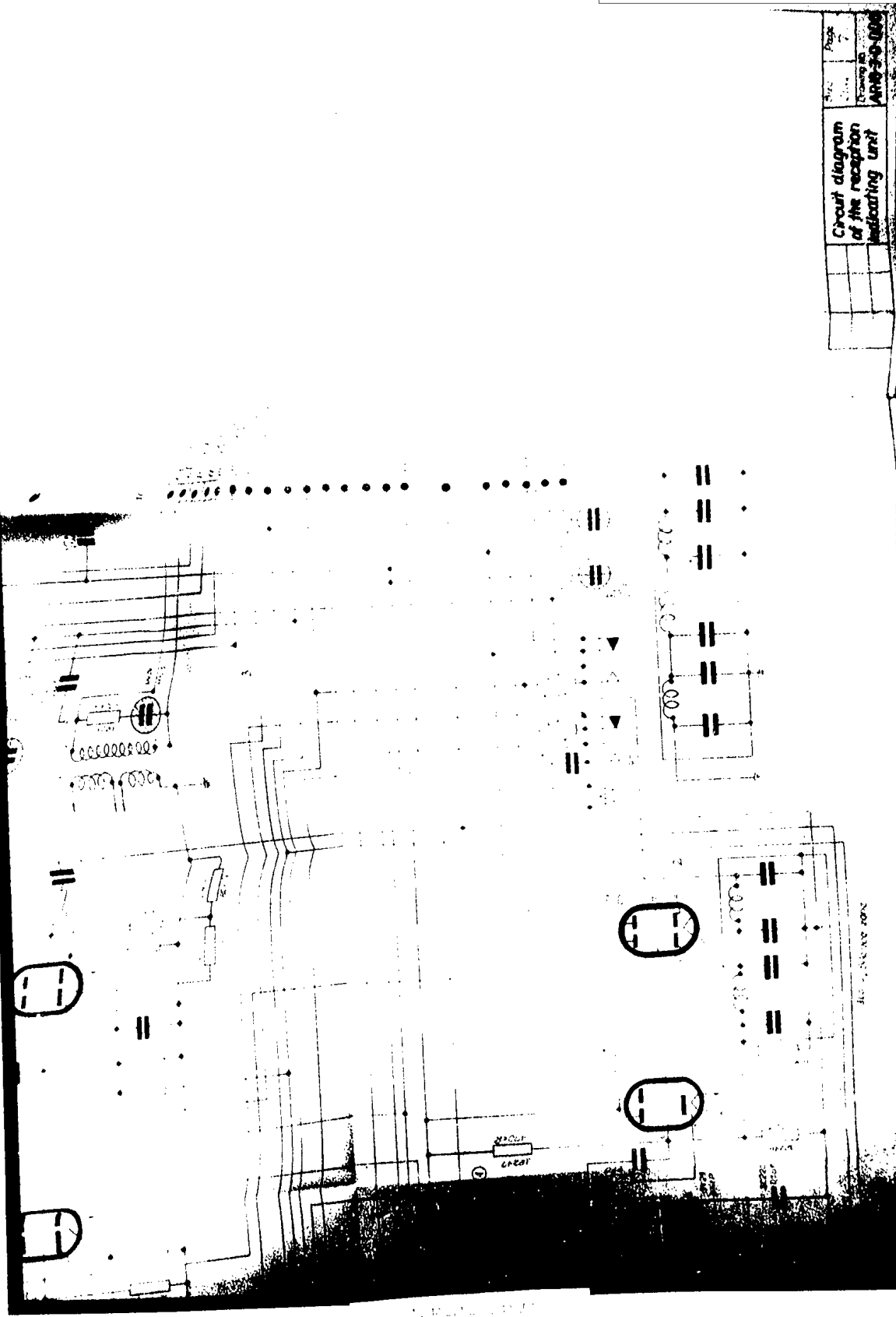

S-E-C-R-E-T
NO FOREIGN DISSEM



50X1

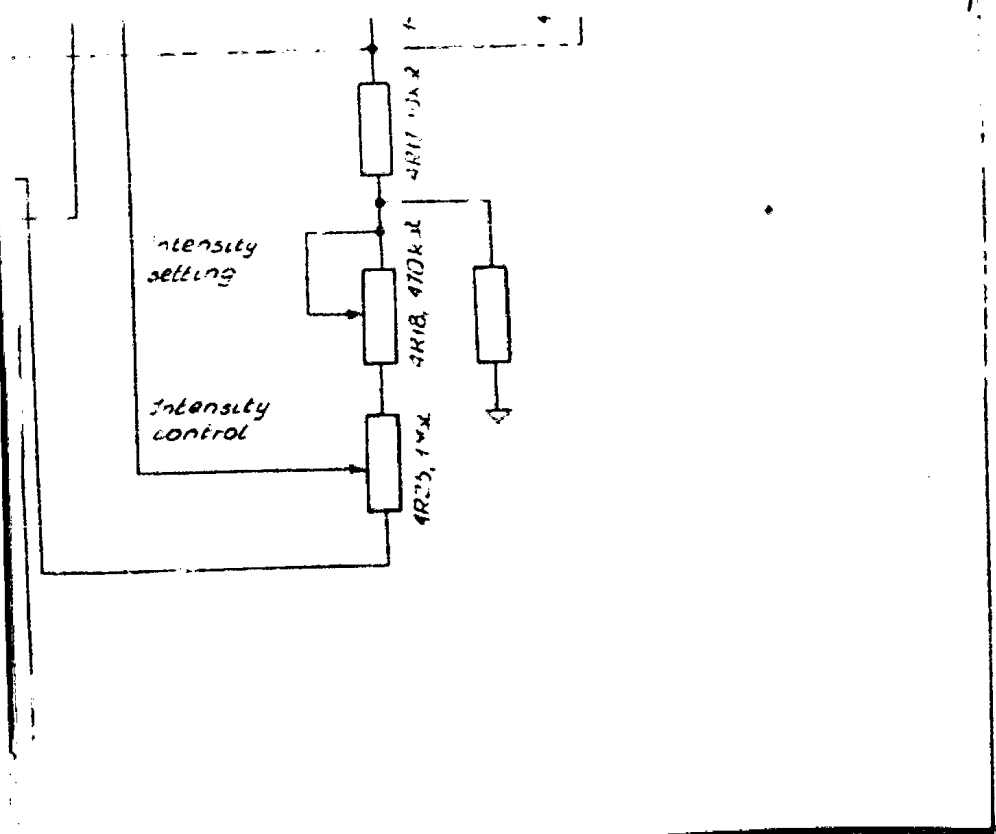

	<i>Circuit diagram of the No 4 unit</i>		Sheet 449	Page 8
			Drawing No AR18-4-0-000sch	

S-E-C-R-E-T

NO FOREIGN DISSEM

S-E-C-R-E-T
NO FOREIGN DISSEM

50X1

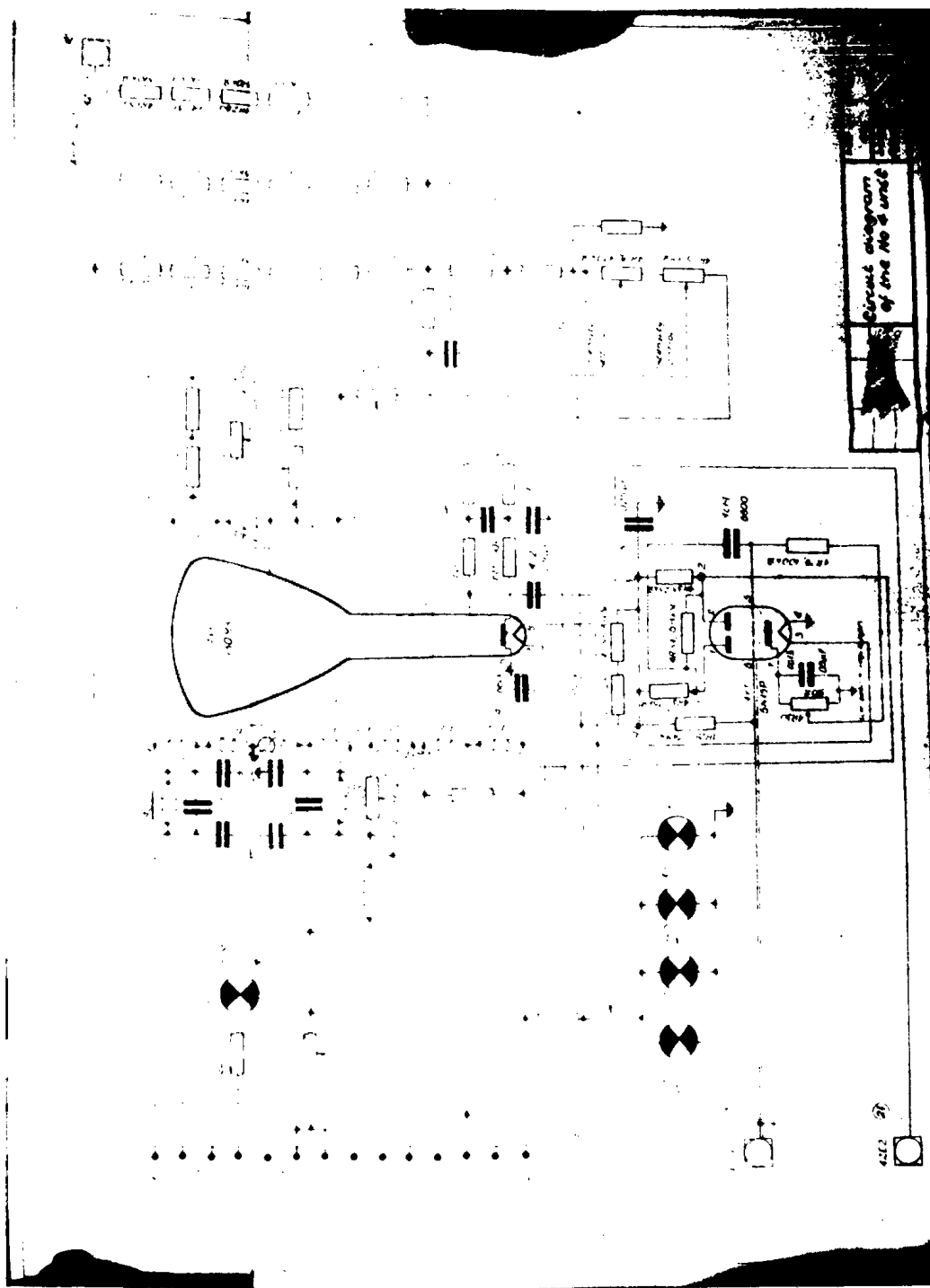

27

S-E-C-R-E-T
NO FOREIGN DISSEM



S-E-C-R-E-T
NO FOREIGN DISSEM

50X1

AR18-5 Junction Box

AR18-5-0-000/sch

S-E-C-R-E-T
NO FOREIGN DISSEM

S-E-C-R-E-T
NO FOREIGN DISSEM



50X1

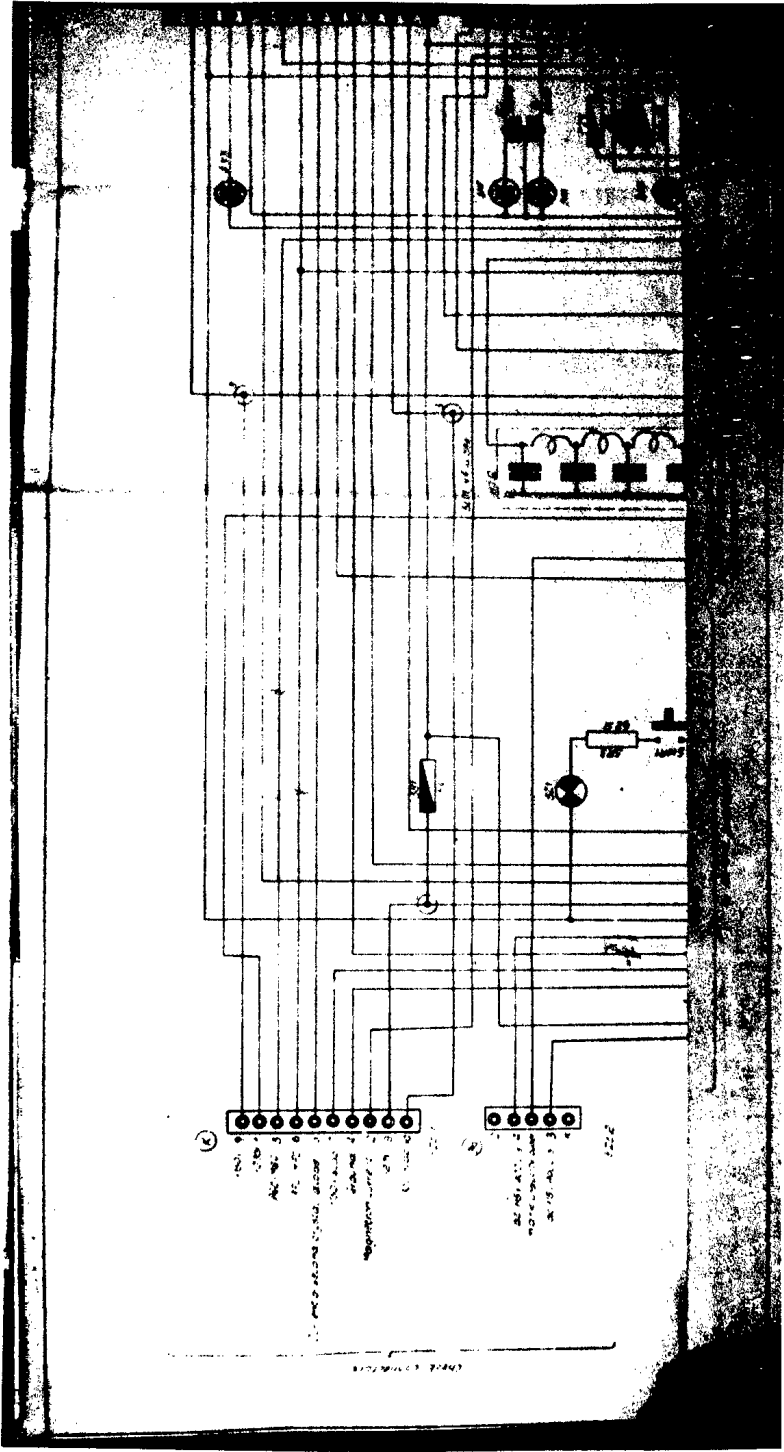

26

S-E-C-R-E-T
NO FOREIGN DISSEM

S-E-C-R-E-T
NO FOREIGN DISSEM



50X1

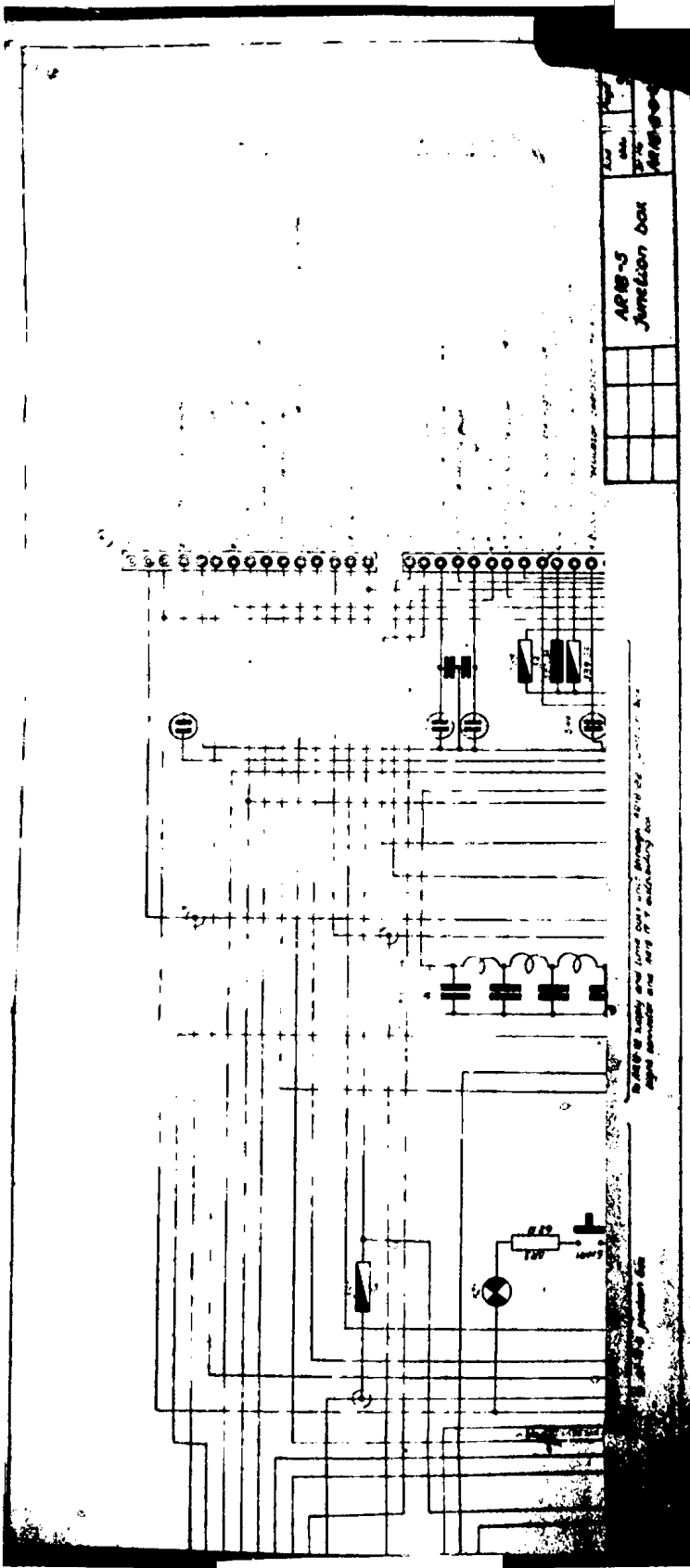

S-E-C-R-E-T
NO FOREIGN DISSEM

S-E-C-R-E-T
NO FOREIGN DISSEM

50X1

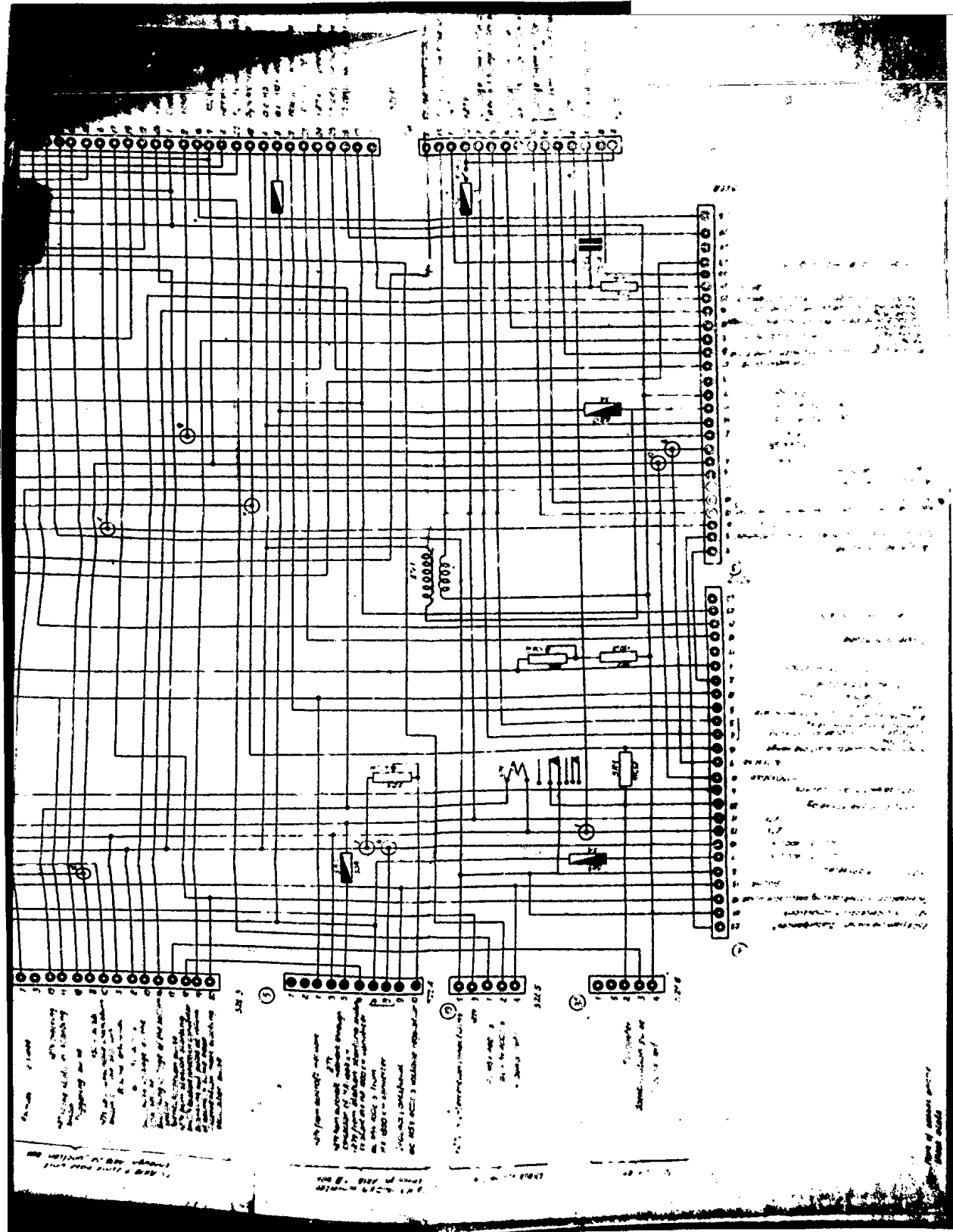

S-E-C-R-E-T
NO FOREIGN DISSEM

S-E-C-R-E-T
NO FOREIGN DISSEM

50X1

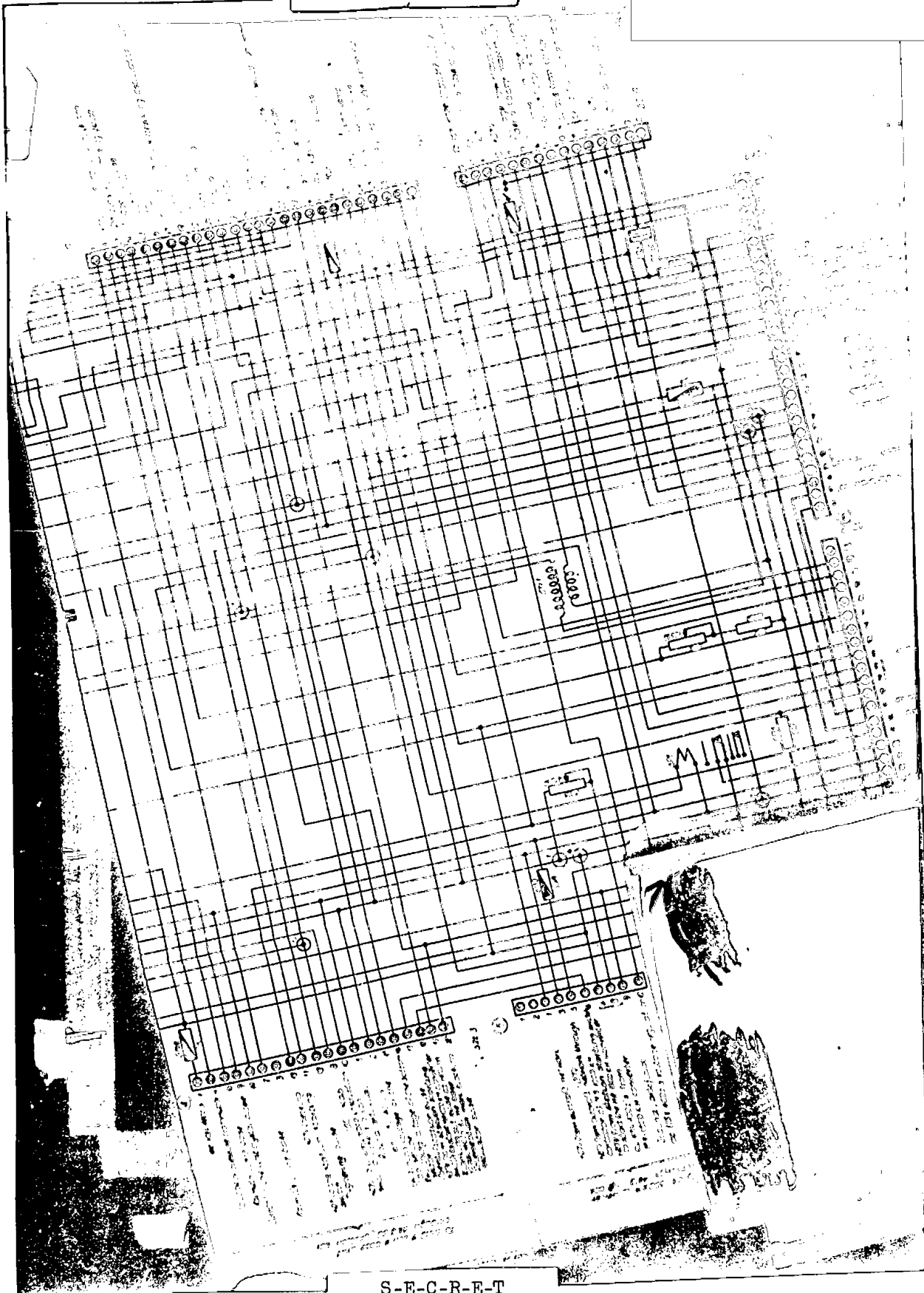

S-E-C-R-E-T

NO FOREIGN DISSEM

S-E-C-R-E-T
NO FOREIGN DISSEM

50X1

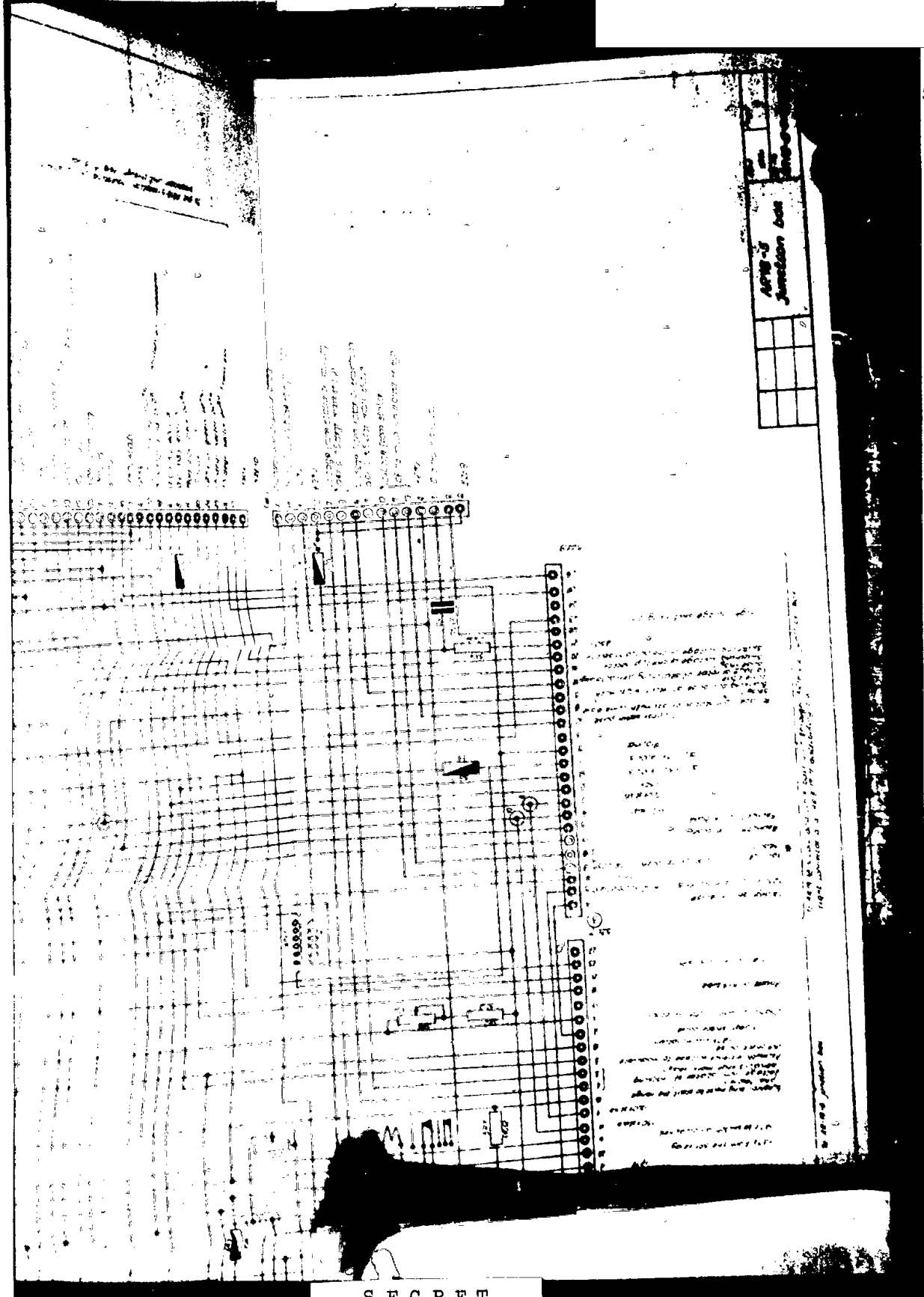

S-E-C-R-E-T
NO FOREIGN DISSEM

S-E-C-R-E-T
NO FOREIGN DISSEM



50X1

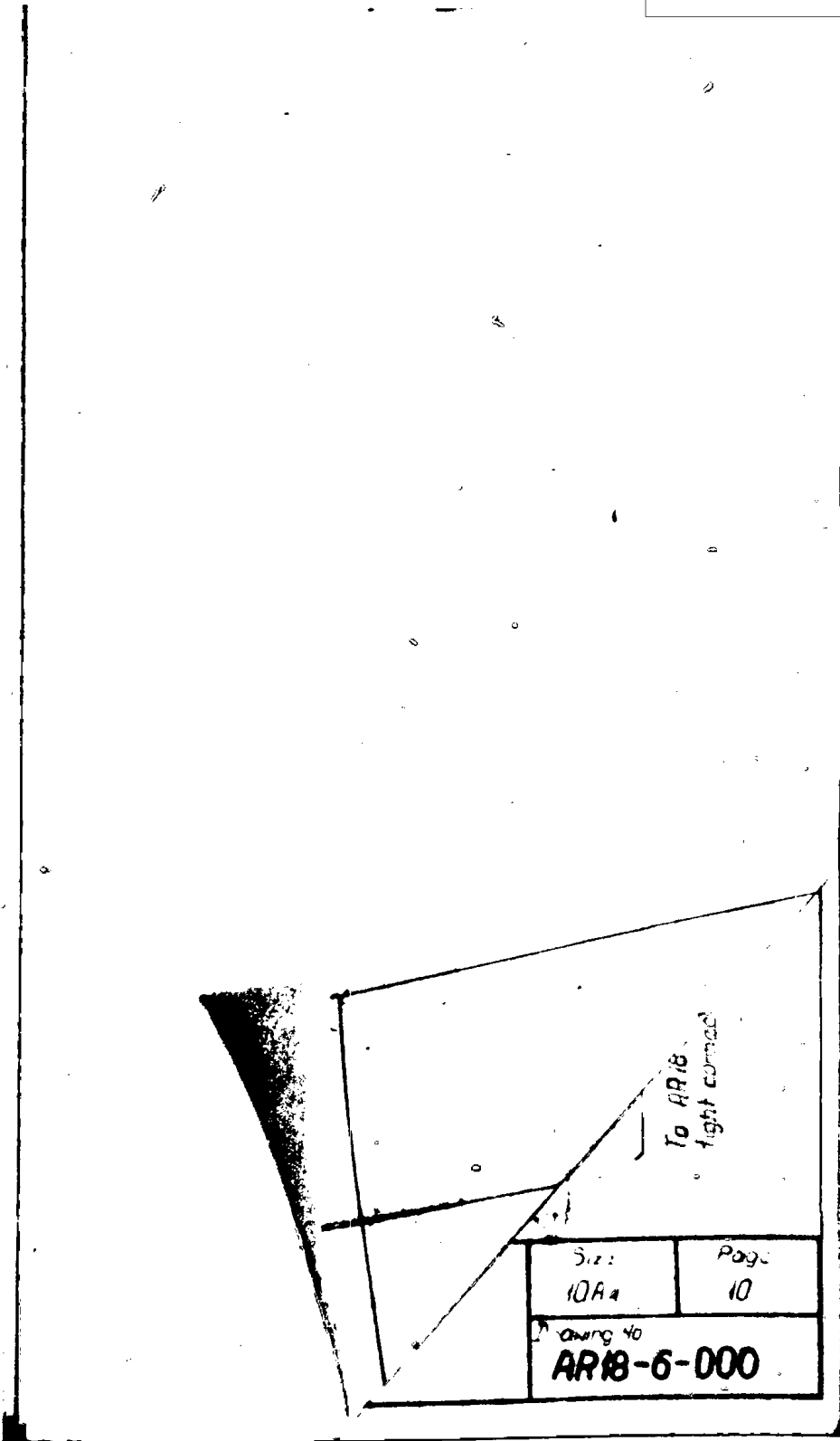

S-E-C-R-E-T
NO FOREIGN DISSEM

S-E-C-R-E-T
NO FOREIGN DISSEM

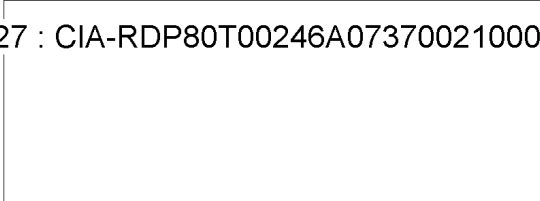

50X1

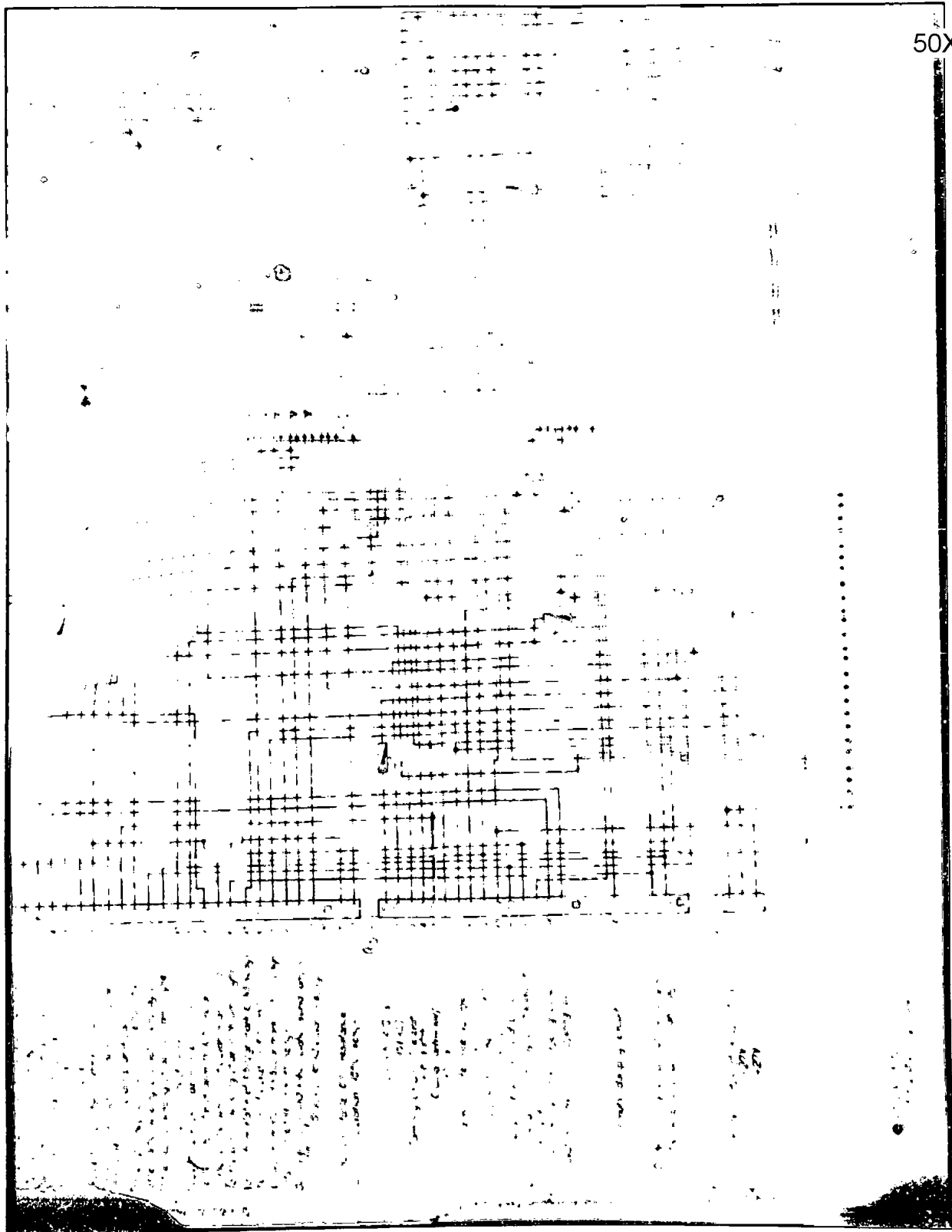

S-E-C-R-E-T
NO FOREIGN DISSEM

S-E-C-R-E-T
NO FOREIGN DISSEM

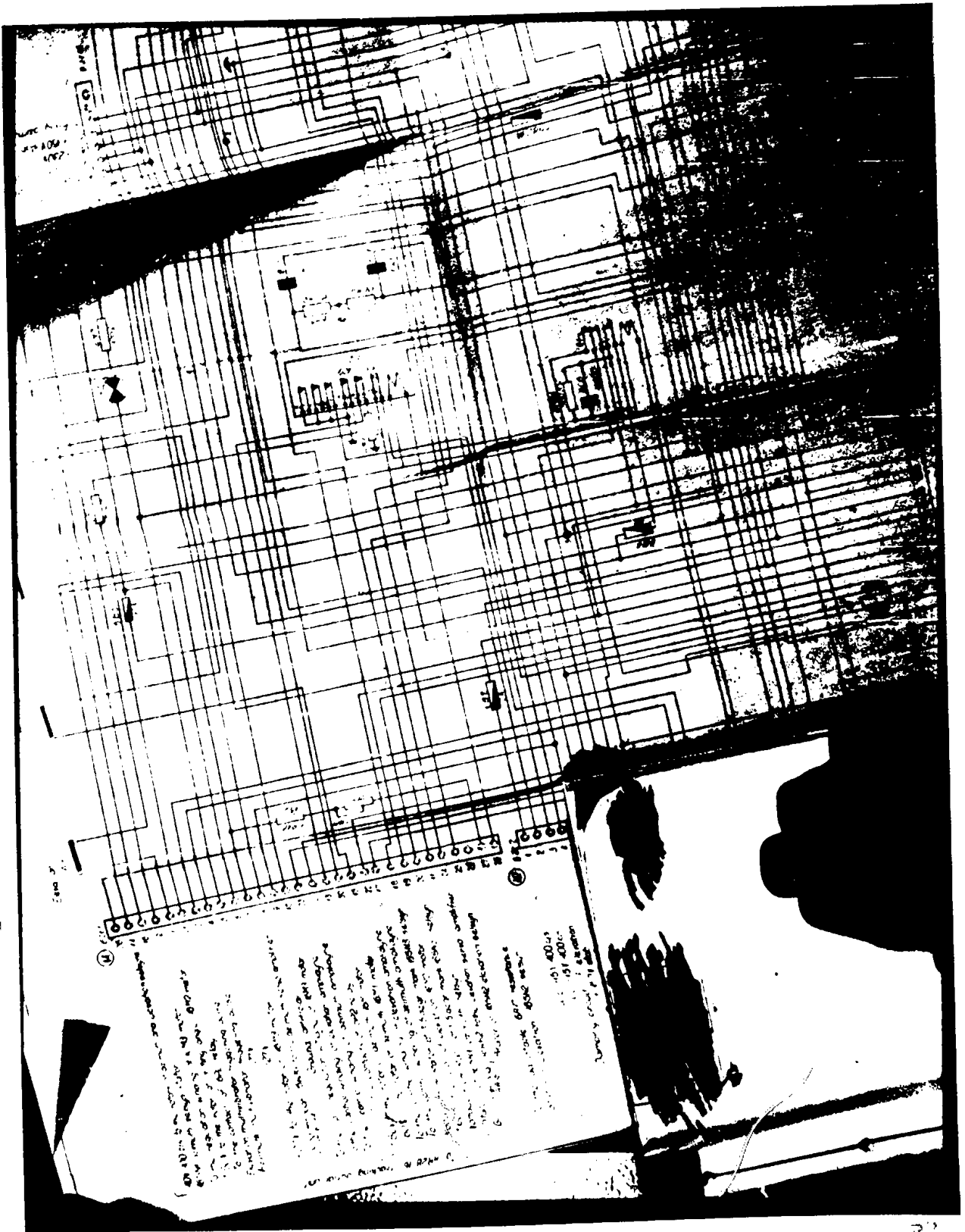

S-E-C-R-E-T

NO FOREIGN DISSEM

S-E-C-R-E-T
NO FOREIGN DISSEM



50X1

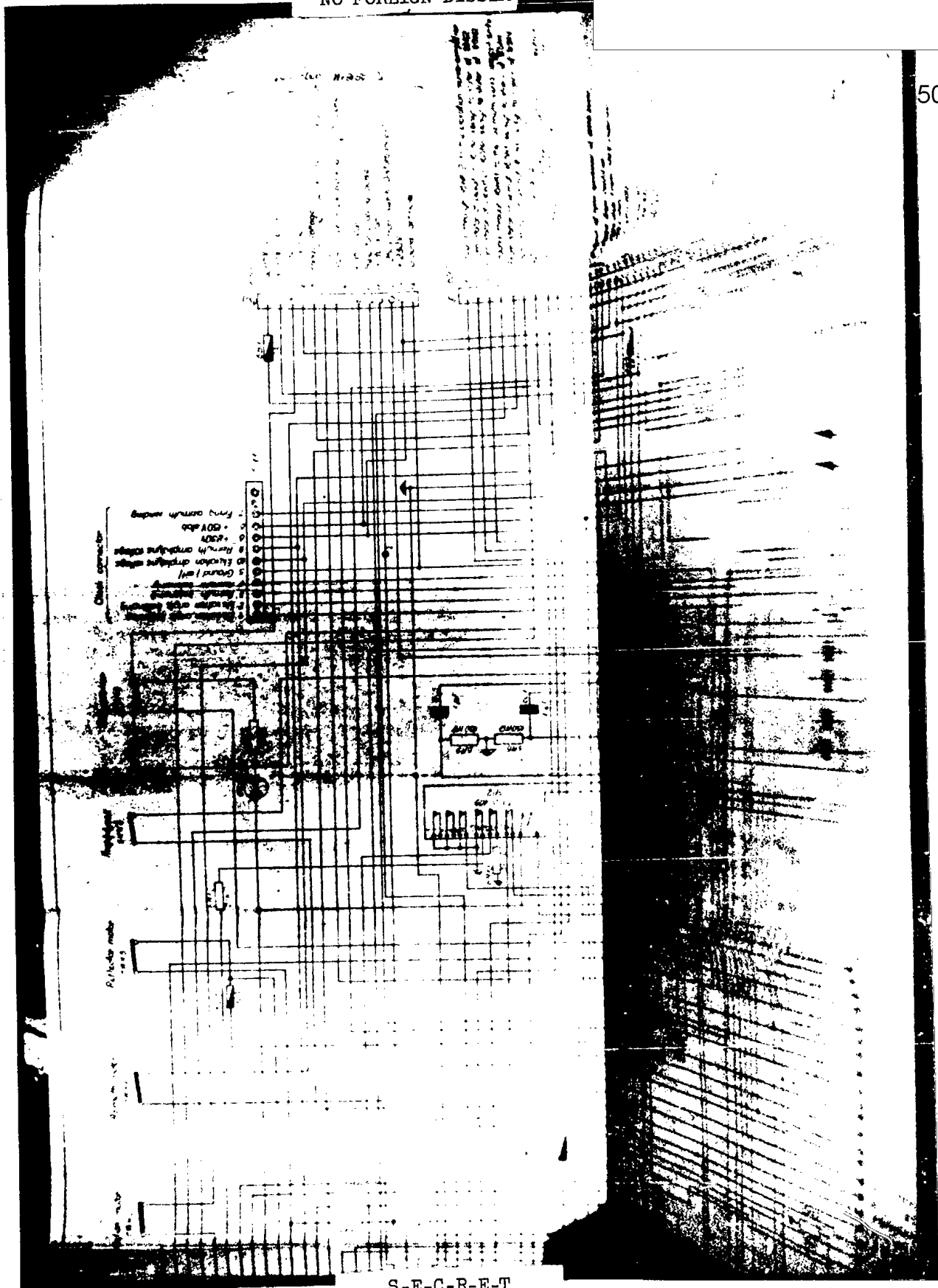

S-E-C-R-E-T
NO FOREIGN DISSEM

S-E-C-R-E-T
NO FOREIGN DISSEM

50X1

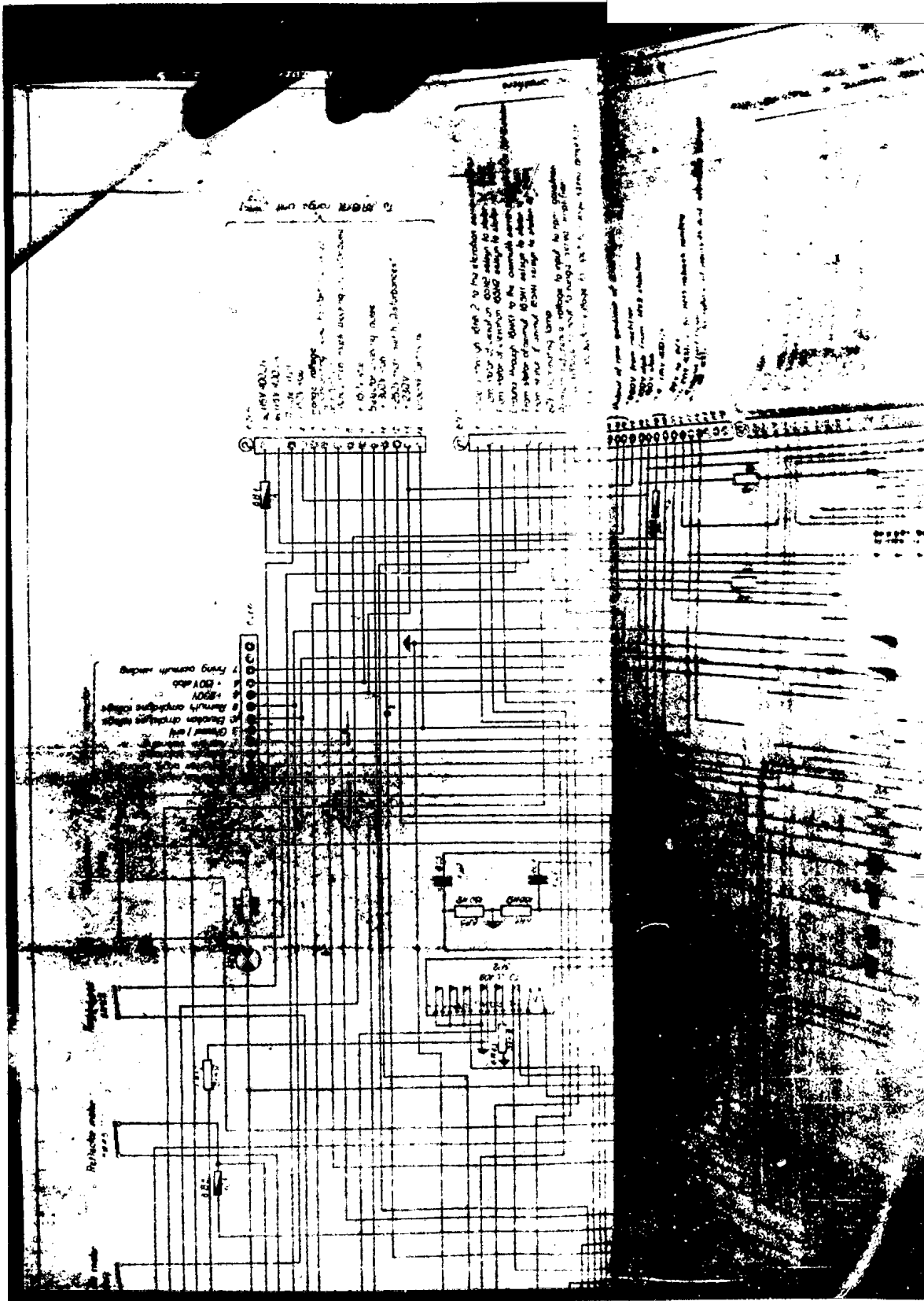

S-E-C-R-E-T
NO FOREIGN DISSEM

35

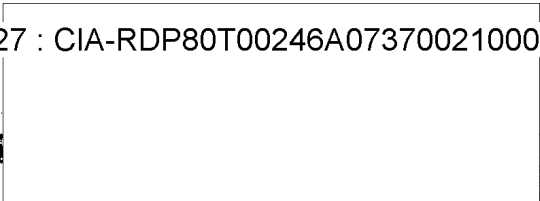

Distributing box

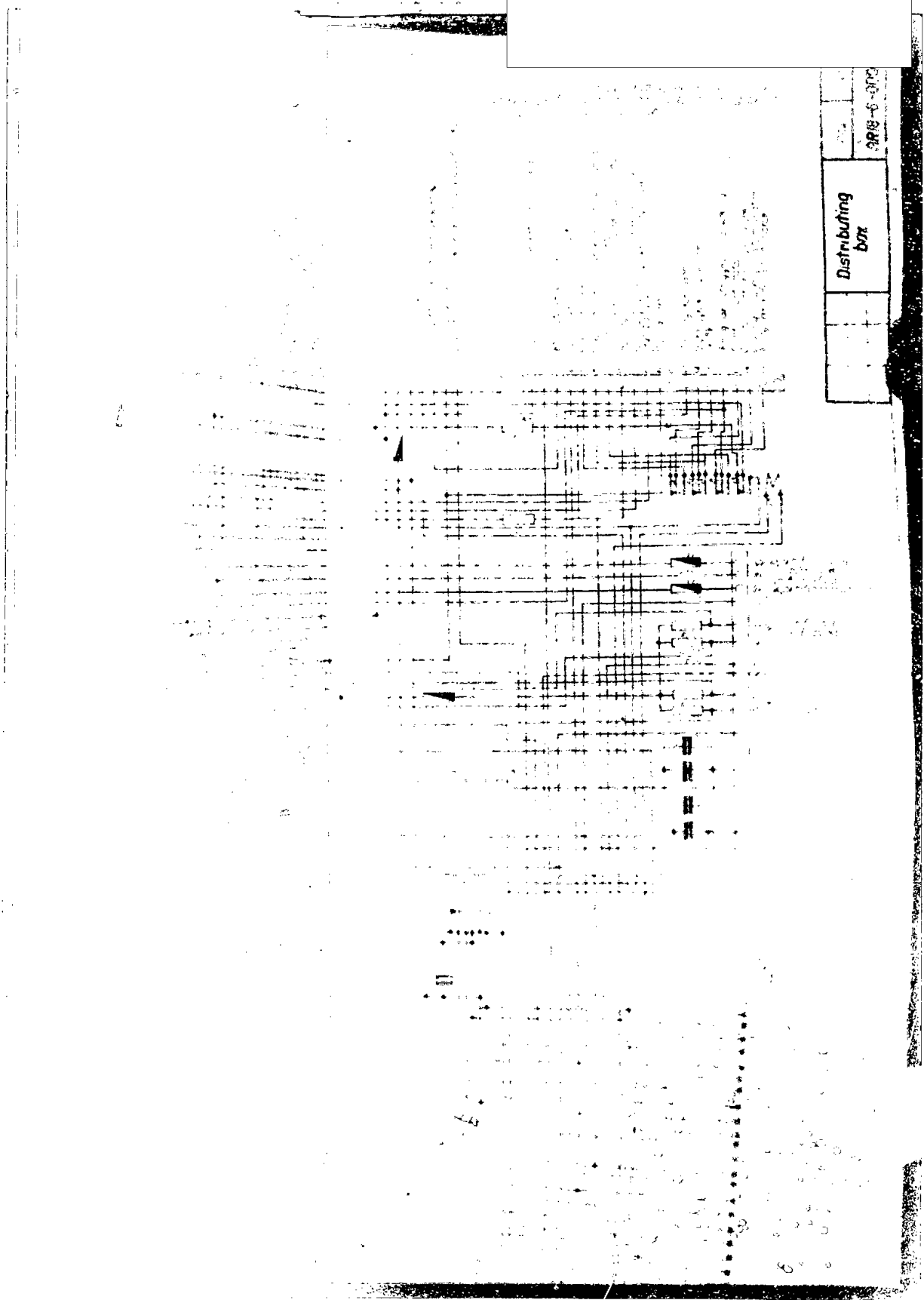

11-11-61

W. W. WATSON, JR.

S-E-C-R-E-T
NO FOREIGN DISSEM

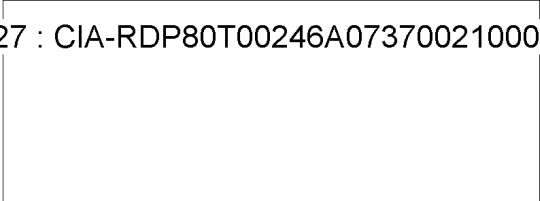

50X1

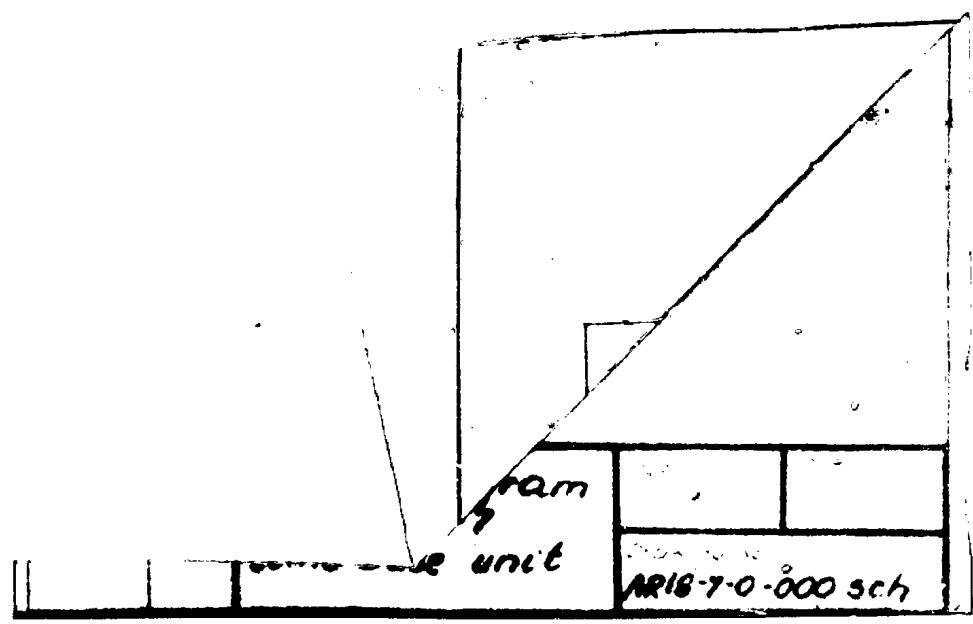

S-E-C-R-E-T
NO FOREIGN DISSEM

S-E-C-R-E-T
NO FOREIGN DISSEM

50X1

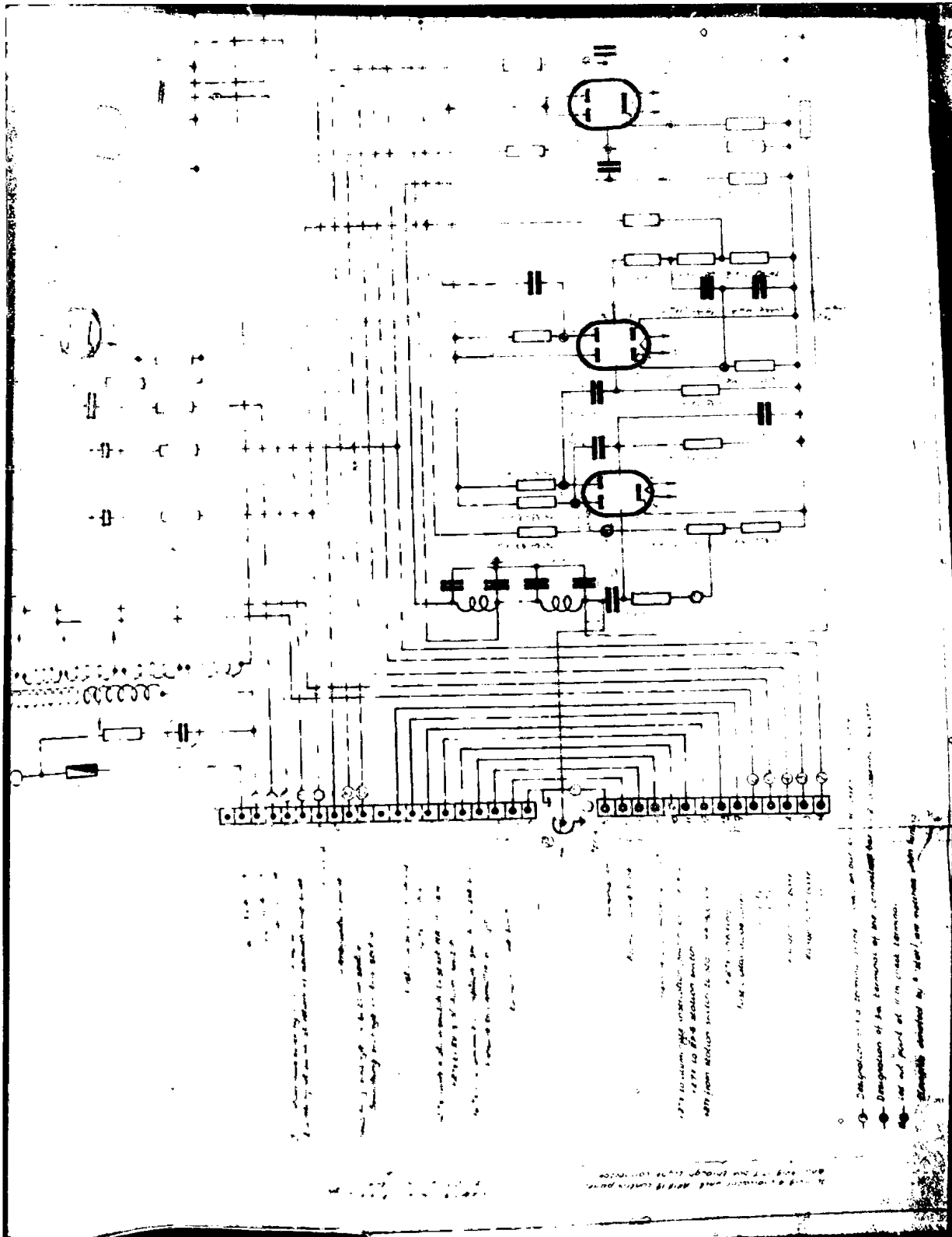

S-E-C-R-E-T
NO FOREIGN DISSEM

S-E-C-R-E-T
NO FOREIGN DISSEM

50X1

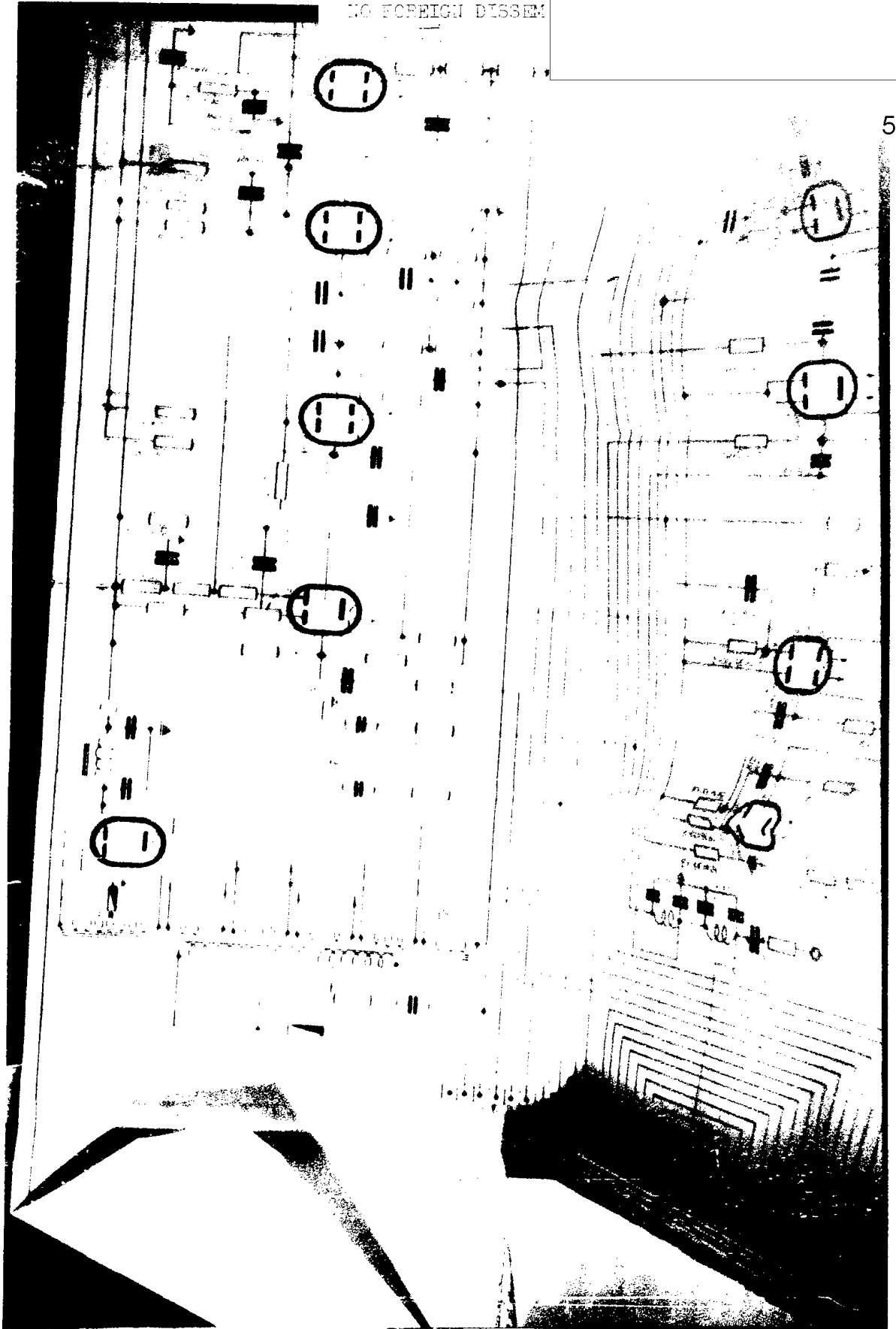

S-E-C-R-E-T

NO FOREIGN DISSEM

S-E-C-R-E-T
NO FOREIGN DISSEM

50X1

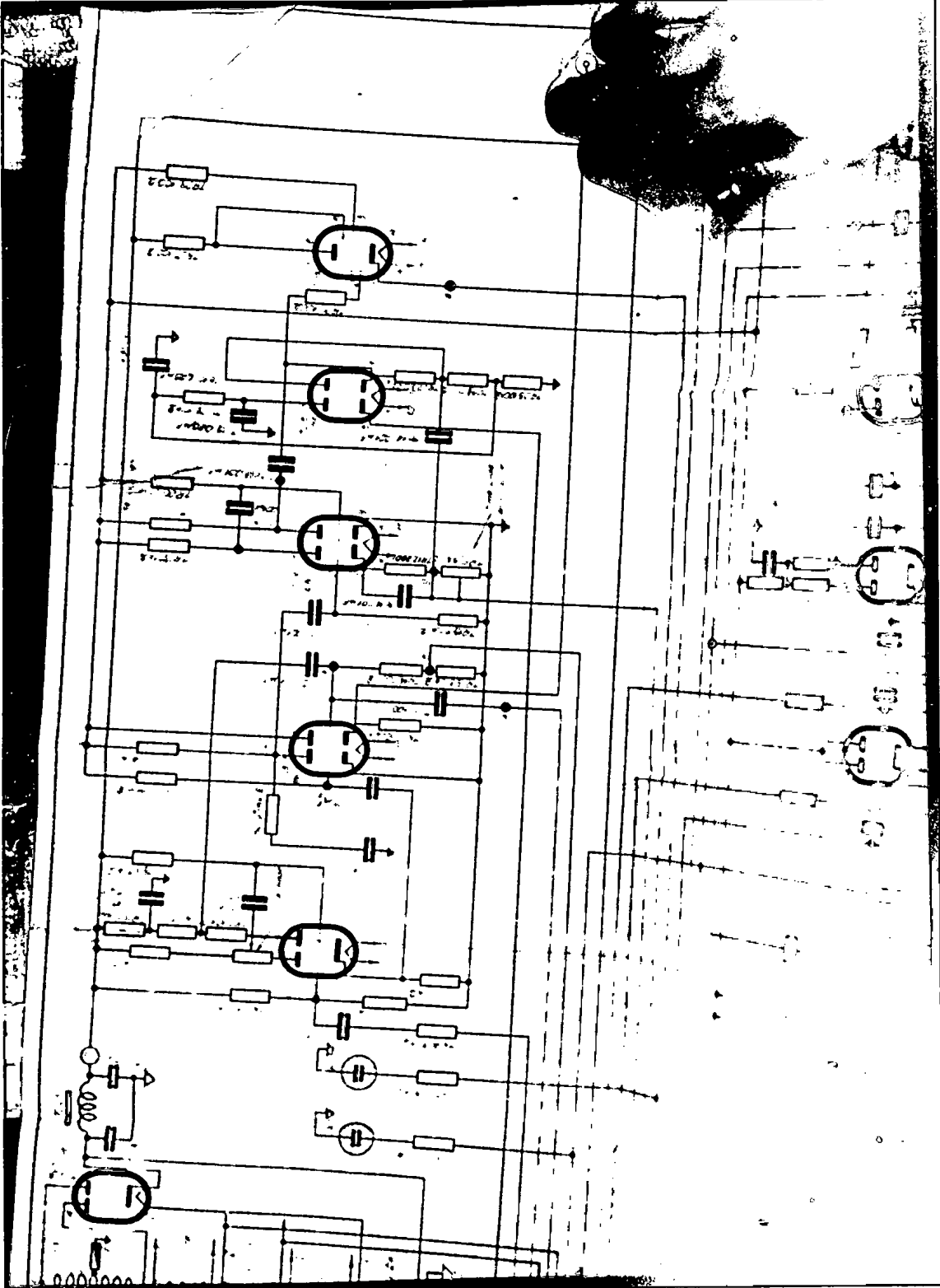

40

S-E-C-R-E-T
NO FOREIGN DISSEM

S-E-C-R-E-T
NO FOREIGN DISSEM

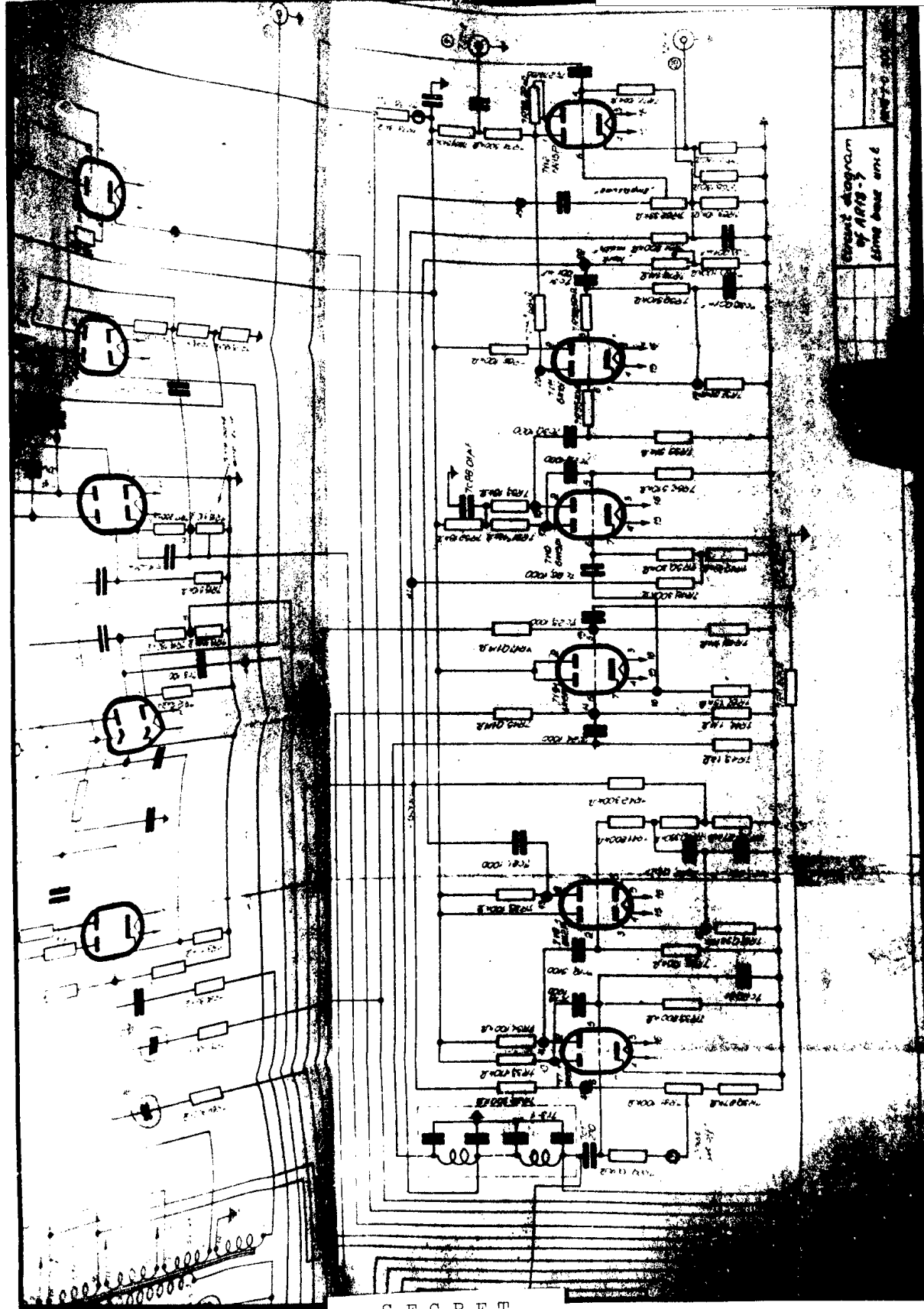

50X1

Legend diagram
of A198-7
Sheet 6 of 6

S-E-C-R-E-T

NO FOREIGN DISSEM

S-E-C-R-E-T
NO FOREIGN DISSEM

50X1

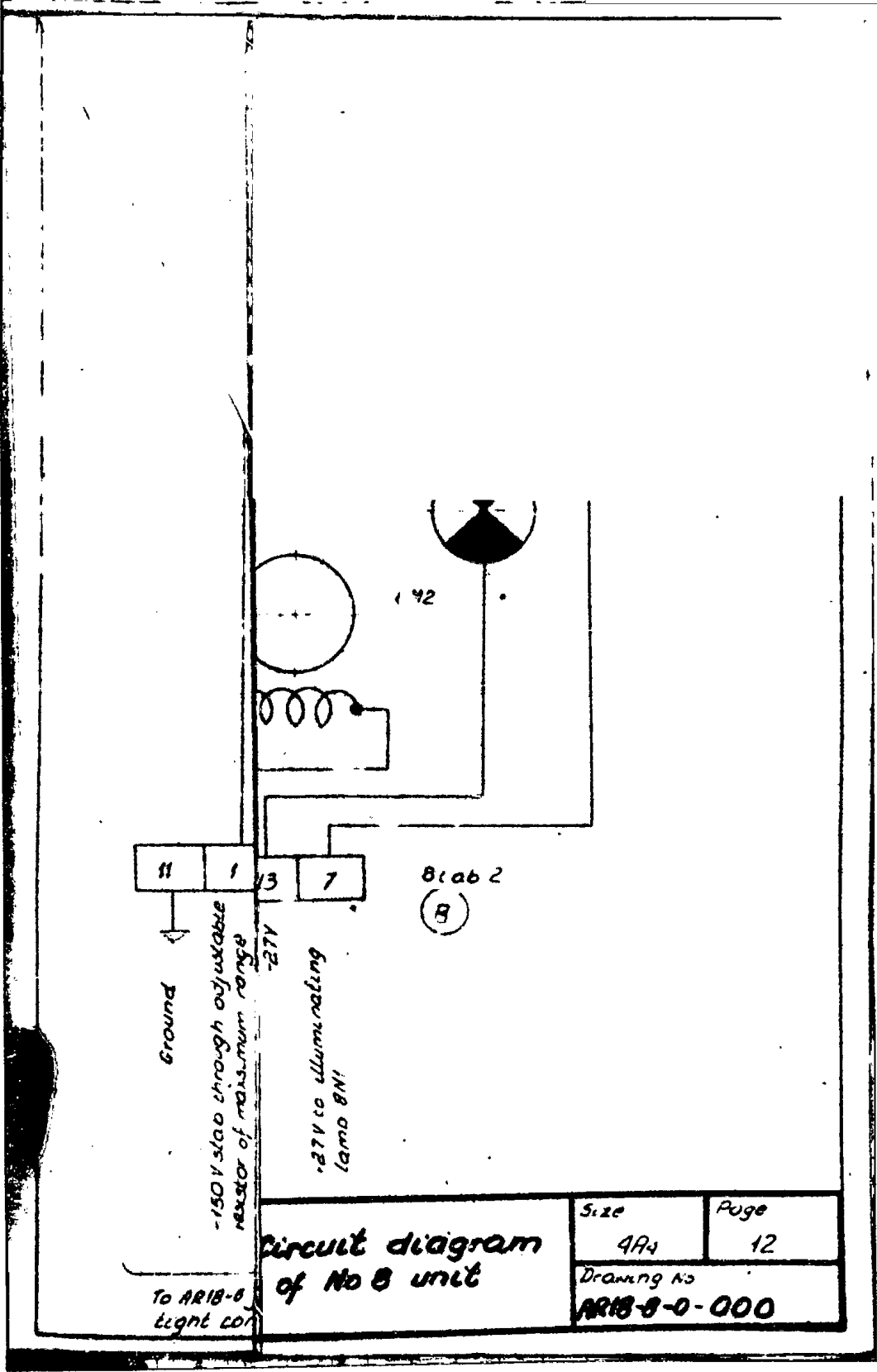

Circuit diagram
of No 8 unit

S-E-C-R-E-T

NO FOREIGN DISSEM

S-E-C-R-E-T
NO FOREIGN DISSEM

50X1

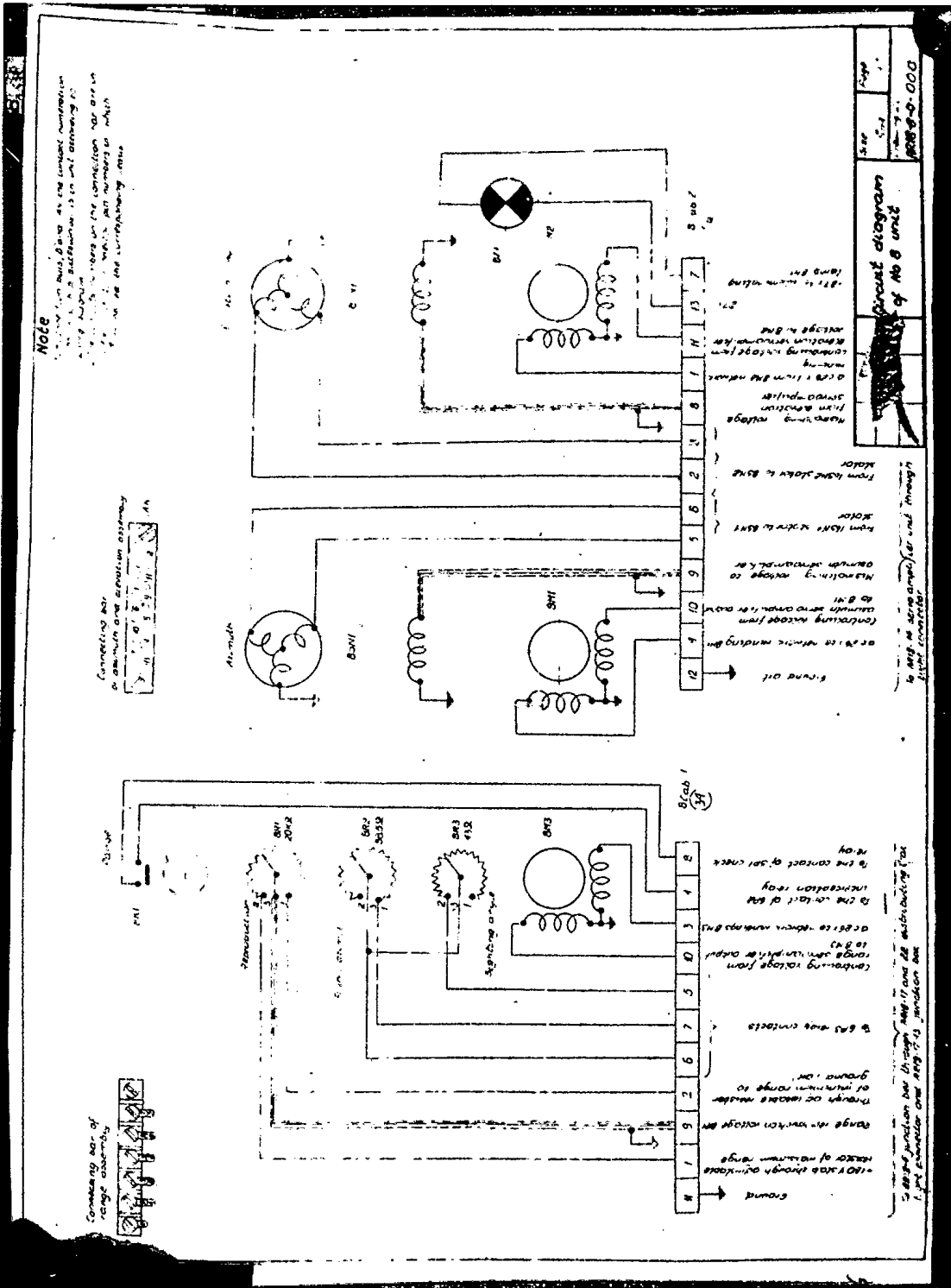

S-E-C-R-E-T

NO FOREIGN DISSEM

S-E-C-R-E-T
NO FOREIGN DISSEM



50X1

Unit of amplidynes
AR18-9-0-000(sch)

S-E-C-R-E-T
NO FOREIGN DISSEM

44

S-E-C-R-E-T
NO FOREIGN DISSEM

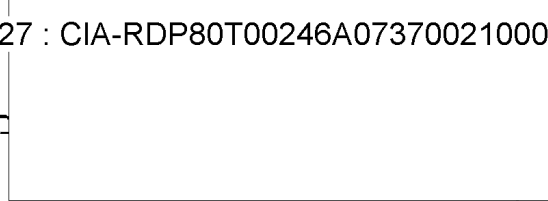

50X1

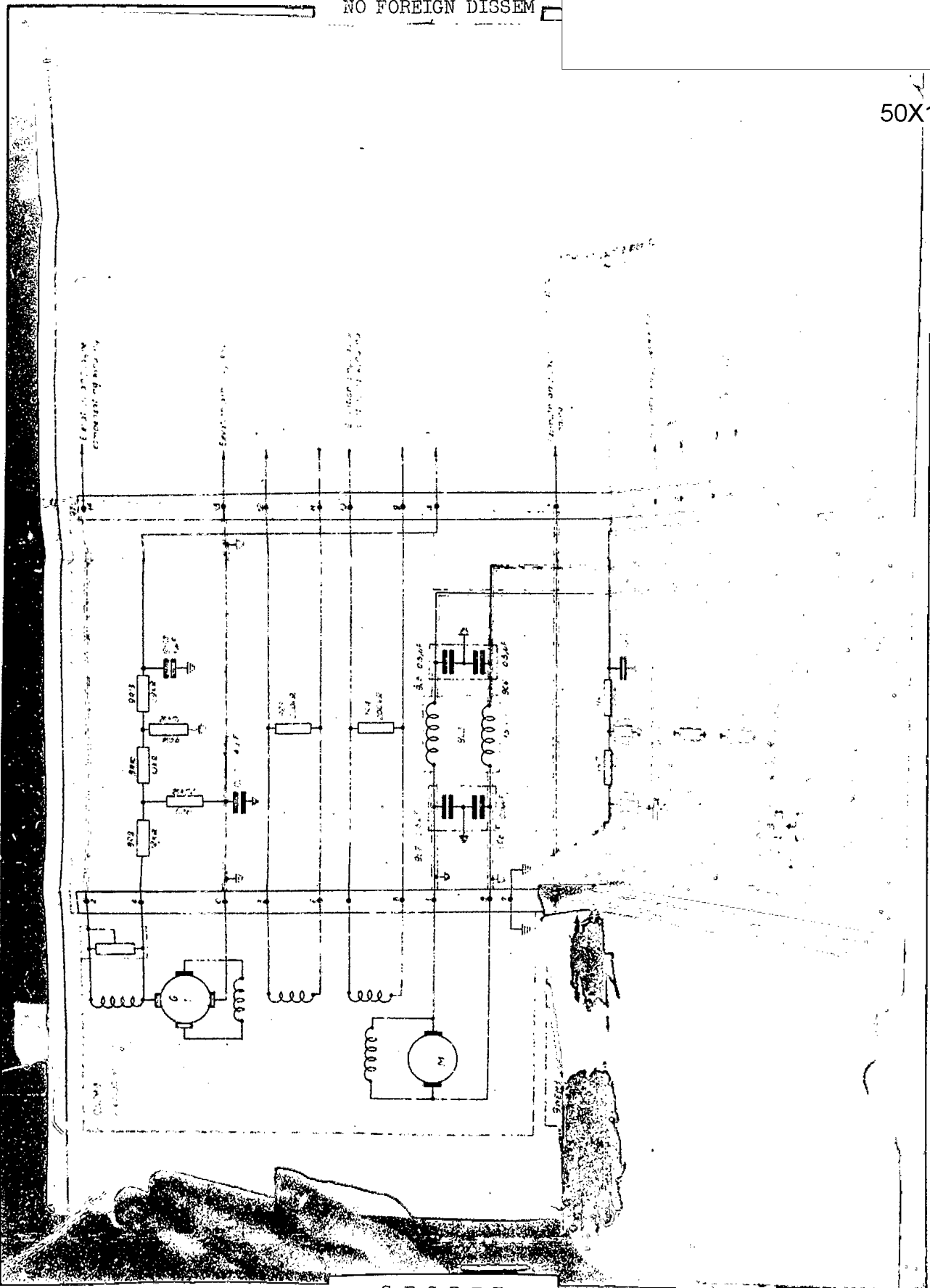

S-E-C-R-E-T
NO FOREIGN DISSEM

SECRET
NO FOREIGN DISSEM

50X1

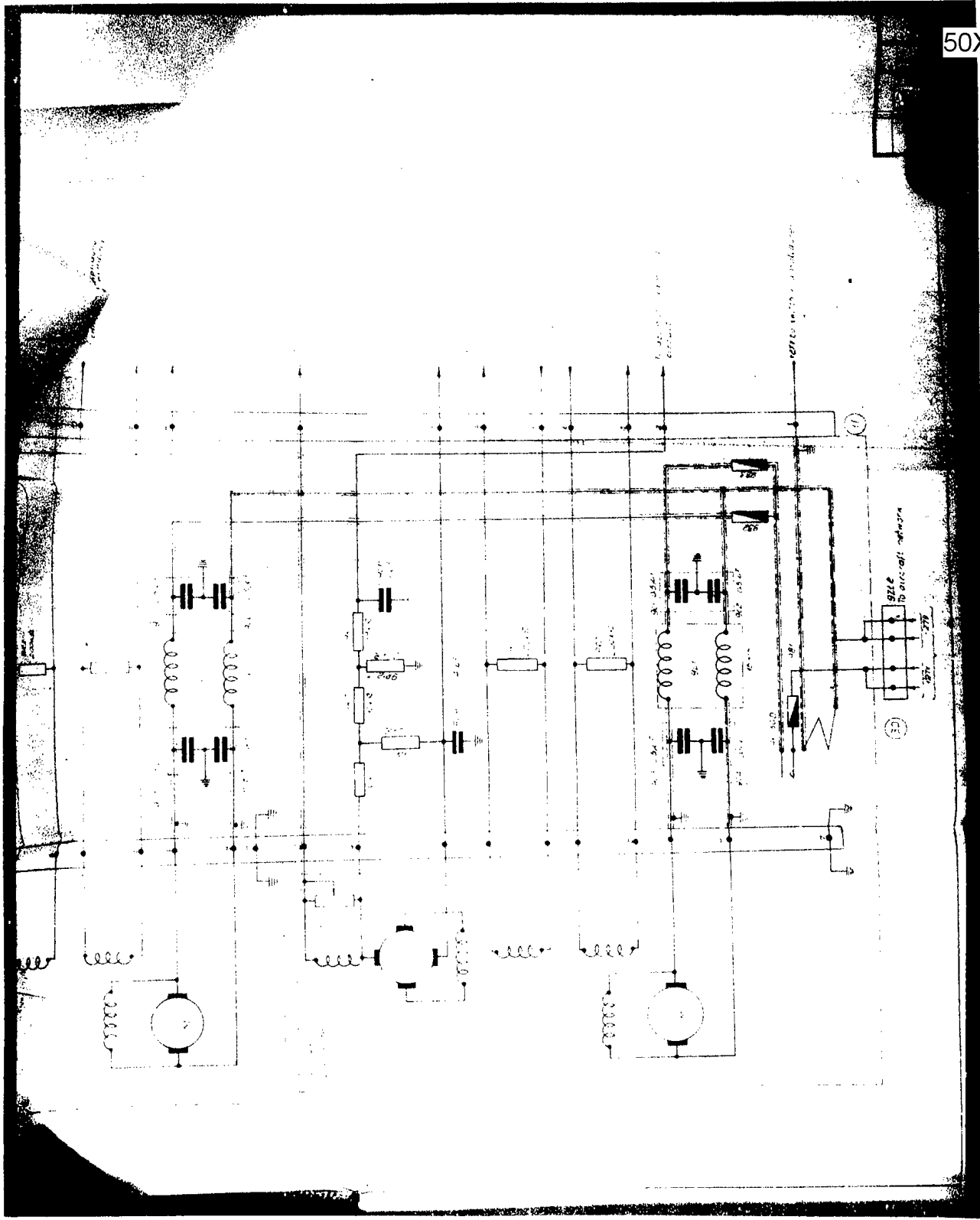

SECRET

NO FOREIGN DISSEM

S-E-C-R-E-T
NO FOREIGN DISSEM

50X1

Unit of
amplidyns

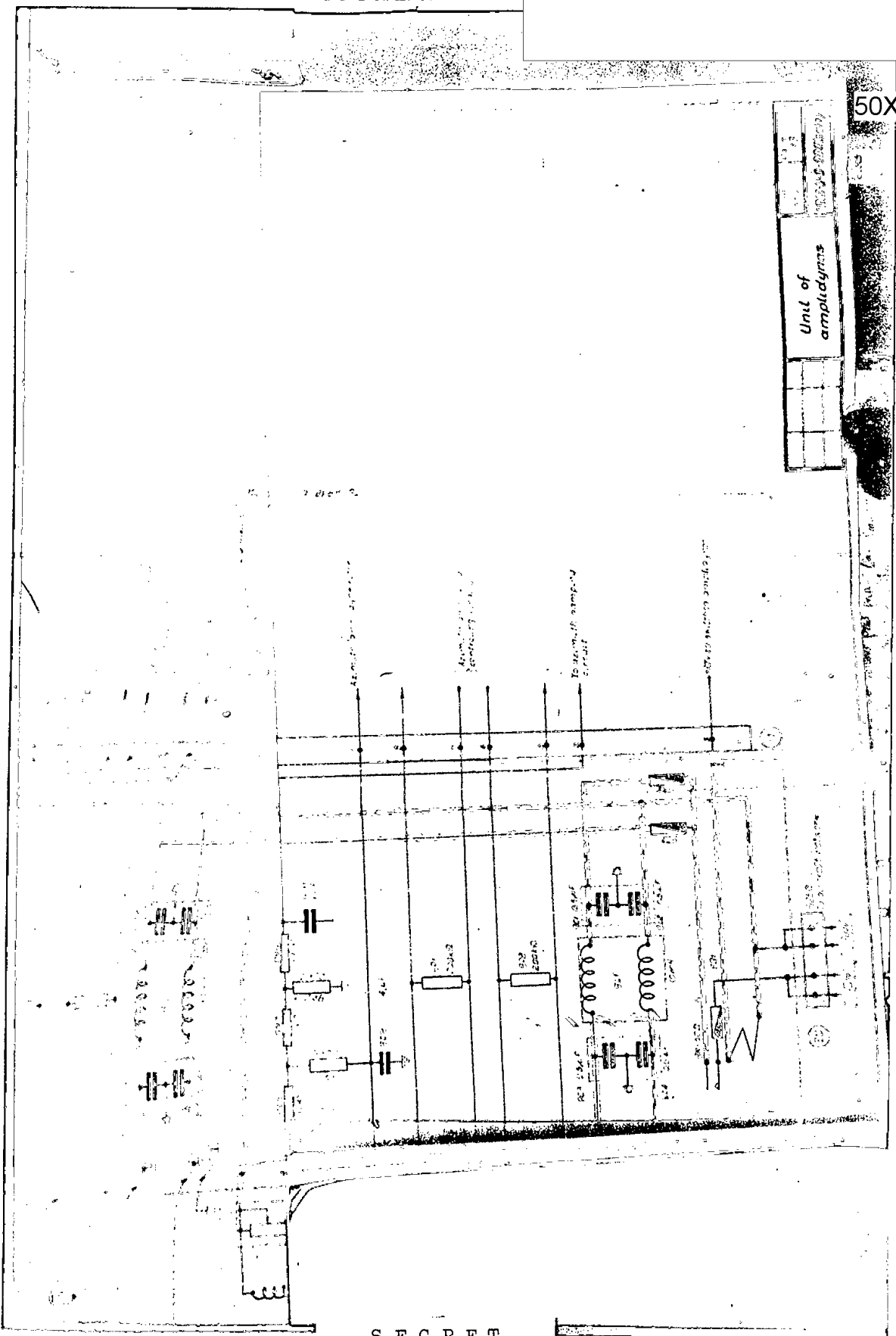

S-E-C-R-E-T
NO FOREIGN DISSEM

S-E-C-R-E-T
NO FOREIGN DISSEM

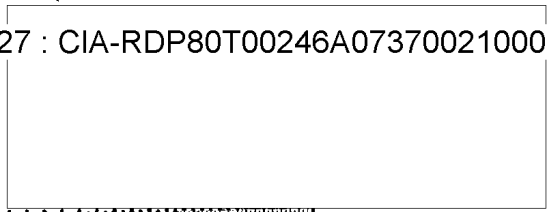

50X1

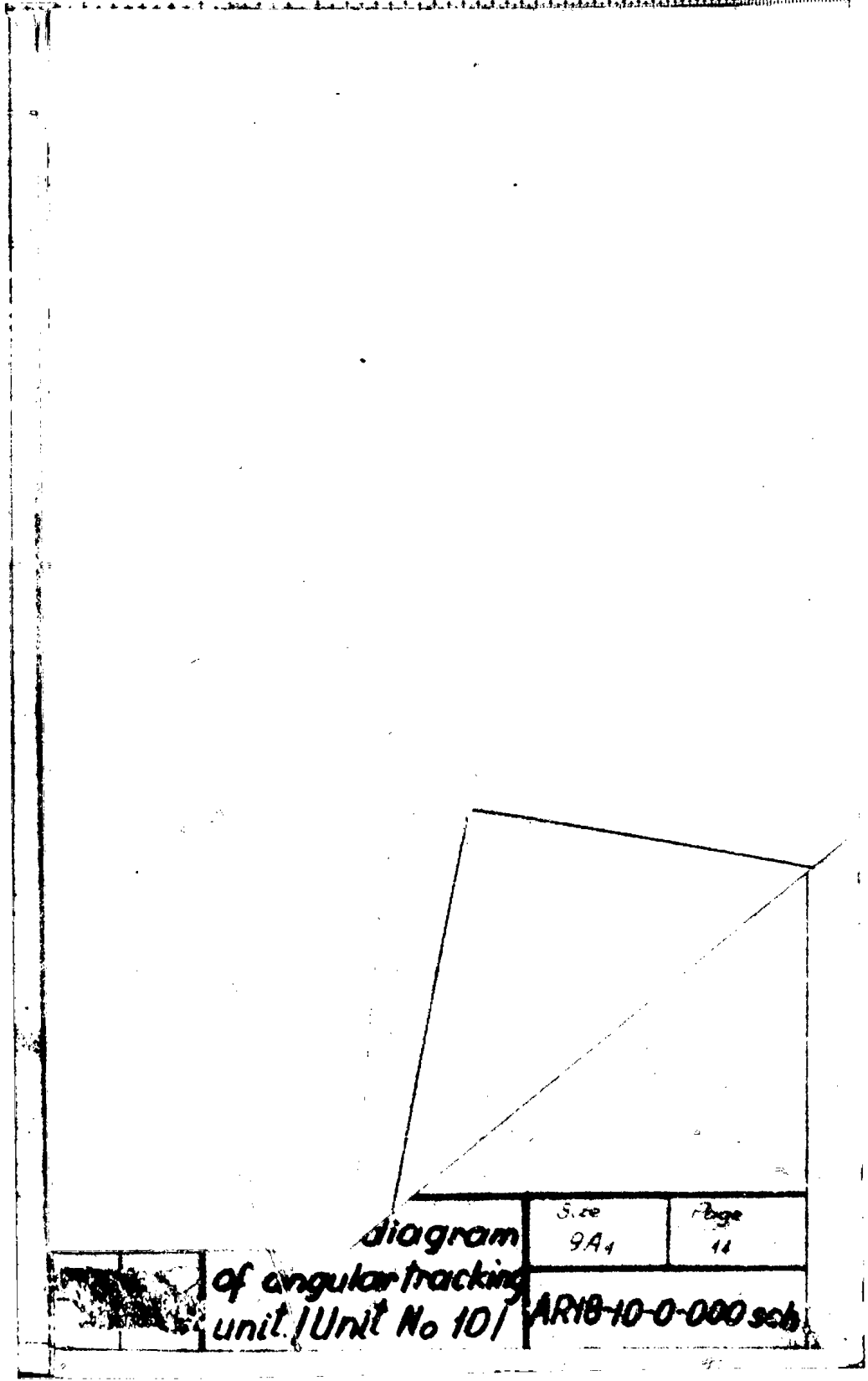

S-E-C-R-E-T

NO FOREIGN DISSEM

S-E-C-R-E-T
NO FOREIGN DISSEM

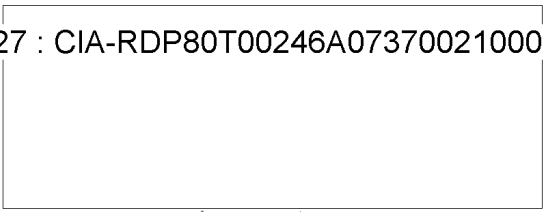

50X1

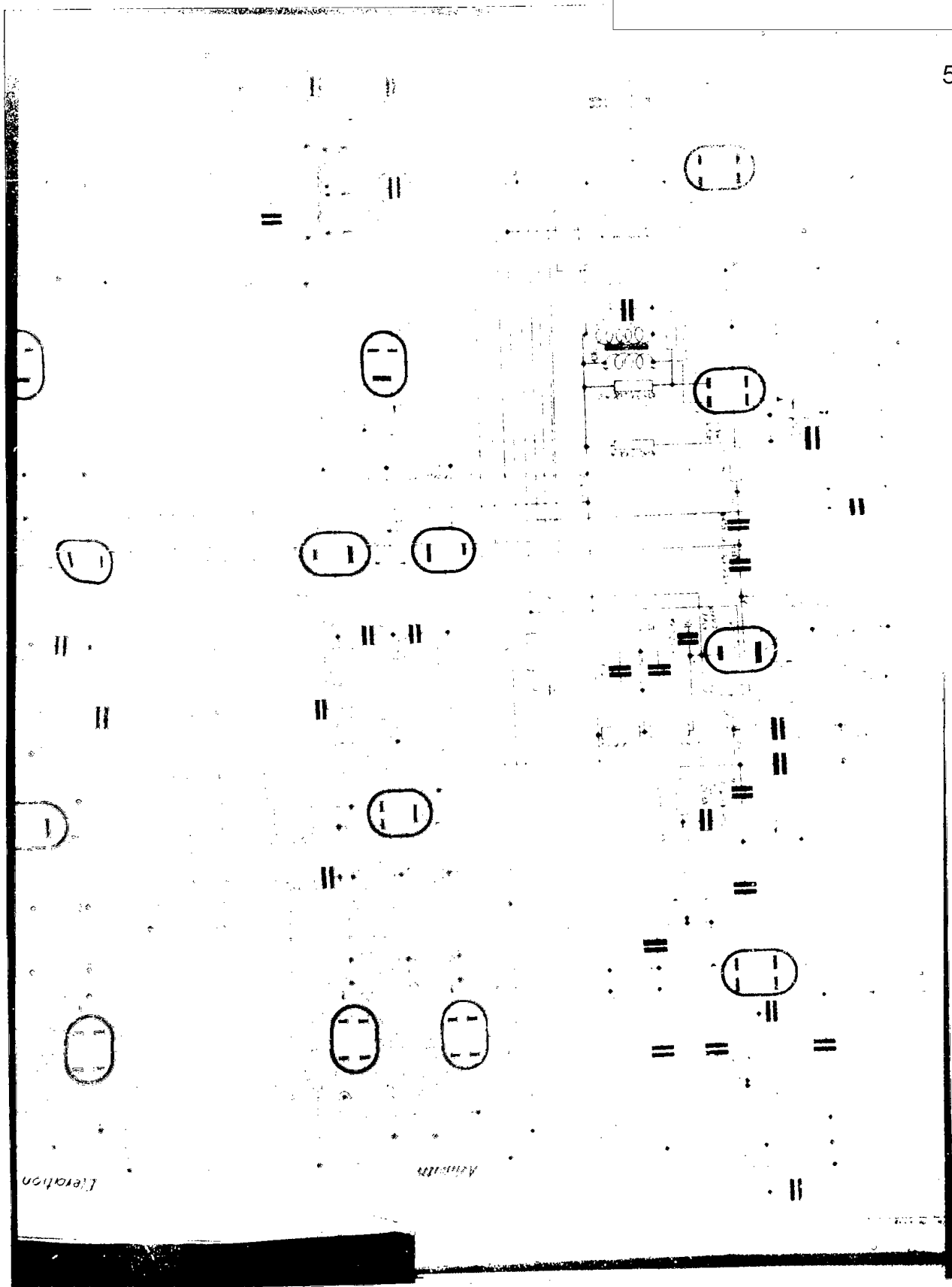

Iteration

Iteration

S-E-C-R-E-T

NO FOREIGN DISSEM

S-E-C-R-E-T
NO FOREIGN DISSEM

50X1

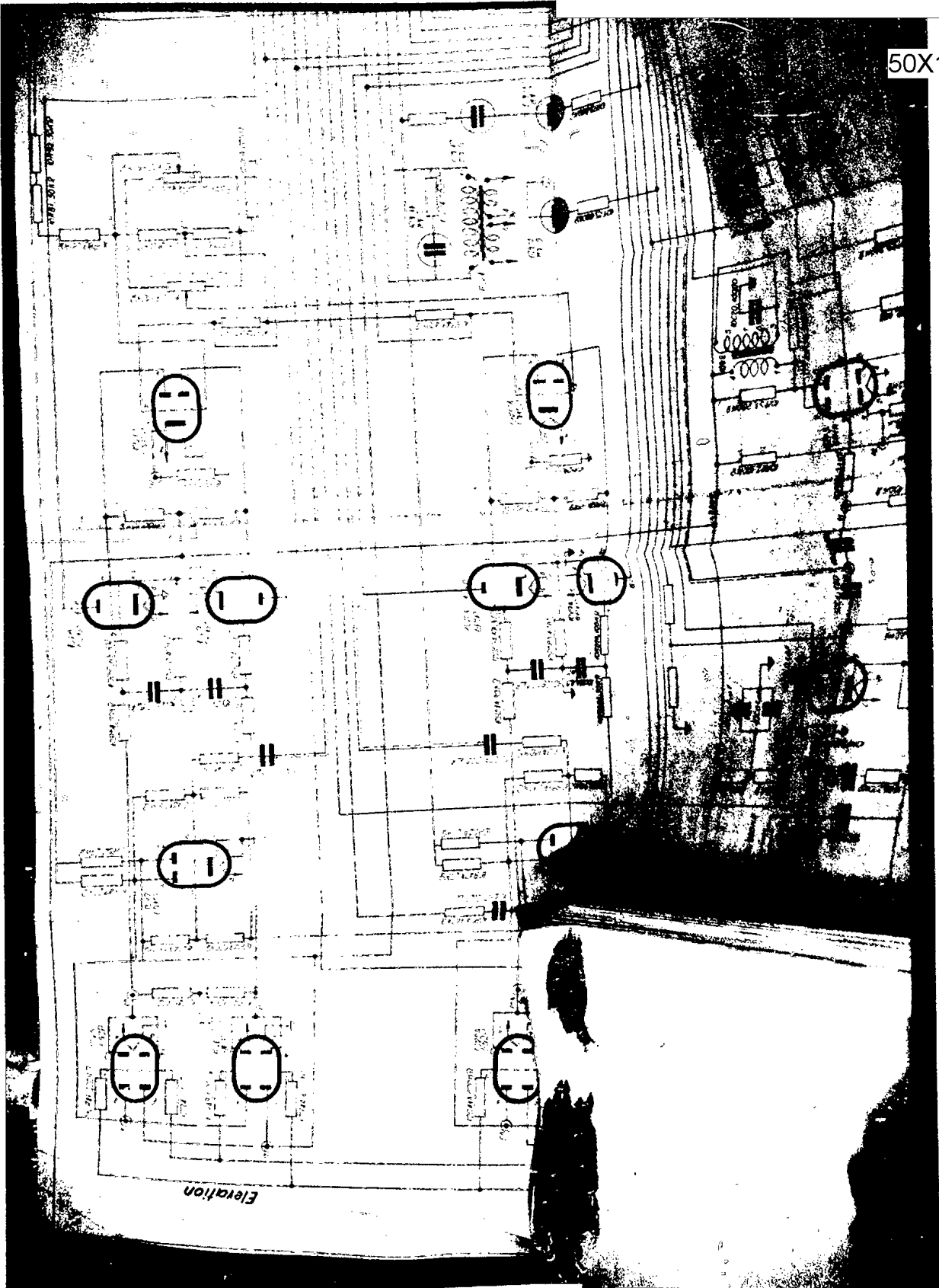

S-E-C-R-E-T

NO FOREIGN DISSEM

S-E-C-R-E-T
NO FOREIGN DISSEM

50X1

Circuit diagram
of crypto-math
unit 1 Unit 151

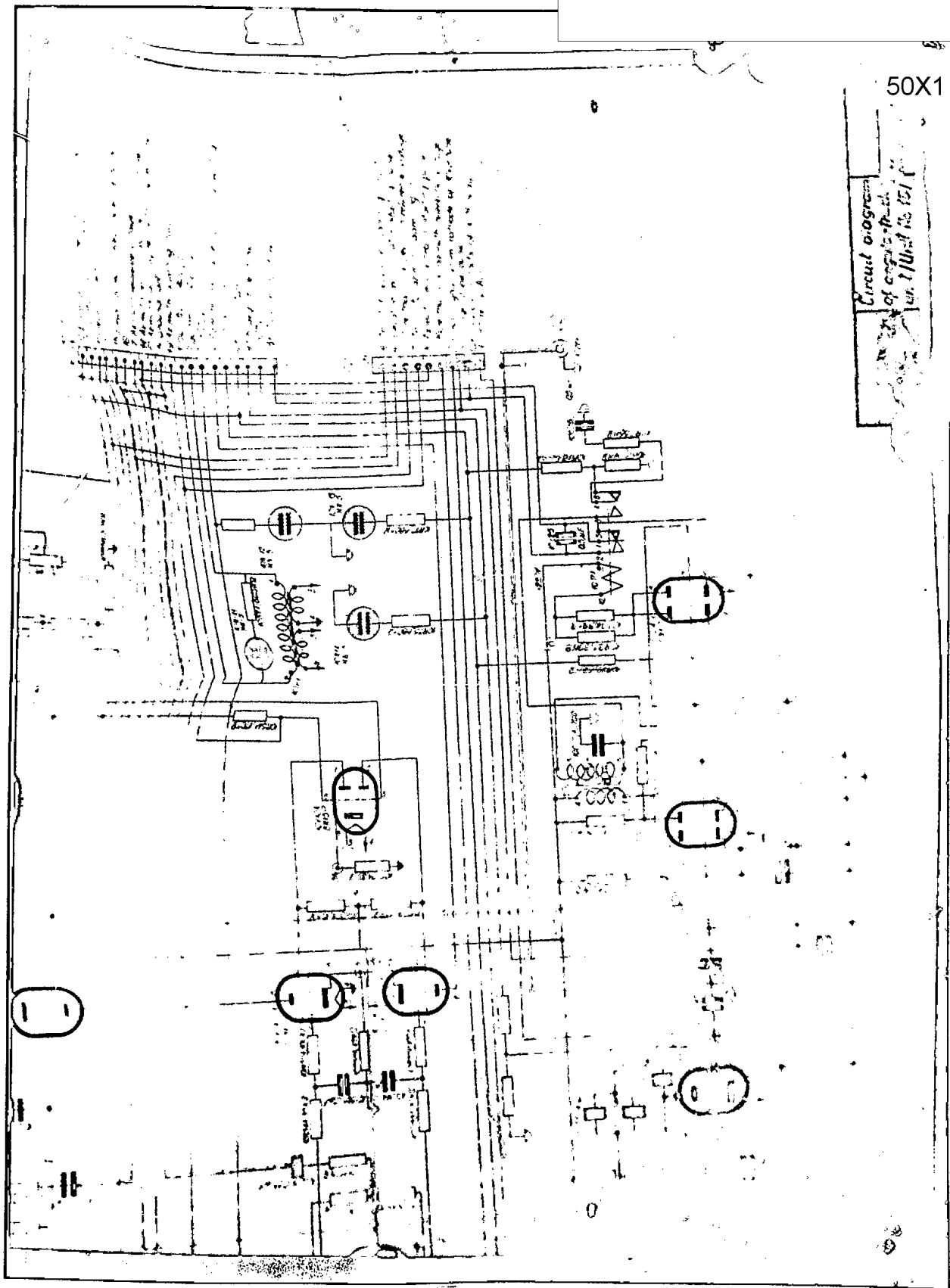

S-E-C-R-E-T

NO FOREIGN DISSEM

S-E-C-R-E-T
NO FOREIGN DISSEM



S-E-C-R-E-T

NO FOREIGN DISSEM

S-E-C-R-E-T
NO FOREIGN DISSEM

50X1

Circuit Diagram of AR18-11
Range Unit

AR18-11-0-000

53

S-E-C-R-E-T
NO FOREIGN DISSEM

S-E-C-R-E-T
NO FOREIGN DISSEM

50X1

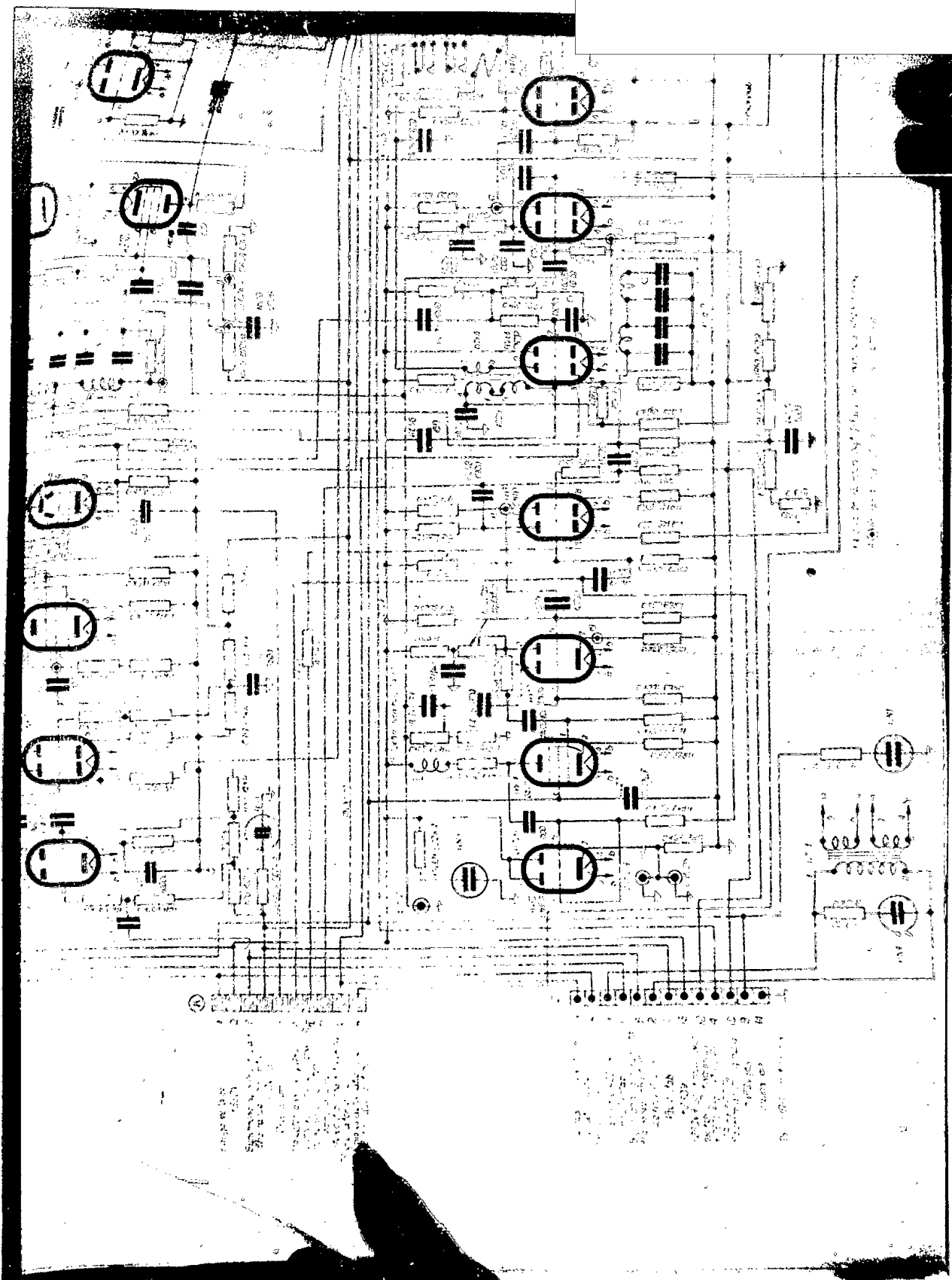

S-E-C-R-E-T

NO FOREIGN DISSEM

51

S-E-C-R-E-T
NO FOREIGN DISSEM

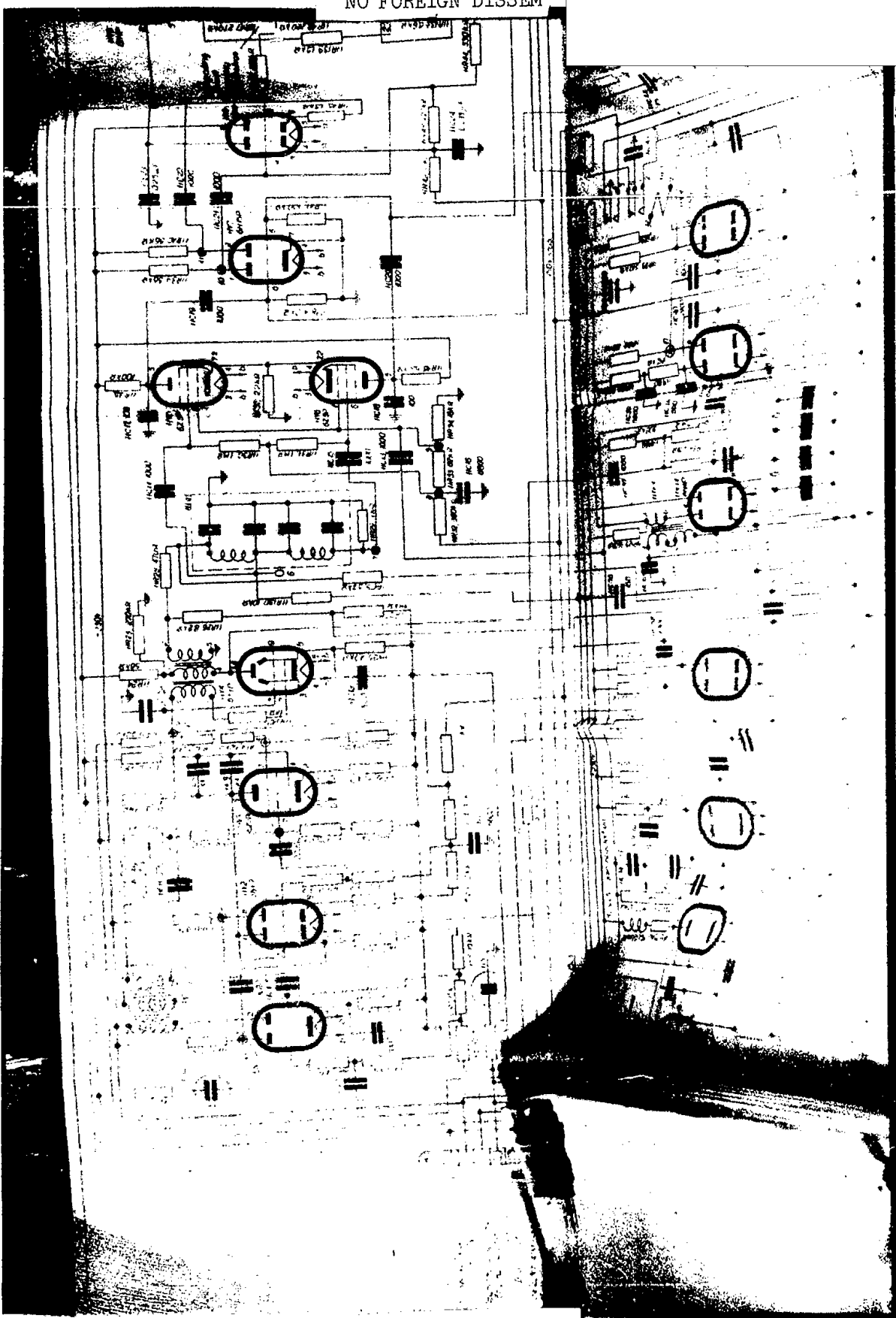

50X1

S-E-C-R-E-T

NO FOREIGN DISSEM

S-E-C-R-E-T
NO FOREIGN DISSEM

50X1

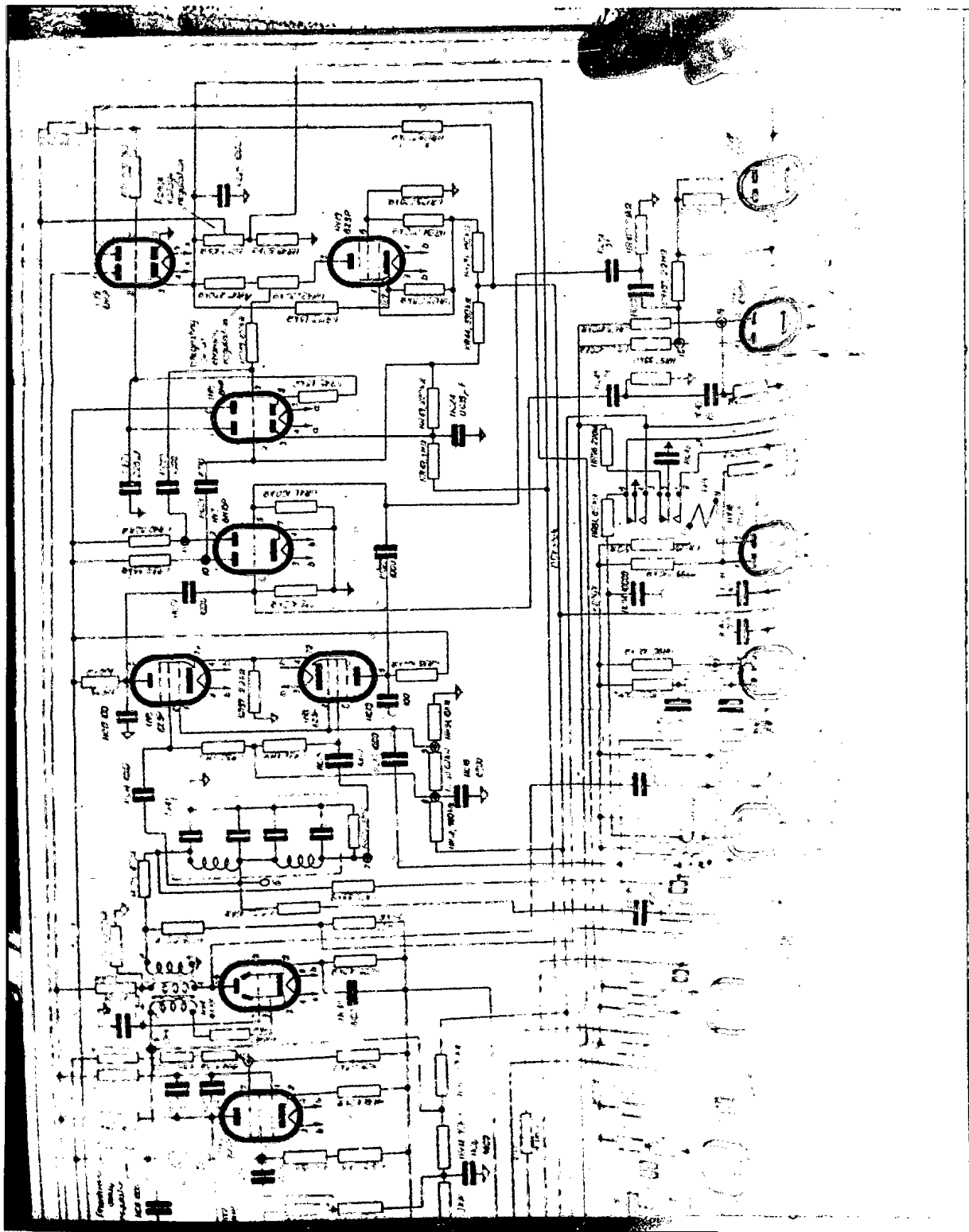

S-E-C-R-E-T

NO FOREIGN DISSEM

S-E-C-R-E-T
NO FOREIGN DISSEM

50X1

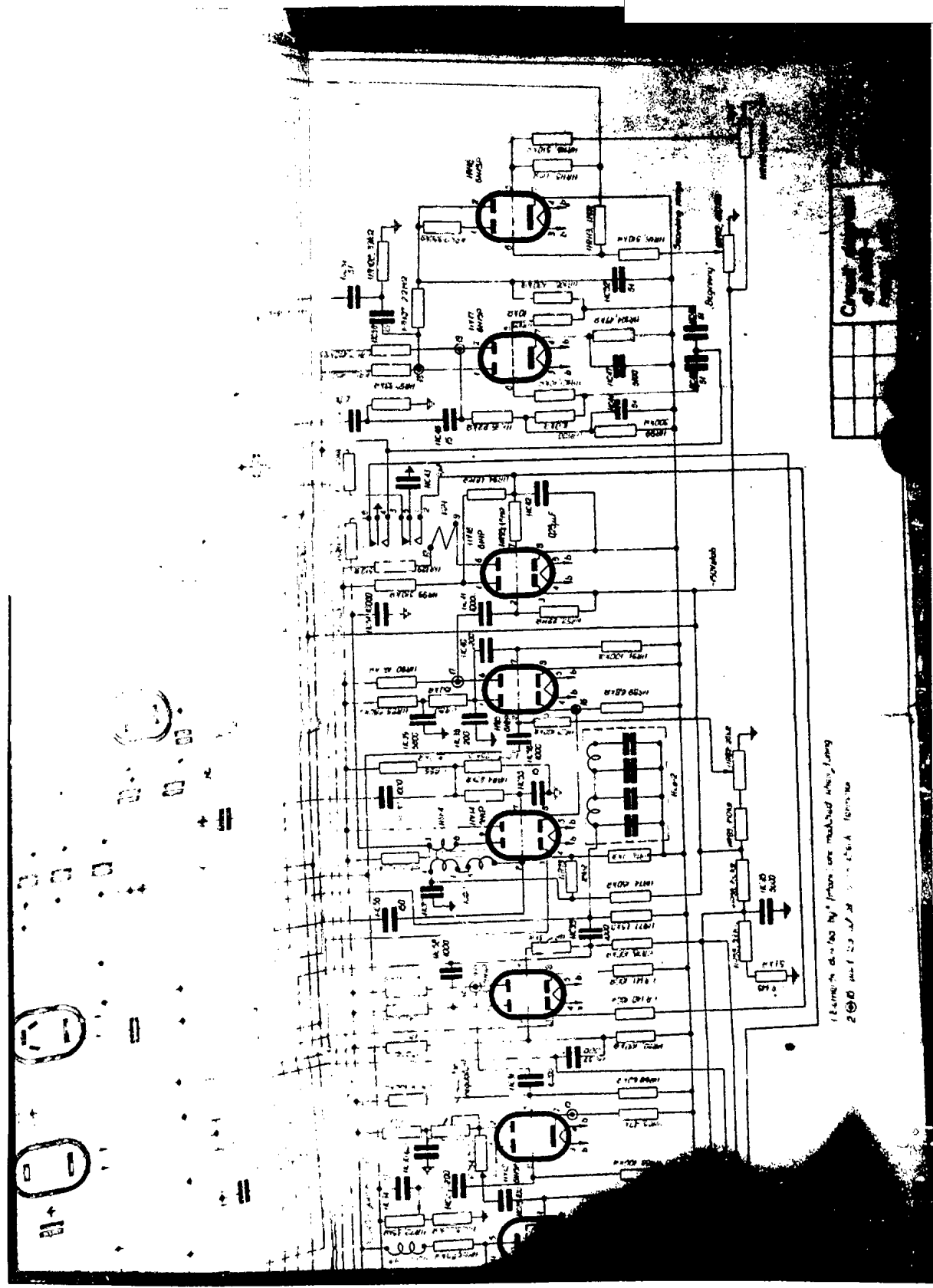

S-E-C-R-E-T

NO FOREIGN DISSEM

S-E-C-R-E-T
NO FOREIGN DISSEM



50X1



		of supply and estimate	BA	15
		time units unit	Drawing No	AMS-12-0-000
		AMS-12-0-000		

58

S-E-C-R-E-T
NO FOREIGN DISSEM

S-E-C-R-E-T
NO FOREIGN DISSEM

50X1

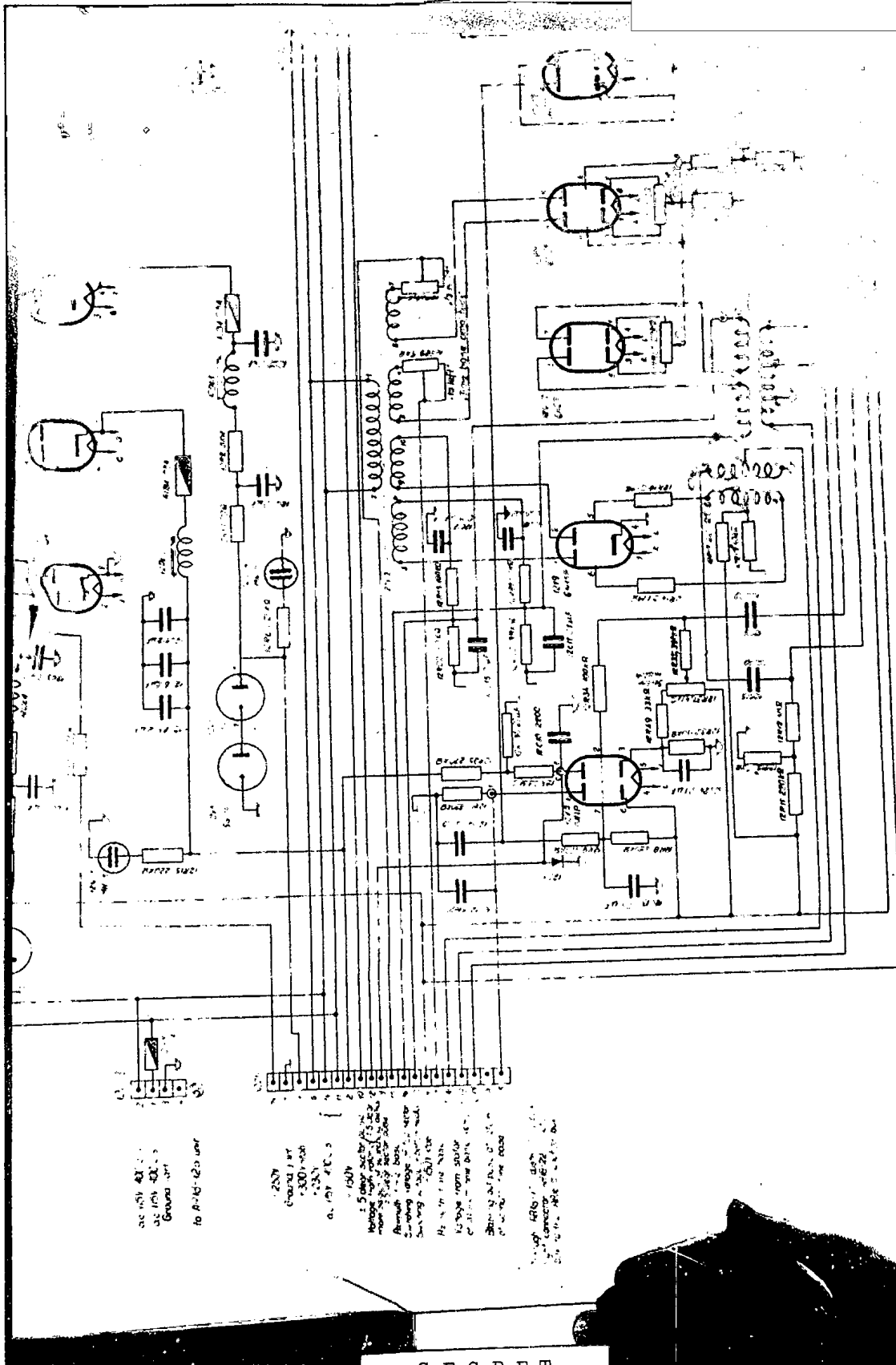

S-E-C-R-E-T

NO FOREIGN DISSEM

Notes:
1. All IC's are matched with 100%
2. All IC's are out of 500K class ...

19

S-E-C-R-E-T
NO FOREIGN DISSEM

50X1

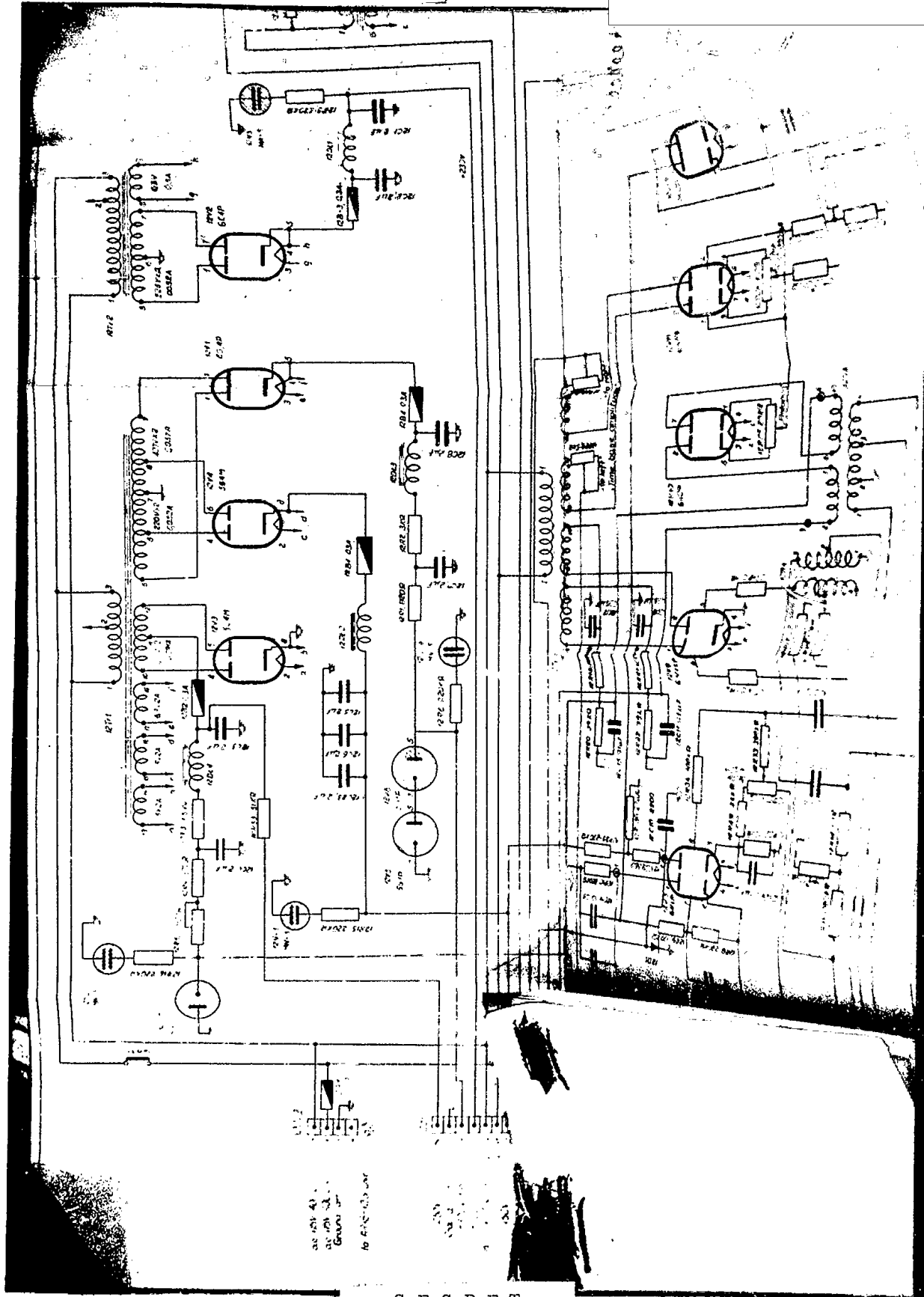

S-E-C-R-E-T

NO FOREIGN DISSEM

S-E-C-R-E-T
NO FOREIGN DISSEM



50X1

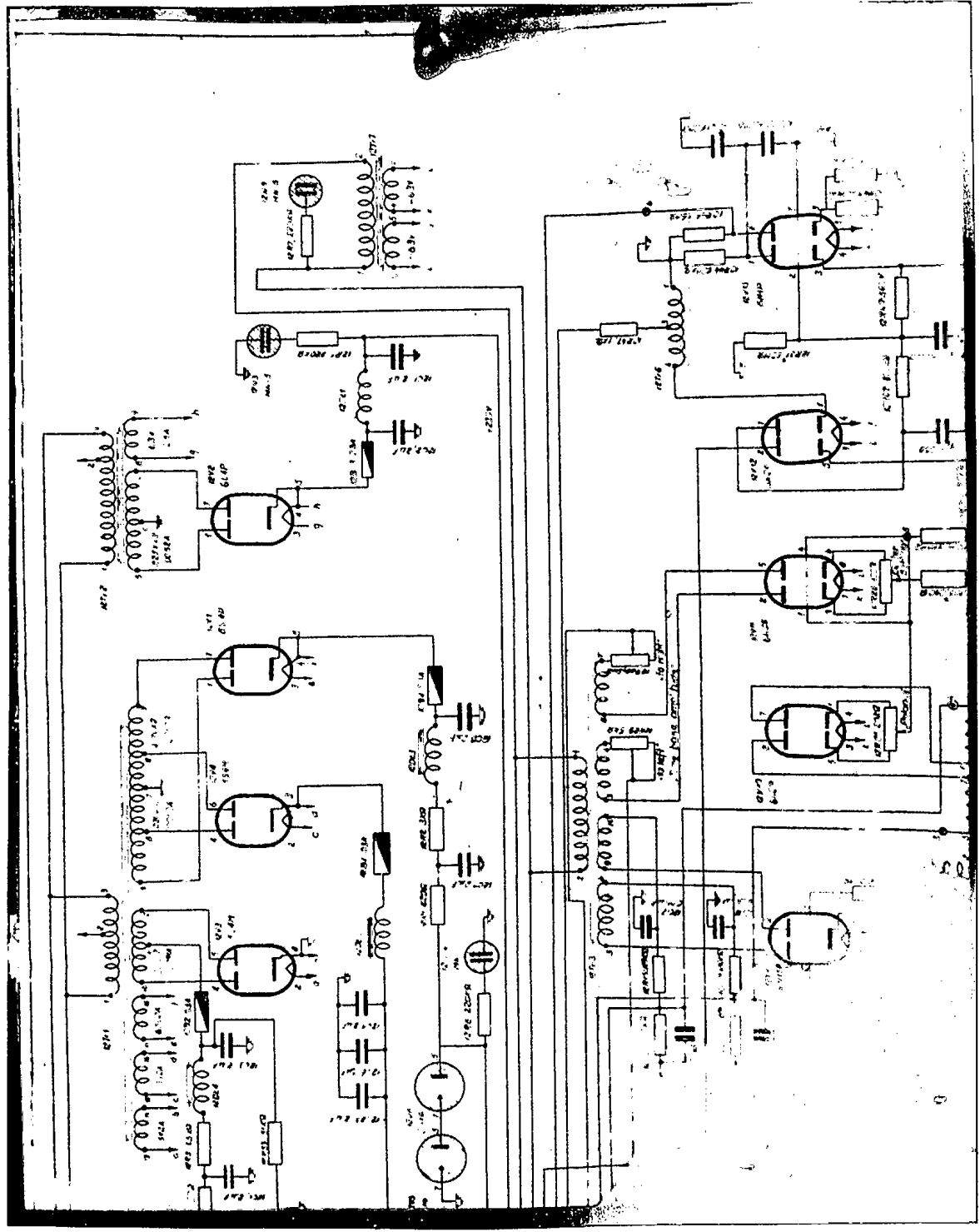

S-E-C-R-E-T
NO FOREIGN DISSEM

S-E-C-R-E-T
NO FOREIGN DISSEM



50X1

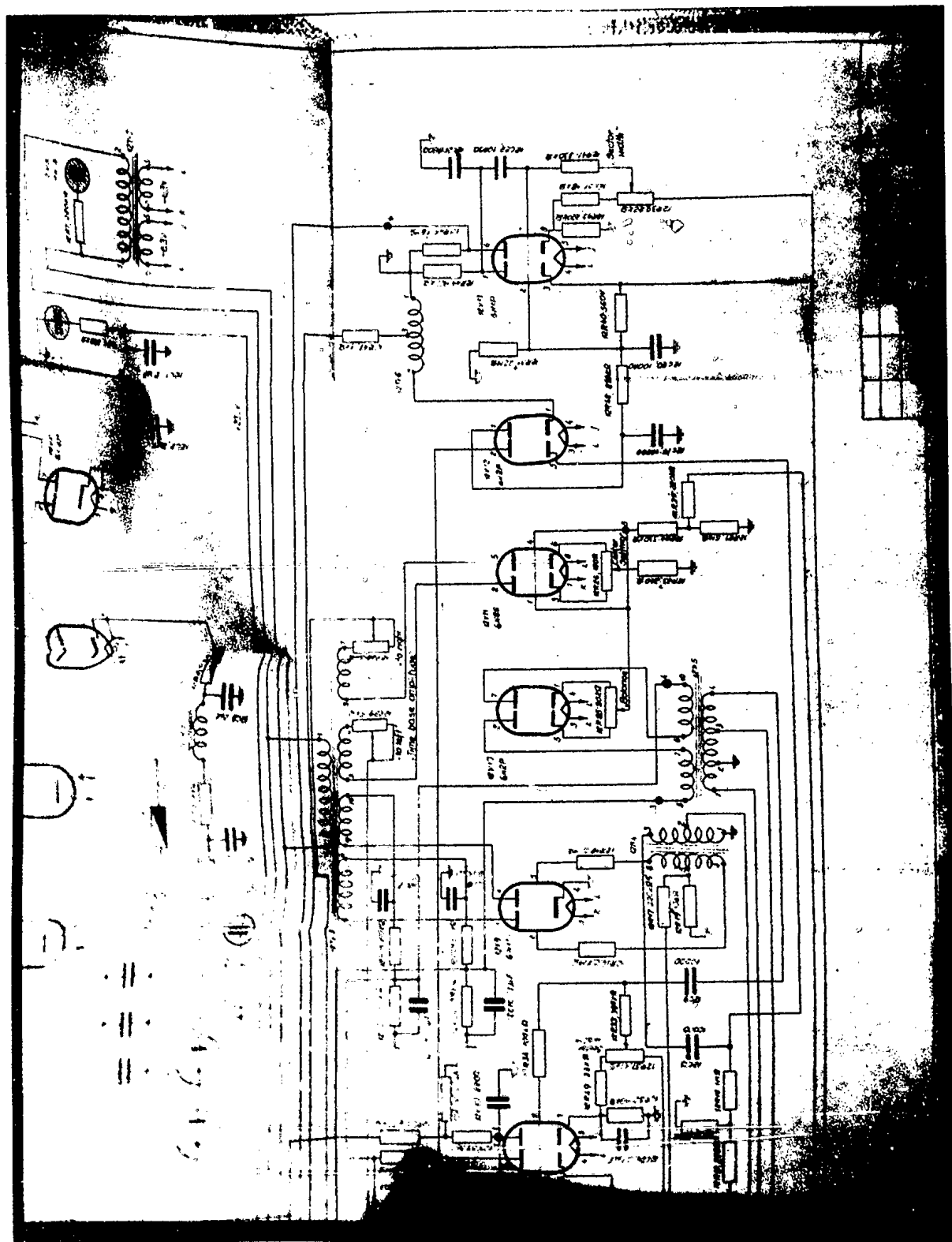

62

S-E-C-R-E-T
NO FOREIGN DISSEM

S-E-C-R-E-T
NO FOREIGN DISSEM

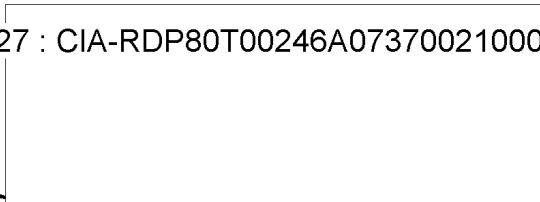

50X1

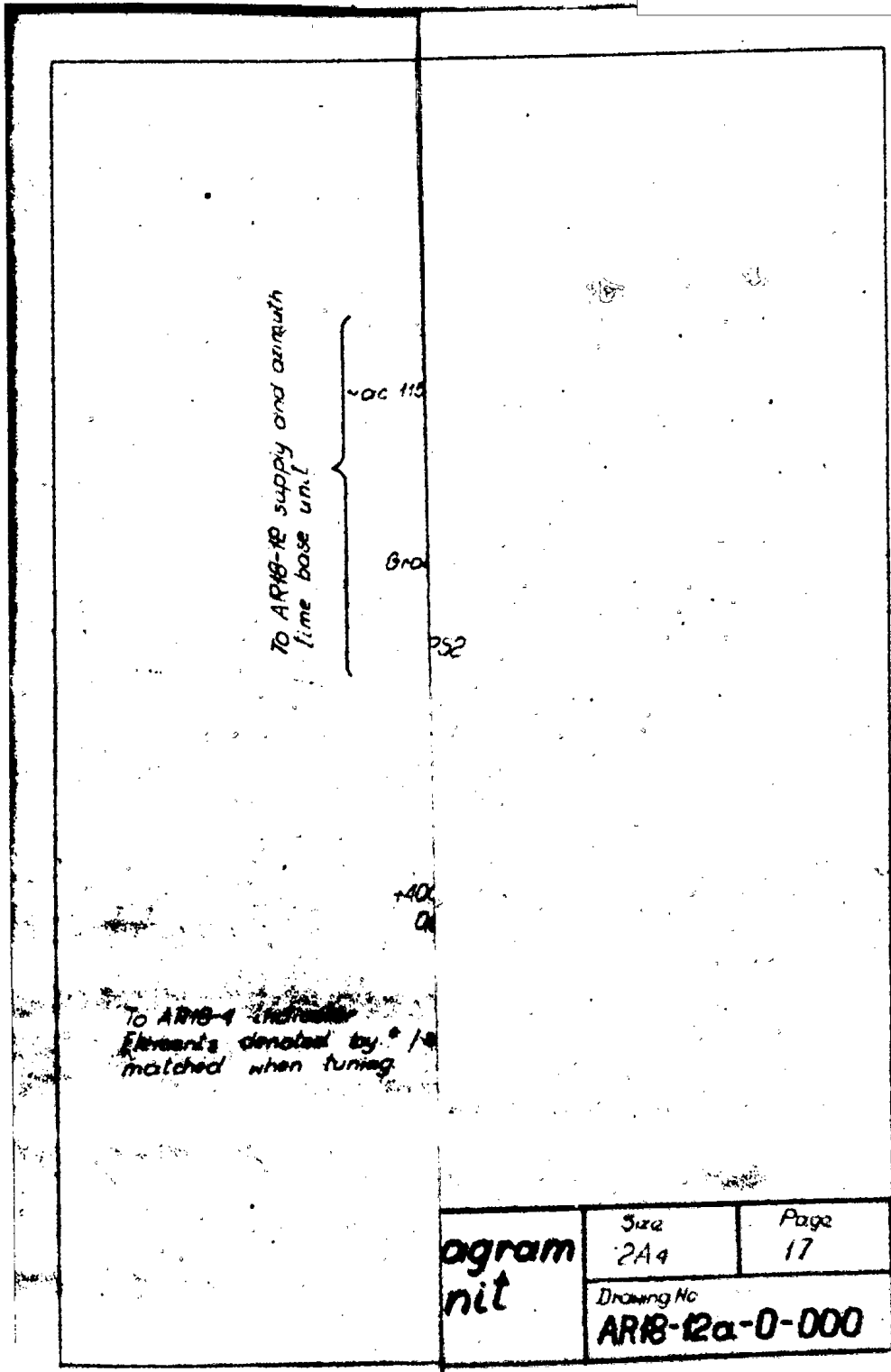

63

S-E-C-R-E-T
NO FOREIGN DISSEM

S-E-C-R-E-T
NO FOREIGN DISSEM



50X1

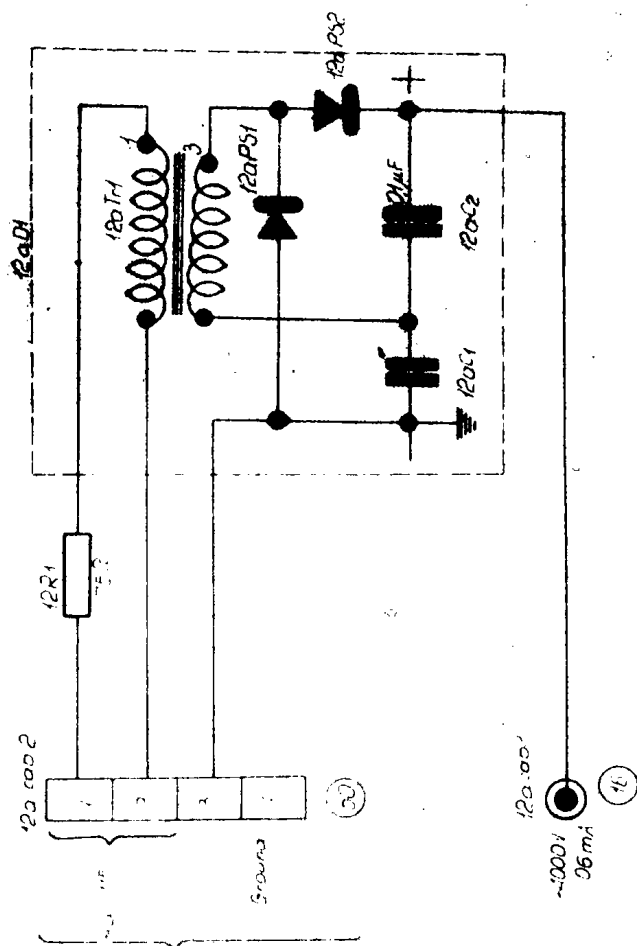

Handwritten notes at the bottom of the diagram, possibly indicating component values or assembly instructions.

42A-4 indicator
Elements enclosed by * / stars; are to be
maintained when tuning

Circuit diagram		Drawn	Page
of 42A unit		2A4	17
ARS-2a-3-000			

S-E-C-R-E-T

NO FOREIGN DISSEM

S-E-C-R-E-T
NO FOREIGN DISSEM

50X1

Circuit Diagram of
No. 14 Unit

AR18-14-0-000

65

S-E-C-R-E-T
NO FOREIGN DISSEM

S-E-C-R-E-T
NO FOREIGN DISSEM



50X1

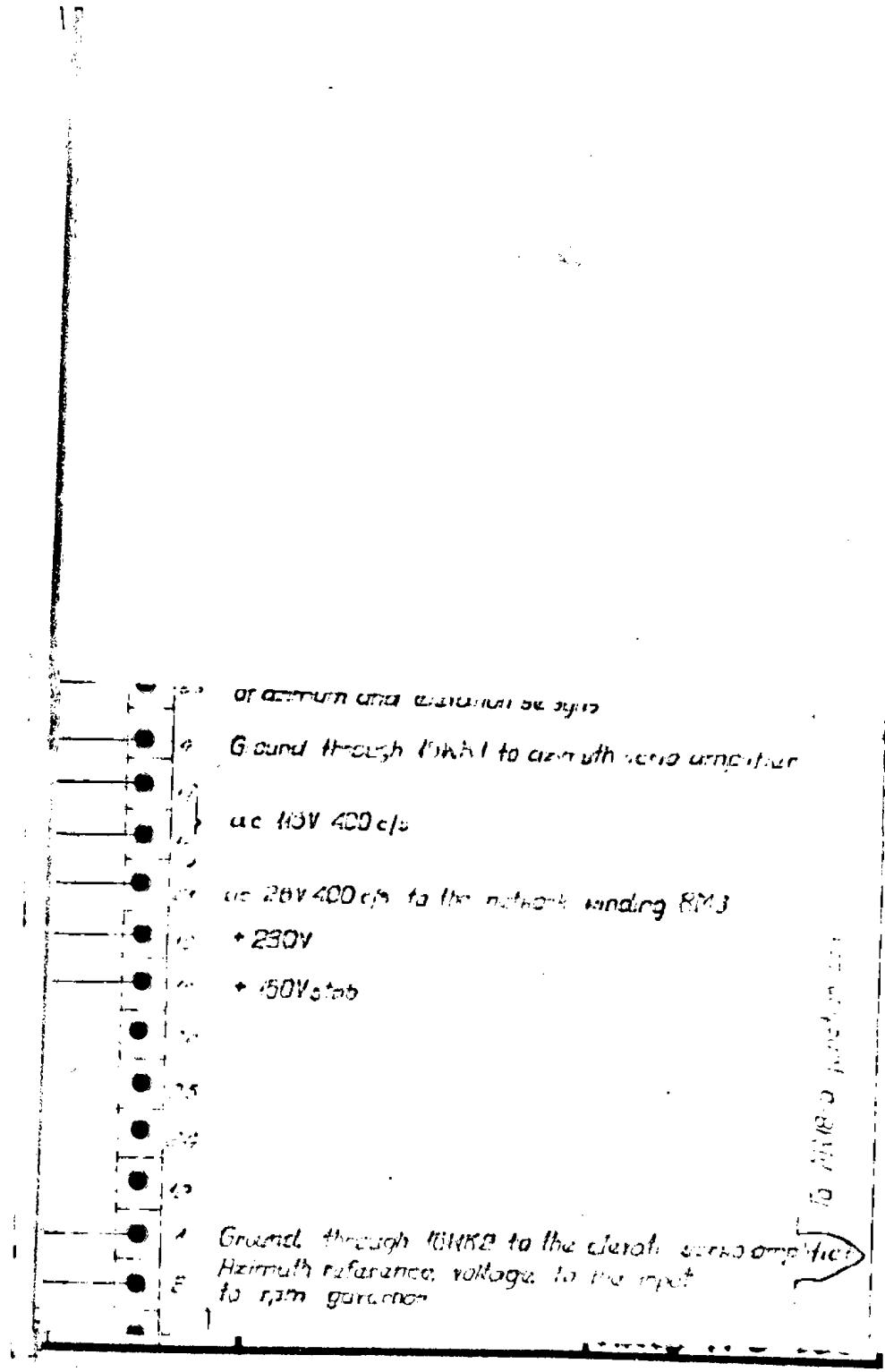

66

S-E-C-R-E-T
NO FOREIGN DISSEM

S-E-C-R-E-T
NO FOREIGN DISSEM



50X1

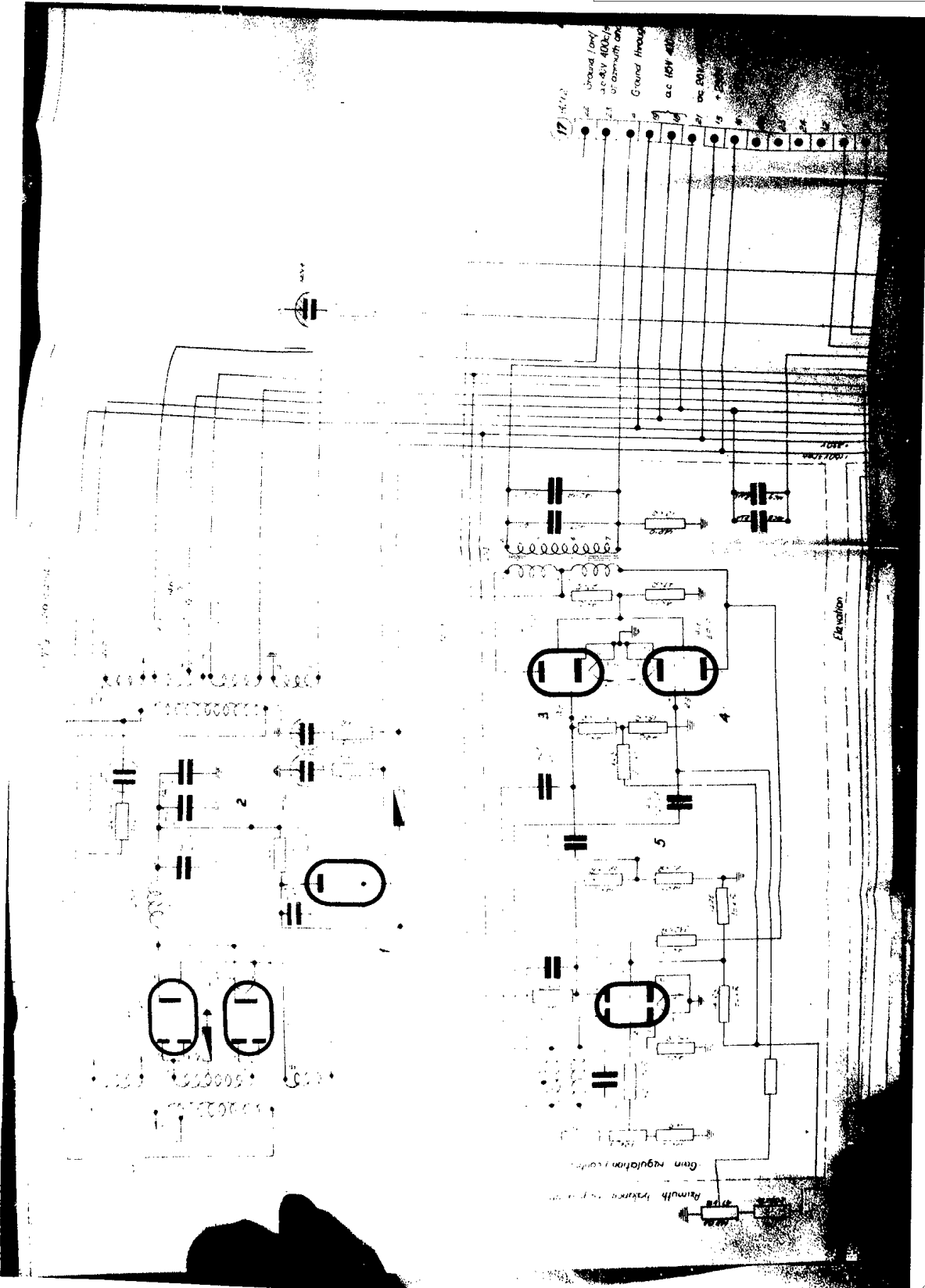

S-E-C-R-E-T

NO FOREIGN DISSEM

S-E-C-R-E-T
NO FOREIGN DISSEM

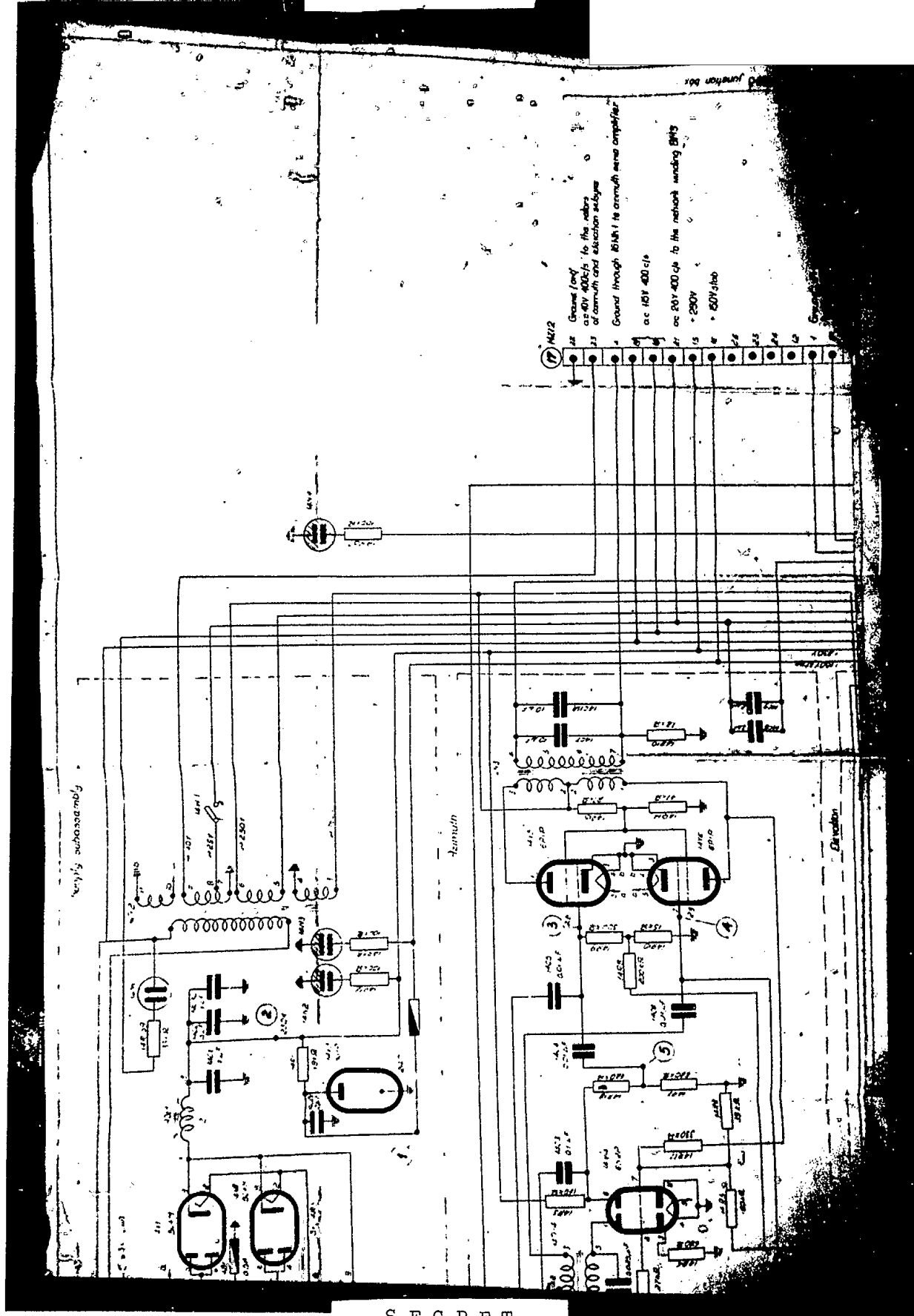

50X1

S-E-C-R-E-T
NO FOREIGN DISSEM

S-E-C-R-E-T
NO FOREIGN DISSEM

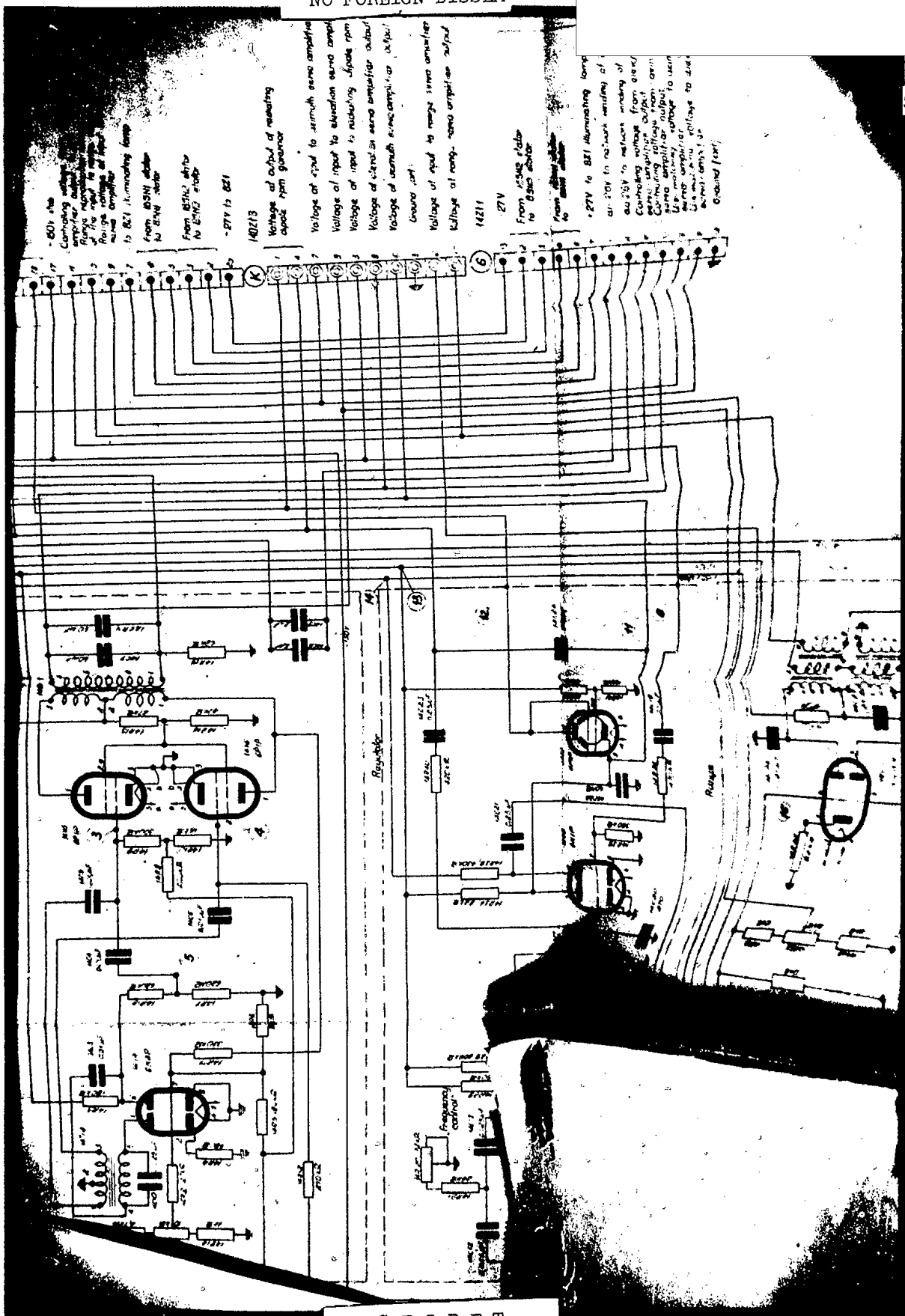

50X1

S-E-C-R-E-T
NO FOREIGN DISSEM

61

S-E-C-R-E-T
NO FOREIGN DISSEM

50X1

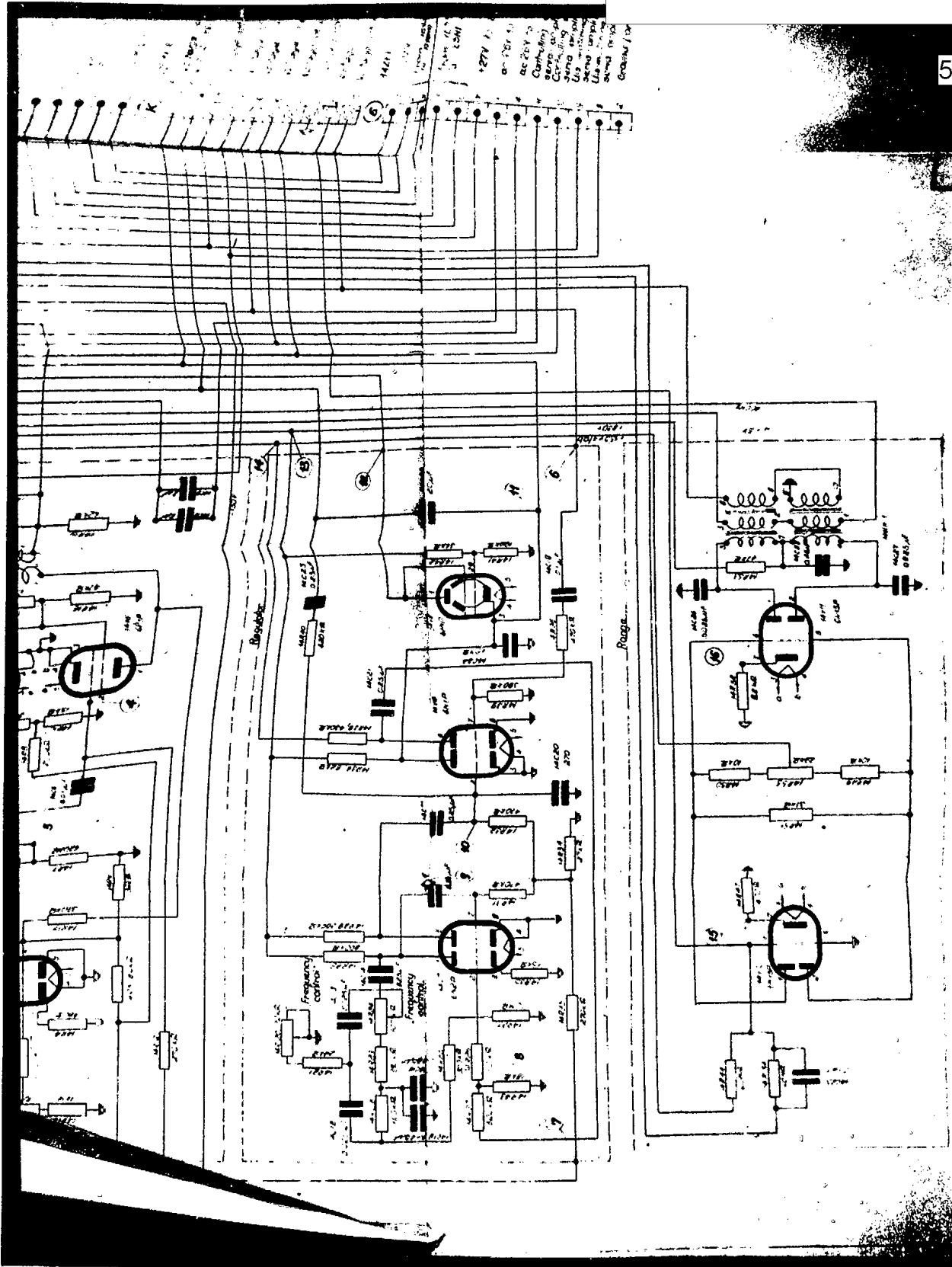

S-E-C-R-E-T

NO FOREIGN DISSEM

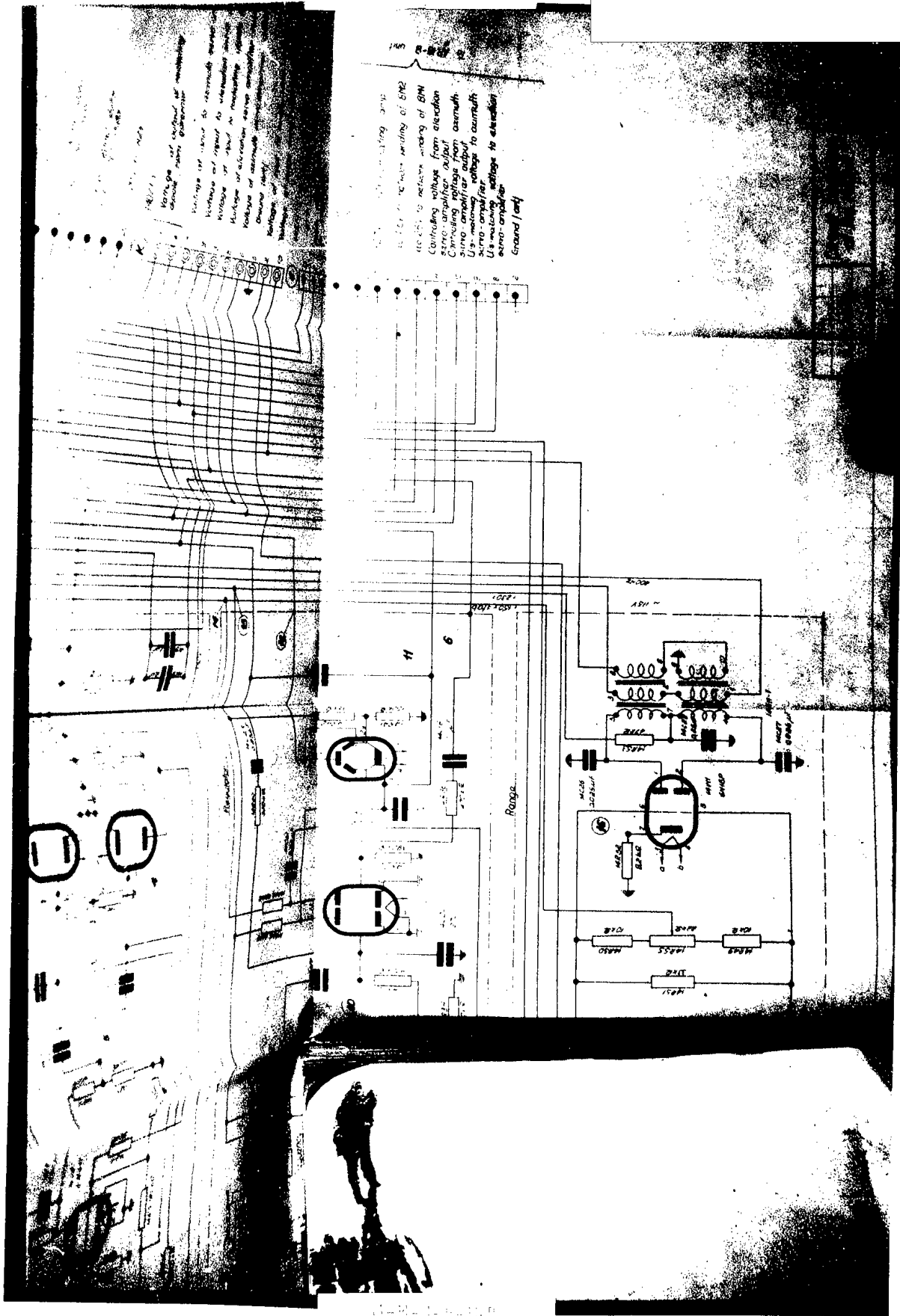

Handwritten notes:

- Voltage of output of measuring device, meter galvanometer
- Voltage of current in measuring device
- Voltage of current in measuring device
- Voltage of current in measuring device
- Voltage of current in measuring device
- Voltage of current in measuring device

Handwritten notes:

- Controlling voltage from excitation
- Control amplifier output
- Control amplifier output
- Control amplifier output
- Control amplifier output
- Control amplifier output

50X1

S-E-C-R-E-T
NO FOREIGN DISSEM



50X1

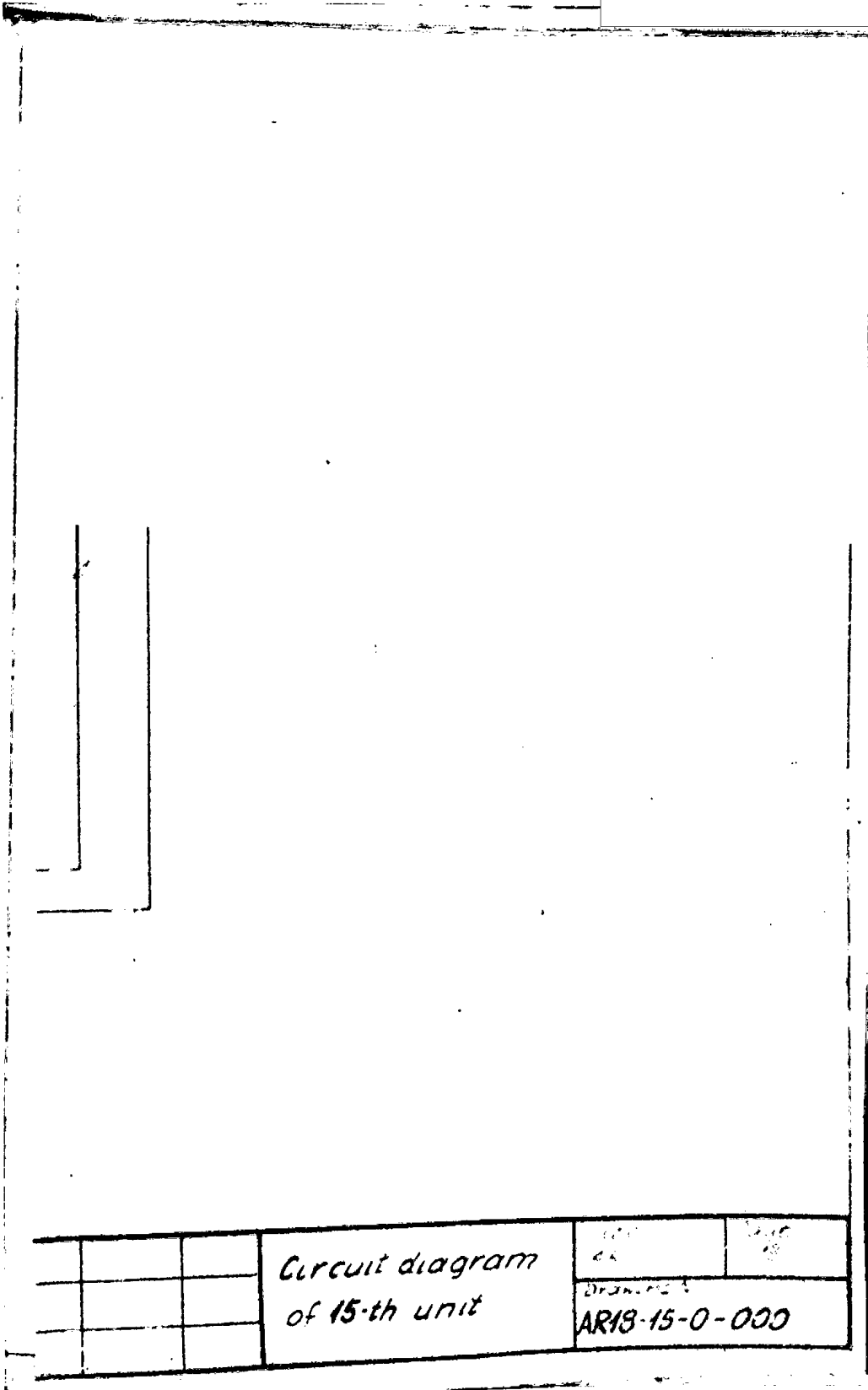

S-E-C-R-E-T
NO FOREIGN DISSEM

72

S-E-C-R-E-T
NO FOREIGN DISSEM

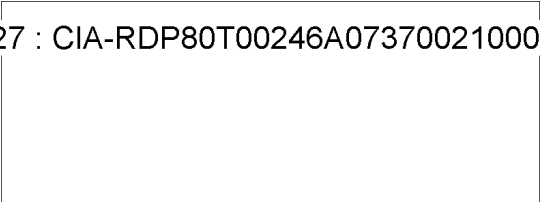

50X1

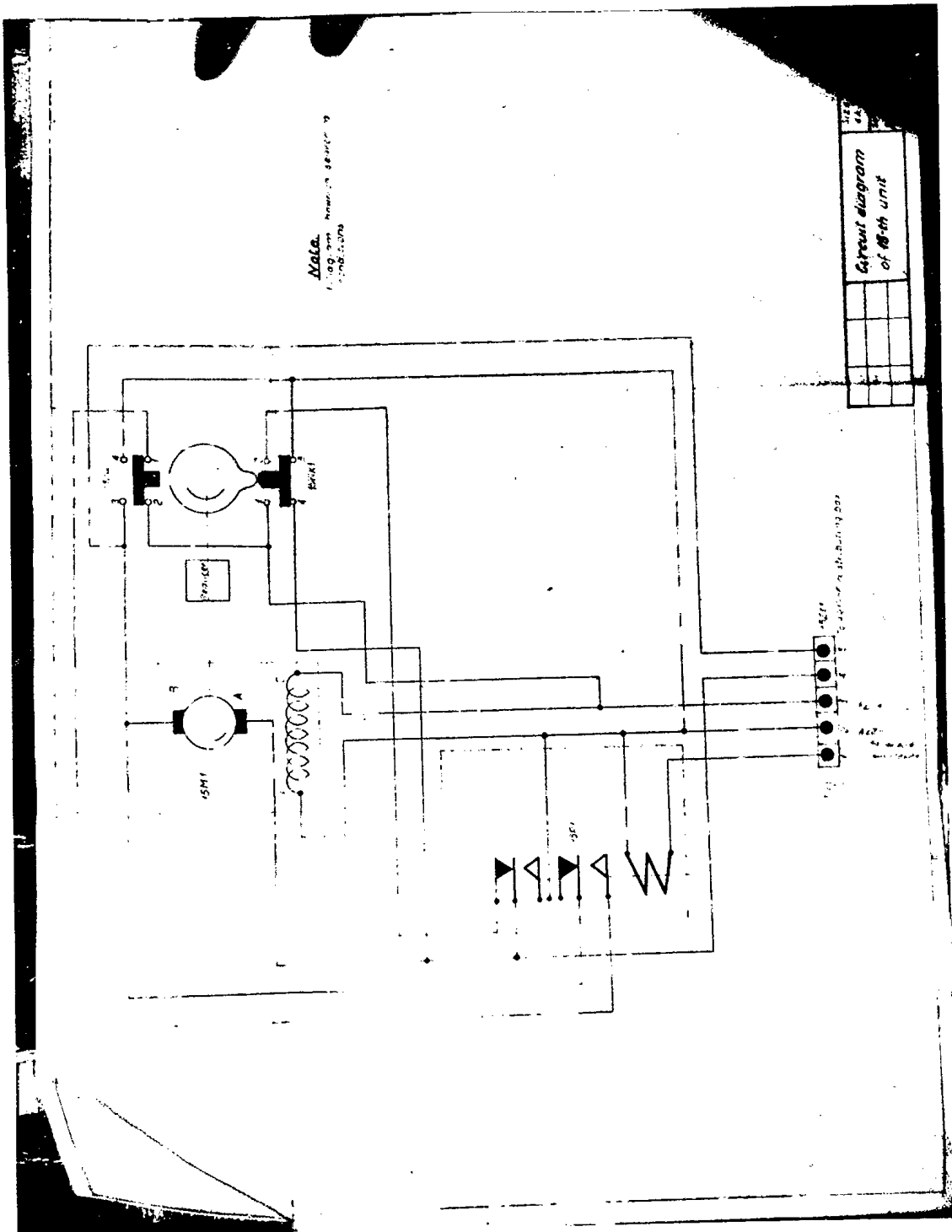

3

S-E-C-R-E-T

NO FOREIGN DISSEM

S-E-C-R-E-T
NO FOREIGN DISSEM

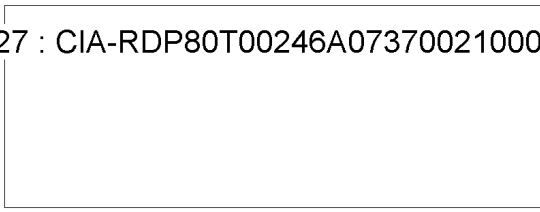

50X1

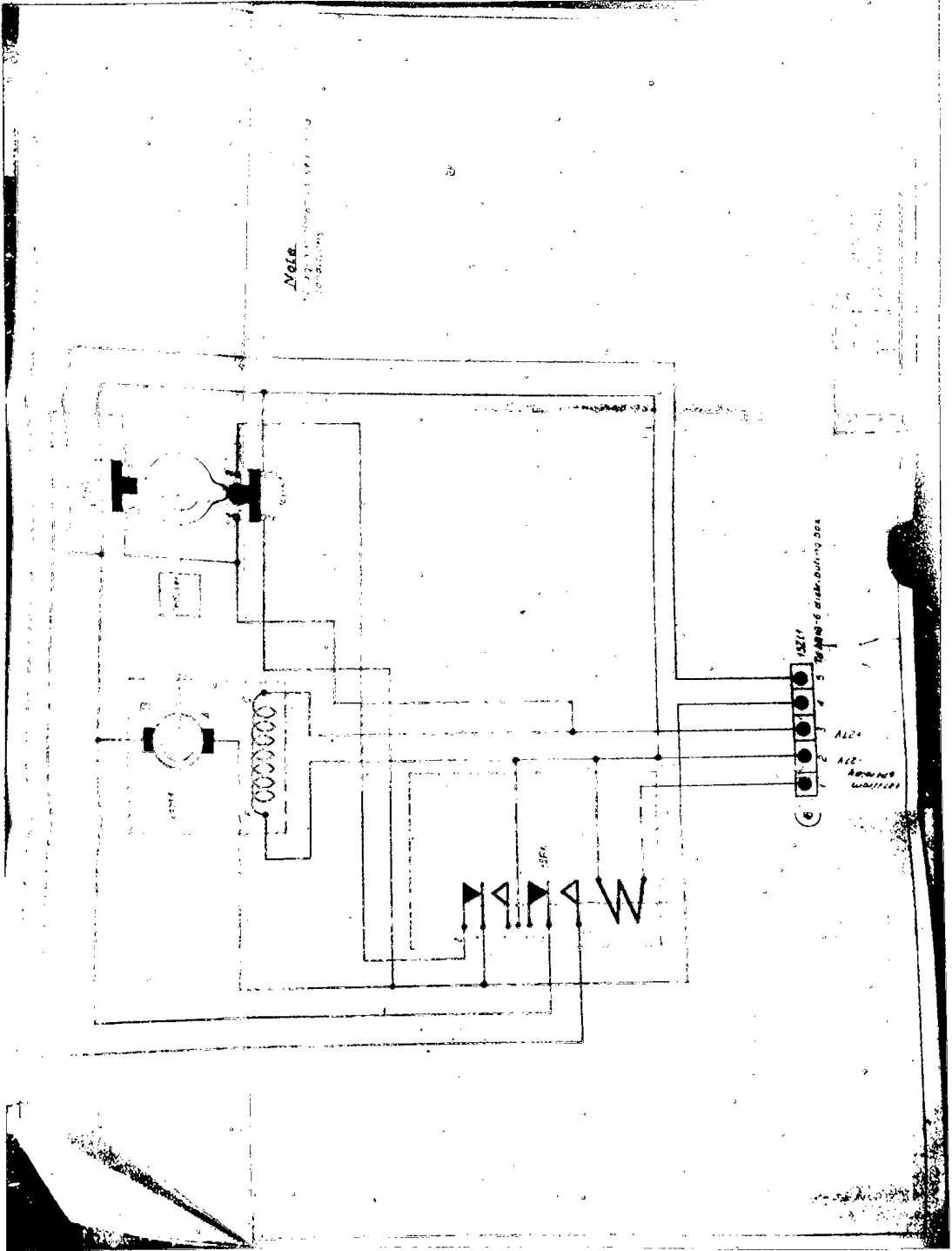

79

S-E-C-R-E-T
NO FOREIGN DISSEM

S-E-C-R-E-T
NO FOREIGN DISSEM

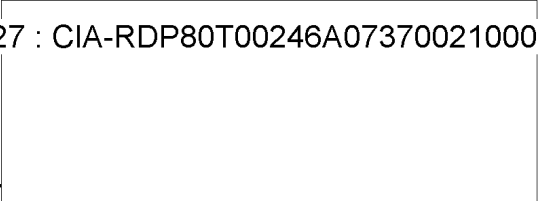

50X1

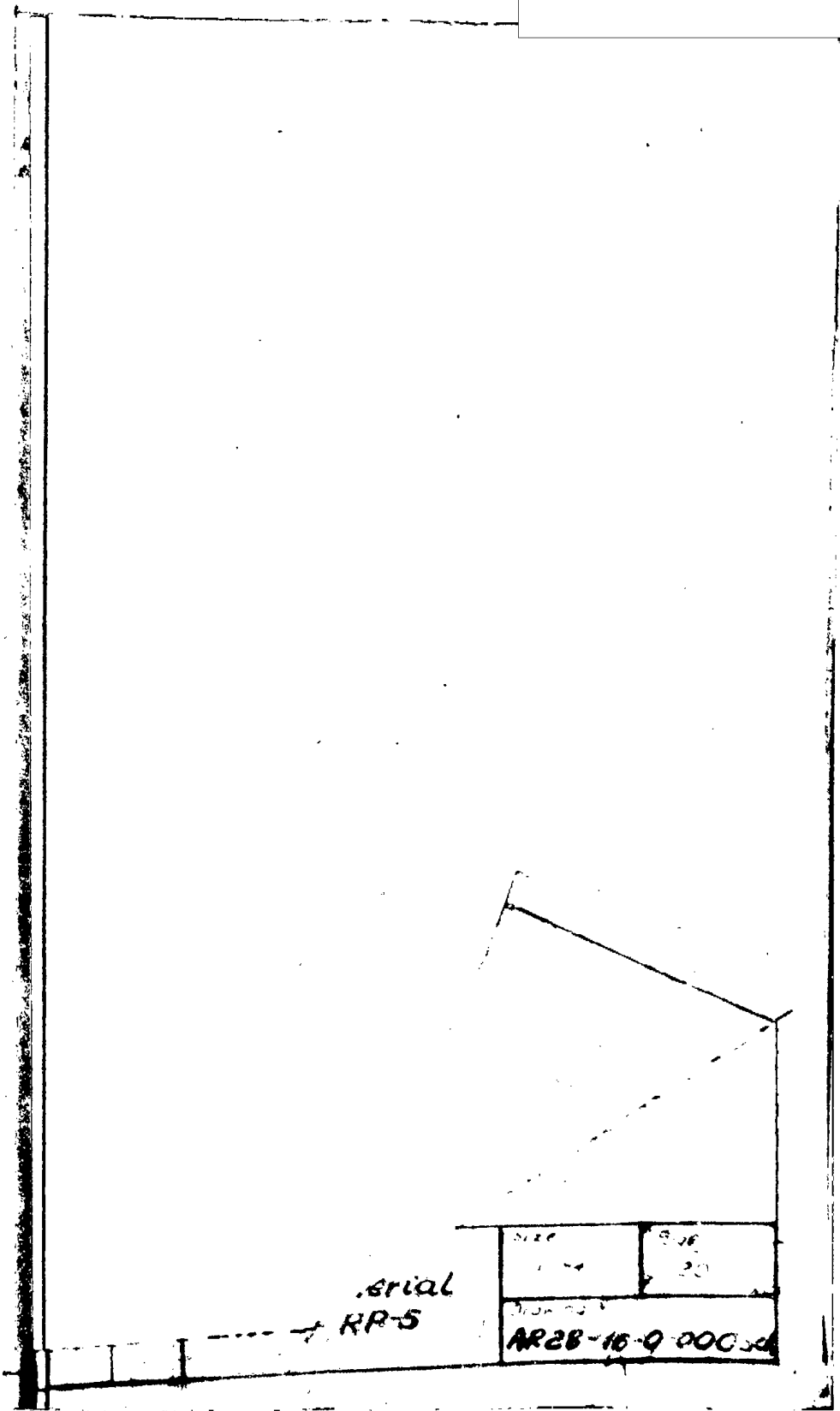

S-E-C-R-E-T
NO FOREIGN DISSEM

S-E-C-R-E-T
NO FOREIGN DISSEM

50X1

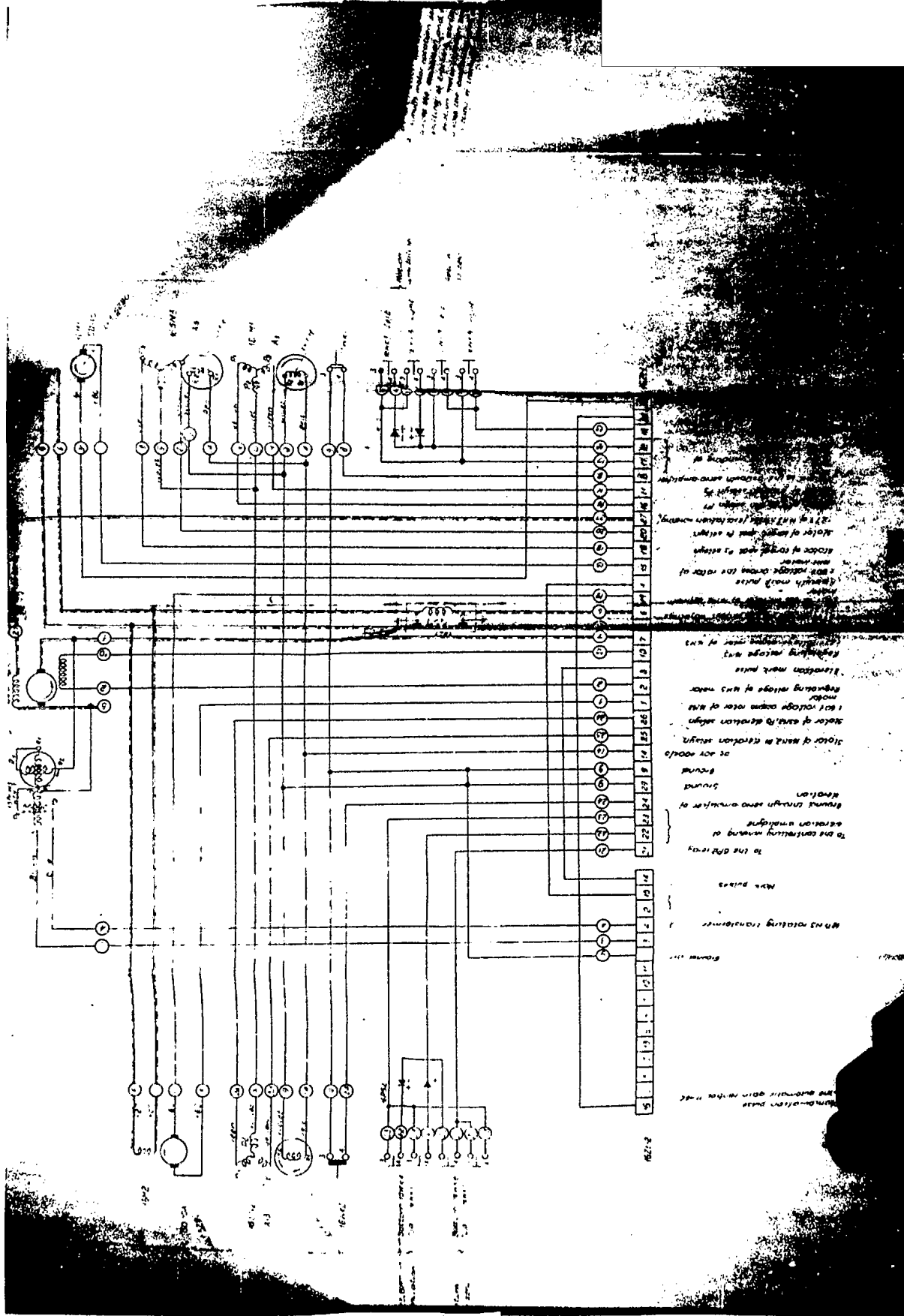

S-E-C-R-E-T

NO FOREIGN DISSEM

S-E-C-R-E-T
NO FOREIGN DISSEM

50X1

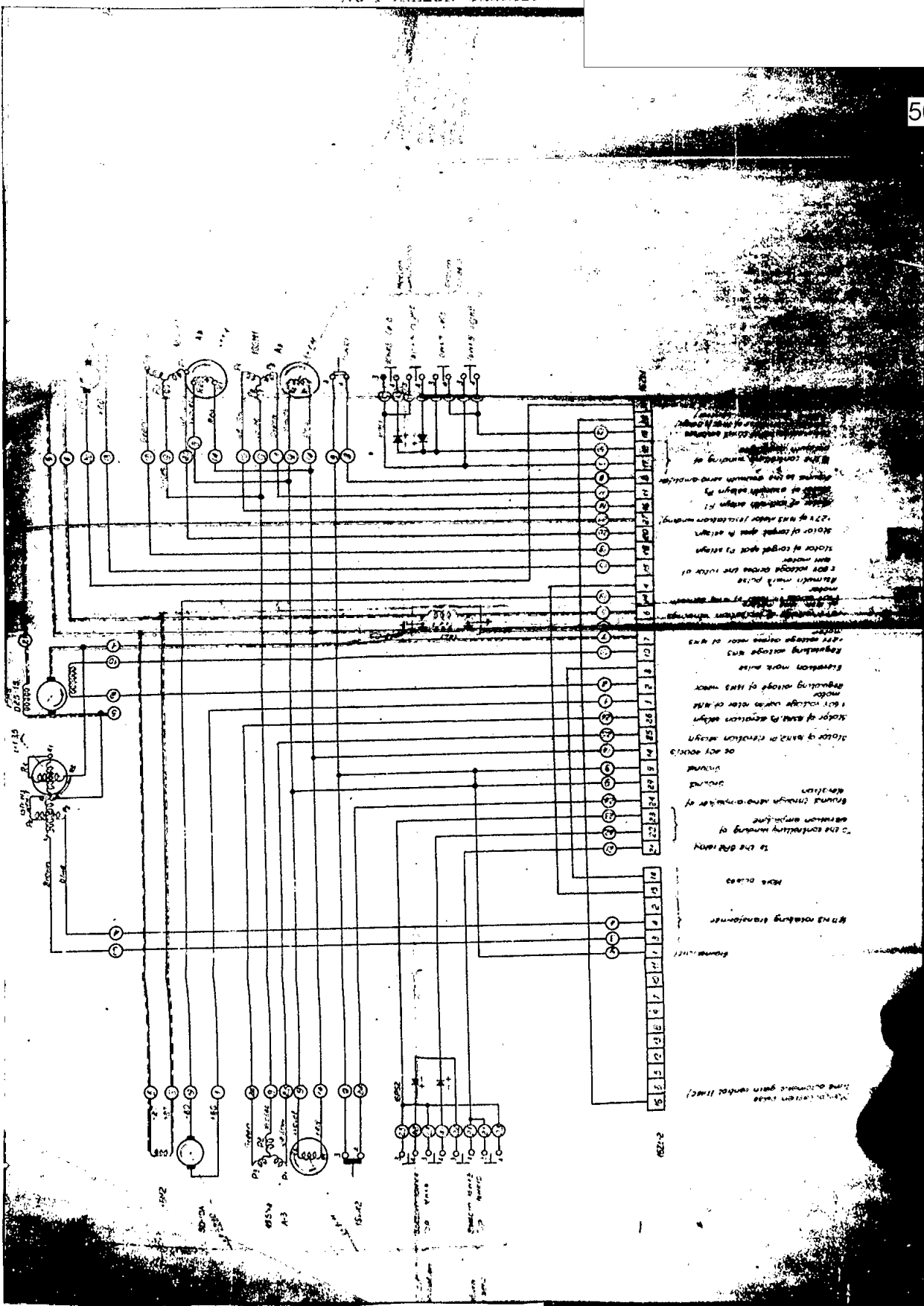

S-E-C-R-E-T

NO FOREIGN DISSEM

S-E-C-R-E-T
NO FOREIGN DISSEM

50X1

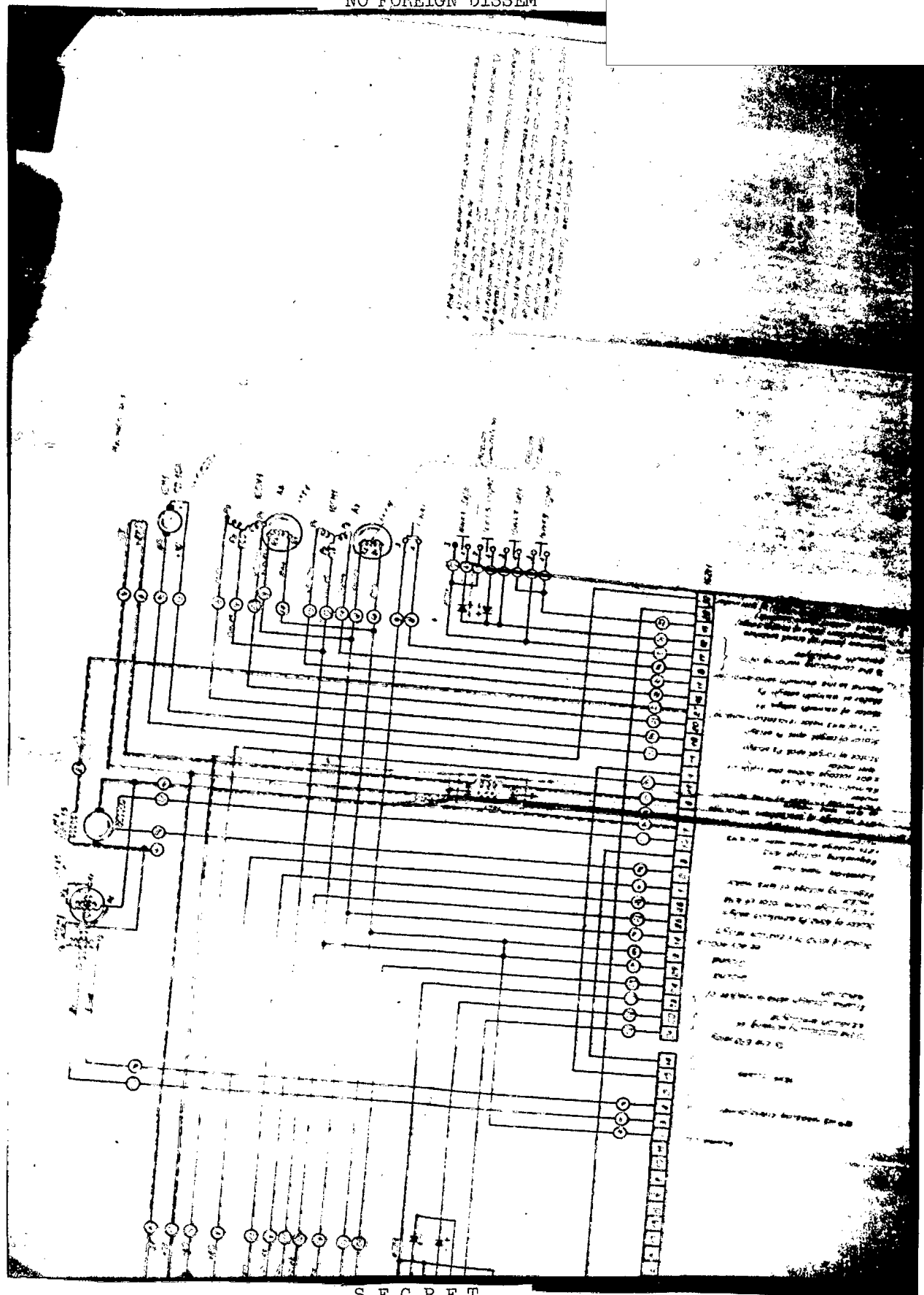

S-E-C-R-E-T

NO FOREIGN DISSEM

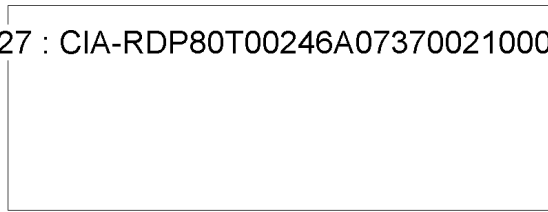

50X1

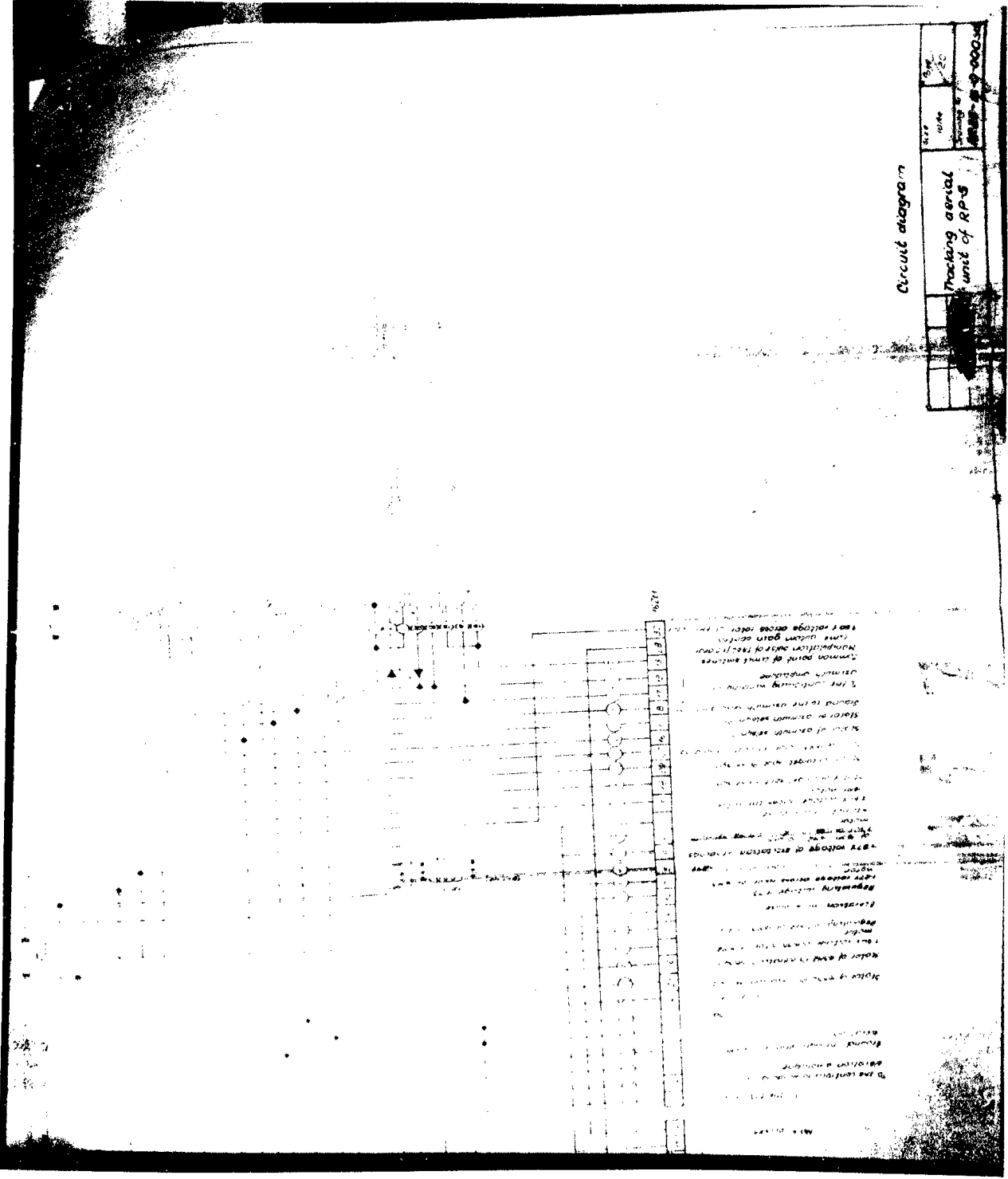

S-E-C-R-E-T
NO FOREIGN DISSEM

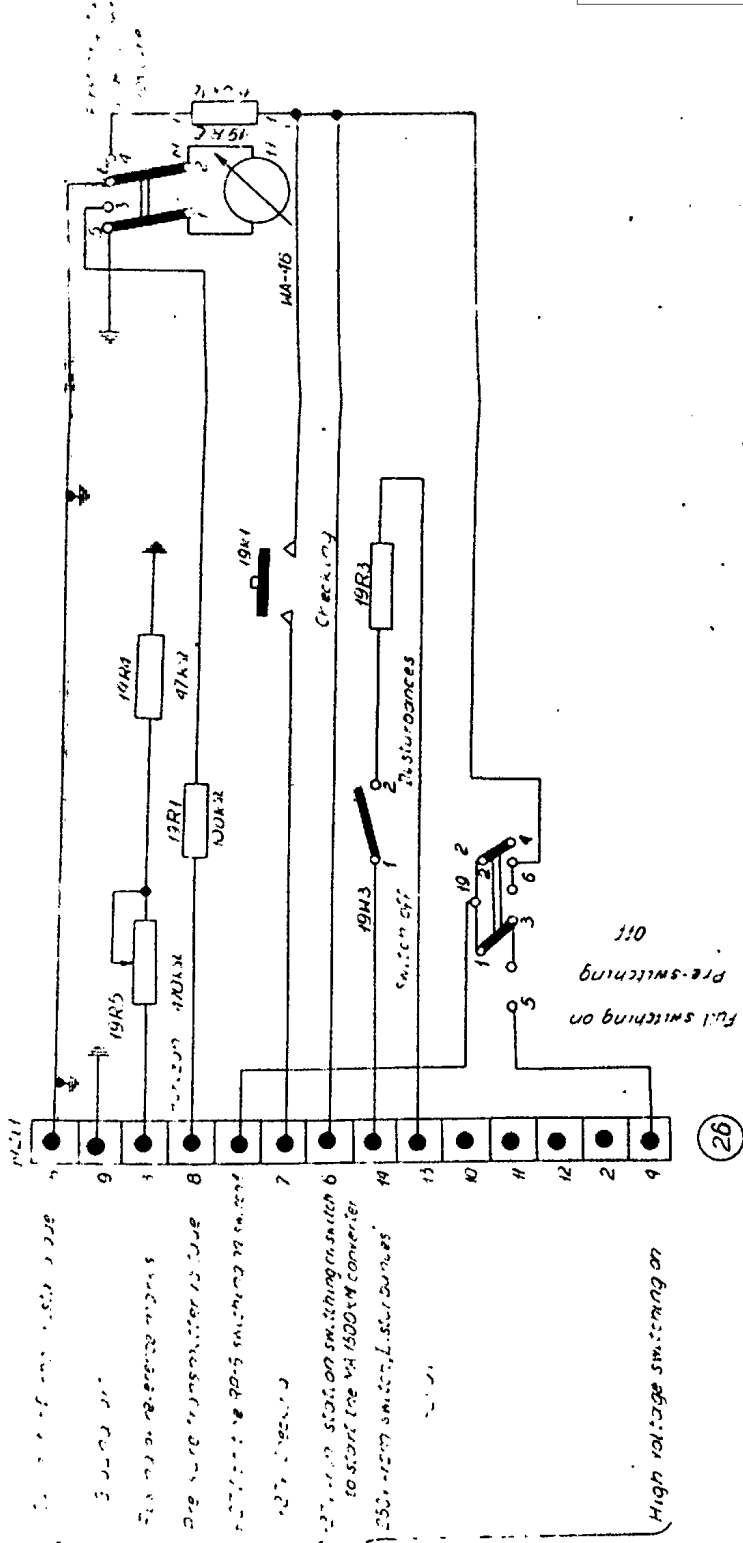

(26)

Size	20x	Age	21
Drawing No	WRB-19-0-C		
50X1			

Control panel

S-E-C-R-E-T

NO FOREIGN DISSEM

S-E-C-R-E-T
NO FOREIGN DISSEM



50X1

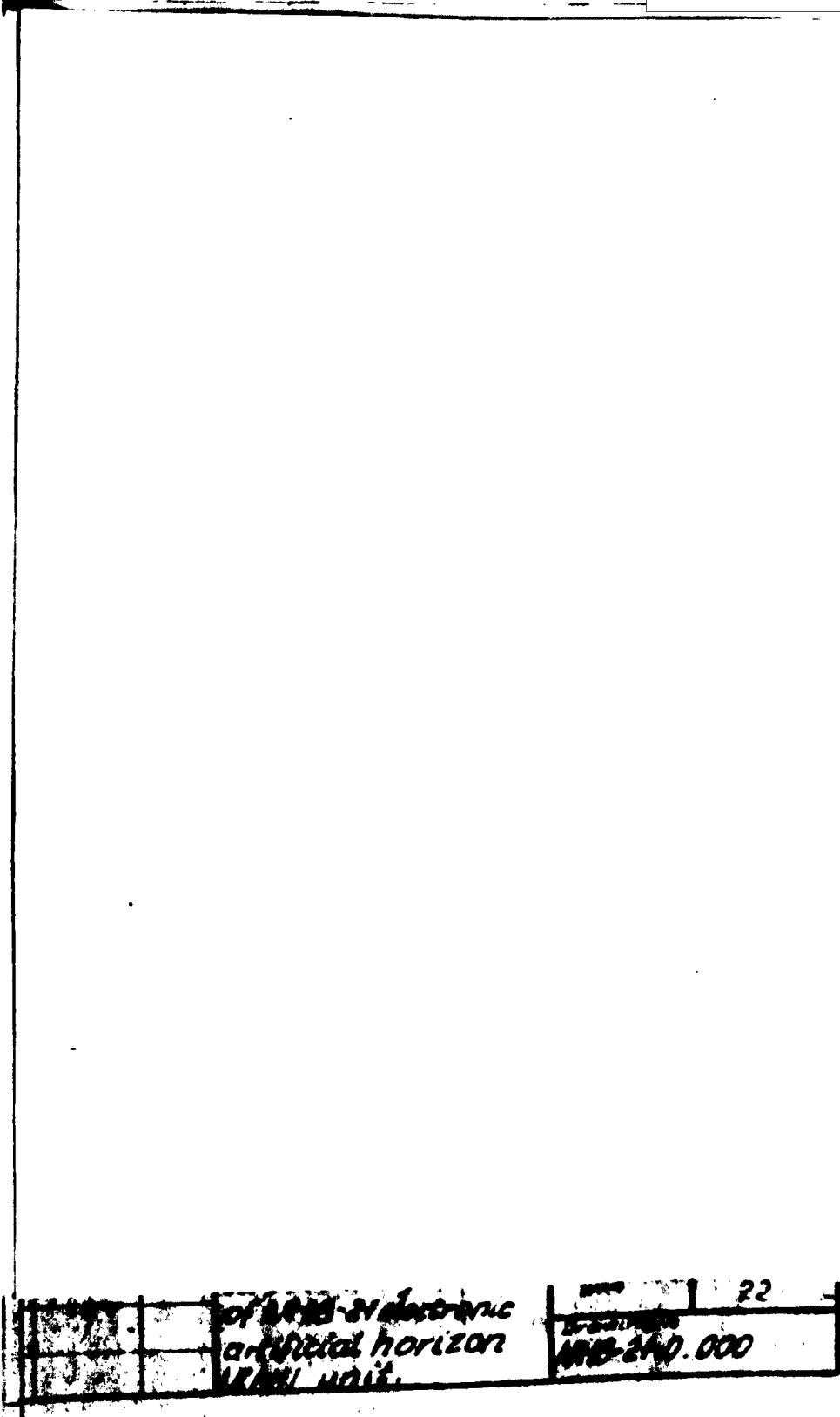

*of 2000-21 electronic
artificial horizon
KRAI unit.*

22
APR 240.000

S-E-C-R-E-T
NO FOREIGN DISSEM

S-E-C-R-E-T
NO FOREIGN DISSEM

50X1

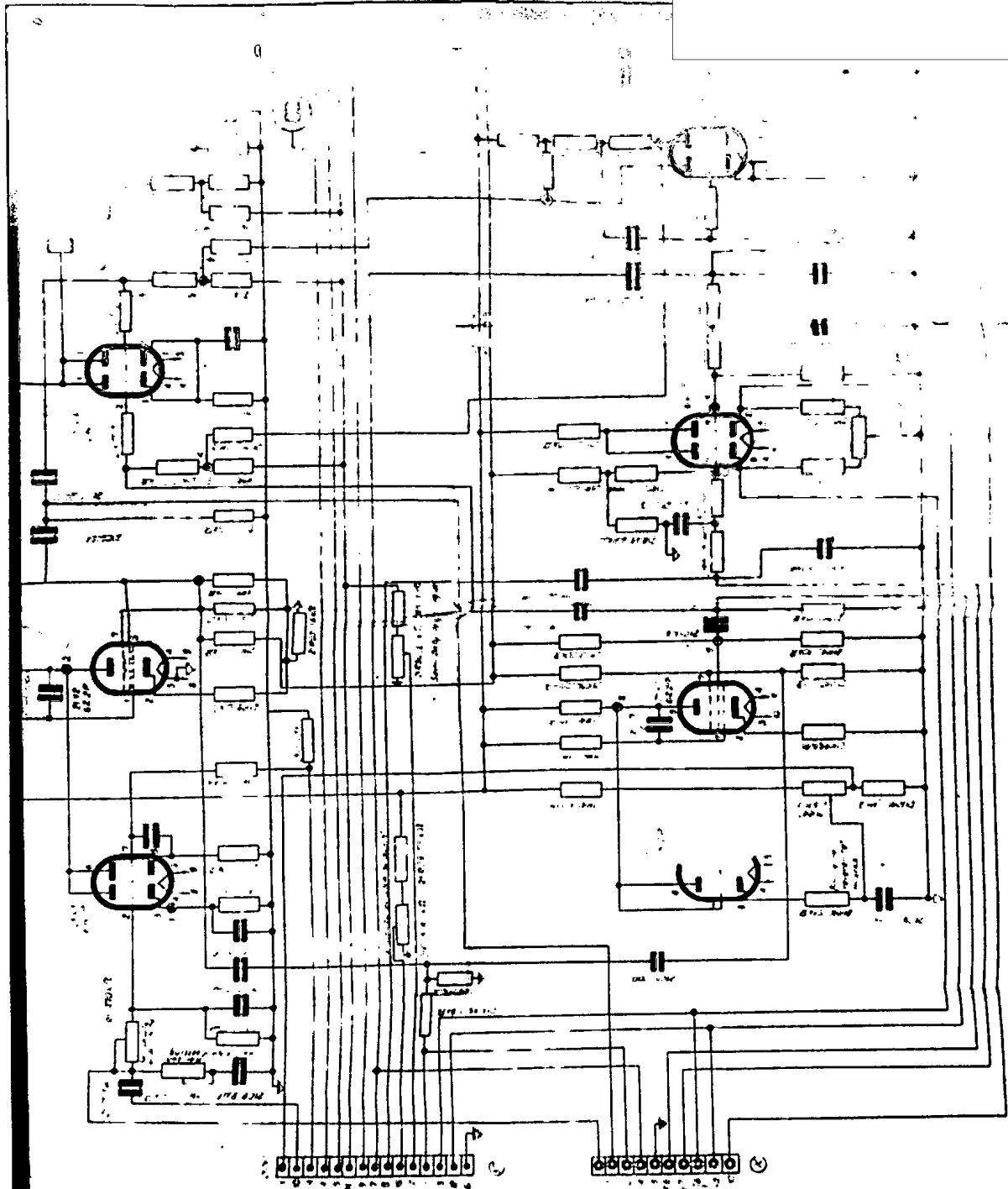

1. This circuit is designed to perform a specific cryptographic function.
 2. The vacuum tubes are connected in a push-pull configuration.
 3. The control panel allows for manual operation and monitoring.
 4. The circuit is powered by a 100V AC source.
 5. The output is taken from the multi-pin connectors at the bottom.
 6. The circuit is designed for high reliability and security.
 7. The components are of high quality and are carefully selected.
 8. The circuit is tested thoroughly before use.
 9. The circuit is designed to be easily maintained.
 10. The circuit is designed to be easily repaired.

MoC

82

S-E-C-R-E-T
NO FOREIGN DISSEM



50X1

S-E-C-R-E-T
NO FOREIGN DISSEM

50X1

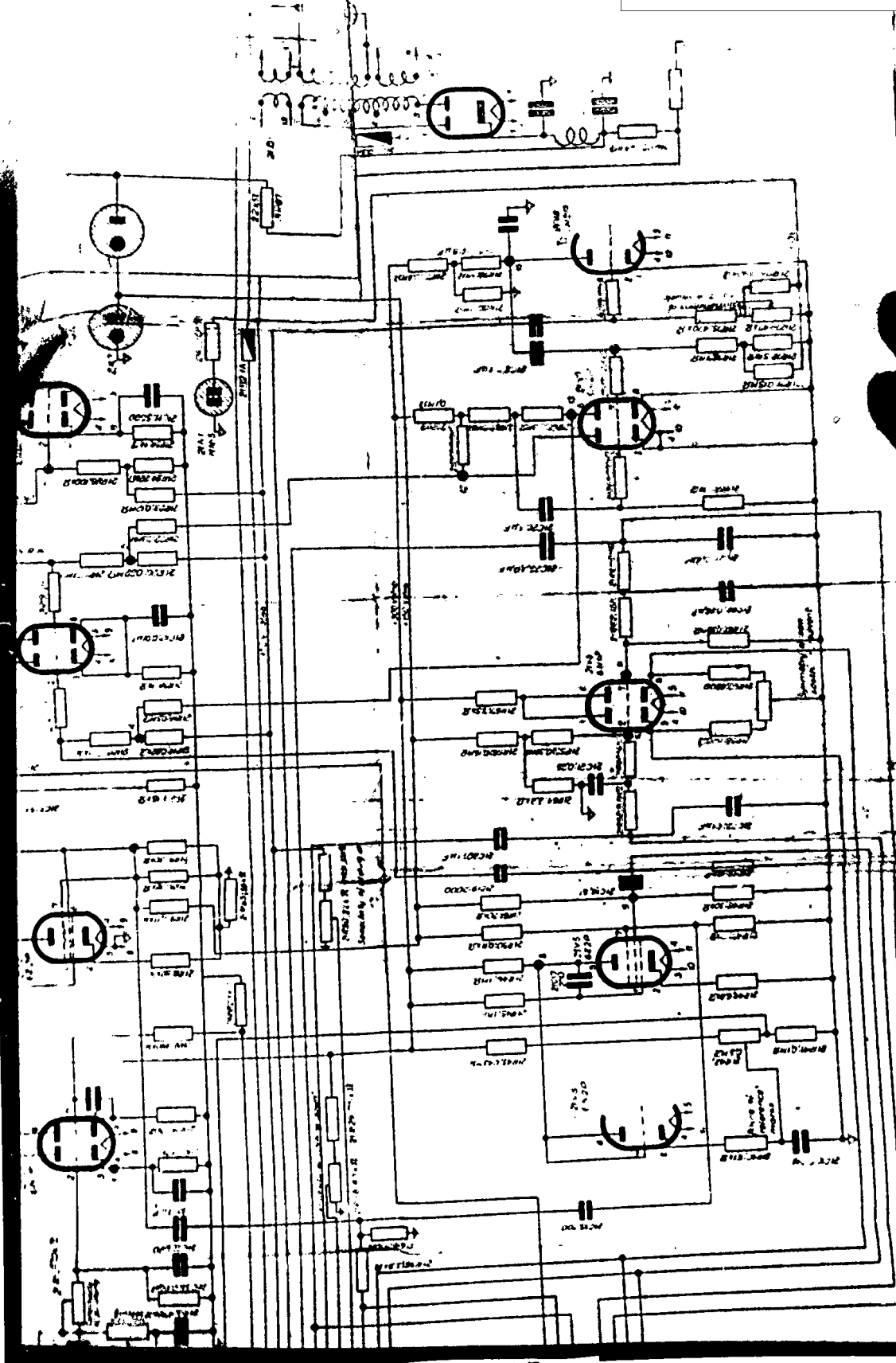

Original Diagram
 of 6BE6 and 6AV6
 for 50X1
 J. C. ...
 ...
 ...

S-E-C-R-E-T

NO FOREIGN DISSEM

S-E-C-R-E-T
NO FOREIGN DISSEM

50X1

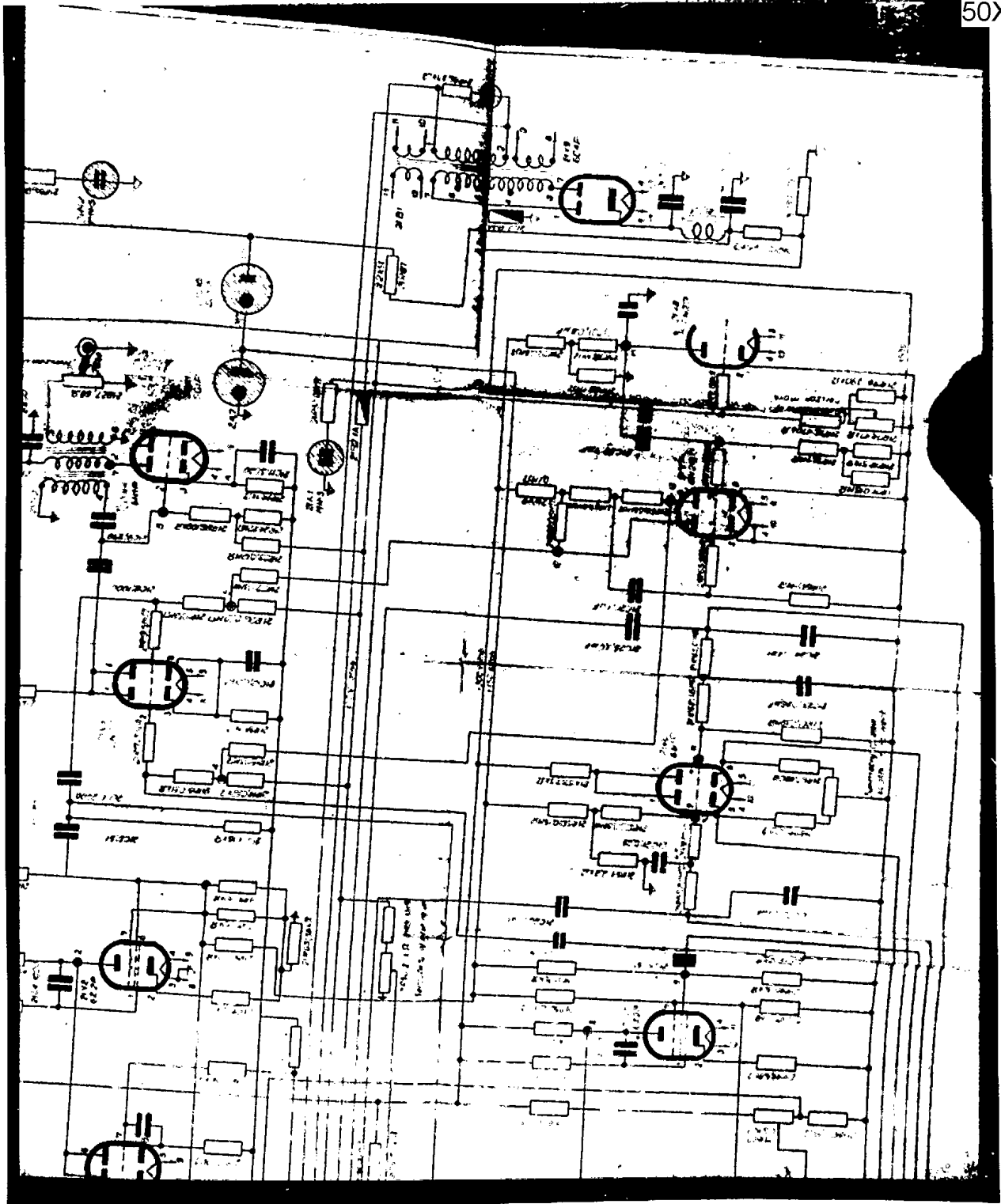

S-E-C-R-E-T
NO FOREIGN DISSEM

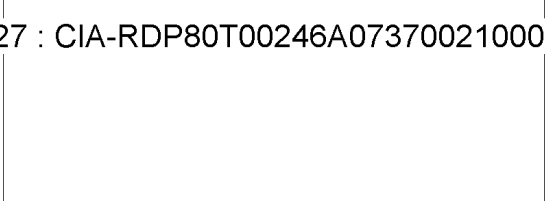

50X1

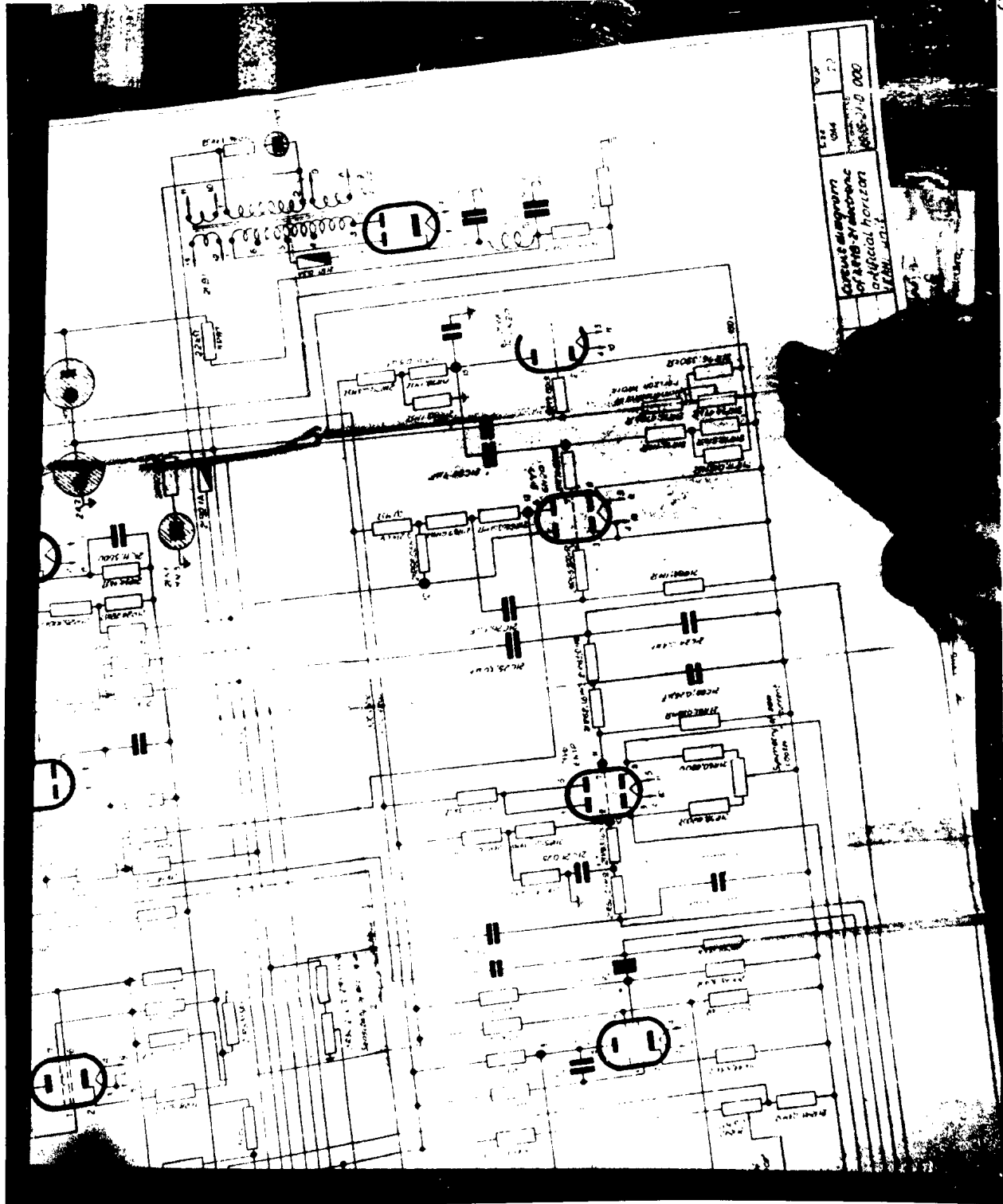

REV	1	2
DATE		
Output diagram of 1918-1919 horizontal official horizon		
V. B. B. 100		

S-E-C-R-E-T
NO FOREIGN DISSEM

50X1

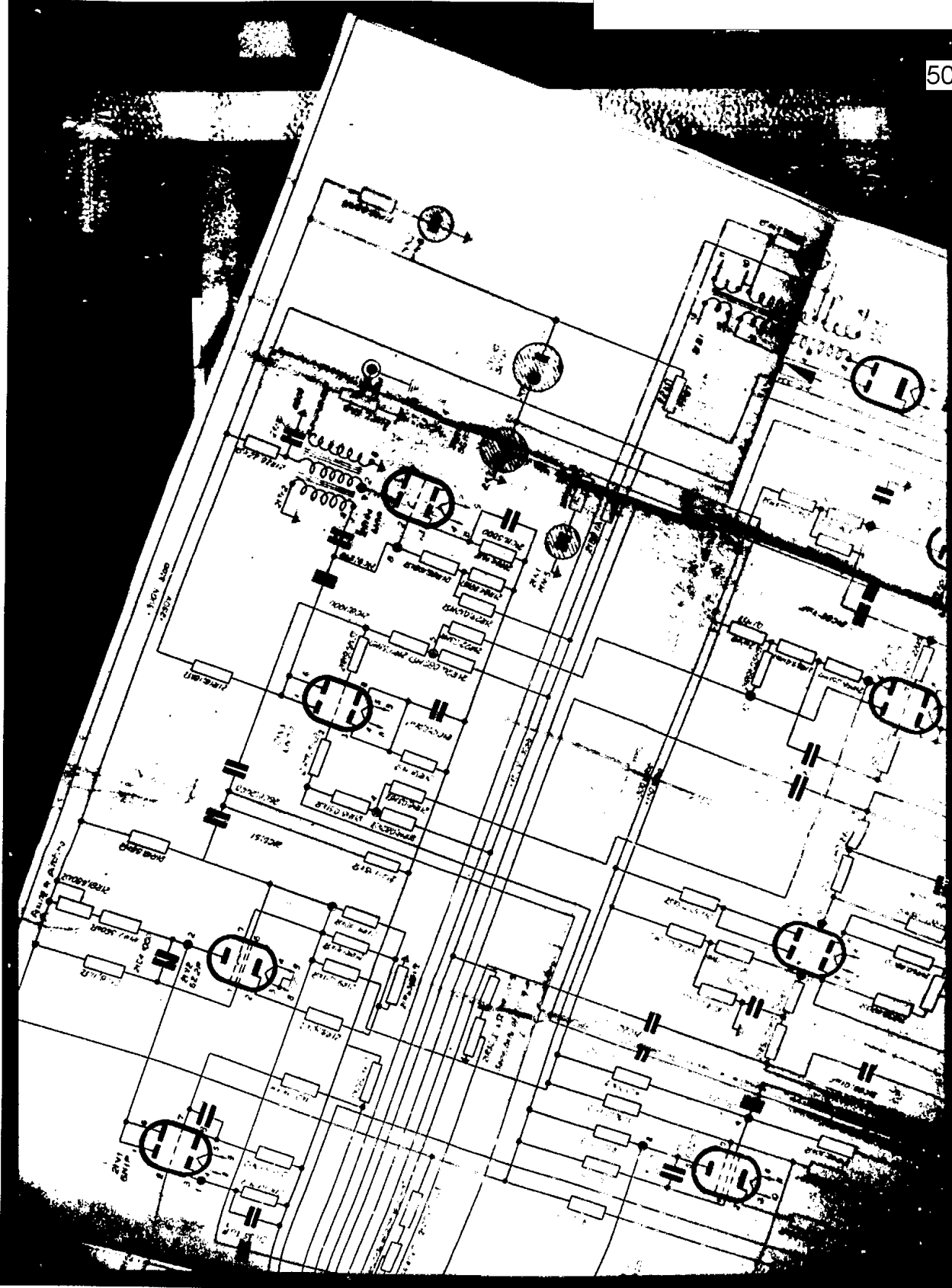

S-E-C-R-E-T

NO FOREIGN DISSEM

S-E-C-R-E-T
NO FOREIGN DISSEM

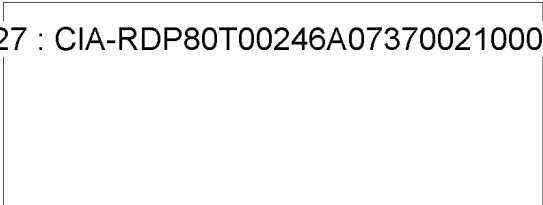

50X1

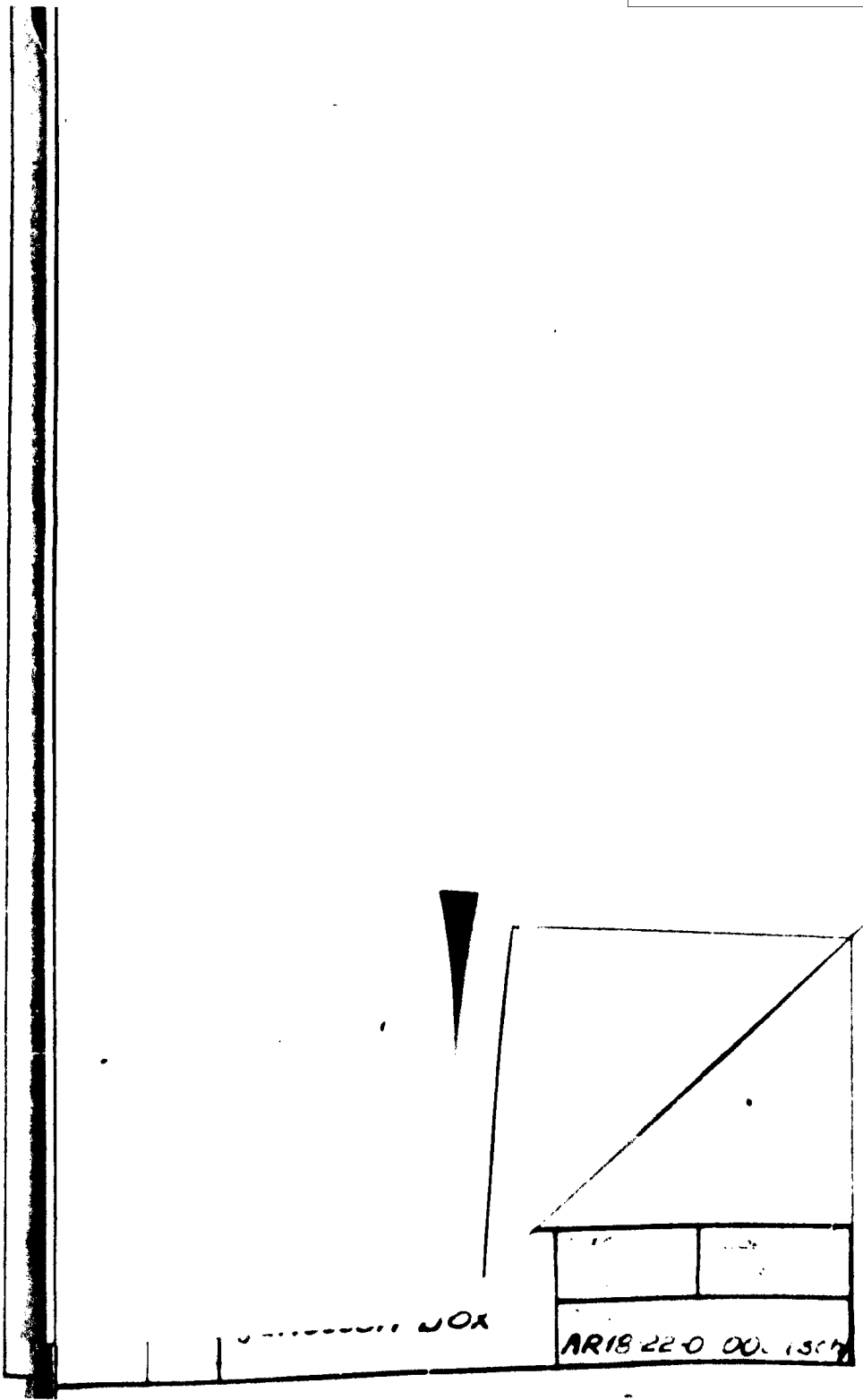

S-E-C-R-E-T
NO FOREIGN DISSEM

S-E-C-R-E-T
NO FOREIGN DISSEM

50X1

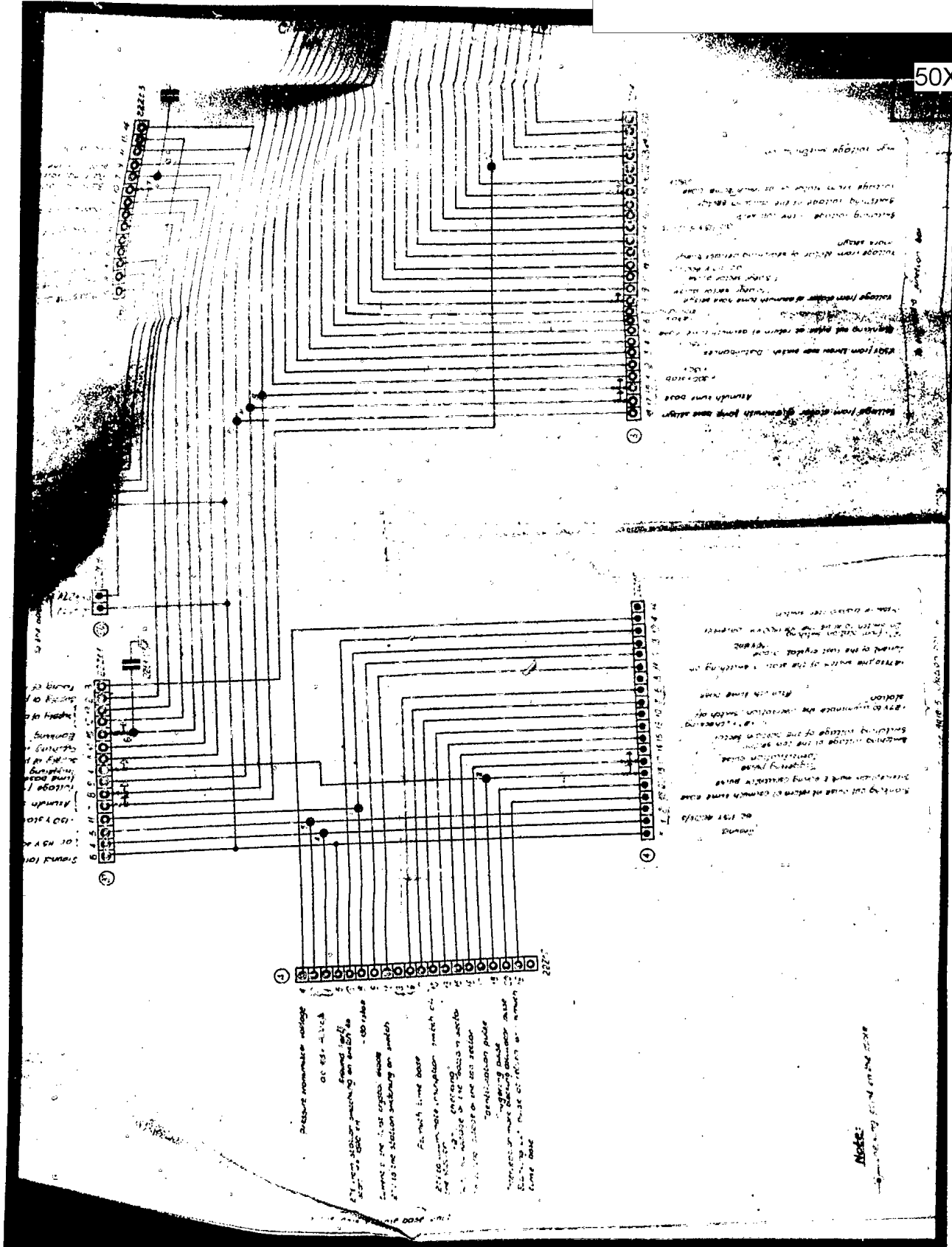

S-E-C-R-E-T

NO FOREIGN DISSEM

S-E-C-R-E-T
NO FOREIGN DISSEM



50X1

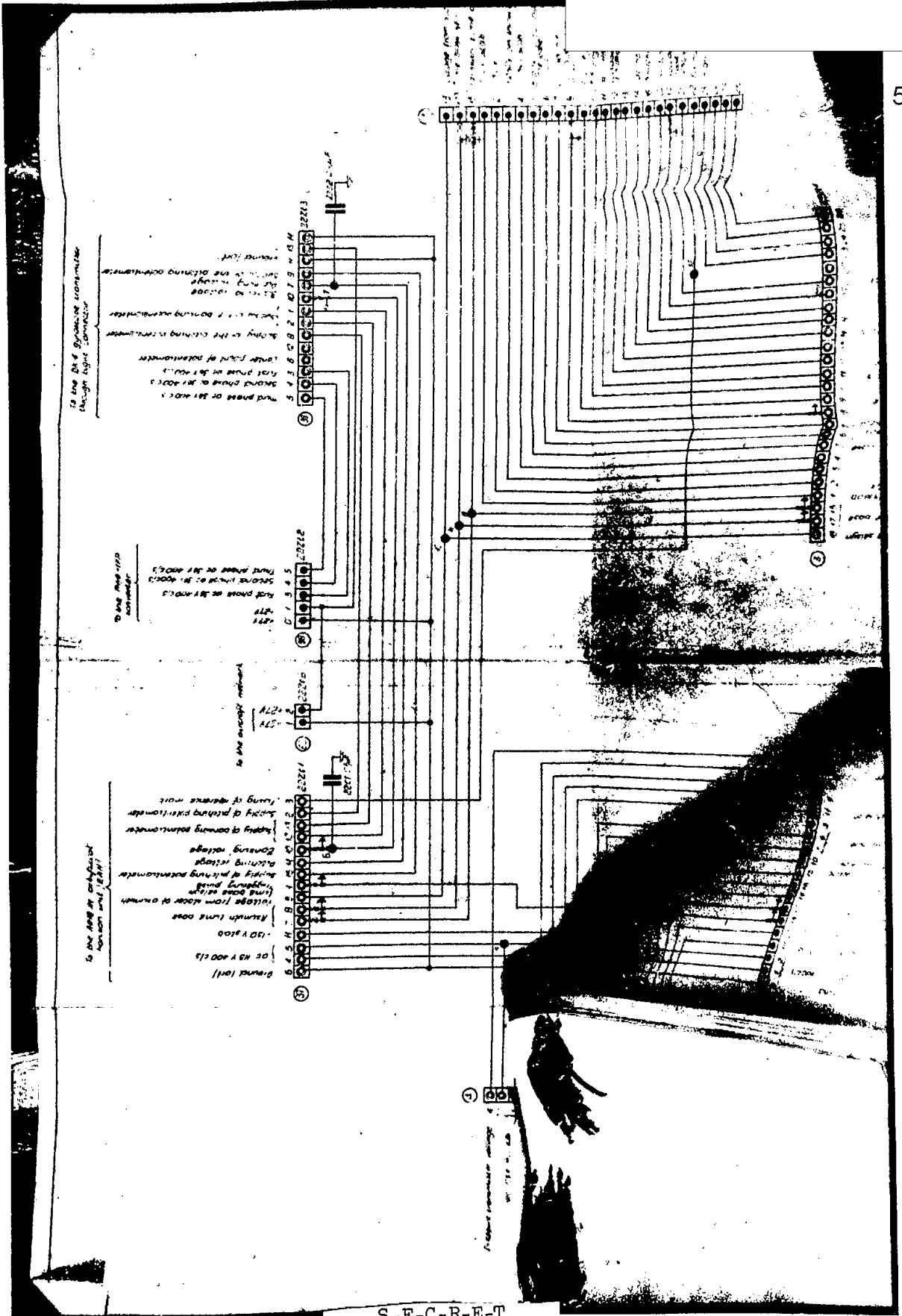

S-E-C-R-E-T

NO FOREIGN DISSEM

S-E-C-R-E-T
NO FOREIGN DISSEM

50X1

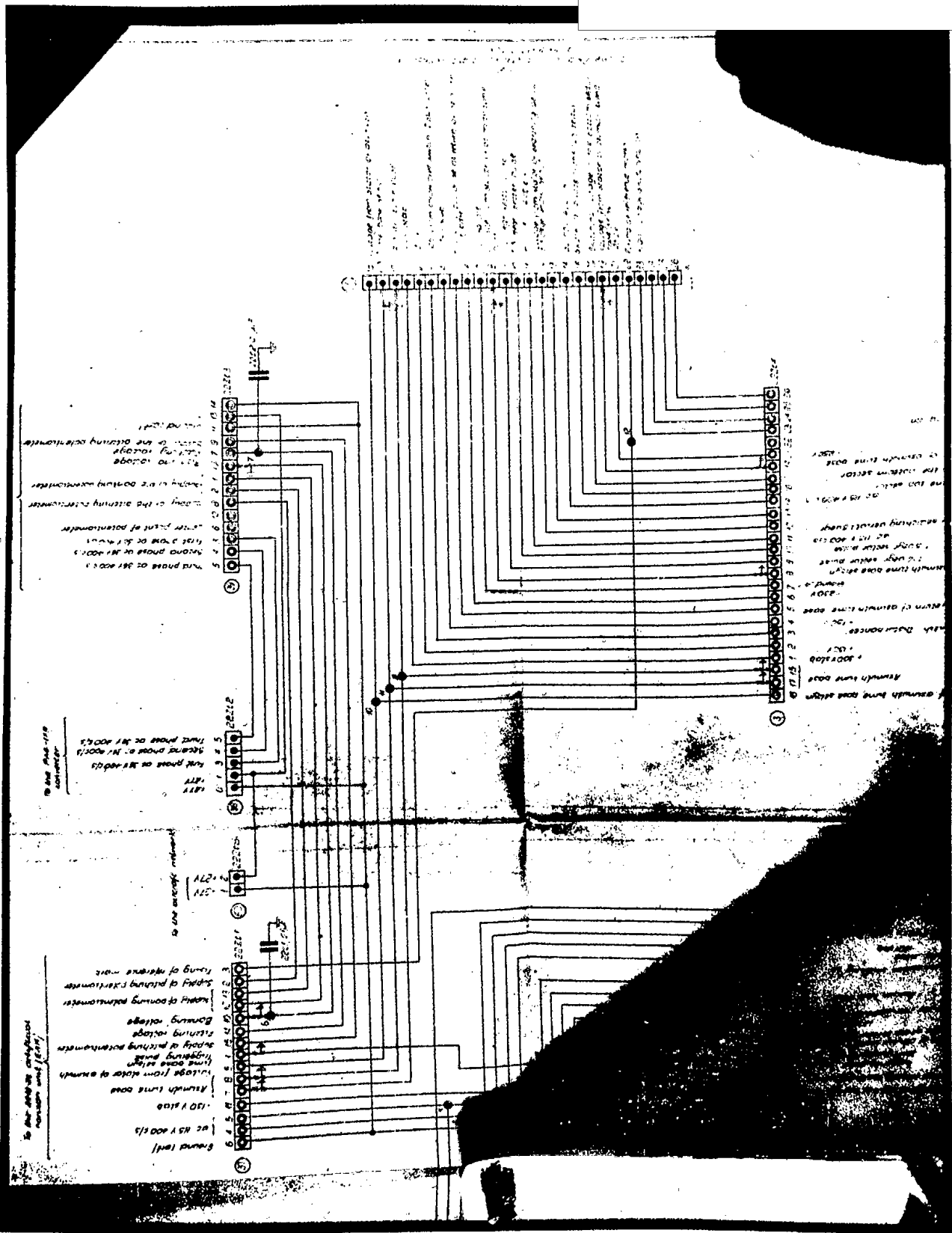

S-E-C-R-E-T

NO FOREIGN DISSEM

NO FOREIGN DISSEM

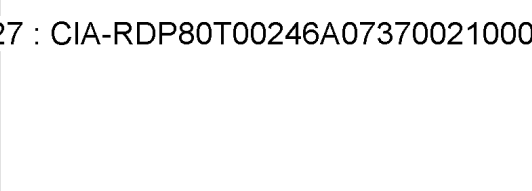

50X1

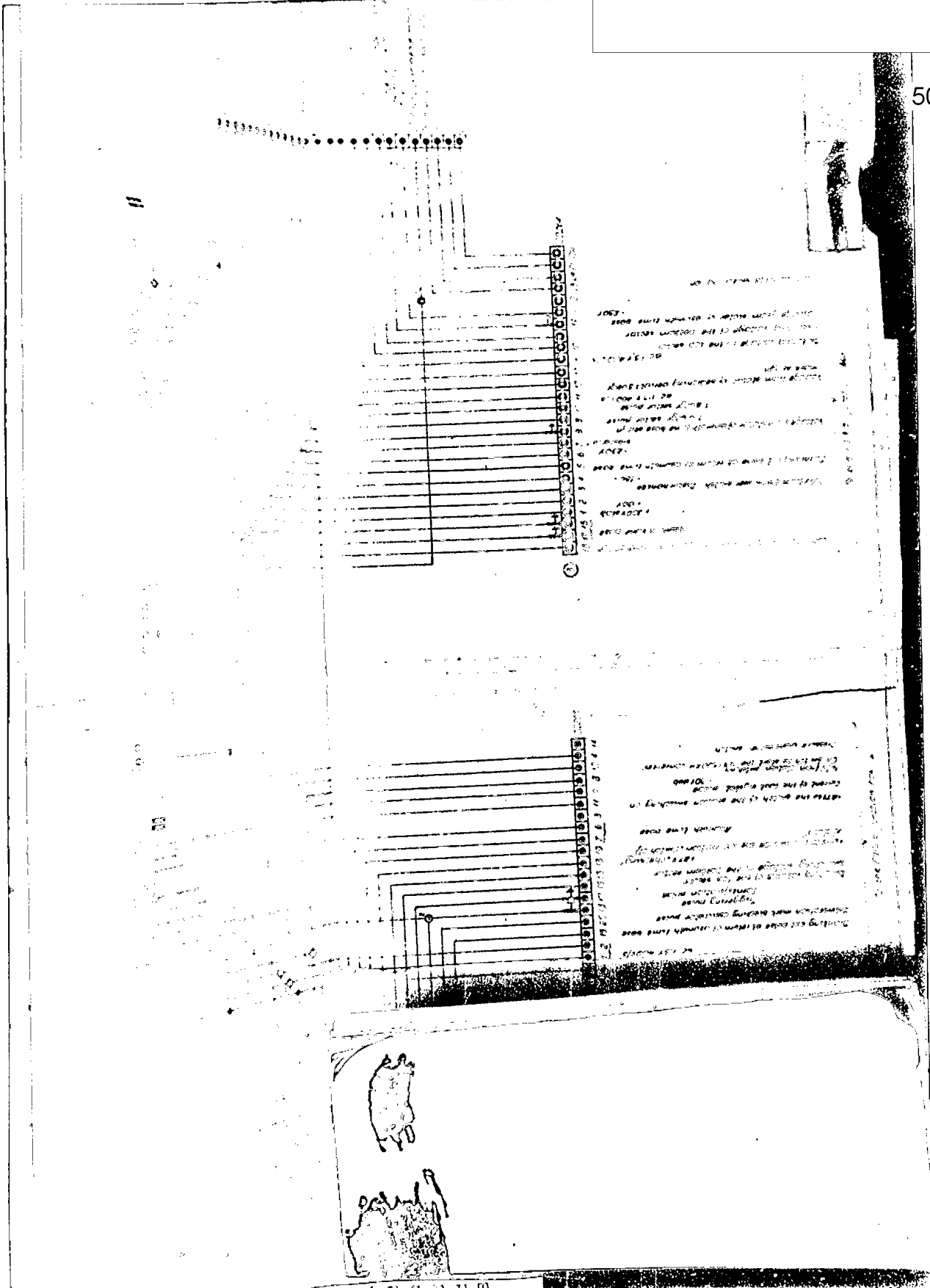

NO FOREIGN DISSEM

1. The system is designed to provide a secure communication channel between the sender and the receiver. The system consists of a transmitter and a receiver, both of which are connected to a central control unit. The transmitter is used to send messages, and the receiver is used to receive messages. The central control unit is responsible for managing the communication process and ensuring that the messages are transmitted securely.

2. The system is based on a principle of frequency hopping. The transmitter and receiver both hop between different frequencies in a predetermined sequence. This makes it difficult for an eavesdropper to intercept the communication, as they would need to know the exact sequence of frequencies used by the transmitter and receiver.

3. The system is also designed to be resistant to jamming. The transmitter and receiver both use a spread spectrum technique, which means that the signal is spread over a wide range of frequencies. This makes it difficult for a jammer to interfere with the communication, as they would need to jam the entire frequency range.

4. The system is also designed to be resistant to interception. The transmitter and receiver both use a secret key to encrypt the messages. This means that even if an eavesdropper intercepts the communication, they will not be able to read the messages unless they have the secret key.

NO FOREIGN DISSEM

1. The system is designed to provide a secure communication channel between the sender and the receiver. The system consists of a transmitter and a receiver, both of which are connected to a central control unit. The transmitter is used to send messages, and the receiver is used to receive messages. The central control unit is responsible for managing the communication process and ensuring that the messages are transmitted securely.

2. The system is based on a principle of frequency hopping. The transmitter and receiver both hop between different frequencies in a predetermined sequence. This makes it difficult for an eavesdropper to intercept the communication, as they would need to know the exact sequence of frequencies used by the transmitter and receiver.

3. The system is also designed to be resistant to jamming. The transmitter and receiver both use a spread spectrum technique, which means that the signal is spread over a wide range of frequencies. This makes it difficult for a jammer to interfere with the communication, as they would need to jam the entire frequency range.

4. The system is also designed to be resistant to interception. The transmitter and receiver both use a secret key to encrypt the messages. This means that even if an eavesdropper intercepts the communication, they will not be able to read the messages unless they have the secret key.

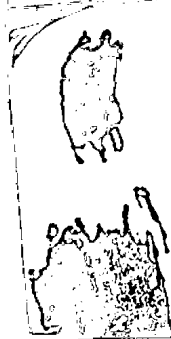

NO FOREIGN DISSEM

S-E-C-P-E-T
NO FOREIGN DISSEM

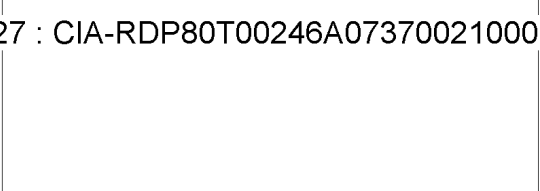

50X1

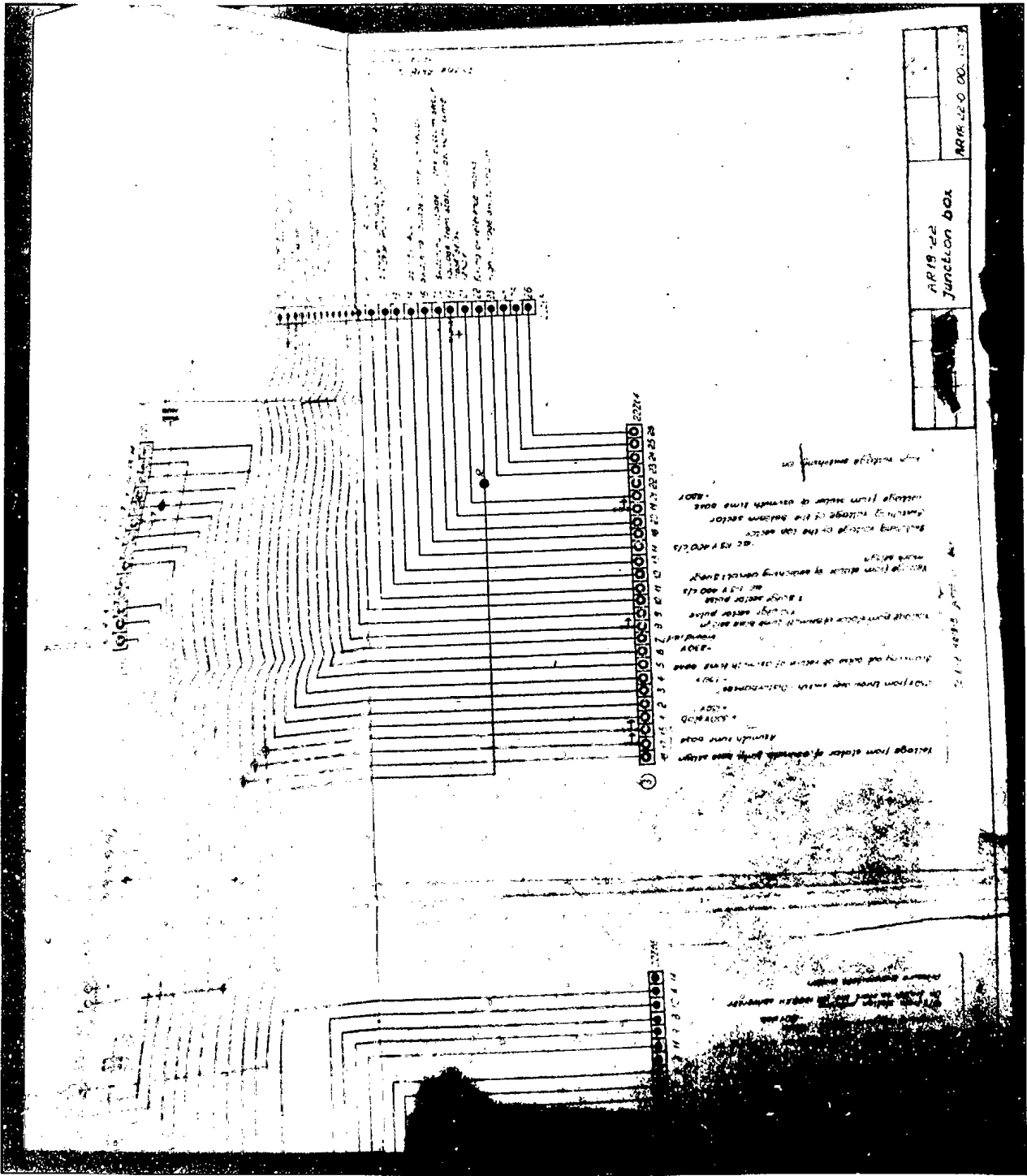

S-E-C-R-E-T

NO FOREIGN DISSEM

S-E-C-R-E-T
NO FOREIGN DISSEM

50X1

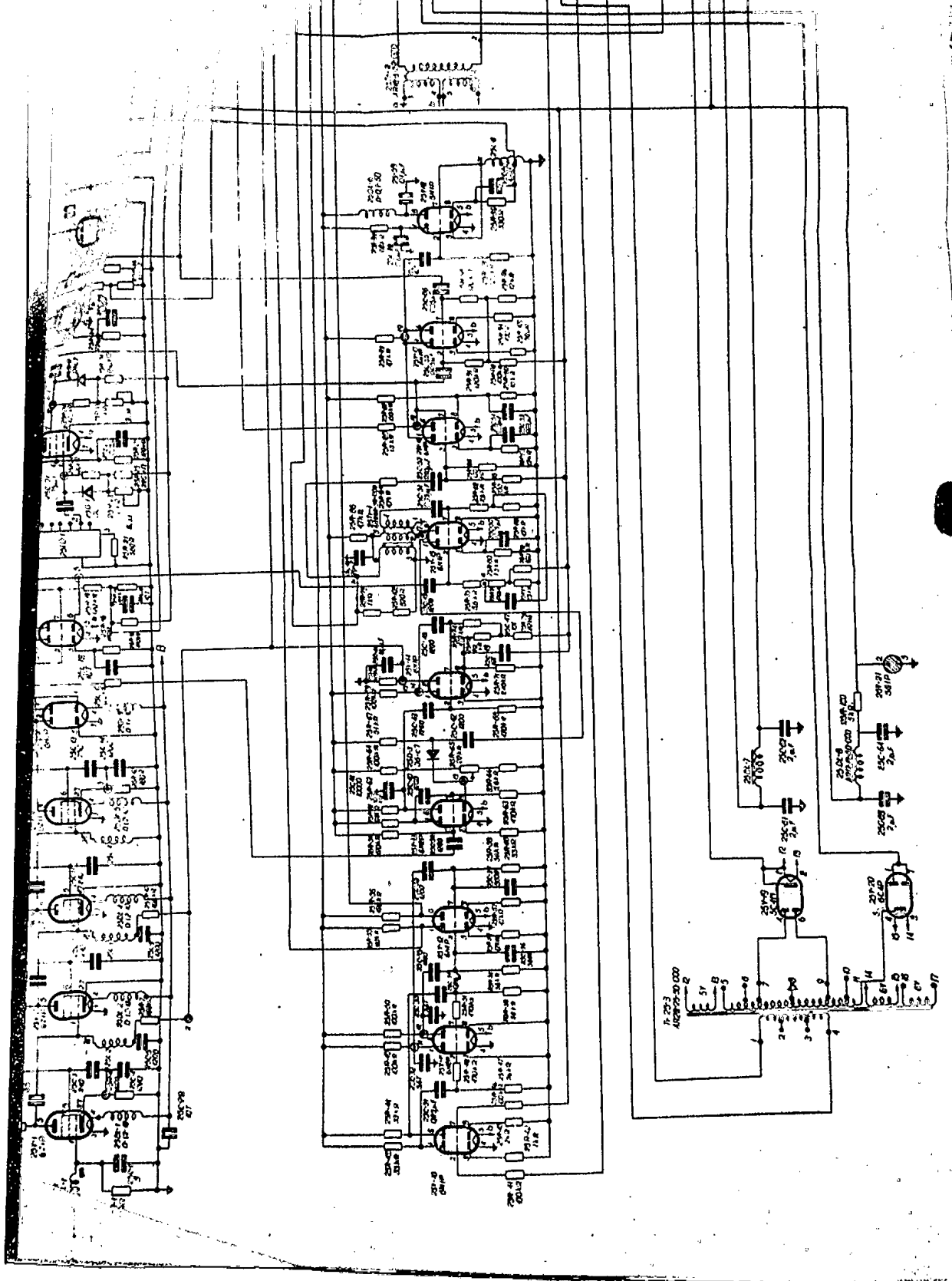

S-E-C-R-E-T

NO FOREIGN DISSEM

77

S-E-C-R-E-T
NO FOREIGN DISSEM

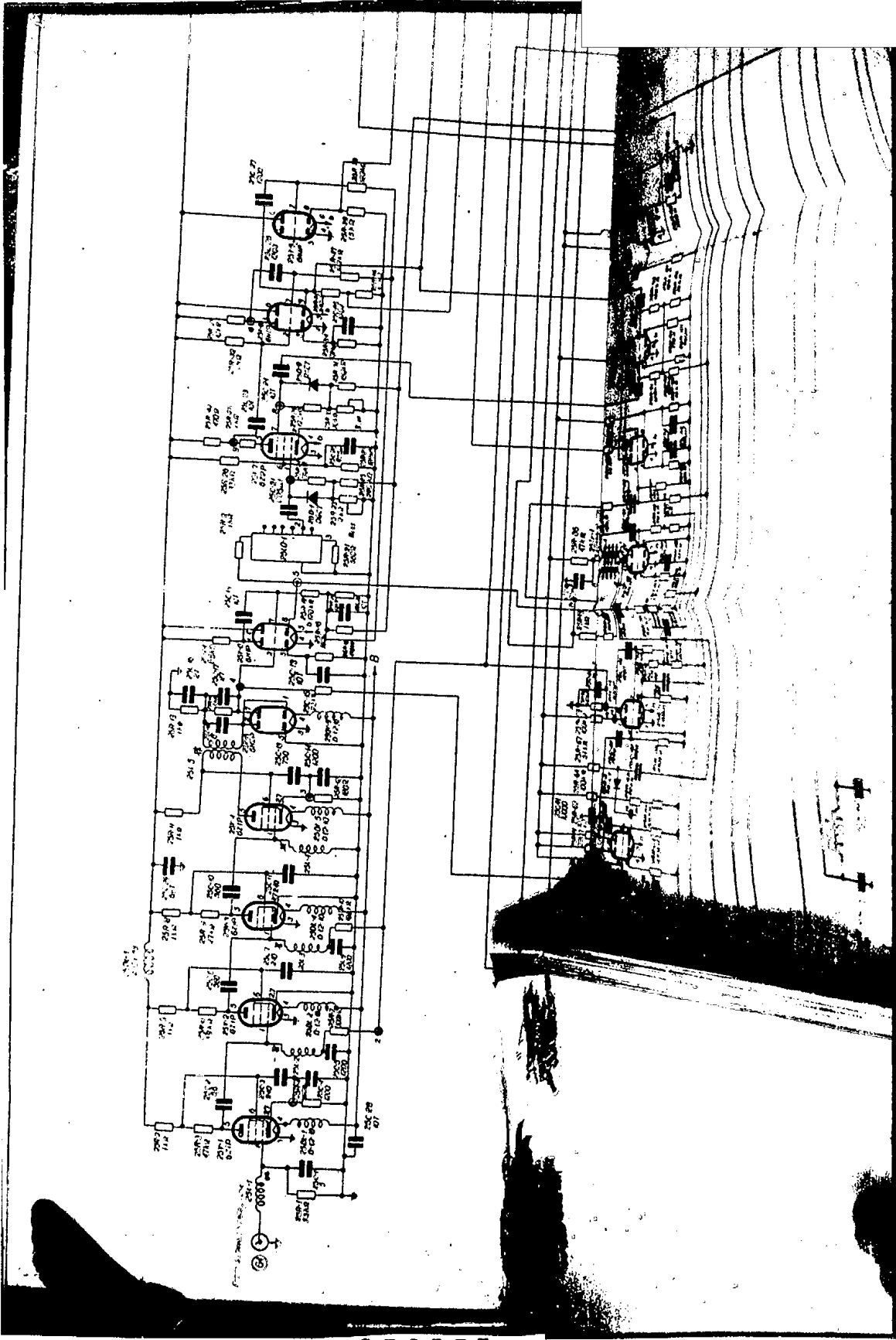

50X1

S-E-C-R-E-T

NO FOREIGN DISSEM

S-E-C-R-E-T
NO FOREIGN DISSEM

50X1

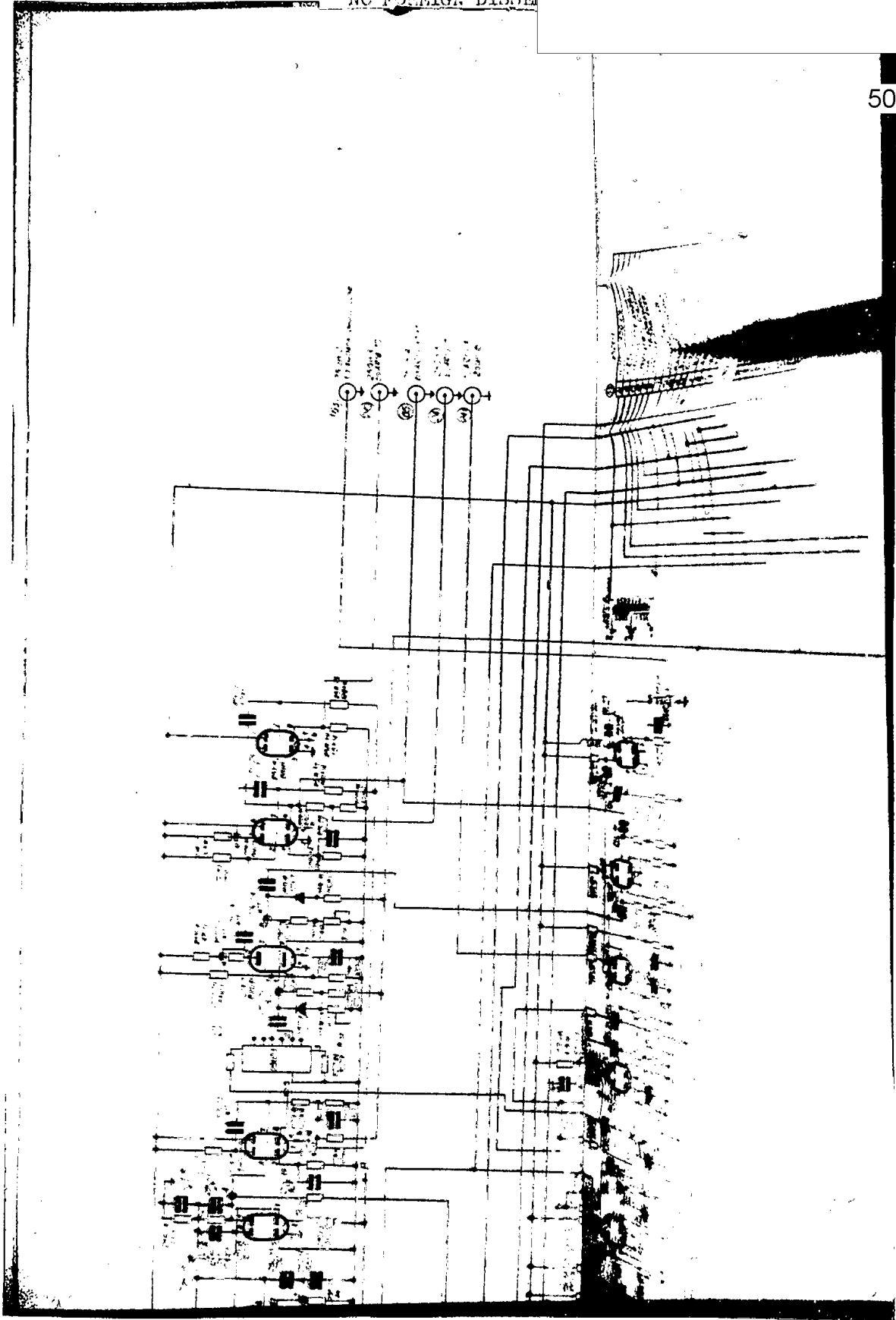

S-E-C-R-E-T

NO FOREIGN DISSEM

S-E-C-R-E-T
NO FOREIGN DISSEM

50X1

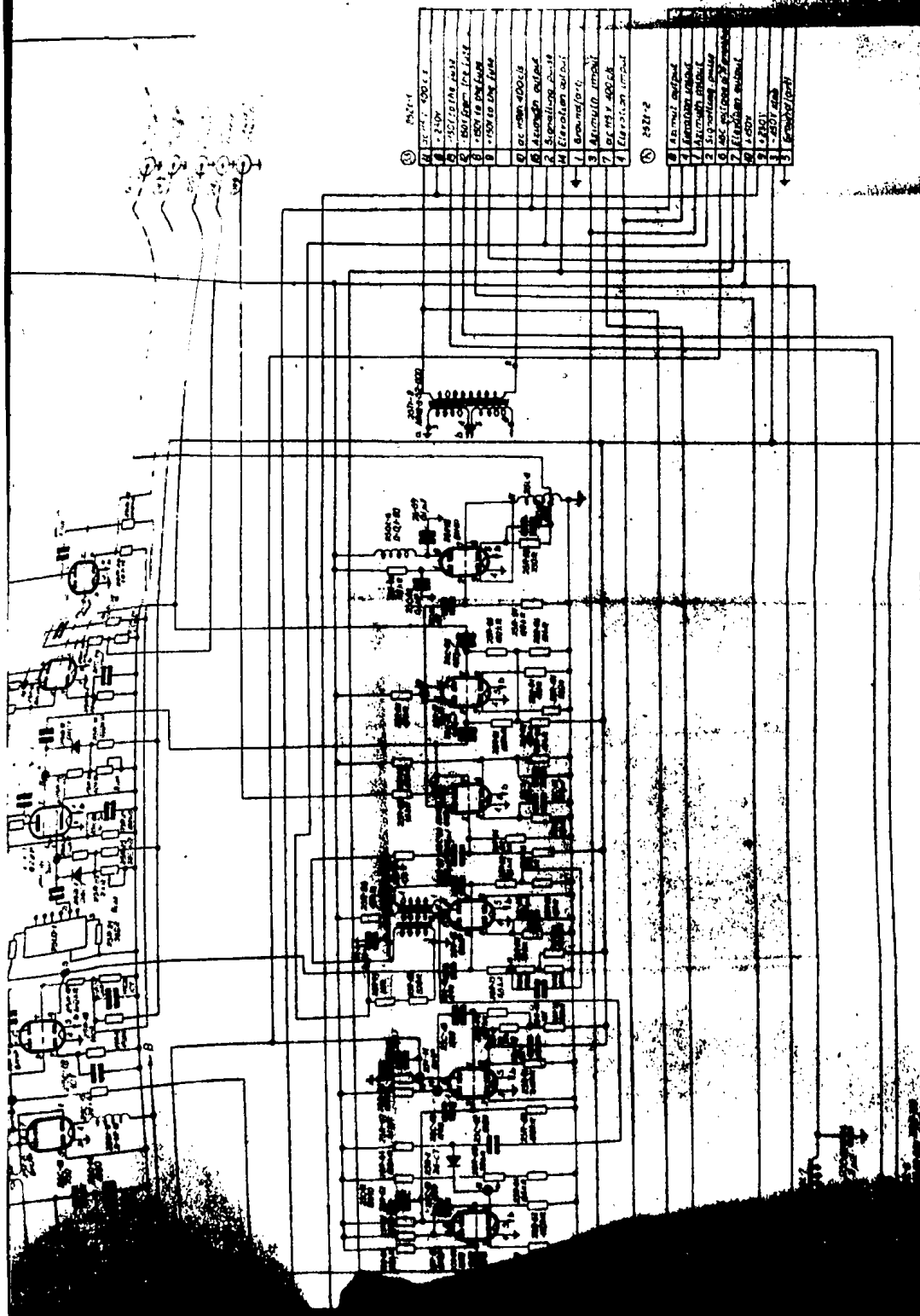

S-E-C-R-E-T

NO FOREIGN DISSEM

S-E-C-R-E-T
NO FOREIGN DISSEM

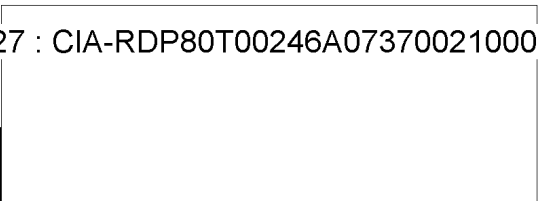

50X1

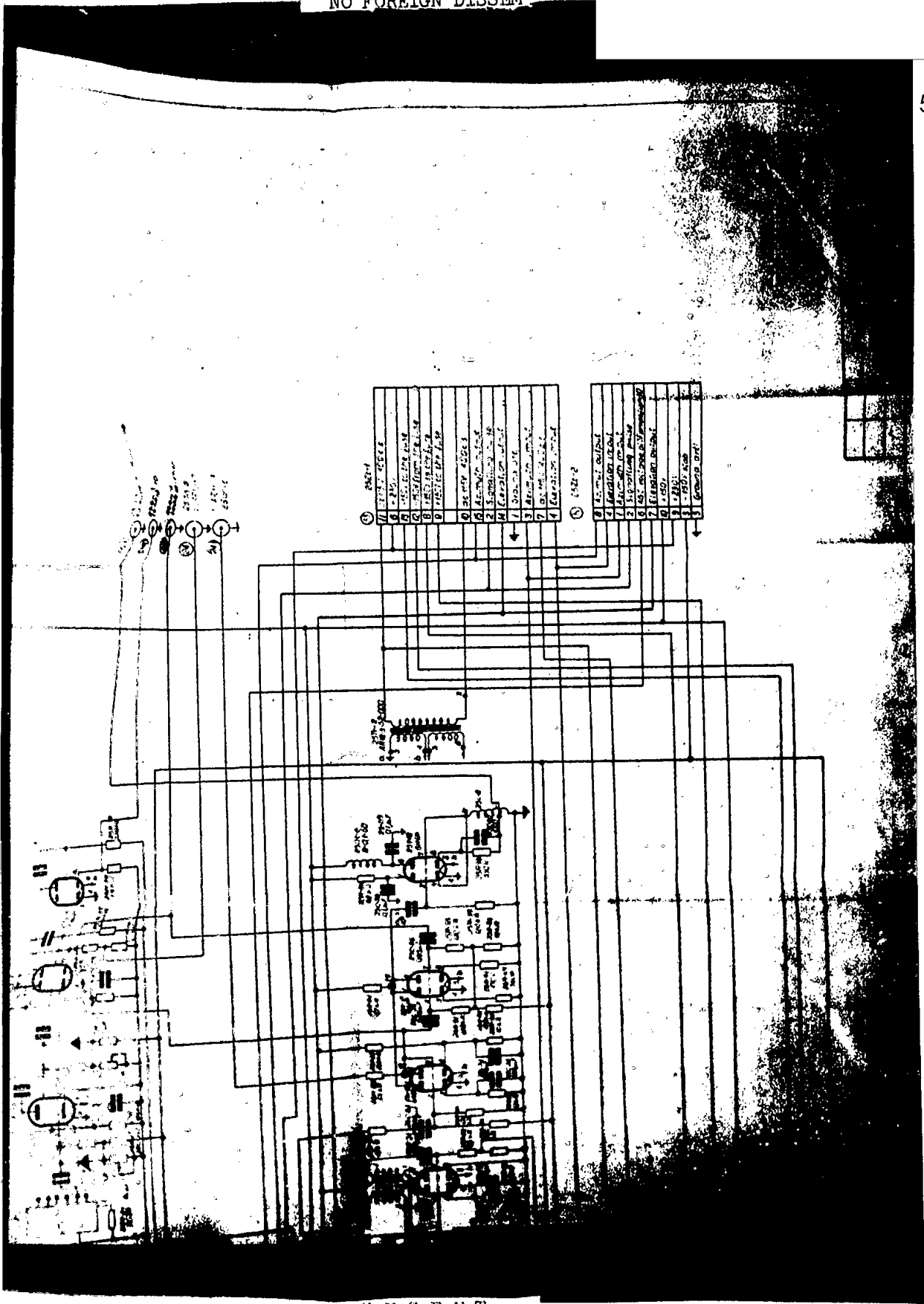

1	12VDC
2	2.5V
3	5V
4	12VDC
5	12VDC
6	12VDC
7	12VDC
8	12VDC
9	12VDC
10	12VDC
11	12VDC
12	12VDC
13	12VDC
14	12VDC
15	12VDC
16	12VDC
17	12VDC
18	12VDC
19	12VDC
20	12VDC
21	12VDC
22	12VDC
23	12VDC
24	12VDC
25	12VDC
26	12VDC
27	12VDC
28	12VDC
29	12VDC
30	12VDC
31	12VDC
32	12VDC
33	12VDC
34	12VDC
35	12VDC
36	12VDC
37	12VDC
38	12VDC
39	12VDC
40	12VDC
41	12VDC
42	12VDC
43	12VDC
44	12VDC
45	12VDC
46	12VDC
47	12VDC
48	12VDC
49	12VDC
50	12VDC
51	12VDC
52	12VDC
53	12VDC
54	12VDC
55	12VDC
56	12VDC
57	12VDC
58	12VDC
59	12VDC
60	12VDC
61	12VDC
62	12VDC
63	12VDC
64	12VDC
65	12VDC
66	12VDC
67	12VDC
68	12VDC
69	12VDC
70	12VDC
71	12VDC
72	12VDC
73	12VDC
74	12VDC
75	12VDC
76	12VDC
77	12VDC
78	12VDC
79	12VDC
80	12VDC
81	12VDC
82	12VDC
83	12VDC
84	12VDC
85	12VDC
86	12VDC
87	12VDC
88	12VDC
89	12VDC
90	12VDC
91	12VDC
92	12VDC
93	12VDC
94	12VDC
95	12VDC
96	12VDC
97	12VDC
98	12VDC
99	12VDC
100	12VDC

S-E-C-R-E-T
NO FOREIGN DISSEM

S-E-C-R-E-T
NO FOREIGN DISSEM



50X1

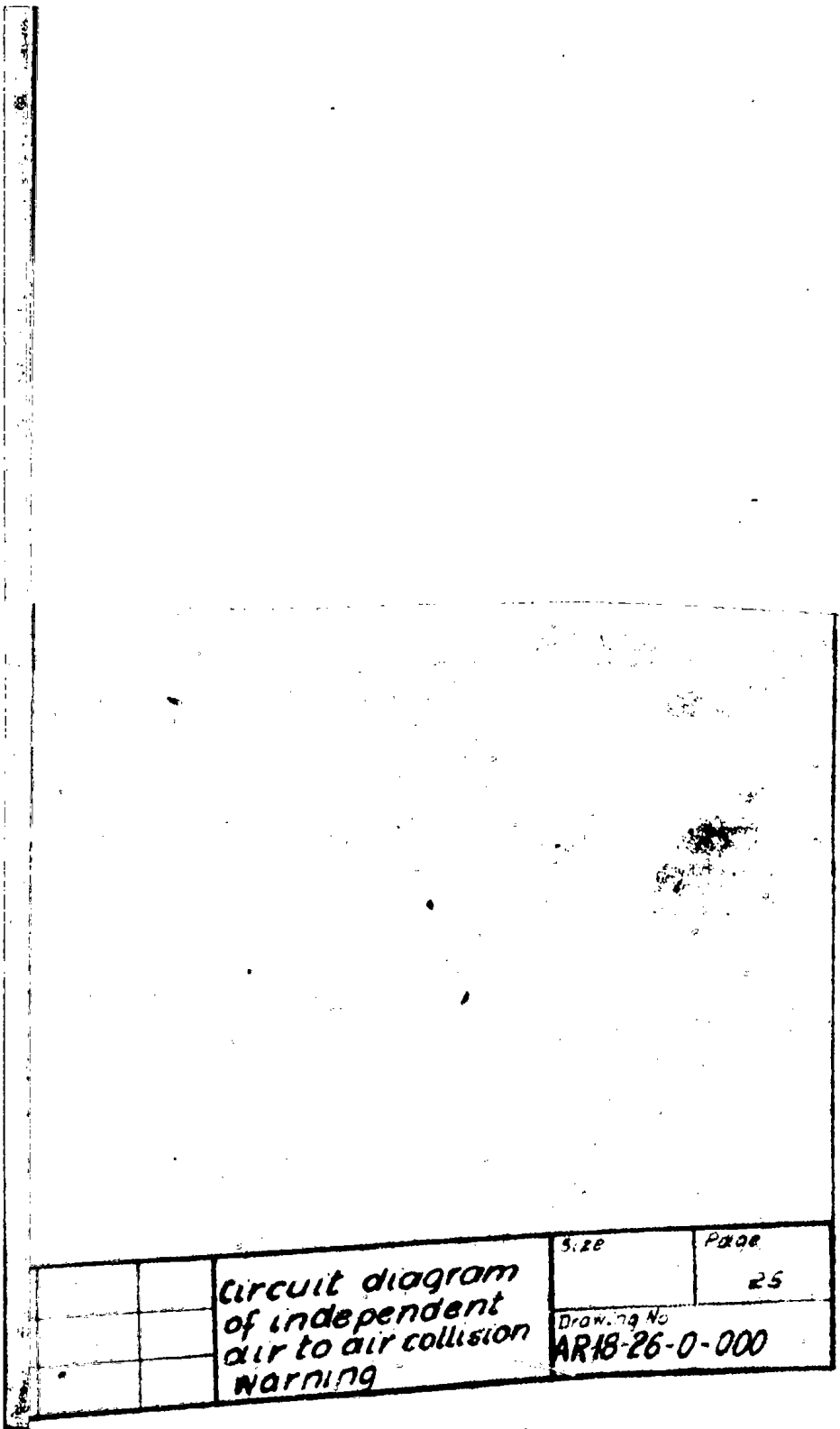

			Size	Page
		Circuit diagram of independent air to air collision warning		25
			Drawing No	AR18-26-0-000

S-E-C-R-E-T

NO FOREIGN DISSEM

S-E-C-R-E-T
NO FOREIGN DISSEM

50X1

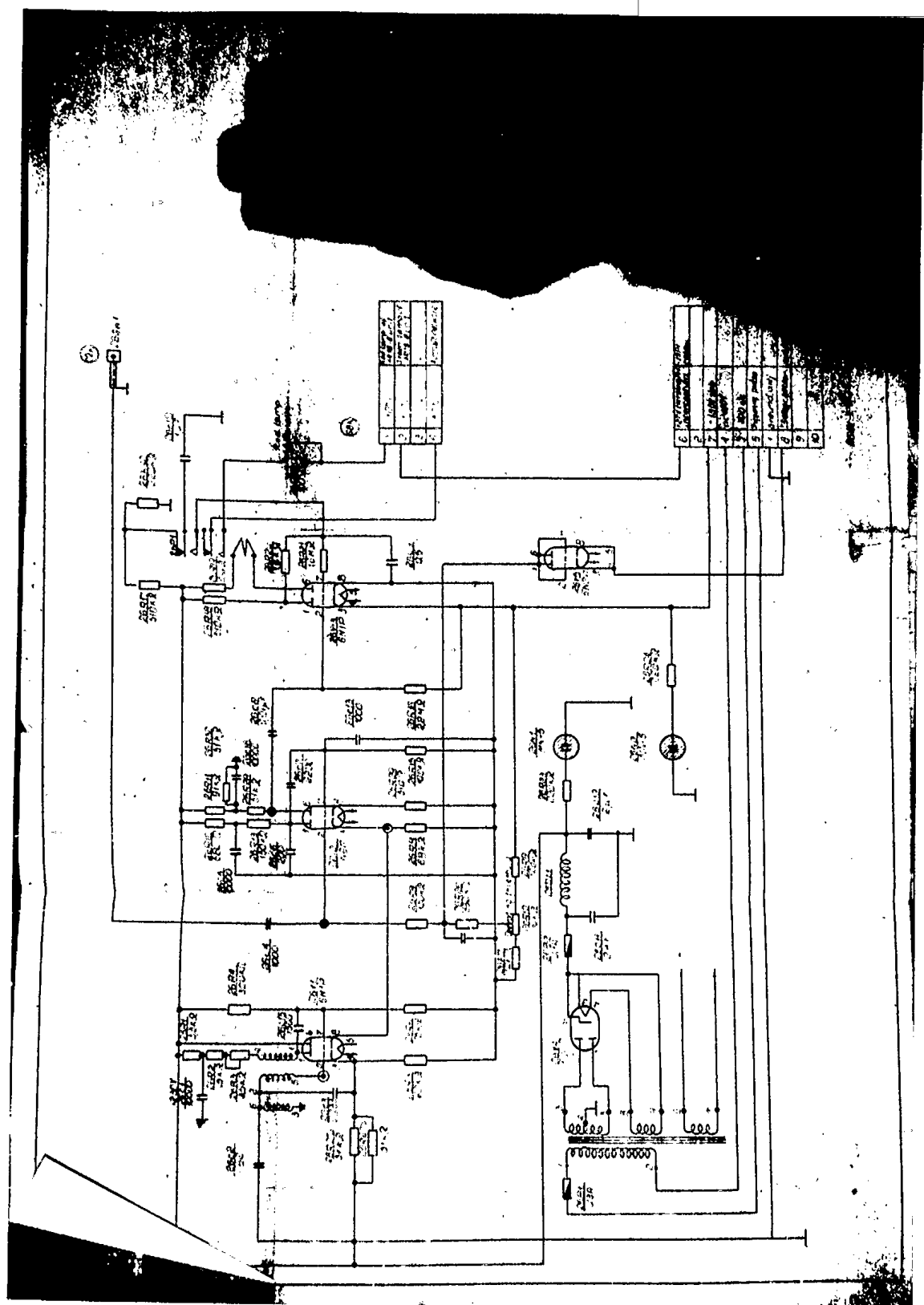

S-E-C-R-E-T

NO FOREIGN DISSEM

S-E-C-R-E-T
NO FOREIGN DISSEM

50X1

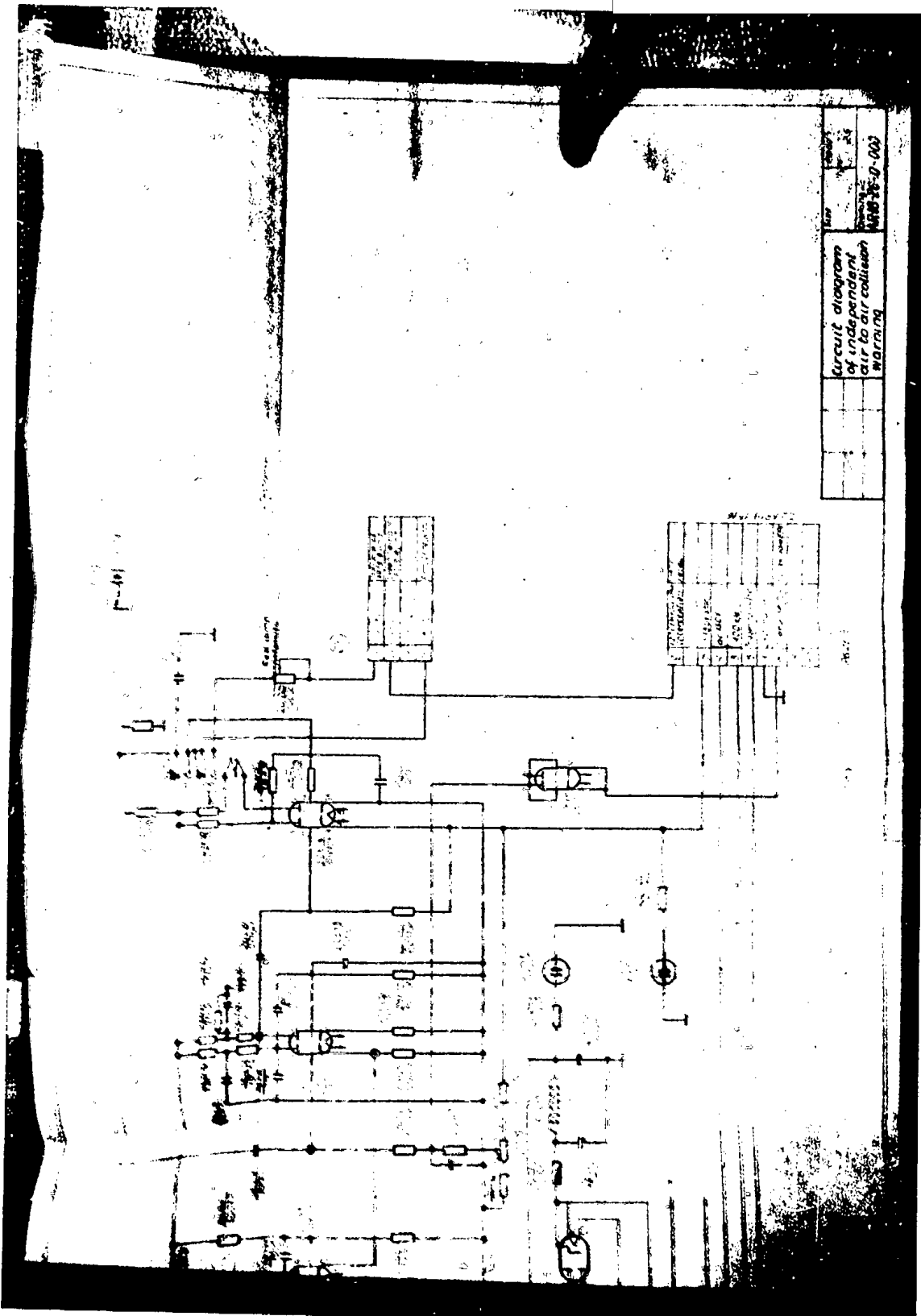

10-1

S-E-C-R-E-T
NO FOREIGN DISSEM

S-E-C-R-E-T
NO FOREIGN DISSEM

50X1

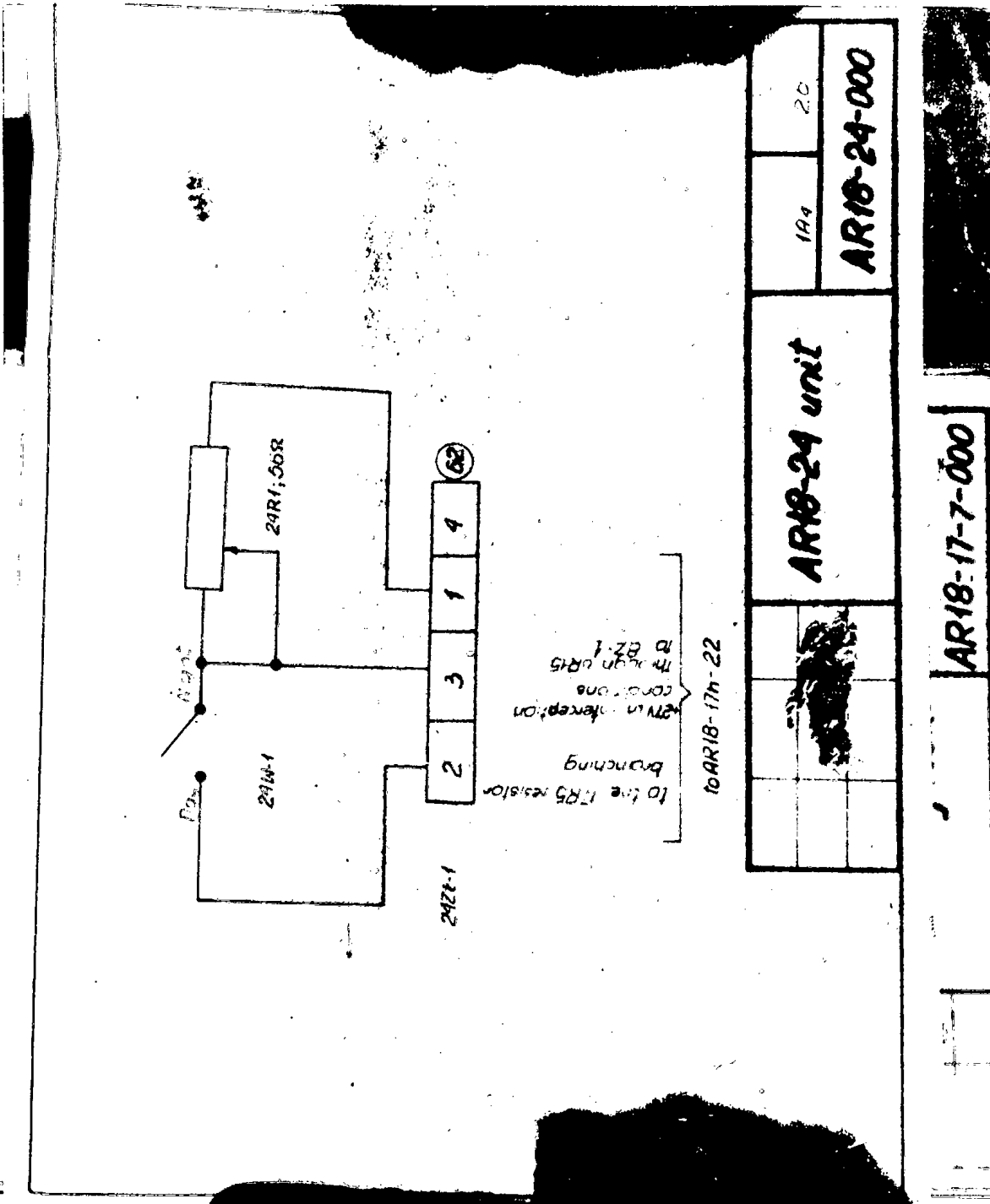

S-E-C-R-E-T

NO FOREIGN DISSEM

S-E-C-R-E-T
NO FOREIGN DISSEM

50X1

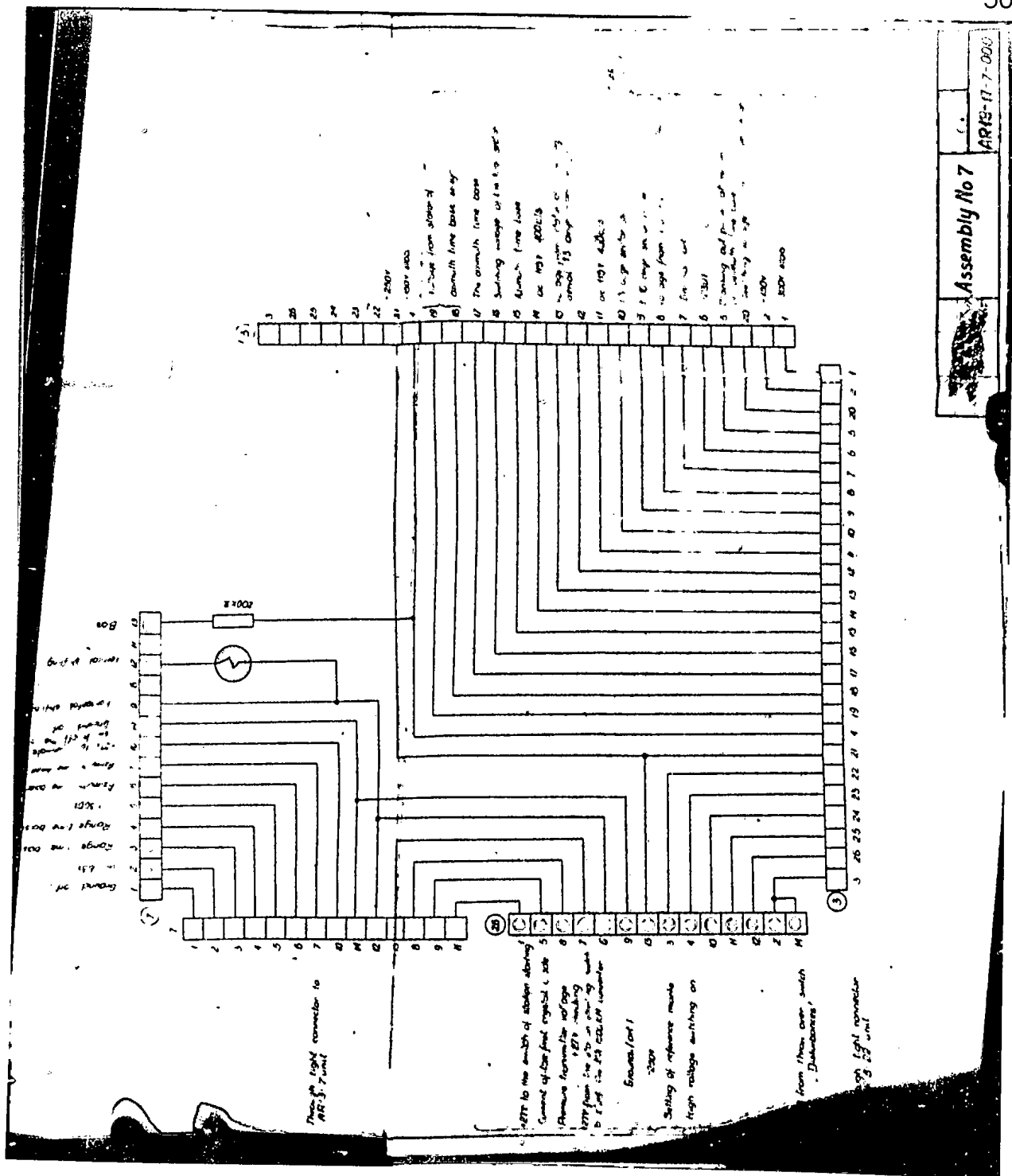

103

S-E-C-R-E-T
NO FOREIGN DISSEM

S-E-C-R-E-T
NO FOREIGN DISSEM

50X1

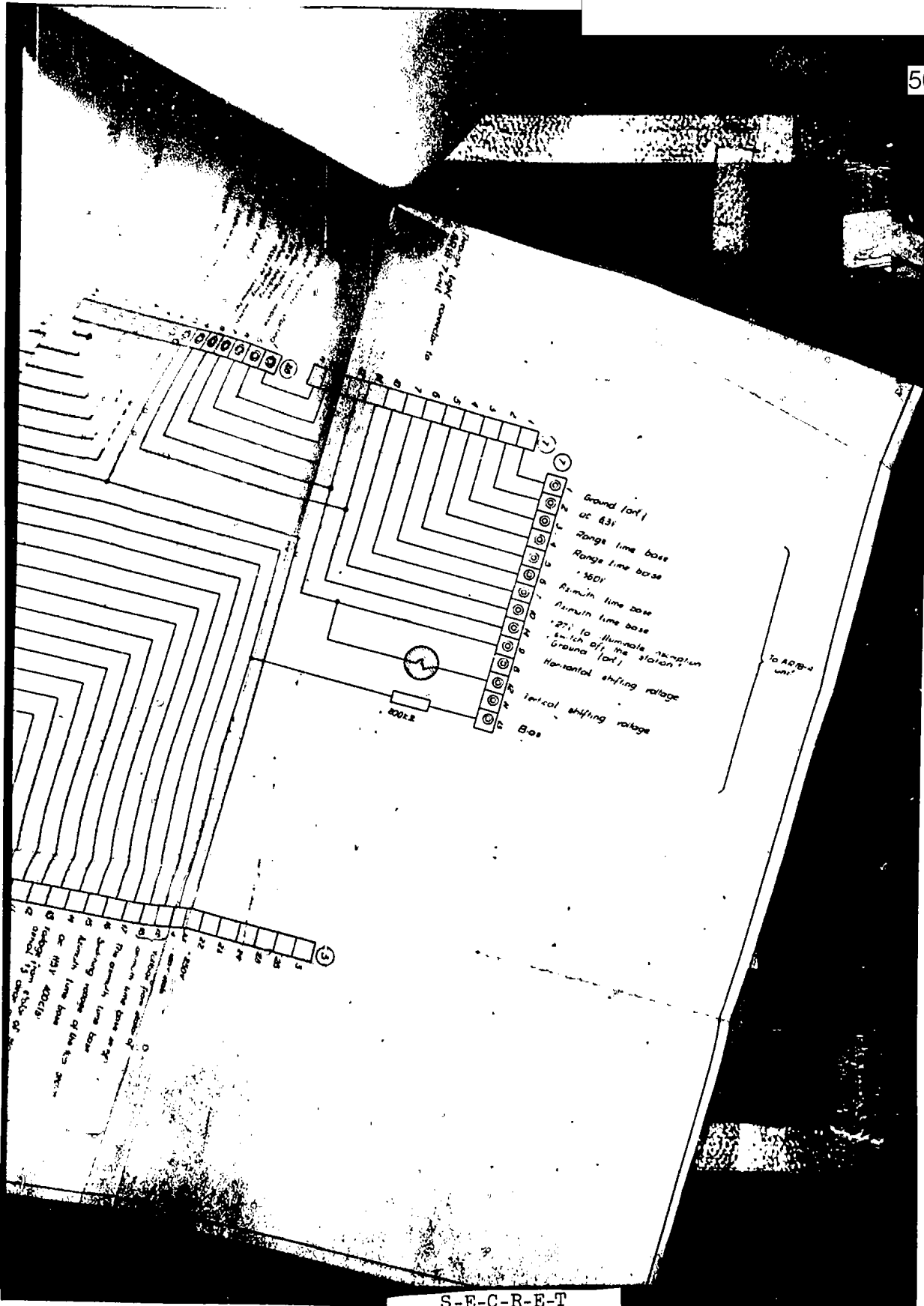

S-E-C-R-E-T
NO FOREIGN DISSEM

107

S-E-C-R-E-T
NO FOREIGN DISSEM

50X1

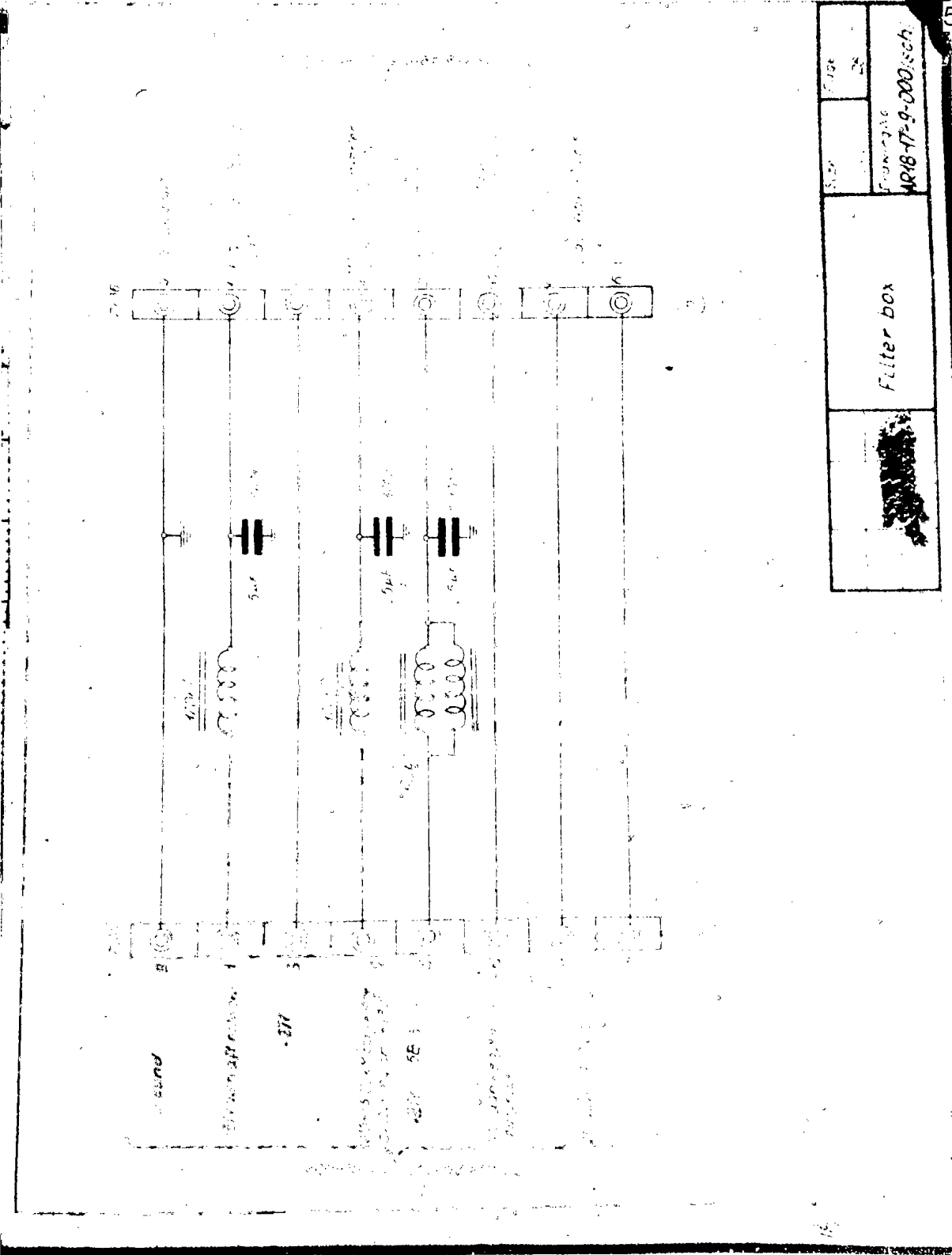

Filter box	Part	24
	Quantity	1
Drawing No. WP18-17-9-000-15ch		

S-E-C-R-E-T

NO FOREIGN DISSEM

S-E-C-R-E-T
NO FOREIGN DISSEM

50X1

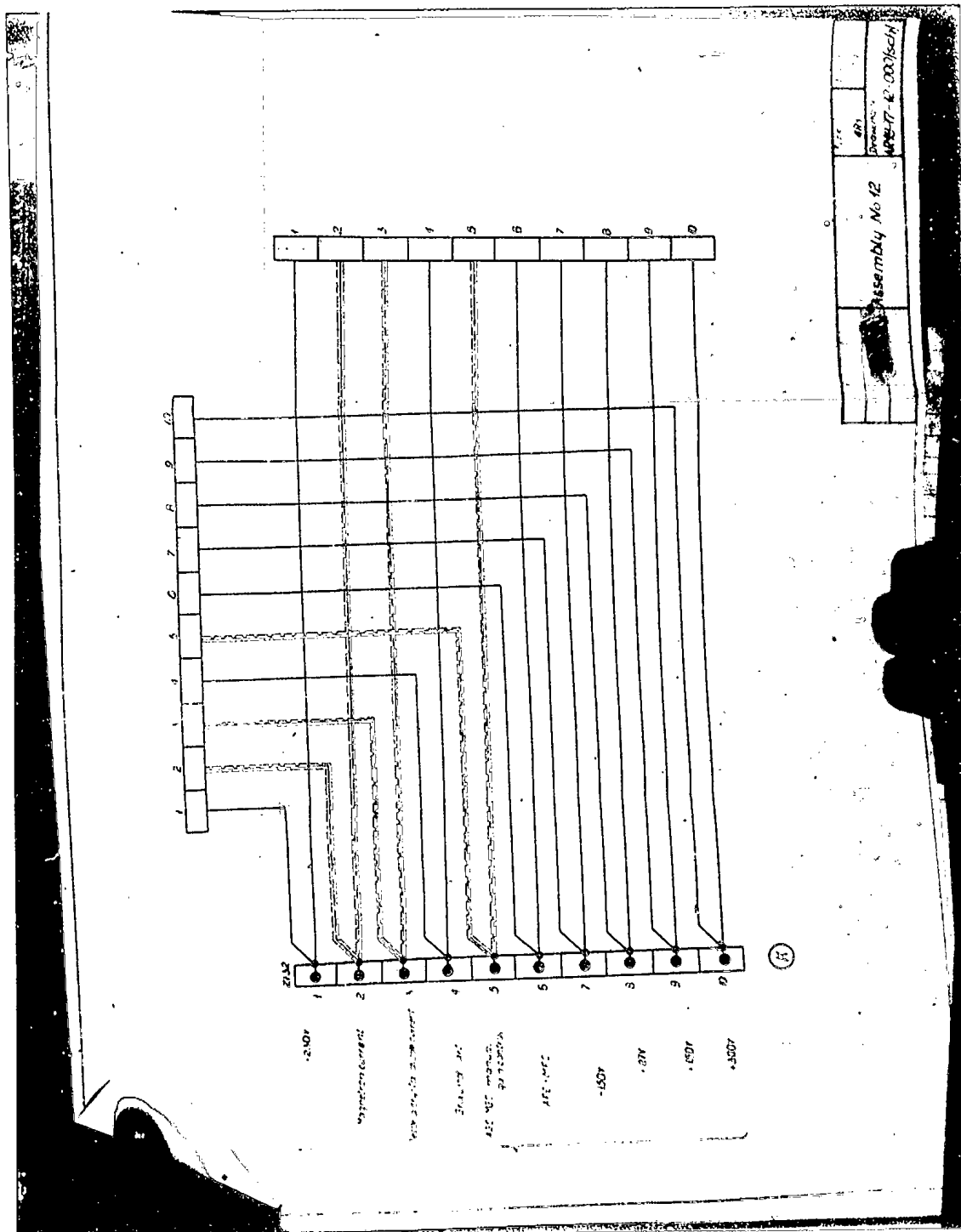

S-E-C-R-E-T
NO FOREIGN DISSEM



50X1

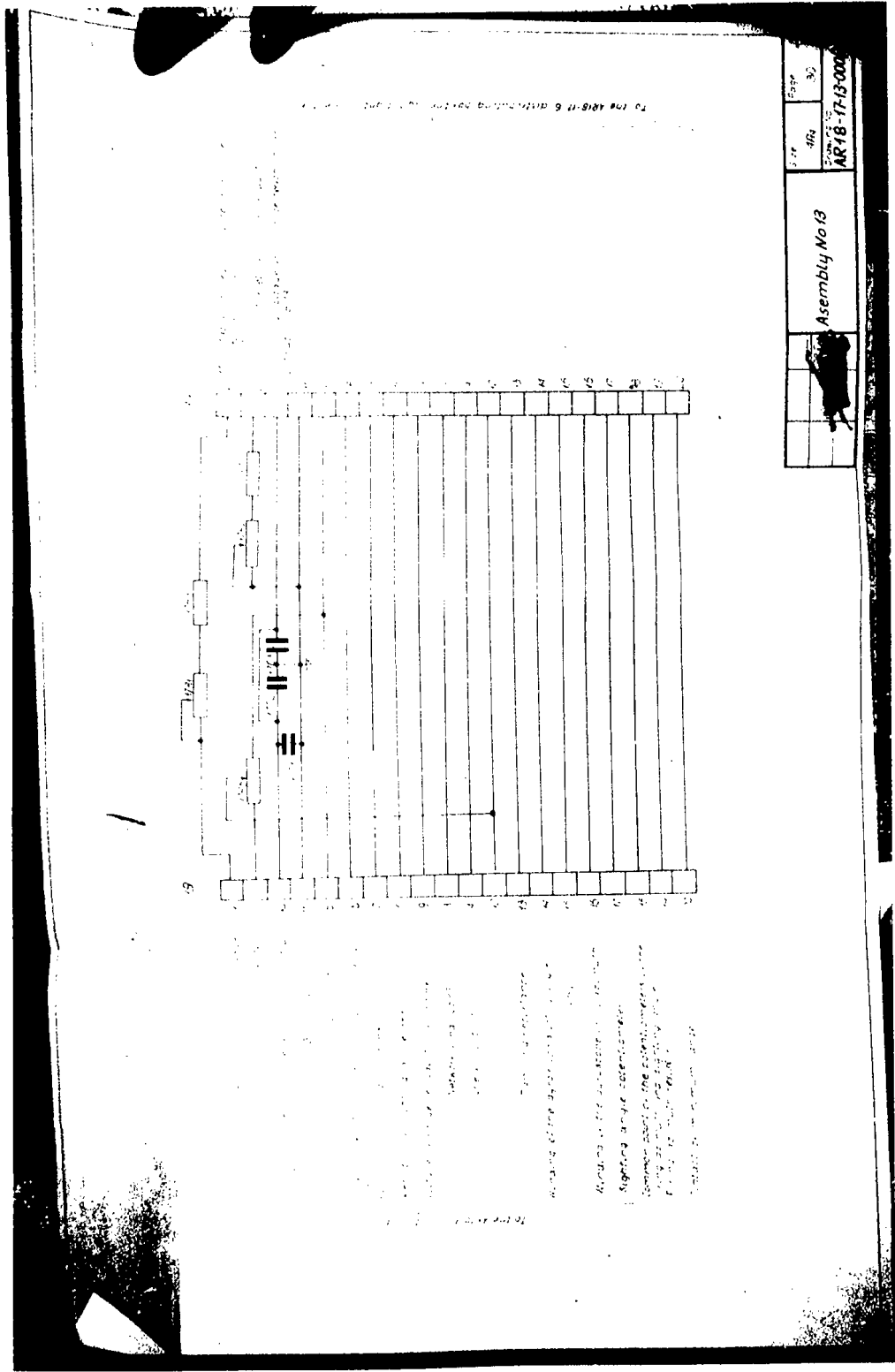

S-E-C-R-E-T
NO FOREIGN DISSEM



50X1

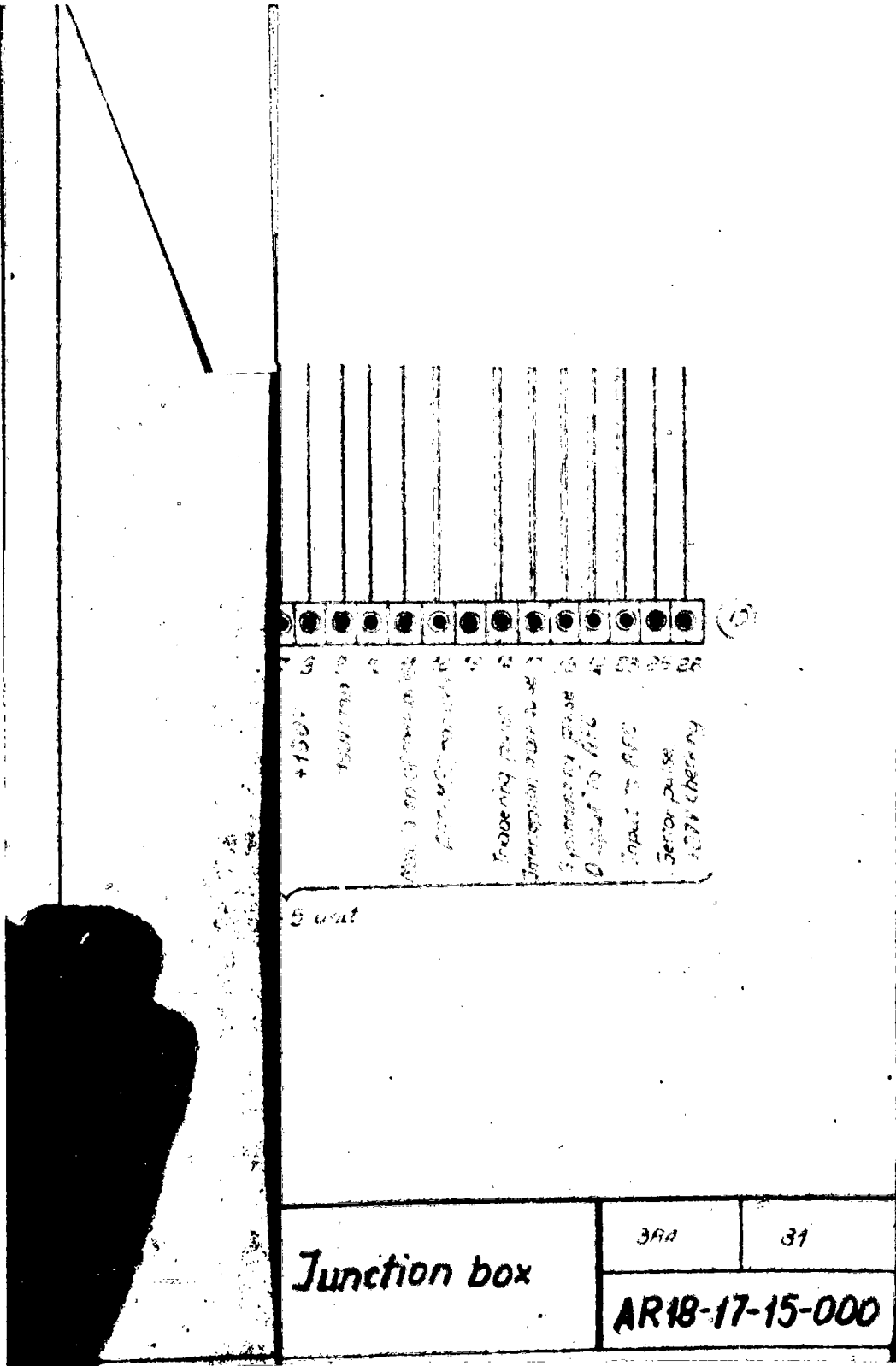

S-E-C-R-E-T

NO FOREIGN DISSEM

108

S-E-C-R-E-T
NO FOREIGN DISSEM

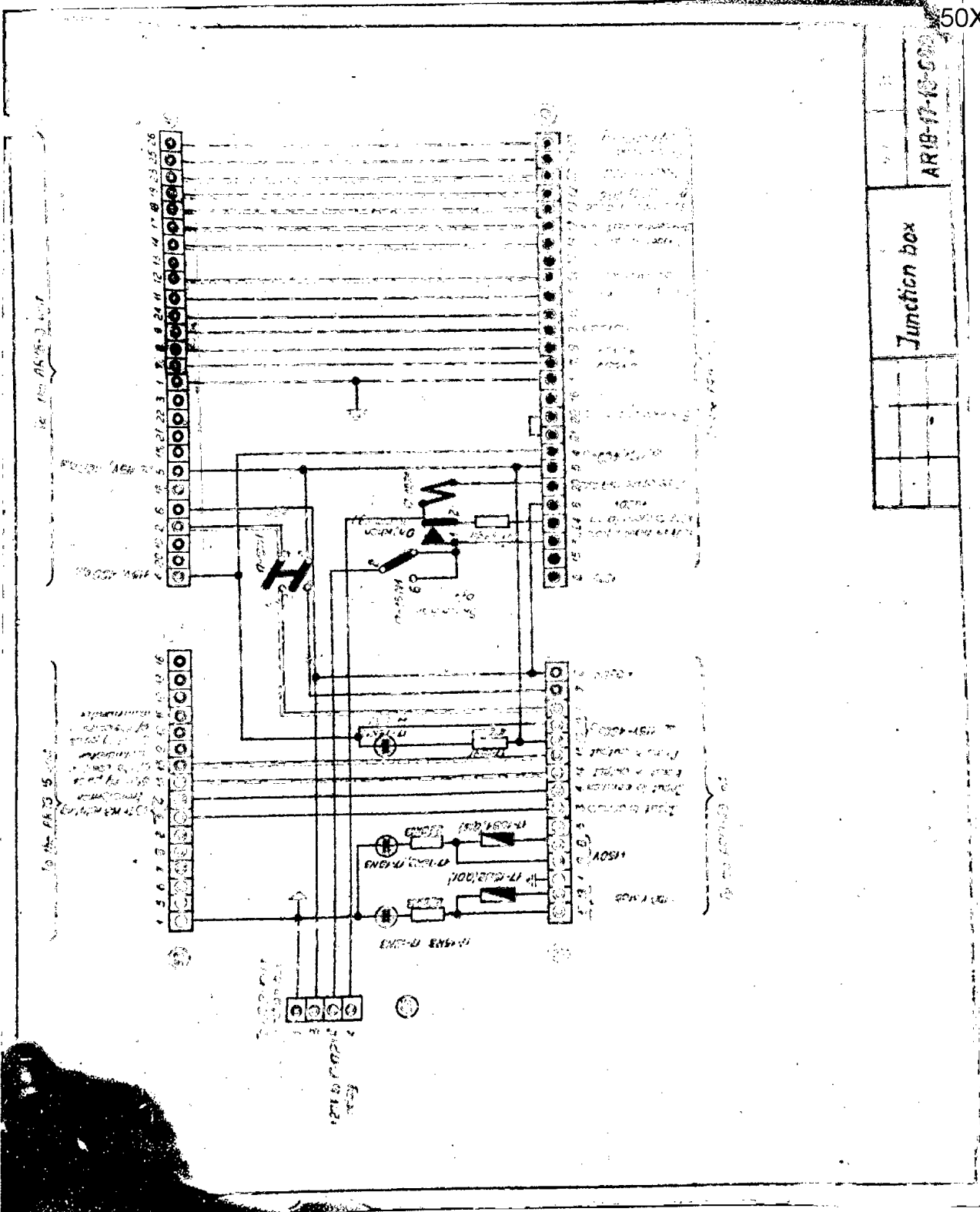

50X1

Junction box	

AR18-17-18-000

S-E-C-R-E-T
NO FOREIGN DISSEM

S-E-C-R-E-T
NO FOREIGN DISSEM

50X1

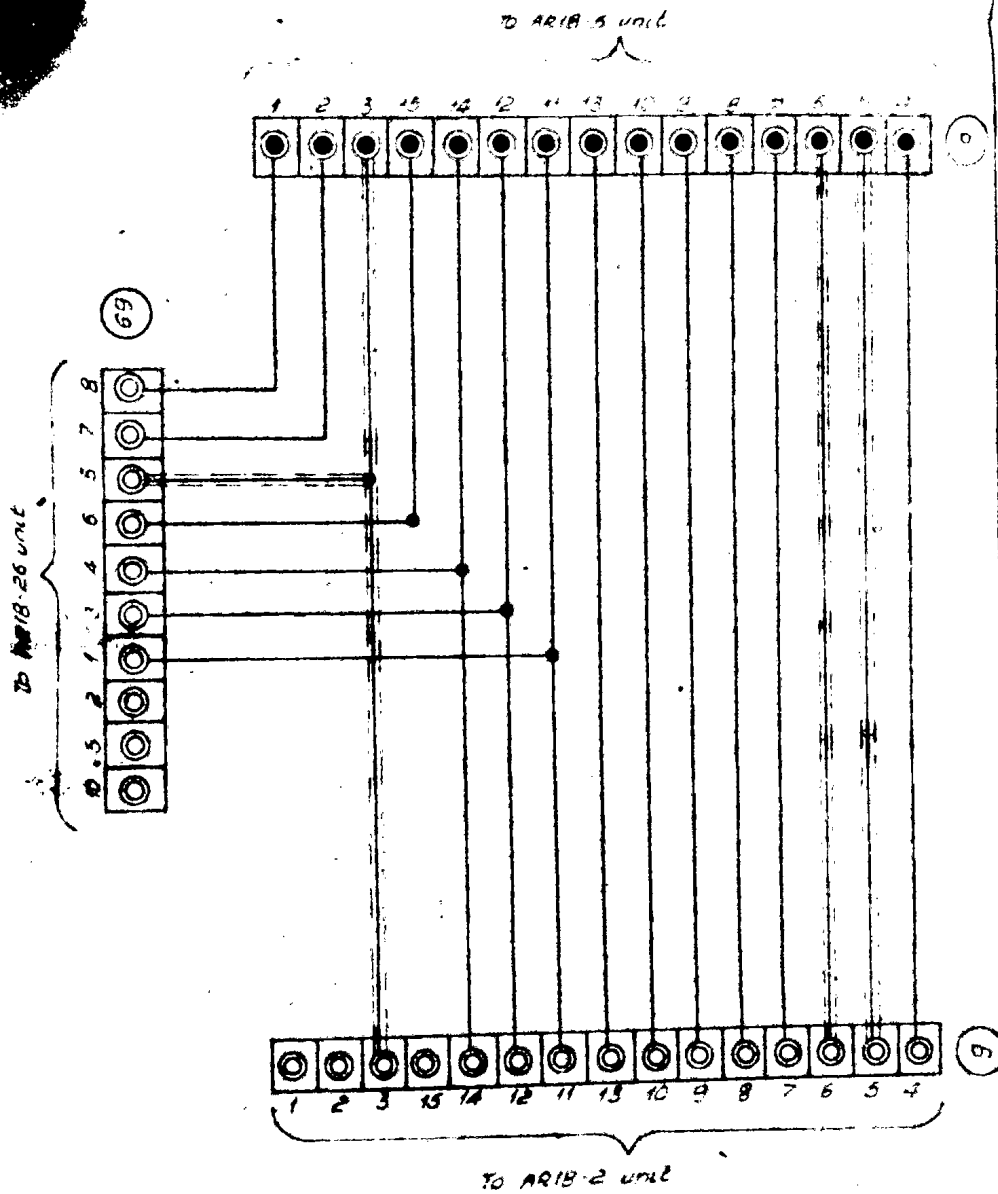

						Size	Page
						M	32
						Drawing No	
						AR-18-17-18-000	

S-E-C-R-E-T
NO FOREIGN DISSEM

110

SECRET

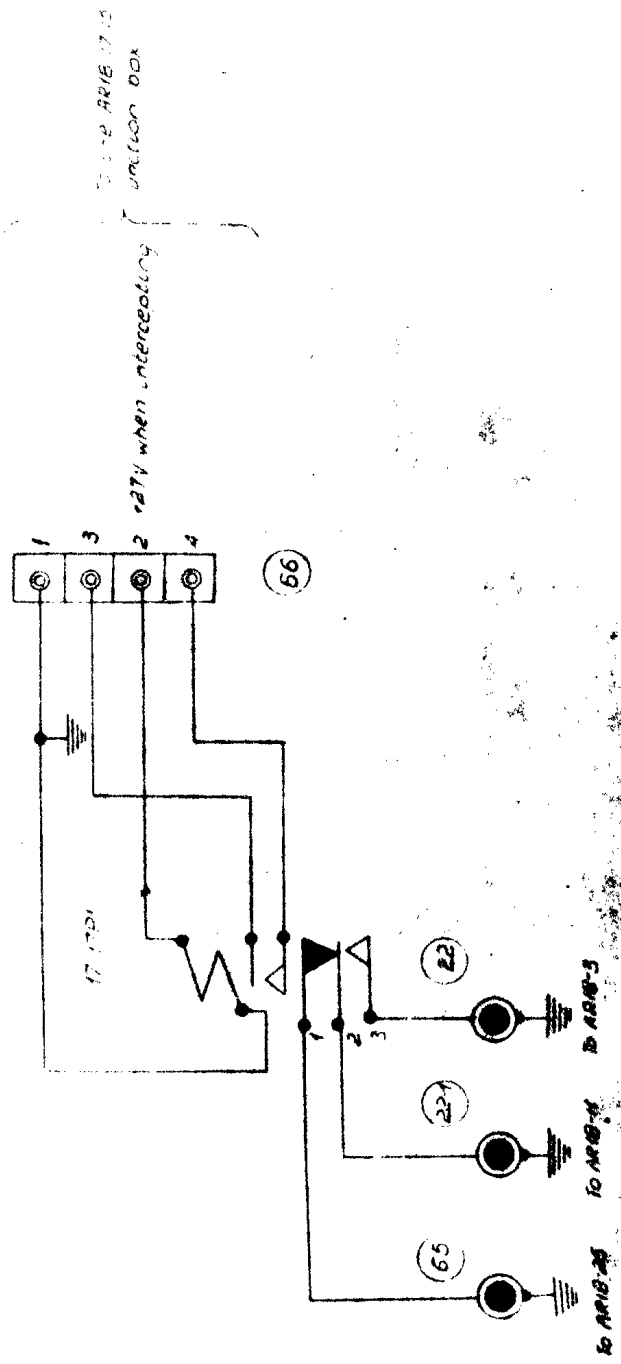

2 - 2 AR18-17-15
junction box

2 22V when interesting

528	Page
A4	23
Drawing No	
AR18-17-17-000	

Junction box

50X1

SECRET

SECRET

S-E-C-R-E-T
NO FOREIGN DISSEM

50X1

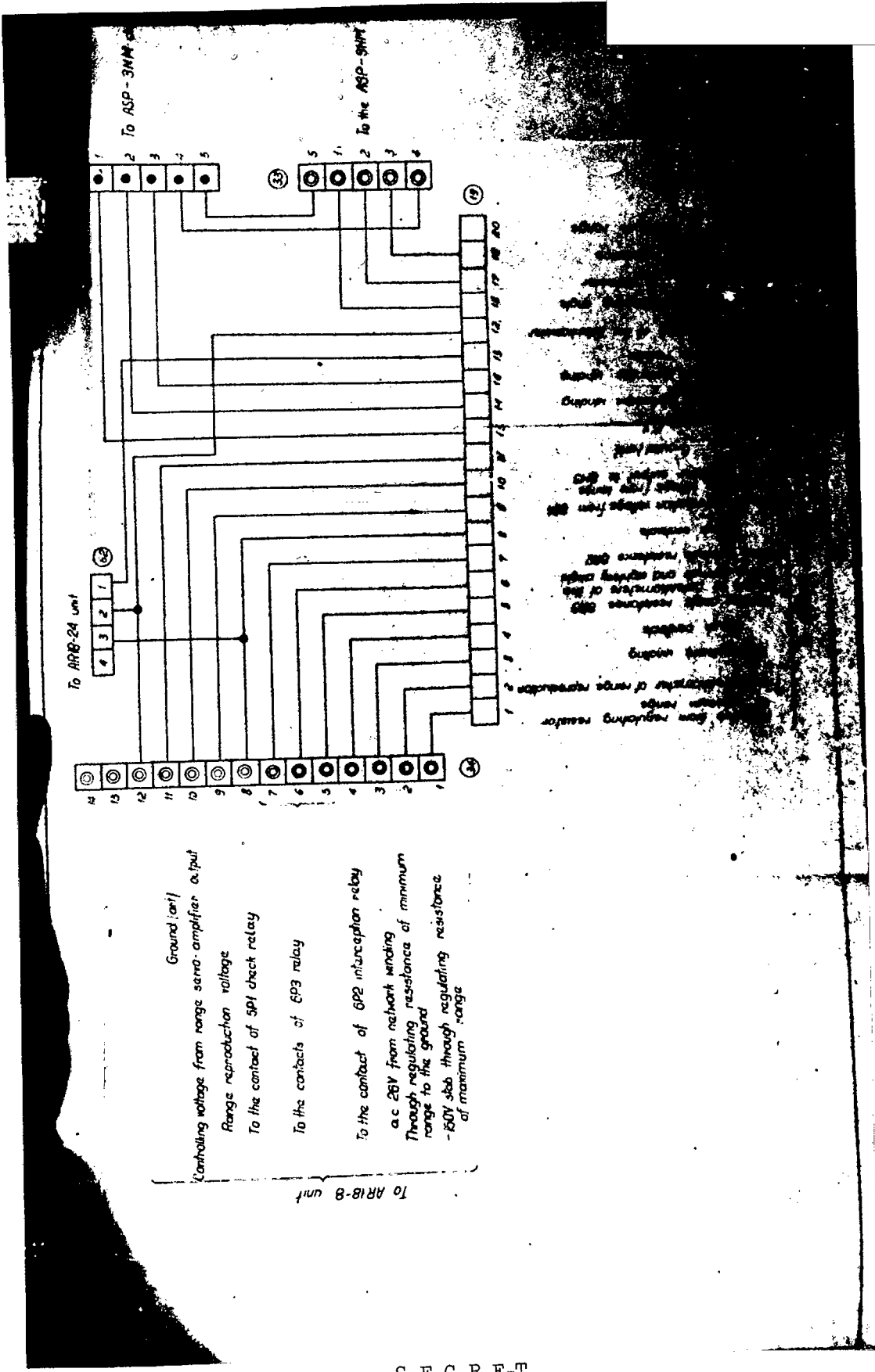

controlling voltage from range servo amplifier output

range reproduction voltage

to the contact of 5P1 sheet relay

to the contacts of 6P3 relay

to the contact of 6P2 interception relay

a.c. 26V from network winding through regulating resistance of minimum range to the ground - 150V slab through regulating resistance of maximum range

S-E-C-R-E-T

NO FOREIGN DISSEM

117

S-E-C-R-E-T
NO FOREIGN DISSEM

50X1

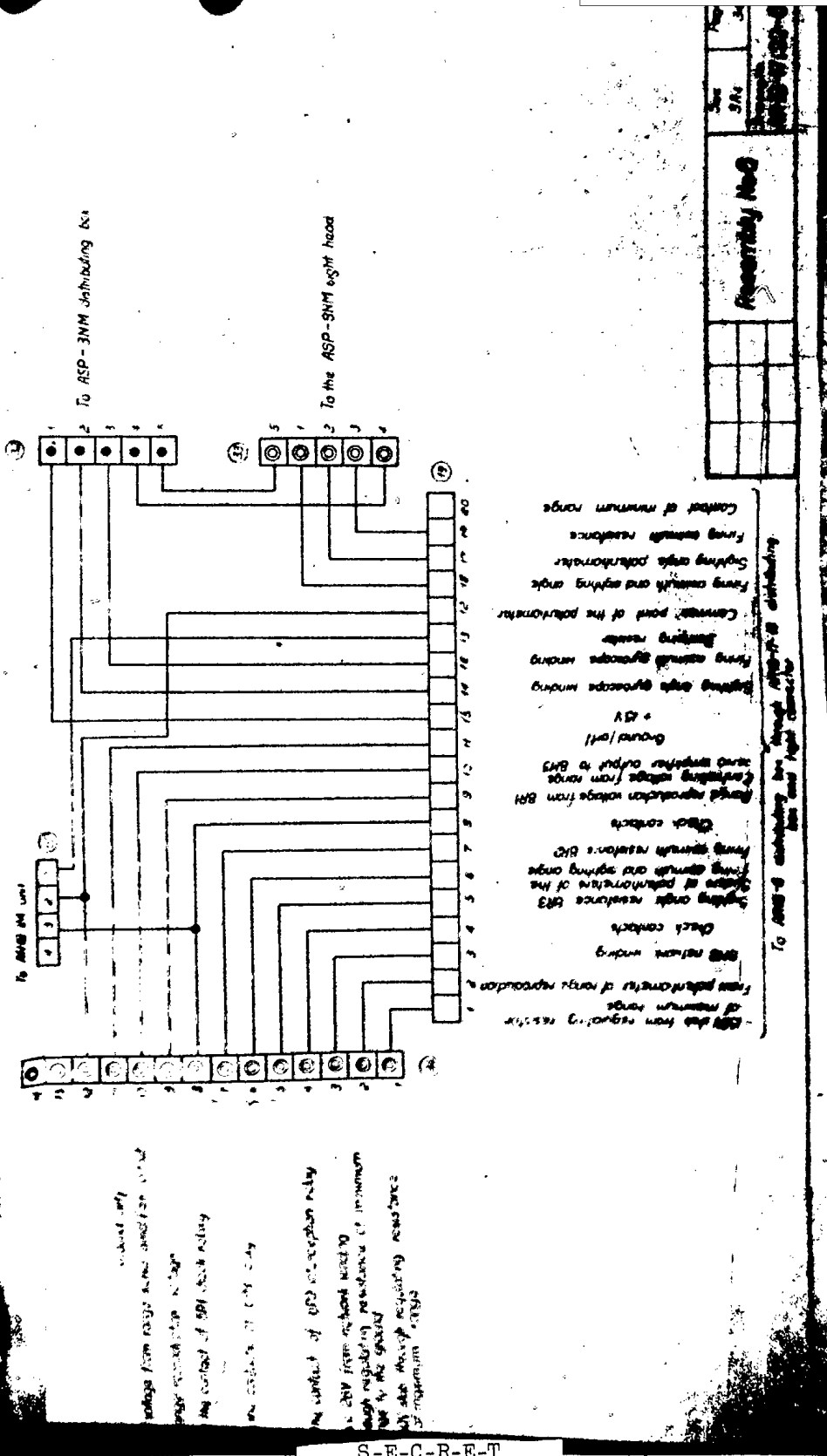

S-E-C-R-E-T
NO FOREIGN DISSEM

S-E-C-R-E-T
NO FOREIGN DISSEM

50X1

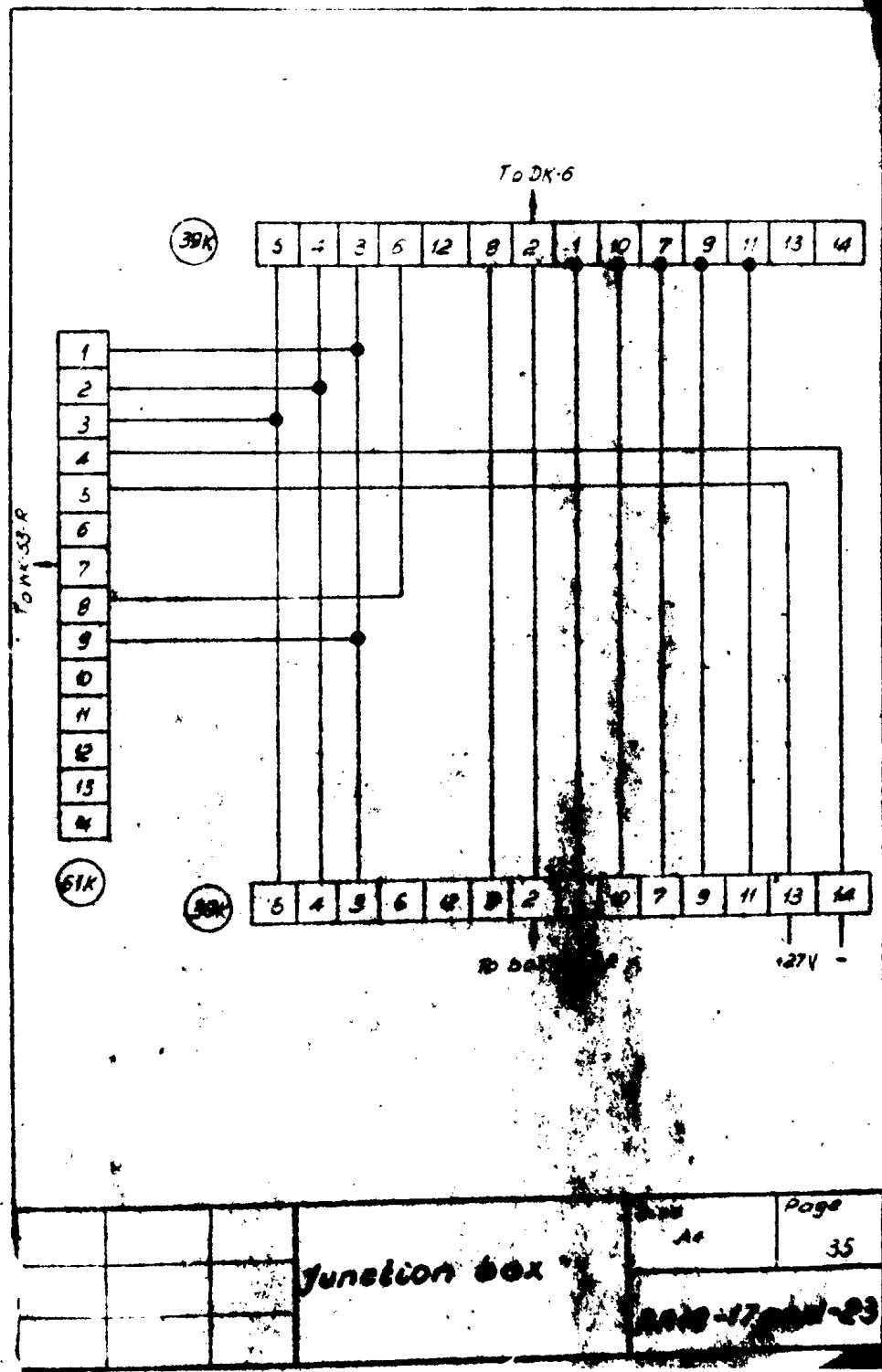

S-E-C-R-E-T
NO FOREIGN DISSEM

NO FOREIGN DISSEM



50X1

SECRET

NO FOREIGN DISSEM

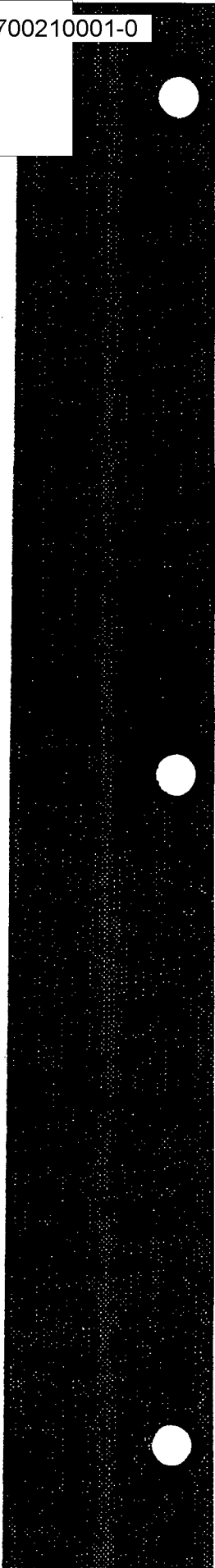

SECRET
NO FOREIGN DISSEM

50X1

RP-5 RADAR STATION
WIRING DIAGRAMS
(English Language)

SECRET
NO FOREIGN DISSEM

GROUP 1
Excluded from automatic
downgrading and
declassification

S-E-C-R-E-T
NO FOREIGN DISSEM

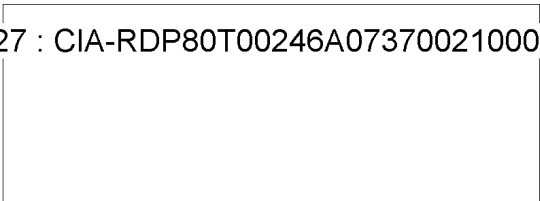

50X1

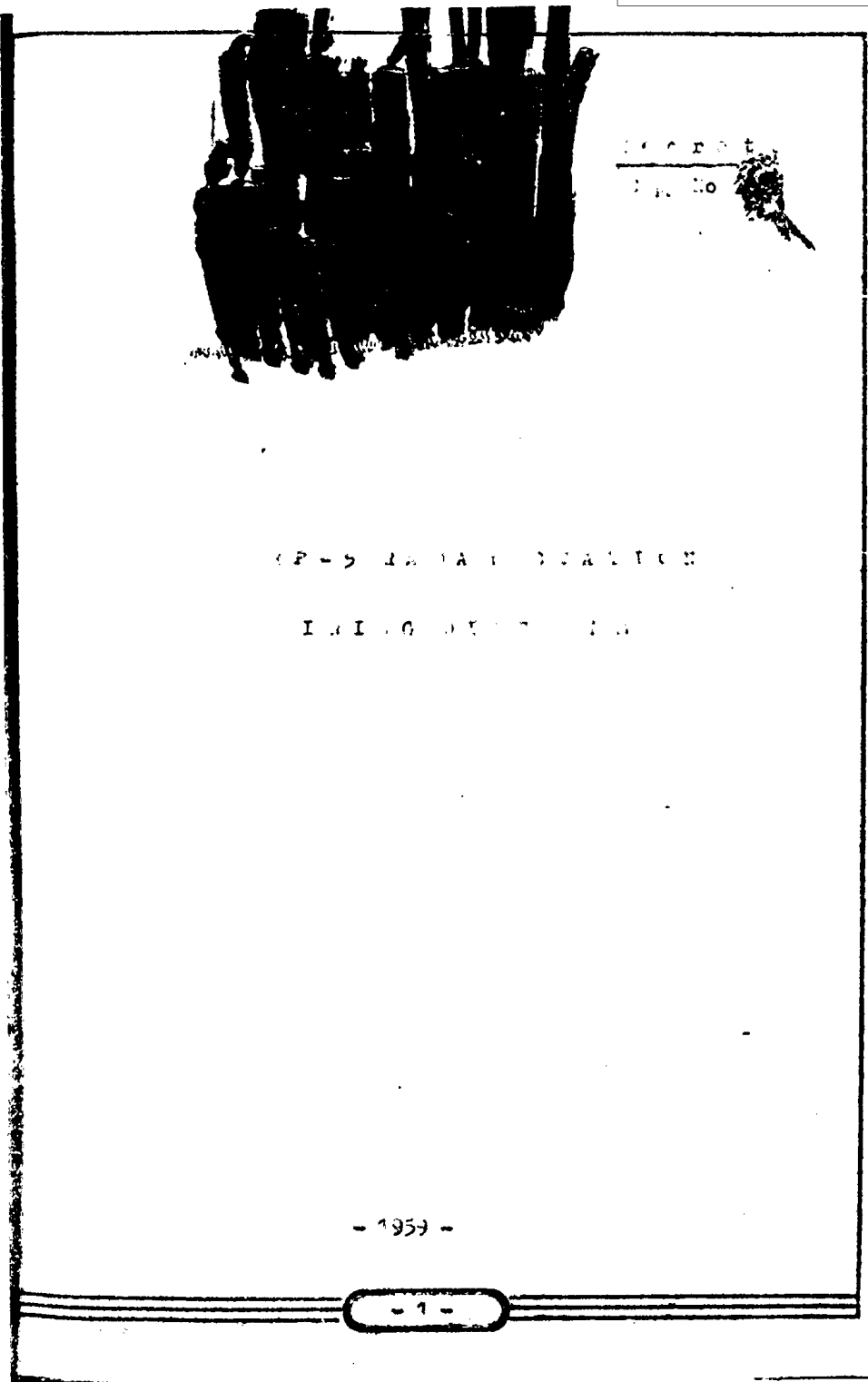

S-E-C-R-E-T
NO FOREIGN DISSEM

S-E-C-R-E-T
NO FOREIGN DISSEM

50X1

Item	Name of diagram	No. of diagrams	Page	Notes
1	Decoding aerial key diagram	AR18-1-1-00	5	
2	Wiring diagram	AR18-1-1-000	6	
3	Wiring diagram	AR18-1-1-00	7	
4	JFFA wiring diagram	AR18-2-7-000	8	
5	Unit No 3 wiring diagram	AR18-3-0-000	9	
6	Subassembly No 1 wiring diagram	AR18-3-1-000	10	
7	Subassembly No 2 wiring diagram	AR18-3-2-000	11	
8	Subassembly No2 wiring diagram	AR18-3-3-000	12	
9	Indicator wiring diagram	AR18-3-0-000	13	
10	Time base unit wiring diagram	AR18-3-0-000	14	
11	Subassembly No 1 wiring diagram	AR18-3-1-000	15	
12	Subassembly No 2 wiring diagram	AR18-3-2-000	16	
13	Range coordinate tracking unit wiring diagram	AR18-3-3-000	17	
14	Range tracking unit wiring diagram	AR18-3-4-000	18	
15	Subassembly No1 wiring diagram	AR18-3-1-000	19	

- 2 -
S-E-C-R-E-T

NO FOREIGN DISSEM

S-E-C-R-E-T
NO FOREIGN DISSEM

50X1

16	Subassembly No 2 wiring diagram	AR18-10-2-000	20
17	Wiring diagram	AR18-11-0-000	21
18	Subassembly No 1 wiring diagram	AR18-11-1-000	22
19	Subassembly No 2 wiring diagram	AR18-11-2-000	23
20	Azimuth time base and supply unit wiring diagram	AR18-12-0-000	24
21	Subassembly No 1 wiring diagram	AR18-12-1-000	25
22	Subassembly No 2 wiring diagram	AR18-12-2-000	26
23	Servoamplifier unit wiring dia.	AR18-13-0-000	27
24	Unit No 21 wiring diagram	AR18-14-0-000	28
25	Subassembly No 1 wiring diagram	AR18-21-1-000	29

S-E-C-R-E-T

NO FOREIGN DISSEM

S-E-C-R-E-T
NO FOREIGN DISSEM

50X1

26	Subassembly No 2 wiring diagram	AR18-24-2-000	30	
27	Unit No 25 wiring diagram	AR18-25-0-000	31	
28	Subassembly No 1 wiring diagram	AR18-25-1-000	32	
29	Subassembly No 2 wiring diagram	AR18-25-2-000	33	
30	Automatic desynchronization unit			
	Wiring diagram	AR18-26-0-000	34	
31	AR-28-16 unit wiring diagram	SI09100237	35	

S-E-C-R-E-T

NO FOREIGN DISSEM

S-E-C-R-E-T
NO FOREIGN DISSEM

50X1

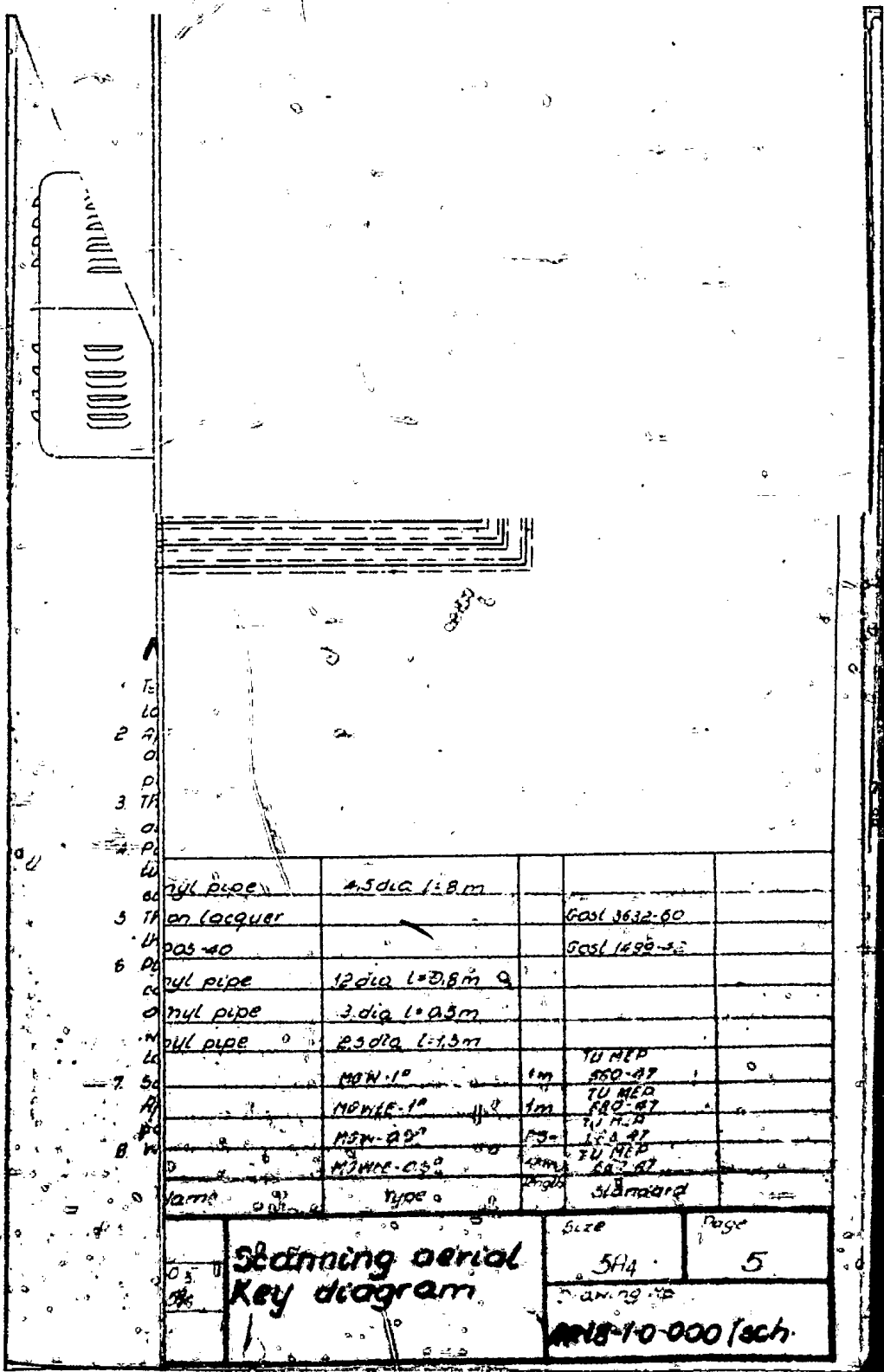

1	nyl pipe	2.5 dia l=1.8m		
2	en lacquer			Coat 3632-60
3	nyl pipe	12 dia l=2.8m		Coat 1690-52
4	nyl pipe	3 dia l=0.5m		
5	nyl pipe	2.3 dia l=1.5m		
6	M2N-10		1m	TU REP 550-87
7	M2N-10		1m	TU REP 580-87
8	M2N-20		1m	TU REP 580-87
9	M2N-20		1m	TU REP 580-87
10	Standard			Standard

Scanning aerial
Key diagram

Size 5H4 Page 5

ANS-10-000 (sch.

S-E-C-R-E-T
NO FOREIGN DISSEM

S-E-C-R-E-T
NO FOREIGN DISSEM

50X1

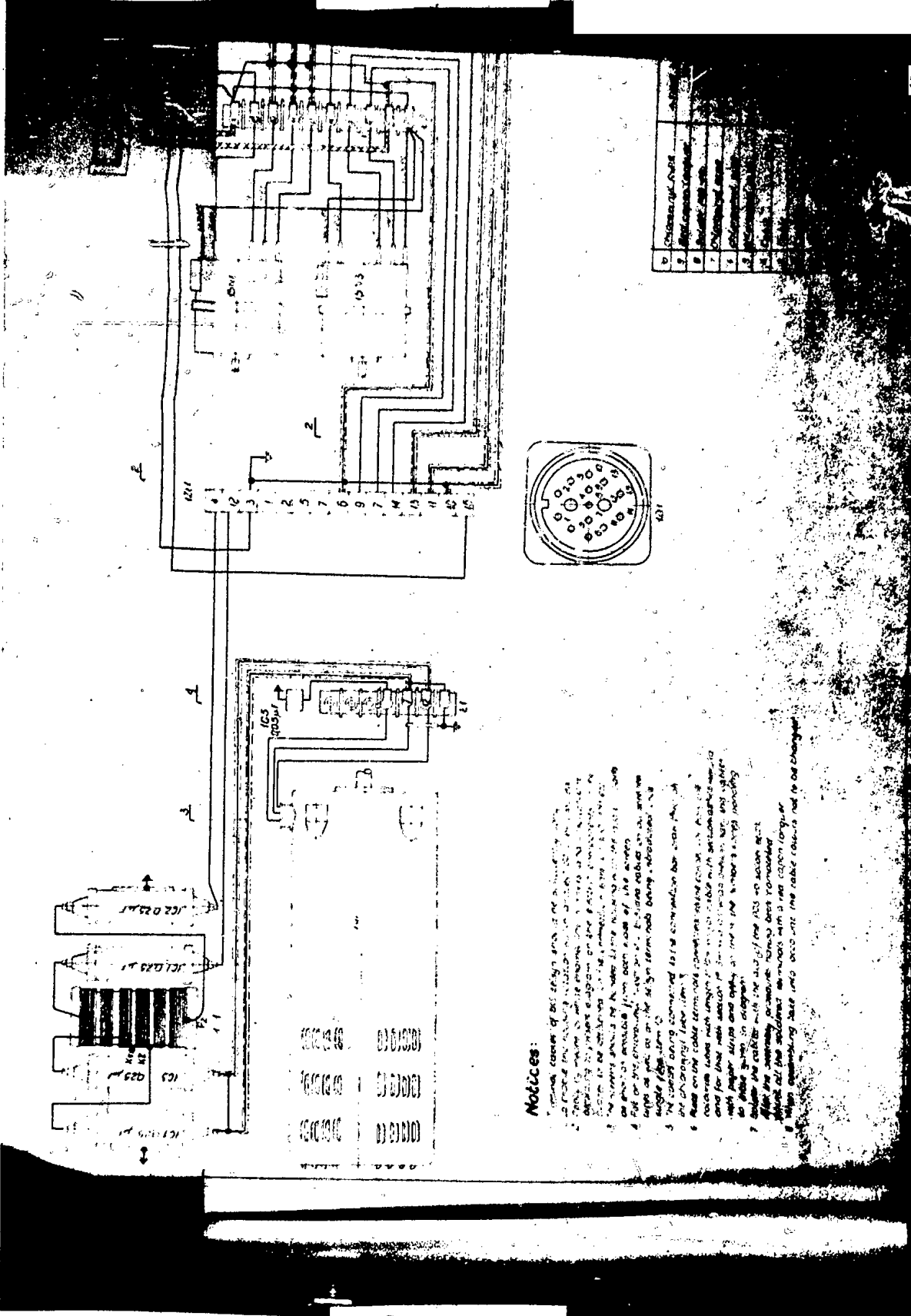

Notices:

1. The cables being connected to the computer bar with the 427 terminal block must be connected to the computer bar with the 427 terminal block.
2. The cables being connected to the computer bar with the 427 terminal block must be connected to the computer bar with the 427 terminal block.
3. The cables being connected to the computer bar with the 427 terminal block must be connected to the computer bar with the 427 terminal block.
4. The cables being connected to the computer bar with the 427 terminal block must be connected to the computer bar with the 427 terminal block.
5. The cables being connected to the computer bar with the 427 terminal block must be connected to the computer bar with the 427 terminal block.
6. The cables being connected to the computer bar with the 427 terminal block must be connected to the computer bar with the 427 terminal block.
7. The cables being connected to the computer bar with the 427 terminal block must be connected to the computer bar with the 427 terminal block.
8. The cables being connected to the computer bar with the 427 terminal block must be connected to the computer bar with the 427 terminal block.

S-E-C-R-E-T
NO FOREIGN DISSEM

S-E-C-R-E-T
NO FOREIGN DISSEM

50X1

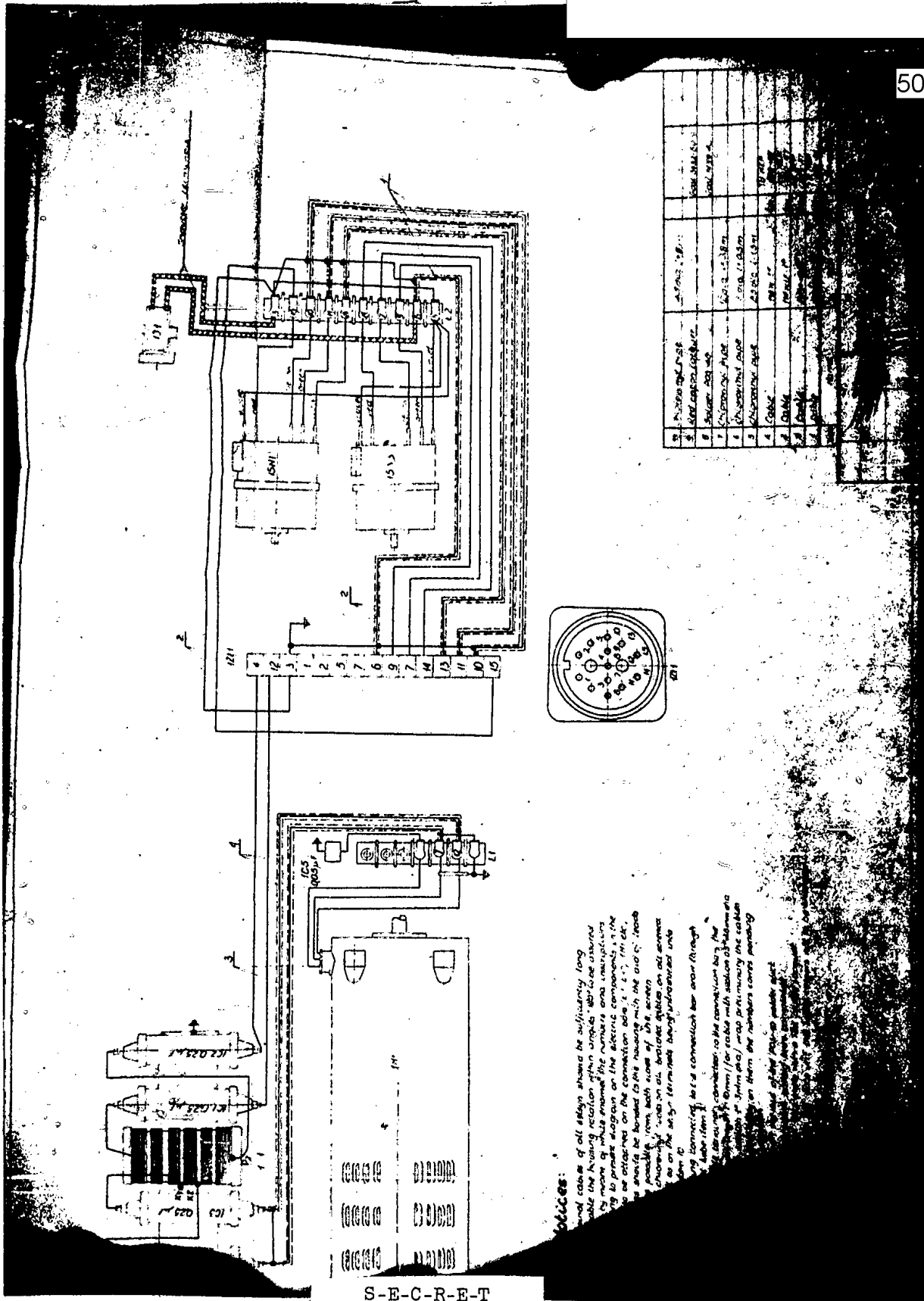

1	2	3	4	5	6	7	8	9	10	11	12	13	14	15
...

Notes:
 1. In all cases of all wiring should be sufficiently long
 2. While the housing section when simple, should be secured
 3. by means of which ensure the number and connections
 4. to prime diagram on the electric components in the
 5. to be attached on the connection side of the
 6. should be bonded to the housing with the aid of
 7. possible from both sides of the wires
 8. (Chromel) was on all brackets which on all wires
 9. to on the only terminals being introduced into
 10. by connecting to a connection bar area through
 11. laboratory connector to the connection bar the
 12. (3mm) for factor with section of the wire and
 13. at the end with preliminary the cable
 14. on them the number series marking
 15. of the top-up cable sheet
 16. with the number series marking

S-E-C-R-E-T
NO FOREIGN DISSEM

S-E-C-R-E-T
NO FOREIGN DISSEM

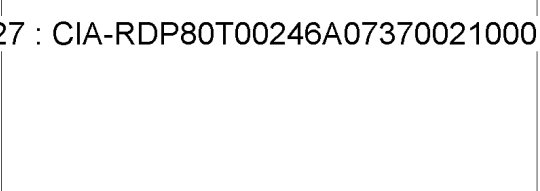

50X1

Secret

<i>Wiring diagram</i>	<i>size</i> 21A4	<i>Page</i> 6
AR13-2-0-000M		

Assembly 11

S-E-C-R-E-T
NO FOREIGN DISSEM

S-E-C-R-E-T
NO FOREIGN DISSEM

50X1

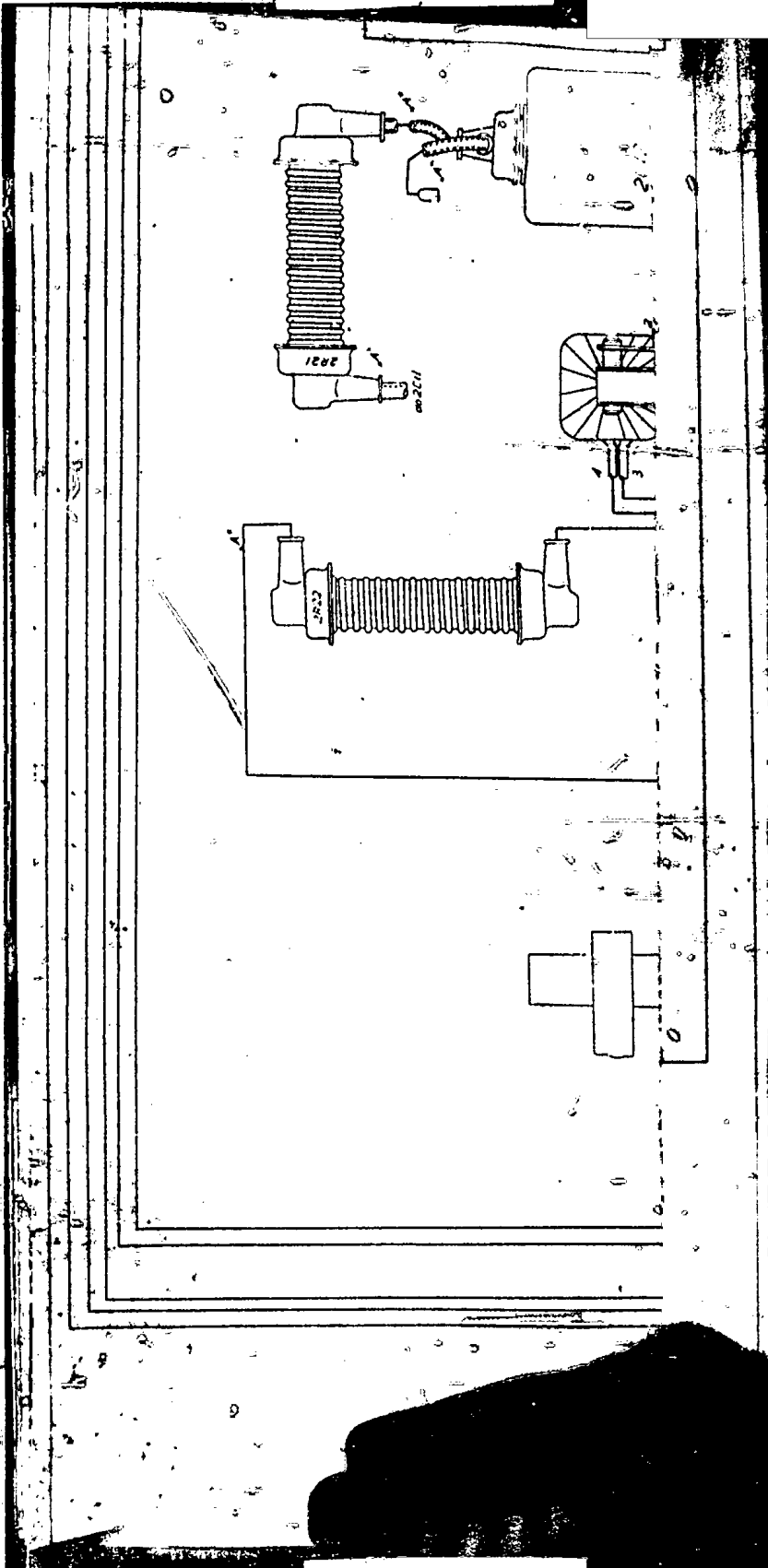

S-E-C-R-E-T
NO FOREIGN DISSEM

S-E-C-R-E-T
NO FOREIGN DISSEM

50X1

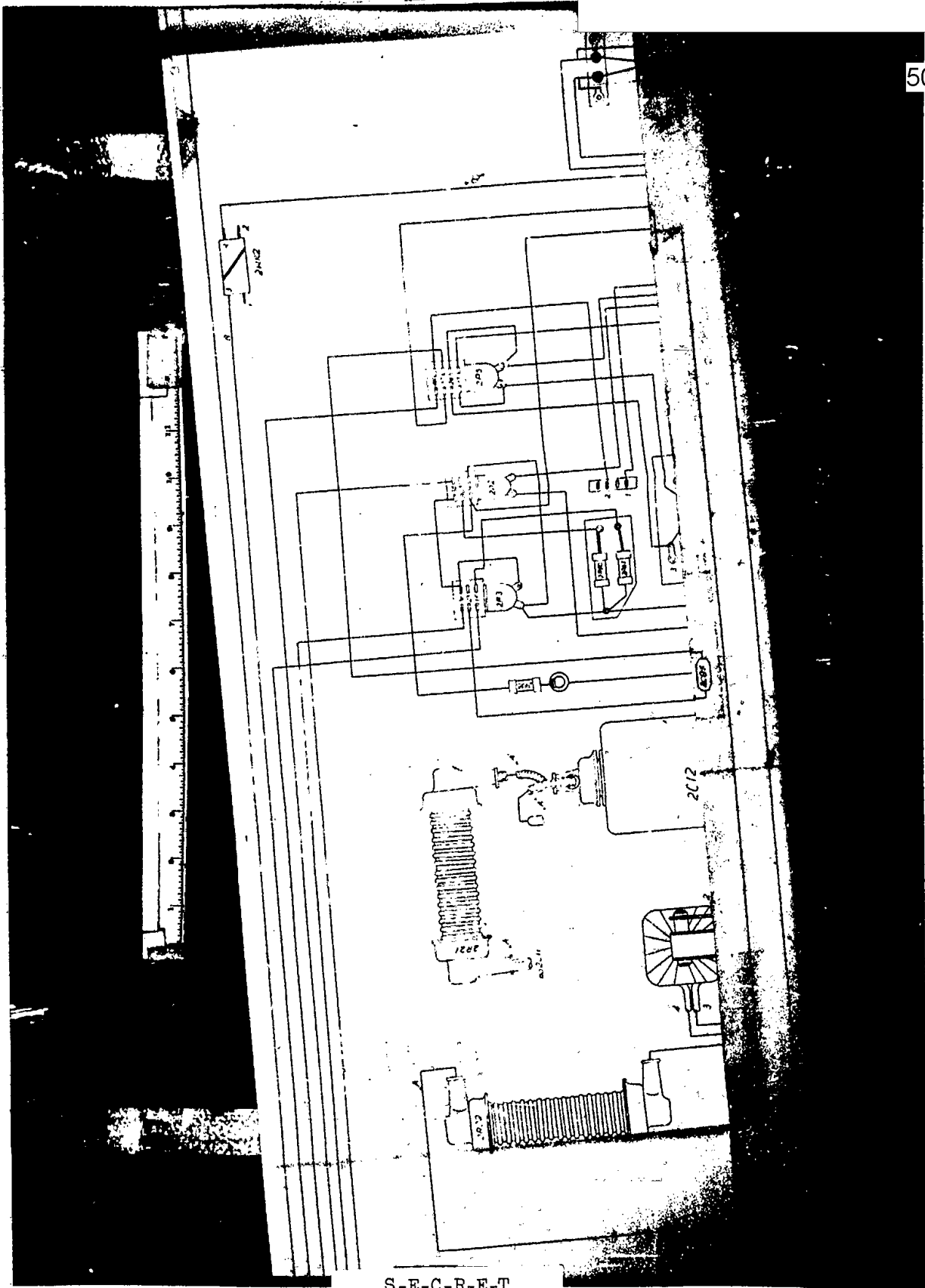

S-E-C-R-E-T

NO FOREIGN DISSEM

10

S-E-C-R-E-T
NO FOREIGN DISSEM

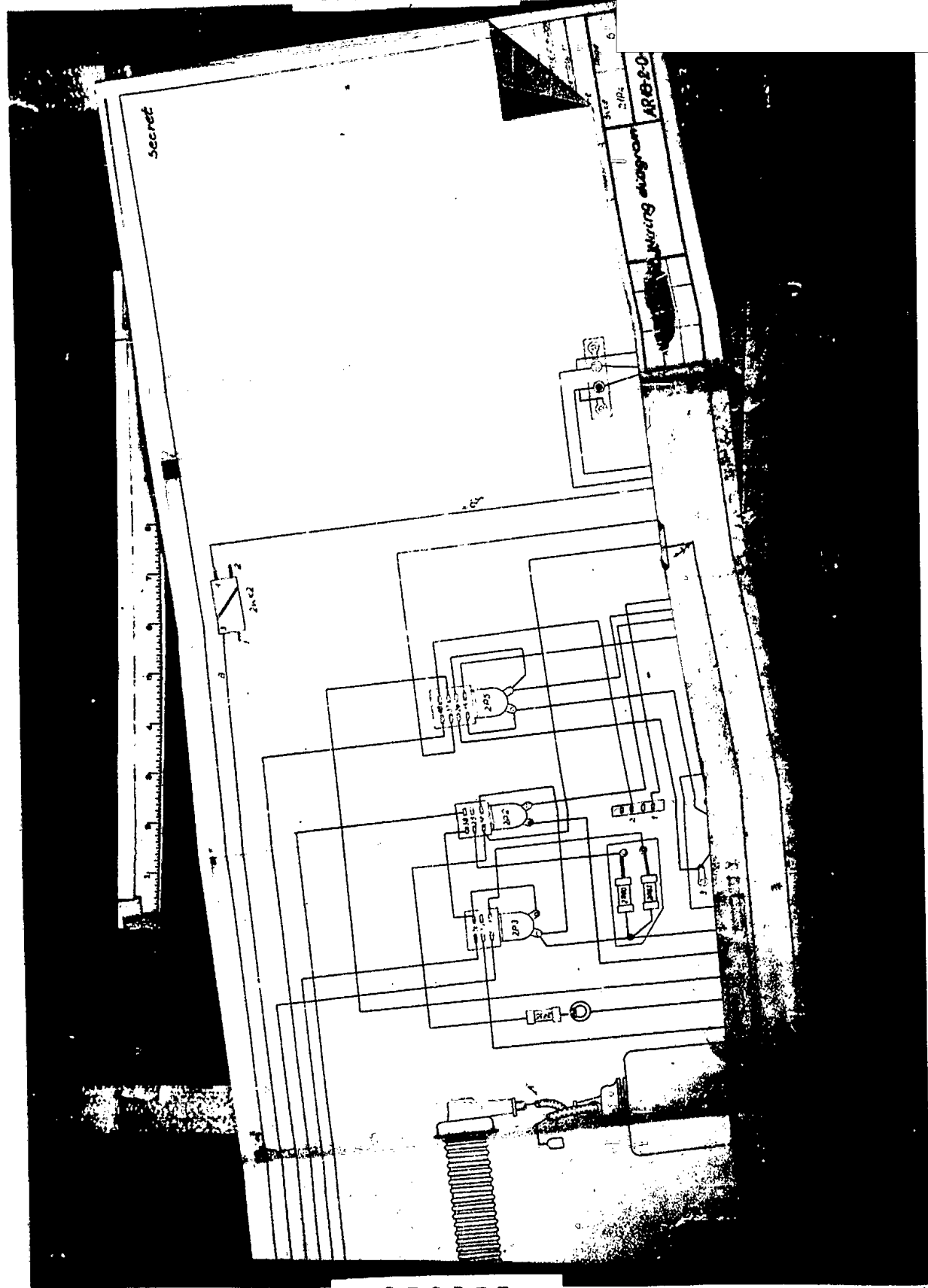

50X1

S-E-C-R-E-T

NO FOREIGN DISSEM

S-E-C R E T
NO FOREIGN DISSEM

50X1

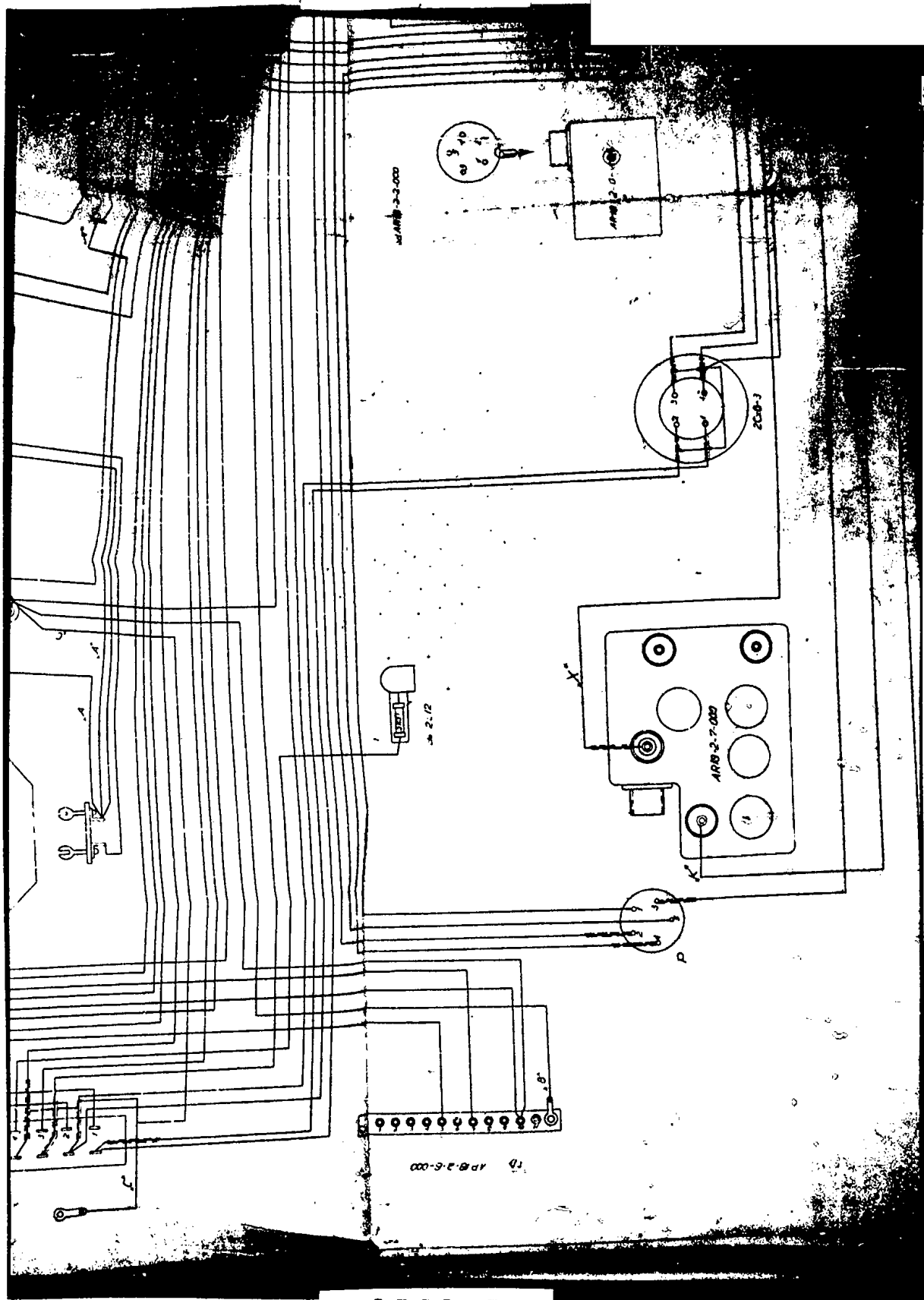

S-E-C-R-E-T

NO FOREIGN DISSEM

S-E-C-R-E-T
NO FOREIGN DISSEM

50X1

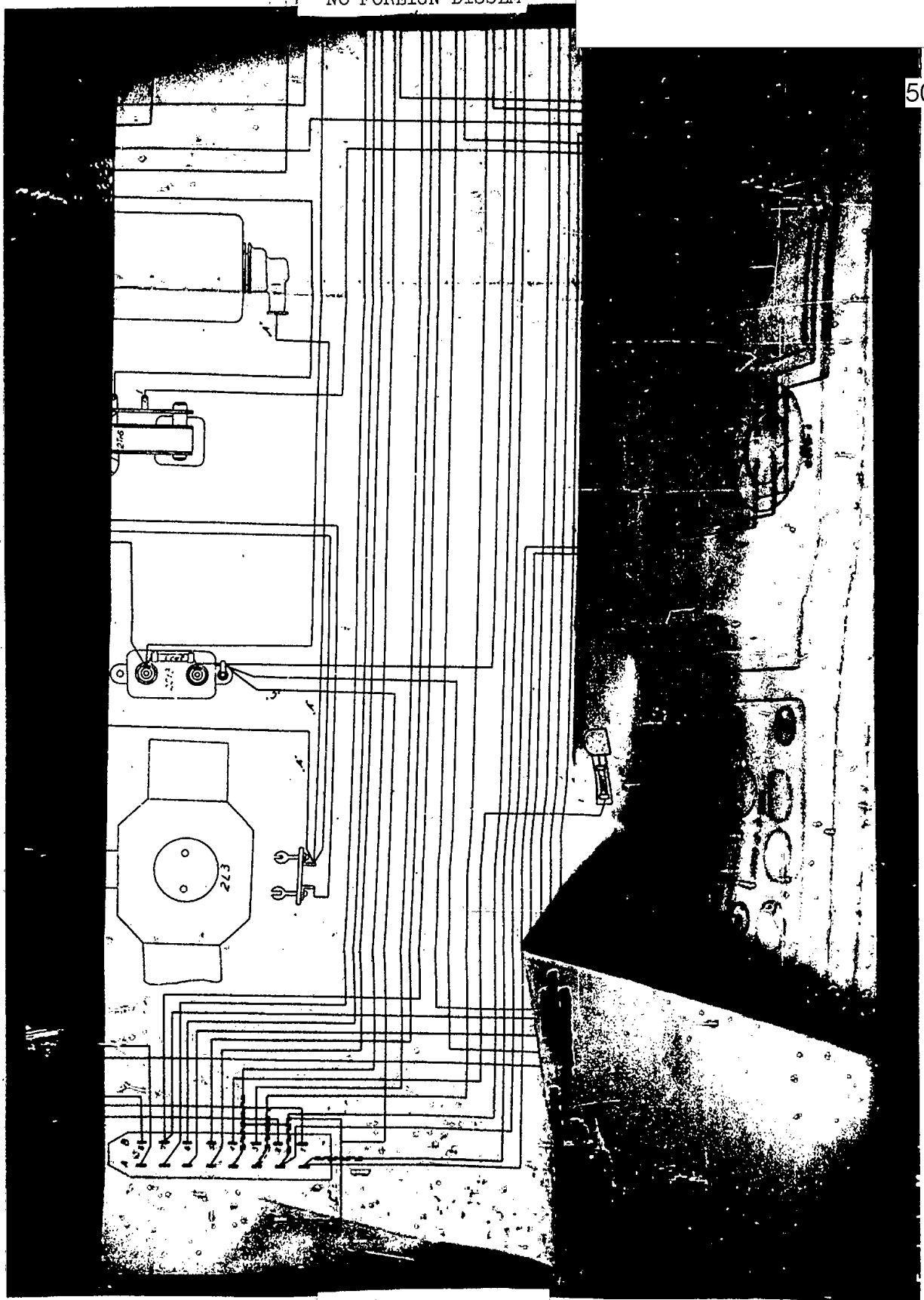

S-E-C-R-E-T
NO FOREIGN DISSEM

15

S-E-C-R-E-T
NO FOREIGN DISSEM

50X1

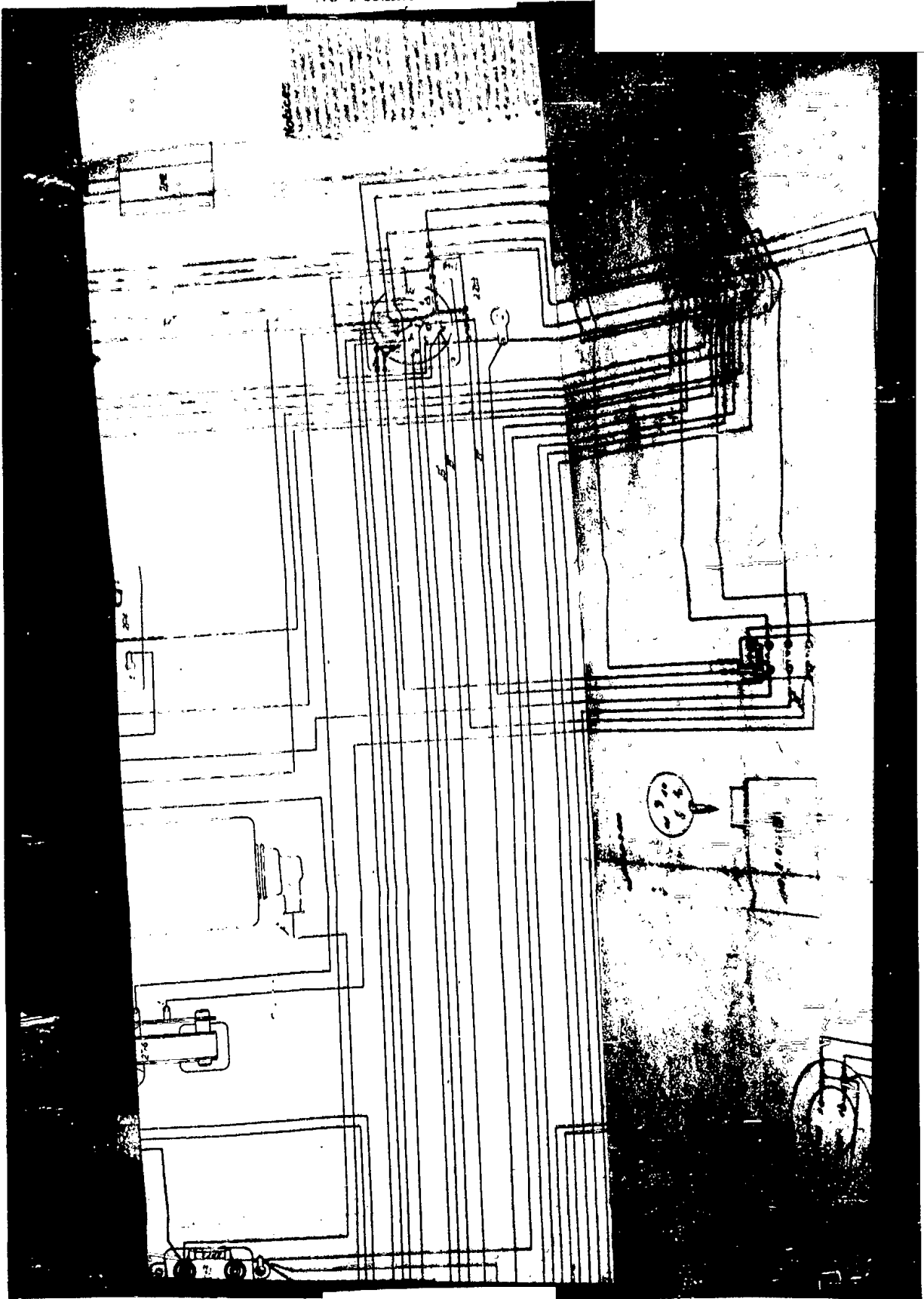

S-E-C-R-E-T

NO FOREIGN DISSEM

S-E-C-R-E-T
NO FOREIGN DISSEM

50X1

NOTICES:

1. This document contains information which is classified as "Secret" and is to be controlled in accordance with the provisions of Executive Order 11652, and is to be controlled in accordance with the provisions of Executive Order 11652, and is to be controlled in accordance with the provisions of Executive Order 11652.
2. This document contains information which is classified as "Secret" and is to be controlled in accordance with the provisions of Executive Order 11652, and is to be controlled in accordance with the provisions of Executive Order 11652, and is to be controlled in accordance with the provisions of Executive Order 11652.
3. This document contains information which is classified as "Secret" and is to be controlled in accordance with the provisions of Executive Order 11652, and is to be controlled in accordance with the provisions of Executive Order 11652, and is to be controlled in accordance with the provisions of Executive Order 11652.
4. This document contains information which is classified as "Secret" and is to be controlled in accordance with the provisions of Executive Order 11652, and is to be controlled in accordance with the provisions of Executive Order 11652, and is to be controlled in accordance with the provisions of Executive Order 11652.
5. This document contains information which is classified as "Secret" and is to be controlled in accordance with the provisions of Executive Order 11652, and is to be controlled in accordance with the provisions of Executive Order 11652, and is to be controlled in accordance with the provisions of Executive Order 11652.
6. This document contains information which is classified as "Secret" and is to be controlled in accordance with the provisions of Executive Order 11652, and is to be controlled in accordance with the provisions of Executive Order 11652, and is to be controlled in accordance with the provisions of Executive Order 11652.
7. This document contains information which is classified as "Secret" and is to be controlled in accordance with the provisions of Executive Order 11652, and is to be controlled in accordance with the provisions of Executive Order 11652, and is to be controlled in accordance with the provisions of Executive Order 11652.
8. This document contains information which is classified as "Secret" and is to be controlled in accordance with the provisions of Executive Order 11652, and is to be controlled in accordance with the provisions of Executive Order 11652, and is to be controlled in accordance with the provisions of Executive Order 11652.
9. This document contains information which is classified as "Secret" and is to be controlled in accordance with the provisions of Executive Order 11652, and is to be controlled in accordance with the provisions of Executive Order 11652, and is to be controlled in accordance with the provisions of Executive Order 11652.
10. This document contains information which is classified as "Secret" and is to be controlled in accordance with the provisions of Executive Order 11652, and is to be controlled in accordance with the provisions of Executive Order 11652, and is to be controlled in accordance with the provisions of Executive Order 11652.

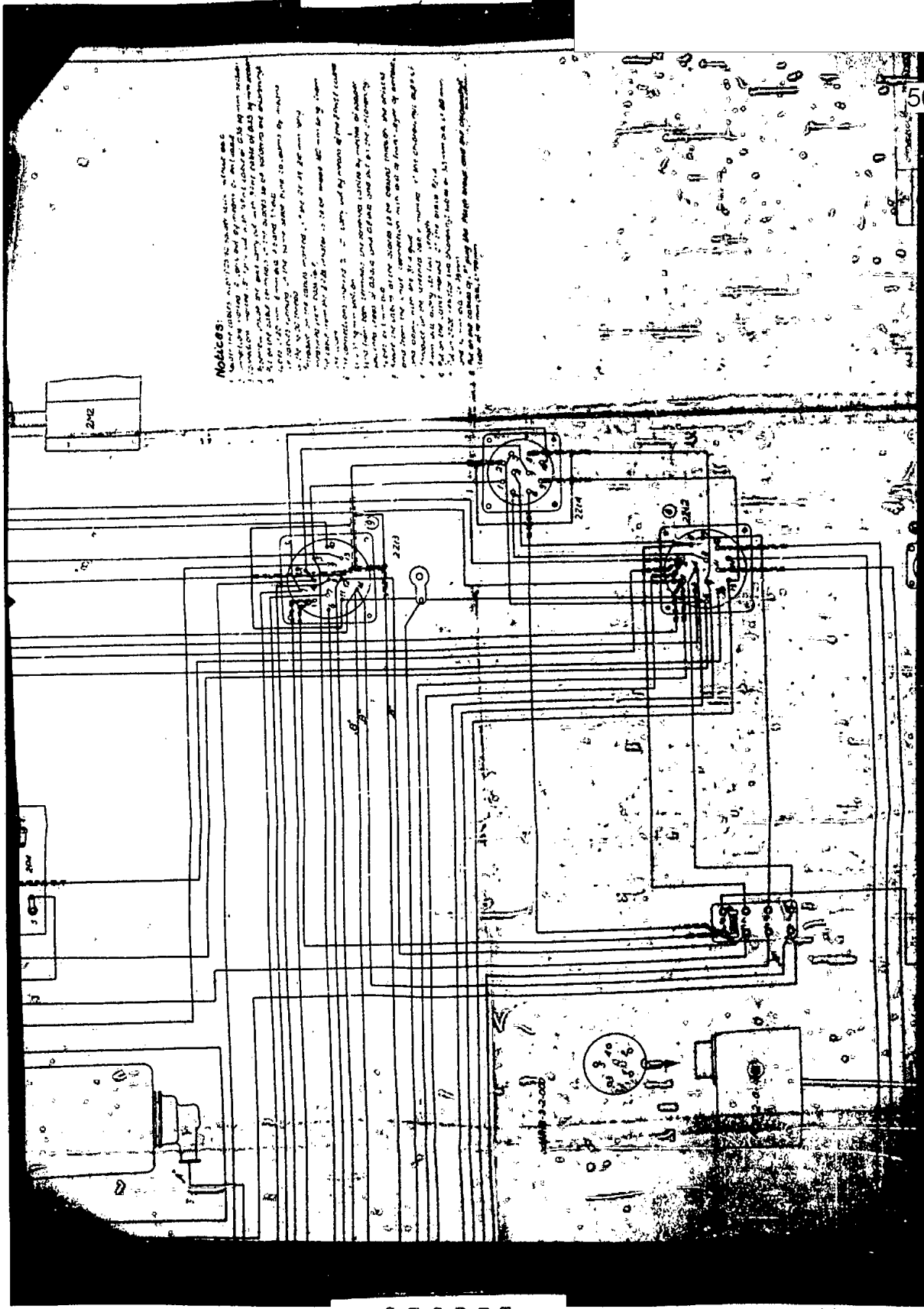

S-E-C-R-E-T
NO FOREIGN DISSEM

S-E-C-R-E-T
NO FOREIGN DISSEM

50X1

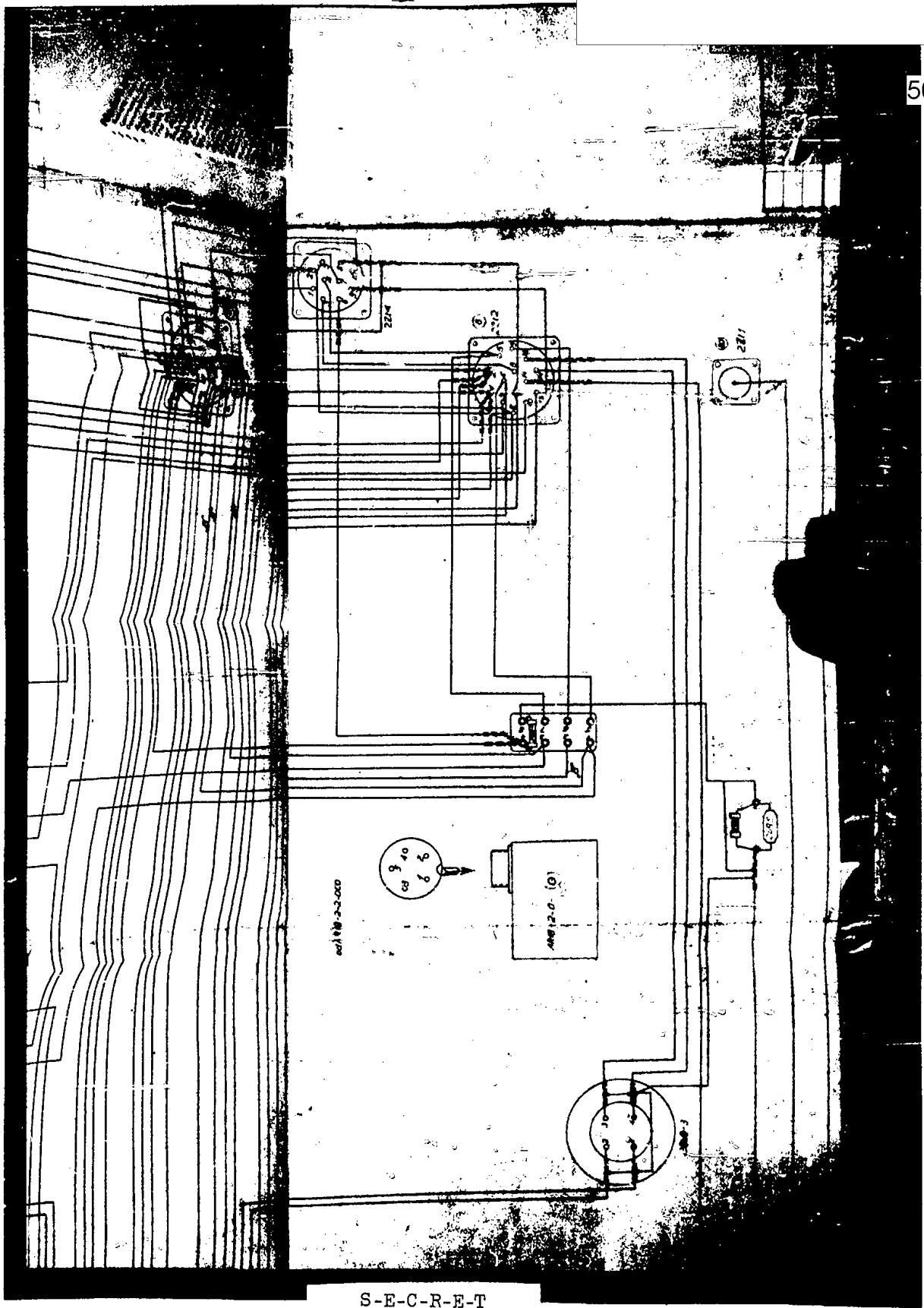

S-E-C-R-E-T
NO FOREIGN DISSEM

S-E-C-R-E-T
NO FOREIGN DISSEM

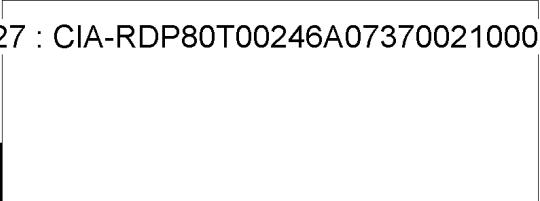

50X1

Notices:

[Faded handwritten notes, illegible]

①	SECRETARY OF DEFENSE	2014
②	SECRETARY OF STATE	
③	SECRETARY OF AGRICULTURE	
④	SECRETARY OF COMMERCE	
⑤	SECRETARY OF ENERGY	
⑥	SECRETARY OF HEALTH AND HUMAN SERVICES	
⑦	SECRETARY OF HOUSING AND URBAN DEVELOPMENT	
⑧	SECRETARY OF INTERIOR	
⑨	SECRETARY OF JUSTICE	
⑩	SECRETARY OF LABOR	
⑪	SECRETARY OF NAVY	
⑫	SECRETARY OF TRANSPORTATION	
⑬	SECRETARY OF WAR	
⑭	SECRETARY OF DEFENSE	

History diagram
AR 155-20

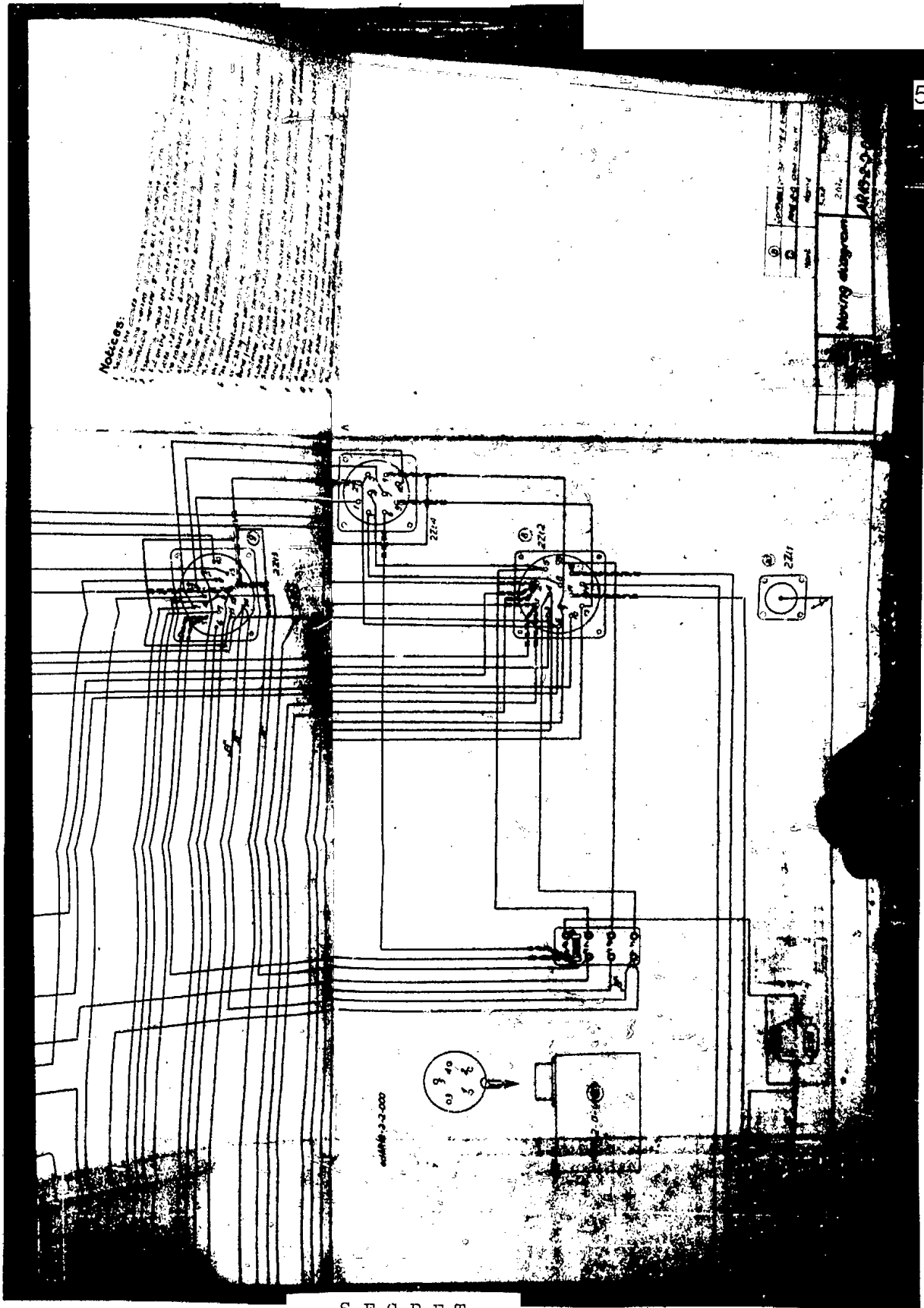

S-E-C-R-E-T

NO FOREIGN DISSEM

S-E-C-R-E-T
NO FOREIGN DISSEM

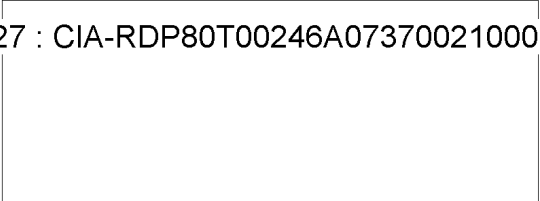

50X1

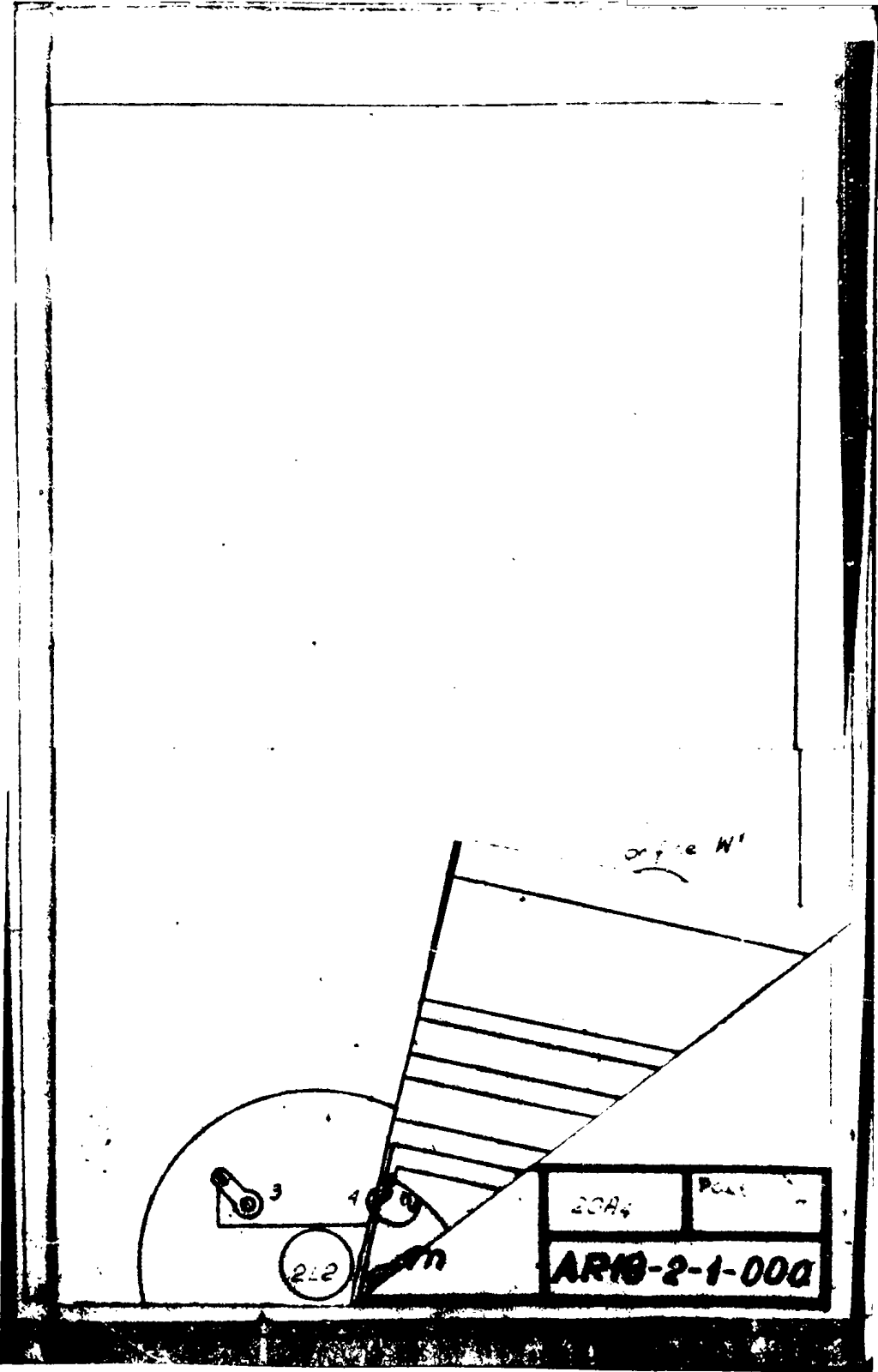

S-E-C-R-E-T

NO FOREIGN DISSEM

S-E-C-R-E-T
NO FOREIGN DISSEM

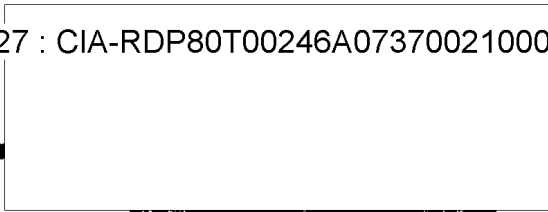

50X1

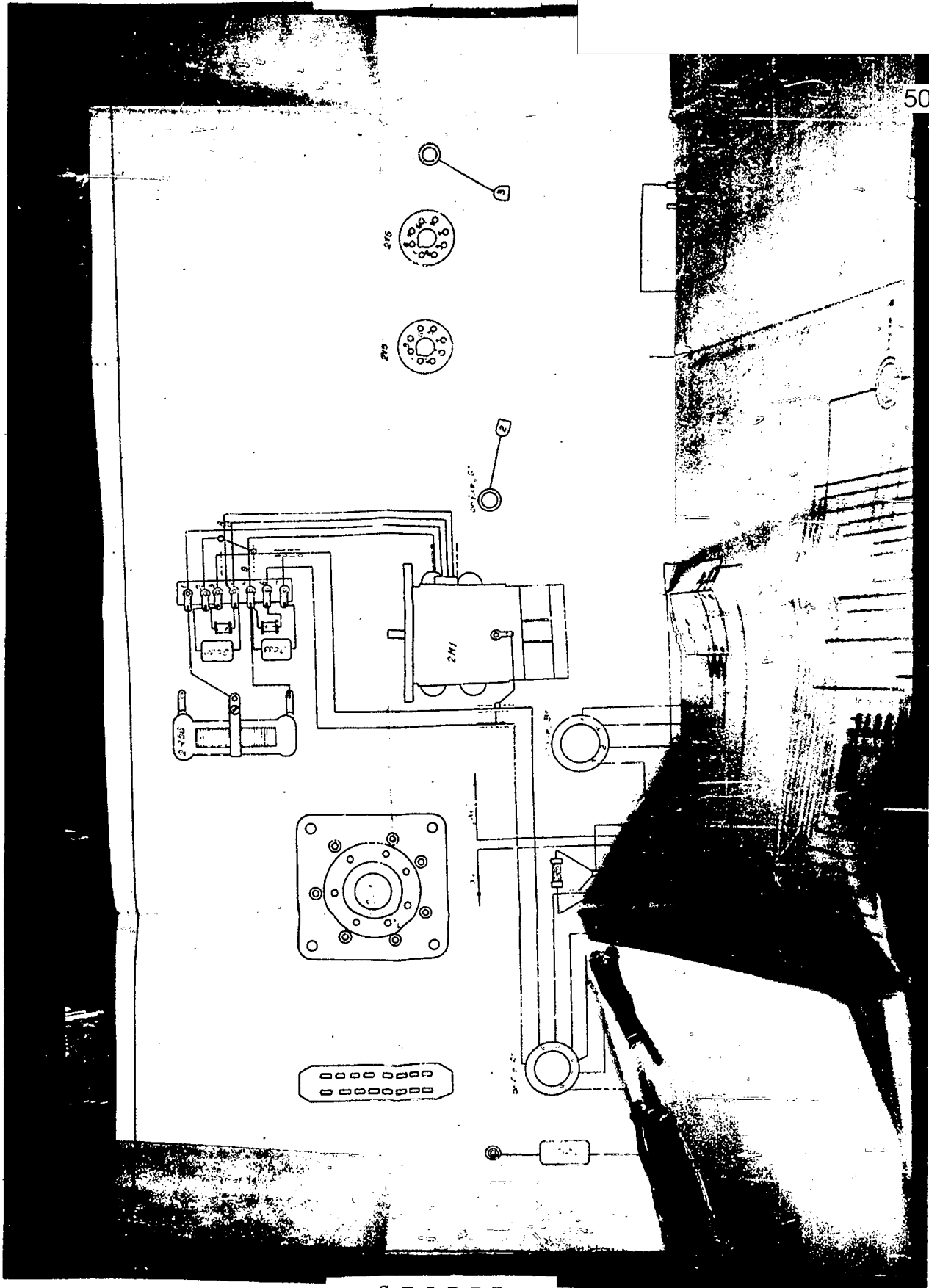

S-E-C-R-E-T

NO FOREIGN DISSEM

7

S-E-C-R-E-T
NO FOREIGN DISSEM

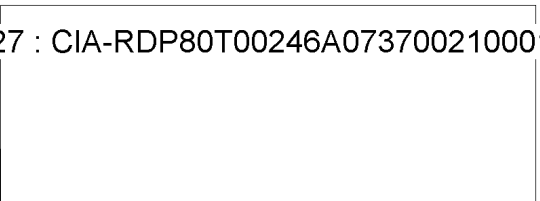

50X1

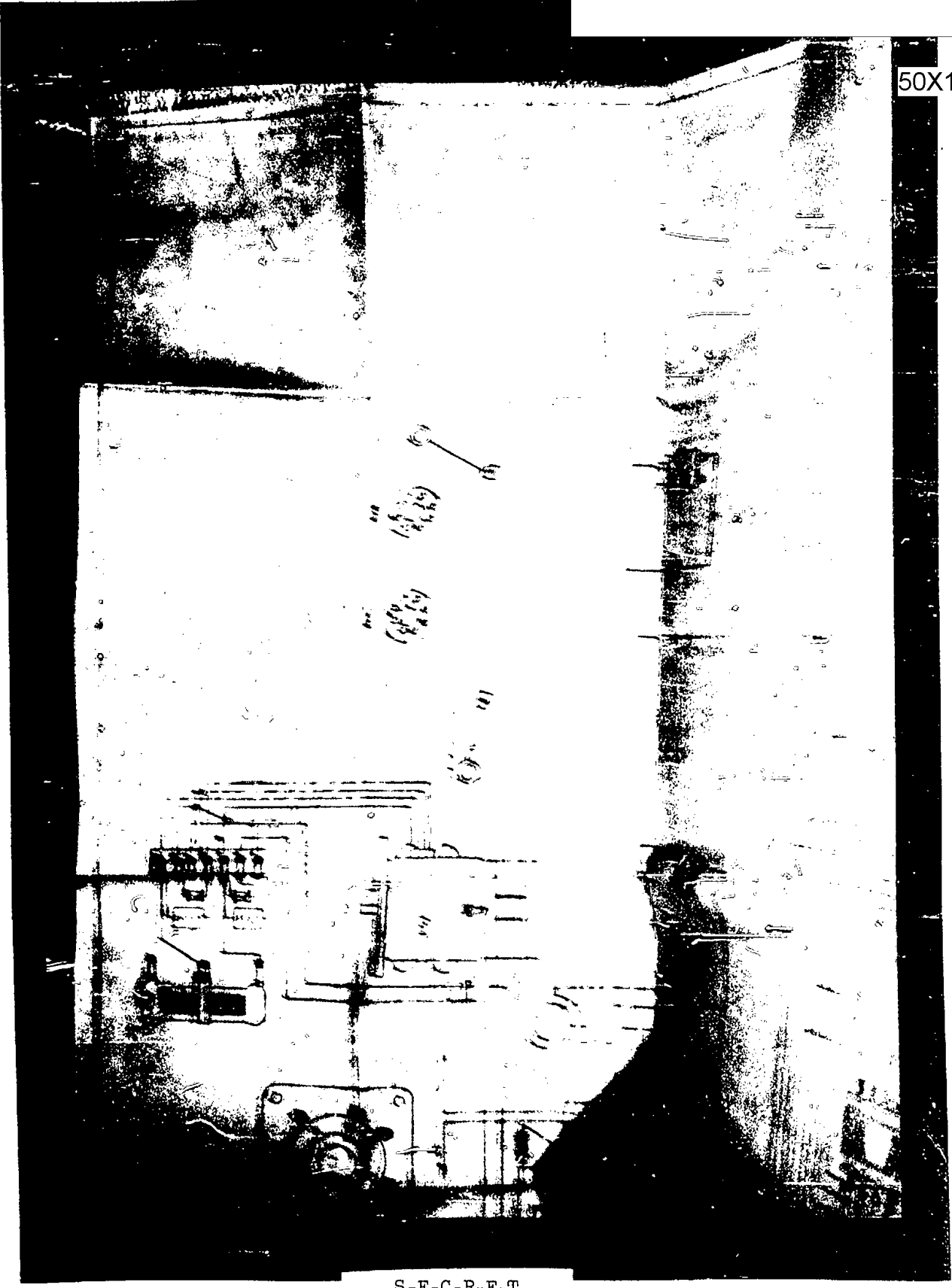

S-E-C-R-E-T

NO FOREIGN DISSEM

2

S-E-C-R-E-T
NO FOREIGN DISSEM

50X1

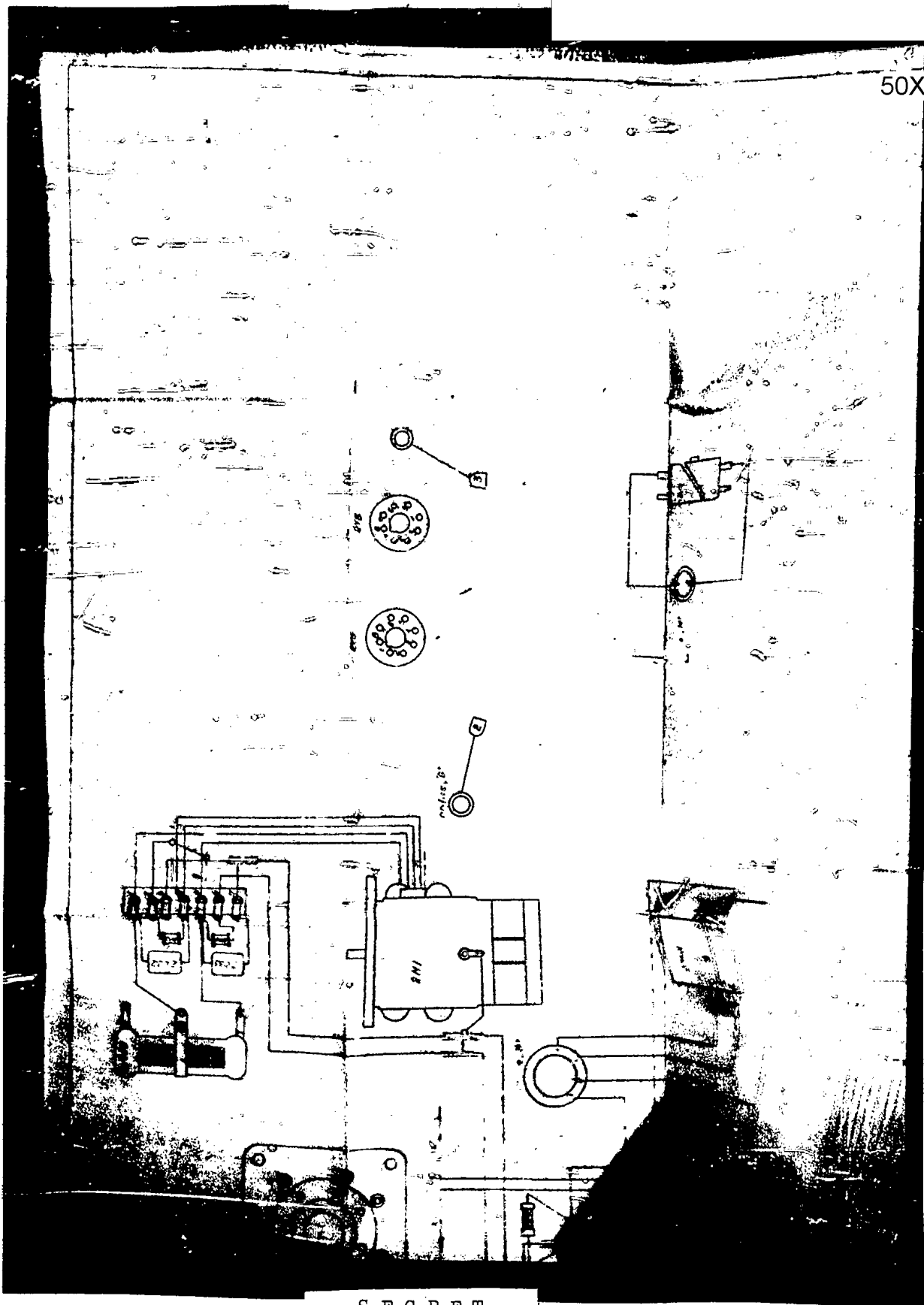

S-E-C-R-E-T
NO FOREIGN DISSEM

S-E-C-R-E-T
NO FOREIGN DISSEM

50X1

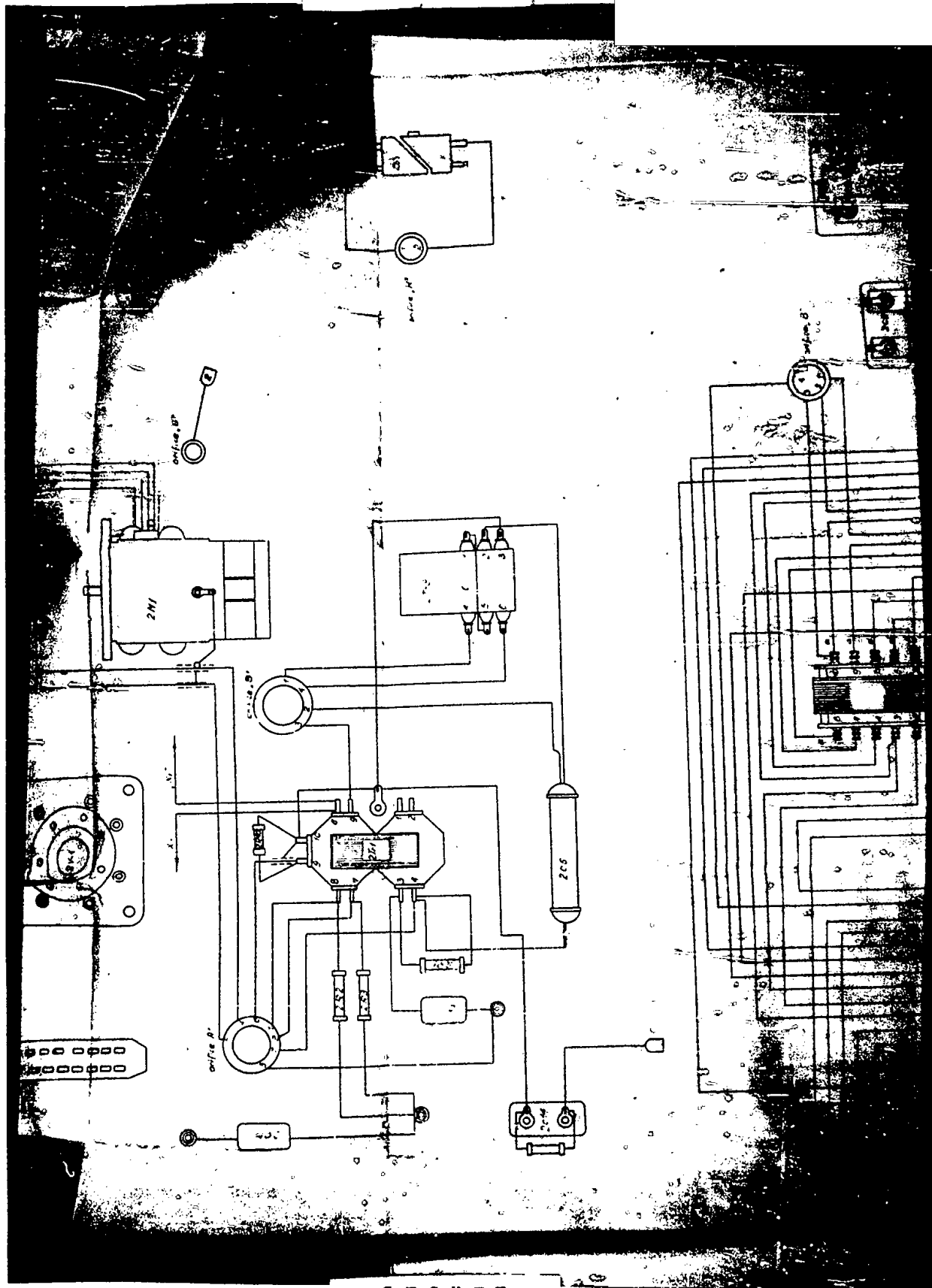

S-E-C-R-E-T
NO FOREIGN DISSEM

S-E-C-R-E-T
NO FOREIGN DISSEM

50X1

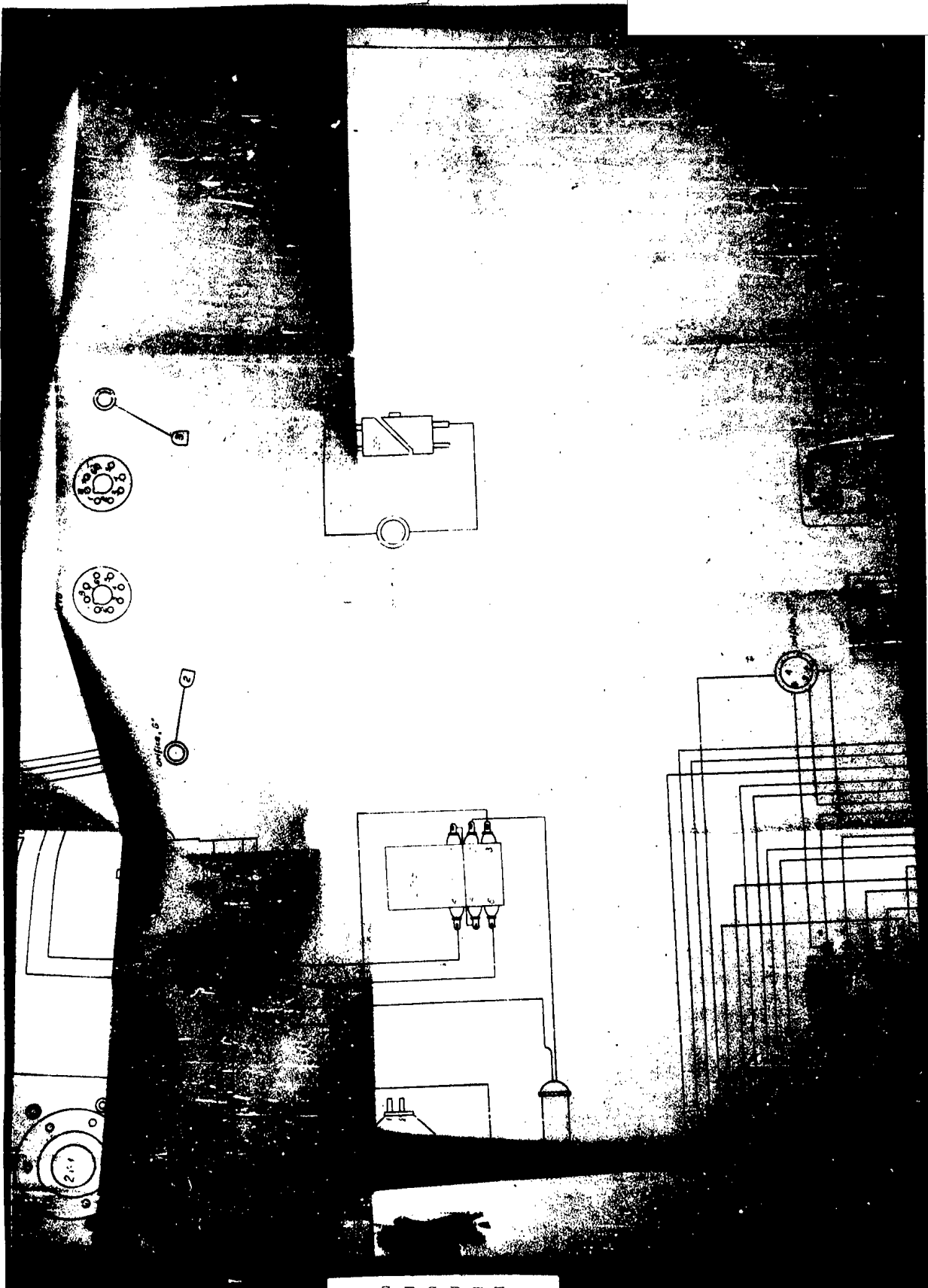

S-E-C-R-E-T
NO FOREIGN DISSEM

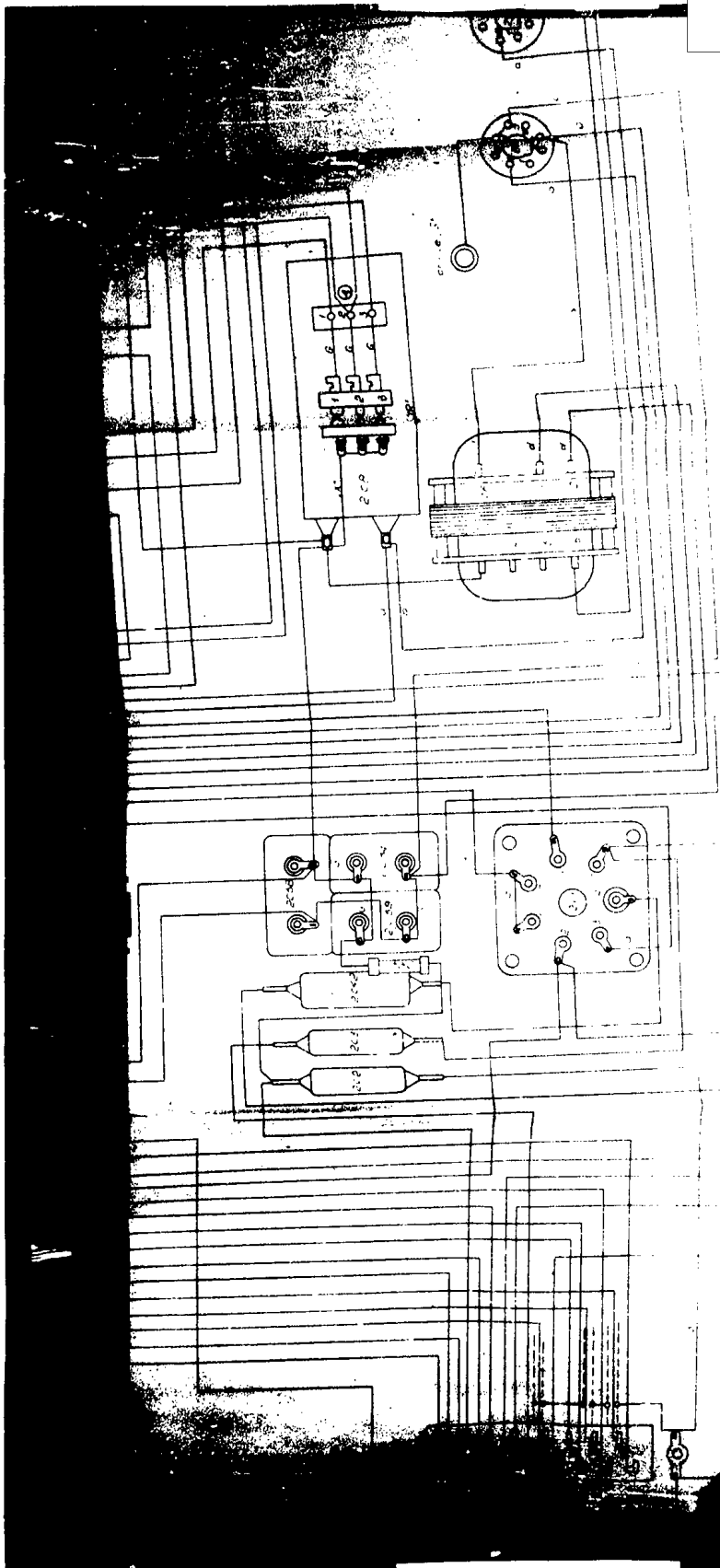

50X1

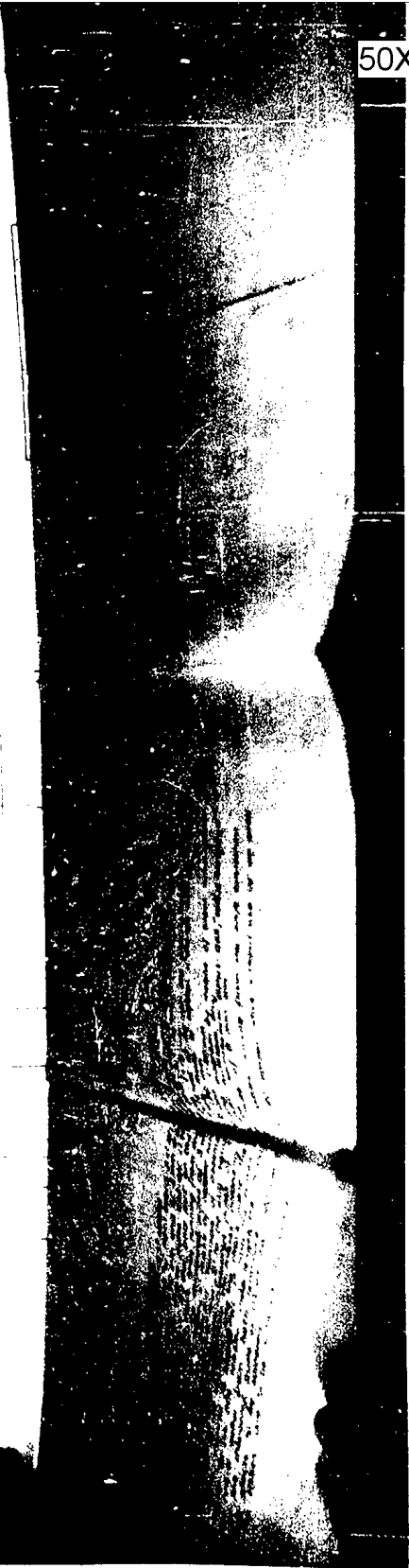

SECRET

50X1

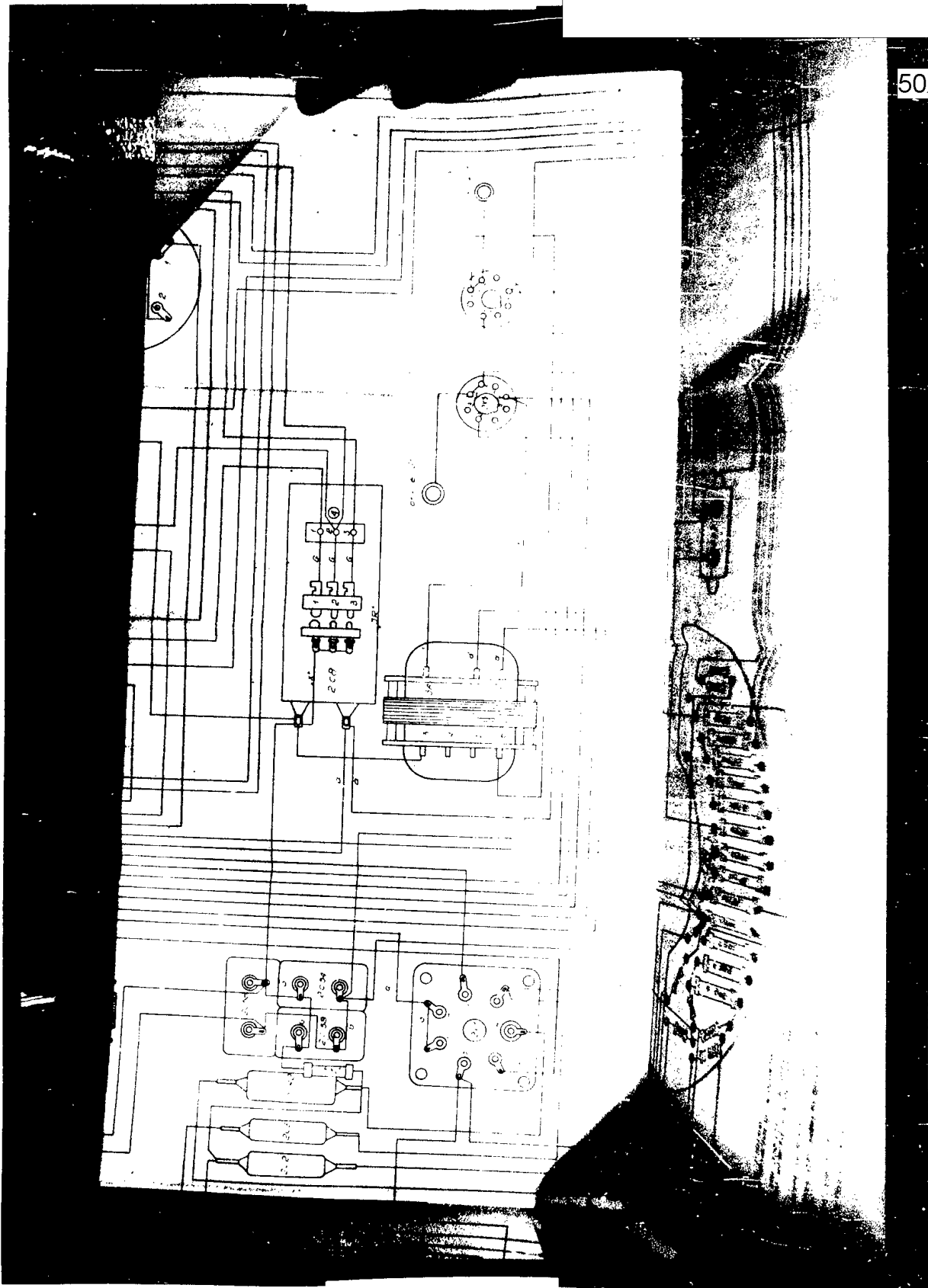

SECRET
NO FOREIGN DISSEM

50X1

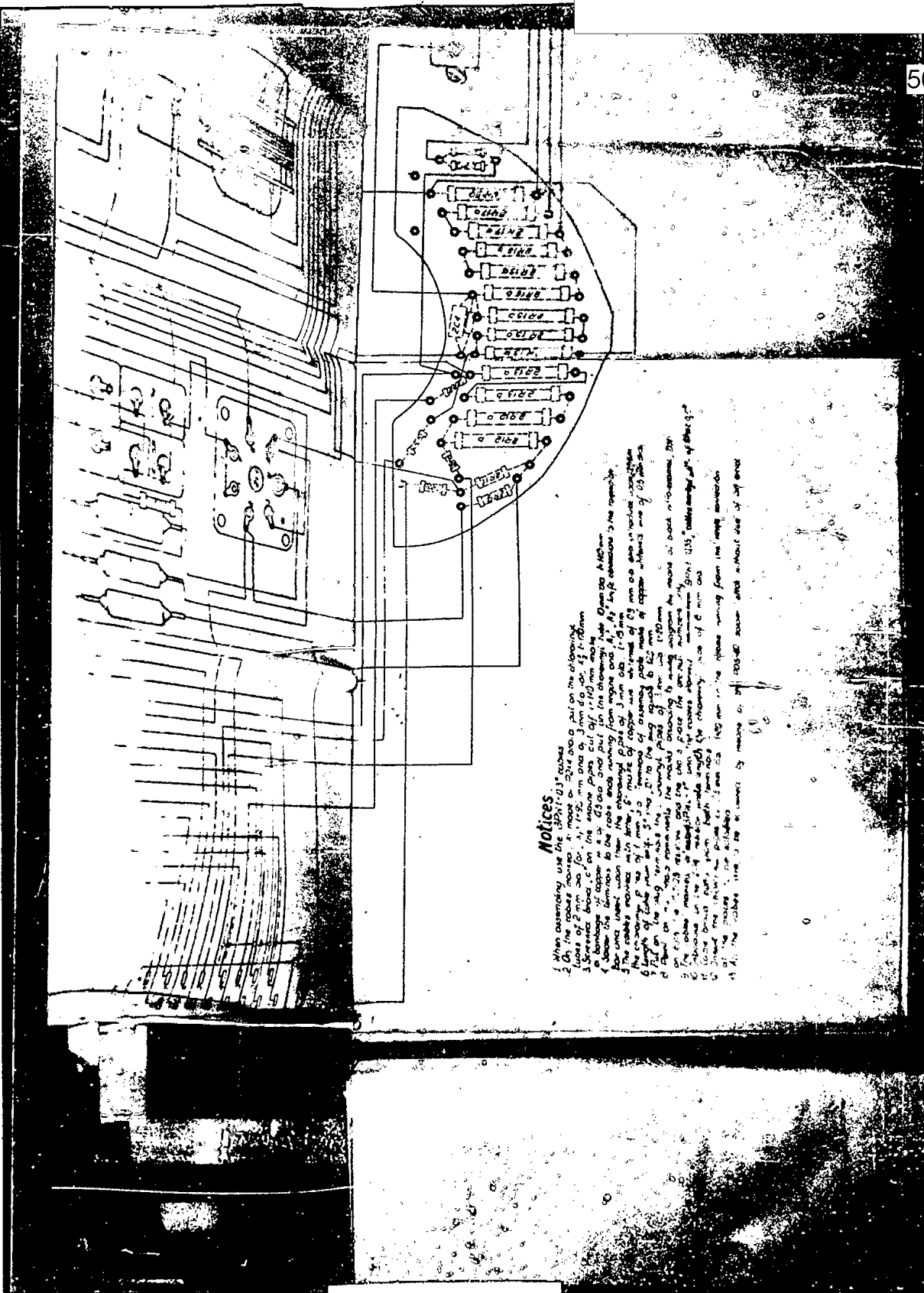

- Notices:**
1. When assembling use the 39311-013 cables.
 2. On the cable harness, 4 holes are 2.14 and a pin on the drawing.
 3. Screws are 3.17 mm dia. x 3 mm long, of 1-18mm.
 4. Screws are 3.17 mm dia. x 3 mm long, of 1-18mm.
 5. A bundle of copper wire is 0.5 mm dia. and has 100 turns.
 6. Below the terminals to the cable ends running from engine and A. As 1/2 inch diameter is the diameter.
 7. For each cable when there is the drawing of 3 mm dia. 1-18mm.
 8. The cable harness is 1.18 mm dia. x 1.18 mm dia. x 1.18 mm dia.
 9. Length of cable from 1.18 mm dia. x 1.18 mm dia. x 1.18 mm dia.
 10. The cable harness is 1.18 mm dia. x 1.18 mm dia. x 1.18 mm dia.
 11. The cable harness is 1.18 mm dia. x 1.18 mm dia. x 1.18 mm dia.
 12. The cable harness is 1.18 mm dia. x 1.18 mm dia. x 1.18 mm dia.
 13. The cable harness is 1.18 mm dia. x 1.18 mm dia. x 1.18 mm dia.
 14. The cable harness is 1.18 mm dia. x 1.18 mm dia. x 1.18 mm dia.
 15. The cable harness is 1.18 mm dia. x 1.18 mm dia. x 1.18 mm dia.
 16. The cable harness is 1.18 mm dia. x 1.18 mm dia. x 1.18 mm dia.
 17. The cable harness is 1.18 mm dia. x 1.18 mm dia. x 1.18 mm dia.
 18. The cable harness is 1.18 mm dia. x 1.18 mm dia. x 1.18 mm dia.
 19. The cable harness is 1.18 mm dia. x 1.18 mm dia. x 1.18 mm dia.
 20. The cable harness is 1.18 mm dia. x 1.18 mm dia. x 1.18 mm dia.
 21. The cable harness is 1.18 mm dia. x 1.18 mm dia. x 1.18 mm dia.
 22. The cable harness is 1.18 mm dia. x 1.18 mm dia. x 1.18 mm dia.
 23. The cable harness is 1.18 mm dia. x 1.18 mm dia. x 1.18 mm dia.
 24. The cable harness is 1.18 mm dia. x 1.18 mm dia. x 1.18 mm dia.
 25. The cable harness is 1.18 mm dia. x 1.18 mm dia. x 1.18 mm dia.
 26. The cable harness is 1.18 mm dia. x 1.18 mm dia. x 1.18 mm dia.
 27. The cable harness is 1.18 mm dia. x 1.18 mm dia. x 1.18 mm dia.
 28. The cable harness is 1.18 mm dia. x 1.18 mm dia. x 1.18 mm dia.
 29. The cable harness is 1.18 mm dia. x 1.18 mm dia. x 1.18 mm dia.
 30. The cable harness is 1.18 mm dia. x 1.18 mm dia. x 1.18 mm dia.
 31. The cable harness is 1.18 mm dia. x 1.18 mm dia. x 1.18 mm dia.
 32. The cable harness is 1.18 mm dia. x 1.18 mm dia. x 1.18 mm dia.
 33. The cable harness is 1.18 mm dia. x 1.18 mm dia. x 1.18 mm dia.
 34. The cable harness is 1.18 mm dia. x 1.18 mm dia. x 1.18 mm dia.
 35. The cable harness is 1.18 mm dia. x 1.18 mm dia. x 1.18 mm dia.
 36. The cable harness is 1.18 mm dia. x 1.18 mm dia. x 1.18 mm dia.
 37. The cable harness is 1.18 mm dia. x 1.18 mm dia. x 1.18 mm dia.
 38. The cable harness is 1.18 mm dia. x 1.18 mm dia. x 1.18 mm dia.
 39. The cable harness is 1.18 mm dia. x 1.18 mm dia. x 1.18 mm dia.
 40. The cable harness is 1.18 mm dia. x 1.18 mm dia. x 1.18 mm dia.
 41. The cable harness is 1.18 mm dia. x 1.18 mm dia. x 1.18 mm dia.
 42. The cable harness is 1.18 mm dia. x 1.18 mm dia. x 1.18 mm dia.
 43. The cable harness is 1.18 mm dia. x 1.18 mm dia. x 1.18 mm dia.
 44. The cable harness is 1.18 mm dia. x 1.18 mm dia. x 1.18 mm dia.
 45. The cable harness is 1.18 mm dia. x 1.18 mm dia. x 1.18 mm dia.
 46. The cable harness is 1.18 mm dia. x 1.18 mm dia. x 1.18 mm dia.
 47. The cable harness is 1.18 mm dia. x 1.18 mm dia. x 1.18 mm dia.
 48. The cable harness is 1.18 mm dia. x 1.18 mm dia. x 1.18 mm dia.
 49. The cable harness is 1.18 mm dia. x 1.18 mm dia. x 1.18 mm dia.
 50. The cable harness is 1.18 mm dia. x 1.18 mm dia. x 1.18 mm dia.
 51. The cable harness is 1.18 mm dia. x 1.18 mm dia. x 1.18 mm dia.
 52. The cable harness is 1.18 mm dia. x 1.18 mm dia. x 1.18 mm dia.
 53. The cable harness is 1.18 mm dia. x 1.18 mm dia. x 1.18 mm dia.
 54. The cable harness is 1.18 mm dia. x 1.18 mm dia. x 1.18 mm dia.
 55. The cable harness is 1.18 mm dia. x 1.18 mm dia. x 1.18 mm dia.
 56. The cable harness is 1.18 mm dia. x 1.18 mm dia. x 1.18 mm dia.
 57. The cable harness is 1.18 mm dia. x 1.18 mm dia. x 1.18 mm dia.
 58. The cable harness is 1.18 mm dia. x 1.18 mm dia. x 1.18 mm dia.
 59. The cable harness is 1.18 mm dia. x 1.18 mm dia. x 1.18 mm dia.
 60. The cable harness is 1.18 mm dia. x 1.18 mm dia. x 1.18 mm dia.

SECRET

NO FOREIGN DISSEM

SECRET
NO FOREIGN DISSEM

50X1

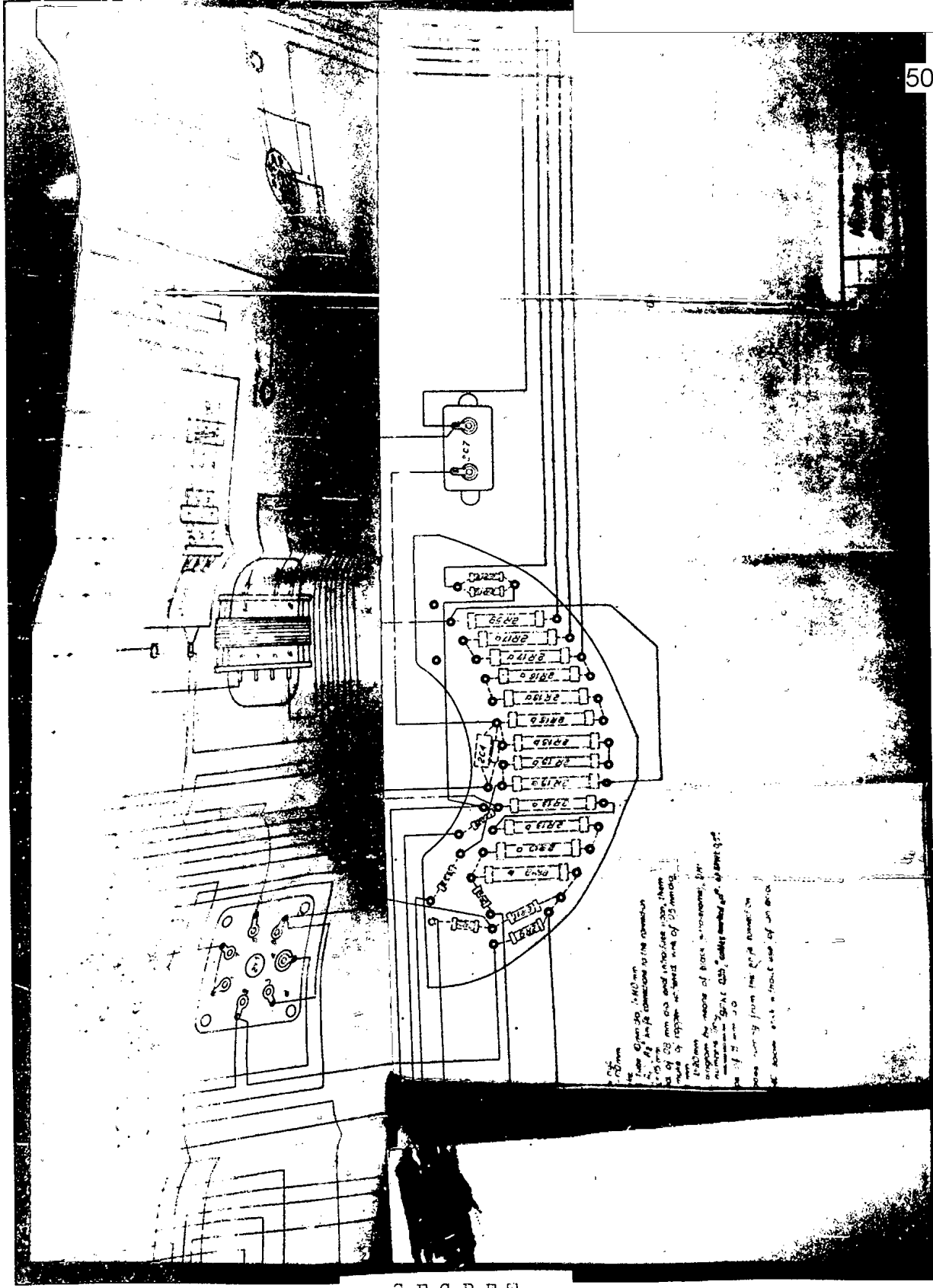

1. The drawing is a technical drawing of a control panel or interface. It shows a complex arrangement of components including a large central dial or display, several rows of rectangular modules or relays, and various electrical connections and wiring. The drawing is oriented vertically on the page. The components are labeled with alphanumeric codes such as '2542', '2543', '2544', '2545', '2546', '2547', '2548', '2549', '2550', '2551', '2552', '2553', '2554', '2555', '2556', '2557', '2558', '2559', '2560', '2561', '2562', '2563', '2564', '2565', '2566', '2567', '2568', '2569', '2570', '2571', '2572', '2573', '2574', '2575', '2576', '2577', '2578', '2579', '2580', '2581', '2582', '2583', '2584', '2585', '2586', '2587', '2588', '2589', '2590', '2591', '2592', '2593', '2594', '2595', '2596', '2597', '2598', '2599', '2600'. There are also labels for '2541', '2542', '2543', '2544', '2545', '2546', '2547', '2548', '2549', '2550', '2551', '2552', '2553', '2554', '2555', '2556', '2557', '2558', '2559', '2560', '2561', '2562', '2563', '2564', '2565', '2566', '2567', '2568', '2569', '2570', '2571', '2572', '2573', '2574', '2575', '2576', '2577', '2578', '2579', '2580', '2581', '2582', '2583', '2584', '2585', '2586', '2587', '2588', '2589', '2590', '2591', '2592', '2593', '2594', '2595', '2596', '2597', '2598', '2599', '2600'. The drawing is a high-contrast, black and white technical drawing.

SECRET

NO FOREIGN DISSEM

S-E-C-R-E-T
NO FOREIGN DISSEM

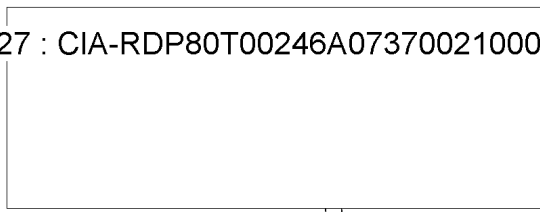

50X1

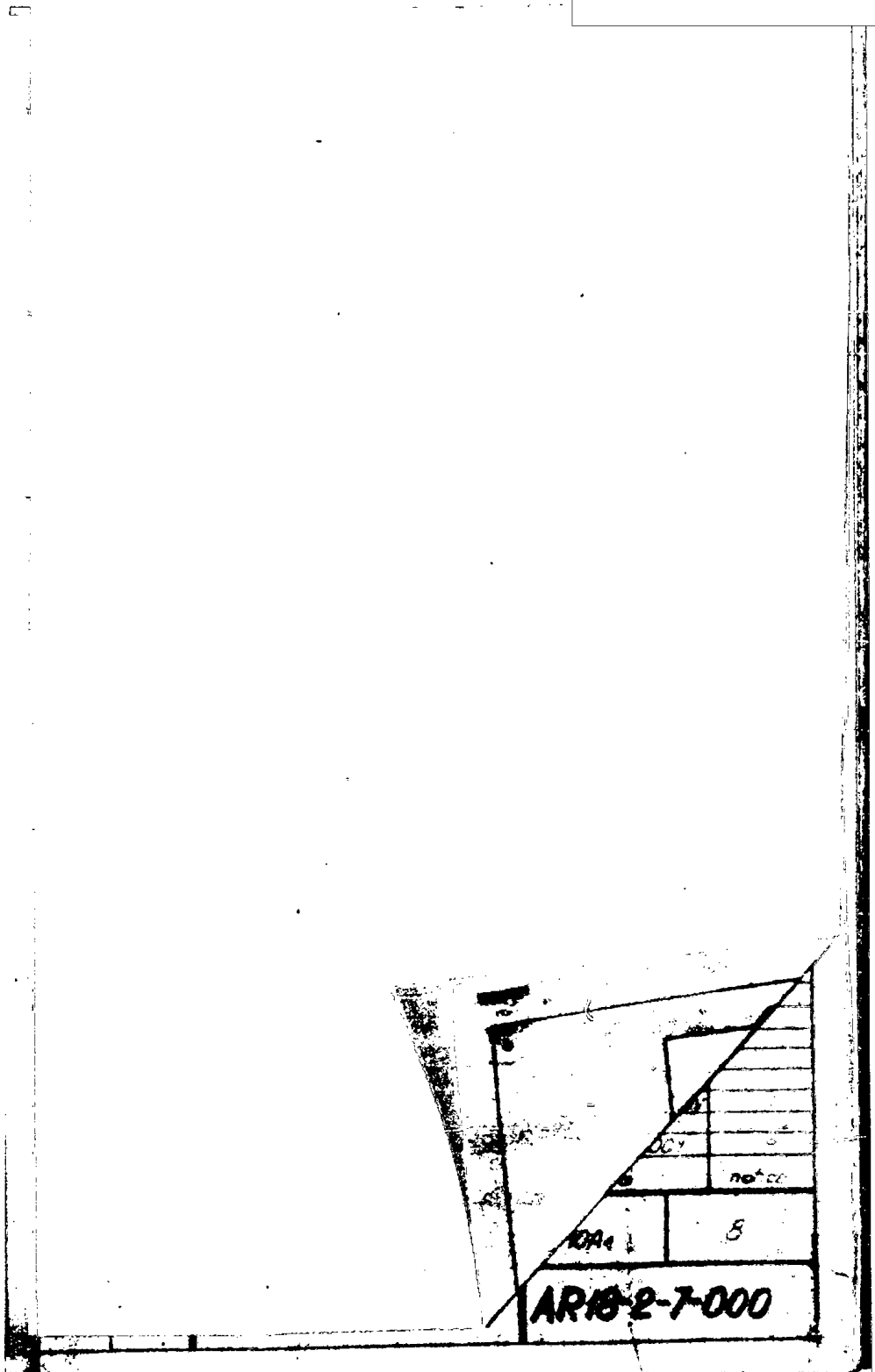

DA	5
AR 18-2-7-000	

28

S-E-C-R-E-T
NO FOREIGN DISSEM

S-E-C-R-E-T
NO FOREIGN DISSEM

50X1

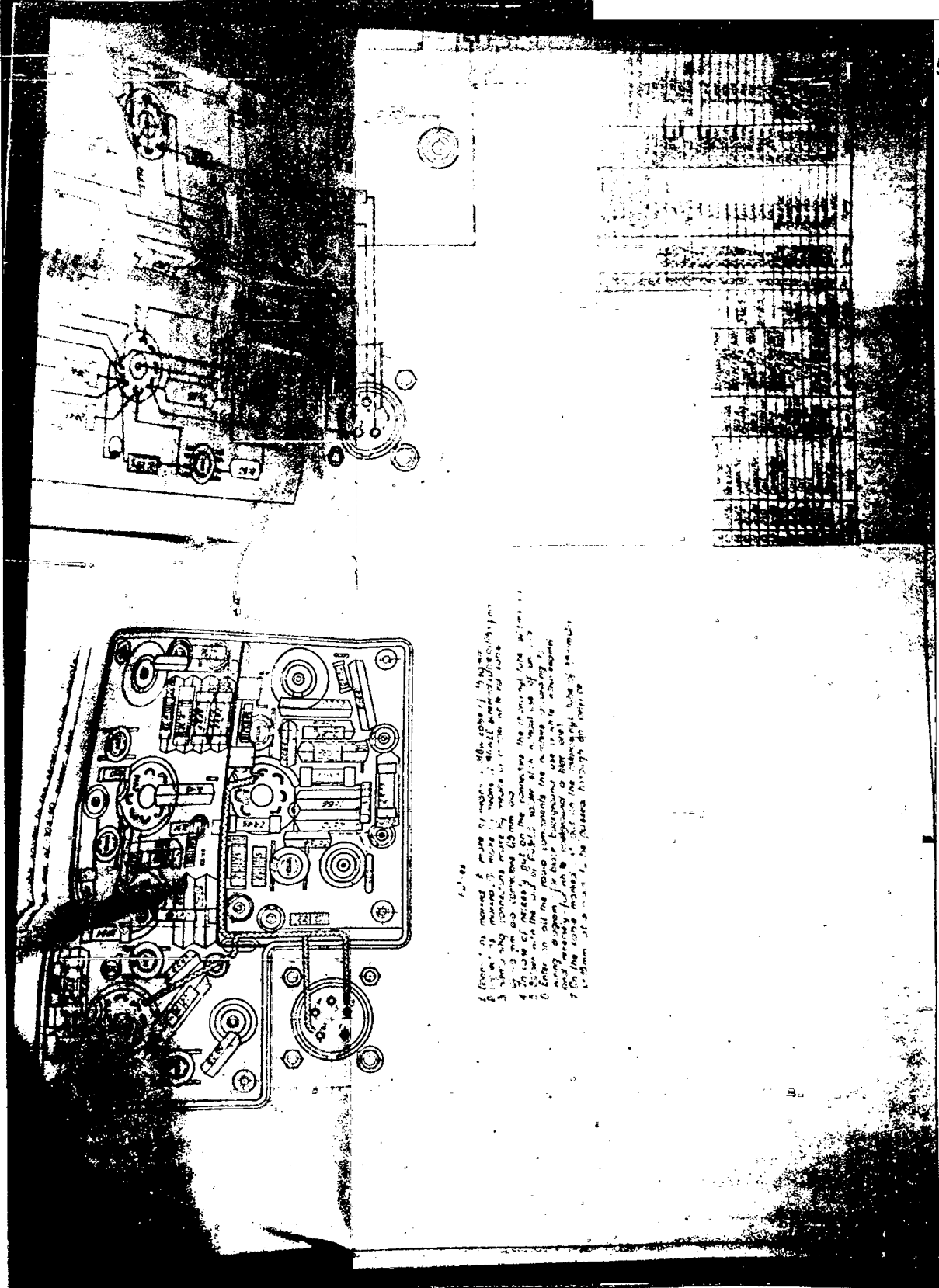

1. Enter in all the round components the numbers 1 through 10.
 2. Enter in all the round components the numbers 1 through 10.
 3. Enter in all the round components the numbers 1 through 10.
 4. Enter in all the round components the numbers 1 through 10.
 5. Enter in all the round components the numbers 1 through 10.
 6. Enter in all the round components the numbers 1 through 10.
 7. Enter in all the round components the numbers 1 through 10.
 8. Enter in all the round components the numbers 1 through 10.
 9. Enter in all the round components the numbers 1 through 10.
 10. Enter in all the round components the numbers 1 through 10.

S-E-C-R-E-T

NO FOREIGN DISSEM

S-E-C-R-E-T
NO FOREIGN DISSEM

50X1

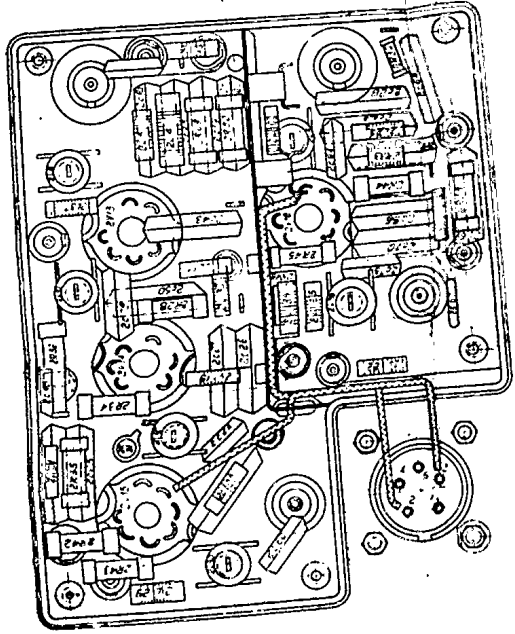
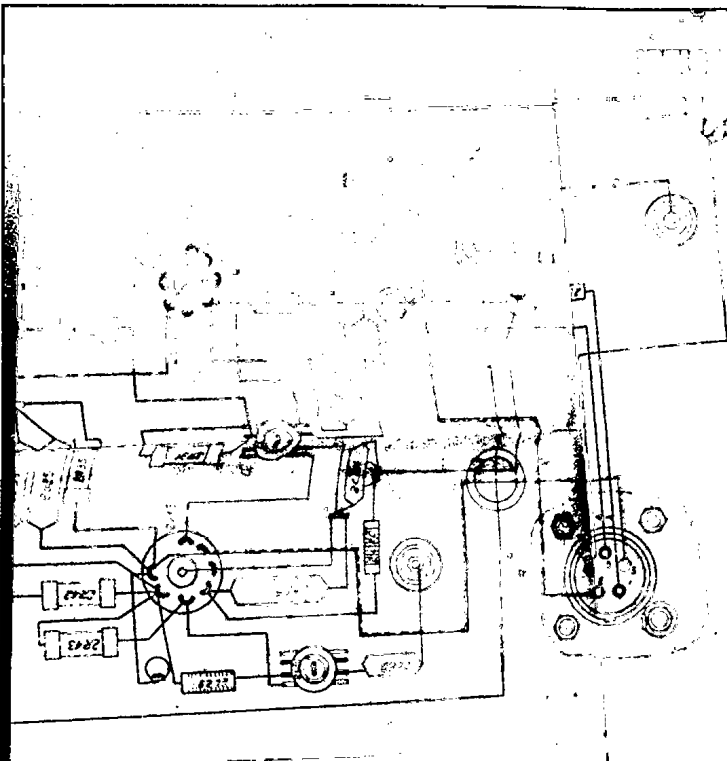

Handwritten notes in the left margin:
 - EXCEEDS 2000 RPM IN THE CENTER OF THE GEAR
 - ALL DIMENSIONS ARE IN INCHES UNLESS SPECIFIED OTHERWISE

Handwritten notes in the right margin:
 - THIS DRAWING IS A REPRODUCTION OF A DRAWING WHICH WAS OBTAINED FROM THE FILES OF THE FBI. IT IS NOT A COPY OF THE ORIGINAL DRAWING AND THEREFORE MAY BE SUBJECT TO THE SAME DEFICIENCIES AS THE ORIGINAL. THE ORIGINAL DRAWING IS FILED IN THE FBI FILES UNDER THE NUMBER 100-448619-100. THE ORIGINAL DRAWING IS FILED IN THE FBI FILES UNDER THE NUMBER 100-448619-100. THE ORIGINAL DRAWING IS FILED IN THE FBI FILES UNDER THE NUMBER 100-448619-100.

S-E-C-R-E-T

NO FOREIGN DISSEM

S-E-C-R-E-T
NO FOREIGN DISSEM

50X1

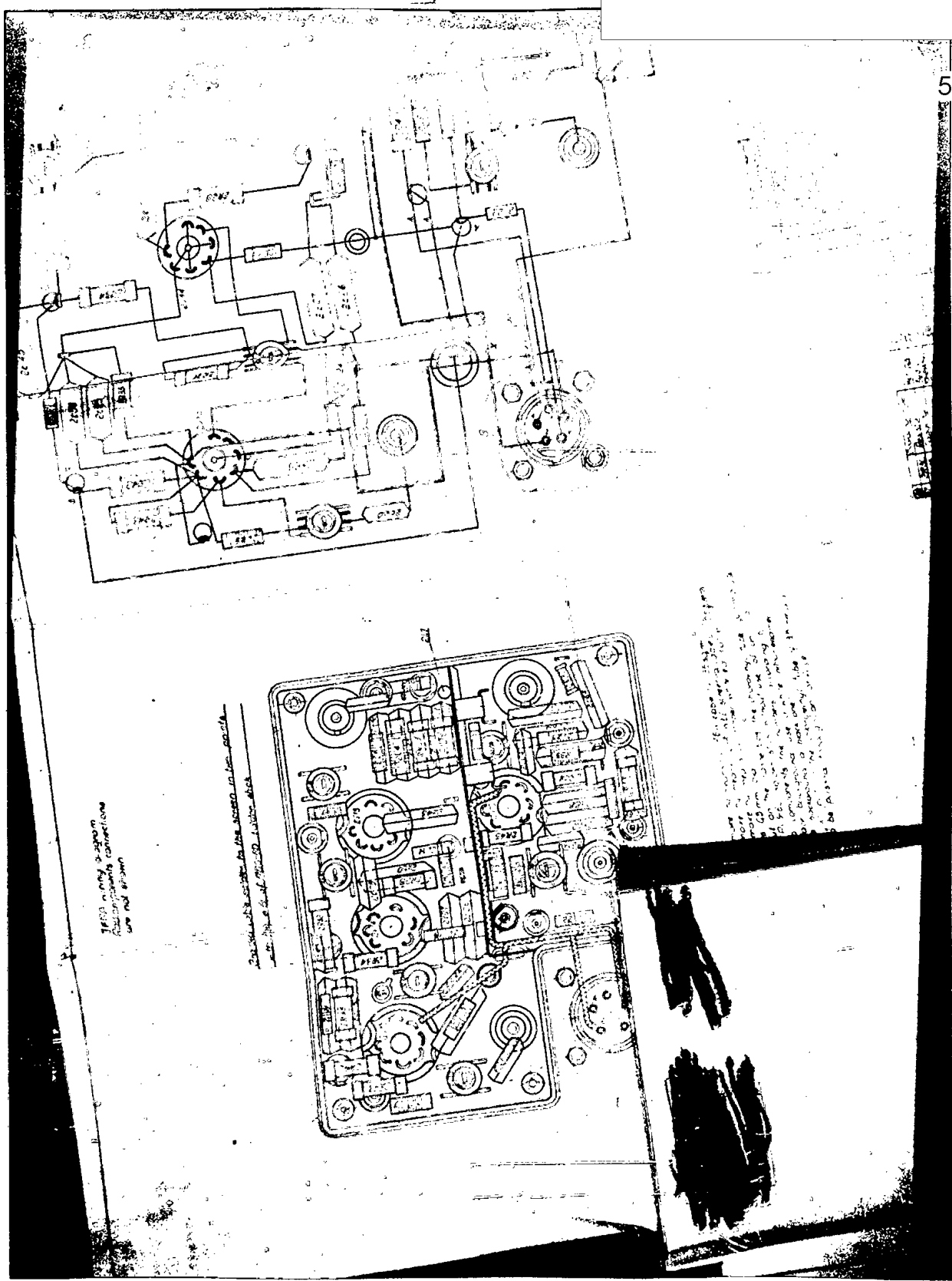

S-E-C-R-E-T
NO FOREIGN DISSEM

S-E-C-R-E-T
NO FOREIGN DISSEM

50X1

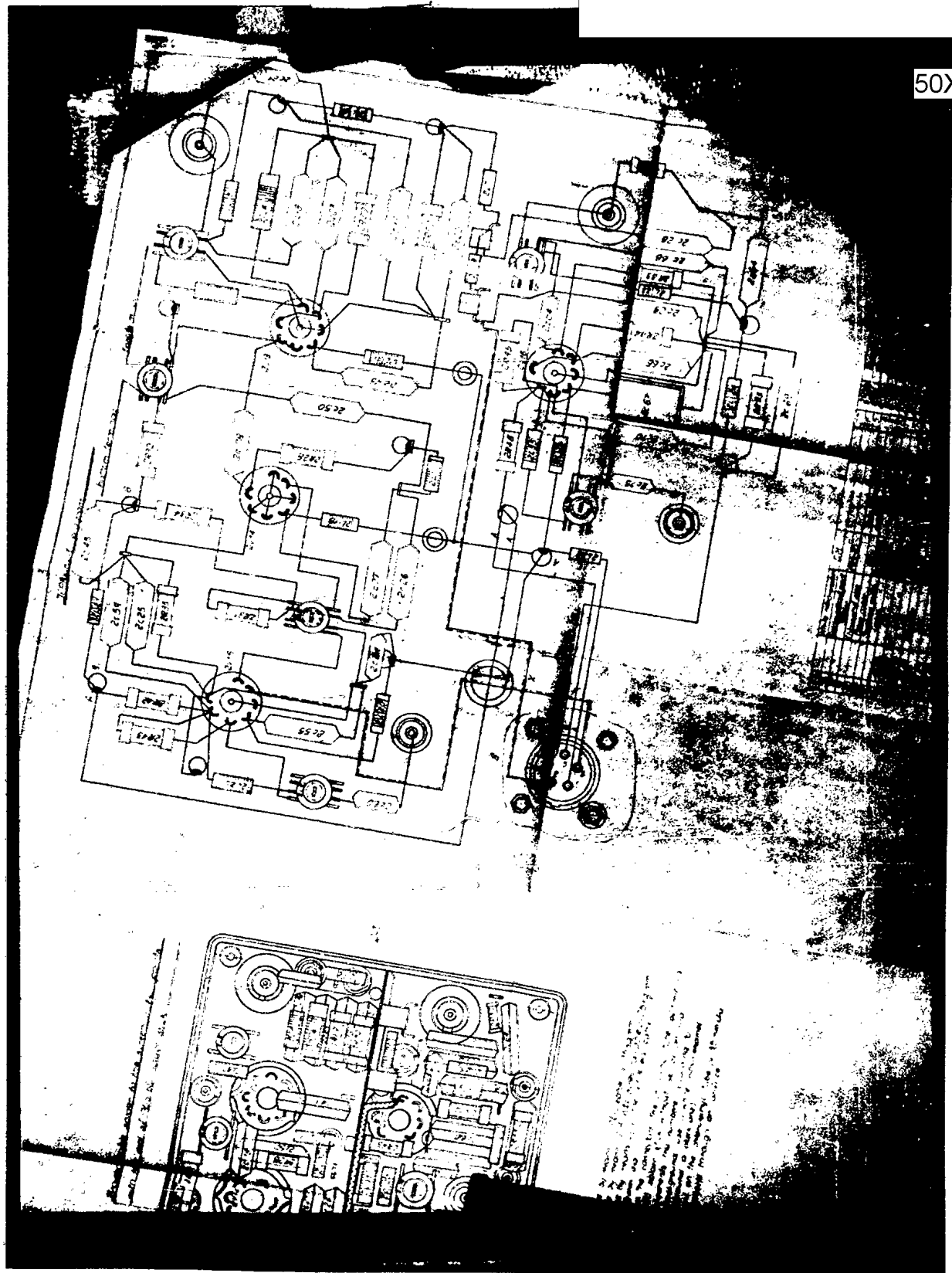

S-E-C-R-E-T
NO FOREIGN DISSEM

S-E-C-R-E-T
NO FOREIGN DISSEM

50X1



APR 82 7-00

JFPA mixing
diagram

This is a copy of the
 original drawing and
 is of rather poor quality.
 It is intended for use
 as a reference only and
 should not be used for
 any other purpose.
 The drawing is the
 property of the
 office and should
 not be distributed
 outside the office.
 Date of issue
 1/1/60

S-E-C-R-E-T

NO FOREIGN DISSEM

S-E-C-R-E-T
NO FOREIGN DISSEM



50X1

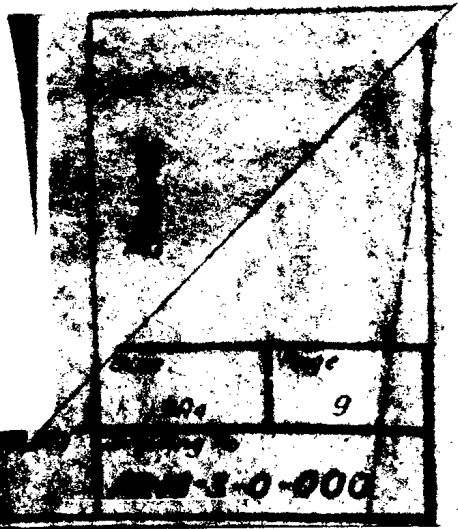
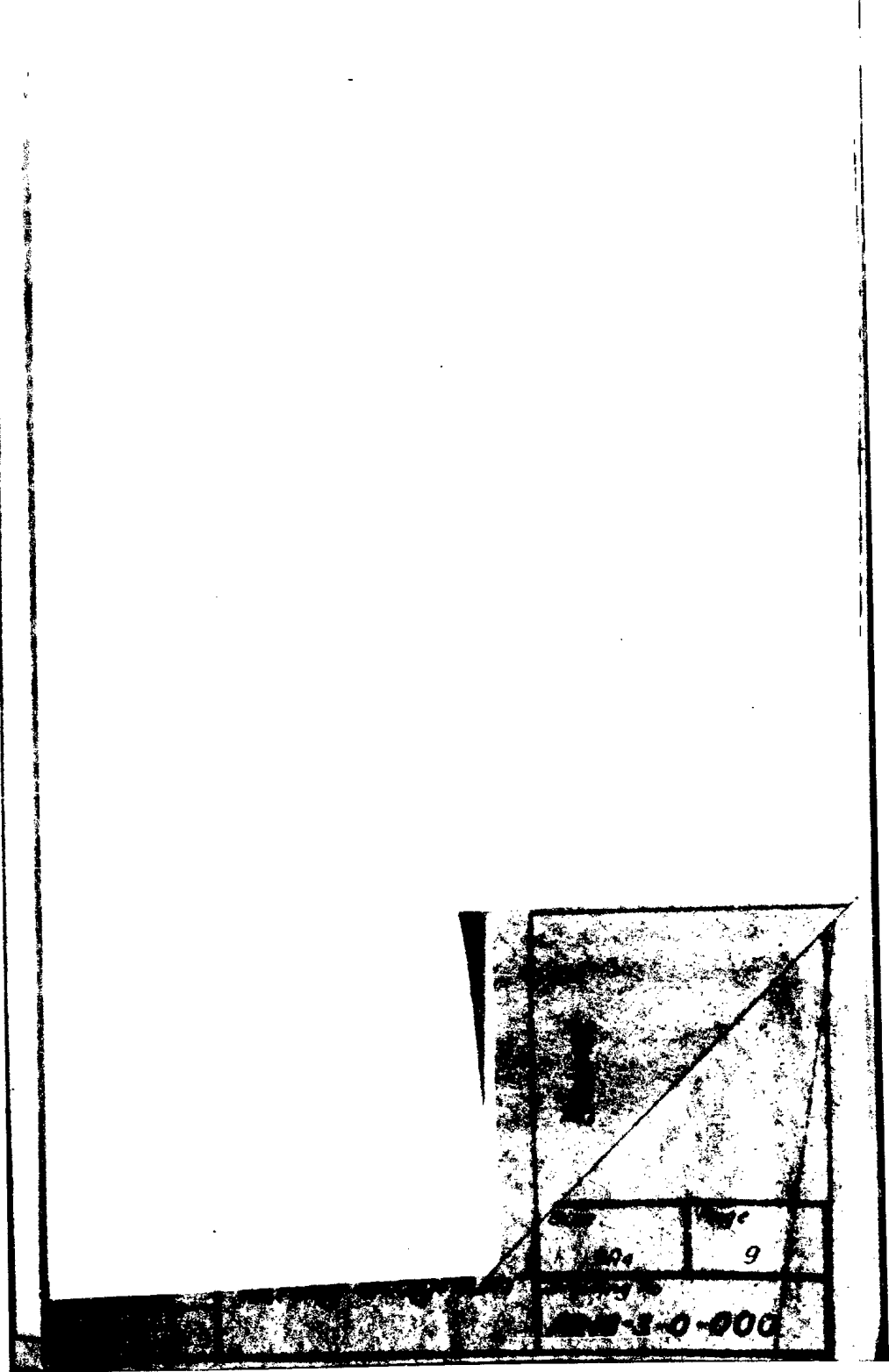

S-E-C-R-E-T
NO FOREIGN DISSEM

SECRET
NO FOREIGN DISSEM

50X1

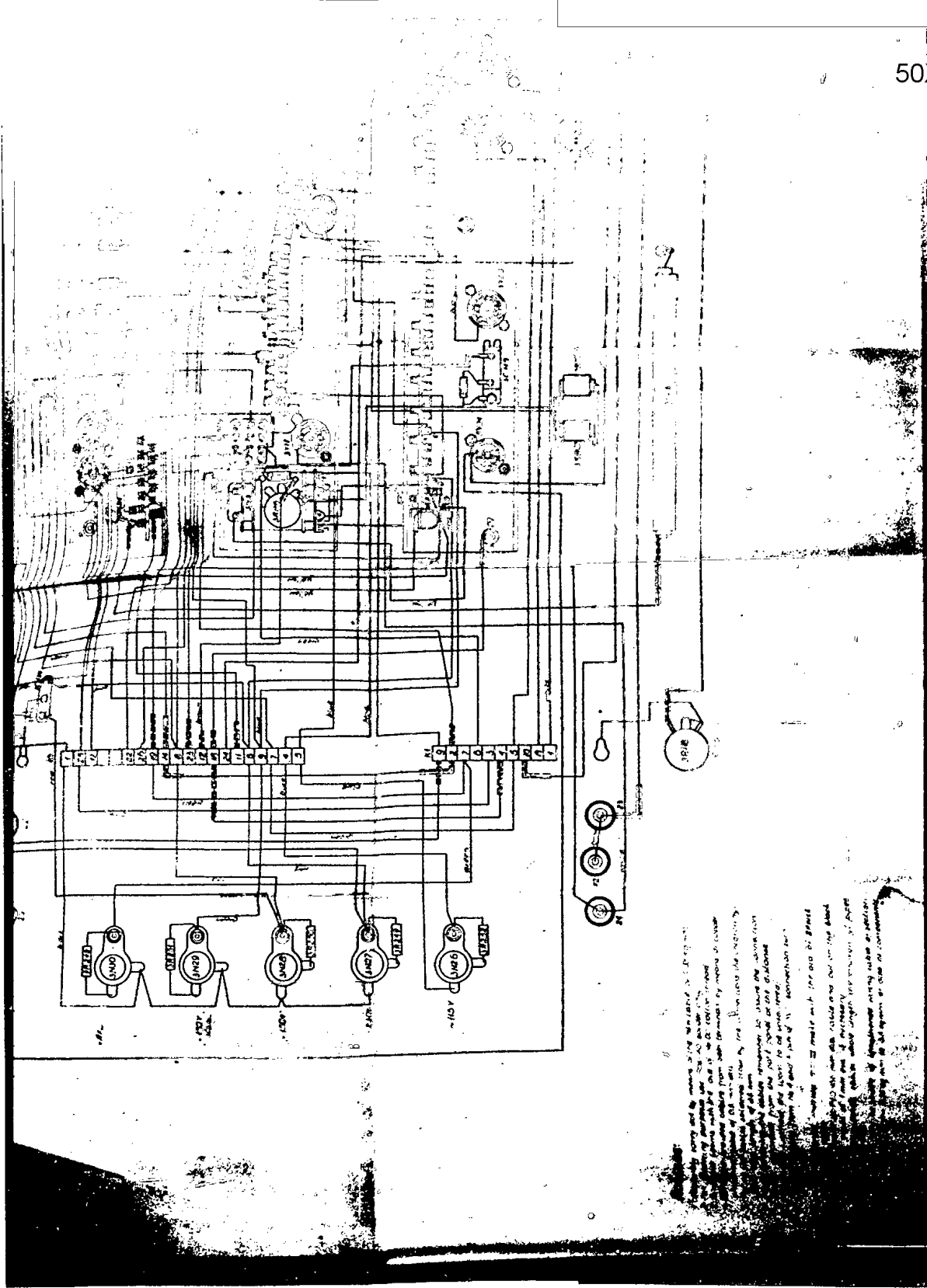

S-E-C-R-E-T

NO FOREIGN DISSEM

S-E-C-R-E-T
NO FOREIGN DISSEM

50X1

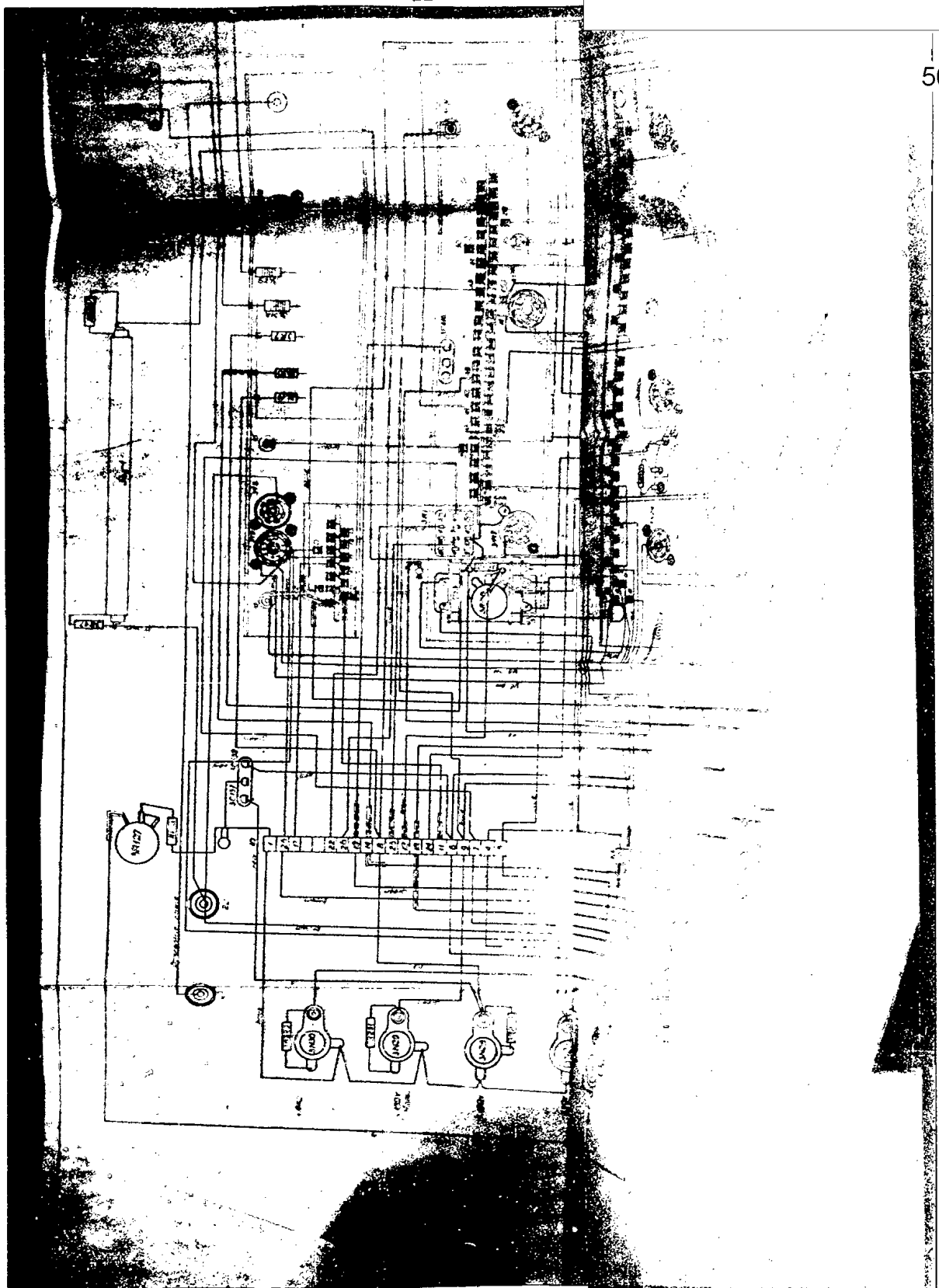

S-E-C-R-E-T
NO FOREIGN DISSEM

S-E-C-R-E-T
NO FOREIGN DISSEM

50X1

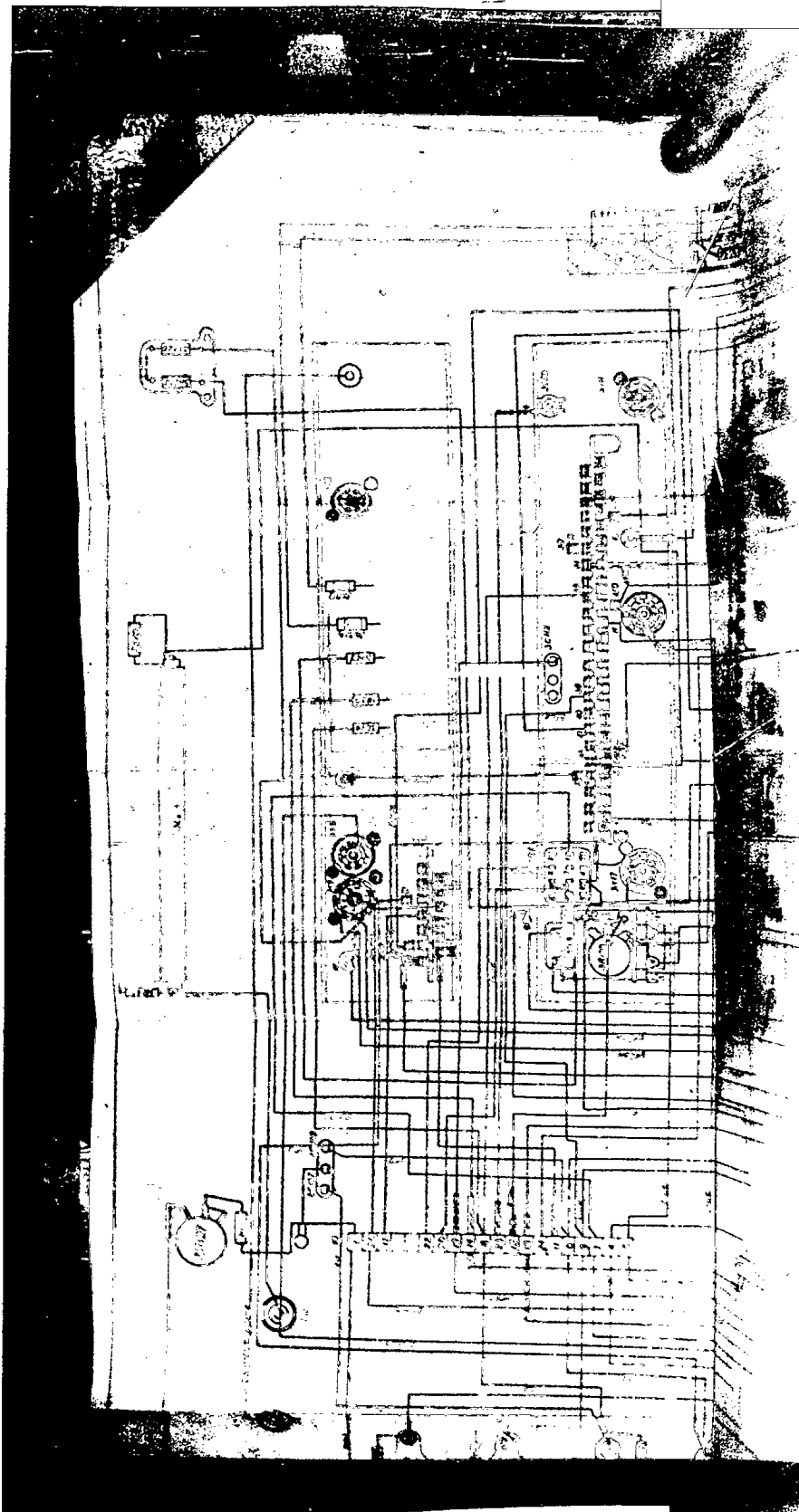

S-E-C-R-E-T

NO FOREIGN DISSEM

S-E-C-R-E-T
NO FOREIGN DISSEM

50X1

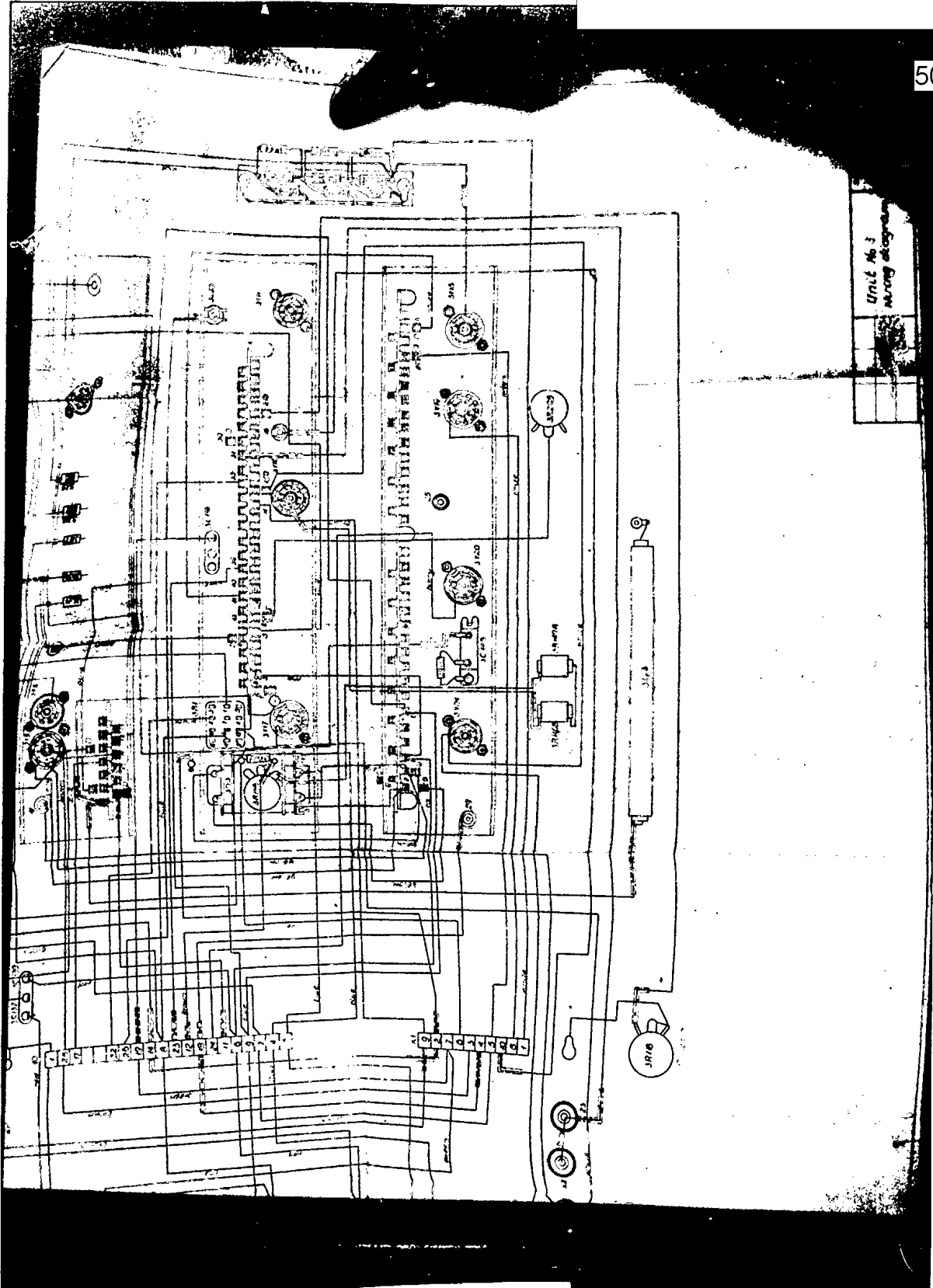

S-E-C-R-E-T
NO FOREIGN DISSEM

S-E-C-R-E-T
NO FOREIGN DISSEM

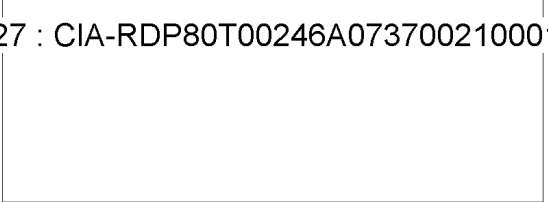

50X1

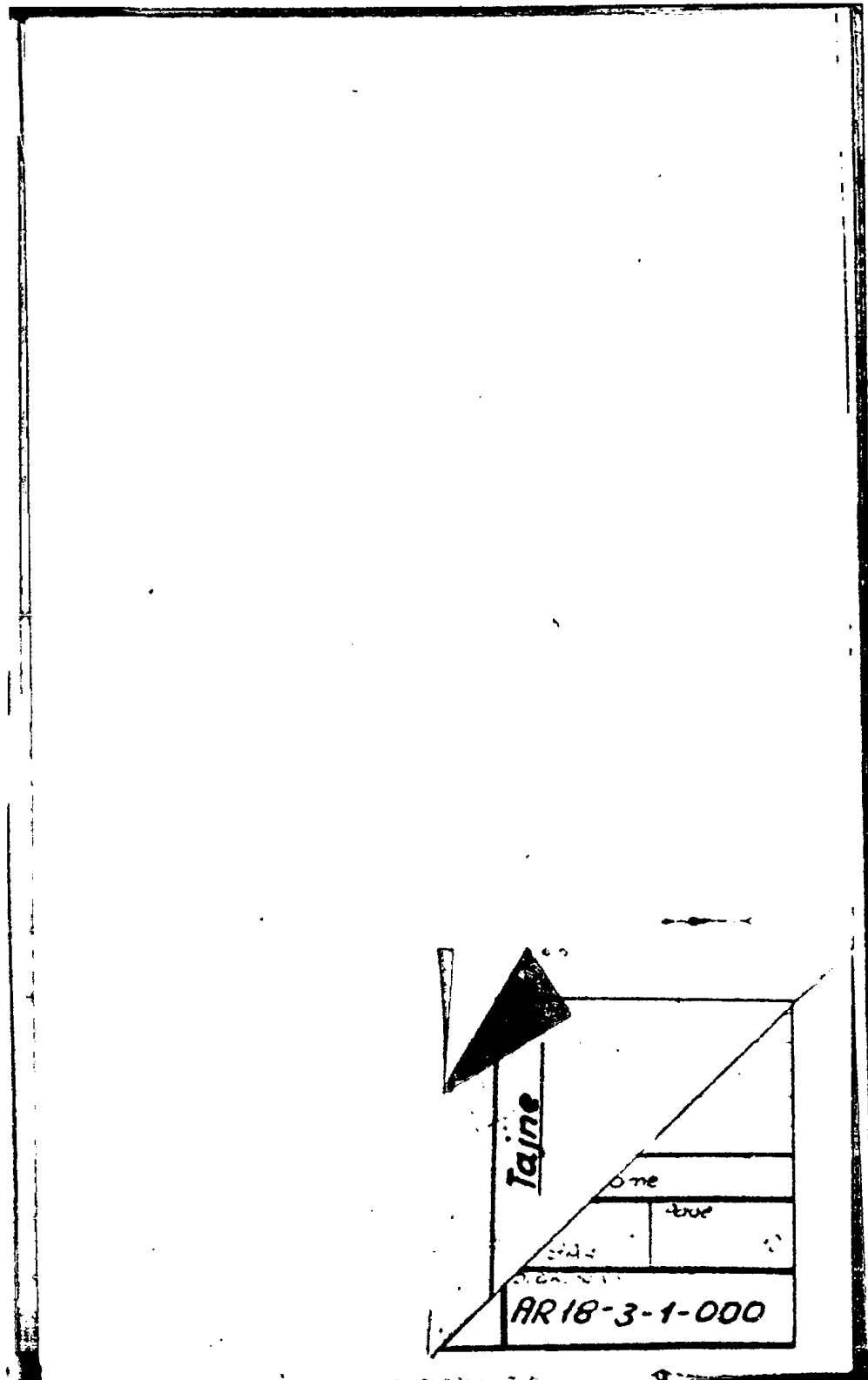

S-E-C-R-E-T
NO FOREIGN DISSEM

S-E-C-R-E-T
NO FOREIGN DISSEM

50X1

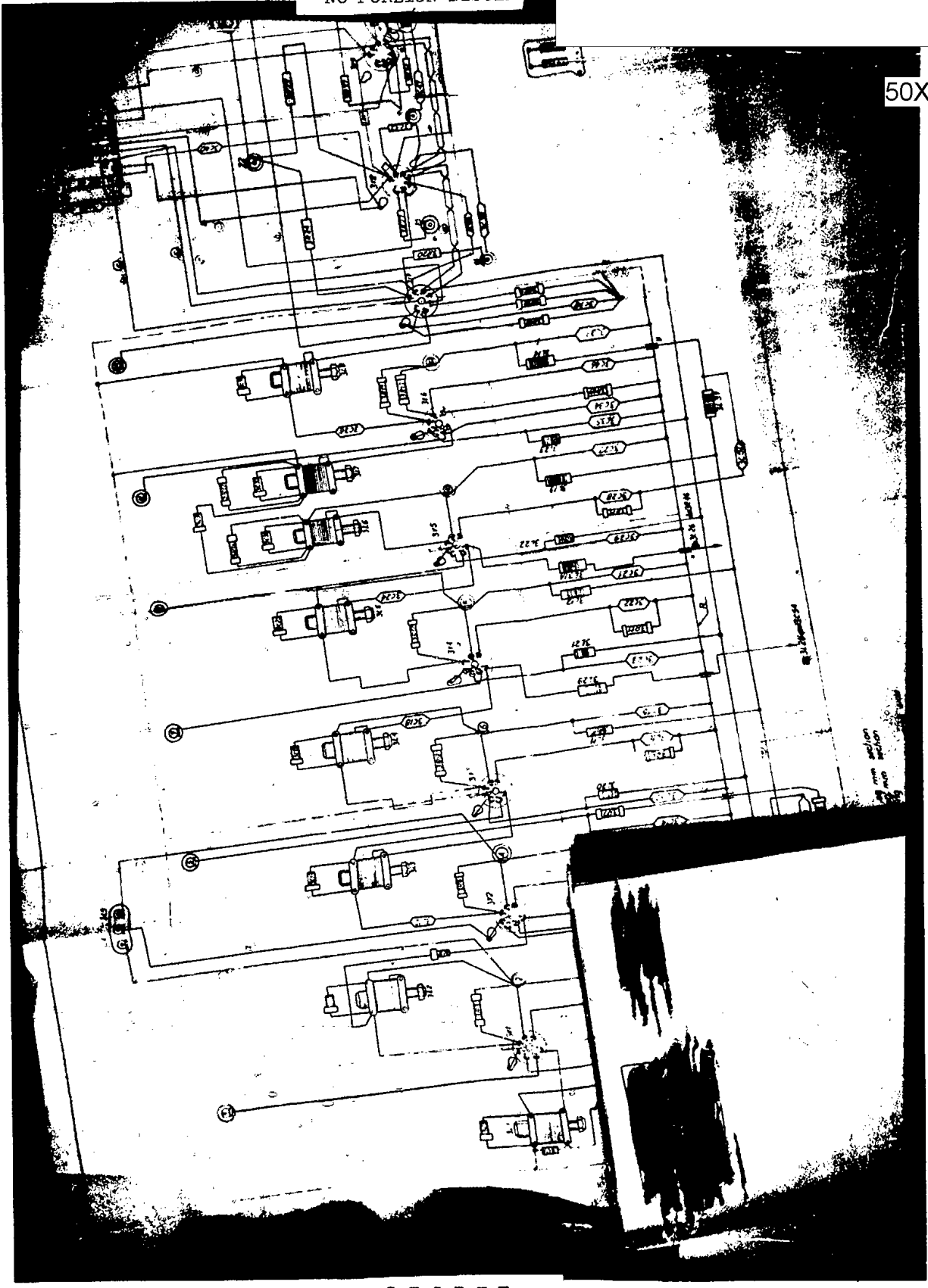

S-E-C-R-E-T
NO FOREIGN DISSEM

41

S-E-C-R-E-T
NO FOREIGN DISSEM

50X1

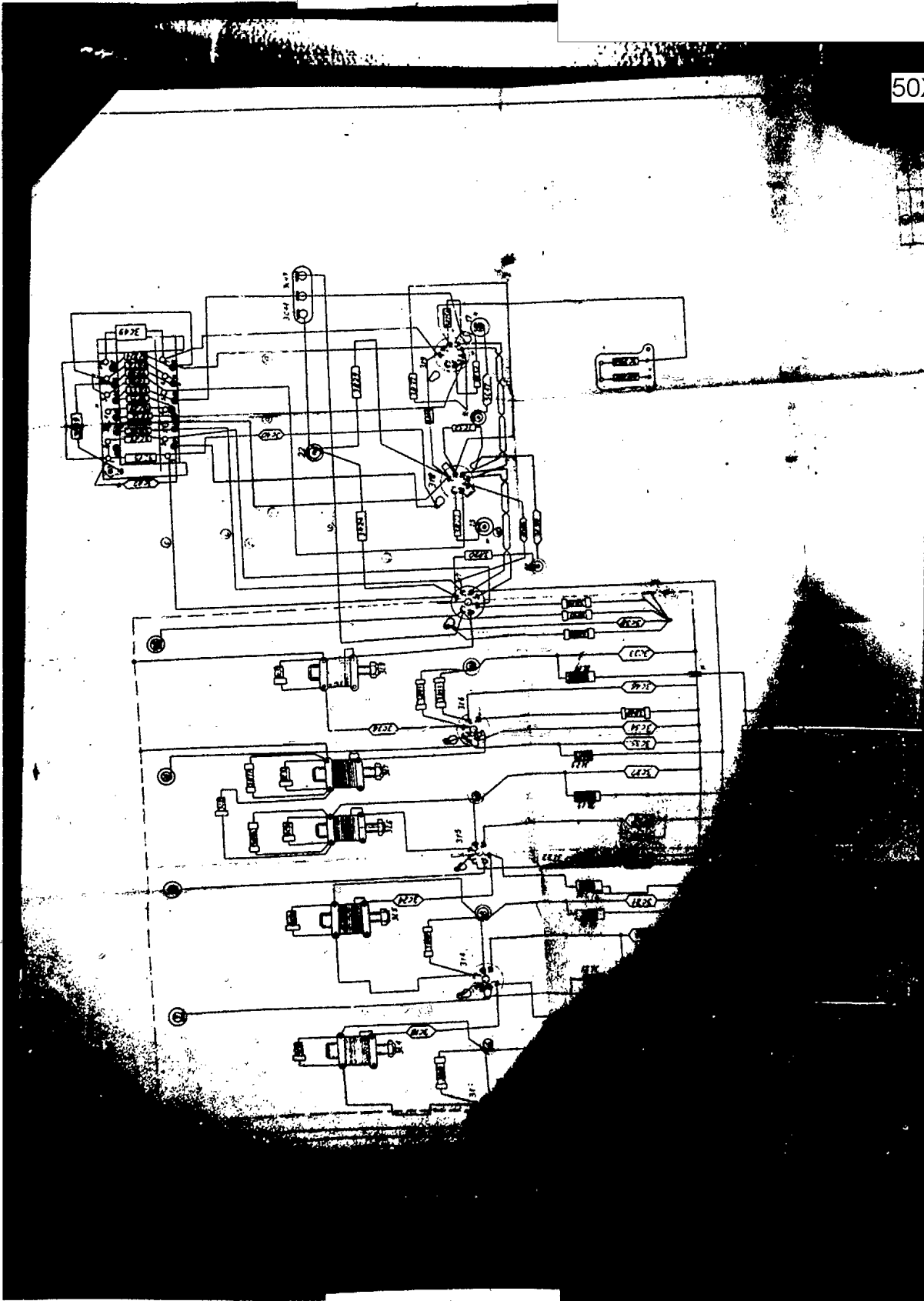

S-E-C-R-E-T
NO FOREIGN DISSEM

S-E-C-R-E-T
NO FOREIGN DISSEM

50X1

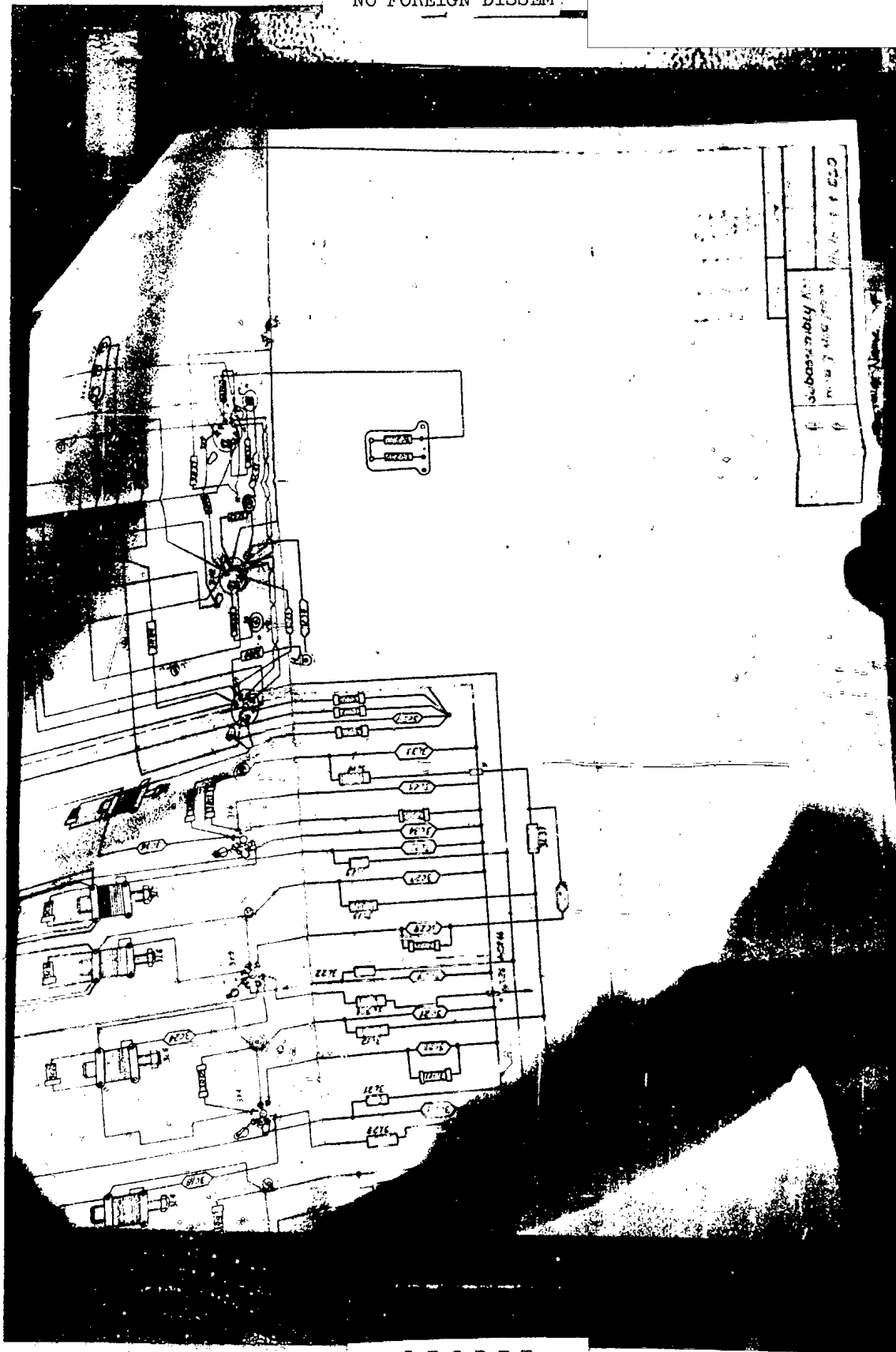

Subassembly No.	
Part No.	
Rev.	
QTY	
DATE	
BY	
CHKD	

S-E-C-R-E-T
NO FOREIGN DISSEM

S-E-C-R-E-T
NO FOREIGN DISSEM

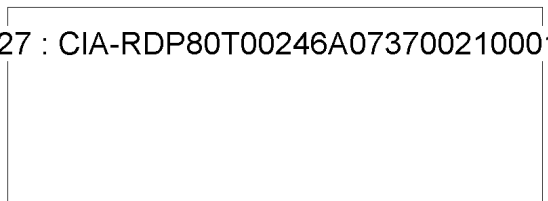

50X1

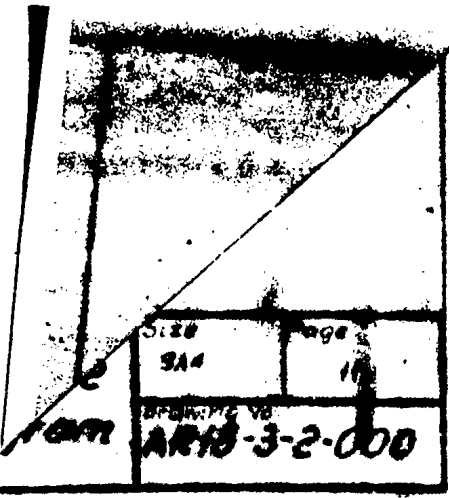
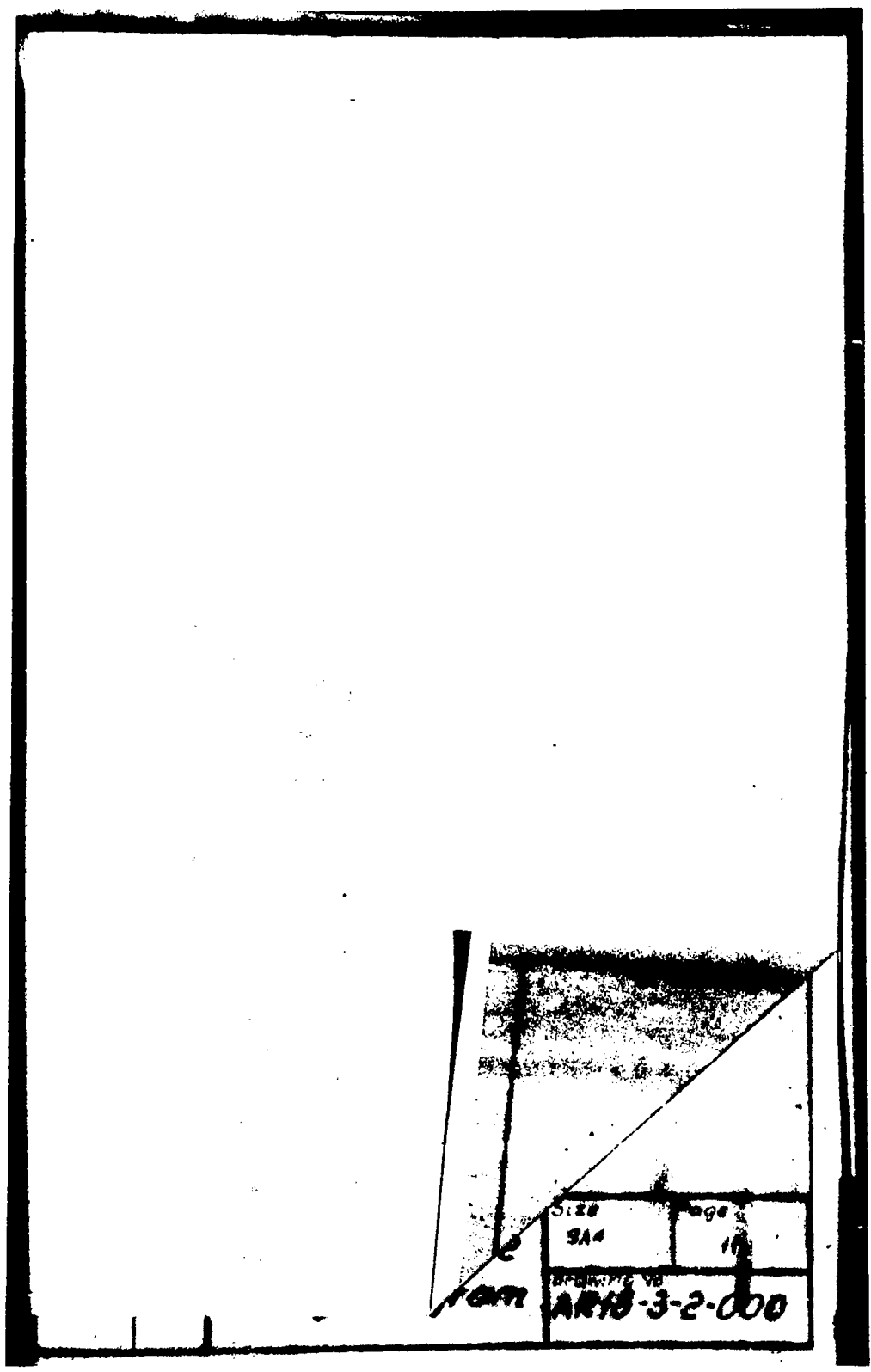

S-E-C-R-E-T
NO FOREIGN DISSEM

S-E-C-R-E-T
NO FOREIGN DISSEM

50X1

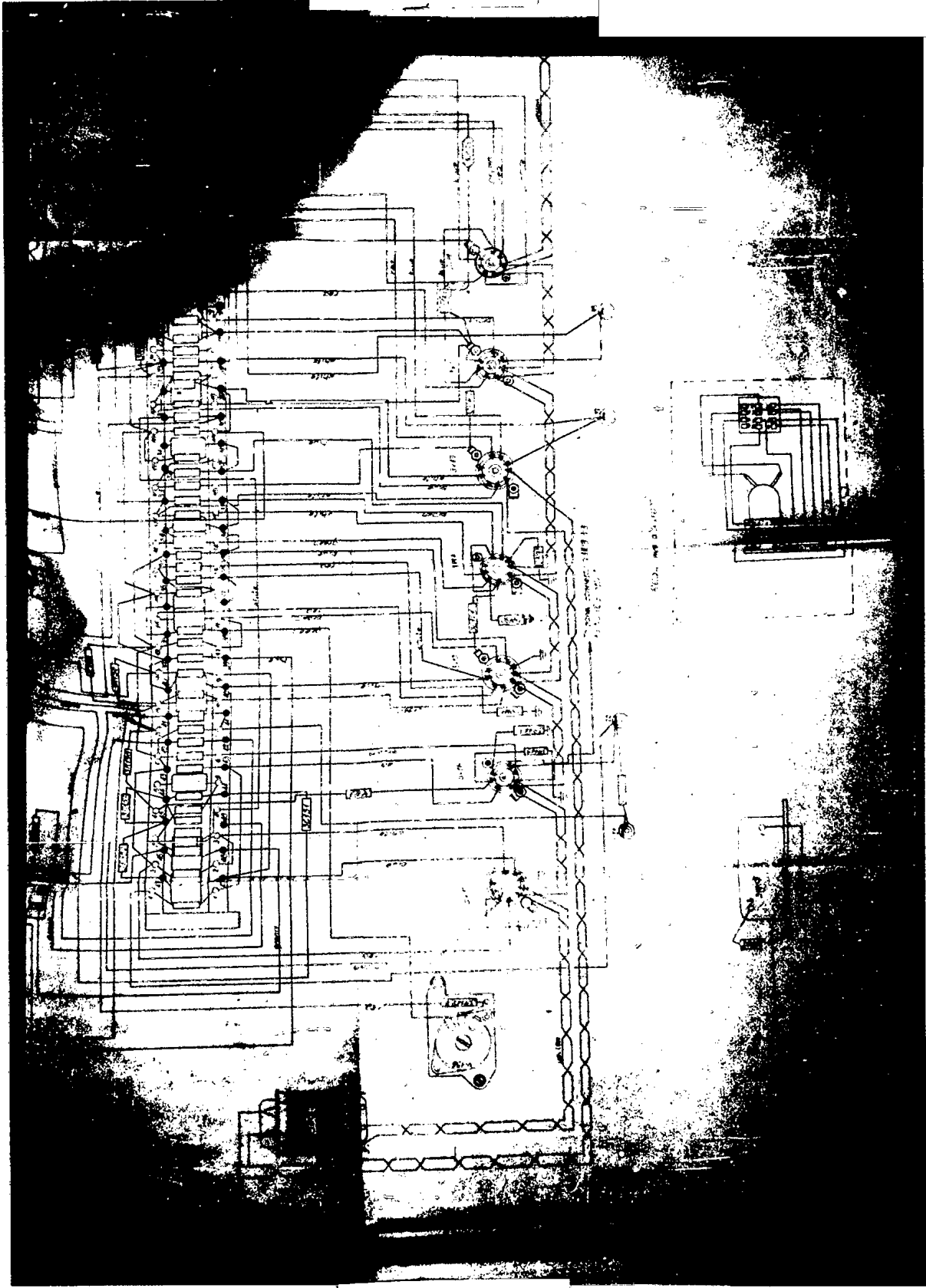

S-E-C-R-E-T
NO FOREIGN DISSEM

S-E-C-R-E-T
NO FOREIGN DISSEM

50X1

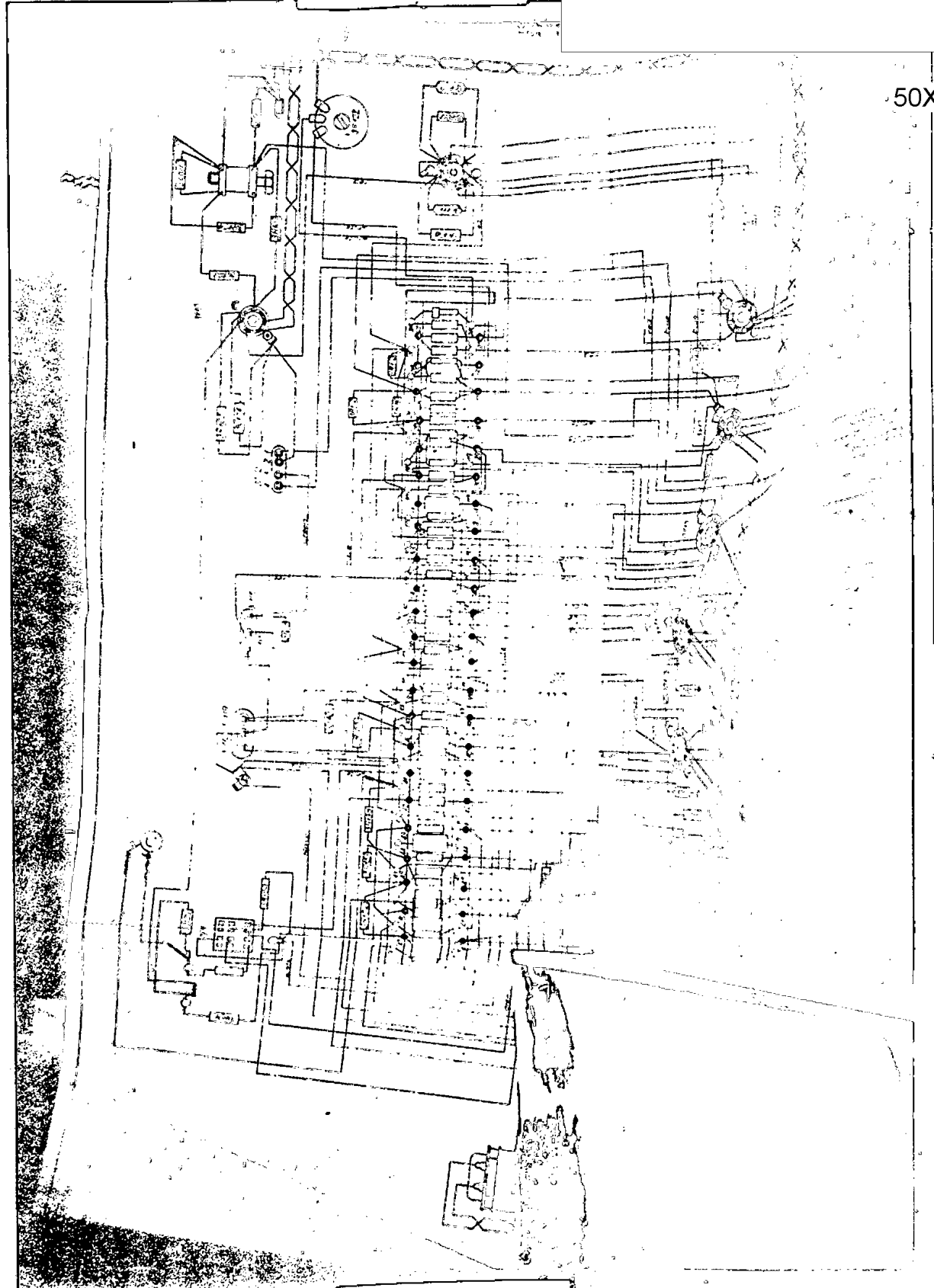

S-E-C-R-E-T

NO FOREIGN DISSEM

S-E-C-R-E-T
NO FOREIGN DISSEM

50X1

NOTES:

1. Cabinet is to be mounted on a wall.
2. All wiring to be done in accordance with the National Electrical Code.
3. All wiring to be done in accordance with the National Electrical Code.
4. All wiring to be done in accordance with the National Electrical Code.
5. All wiring to be done in accordance with the National Electrical Code.
6. All wiring to be done in accordance with the National Electrical Code.
7. All wiring to be done in accordance with the National Electrical Code.
8. All wiring to be done in accordance with the National Electrical Code.
9. All wiring to be done in accordance with the National Electrical Code.
10. All wiring to be done in accordance with the National Electrical Code.

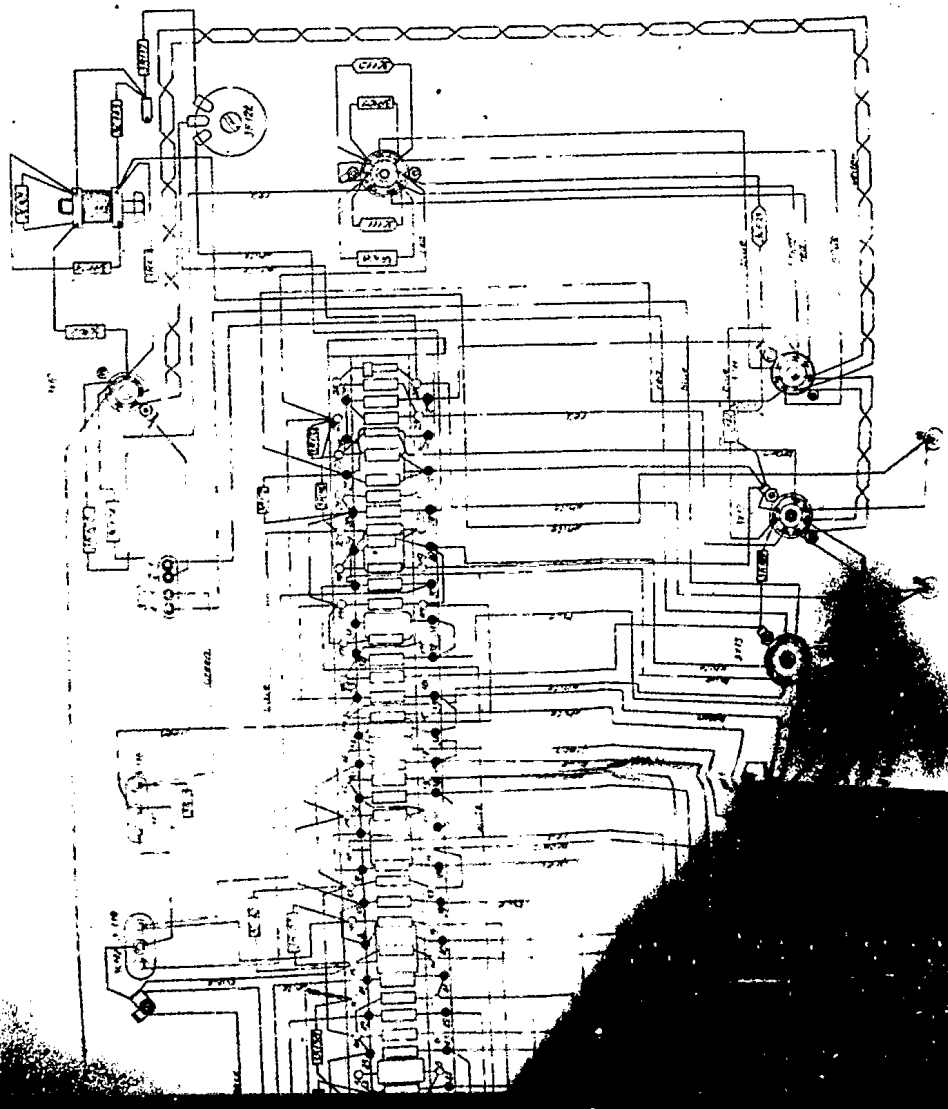

S-E-C-R-E-T

NO FOREIGN DISSEM

50X1

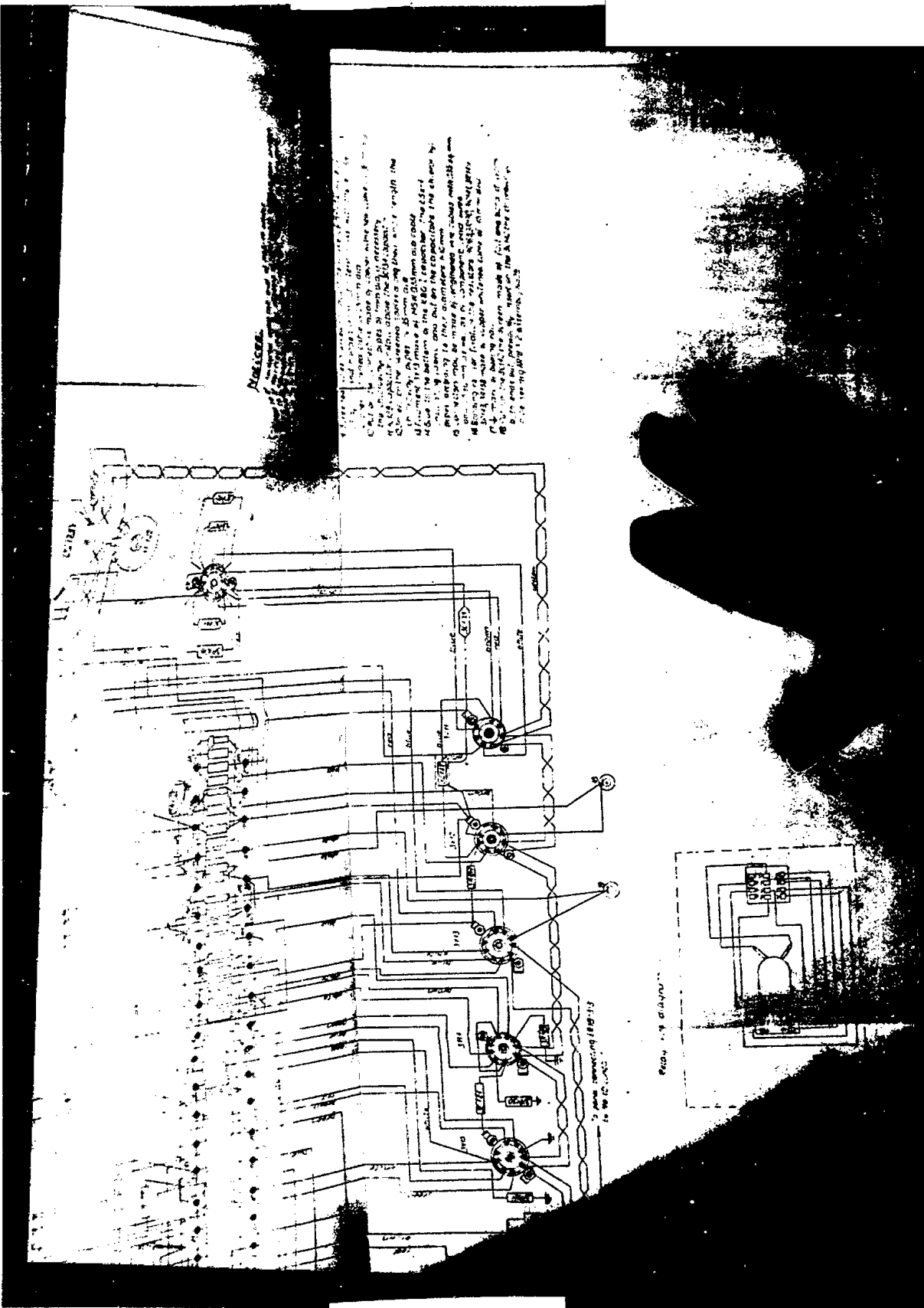

SECRET

NO FOREIGN DISSEM

S-E-C-R-E-T
NO FOREIGN DISSEM



50X1

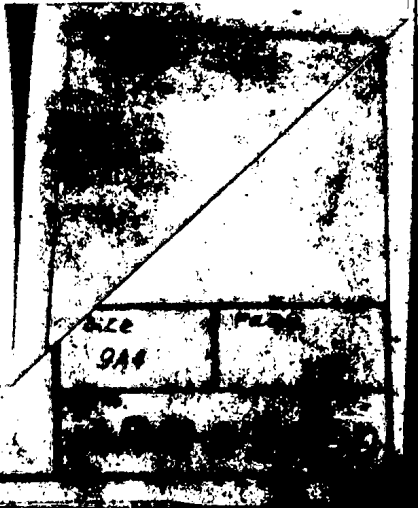
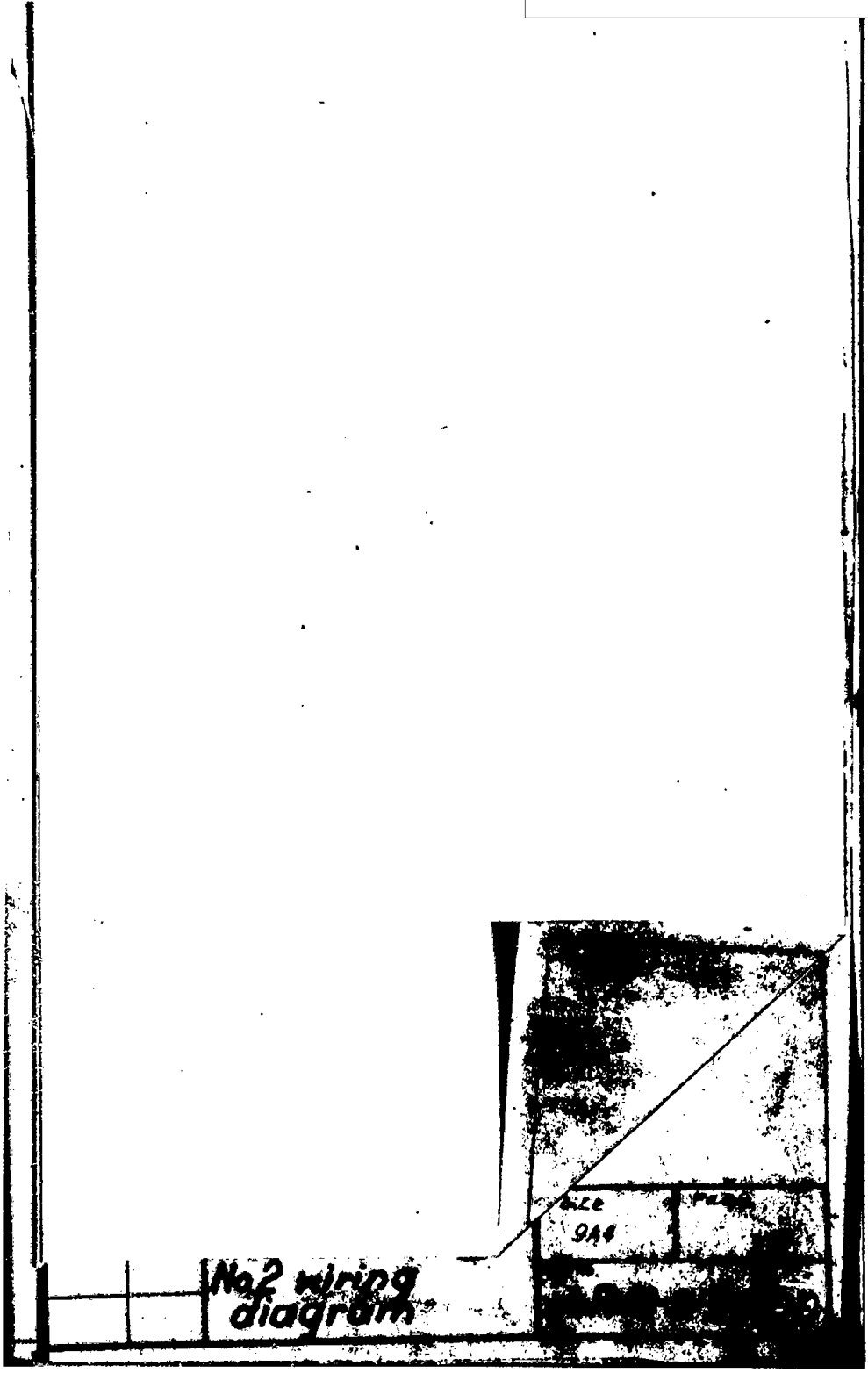

No. 2 wiring diagram

S-E-C-R-E-T

NO FOREIGN DISSEM

S-E-C-R-E-T
NO FOREIGN DISSEM

50X1

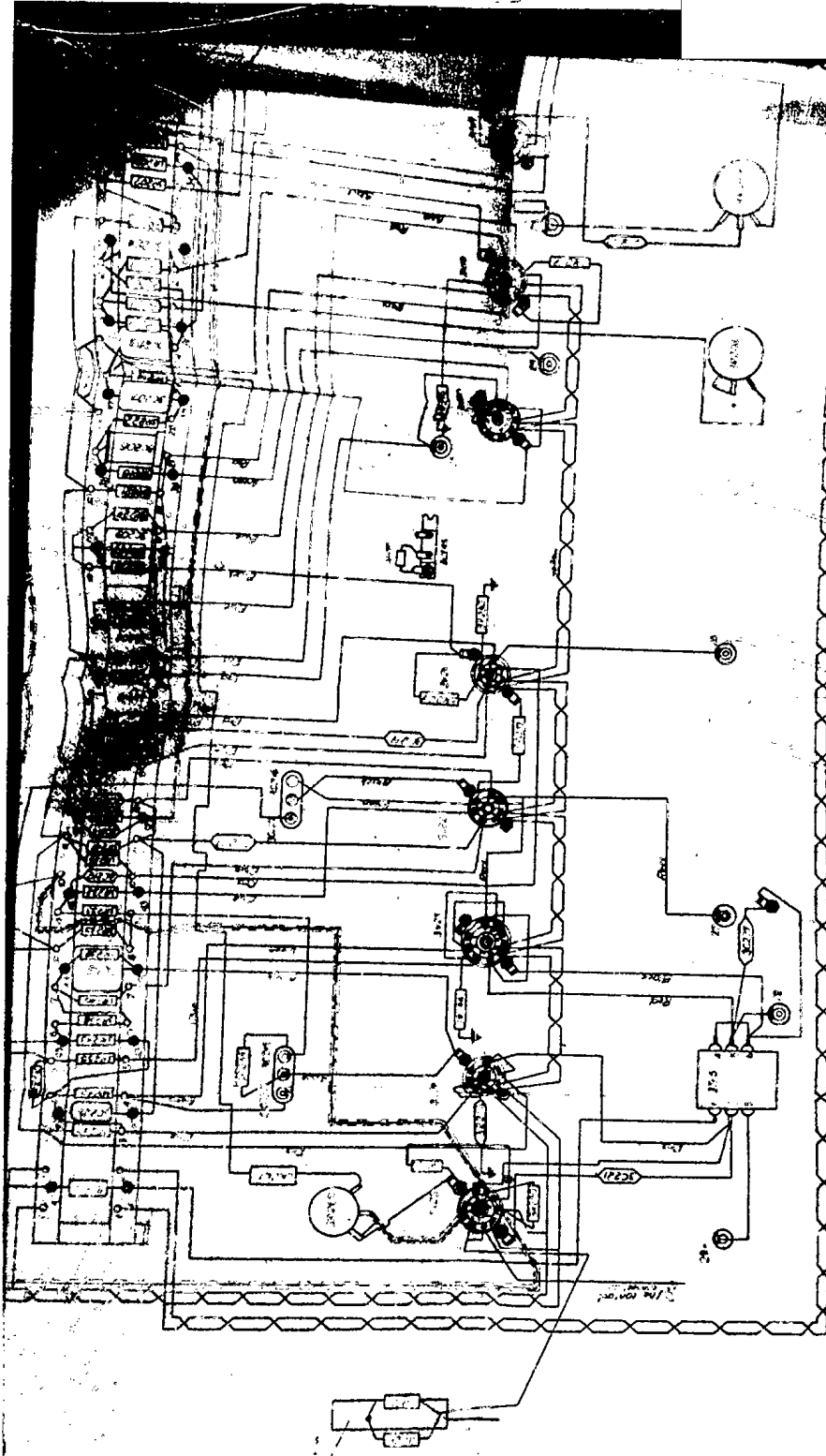

Notes

1. The cable is made of 100-40 gauge...
2. The cable is made of 100-40 gauge...
3. The cable is made of 100-40 gauge...
4. The cable is made of 100-40 gauge...
5. The cable is made of 100-40 gauge...
6. The cable is made of 100-40 gauge...
7. The cable is made of 100-40 gauge...
8. The cable is made of 100-40 gauge...
9. The cable is made of 100-40 gauge...
10. The cable is made of 100-40 gauge...

S-E-C-R-E-T

NO FOREIGN DISSEM

S-E-C-R-E-T
NO FOREIGN DISSEM

50X1

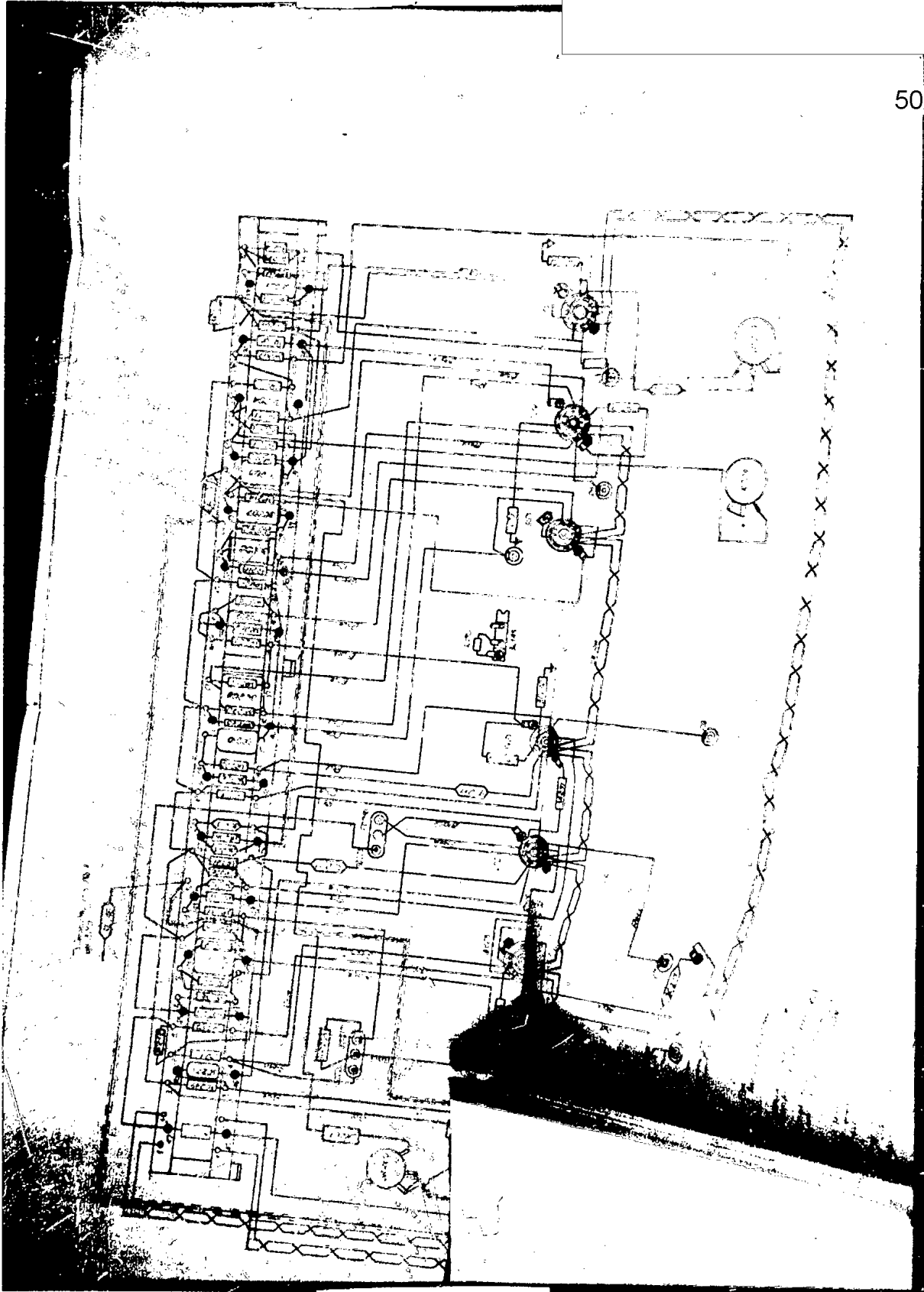

S-E-C-R-E-T
NO FOREIGN DISSEM

S-E-C-R-E-T
NO FOREIGN DISSEM

50X1

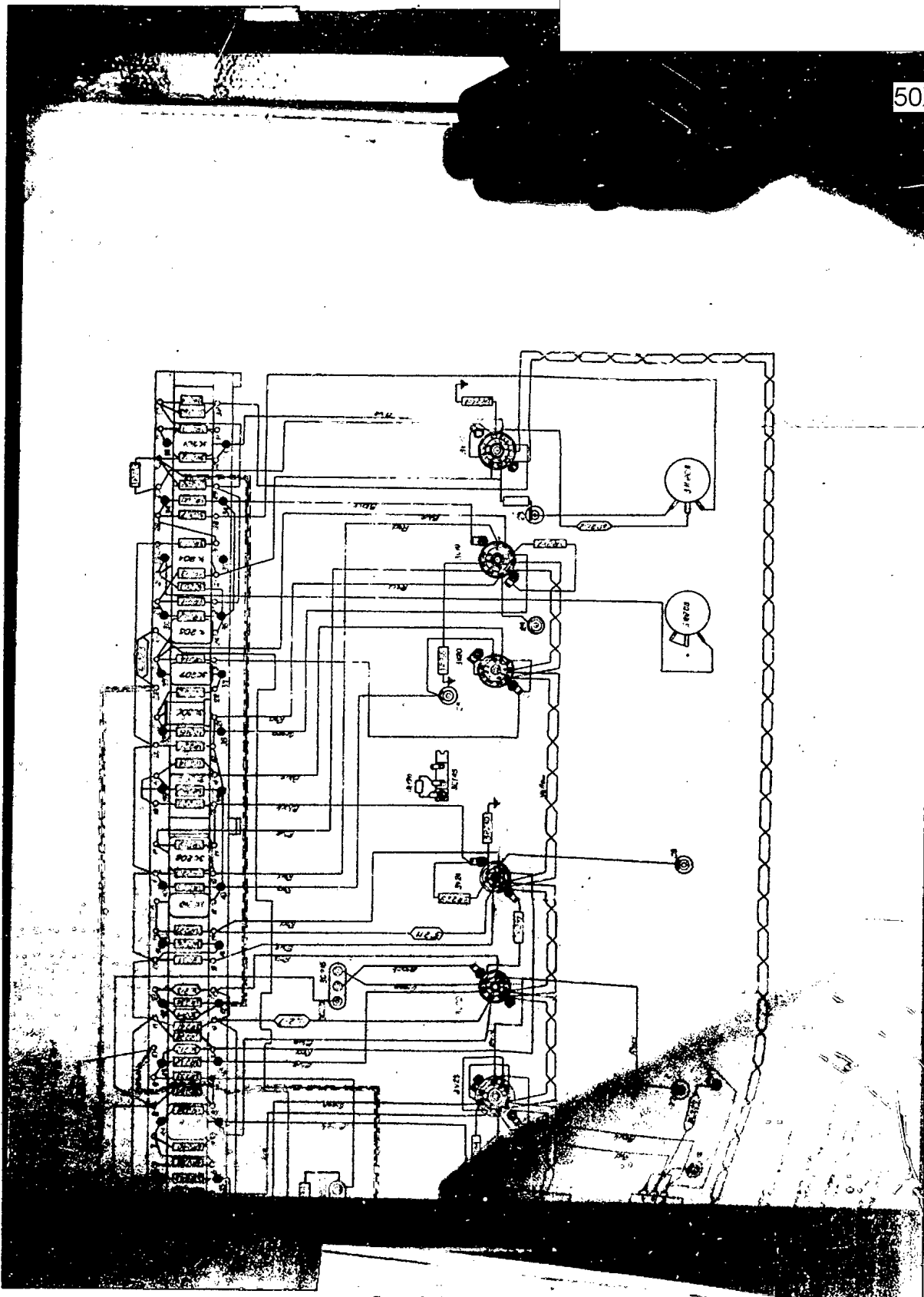

S-E-C-R-E-T
NO FOREIGN DISSEM

S-E-C-R-E-T
NO FOREIGN DISSEM

50X1

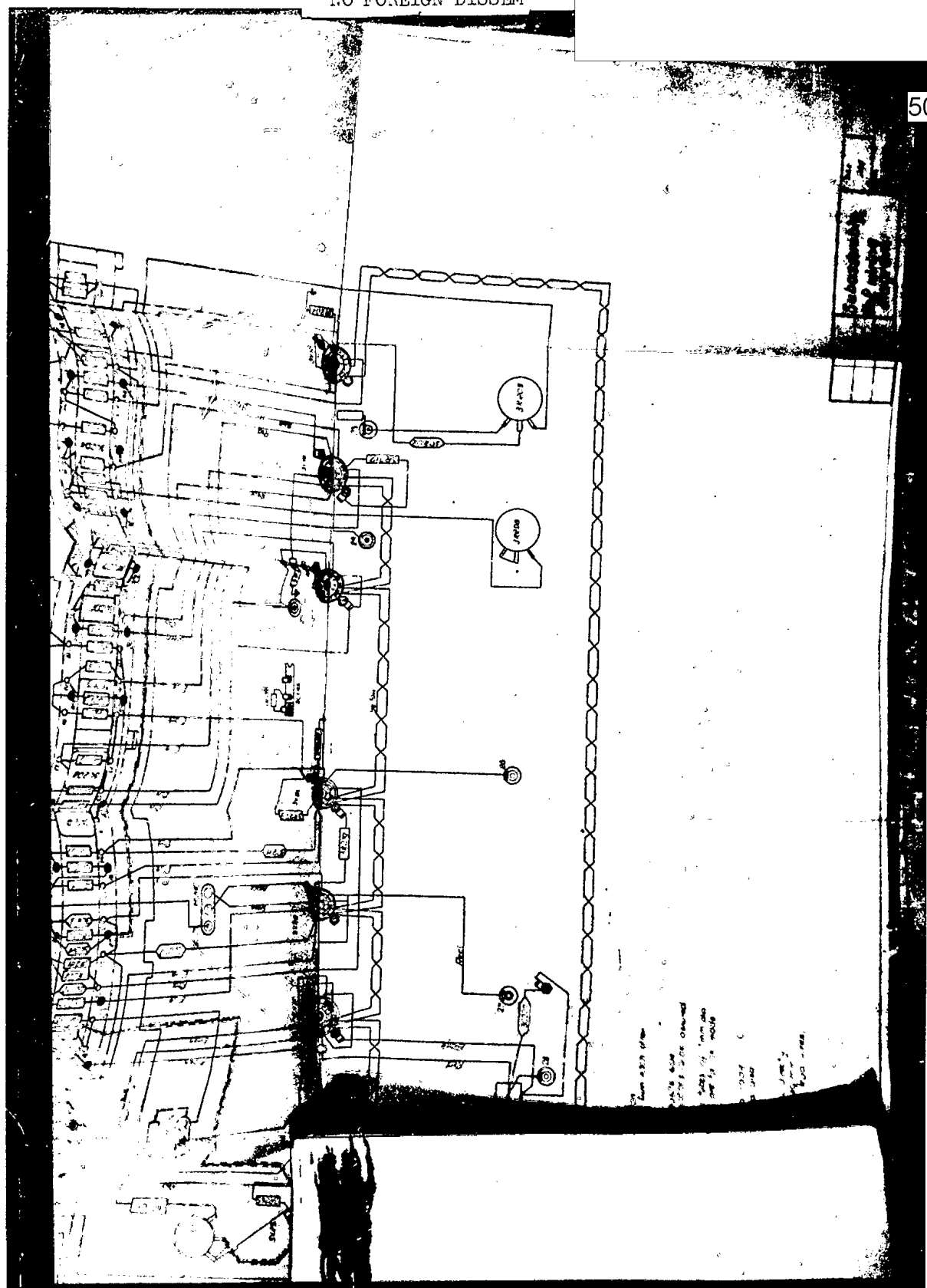

S-E-C-R-E-T
NO FOREIGN DISSEM

S-E-C-R-E-T
NO FOREIGN DISSEM



50X1

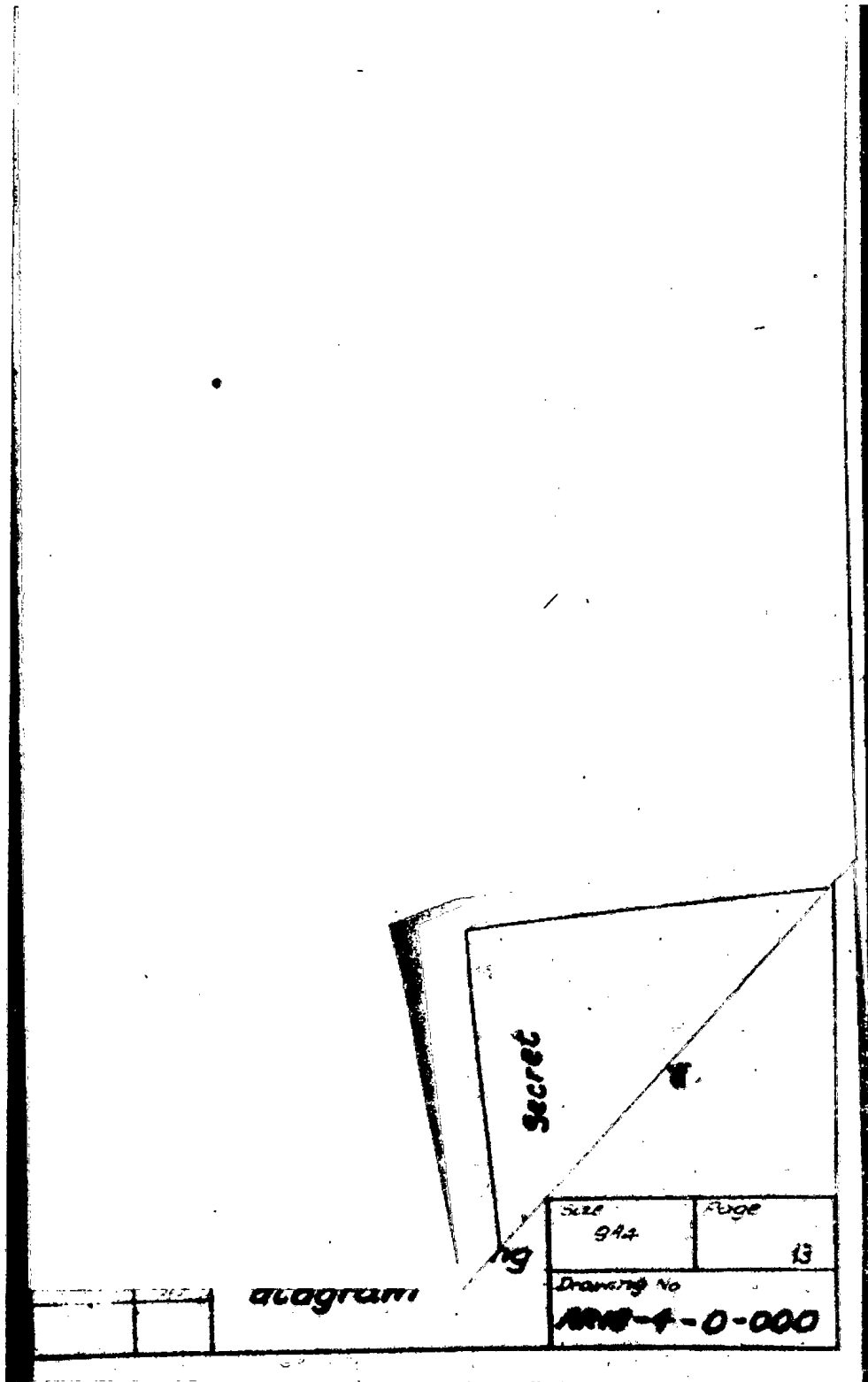

S-E-C-R-E-T
NO FOREIGN DISSEM

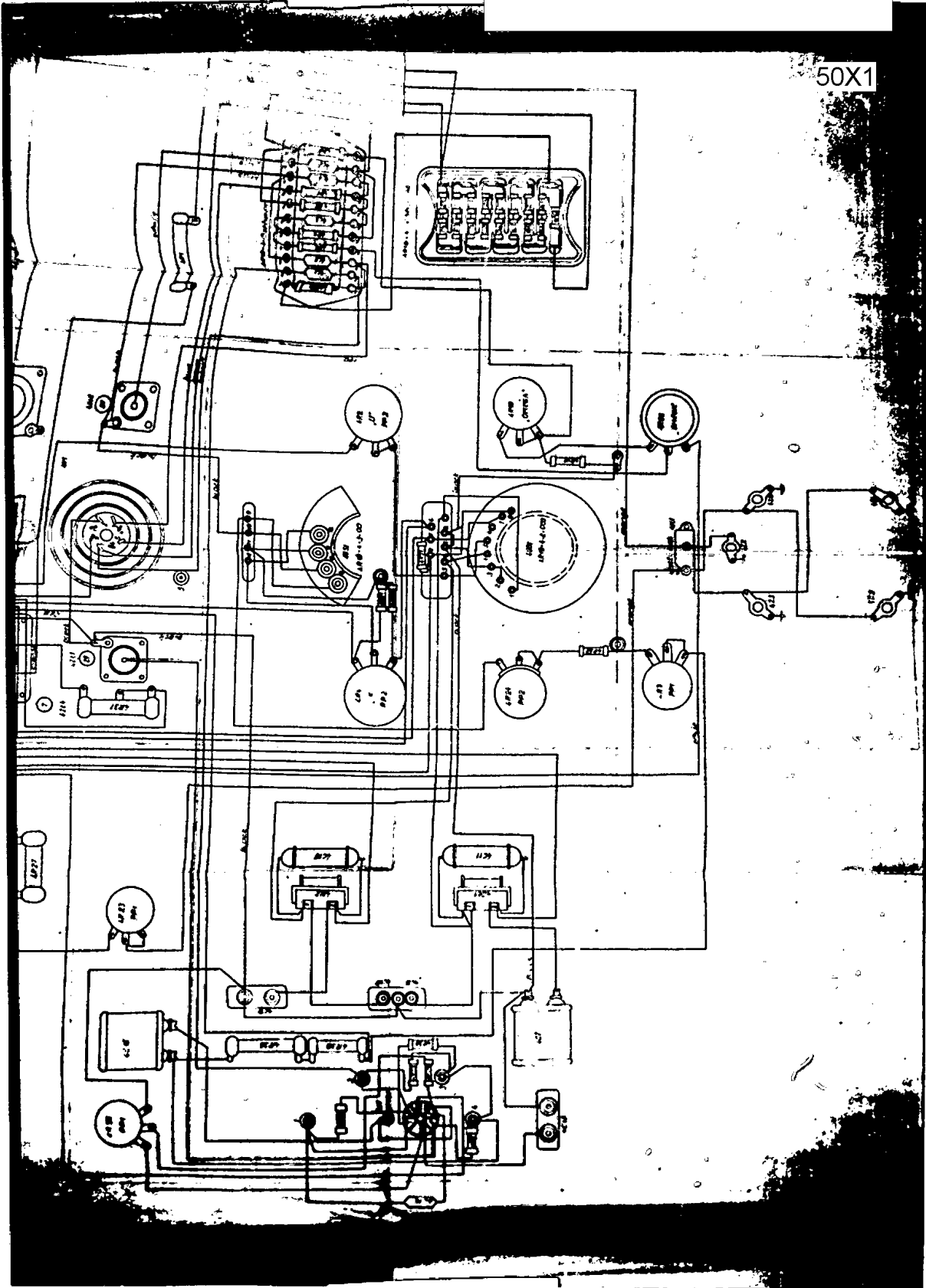

50X1

S-E-C-R-E-T

NO FOREIGN DISSEM

S-E-C-R-E-T
NO FOREIGN DISSEM

50X1

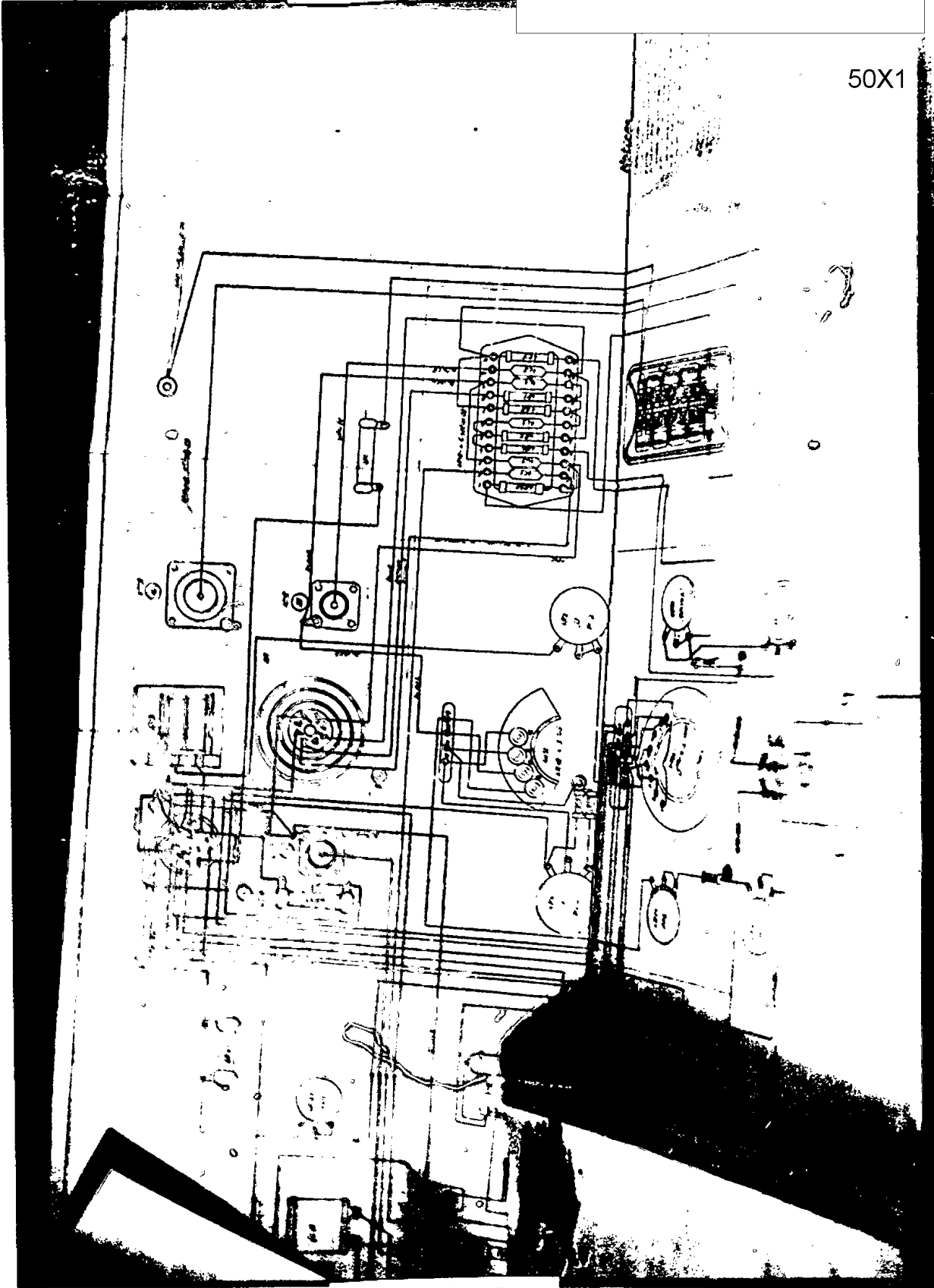

S-E-C-R-E-T
NO FOREIGN DISSEM

50X1

NOTES

1. This circuit is designed to operate from a 240V AC power source. The power source should be connected to the terminals marked "LINE" and "NEUTRAL".

2. The circuit is designed to operate at a frequency of 60 Hz. It is not recommended to operate this circuit at any other frequency.

3. The circuit is designed to operate at a power rating of 1000 VA. It is not recommended to operate this circuit at any other power rating.

4. The circuit is designed to operate at a temperature range of 0°C to 40°C. It is not recommended to operate this circuit at any other temperature range.

5. The circuit is designed to operate at a humidity range of 5% to 95%. It is not recommended to operate this circuit at any other humidity range.

6. The circuit is designed to operate at a pressure range of 1013 hPa to 1027 hPa. It is not recommended to operate this circuit at any other pressure range.

7. The circuit is designed to operate at a vibration range of 0.5 mm/s² to 1.0 mm/s². It is not recommended to operate this circuit at any other vibration range.

8. The circuit is designed to operate at a shock range of 10 g to 20 g. It is not recommended to operate this circuit at any other shock range.

9. The circuit is designed to operate at a maximum altitude of 10,000 feet. It is not recommended to operate this circuit at any other altitude.

10. The circuit is designed to operate at a maximum depth of 100 feet. It is not recommended to operate this circuit at any other depth.

11. The circuit is designed to operate at a maximum speed of 100 mph. It is not recommended to operate this circuit at any other speed.

12. The circuit is designed to operate at a maximum acceleration of 10 g. It is not recommended to operate this circuit at any other acceleration.

13. The circuit is designed to operate at a maximum deceleration of 10 g. It is not recommended to operate this circuit at any other deceleration.

14. The circuit is designed to operate at a maximum turn rate of 10 degrees per second. It is not recommended to operate this circuit at any other turn rate.

15. The circuit is designed to operate at a maximum turn rate of 10 degrees per second. It is not recommended to operate this circuit at any other turn rate.

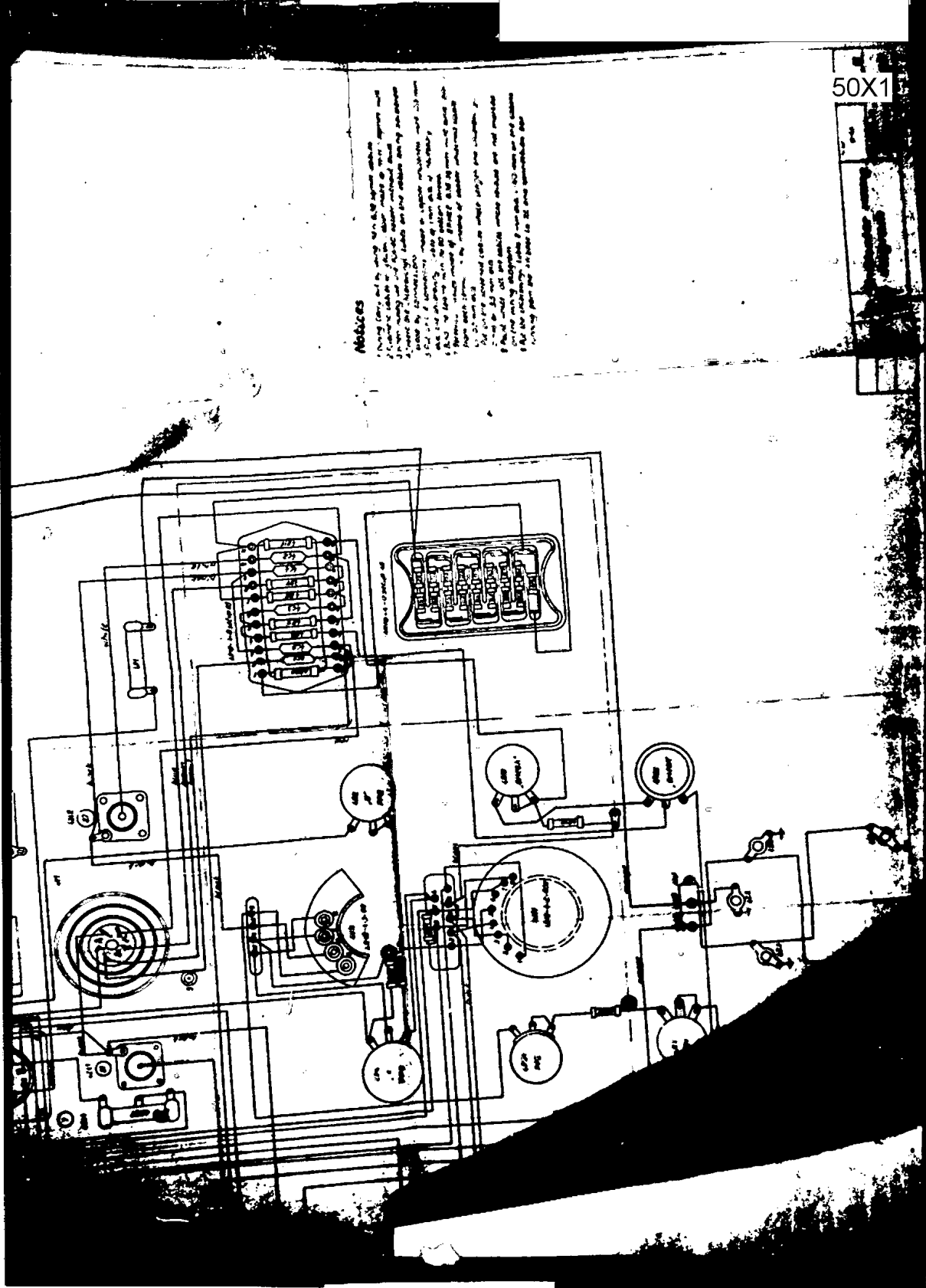

S-E-C-R-E-T

NO FOREIGN DISSEM

50X1

Abstract

This document describes a cryptographic system for the secure transmission of information. The system consists of a transmitter and a receiver, both of which are capable of operating in either a manual or an automatic mode. The transmitter is capable of transmitting information in either a plaintext or a ciphertext form, and the receiver is capable of receiving information in either a plaintext or a ciphertext form. The system is designed to provide a high level of security and is suitable for use in a variety of environments.

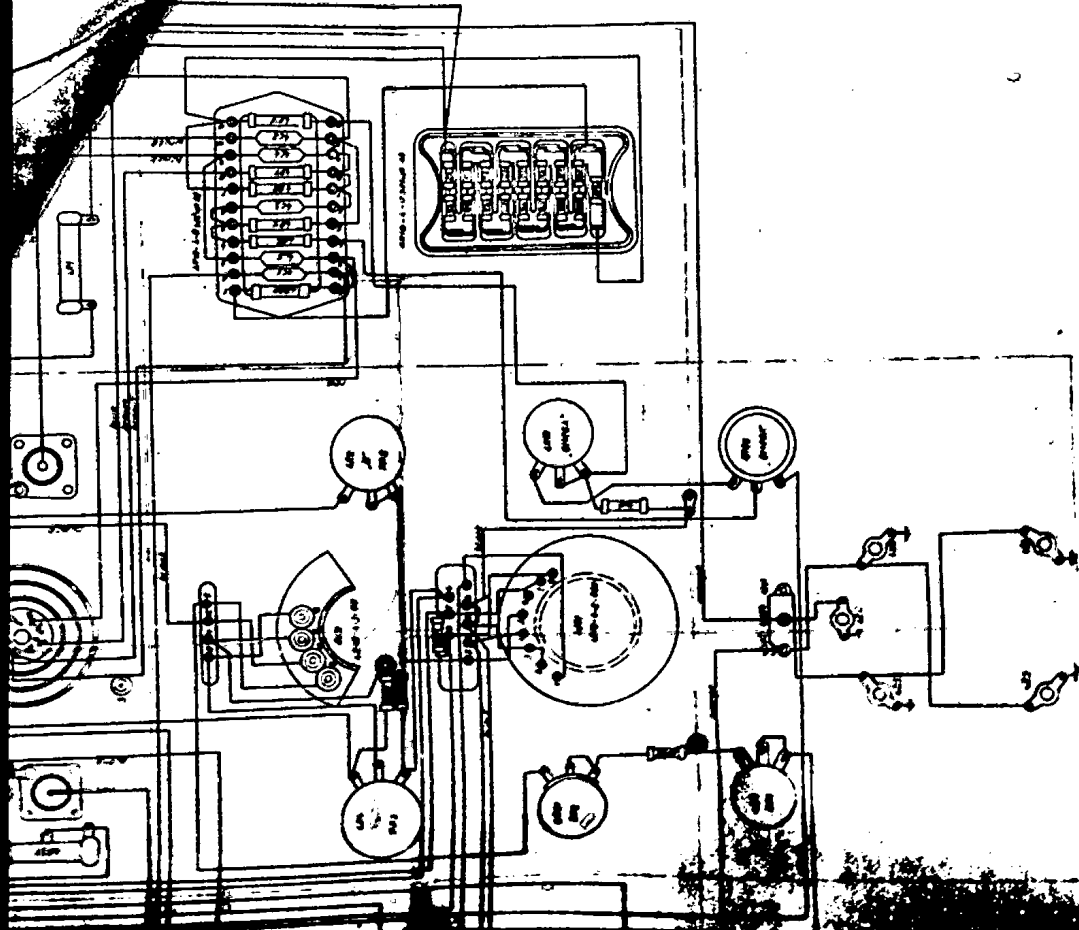

S-E-C-R-E-T

NO FOREIGN DISSEM

S-E-C-R-E-T
NO FOREIGN DISSEM

50X1

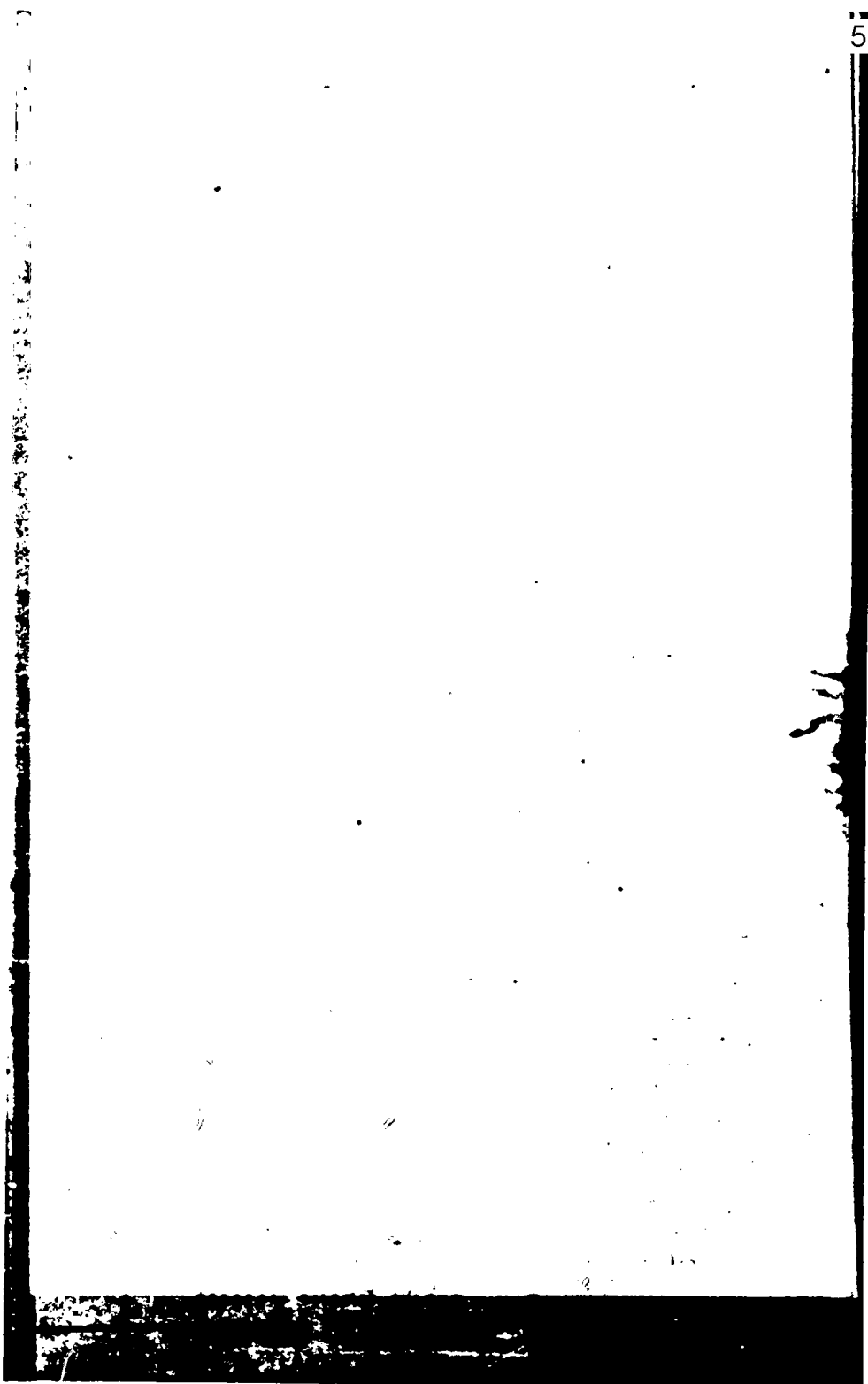

r4

S-E-C-R-E-T
NO FOREIGN DISSEM

S-E-C-R-E-T
NO FOREIGN DISSEM

50X1

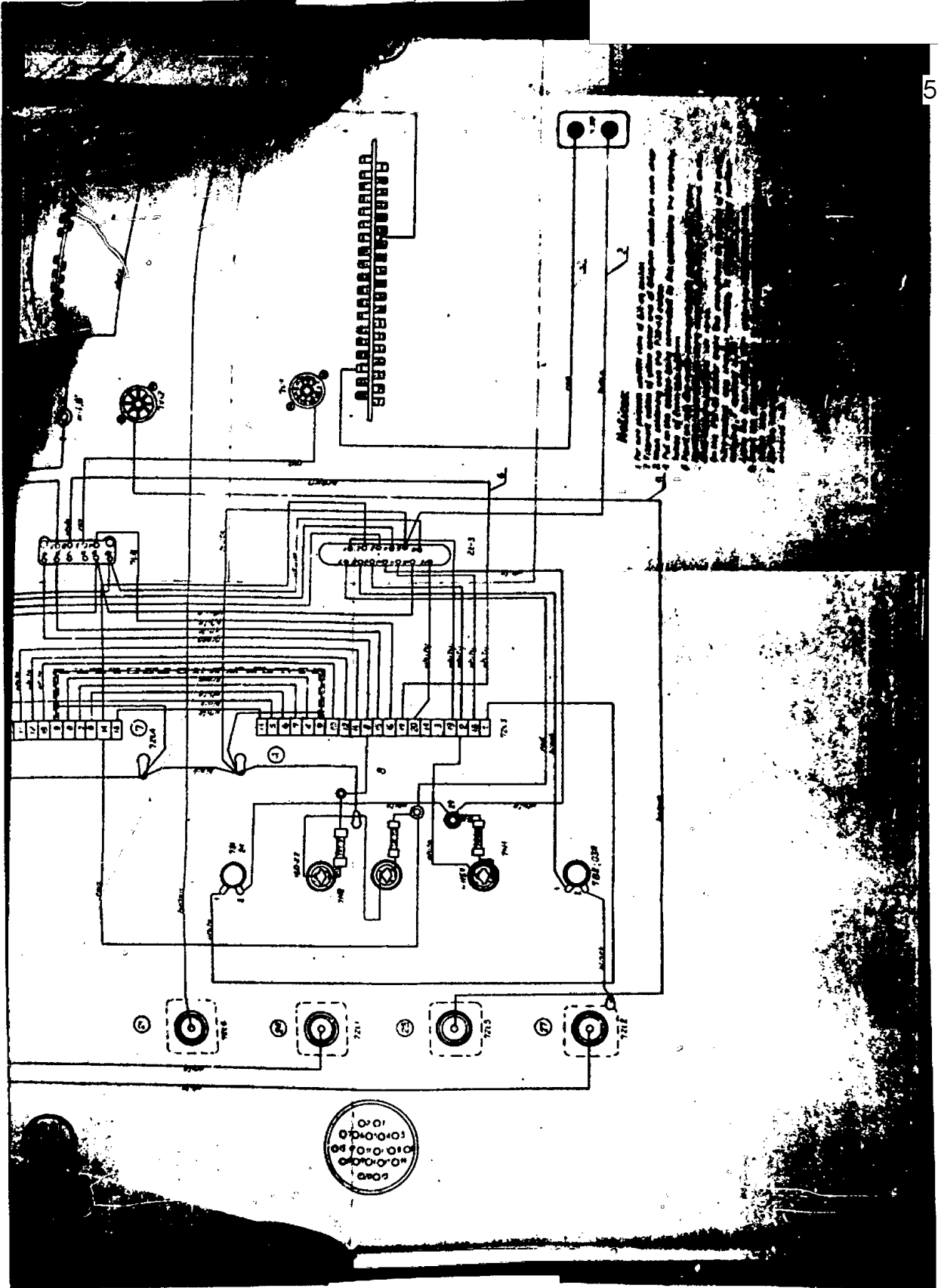

S-E-C-R-E-T
NO FOREIGN DISSEM

S-E-C-R-E-T
NO FOEIGN DISSEM

50X1

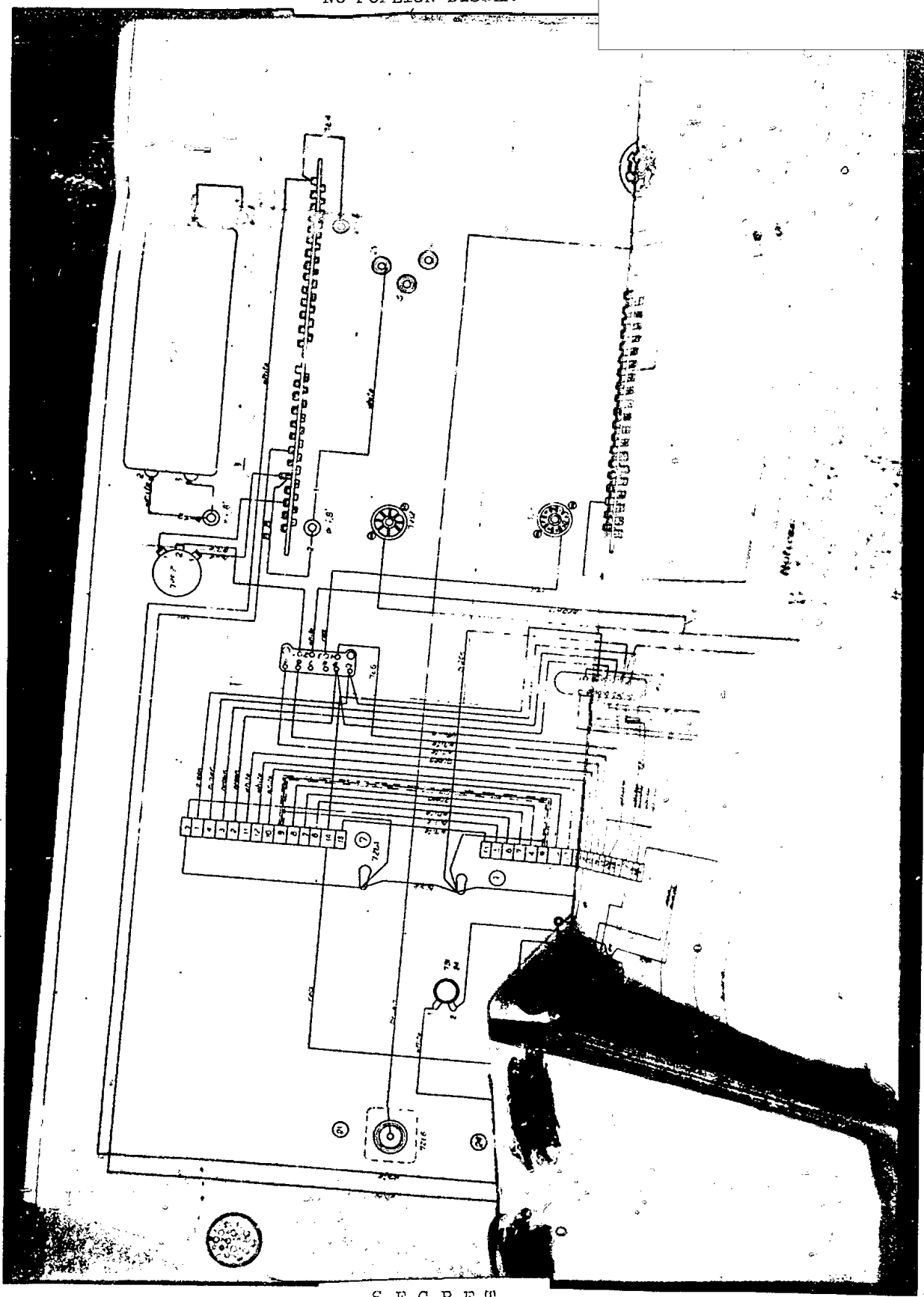

S-E-C-R-E-T
NO FOEIGN DISSEM

S-E-C-R-E-T
NO FOREIGN DISSEM

50X1

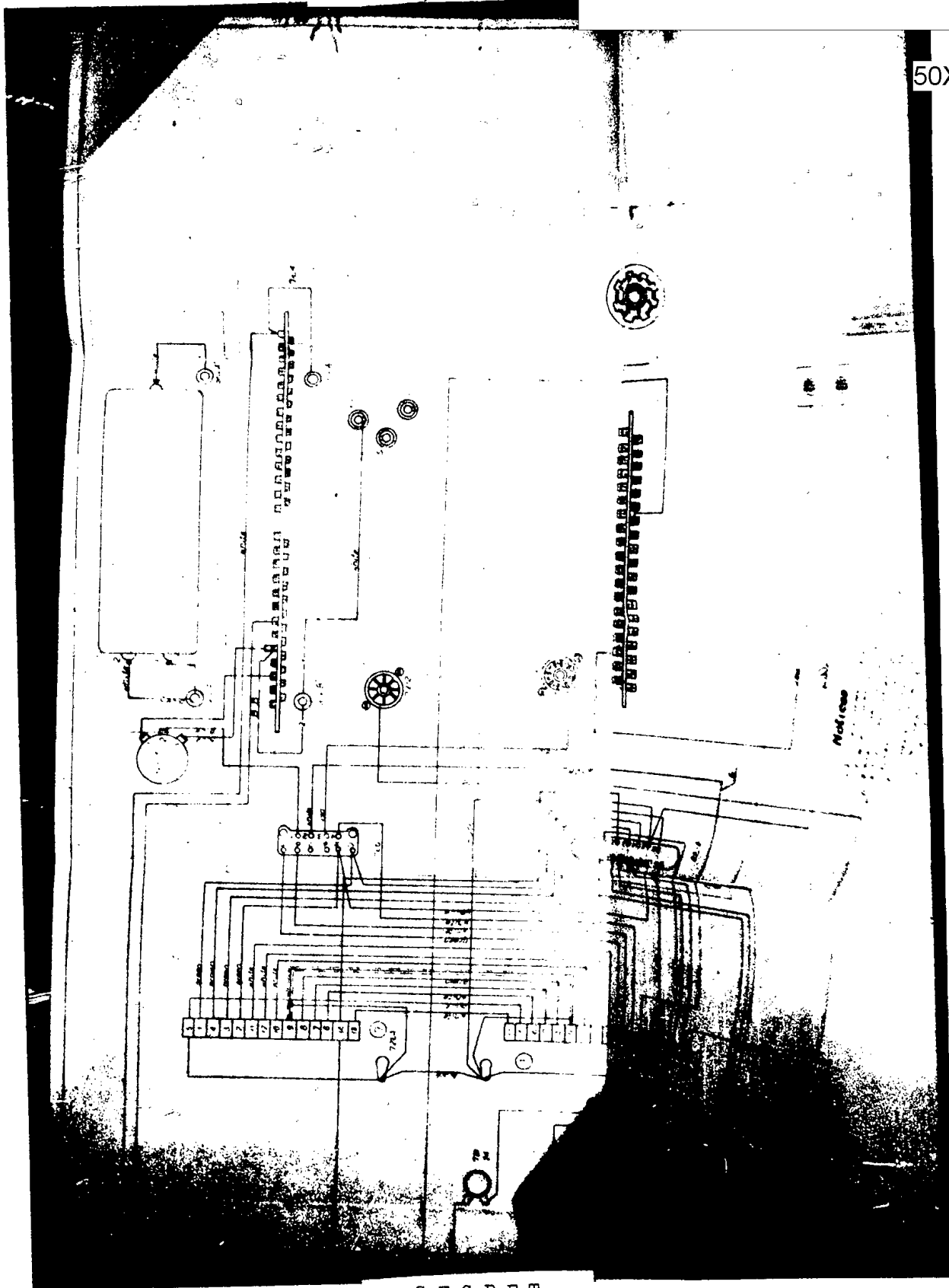

S-E-C-R-E-T
NO FOREIGN DISSEM

S-E-C-R-E-T
NO FOREIGN DISSEM

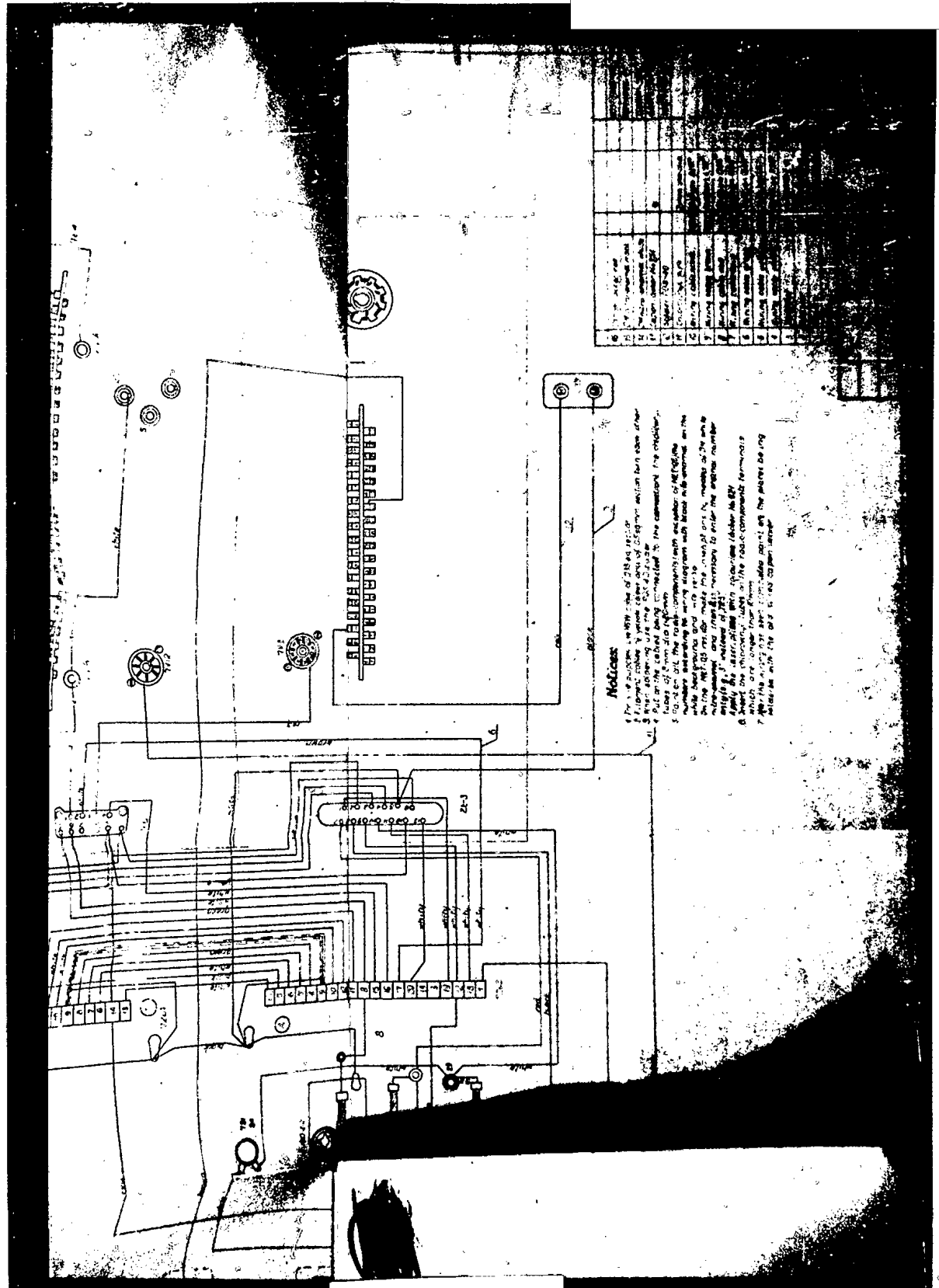

NOTES:

1. The system is a 24-bit system.
2. The system is a 24-bit system.
3. The system is a 24-bit system.
4. The system is a 24-bit system.
5. The system is a 24-bit system.
6. The system is a 24-bit system.
7. The system is a 24-bit system.
8. The system is a 24-bit system.
9. The system is a 24-bit system.
10. The system is a 24-bit system.

S-E-C-R-E-T
NO FOREIGN DISSEM

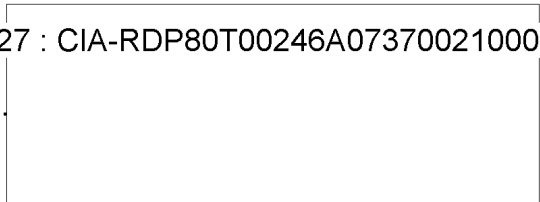

50X1

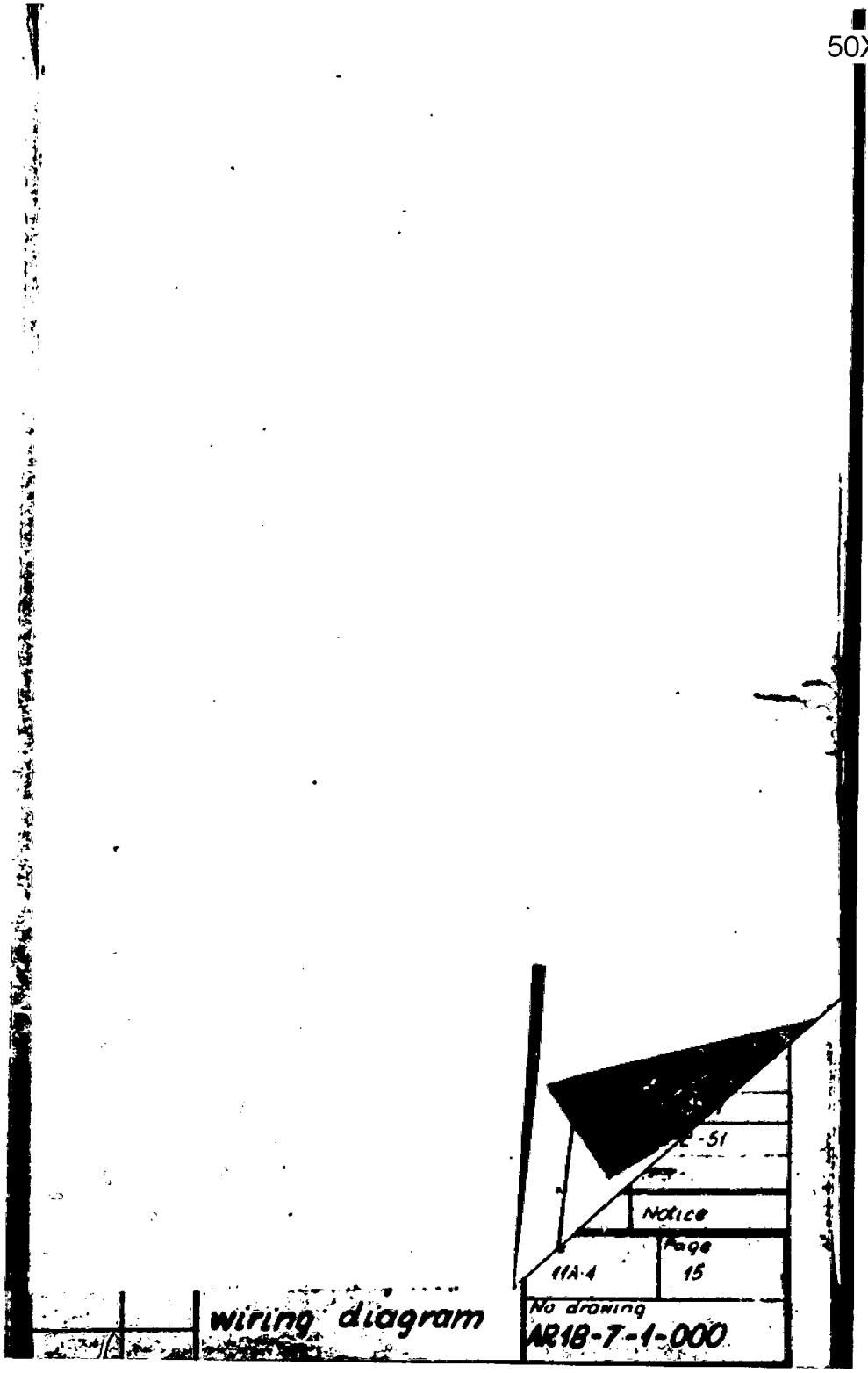

11A-4	
No drawing	
AR18-7-1-000	
Page	15
NOTICE	
-51	

wiring diagram

S-E-C-R-E-T

NO FOREIGN DISSEM

S-E-C-R-E-T
NO FOREIGN DISSEM

50X1

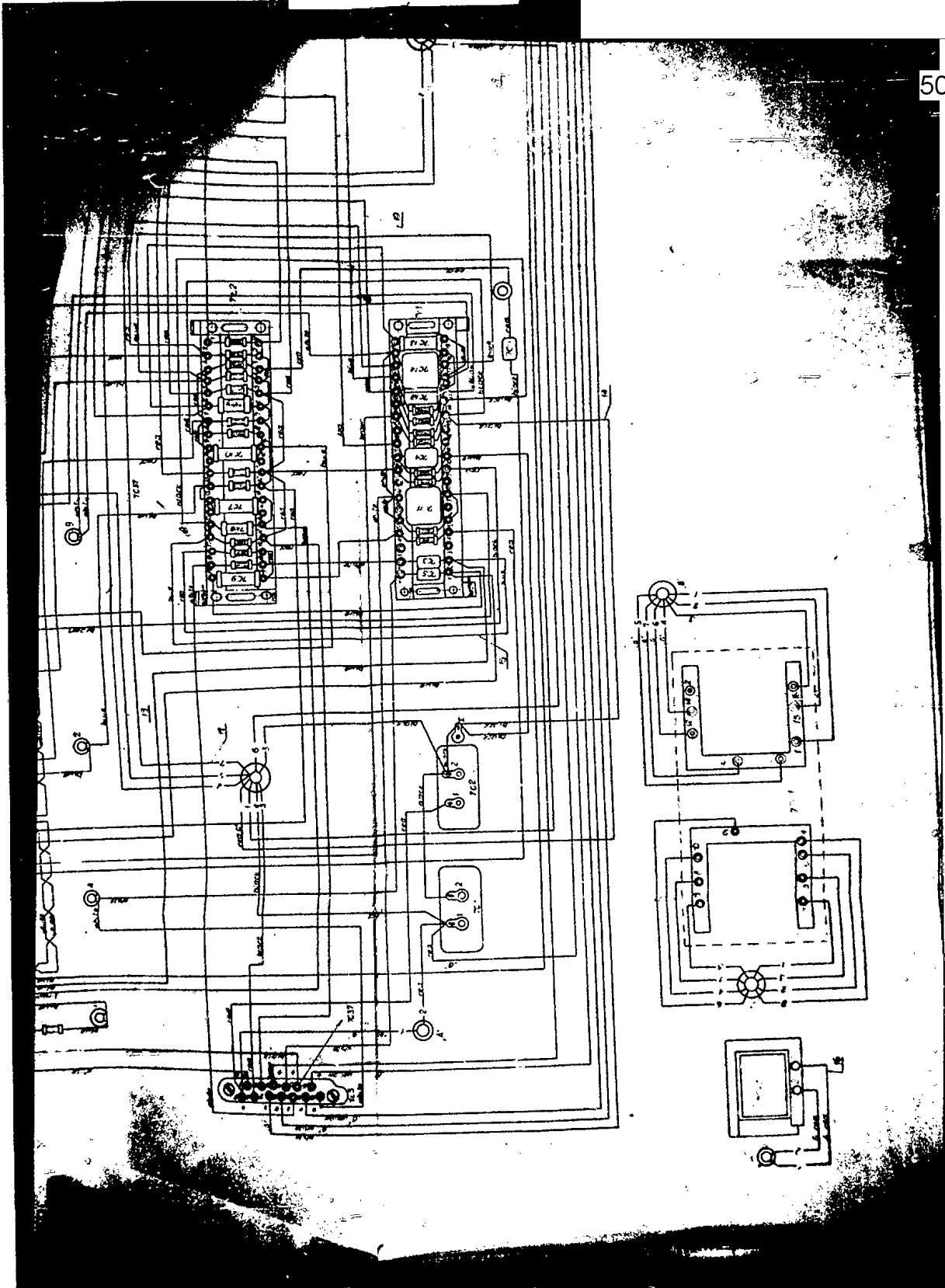

S-E-C-R-E-T
NO FOREIGN DISSEM

15

S-E-C-R-E-T
NO FOREIGN DISSEM

50X1

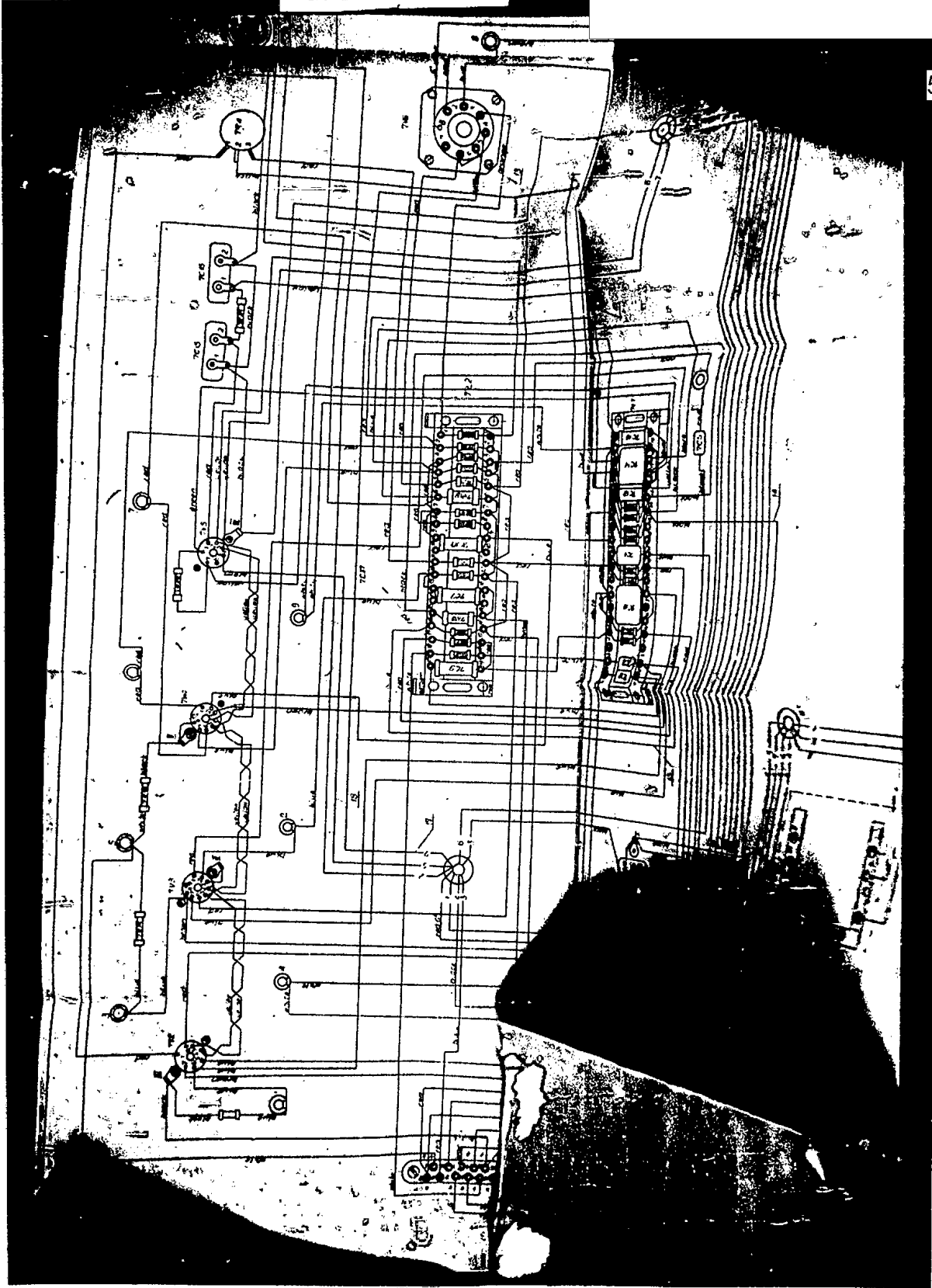

S-E-C-R-E-T
NO FOREIGN DISSEM

66

S-E-C-R-E-T
NO FOREIGN DISSEM



50X1

Notices:

1. The wiring diagram and the test procedures are to be used only for the purpose of maintaining the equipment in the field.
2. The test procedures are to be used only for the purpose of maintaining the equipment in the field.
3. The test procedures are to be used only for the purpose of maintaining the equipment in the field.
4. The test procedures are to be used only for the purpose of maintaining the equipment in the field.
5. The test procedures are to be used only for the purpose of maintaining the equipment in the field.
6. The test procedures are to be used only for the purpose of maintaining the equipment in the field.
7. The test procedures are to be used only for the purpose of maintaining the equipment in the field.
8. The test procedures are to be used only for the purpose of maintaining the equipment in the field.
9. The test procedures are to be used only for the purpose of maintaining the equipment in the field.
10. The test procedures are to be used only for the purpose of maintaining the equipment in the field.

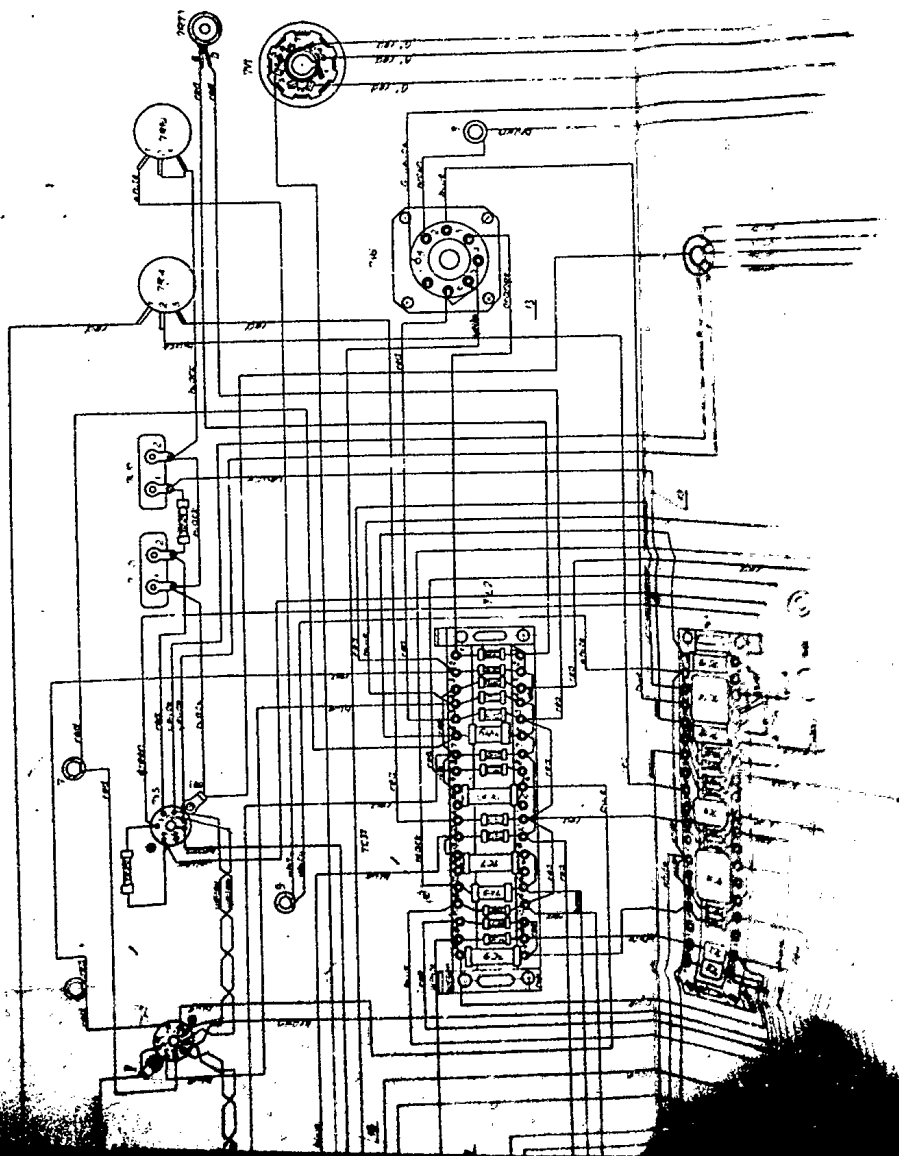

S-E-C-R-E-T

NO FOREIGN DISSEM

S-E-C-R-E-T
NO FOREIGN DISSEM

50X1

Notices:

1. The wiring diagram will be shown the MIL-STD-883C test procedures.
2. The wiring diagram will be shown the MIL-STD-883C test procedures.
3. The wiring diagram will be shown the MIL-STD-883C test procedures.
4. The wiring diagram will be shown the MIL-STD-883C test procedures.
5. The wiring diagram will be shown the MIL-STD-883C test procedures.
6. The wiring diagram will be shown the MIL-STD-883C test procedures.
7. The wiring diagram will be shown the MIL-STD-883C test procedures.
8. The wiring diagram will be shown the MIL-STD-883C test procedures.
9. The wiring diagram will be shown the MIL-STD-883C test procedures.
10. The wiring diagram will be shown the MIL-STD-883C test procedures.

1	...
2	...
3	...
4	...
5	...
6	...
7	...
8	...
9	...
10	...

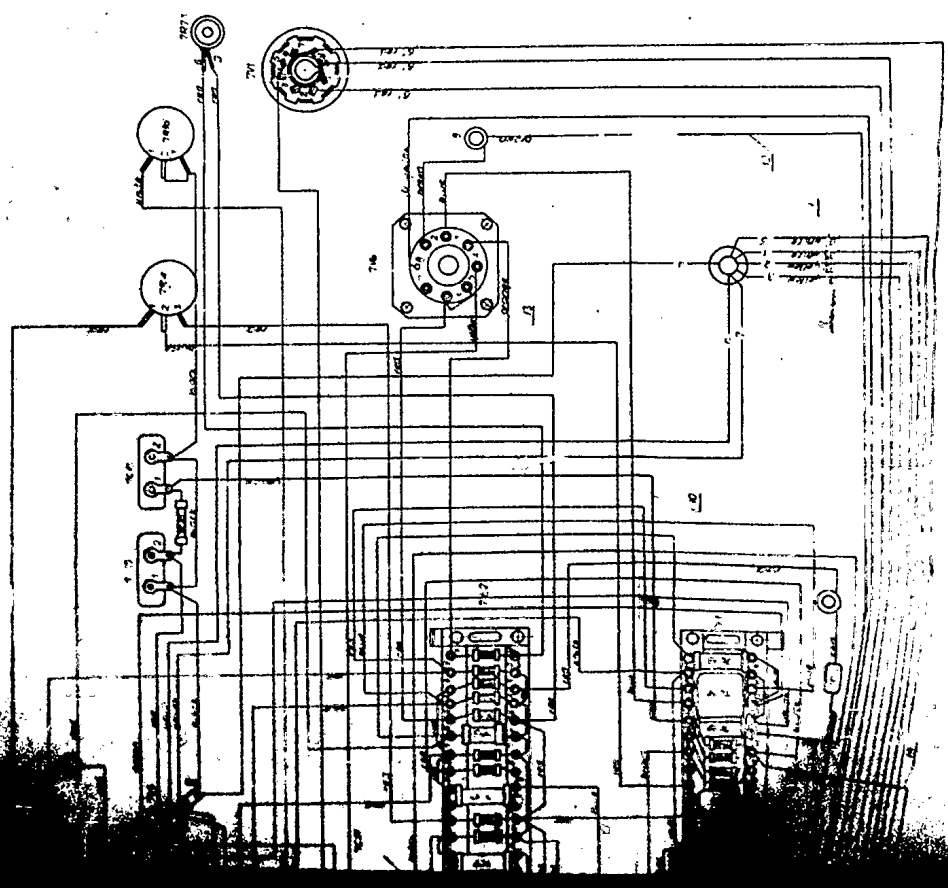

S-E-C-R-E-T
NO FOREIGN DISSEM

S-E-C-R-E-T
NO FOREIGN DISSEM

50X1

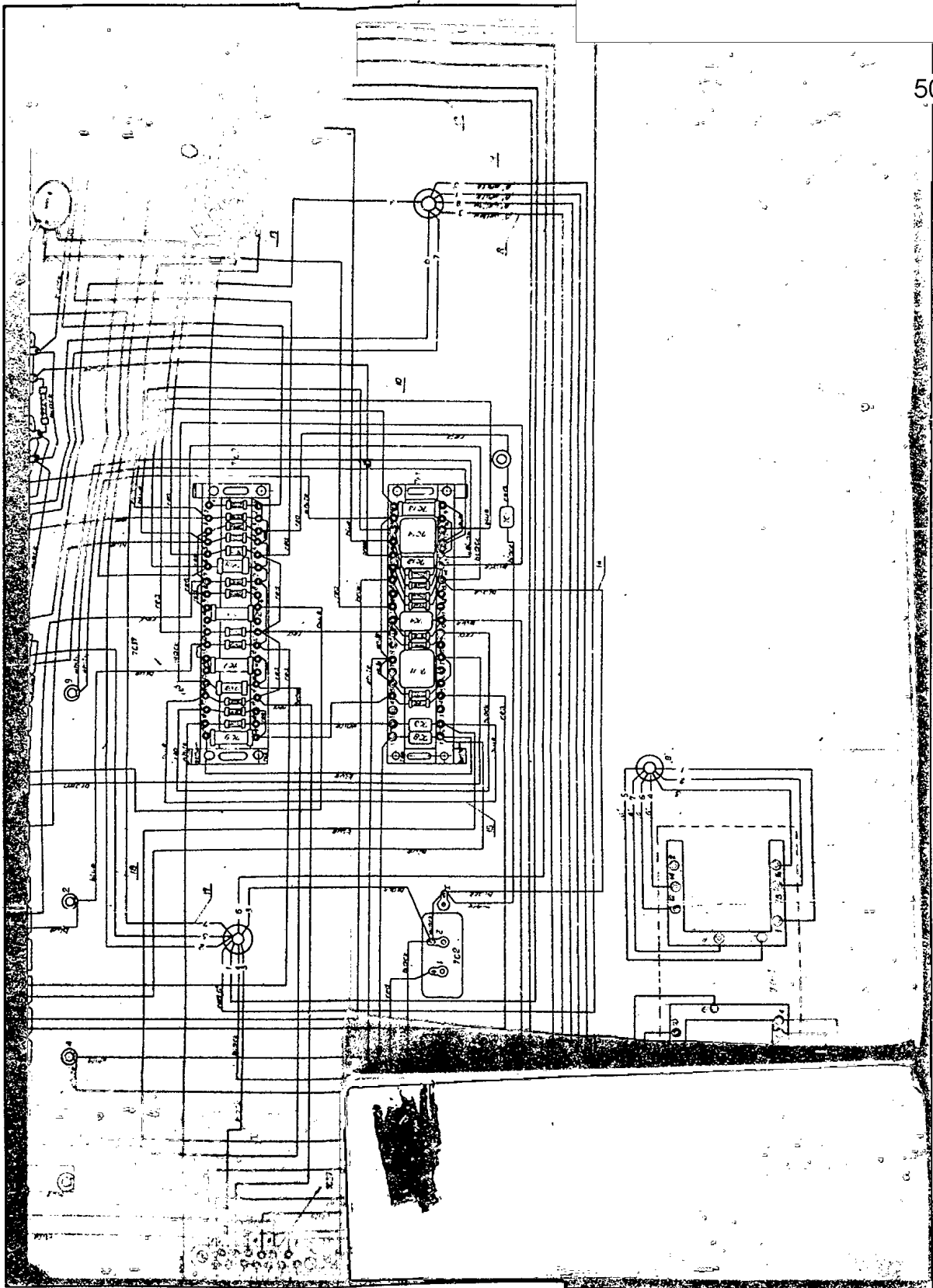

S-E-C-R-E-T
NO FOREIGN DISSEM

SECRET
NO FOREIGN DISSEM

NOTICES:

1. This drawing is to be used in conjunction with drawing 100-100000-1000.
2. The drawing is to be used in conjunction with drawing 100-100000-1000.
3. The drawing is to be used in conjunction with drawing 100-100000-1000.
4. The drawing is to be used in conjunction with drawing 100-100000-1000.
5. The drawing is to be used in conjunction with drawing 100-100000-1000.
6. The drawing is to be used in conjunction with drawing 100-100000-1000.
7. The drawing is to be used in conjunction with drawing 100-100000-1000.
8. The drawing is to be used in conjunction with drawing 100-100000-1000.
9. The drawing is to be used in conjunction with drawing 100-100000-1000.
10. The drawing is to be used in conjunction with drawing 100-100000-1000.

Item No.	Description	Quantity	Part No.
1
2
3
4
5
6
7
8
9
10
11
12
13
14
15
16
17
18
19
20
21
22
23
24
25
26
27
28
29
30
31
32
33
34
35
36
37
38
39
40
41
42
43
44
45
46
47
48
49
50
51
52
53
54
55
56
57
58
59
60
61
62
63
64
65
66
67
68
69
70
71
72
73
74
75
76
77
78
79
80
81
82
83
84
85
86
87
88
89
90
91
92
93
94
95
96
97
98
99
100

50X1

Subassembly No. 1
Wiring Diagram

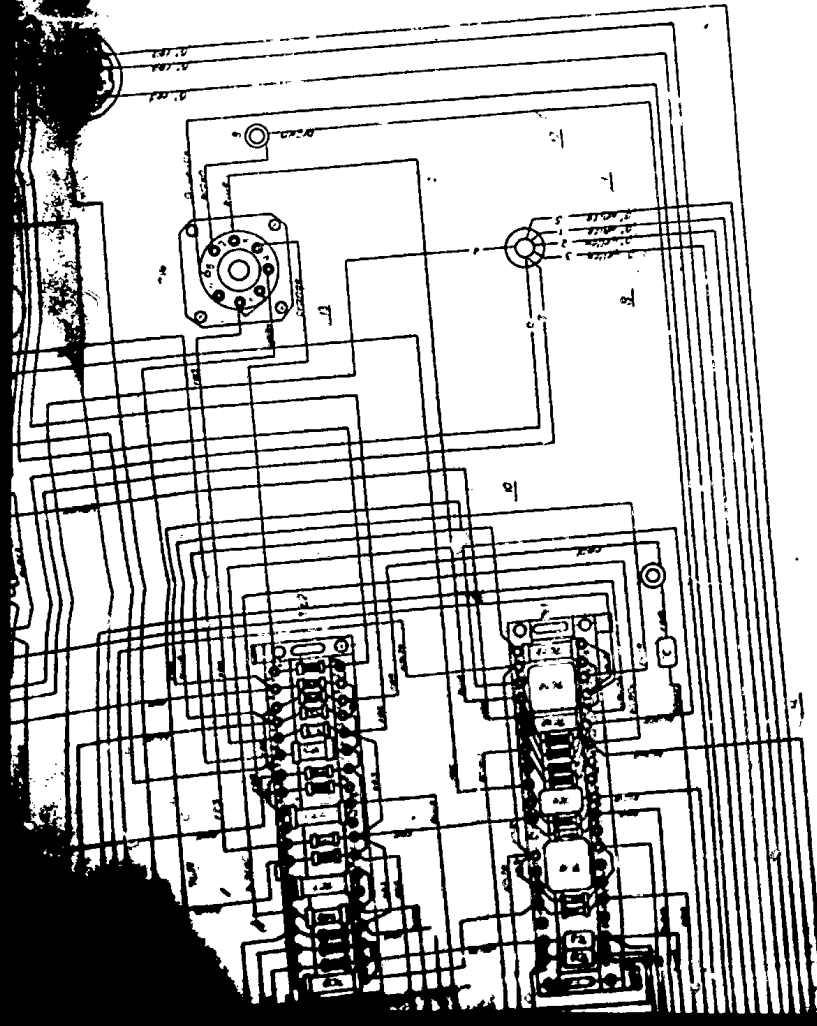

SECRET
NO FOREIGN DISSEM



50X1

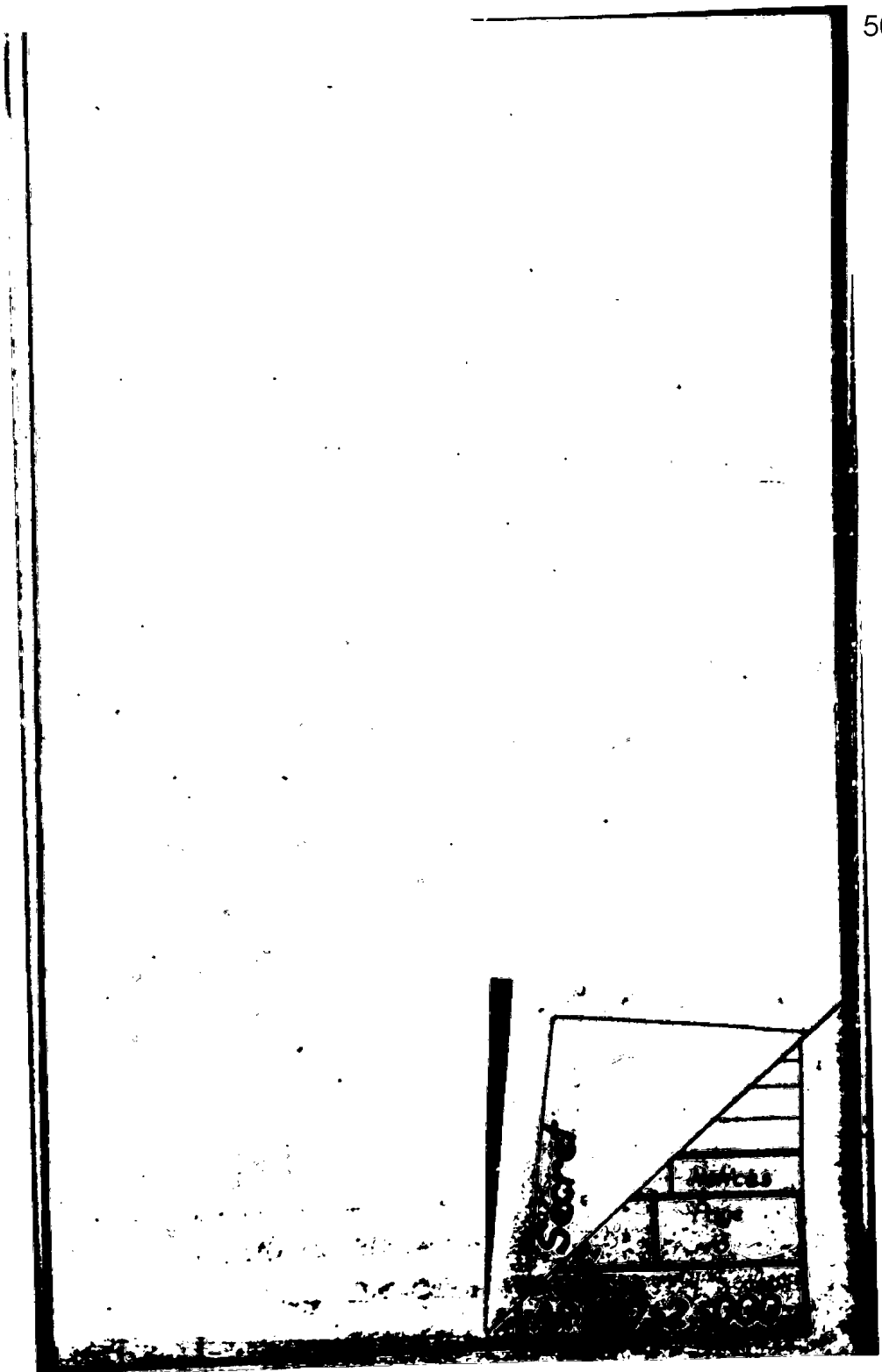

S-E-C-R-E-T

NO FOREIGN DISSEM

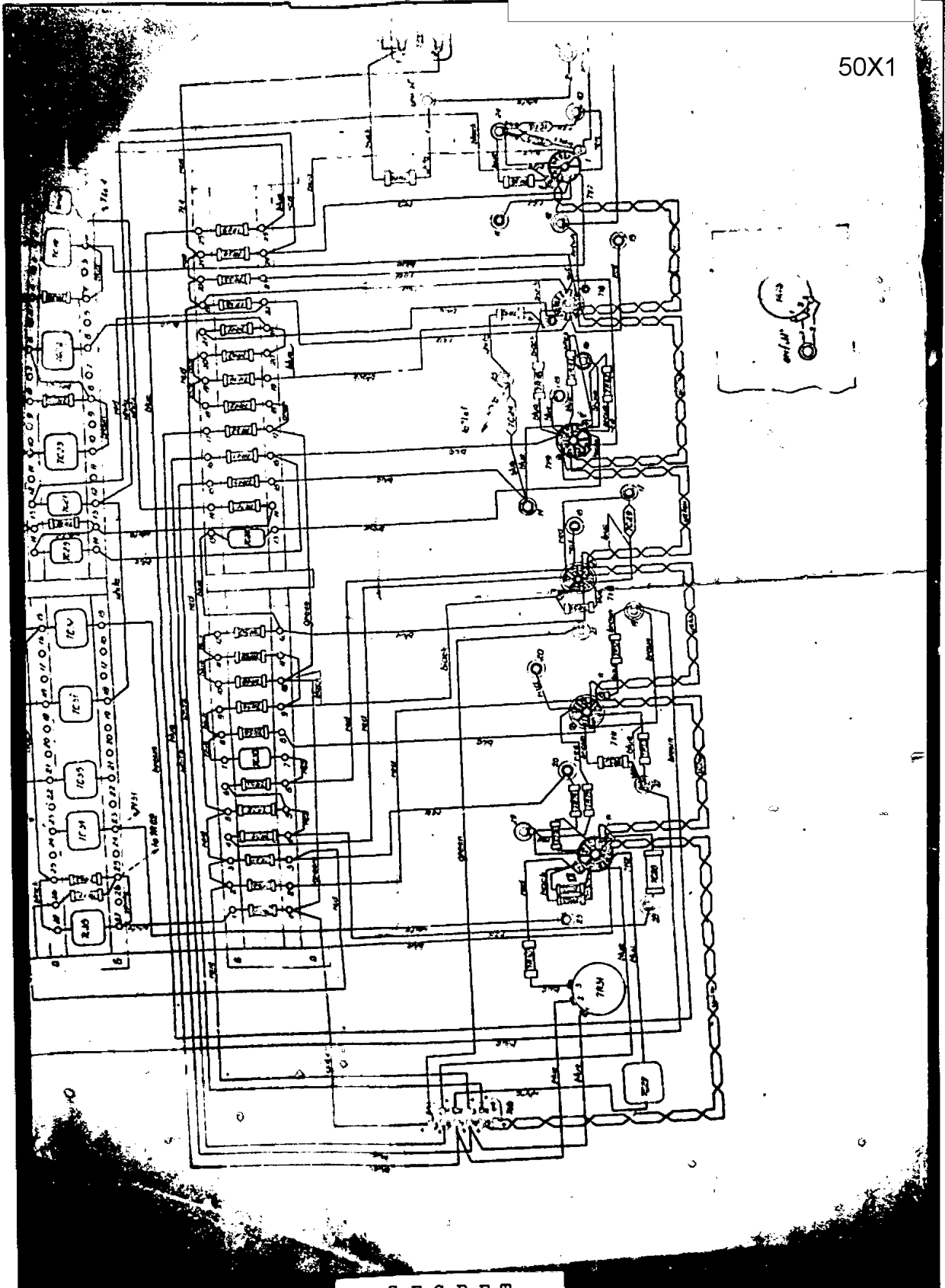

50X1

S-E-C-R-E-T

NO FOREIGN DISSEM

S-E-C-R-E-T
NO FOREIGN DISSEM

50X1

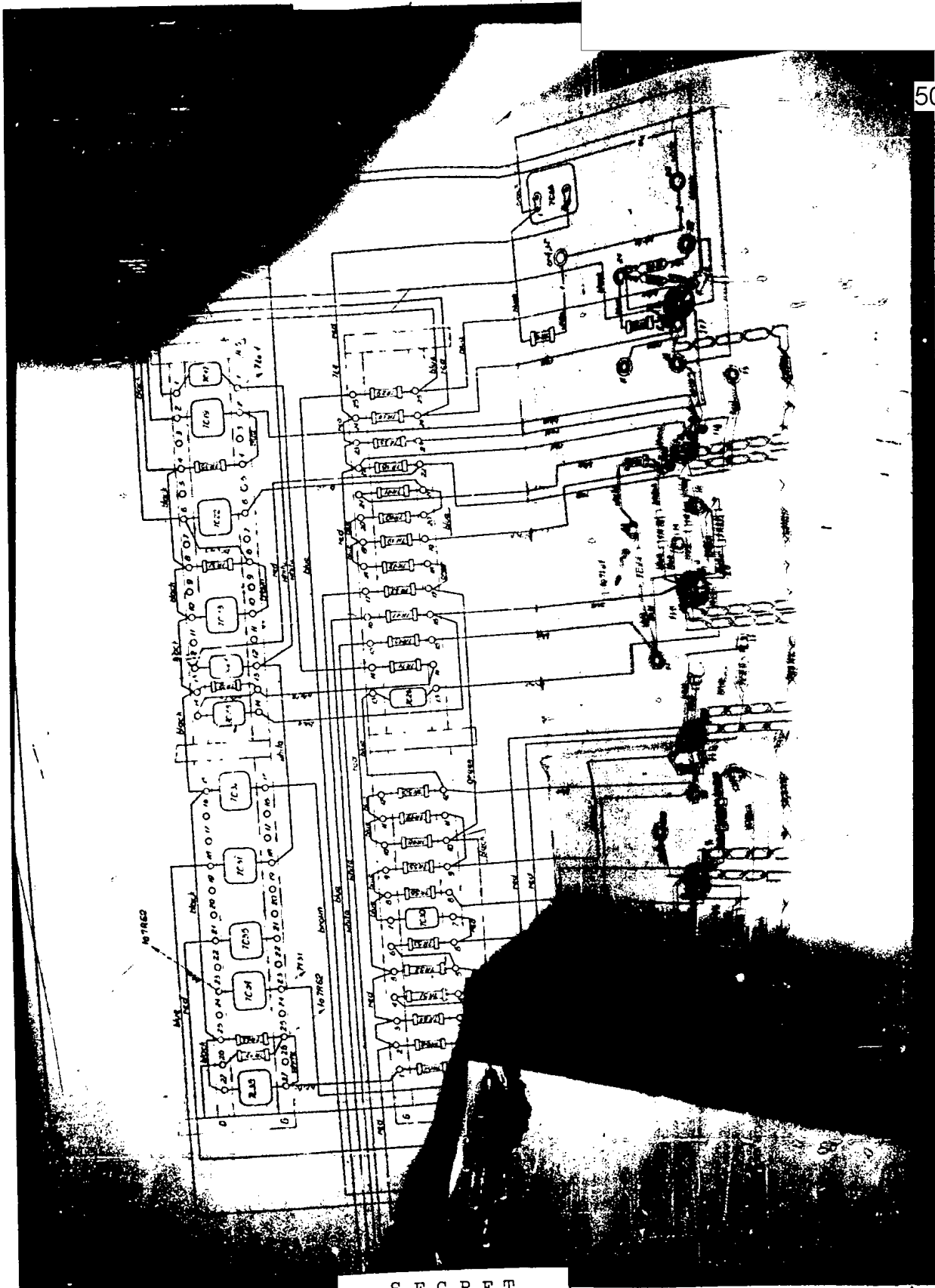

S-E-C-R-E-T
NO FOREIGN DISSEM

S-E-C-R-E-T
NO FOREIGN DISSEM

50X1

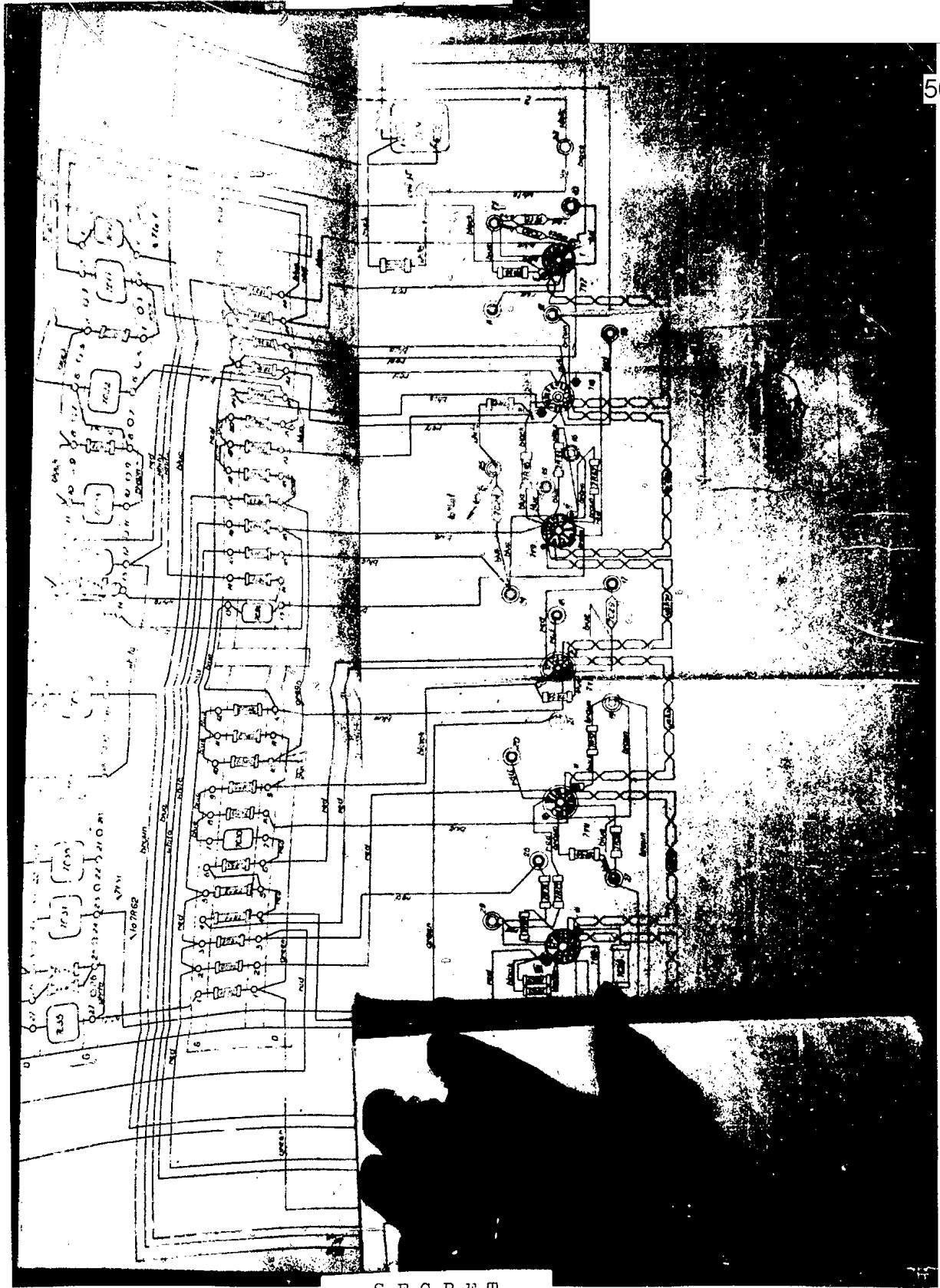

S-E-C-R-E-T
NO FOREIGN DISSEM

S-E-C-R-E-T
NO FOREIGN DISSEM

50X1



S-E-C-R-E-T
NO FOREIGN DISSEM

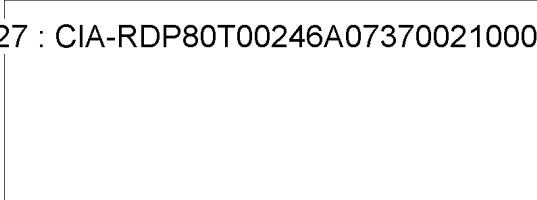

50X1

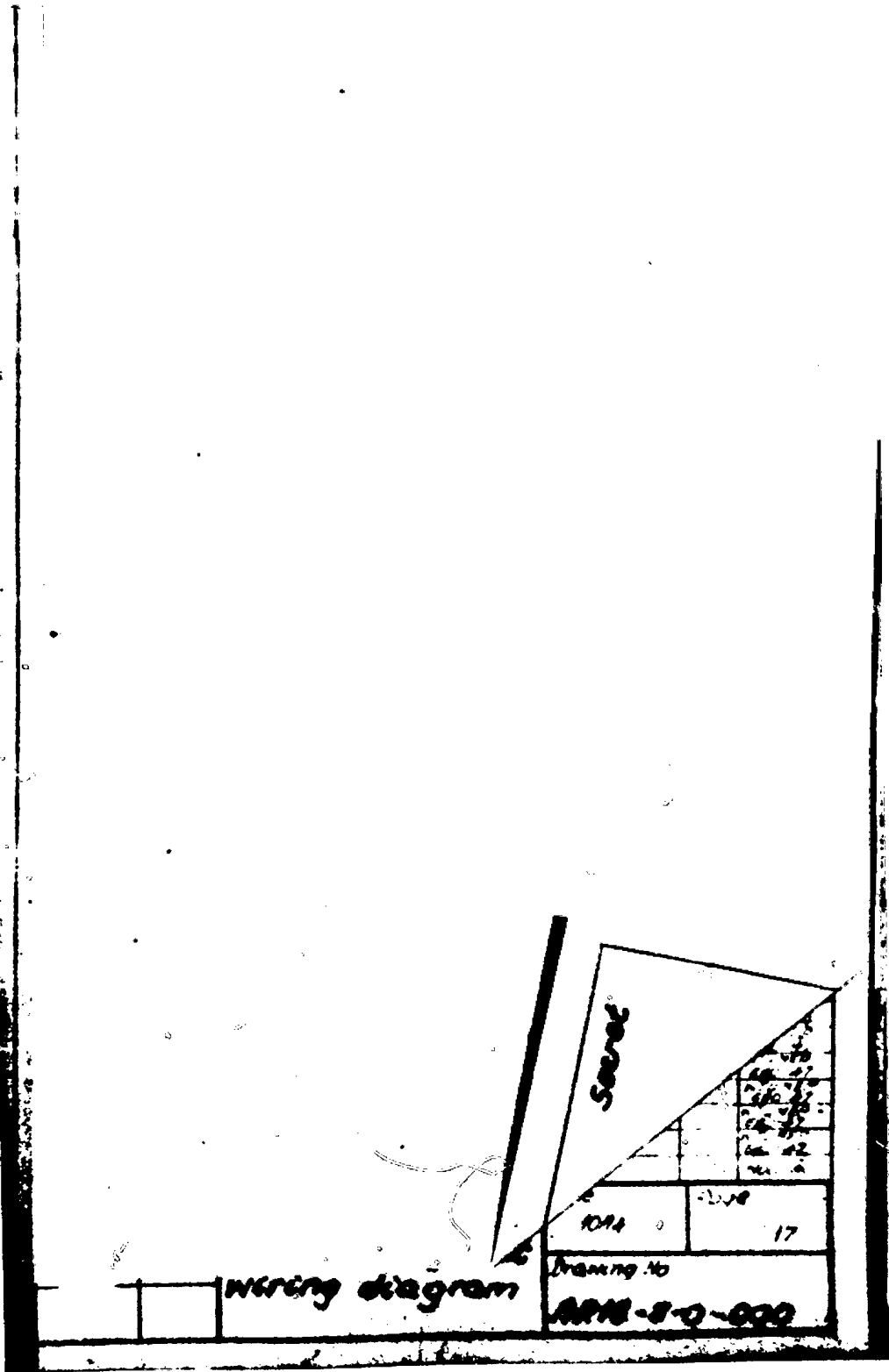

S-E-C-R-E-T

NO FOREIGN DISSEM

S-E-C-R-E-T
NO FOREIGN DISSEM



50X1

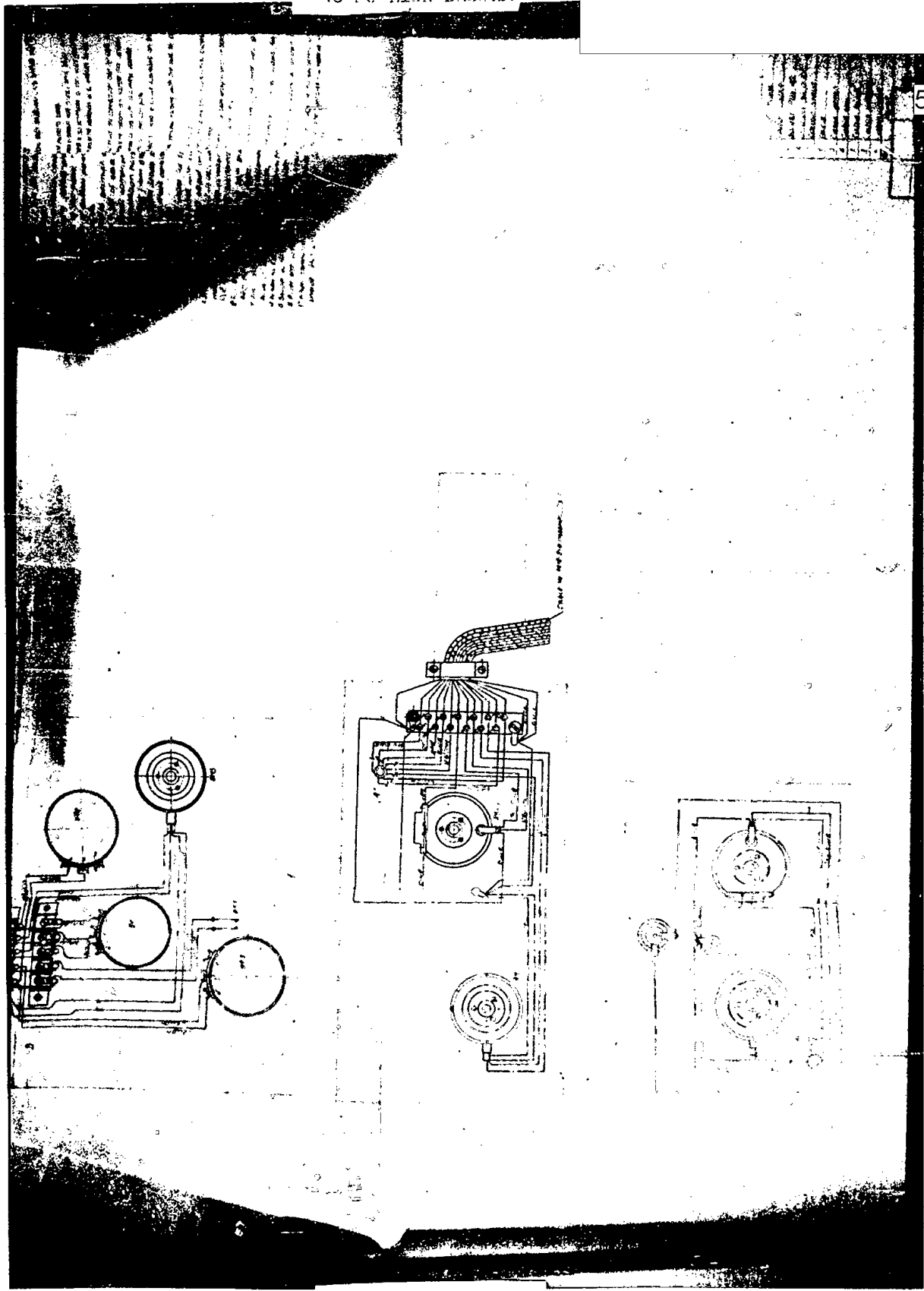

S-E-C-R-E-T

NO FOREIGN DISSEM

S-E-C-R-E-T
NO FOREIGN DISSEM

50X1

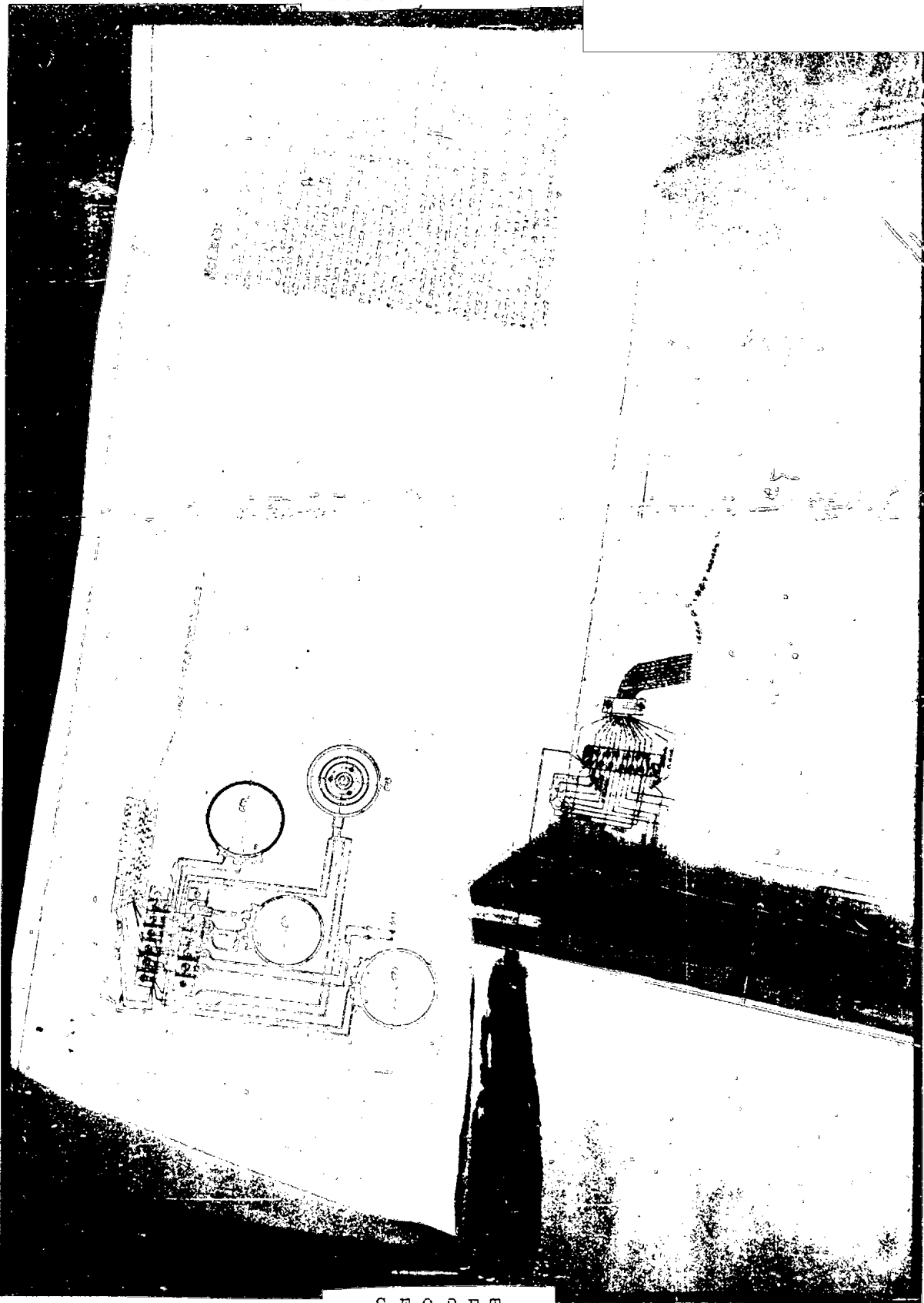

S-E-C-R-E-T
NO FOREIGN DISSEM

NO FOREIGN DISSEM

50X1

NOTES:

1. The above information was obtained from a confidential source who has provided reliable information in the past. It is being furnished to you for your information only. It is not to be disseminated outside your agency.

2. The above information is being furnished to you for your information only. It is not to be disseminated outside your agency.

3. The above information is being furnished to you for your information only. It is not to be disseminated outside your agency.

4. The above information is being furnished to you for your information only. It is not to be disseminated outside your agency.

5. The above information is being furnished to you for your information only. It is not to be disseminated outside your agency.

6. The above information is being furnished to you for your information only. It is not to be disseminated outside your agency.

7. The above information is being furnished to you for your information only. It is not to be disseminated outside your agency.

8. The above information is being furnished to you for your information only. It is not to be disseminated outside your agency.

9. The above information is being furnished to you for your information only. It is not to be disseminated outside your agency.

10. The above information is being furnished to you for your information only. It is not to be disseminated outside your agency.

S-E-C-R-E-T

NO FOREIGN DISSEM

50X1

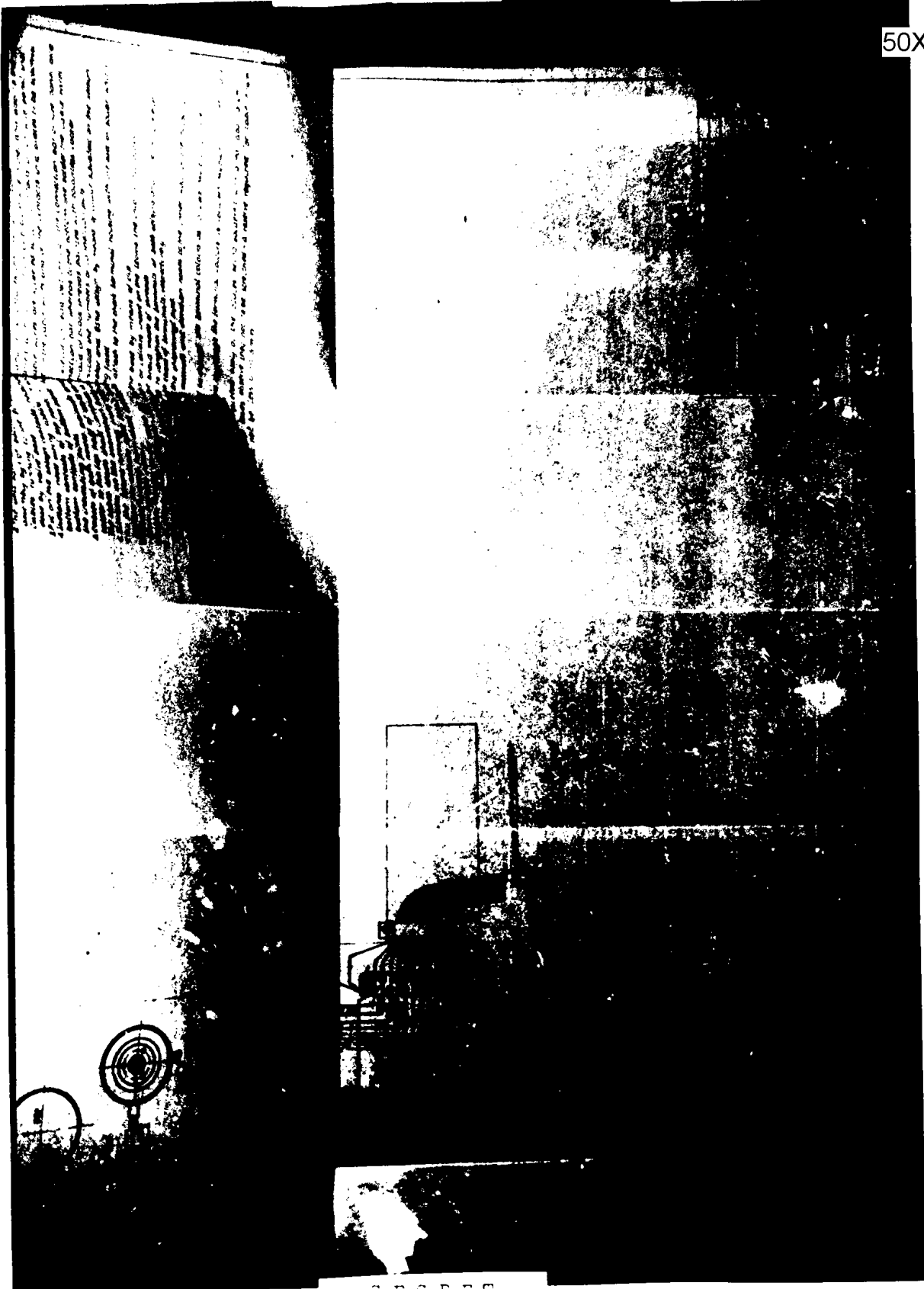

S-E-C-R-E-T

NO FOREIGN DISSEM

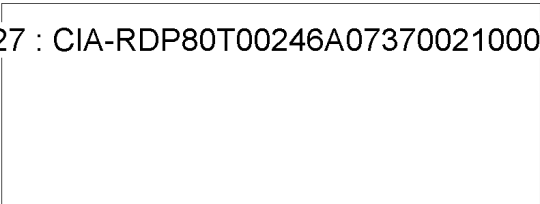

50X1

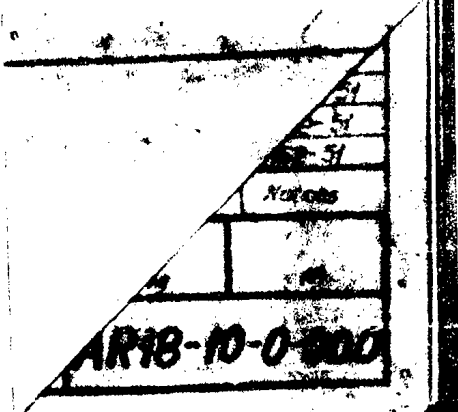

50X1

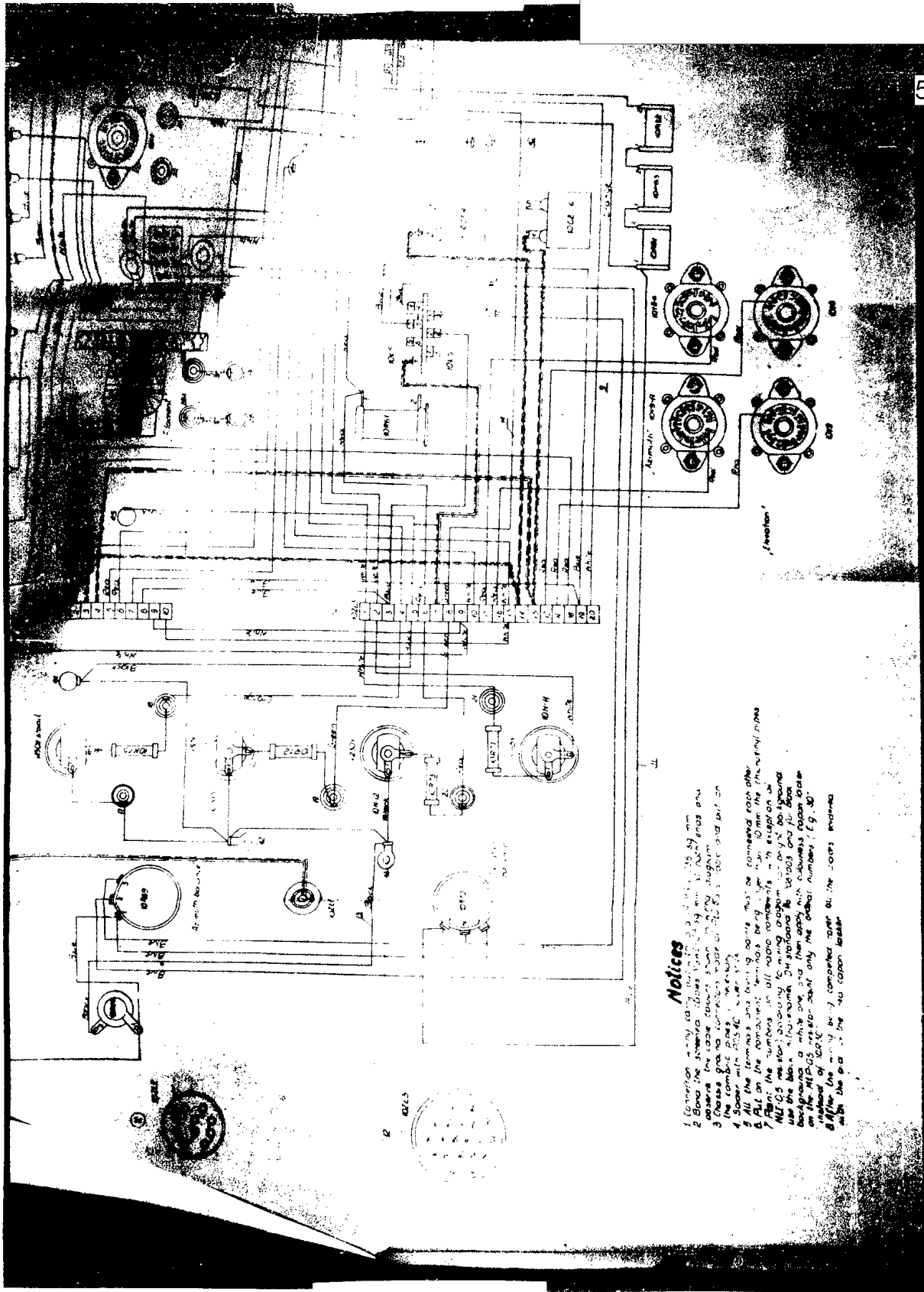

Notices

- 1 Connection points are marked with numbers 1 through 10.
- 2 Bend the wires at angles from 30 to 45 degrees and observe the lead labels shown in every diagram.
- 3 These are no longer used in any diagram.
- 4 The combic plug is obsolete.
- 5 All the terminals and their wires must be removed each other.
- 6 Put on the numbers in all radio components with exception in ALL Q's the start of every wiring diagram. In any background use the block numbers, the standard is 10000 and 70000 background a white one and the other with colored paper data instead of 10000 start only the other numbers, e.g. 10000.
- 7 After the wiring is completed refer to the color markings with the 10000 color paper.

SECRET
NO FOREIGN DISSEM

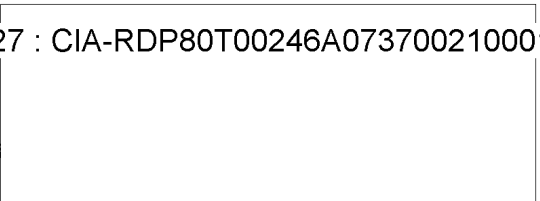

50X1

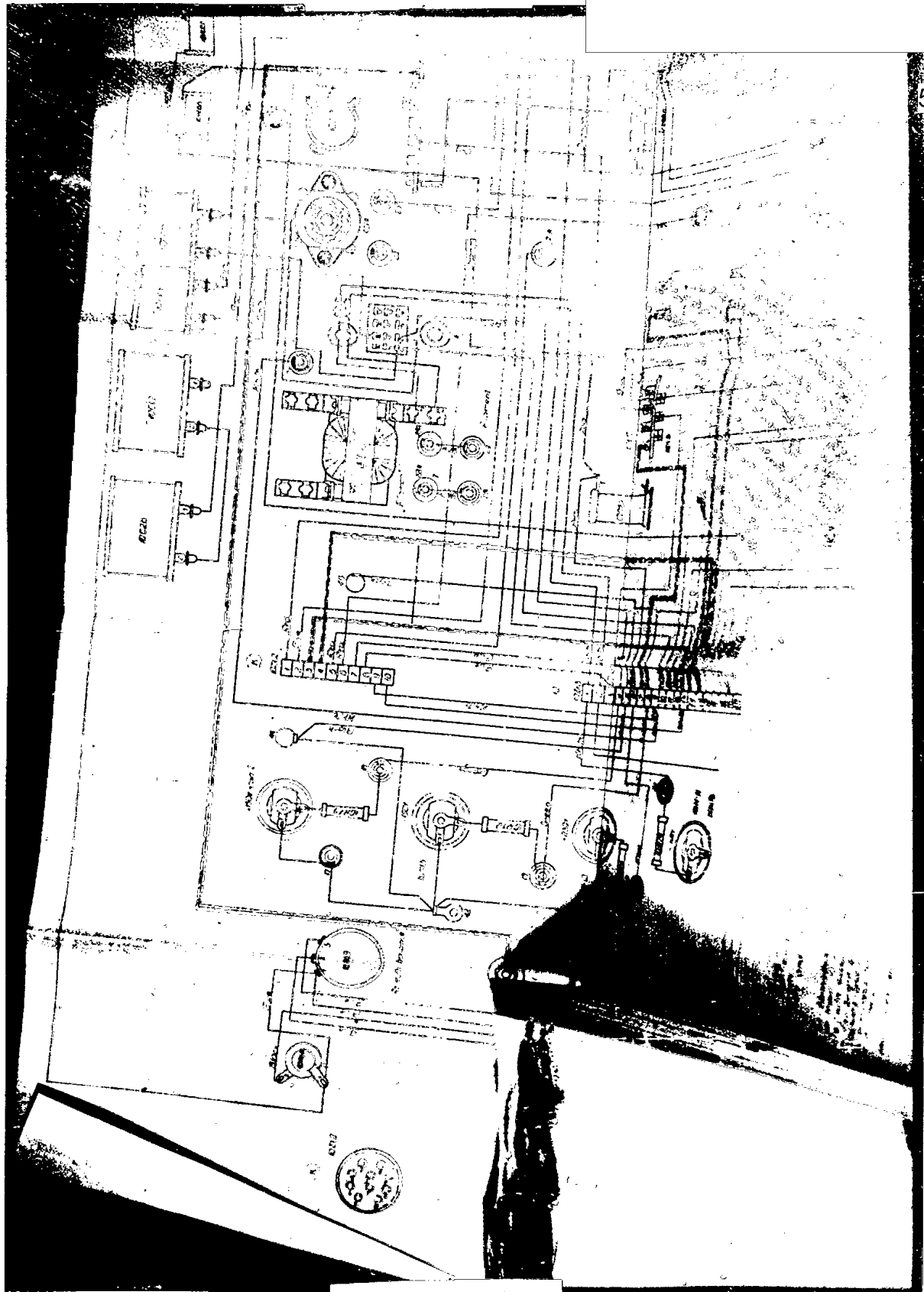

S-E-C-R-E-T

NO FOREIGN DISSEM

S-E-C-R-E-T
NO FOREIGN DISSEM

50X1

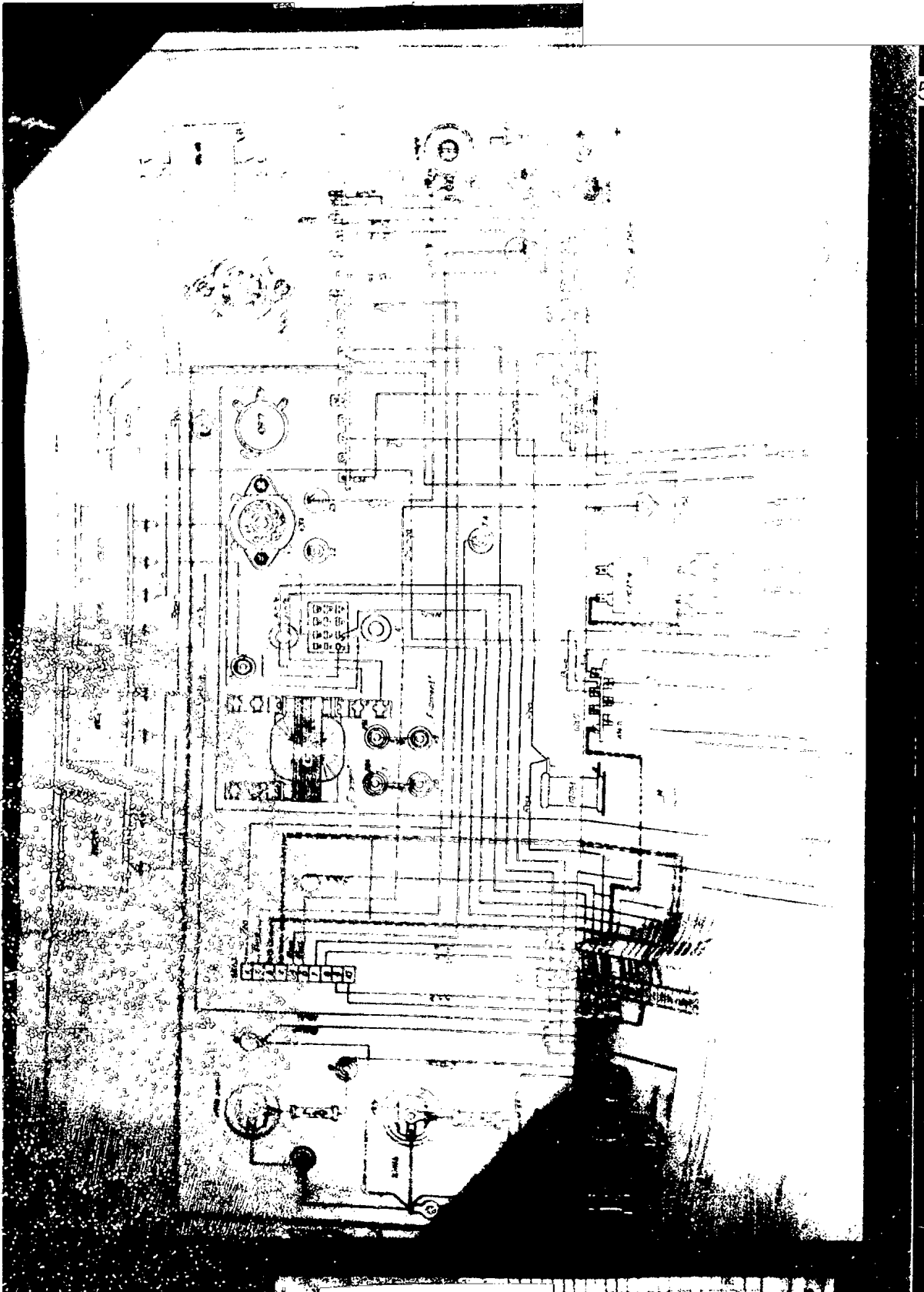

S-E-C-R-E-T

NO FOREIGN DISSEM

S-E-C-R-E-T
NO FOREIGN DISSEM

50X1

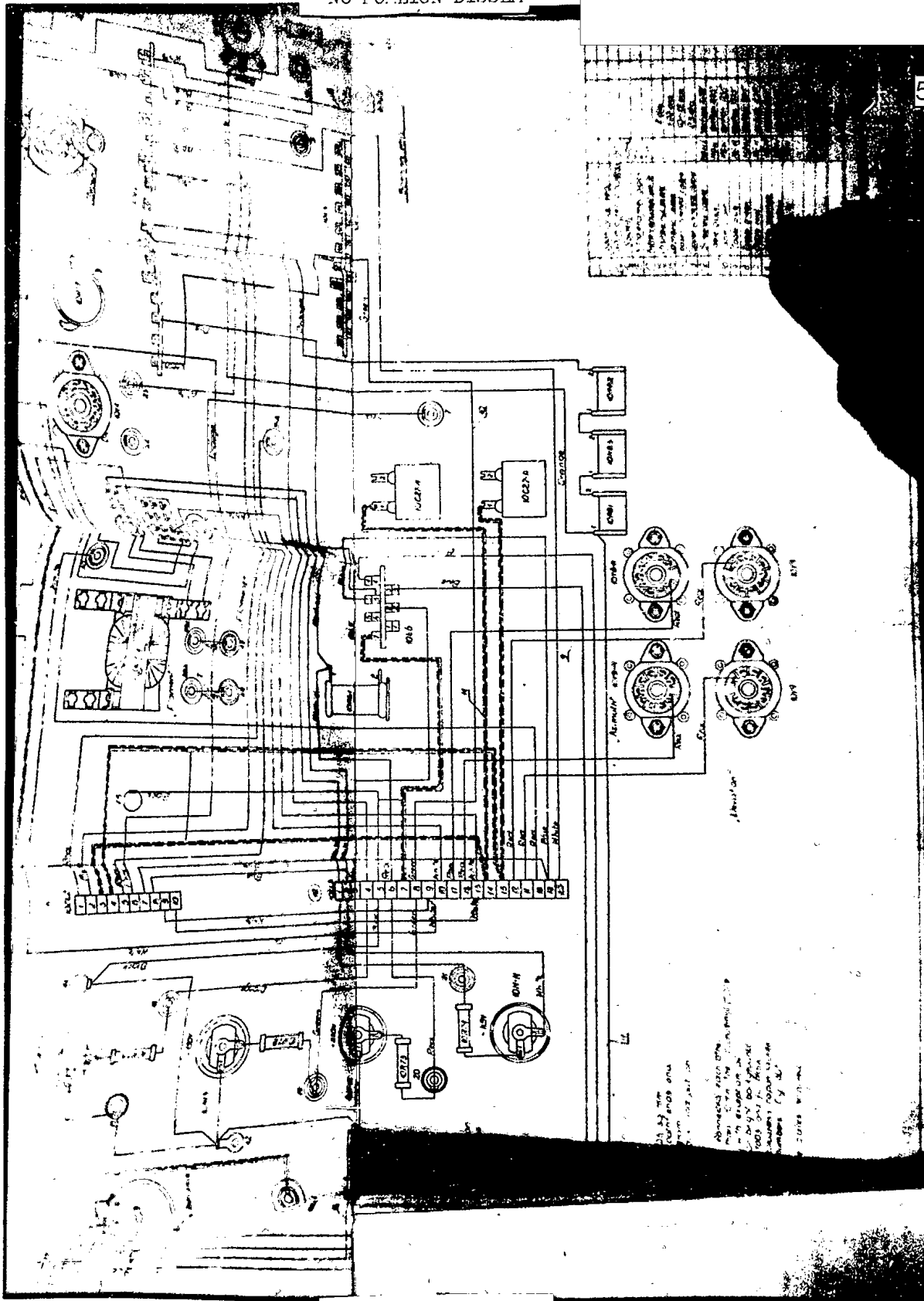

S-E-C-R-E-T

NO FOREIGN DISSEM

S-E-C-R-E-T
NO FOREIGN DISSEM

50X1

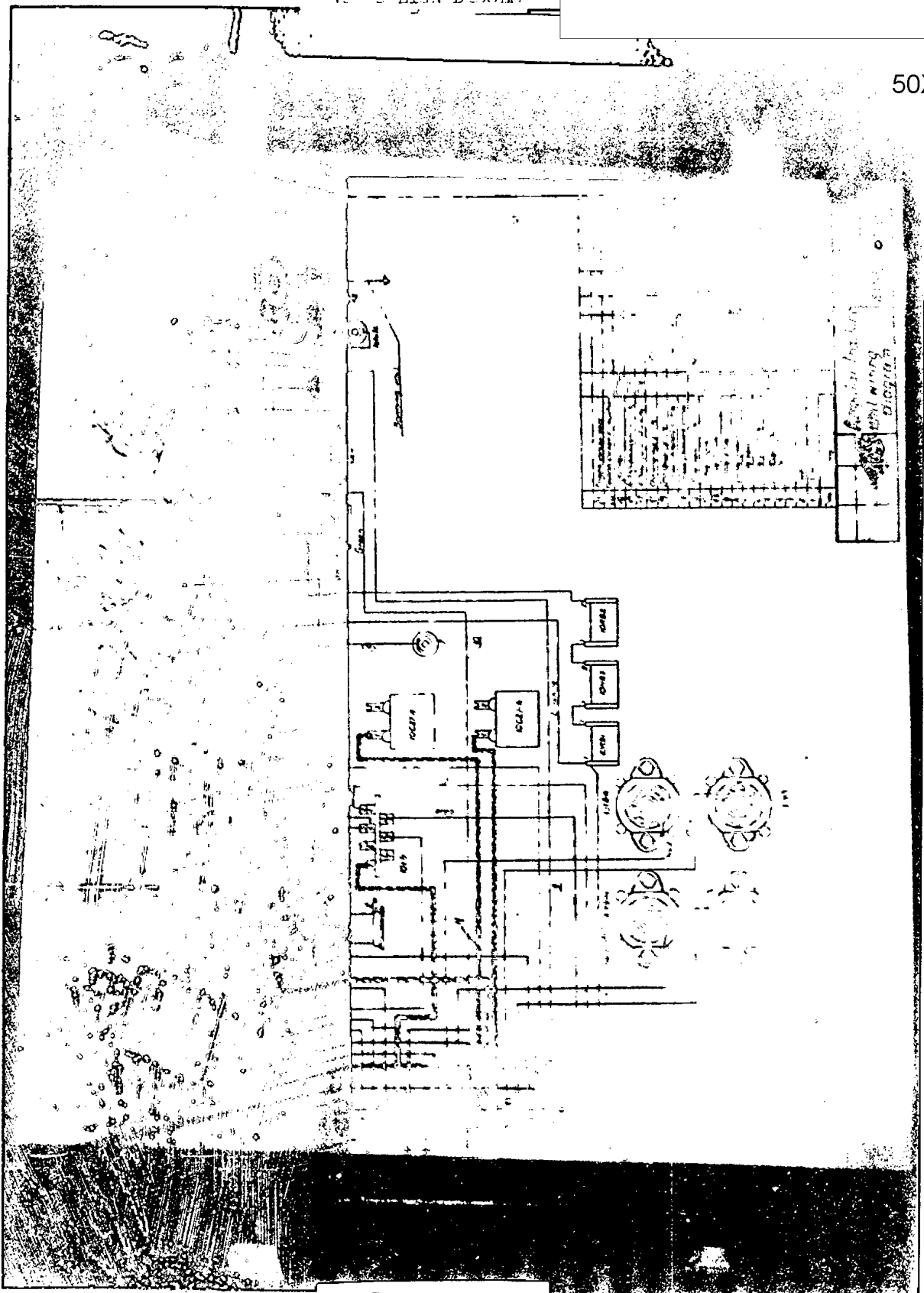

S-E-C-R-E-T

NO FOREIGN DISSEM

S-E-C-R-E-T
NO FOREIGN DISSEM

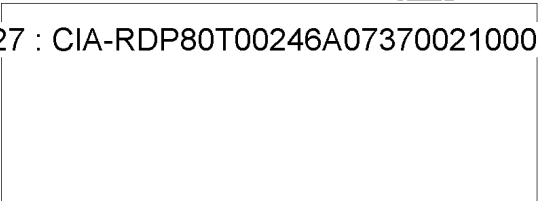

50X1

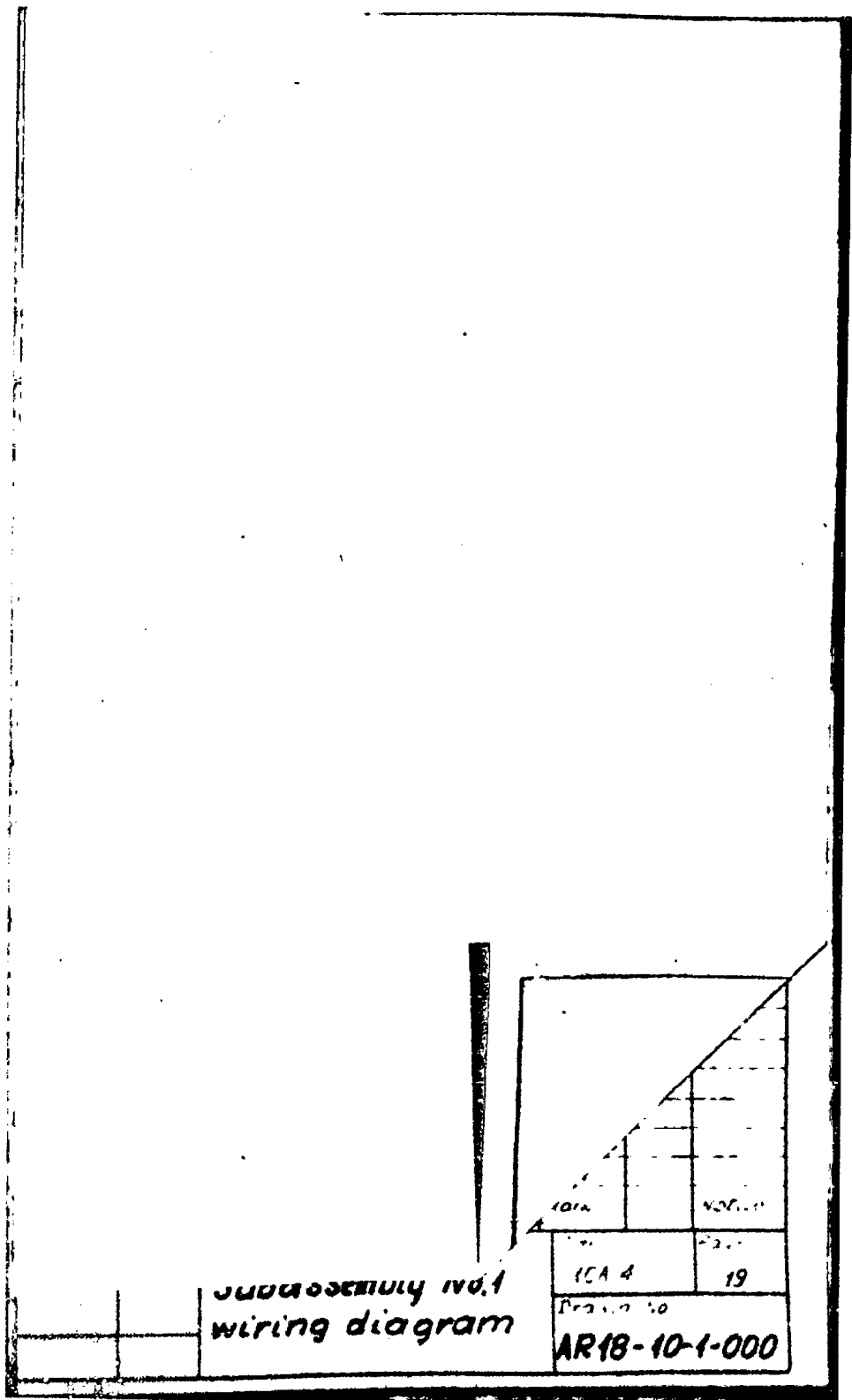

S-E-C-R-E-T

NO FOREIGN DISSEM

S-E-C-R-E-T
NO FOREIGN DISSEM

50X1

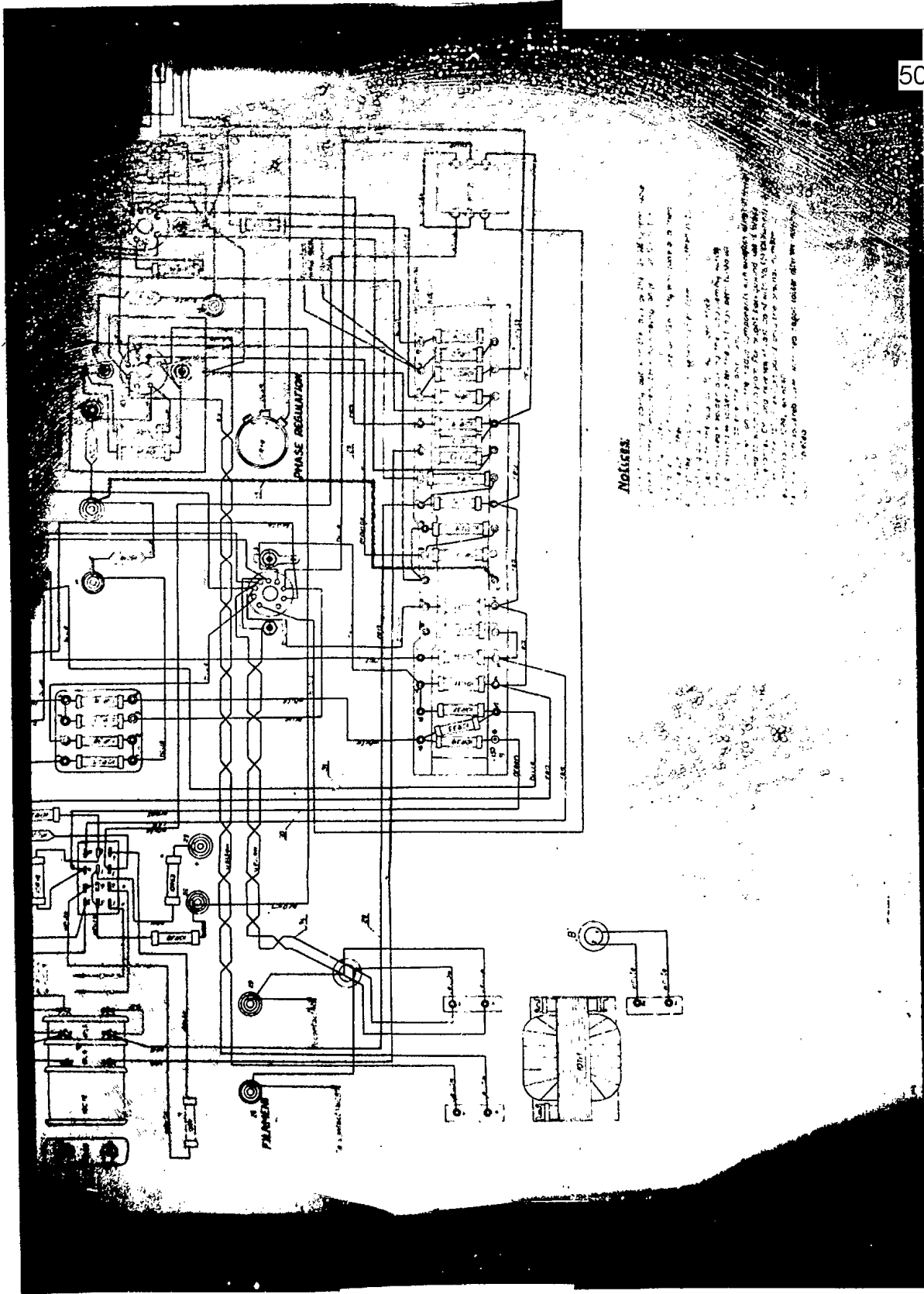

S-E-C-R-E-T
NO FOREIGN DISSEM

S-E-C-R-E-T
NO FOREIGN DISSEM

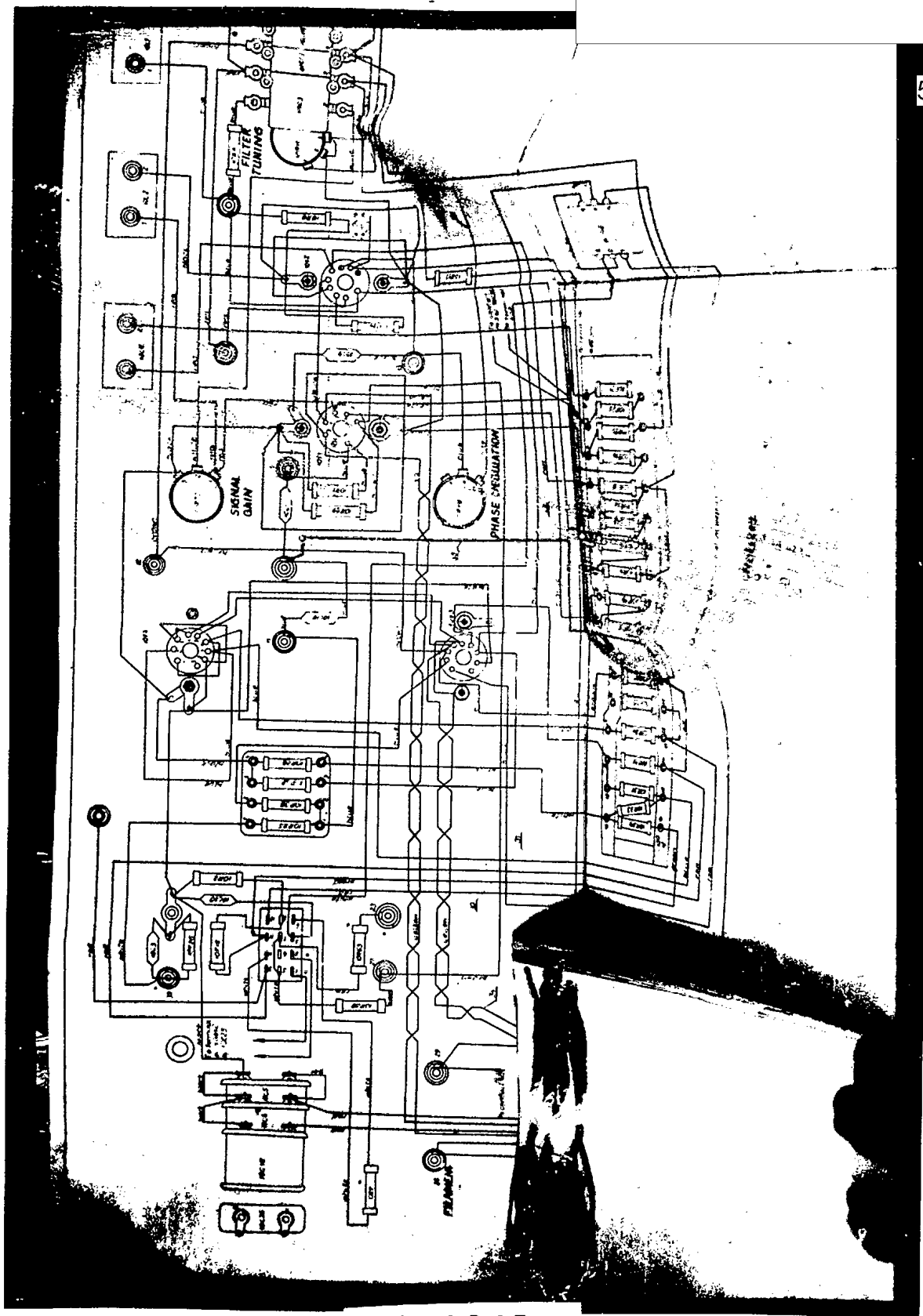

50X1

S-E-C-R-E-T

NO FOREIGN DISSEM

S-E-C-R-E-T
NO FOREIGN DISSEM

50X1

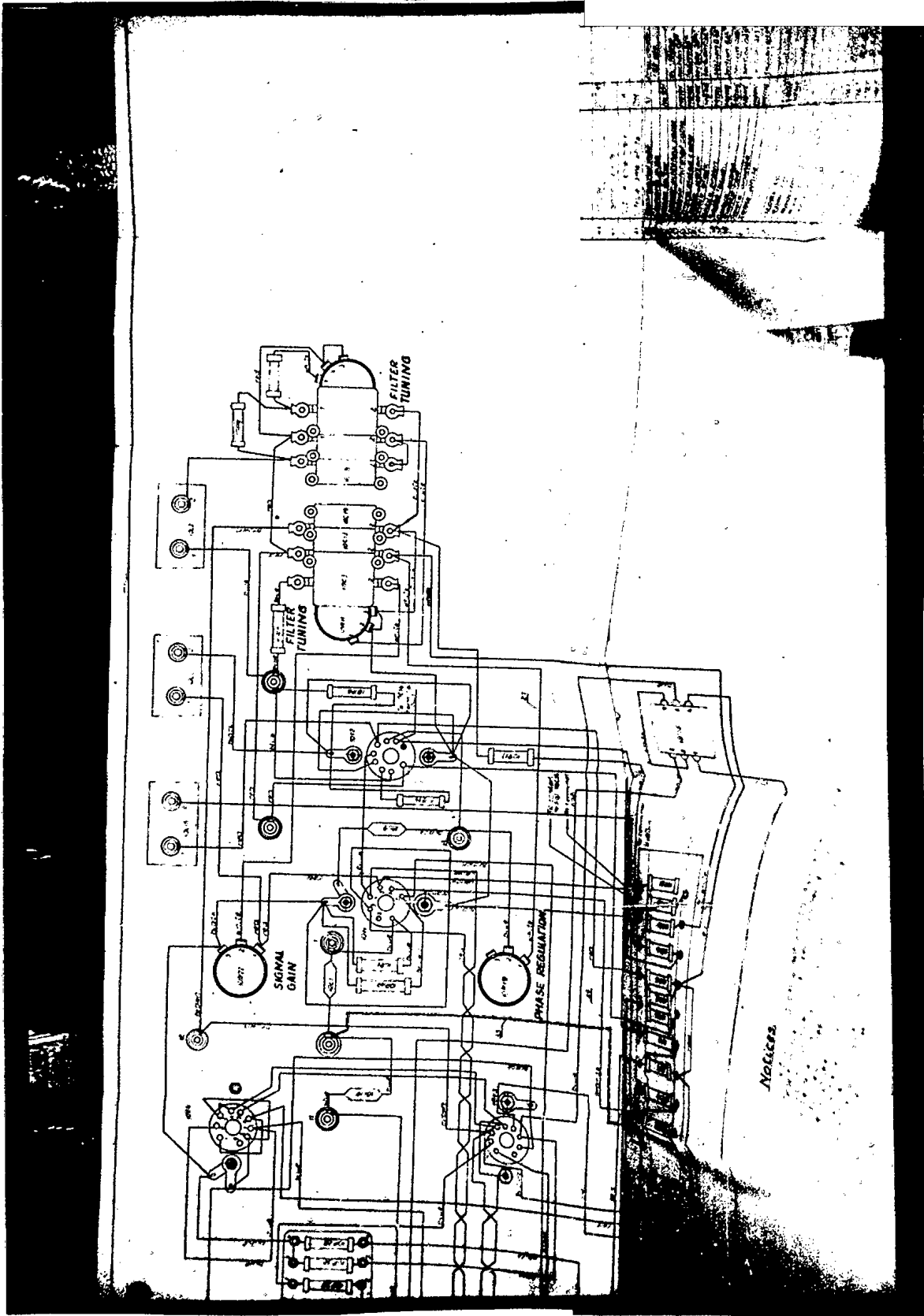

S-E-C-R-E-T

NO FOREIGN DISSEM

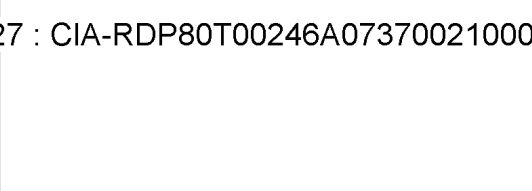

NO FOREIGN DISSEM

50X1

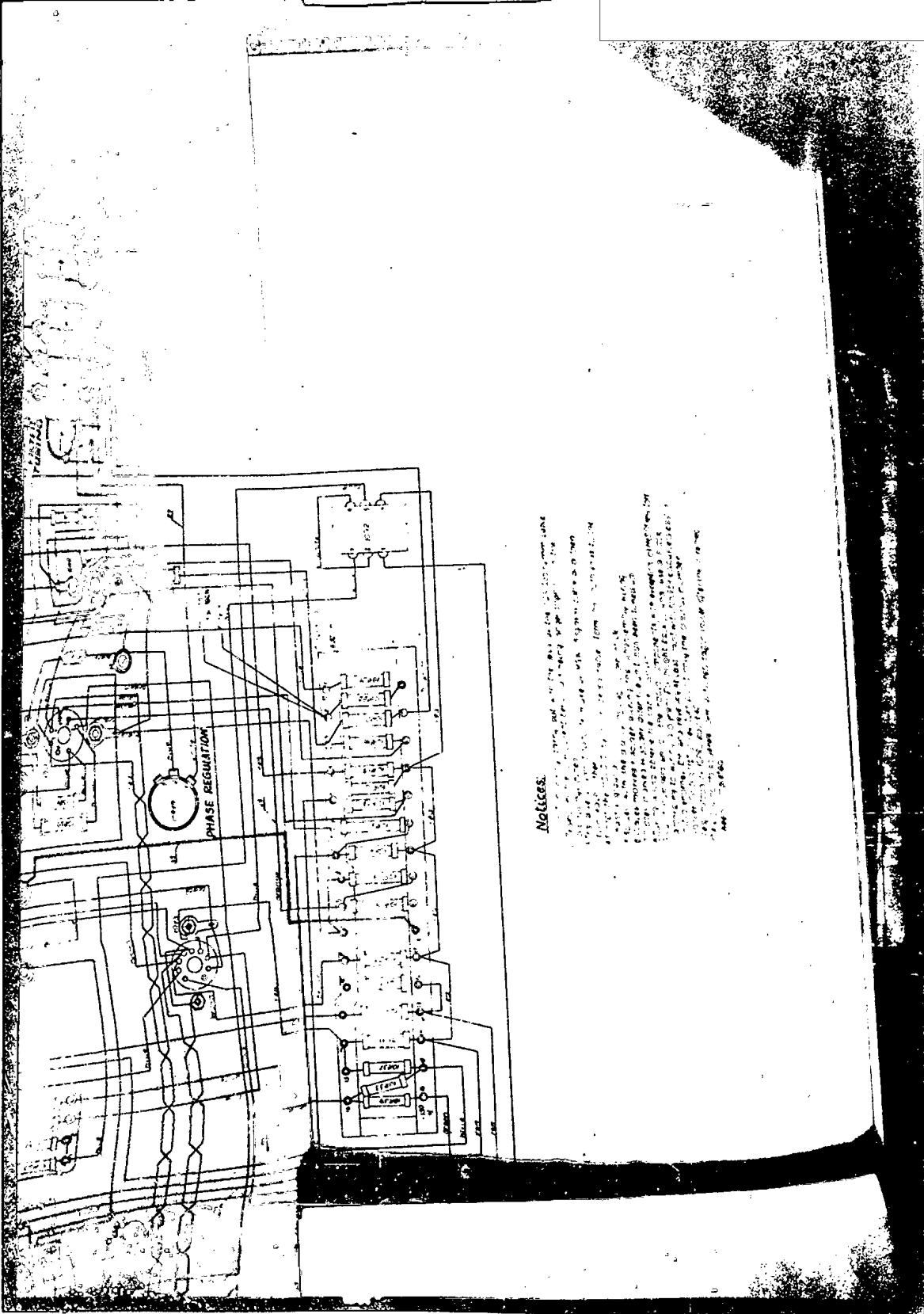

Notices:

1. This drawing is a schematic diagram of the electrical control system for the phase regulator. It is intended for use as a reference only and should not be used for construction purposes.

2. The components shown in this drawing are subject to change without notice. The user should refer to the latest revision of this drawing for the most current information.

3. The user should refer to the component data sheets for the components shown in this drawing for the most current information.

4. The user should refer to the wiring diagram for the phase regulator for the most current information.

5. The user should refer to the phase regulator manual for the most current information.

S-E-C-R-E-T

NO FOREIGN DISSEM

S-E-C-R-E-T
NO FOREIGN DISSEM



50X1

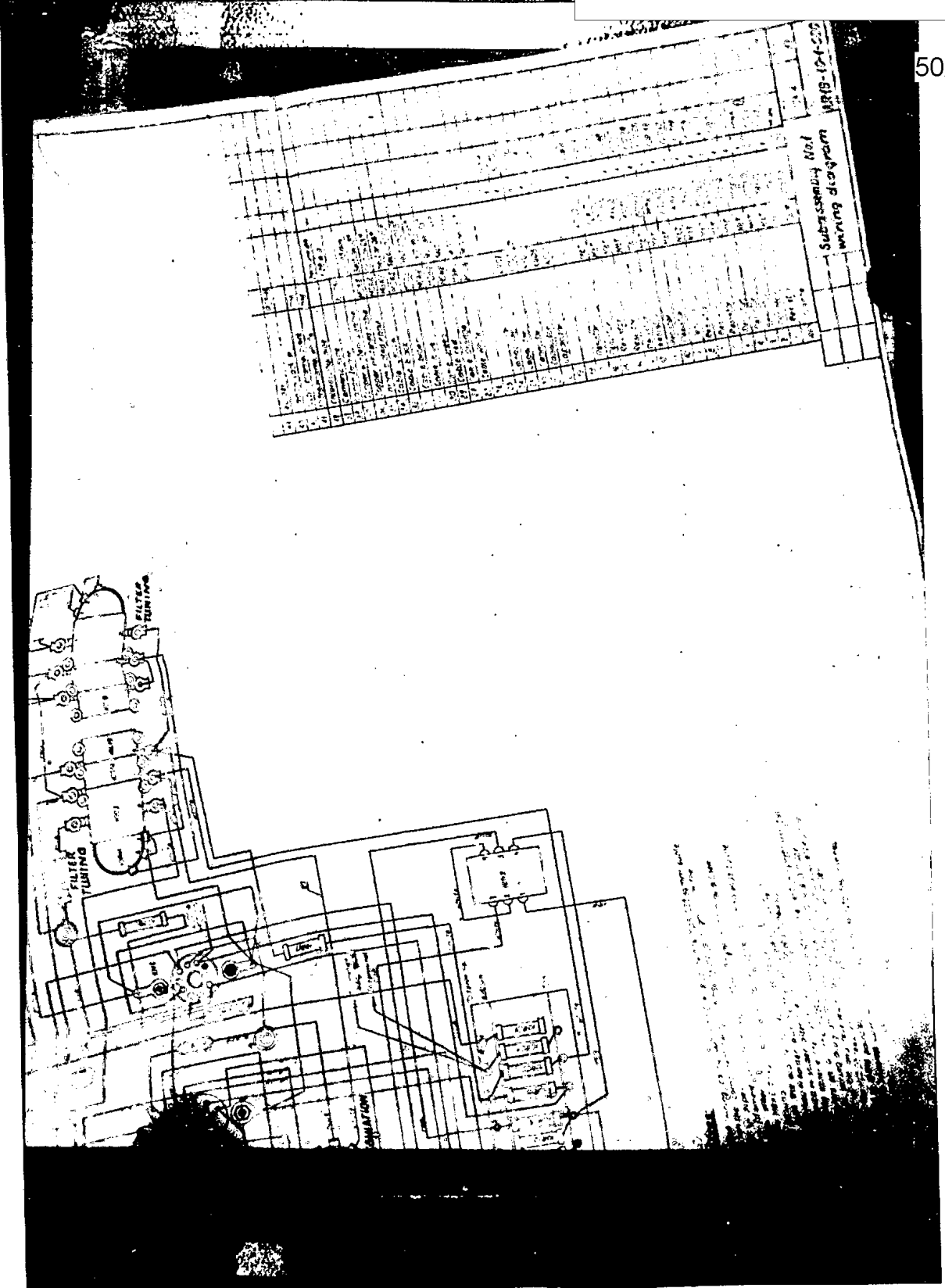

S-E-C-R-E-T

NO FOREIGN DISSEM

S-E-C-R-E-T
NO FOREIGN DISSEM

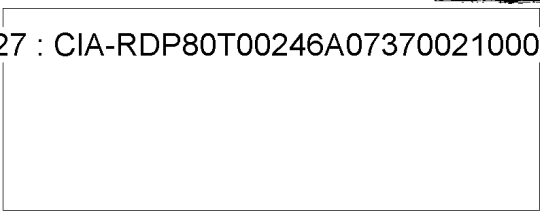

50X1

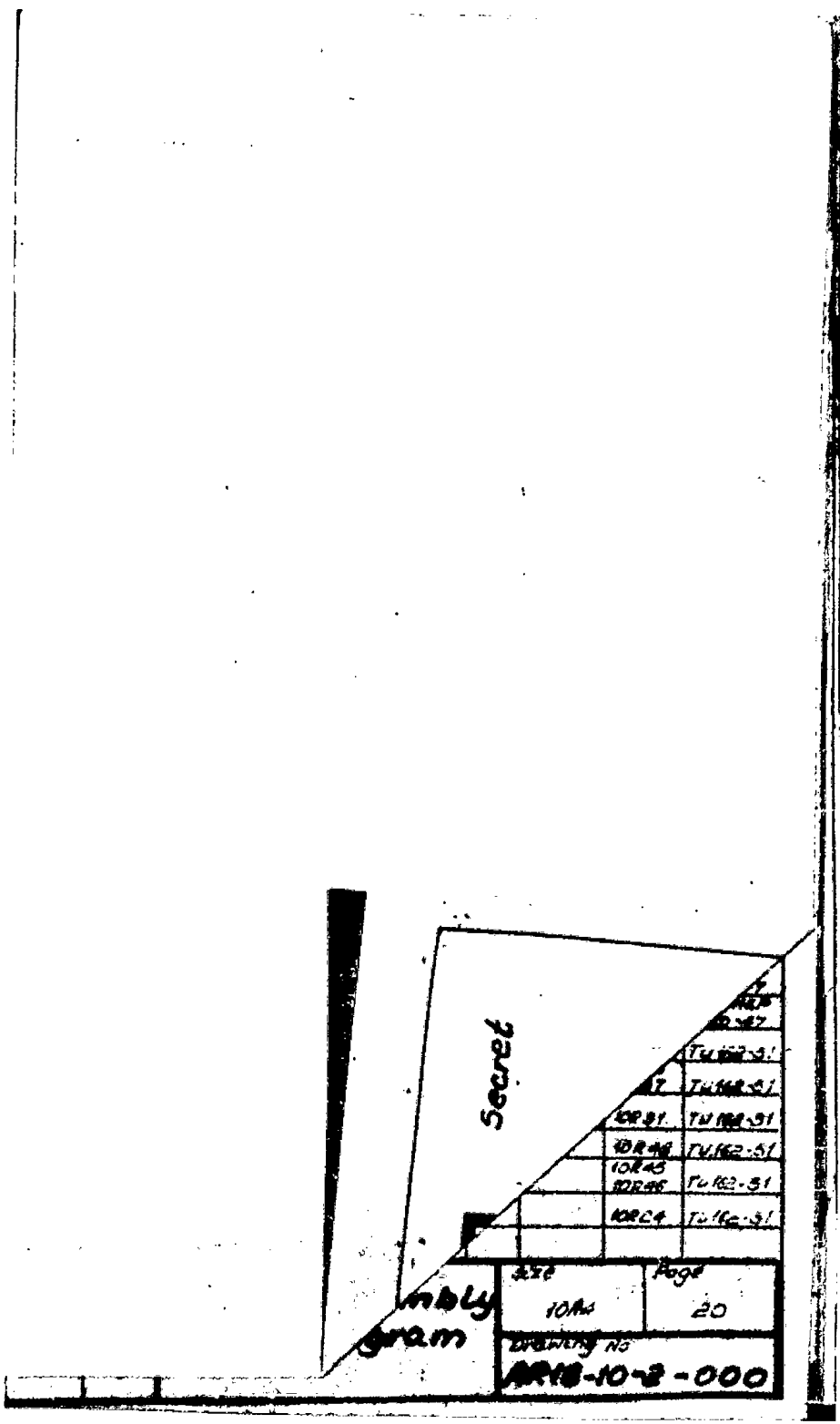

S-E-C-R-E-T

NO FOREIGN DISSEM

S-E-C-R-E-T
NO FOREIGN DISSEM

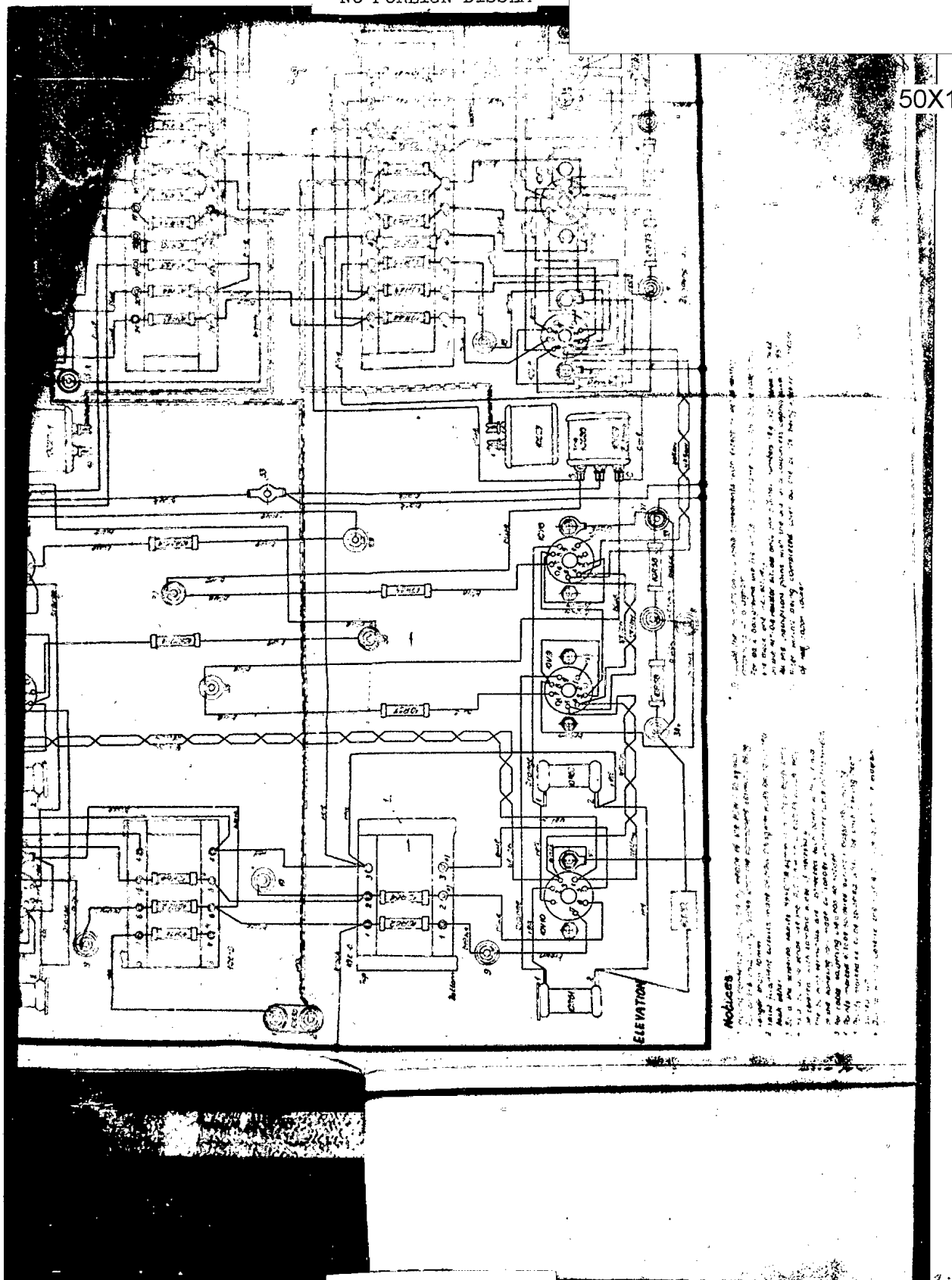

S-E-C-R-E-T
NO FOREIGN DISSEM

S-E-C-R-E-T
NO FOREIGN DISSEM

50X1

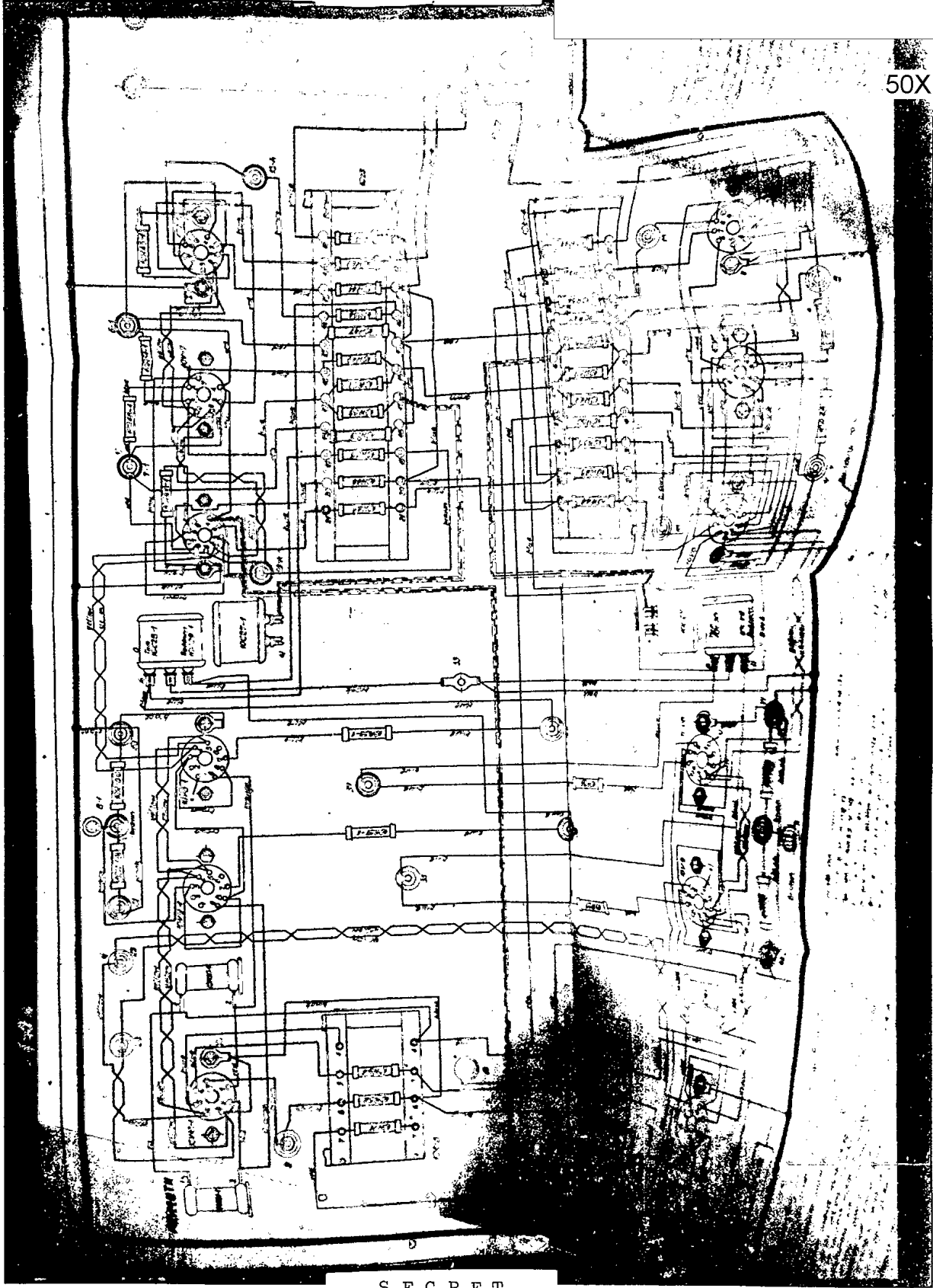

S-E-C-R-E-T
NO FOREIGN DISSEM

S-E-C-R-E-T
NO FOREIGN DISSEM

50X1

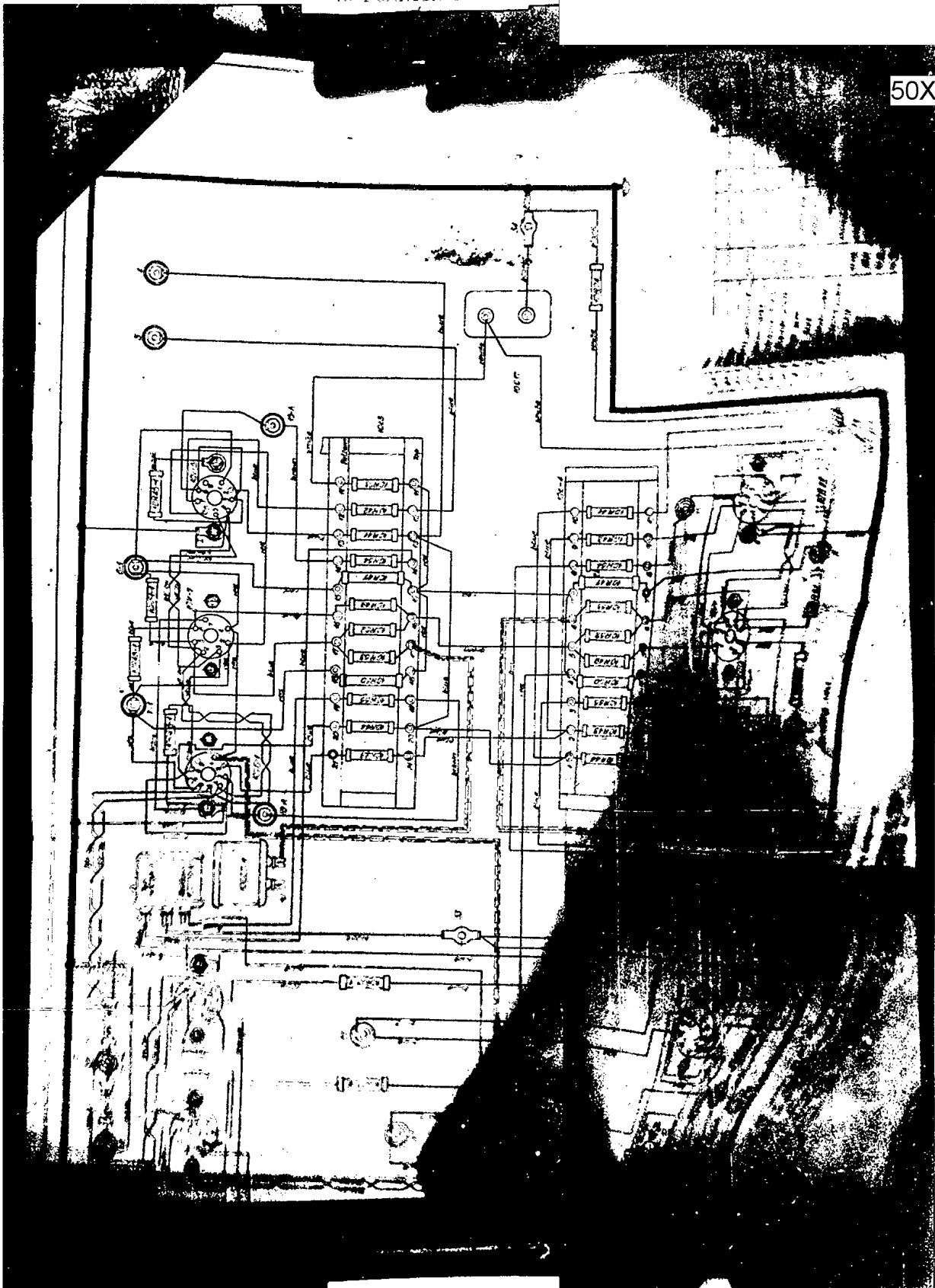

S-E-C-R-E-T

NO FOREIGN DISSEM

S-E-C-R-E-T
NO FOREIGN DISSEM

50X1

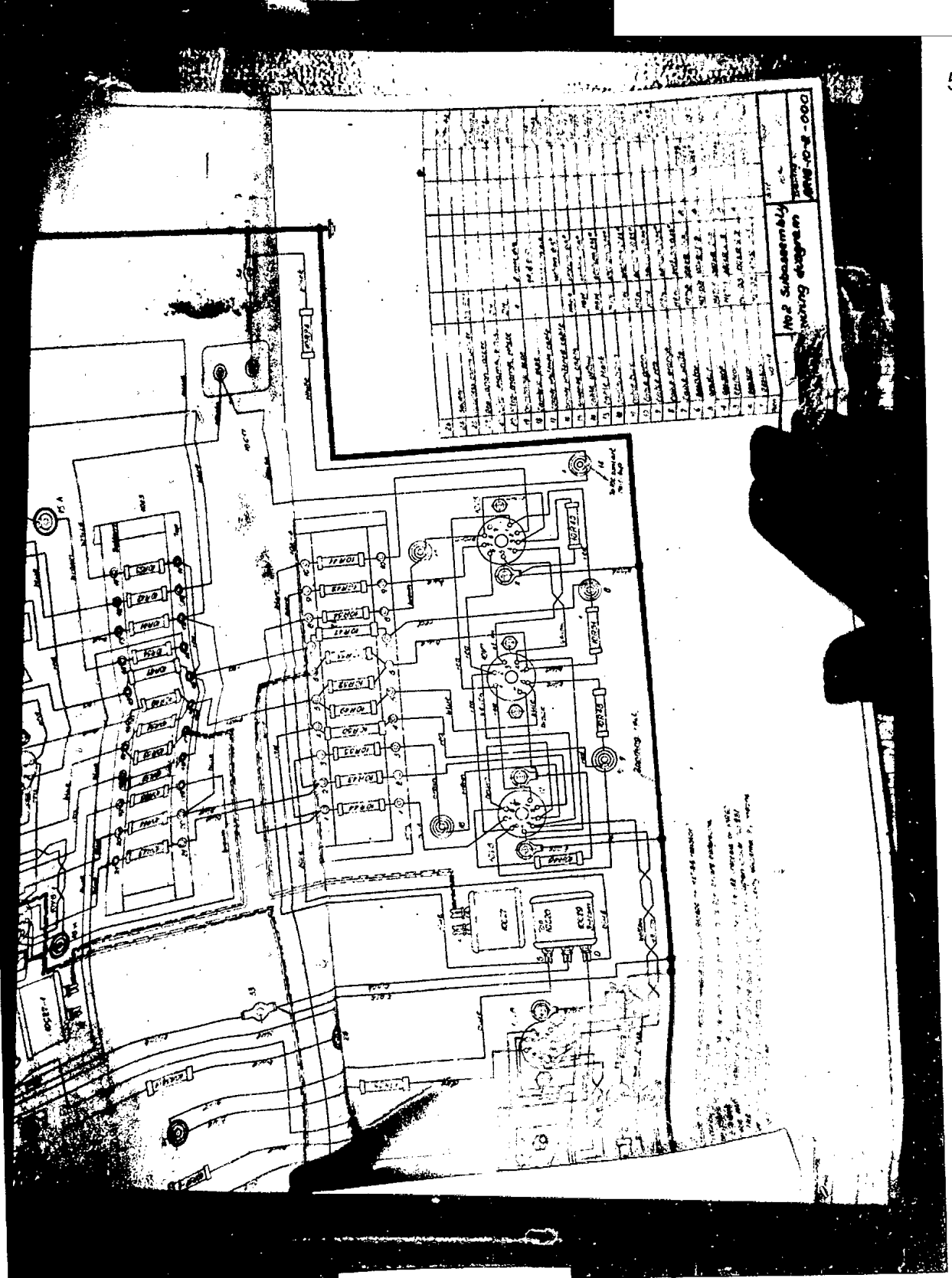

S-E-C-R-E-T

NO FOREIGN DISSEM

S-E-C-R-E-T
NO FOREIGN DISSEM

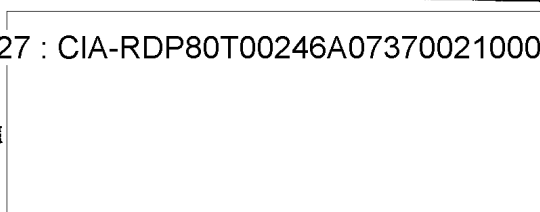

50X1

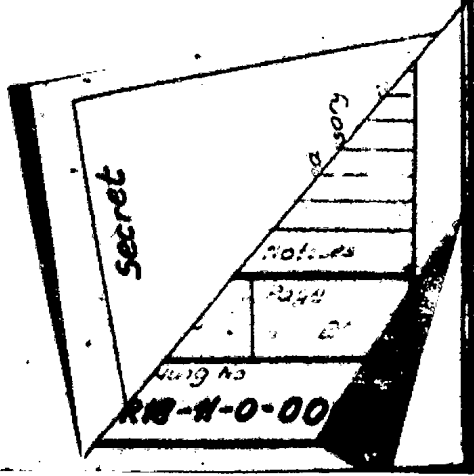

S-E-C-R-E-T
NO FOREIGN DISSEM

S-E-C-R-E-T
NO FOREIGN DISSEM

50X1

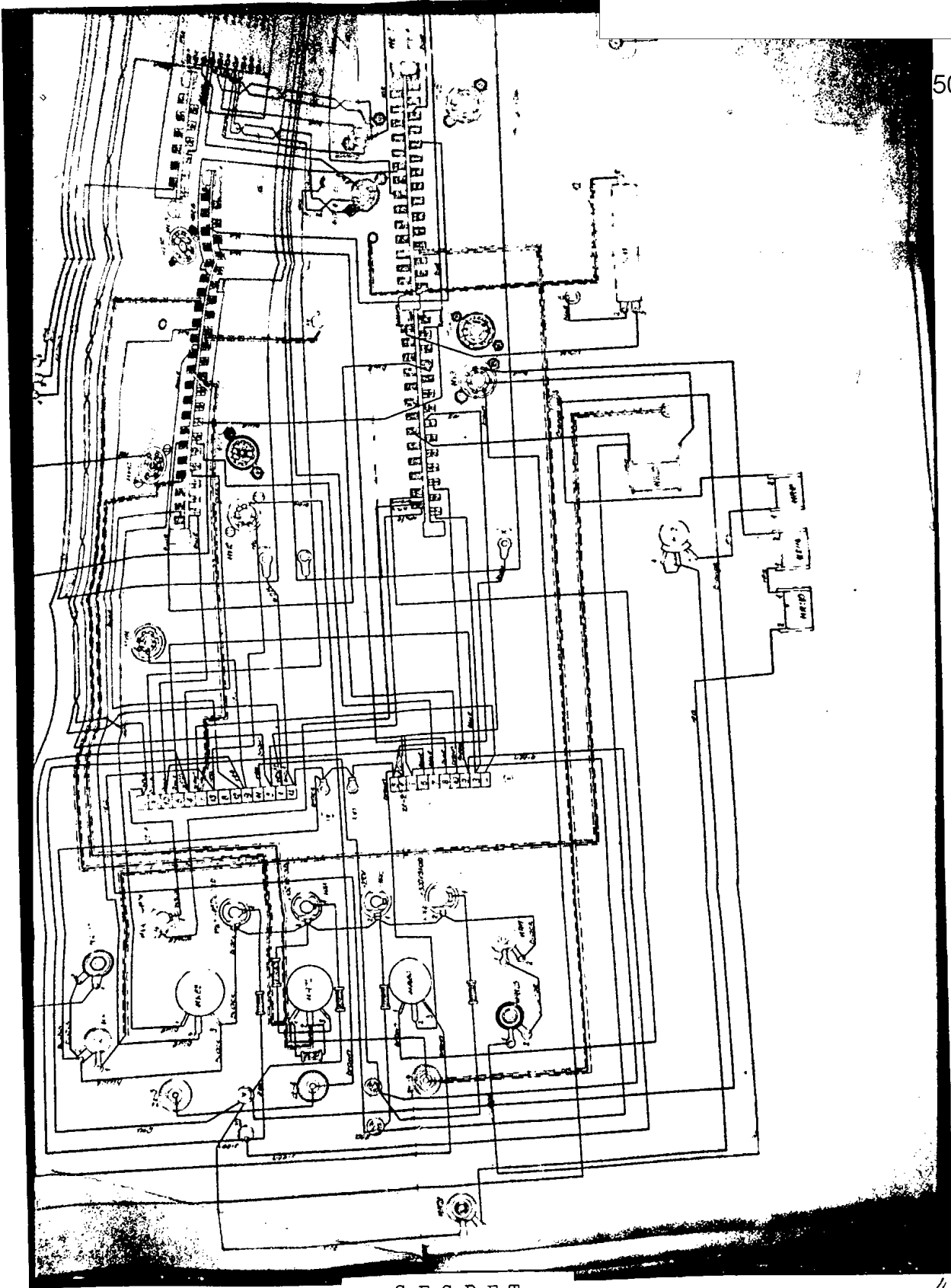

S-E-C-R-E-T
NO FOREIGN DISSEM

S-E-C-R-E-T
NO FOREIGN DISSEM

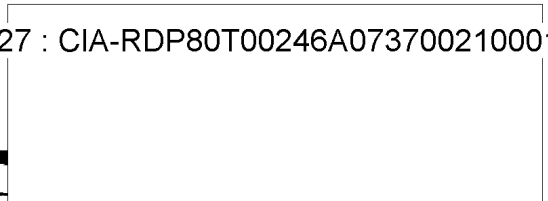

50X1

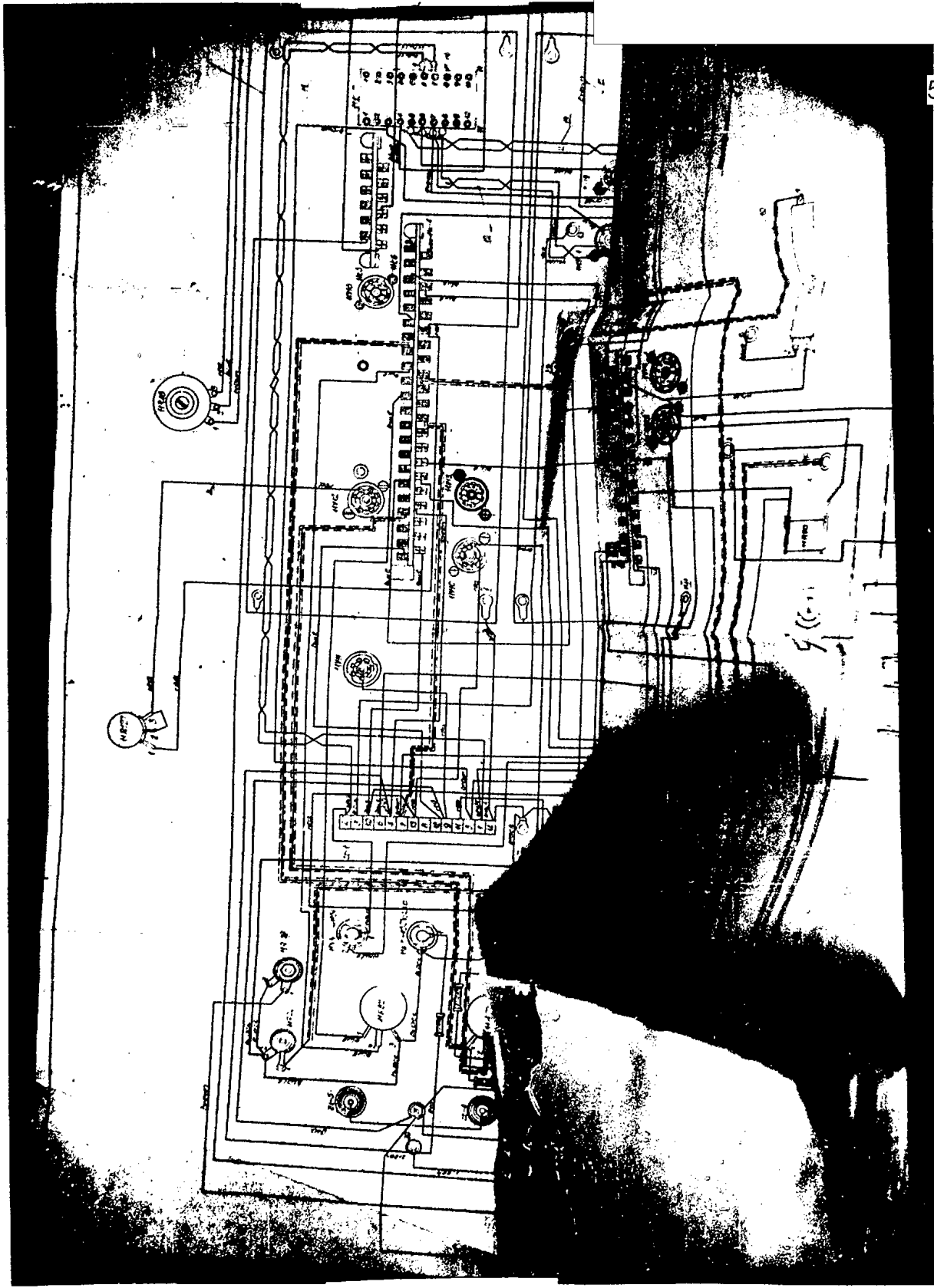

S-E-C-R-E-T
NO FOREIGN DISSEM

S-E-C-R-E-T
NO FOREIGN DISSEM

50X1

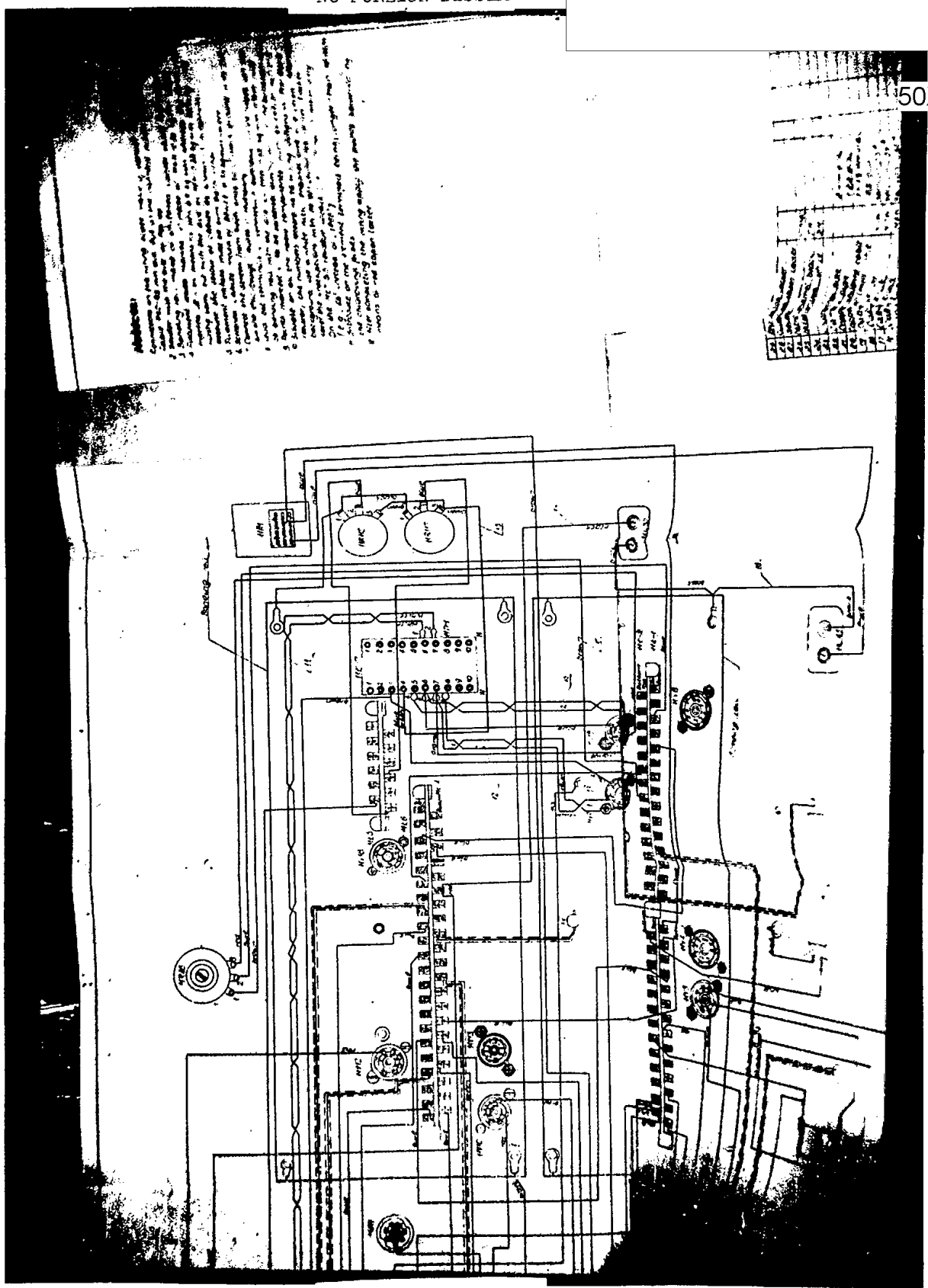

S-E-C-R-E-T

NO FOREIGN DISSEM

SECRET

50X1

Notices:

1. Connectors are not to be used unless they are specifically identified in the drawing.

2. Cable #10-10 must be used unless otherwise specified.

3. Shielding must be maintained throughout the entire length of the cable.

4. The shield must be grounded at both ends of the cable.

5. The shield must be grounded to the same ground as the equipment.

6. The shield must be grounded to the same ground as the equipment.

7. The shield must be grounded to the same ground as the equipment.

8. The shield must be grounded to the same ground as the equipment.

9. The shield must be grounded to the same ground as the equipment.

10. The shield must be grounded to the same ground as the equipment.

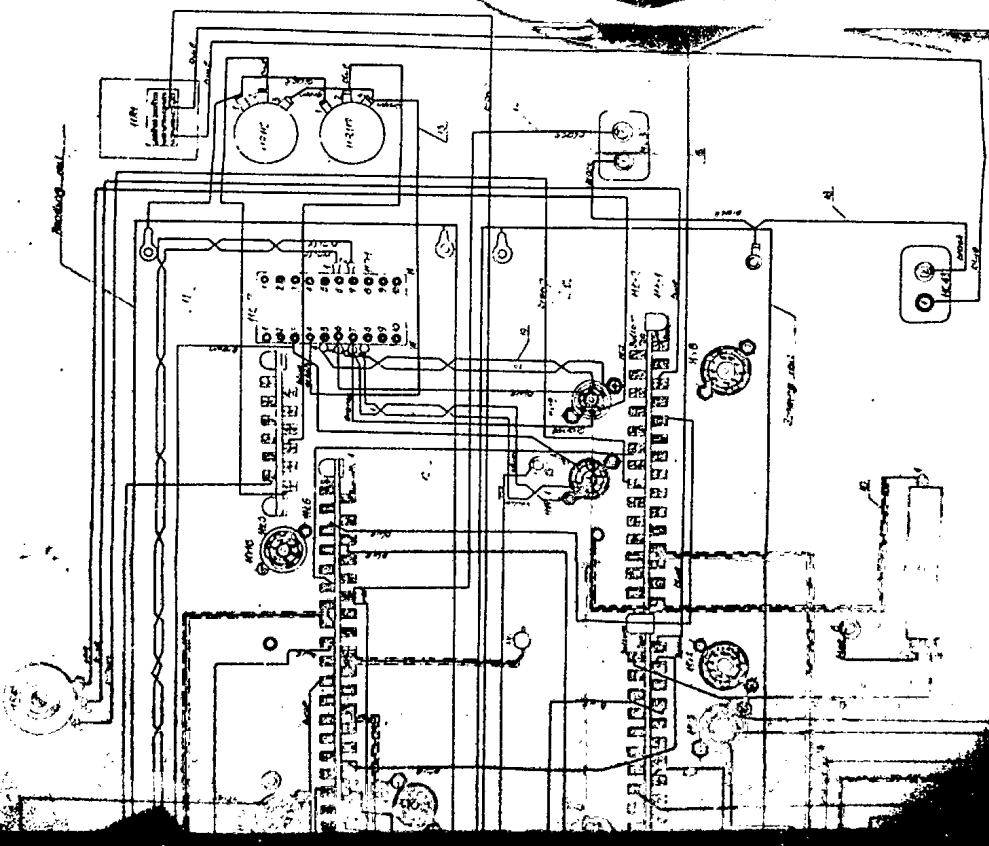

SECRET

NO FOREIGN DISSEM

S-E-C-R-E-T
NO FOREIGN DISSEM

50X1

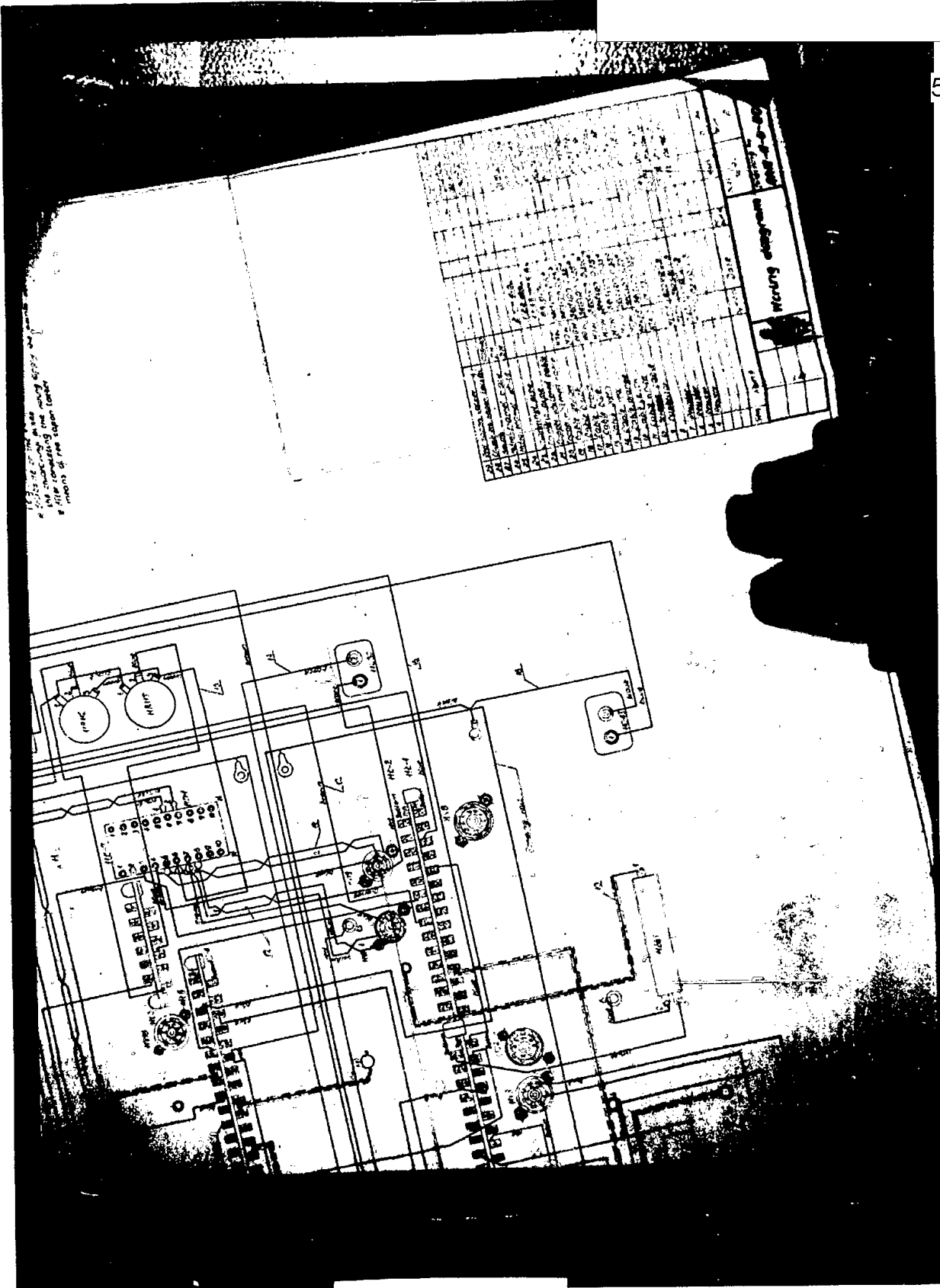

S-E-C-R-E-T
NO FOREIGN DISSEM

S-E-C-R-E-T
NO FOREIGN DISSEM



50X1

Secret

of copper whitened cable of 0.5 mm dia and
 m if necessary
 solder stick
 2 cab's of 1.5 mm dia
 0.95 sq mm cab's marked - 2 of 0.5 sq mm section
 the dia of MGN-0.55 sq mm lead observing the
 other
 0.5 sq mm lead
 terminals and also put on the chloro vinyl pipes if necessary
 bases to bonding rail make of MGN-0.55 sq mm
 wiring the subassembly wiring
 components (with exception of MEL-0.5 resistor) according
 and with white enamel and reversely, on this white
 colourless copon locker
 not number only (E.g. 28" instead of 11R28)
 but terminals being longer than 10 mm
 in red copon locker after the wiring being

Name	Number	Des. No.	Mark	Notes
Subassembly No. 1 Wiring diagram			Size EQW	Page 21
			Drawing No AR18-11-1-000	

175

S-E-C-R-E-T
NO FOREIGN DISSEM

S-E-C-R-E-T
NO FOREIGN DISSEM

50X1

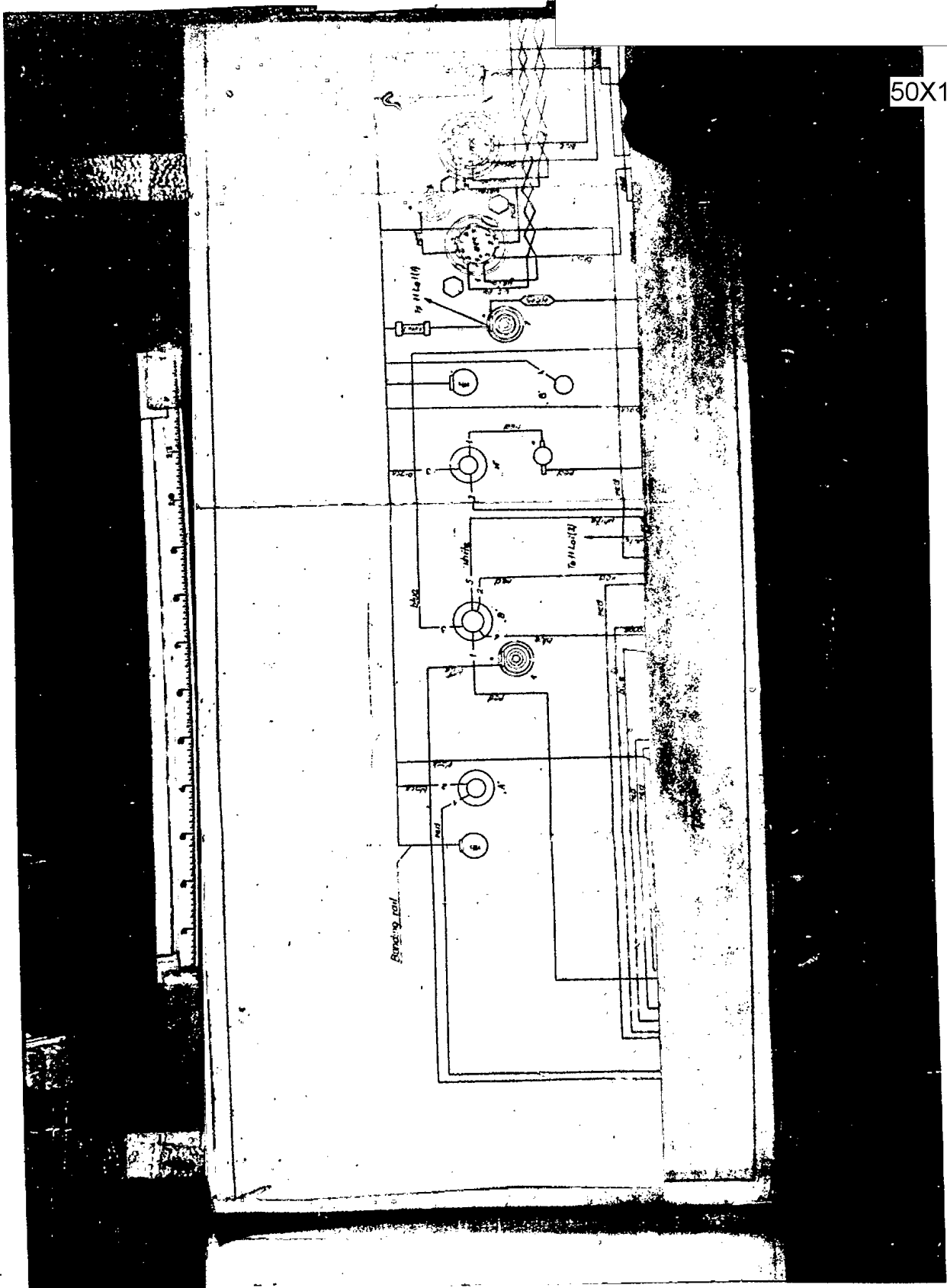

S-E-C-R-E-T
NO FOREIGN DISSEM

S-E-C-R-E-T
NO FOREIGN DISSEM

50X1

Notices:

(Continued)
1. The following information is classified "Secret" because it is information the disclosure of which is so vital to the national defense that its unauthorized disclosure would result in the identification of sources of information and the disclosure of methods and techniques of intelligence gathering.

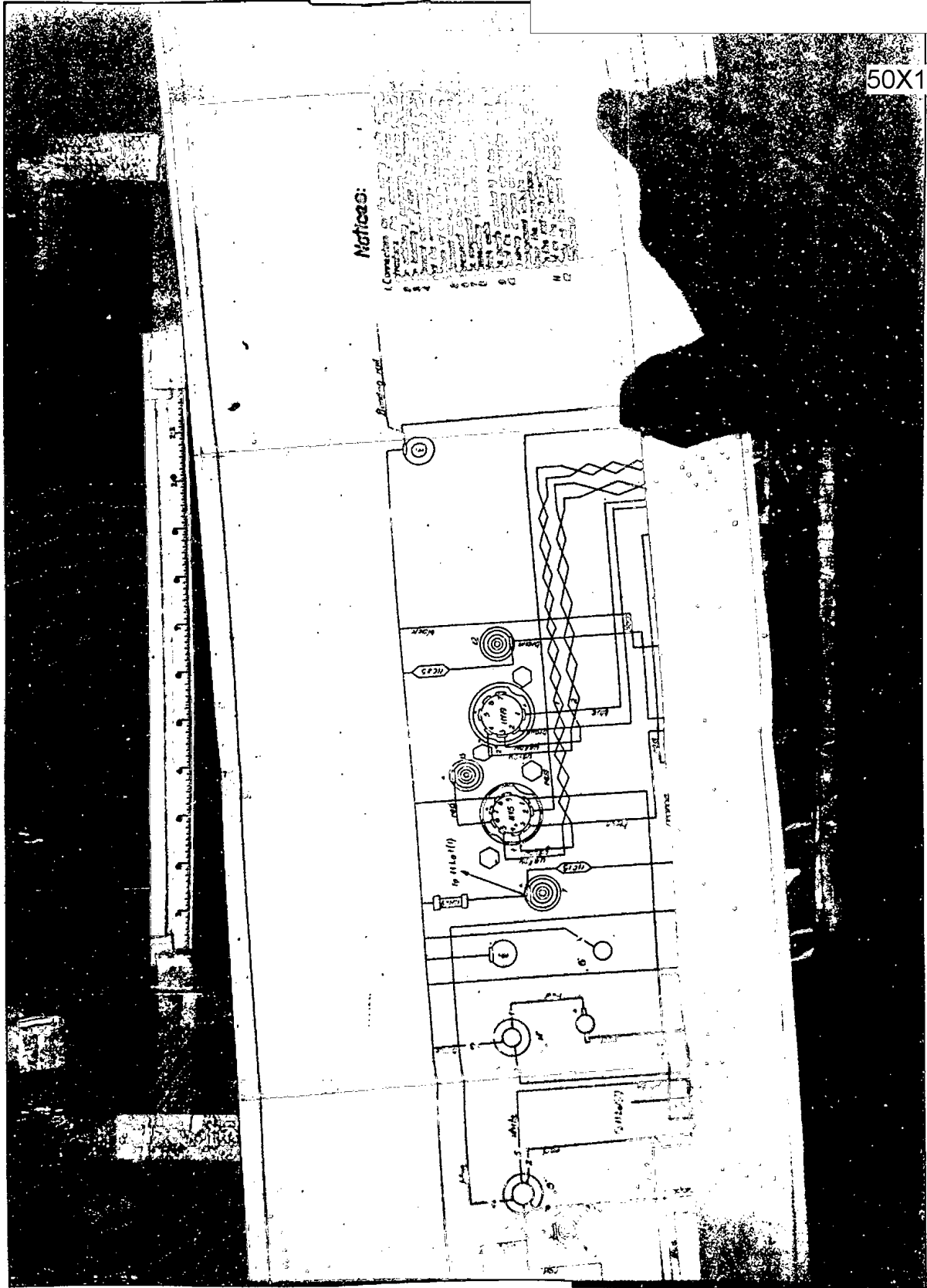

S-E-C-R-E-T

NO FOREIGN DISSEM

S-E-C-R-E-T
NO FOREIGN DISSE

50X1

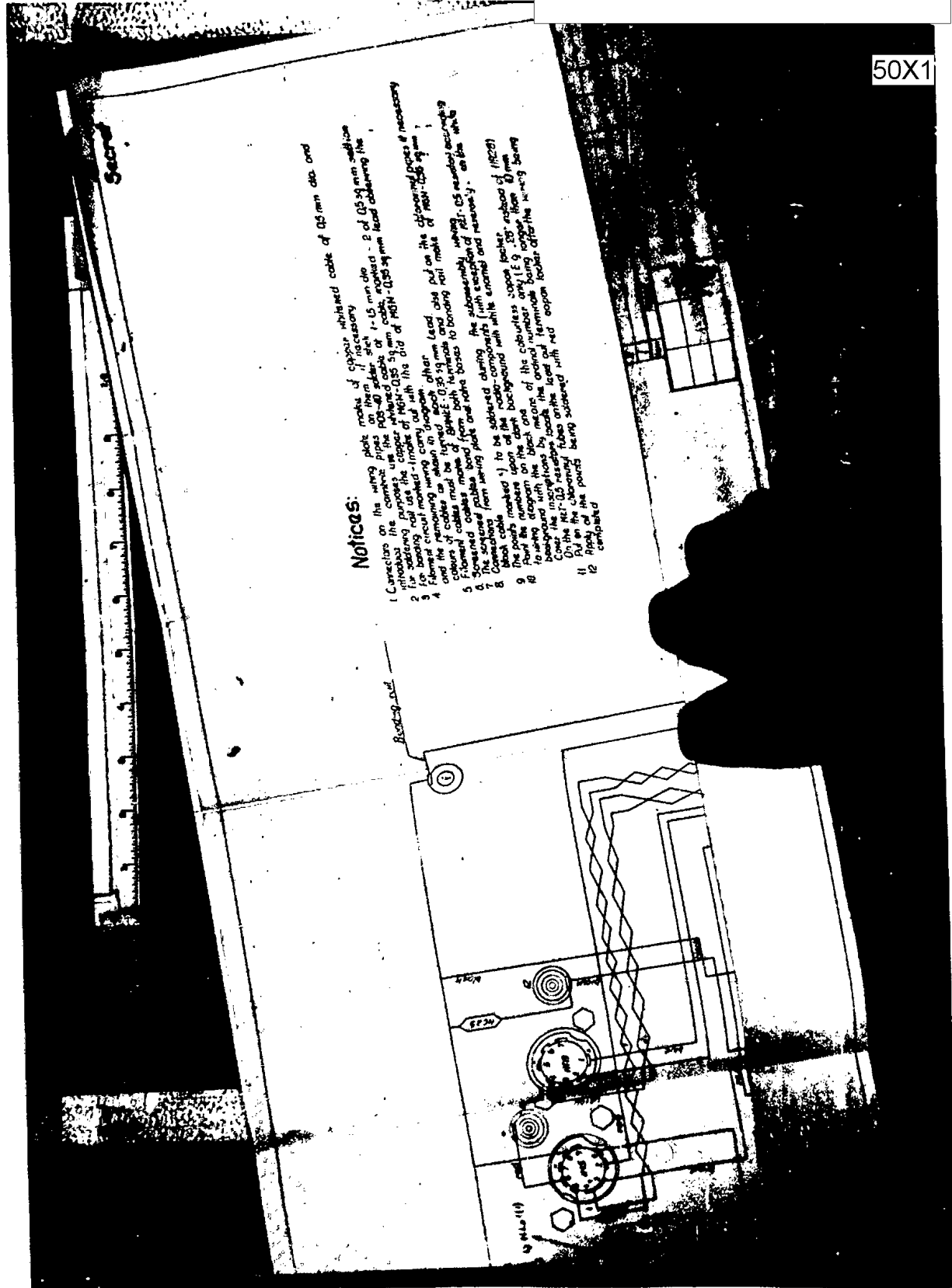

Notices:

- 1 Connections on the wiring plate on them marks of copper whitened cable of 0.5 mm dia. and
- 2 indicates the correct type of cable. The marks of copper whitened cable of 0.5 mm dia. and
- 3 for bonding are the marks of copper whitened cable of 0.5 mm dia. and
- 4 and the correct type of cable. The marks of copper whitened cable of 0.5 mm dia. and
- 5 Filament remaining wiring carry out from the marks of copper whitened cable of 0.5 mm dia. and
- 6 Filament of cables must be typed with the marks of copper whitened cable of 0.5 mm dia. and
- 7 The correct type of cable. The marks of copper whitened cable of 0.5 mm dia. and
- 8 Connections on the wiring plate on them marks of copper whitened cable of 0.5 mm dia. and
- 9 The marks numbers on the marks of copper whitened cable of 0.5 mm dia. and
- 10 The marks numbers on the marks of copper whitened cable of 0.5 mm dia. and
- 11 On the marks numbers on the marks of copper whitened cable of 0.5 mm dia. and
- 12 completed

S-E-C-R-E-T

NO FOREIGN DISSEM

S-E-C-R-E-T
NO FOREIGN DISSEM

50X1

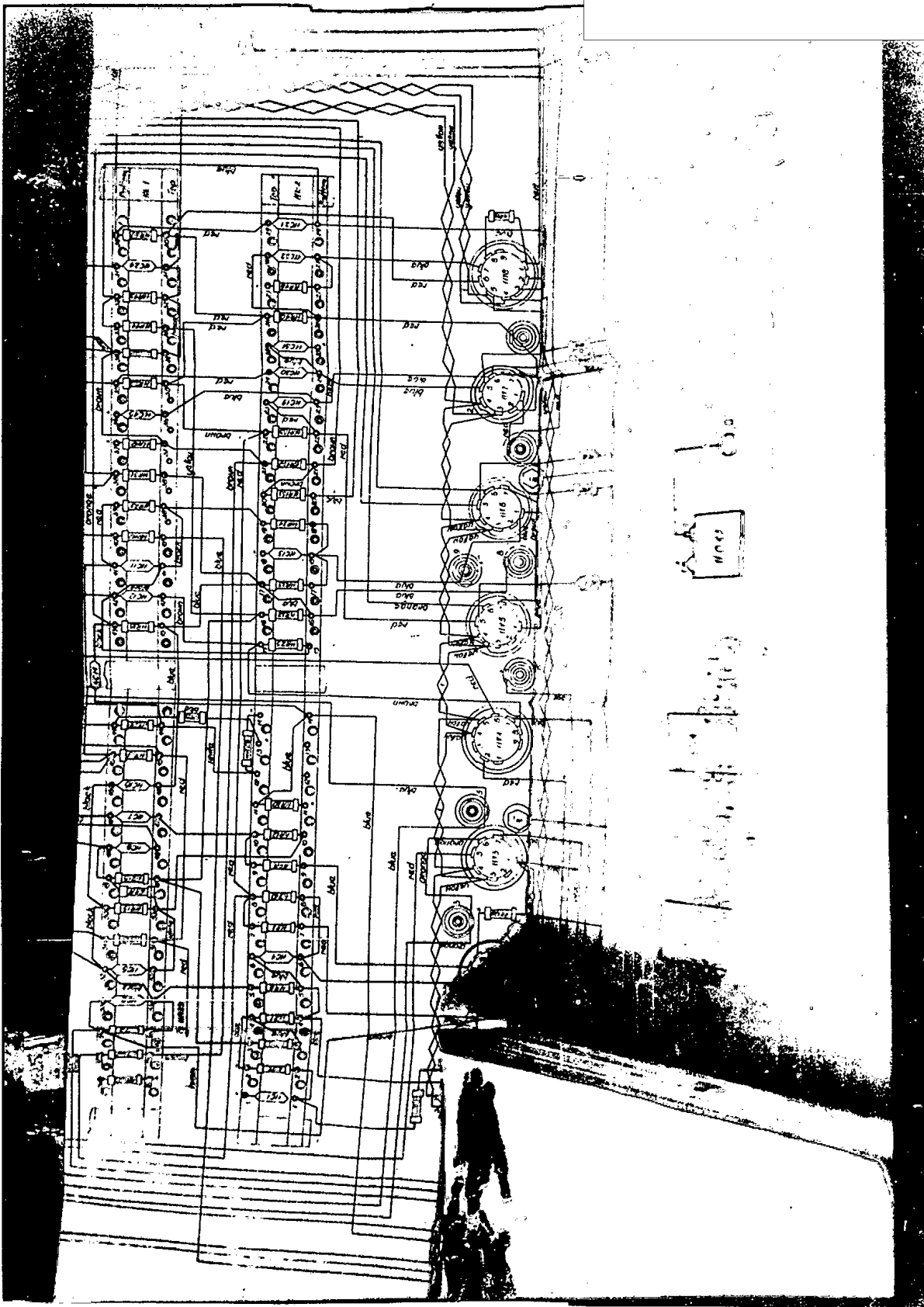

S-E-C-R-E-T

NO FOREIGN DISSEM

50X1

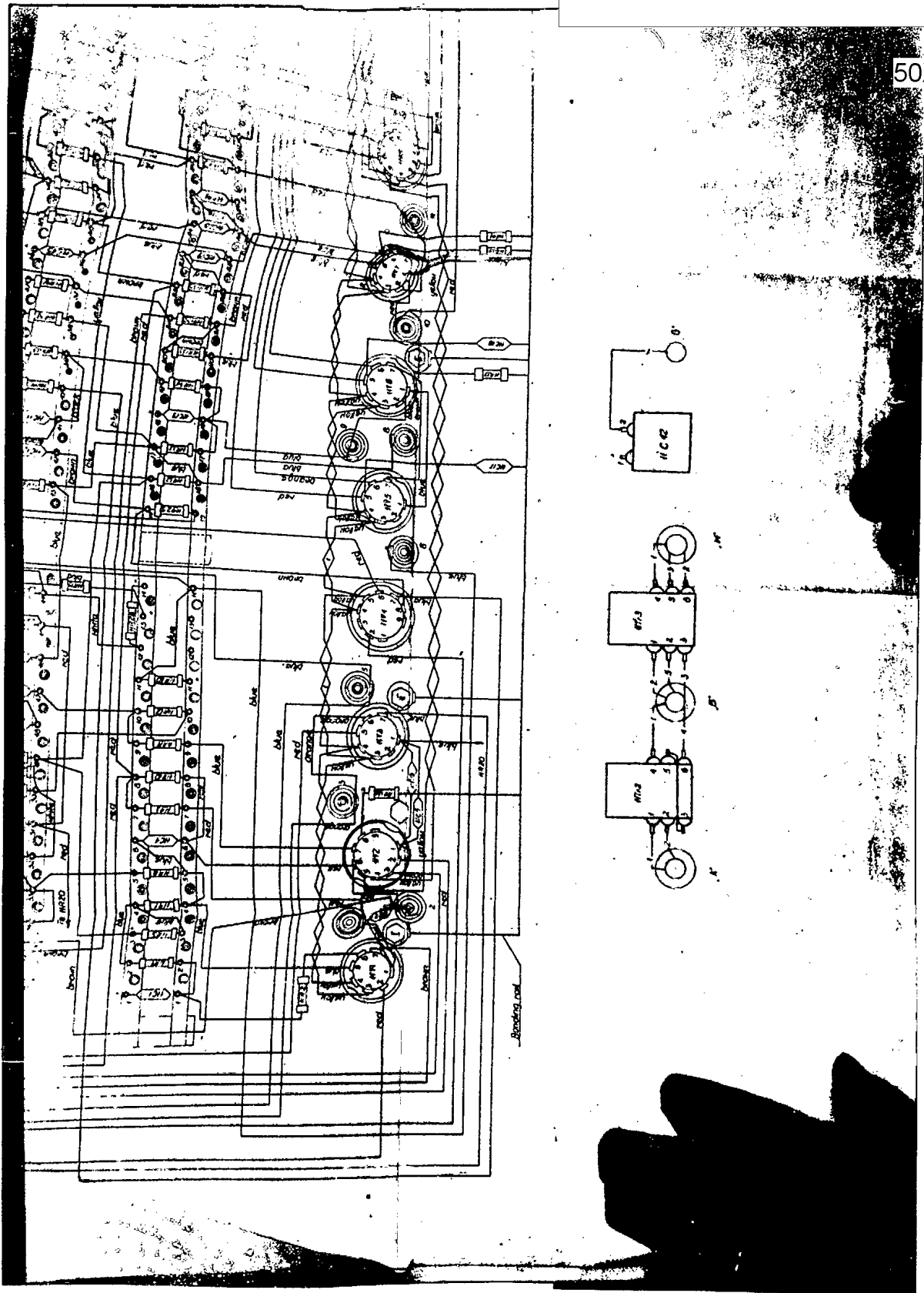

6-8-63-R-1

NO PORTUG. DISSEM

S-E-C-R-E-T
NO FOREIGN DISSEM

50X1

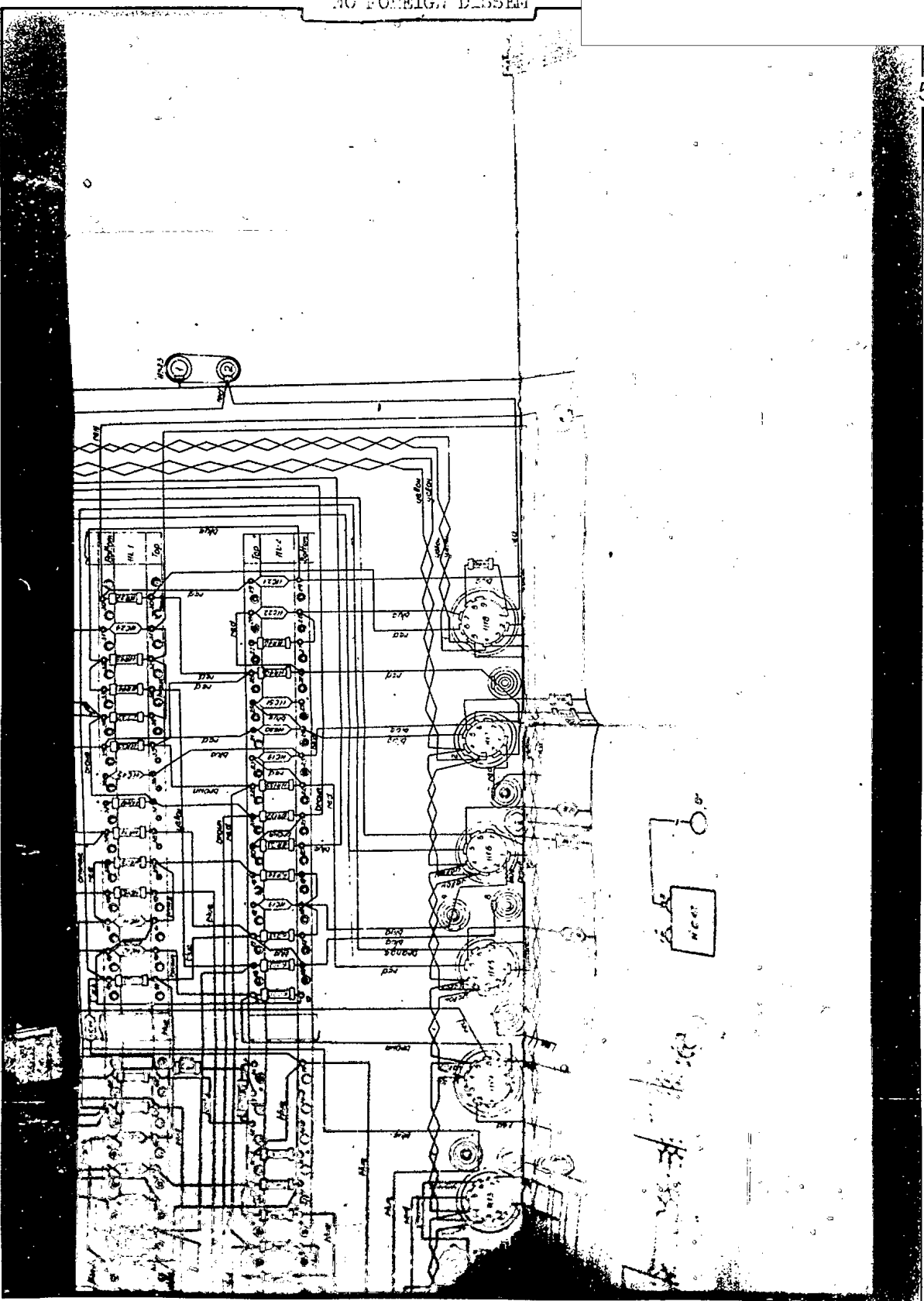

S-E-C-R-E-T

NO FOREIGN DISSEM

S-E-C-R-E-T
NO FOREIGN DISSEM

50X1

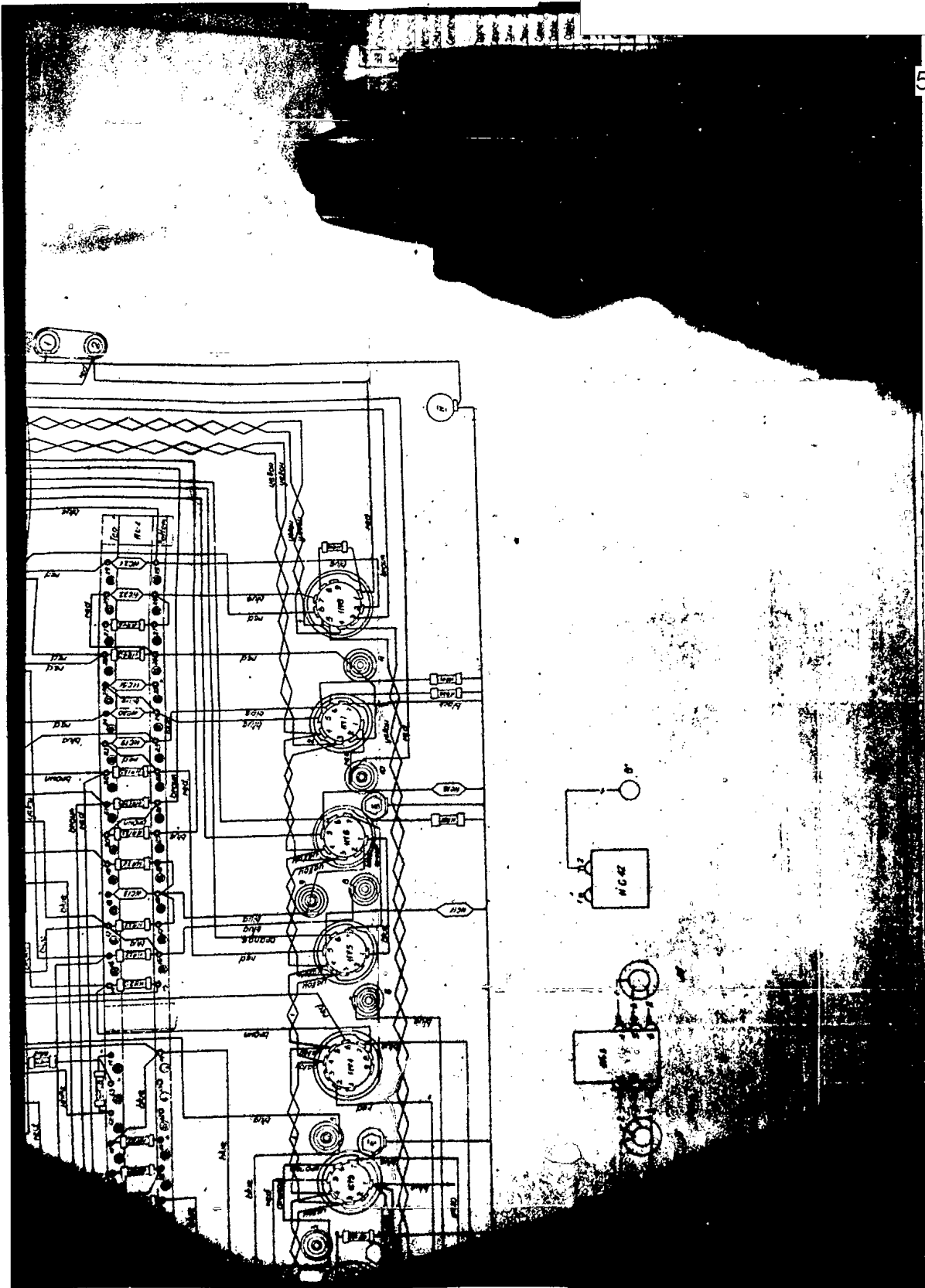

S-E-C-R-E-T

NO FOREIGN DISSEM

S-E-C-R-E-T
NO FOREIGN DISSEM

50X1

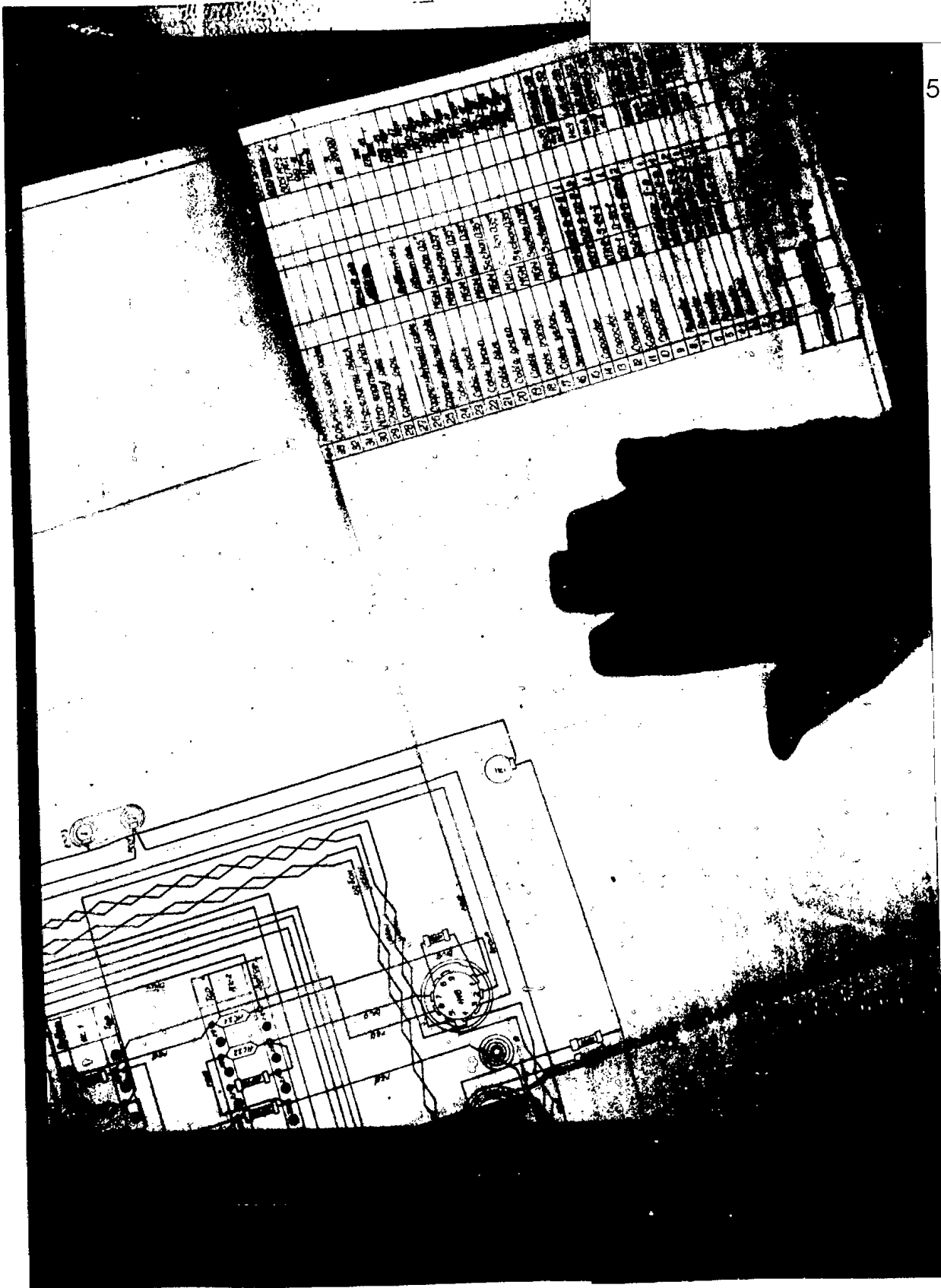

S-E-C-R-E-T
NO FOREIGN DISSEM

S-E-C-R-E-T
NO FOREIGN DISSEM

50X1

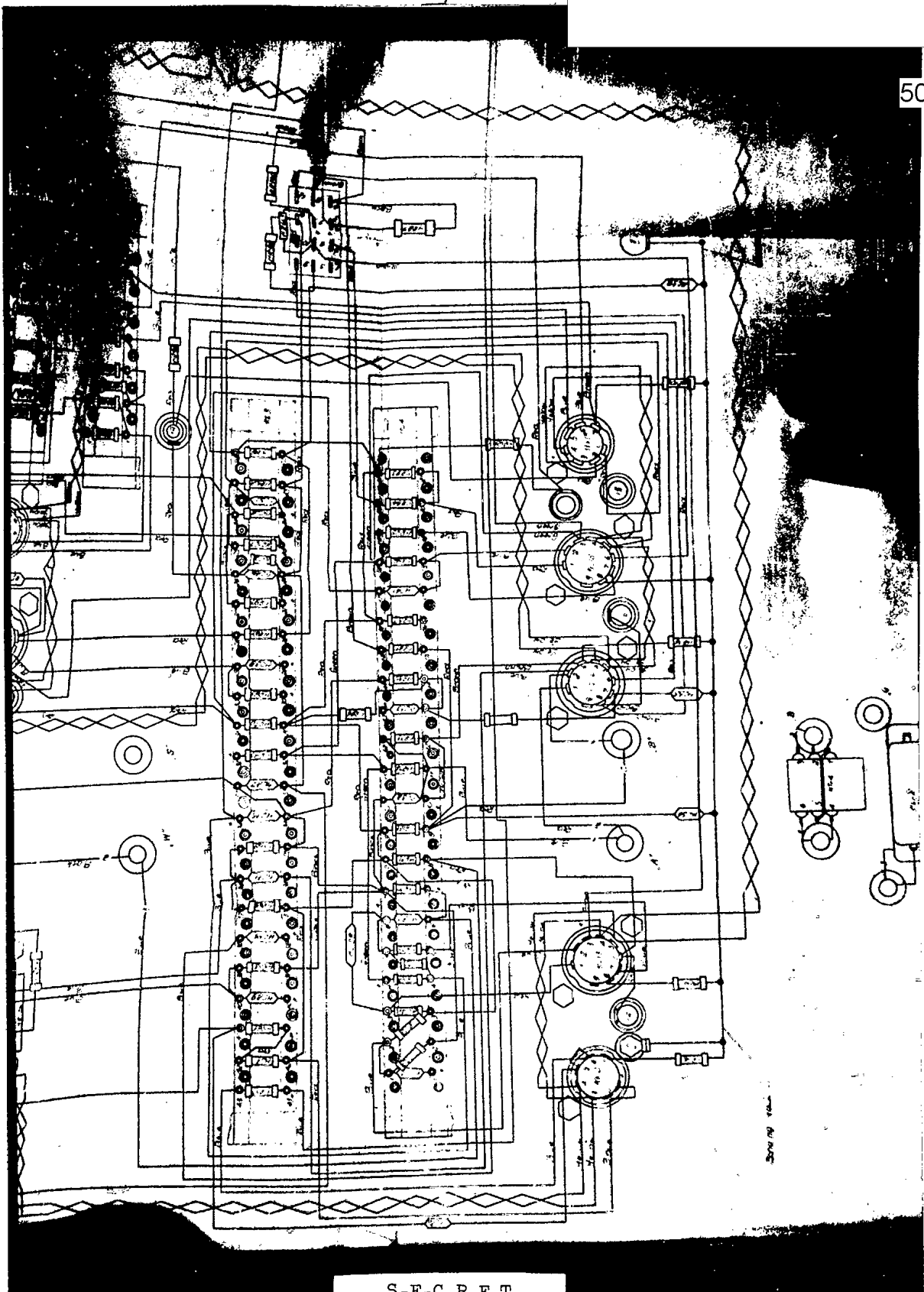

S-E-C-R-E-T
NO FOREIGN DISSEM

S-E-C-R-E-T
NO FOREIGN DISSEM

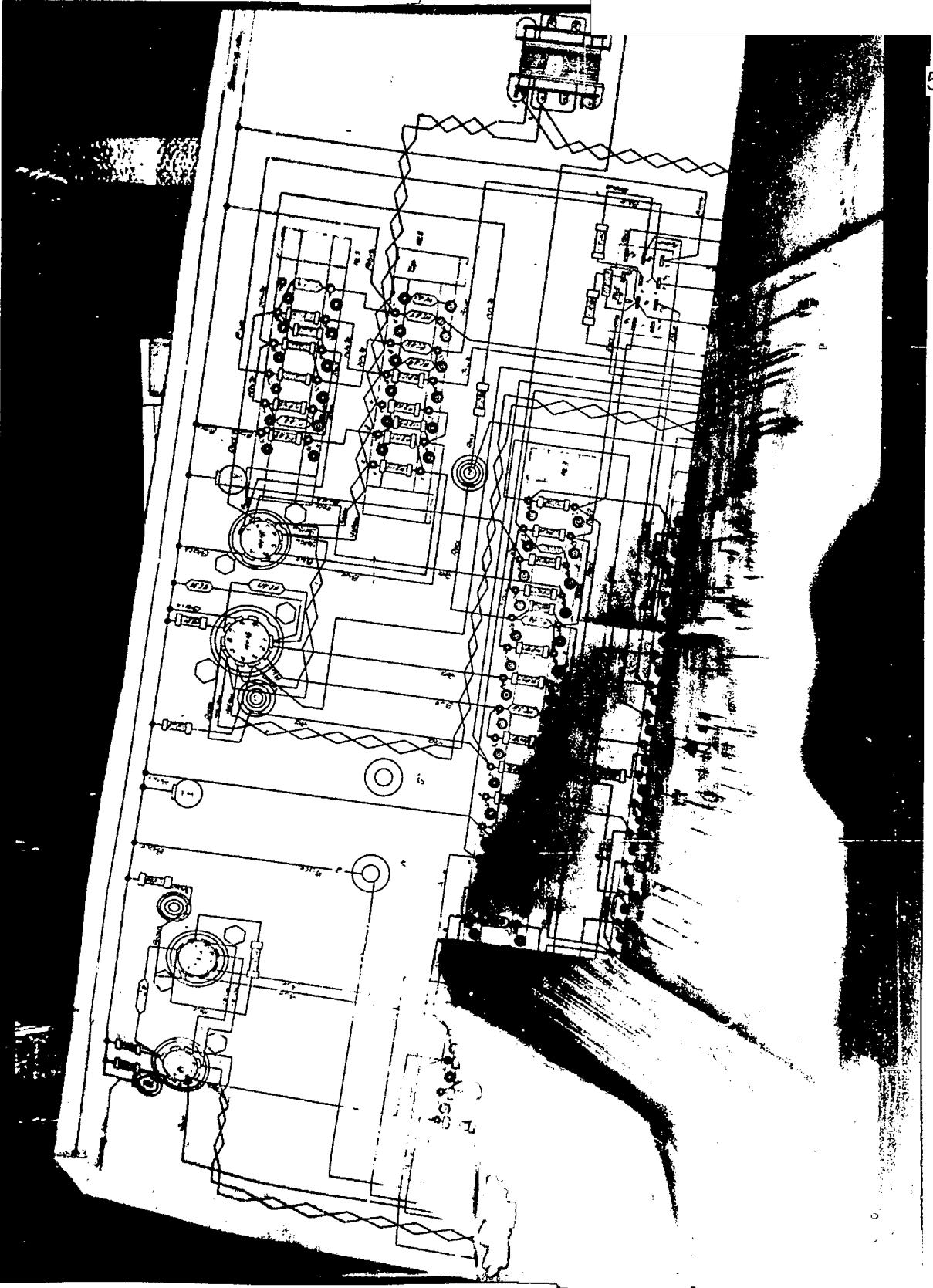

50X1

S-E-C-R-E-T

NO FOREIGN DISSEM

S-E-C-R-E-T
NO FOREIGN DISSEM

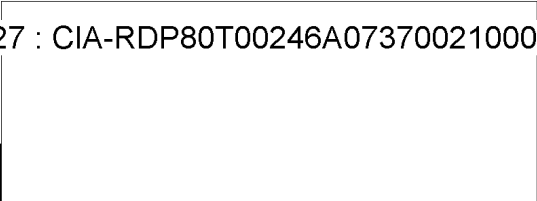

50X1

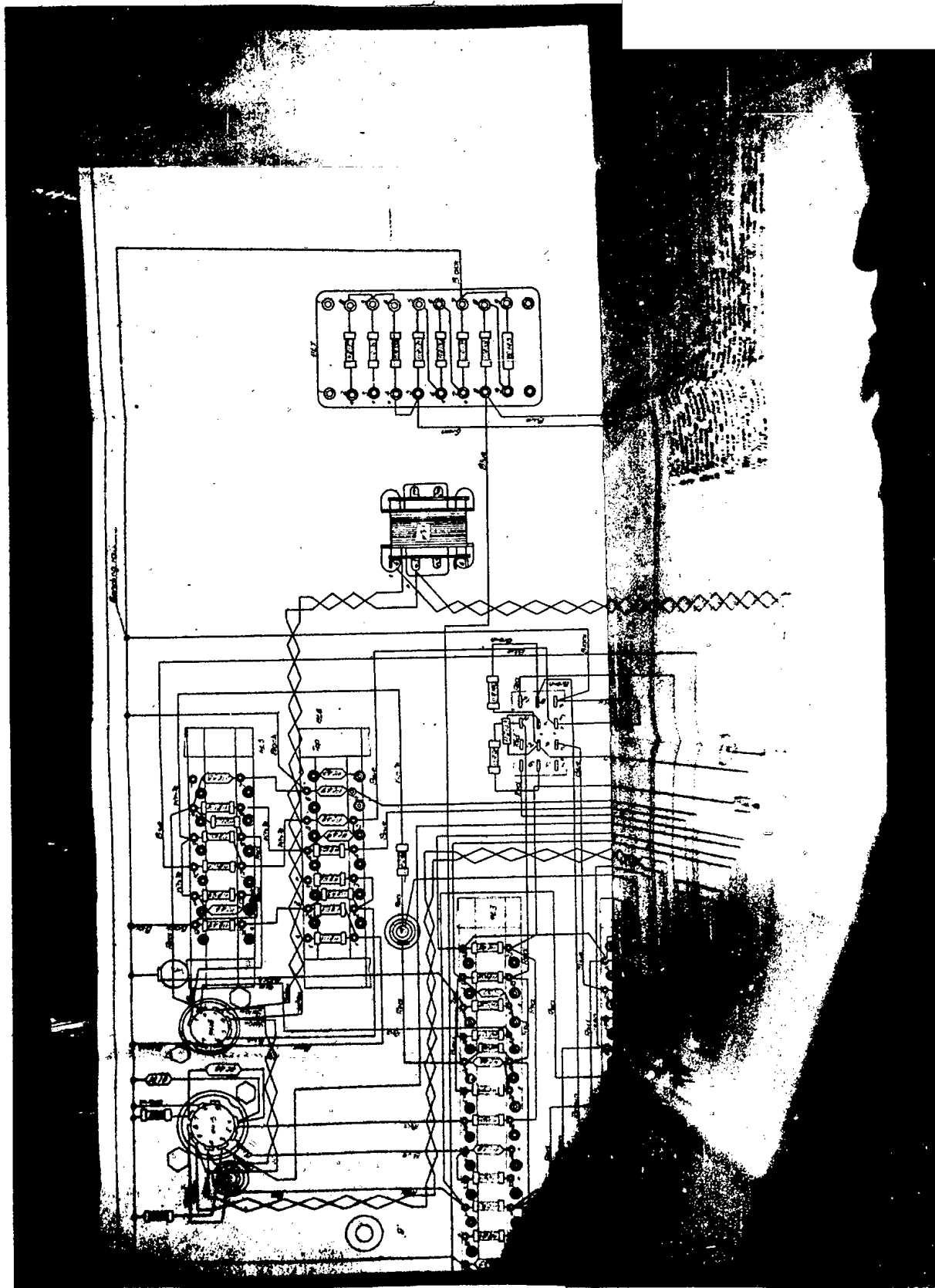

S-E-C-R-E-T
NO FOREIGN DISSEM

S-E-C-R-E-T
NO FOREIGN DISSEM

50X1

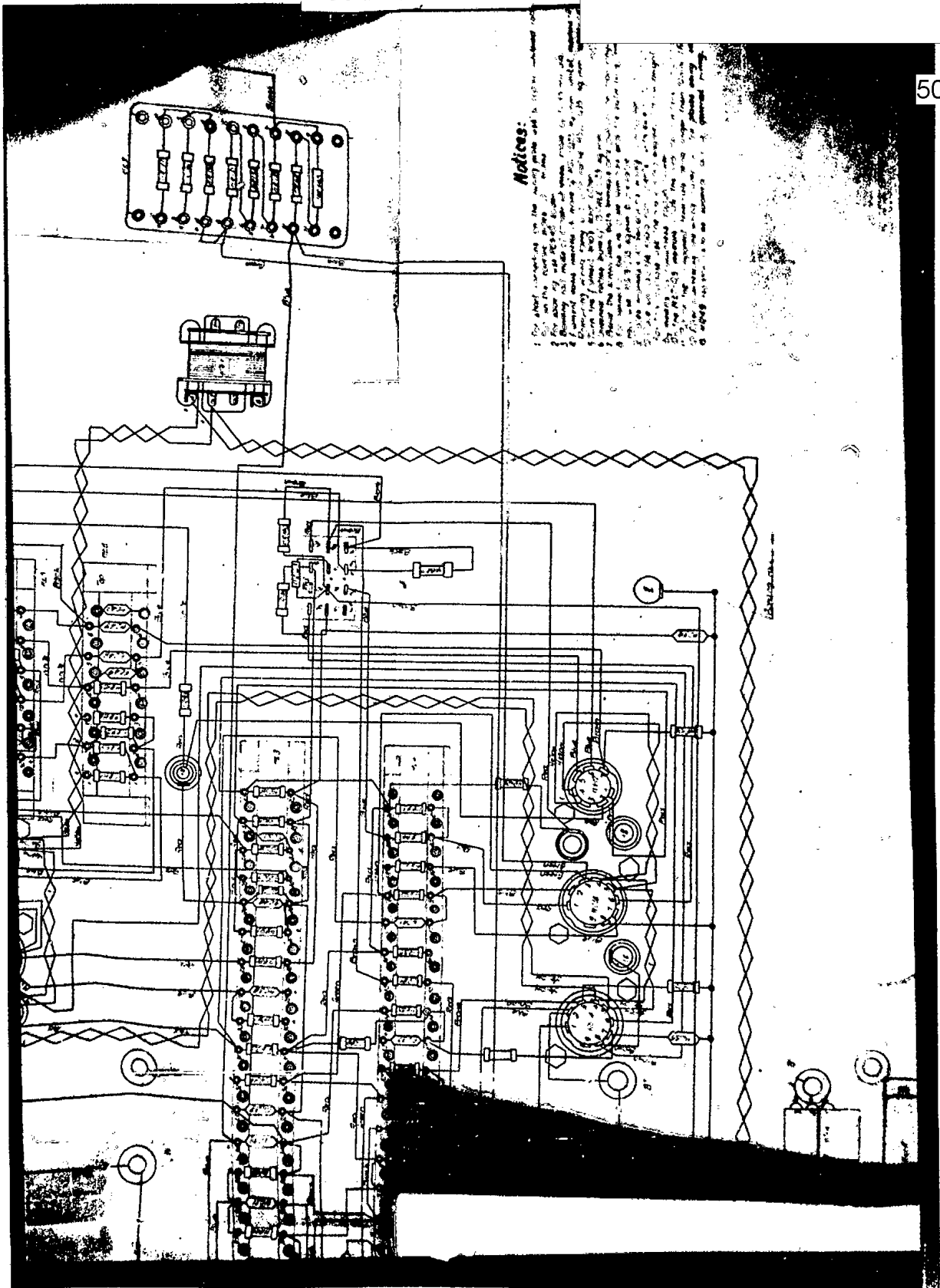

S-E-C-R-E-T
NO FOREIGN DISSEM

S-E-C-R-E-T
NO FOREIGN DISSEM

50X1

Item No.	Description	Quantity	Unit	Remarks
1
2
3
4
5
6
7
8
9
10
11
12
13
14
15
16
17
18
19
20
21
22
23
24
25
26
27
28
29
30
31
32
33
34
35
36
37
38
39
40
41
42
43
44
45
46
47
48
49
50

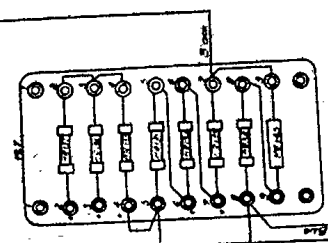

Notes:

1. For short connections on the wiring table use a copper shielded cable 0.10 mm dia.
2. Put on the cable 100% jacket.
3. For assembly of the cable use a copper shielded cable 0.10 mm dia.
4. For assembly of the cable use a copper shielded cable 0.10 mm dia.
5. For assembly of the cable use a copper shielded cable 0.10 mm dia.
6. For assembly of the cable use a copper shielded cable 0.10 mm dia.
7. For assembly of the cable use a copper shielded cable 0.10 mm dia.
8. For assembly of the cable use a copper shielded cable 0.10 mm dia.
9. For assembly of the cable use a copper shielded cable 0.10 mm dia.
10. For assembly of the cable use a copper shielded cable 0.10 mm dia.
11. For assembly of the cable use a copper shielded cable 0.10 mm dia.
12. For assembly of the cable use a copper shielded cable 0.10 mm dia.
13. For assembly of the cable use a copper shielded cable 0.10 mm dia.
14. For assembly of the cable use a copper shielded cable 0.10 mm dia.
15. For assembly of the cable use a copper shielded cable 0.10 mm dia.
16. For assembly of the cable use a copper shielded cable 0.10 mm dia.
17. For assembly of the cable use a copper shielded cable 0.10 mm dia.
18. For assembly of the cable use a copper shielded cable 0.10 mm dia.
19. For assembly of the cable use a copper shielded cable 0.10 mm dia.
20. For assembly of the cable use a copper shielded cable 0.10 mm dia.
21. For assembly of the cable use a copper shielded cable 0.10 mm dia.
22. For assembly of the cable use a copper shielded cable 0.10 mm dia.
23. For assembly of the cable use a copper shielded cable 0.10 mm dia.
24. For assembly of the cable use a copper shielded cable 0.10 mm dia.
25. For assembly of the cable use a copper shielded cable 0.10 mm dia.
26. For assembly of the cable use a copper shielded cable 0.10 mm dia.
27. For assembly of the cable use a copper shielded cable 0.10 mm dia.
28. For assembly of the cable use a copper shielded cable 0.10 mm dia.
29. For assembly of the cable use a copper shielded cable 0.10 mm dia.
30. For assembly of the cable use a copper shielded cable 0.10 mm dia.
31. For assembly of the cable use a copper shielded cable 0.10 mm dia.
32. For assembly of the cable use a copper shielded cable 0.10 mm dia.
33. For assembly of the cable use a copper shielded cable 0.10 mm dia.
34. For assembly of the cable use a copper shielded cable 0.10 mm dia.
35. For assembly of the cable use a copper shielded cable 0.10 mm dia.
36. For assembly of the cable use a copper shielded cable 0.10 mm dia.
37. For assembly of the cable use a copper shielded cable 0.10 mm dia.
38. For assembly of the cable use a copper shielded cable 0.10 mm dia.
39. For assembly of the cable use a copper shielded cable 0.10 mm dia.
40. For assembly of the cable use a copper shielded cable 0.10 mm dia.
41. For assembly of the cable use a copper shielded cable 0.10 mm dia.
42. For assembly of the cable use a copper shielded cable 0.10 mm dia.
43. For assembly of the cable use a copper shielded cable 0.10 mm dia.
44. For assembly of the cable use a copper shielded cable 0.10 mm dia.
45. For assembly of the cable use a copper shielded cable 0.10 mm dia.
46. For assembly of the cable use a copper shielded cable 0.10 mm dia.
47. For assembly of the cable use a copper shielded cable 0.10 mm dia.
48. For assembly of the cable use a copper shielded cable 0.10 mm dia.
49. For assembly of the cable use a copper shielded cable 0.10 mm dia.
50. For assembly of the cable use a copper shielded cable 0.10 mm dia.

S-E-C-R-E-T

NO FOREIGN DISSEM

S-E-C-R-E-T
NO FOREIGN DISSEM



50X1

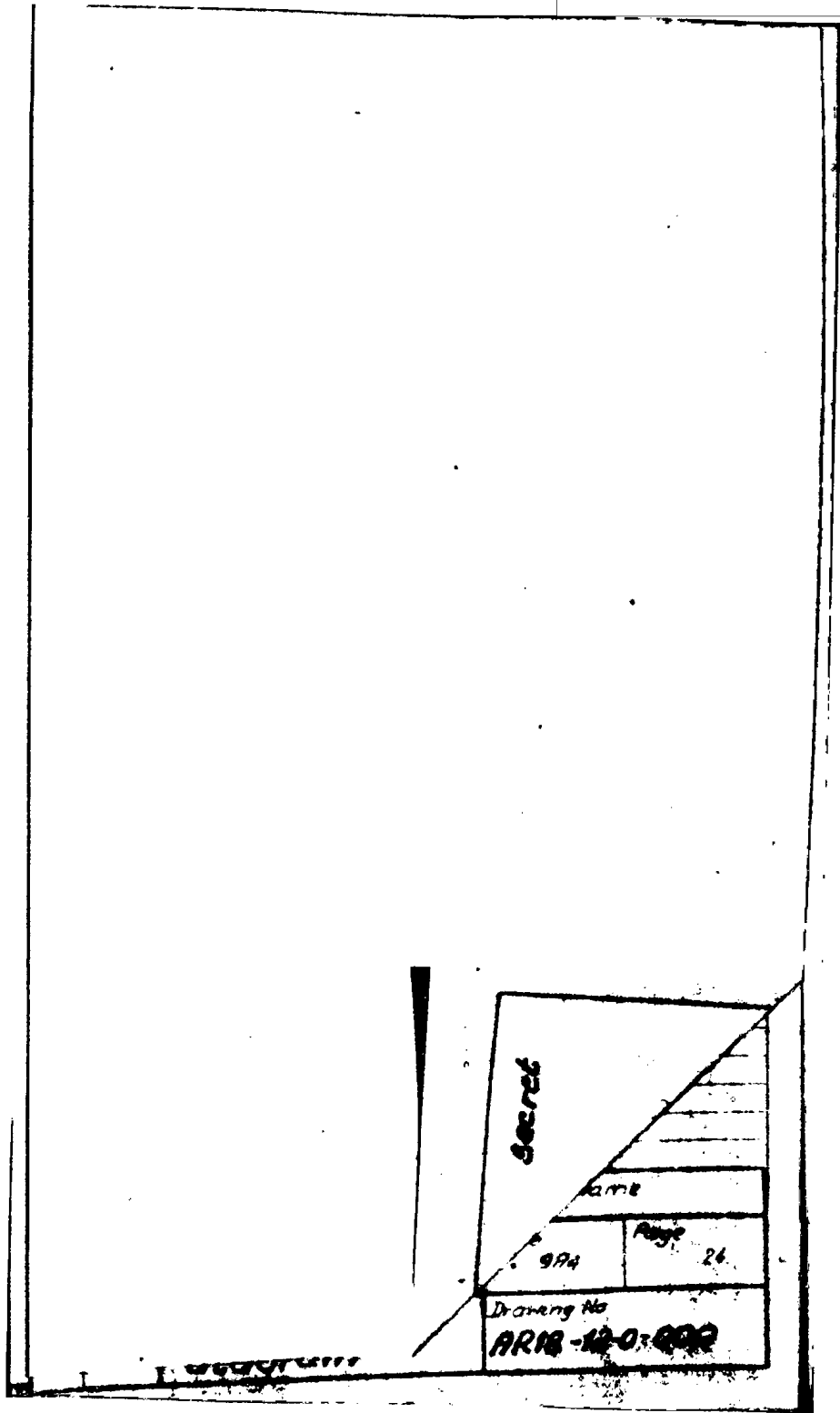

Secret		Name	
		974	Page 26
Drawing No AR18-12-0-000			

S-E-C-R-E-T
NO FOREIGN DISSEM

S-E-C-R-E-T
NO FOREIGN DISSEM

50X1

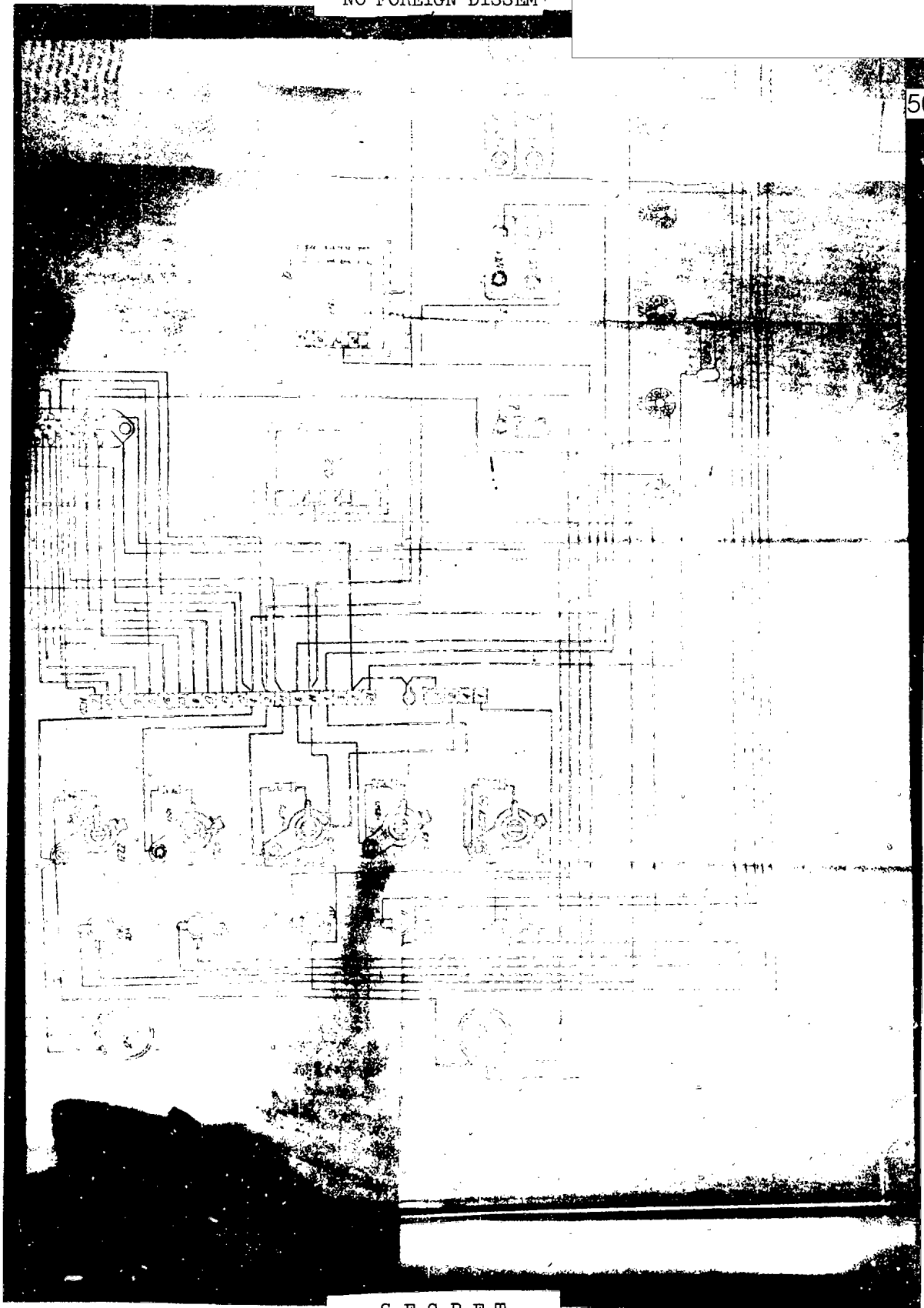

S-E-C-R-E-T
NO FOREIGN DISSEM

S-E-C-R-E-T
NO FOREIGN DISSEM

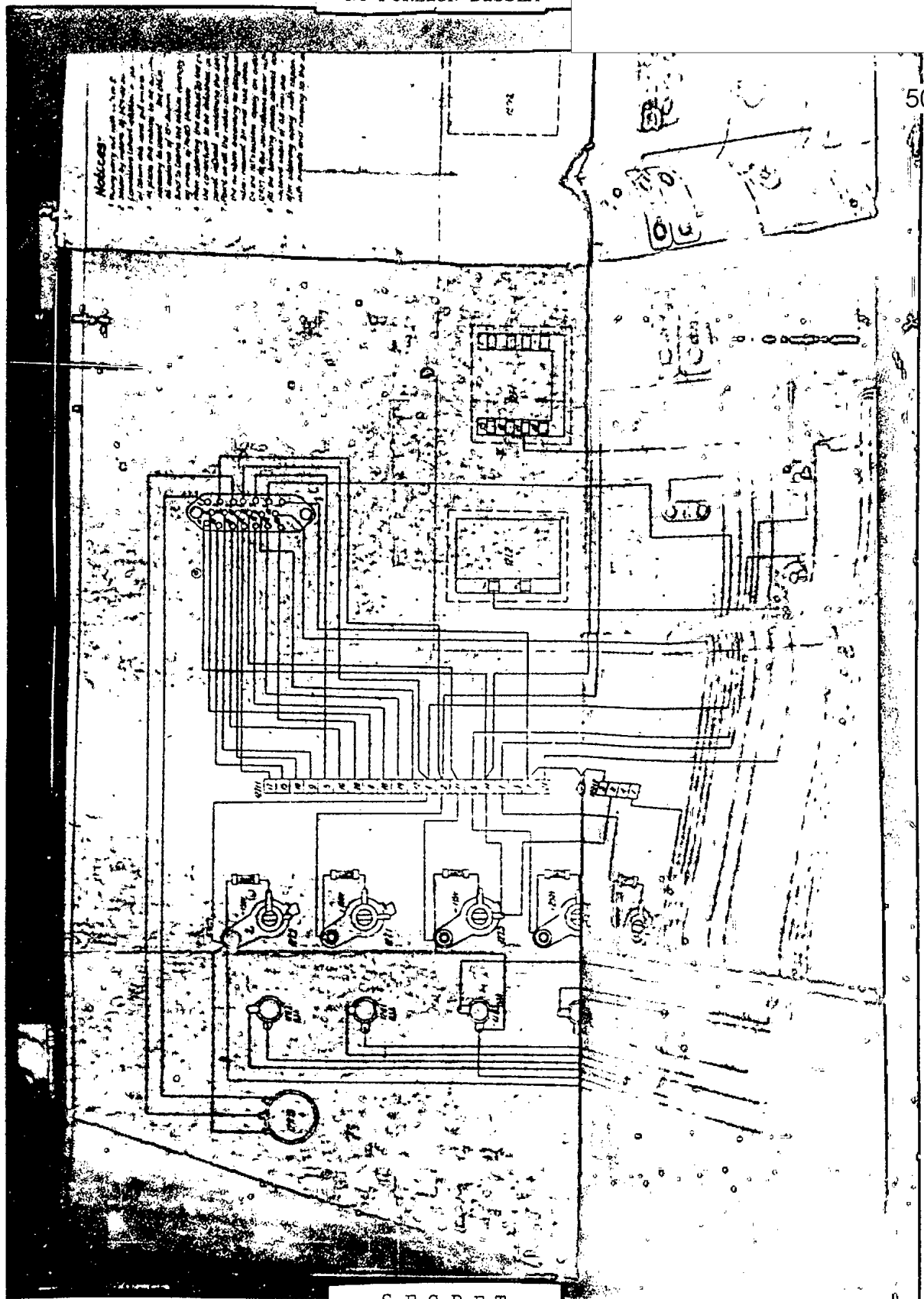

S-E-C-R-E-T
NO FOREIGN DISSEM

S-E-C-R-E-T
NO FOREIGN DISSEM

50X1

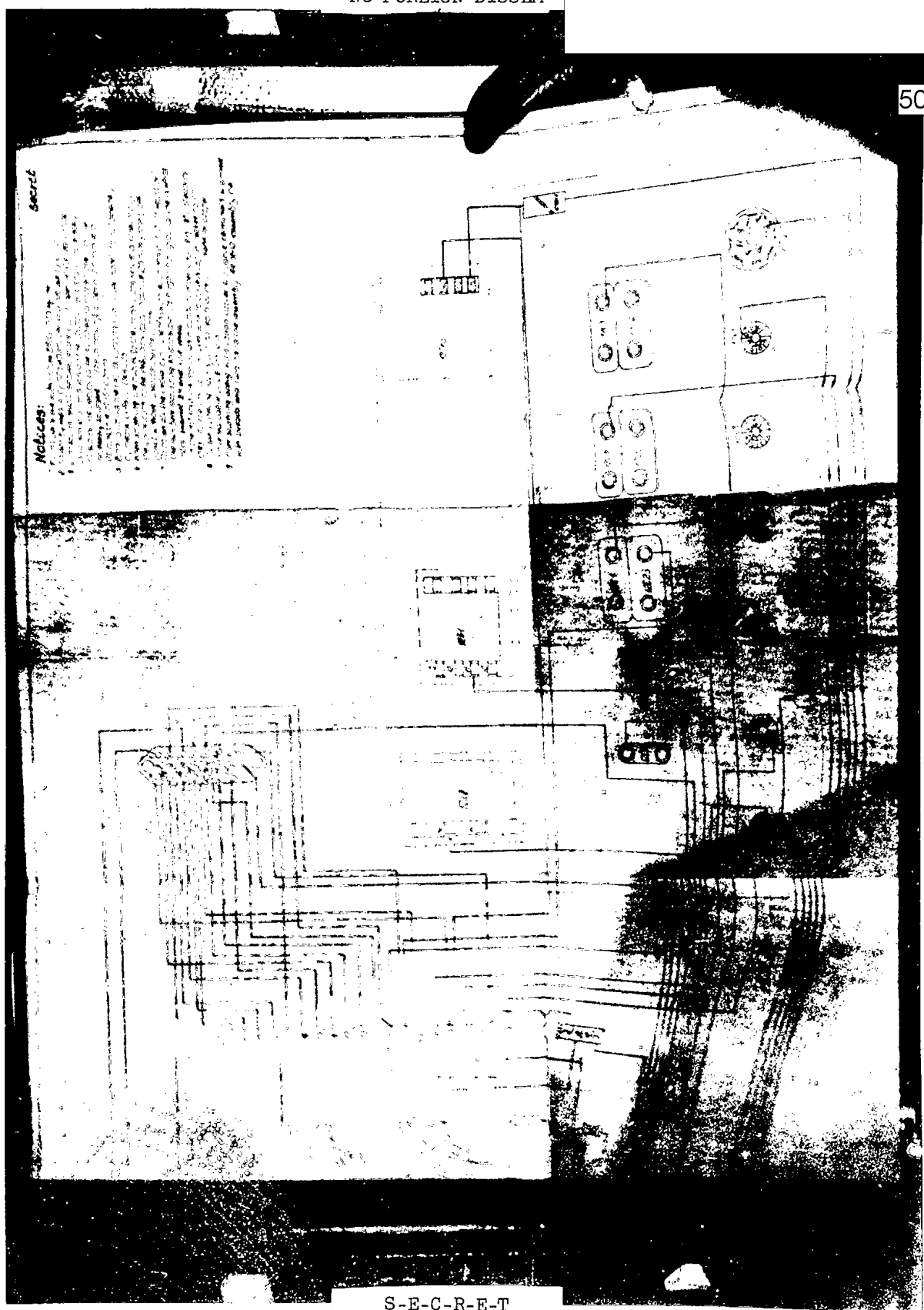

S-E-C-R-E-T
NO FOREIGN DISSEM

S-E-C-R-E-T
NO FOREIGN DISSEM

50X1

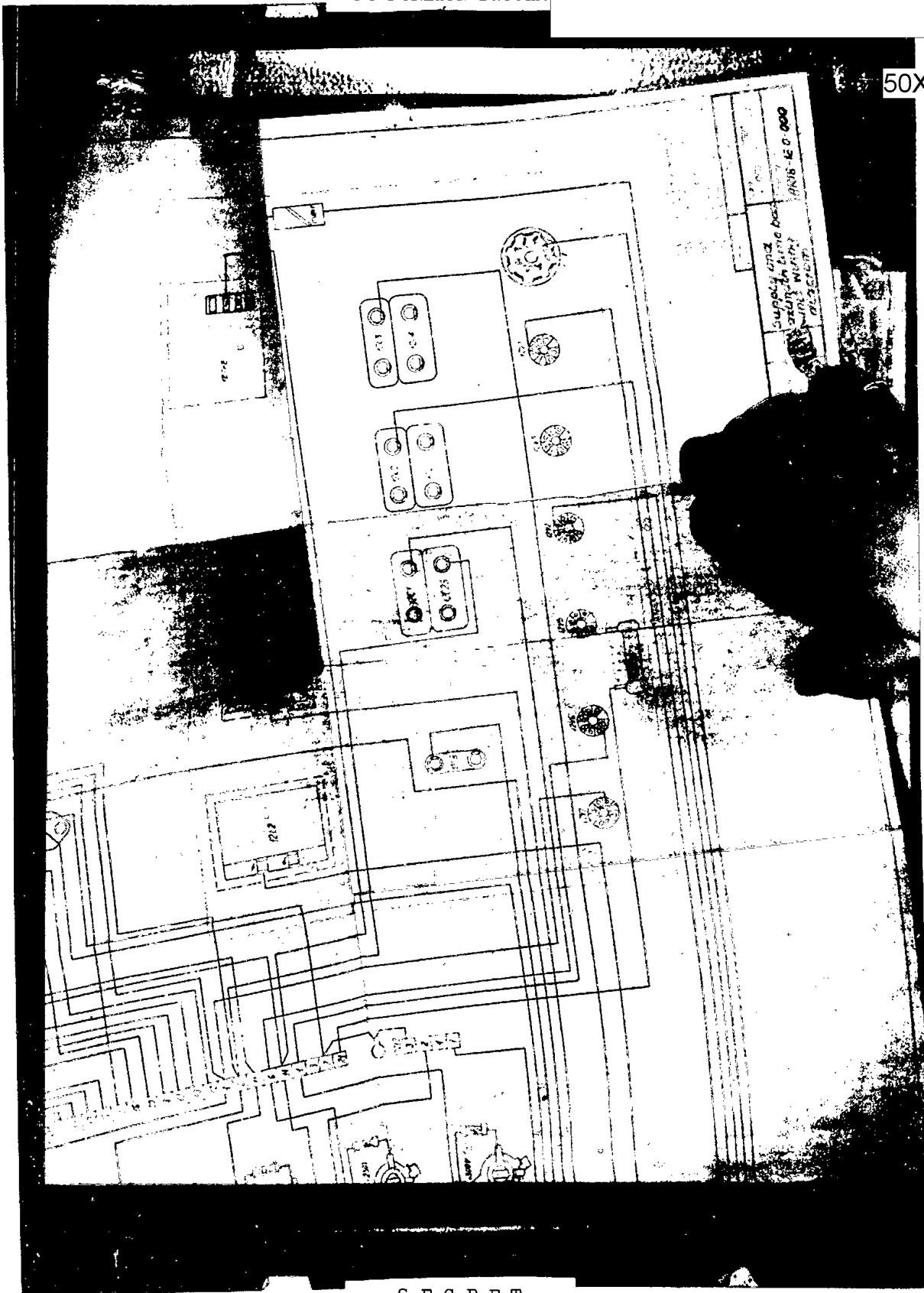

S-E-C-R-E-T
NO FOREIGN DISSEM

S-E-C-R-E-T
NO FOREIGN DISSEM

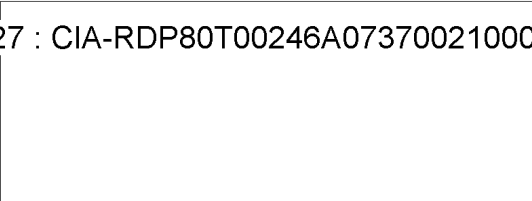

50X1

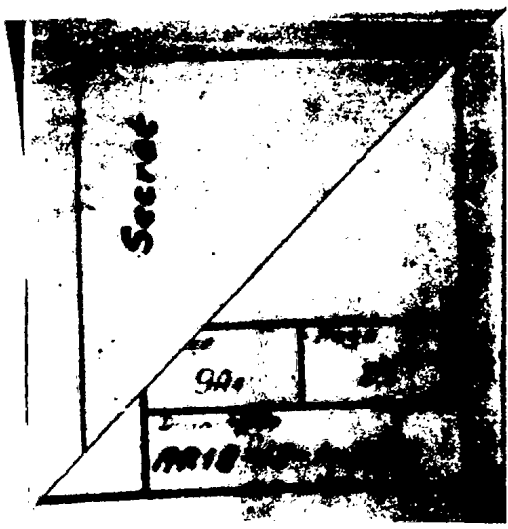

S-E-C-R-E-T
NO FOREIGN DISSEM

S-E-C-R-E-T
NO FOREIGN DISSEM

50X1

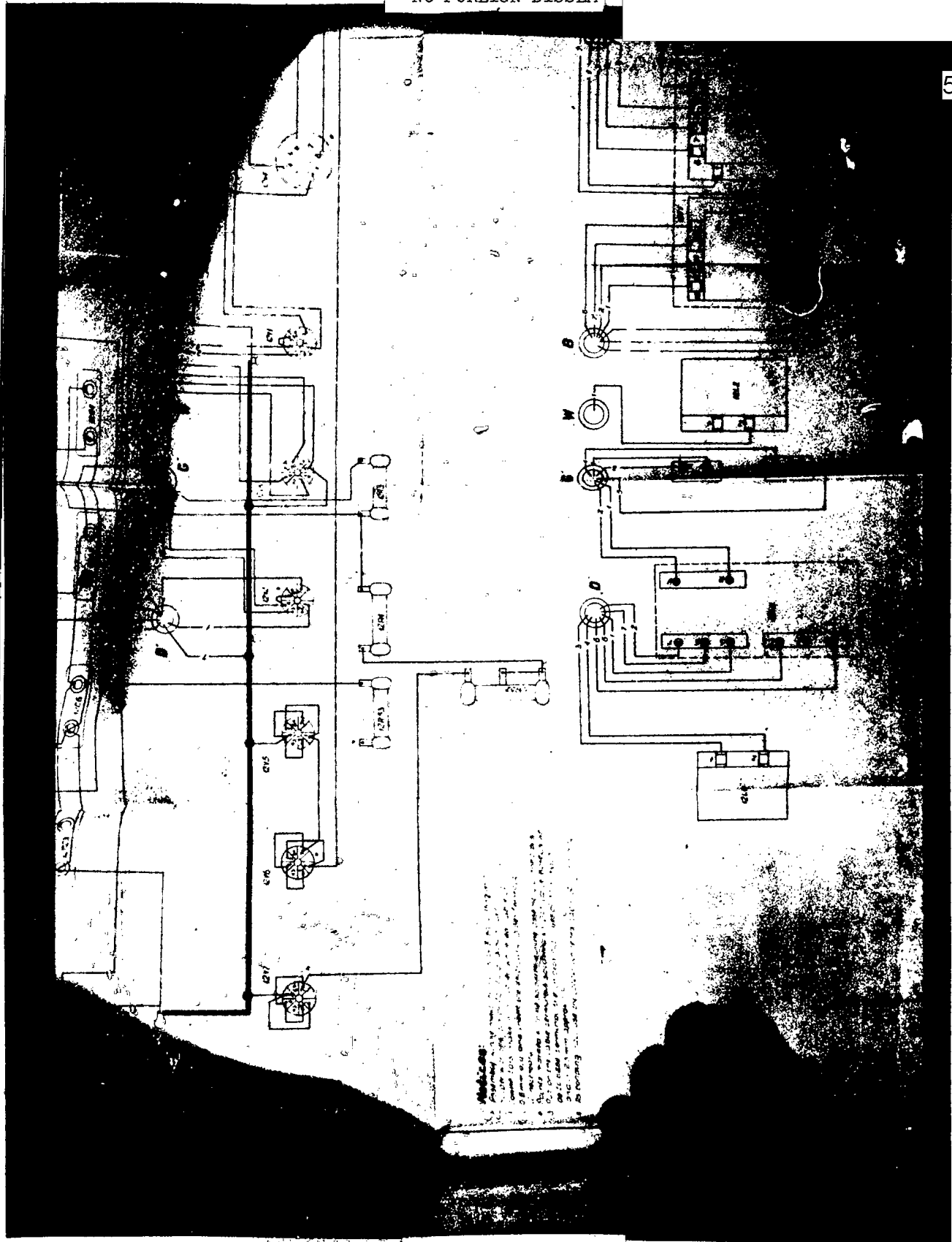

S-E-C-R-E-T
NO FOREIGN DISSEM

S-E-C-R-E-T
NO FOREIGN DISSEM

50X1

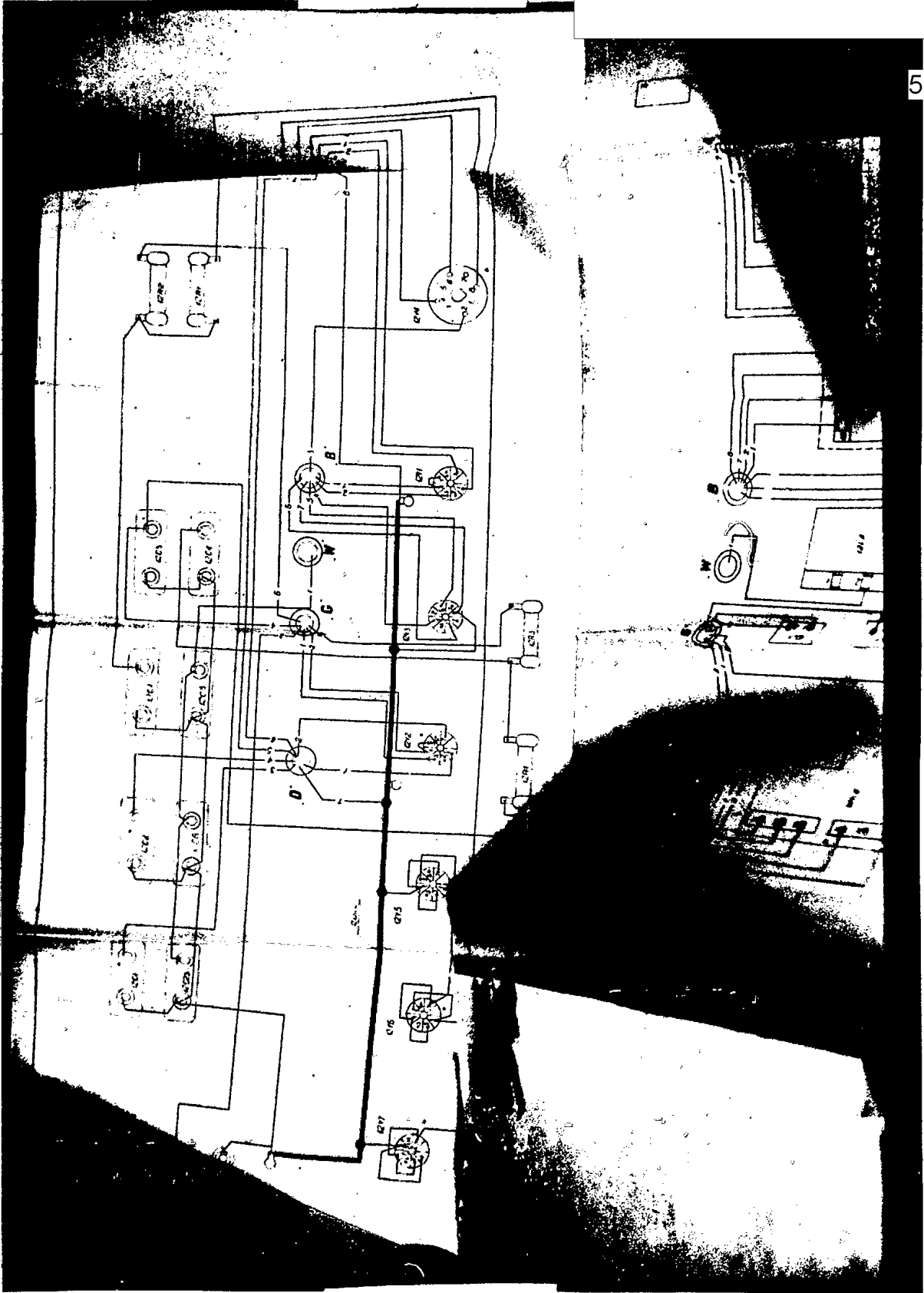

S-E-C-R-E-T
NO FOREIGN DISSEM

S-E-C-R-E-T
NO FOREIGN DISSEM

50X1

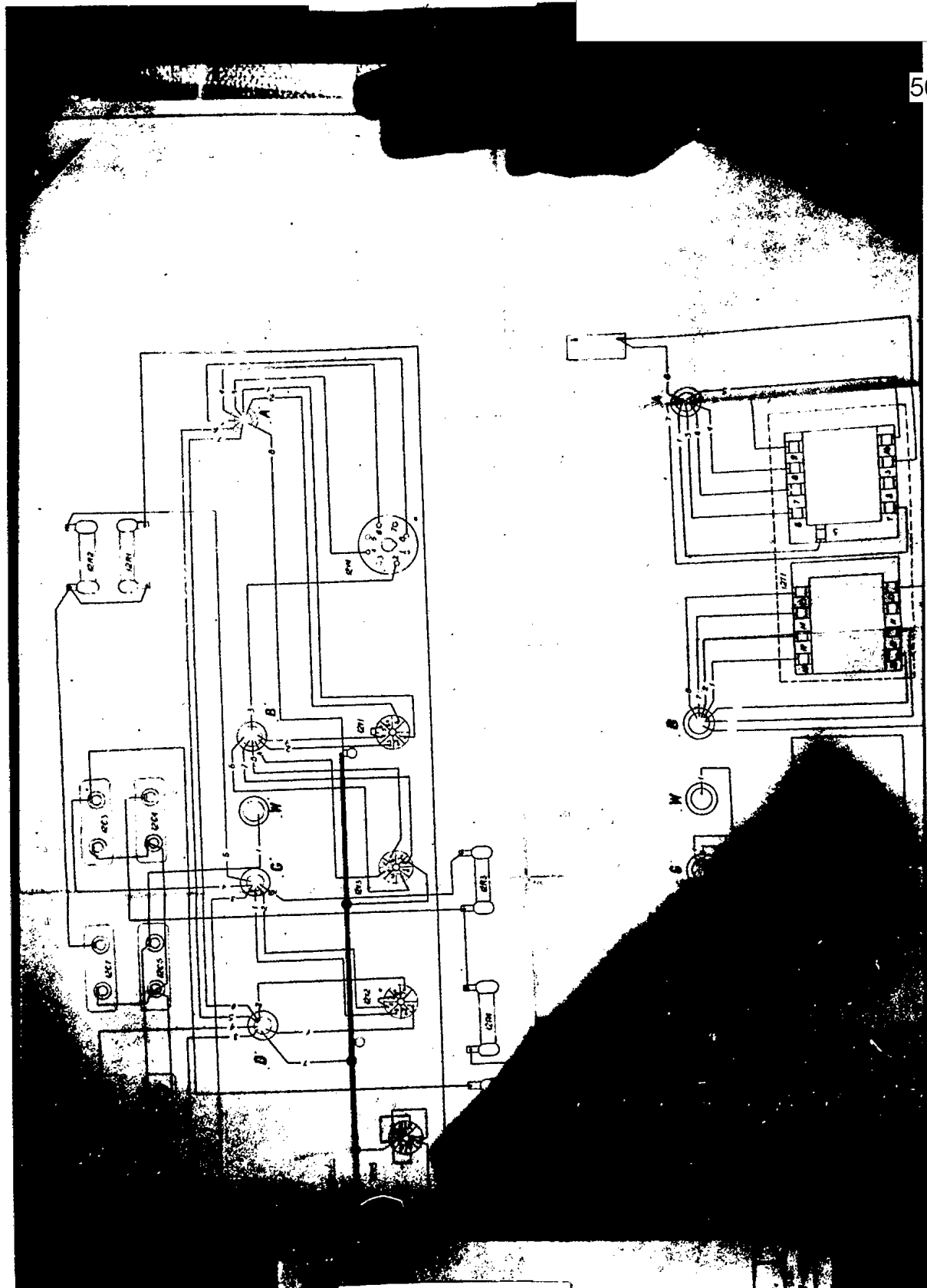

S-E-C-R-E-T
NO FOREIGN DISSEM

SECRET
NO FOREIGN DISSEM

50X1

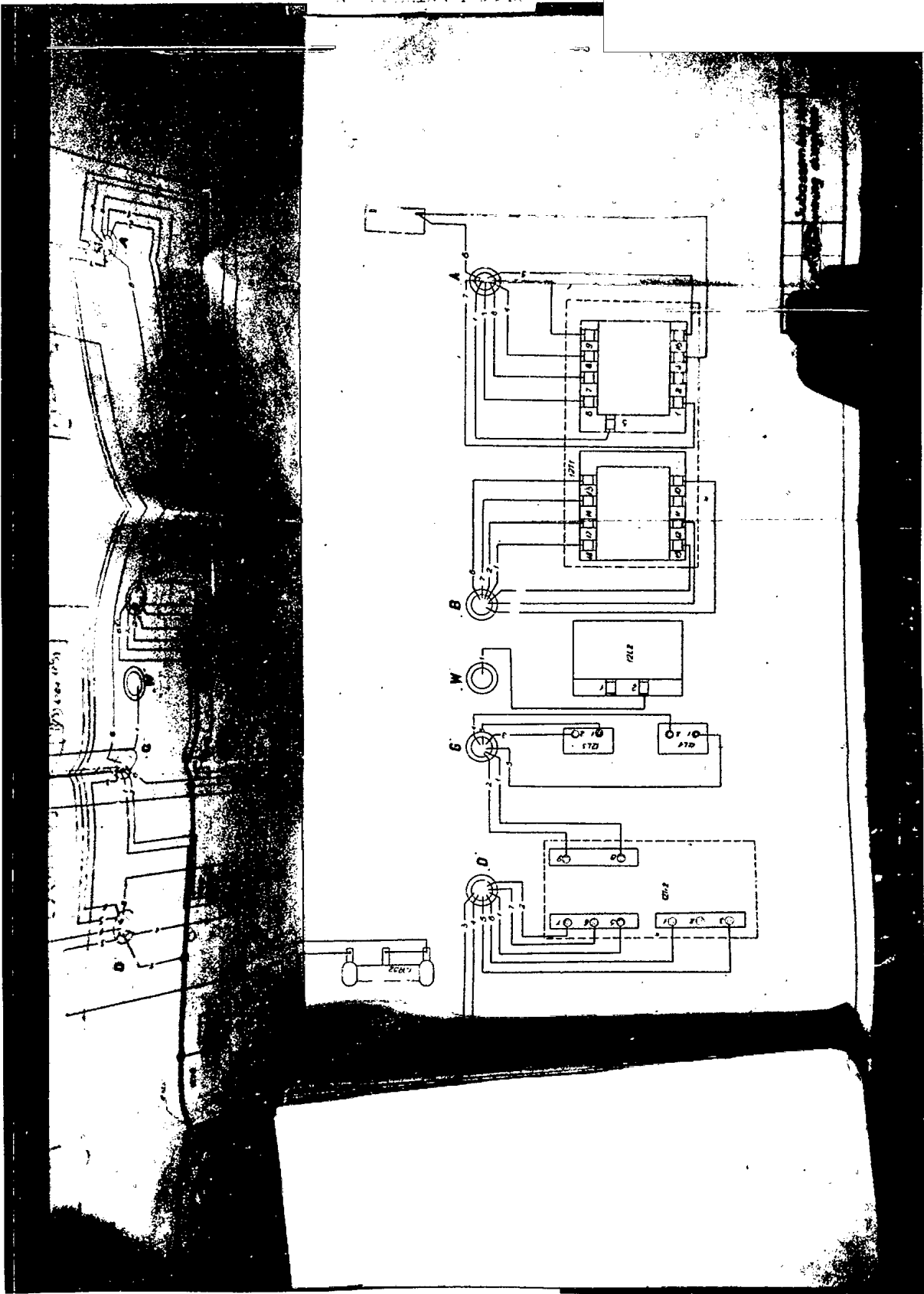

S-E-C-R-E-T

NO FOREIGN DISSEM

S-E-C-R-E-T
NO FOREIGN DISSEM

50X1

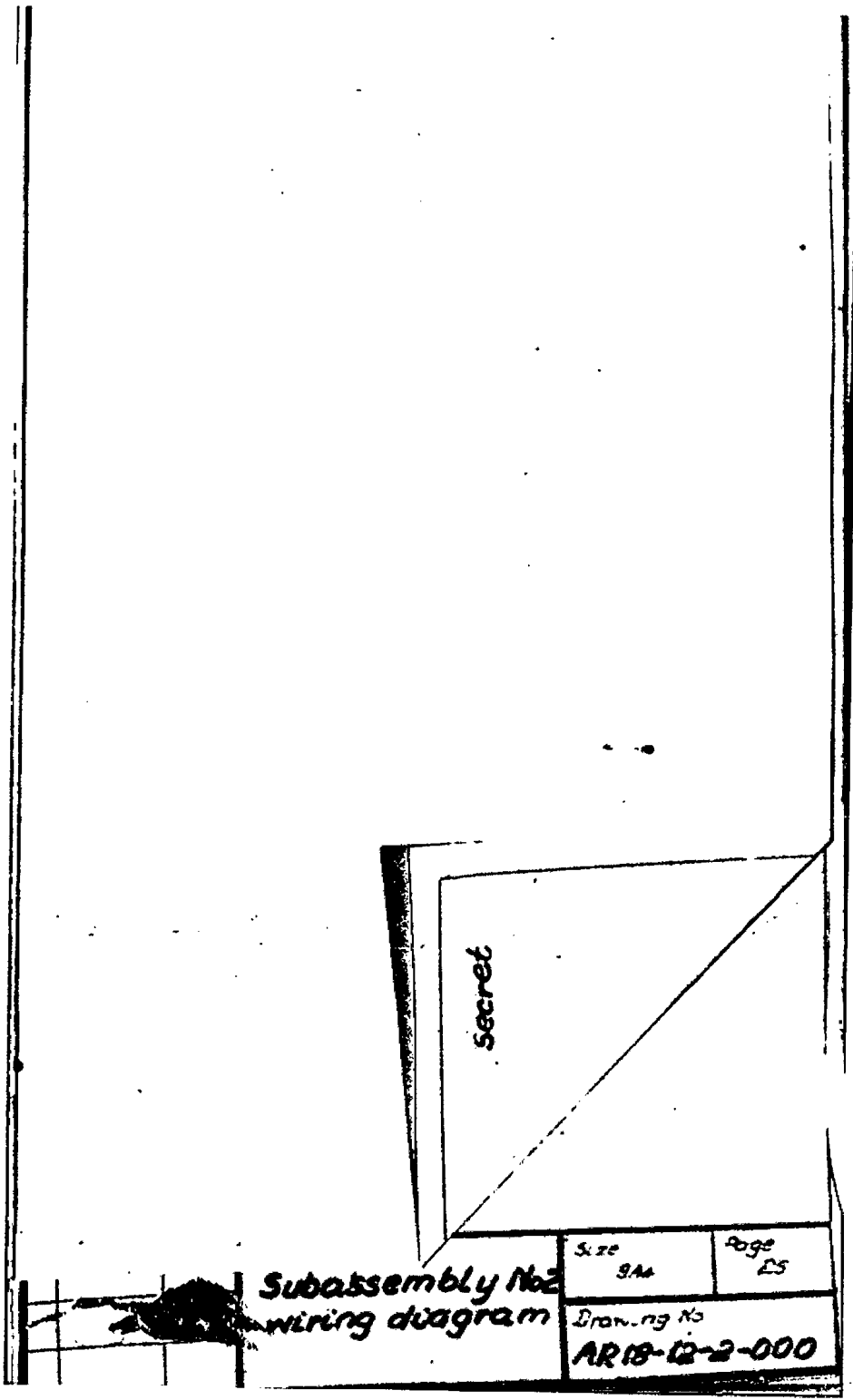

S-E-C-R-E-T
NO FOREIGN DISSEM

S-E-C-R-E-T
NO FOREIGN DISSEM

50X1

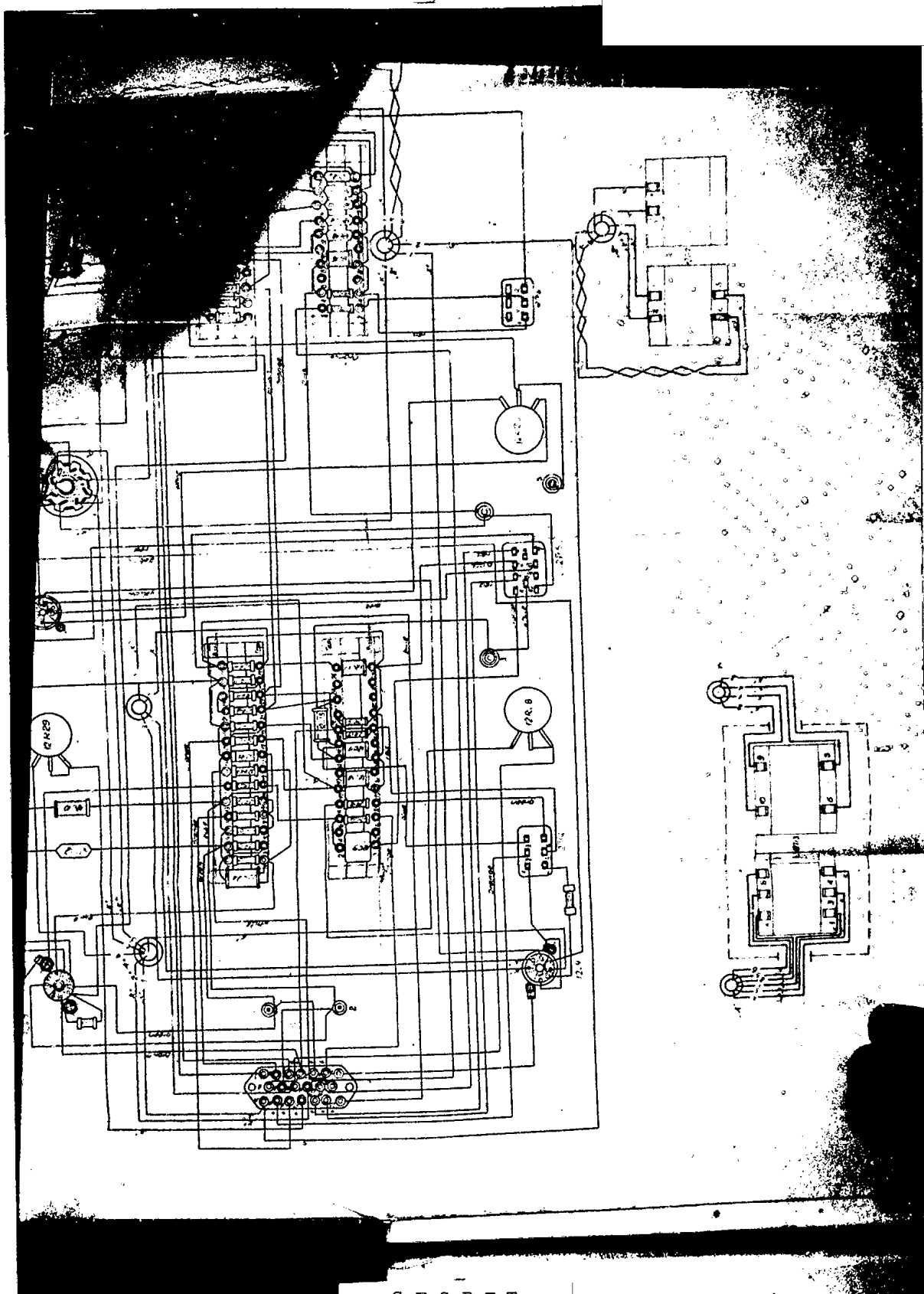

S-E-C-R-E-T
NO FOREIGN DISSEM

S-E-C-R-E-T
NO FOREIGN DISSEM

50X1

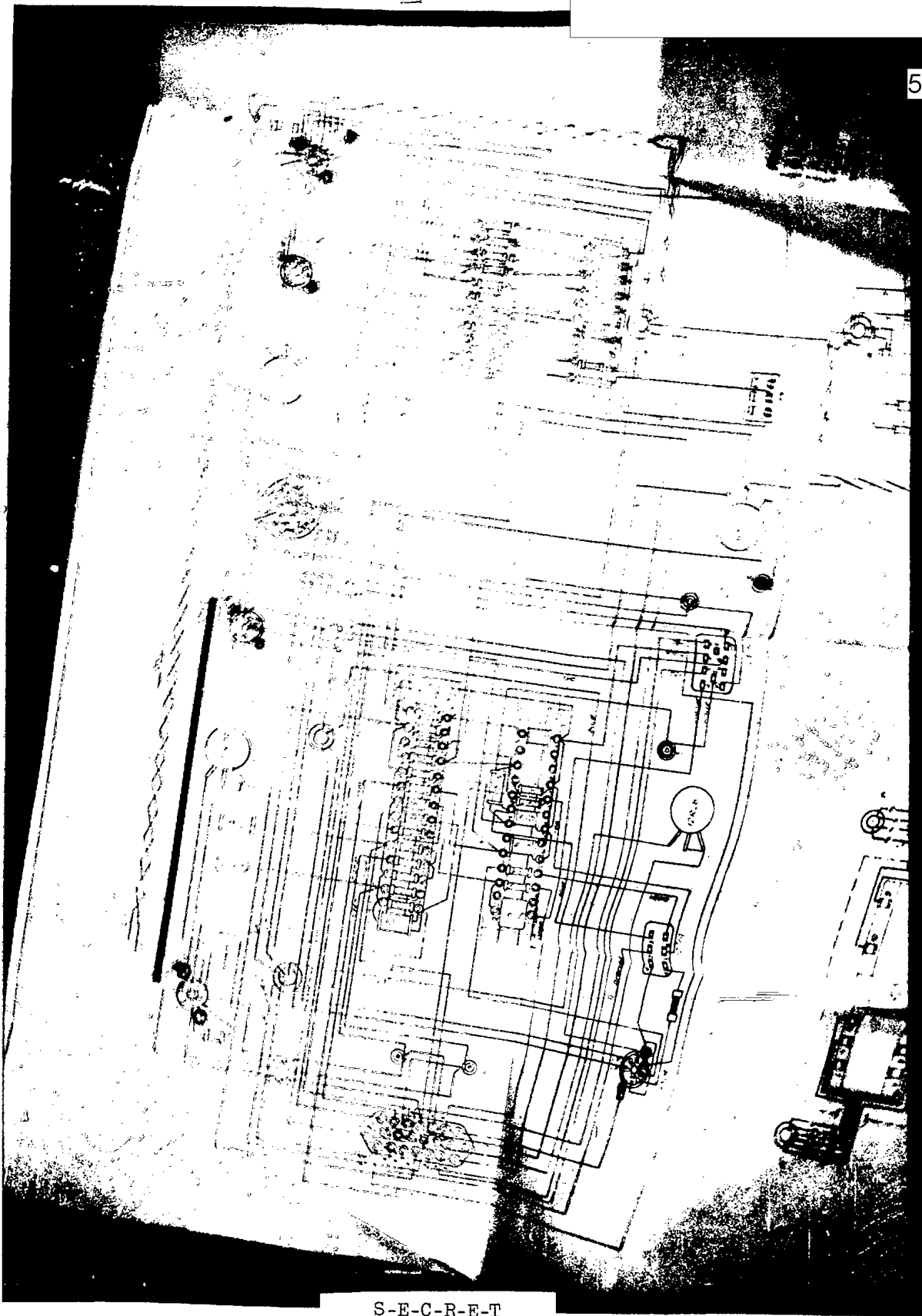

S-E-C-R-E-T
NO FOREIGN DISSEM

S-E-C-R-E-T
NO FOREIGN DISSEM

50X1

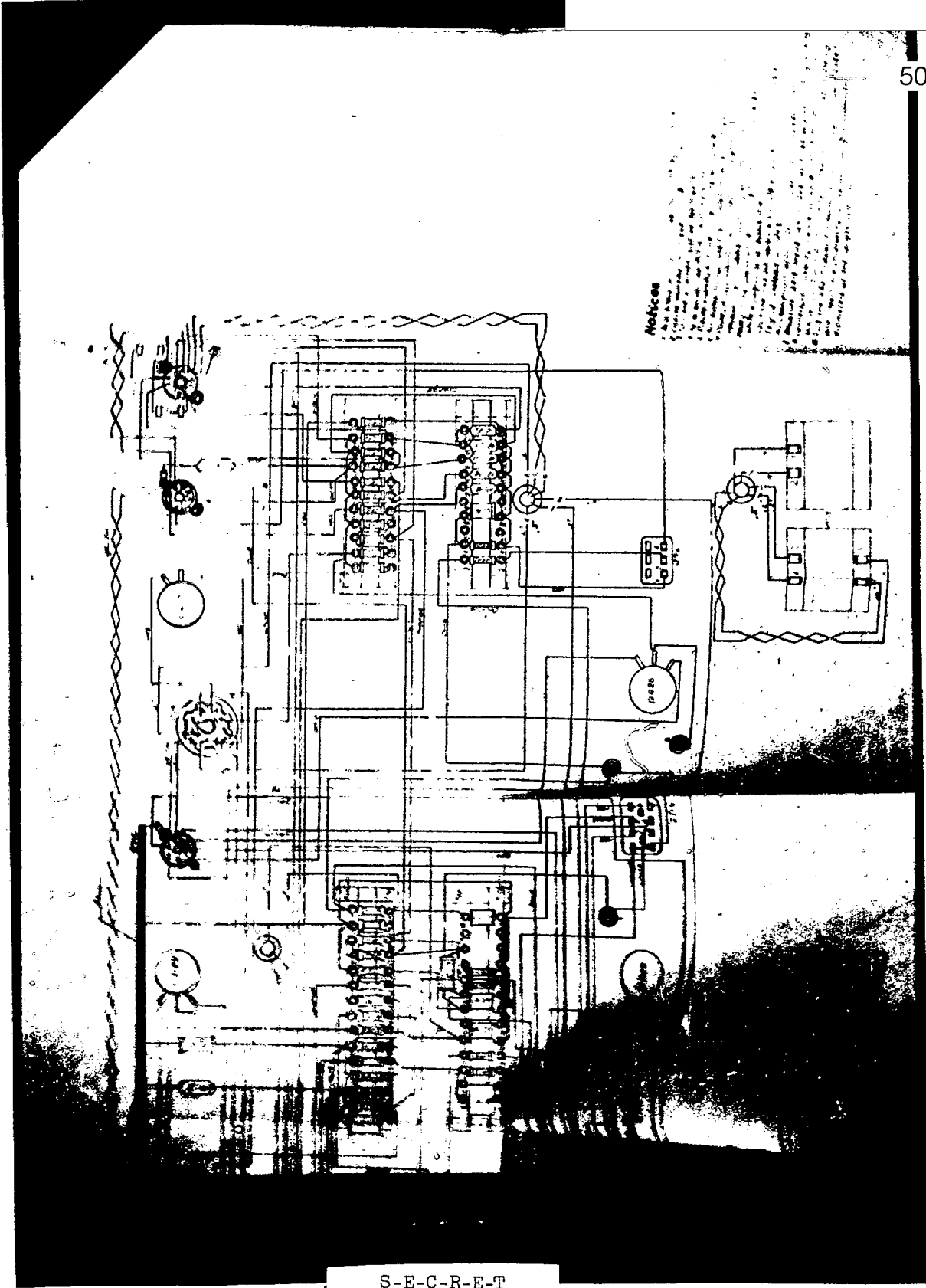

Notice

S-E-C-R-E-T

NO FOREIGN DISSEM

S-E-C-R-E-T
NO FOREIGN DISSEM

50X1

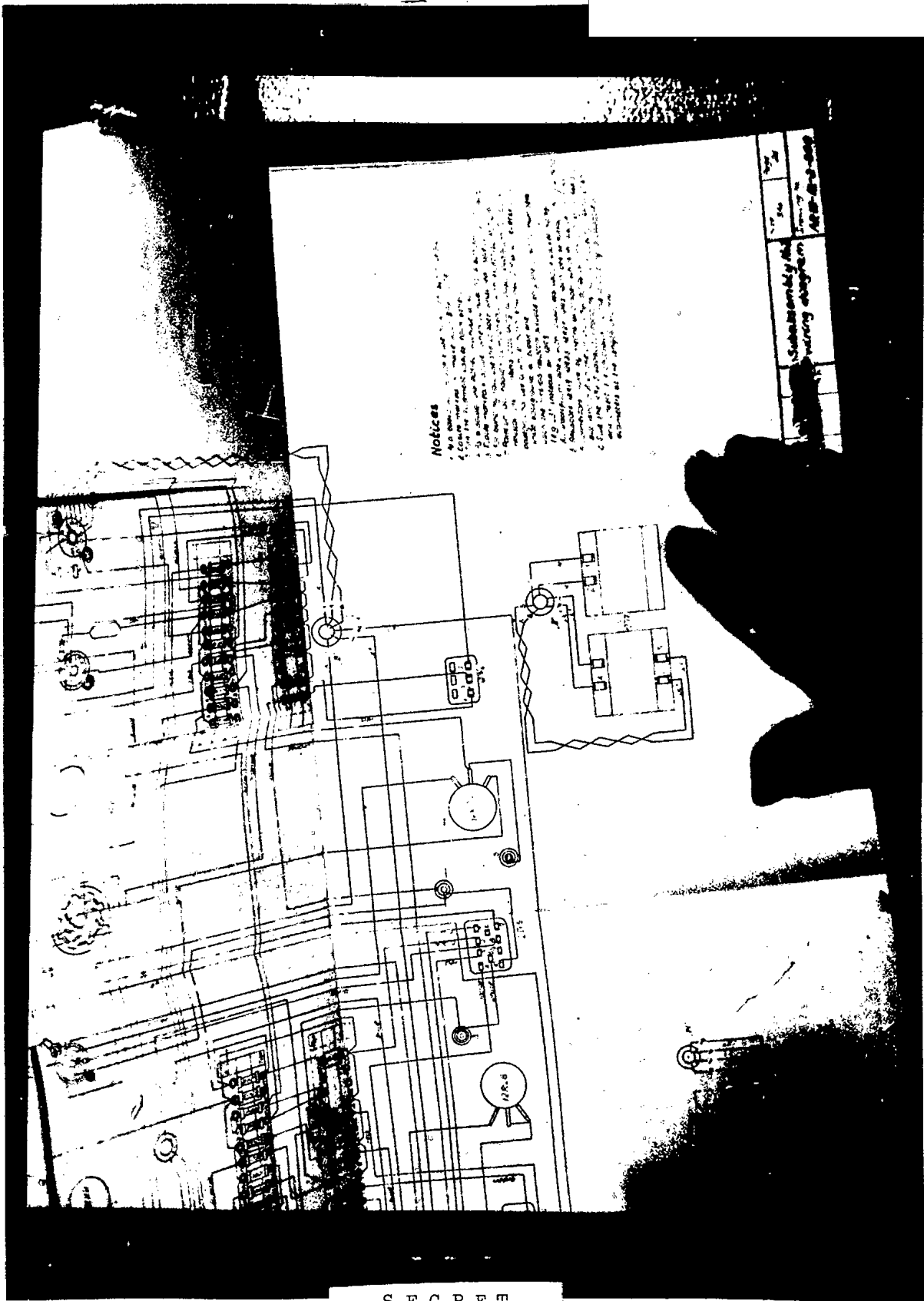

S-E-C-R-E-T
NO FOREIGN DISSEM

S-E-C-R-E-T
NO FOREIGN DISSEM



50X1

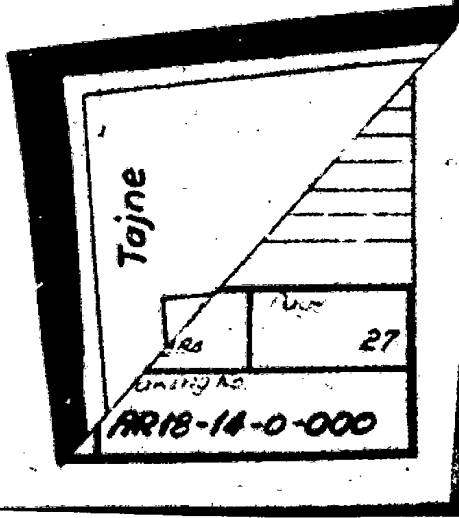
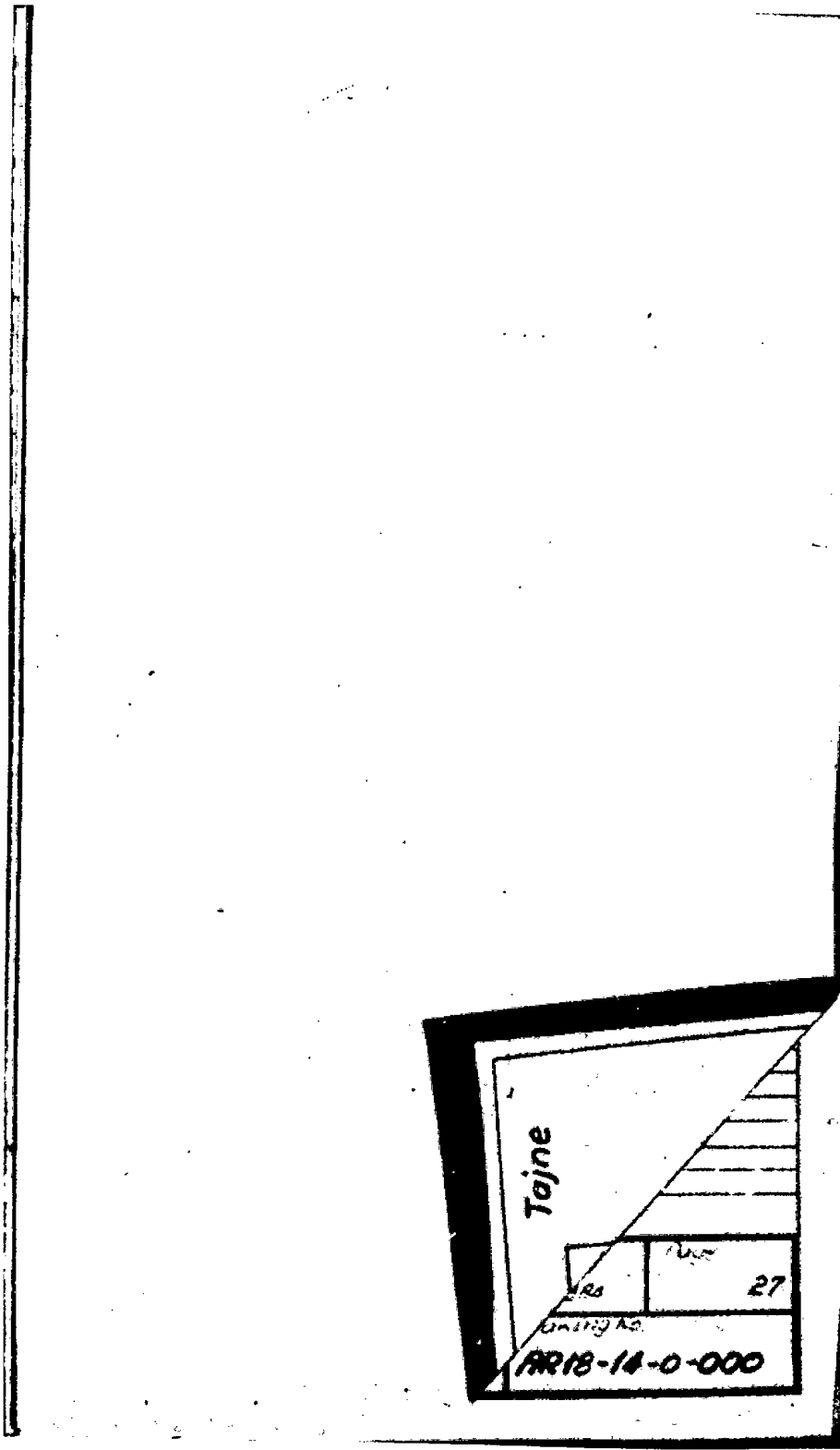

S-E-C-R-E-T
NO FOREIGN DISSEM

S-E-C-R-E-T
NO FOREIGN DISSEM

50X1

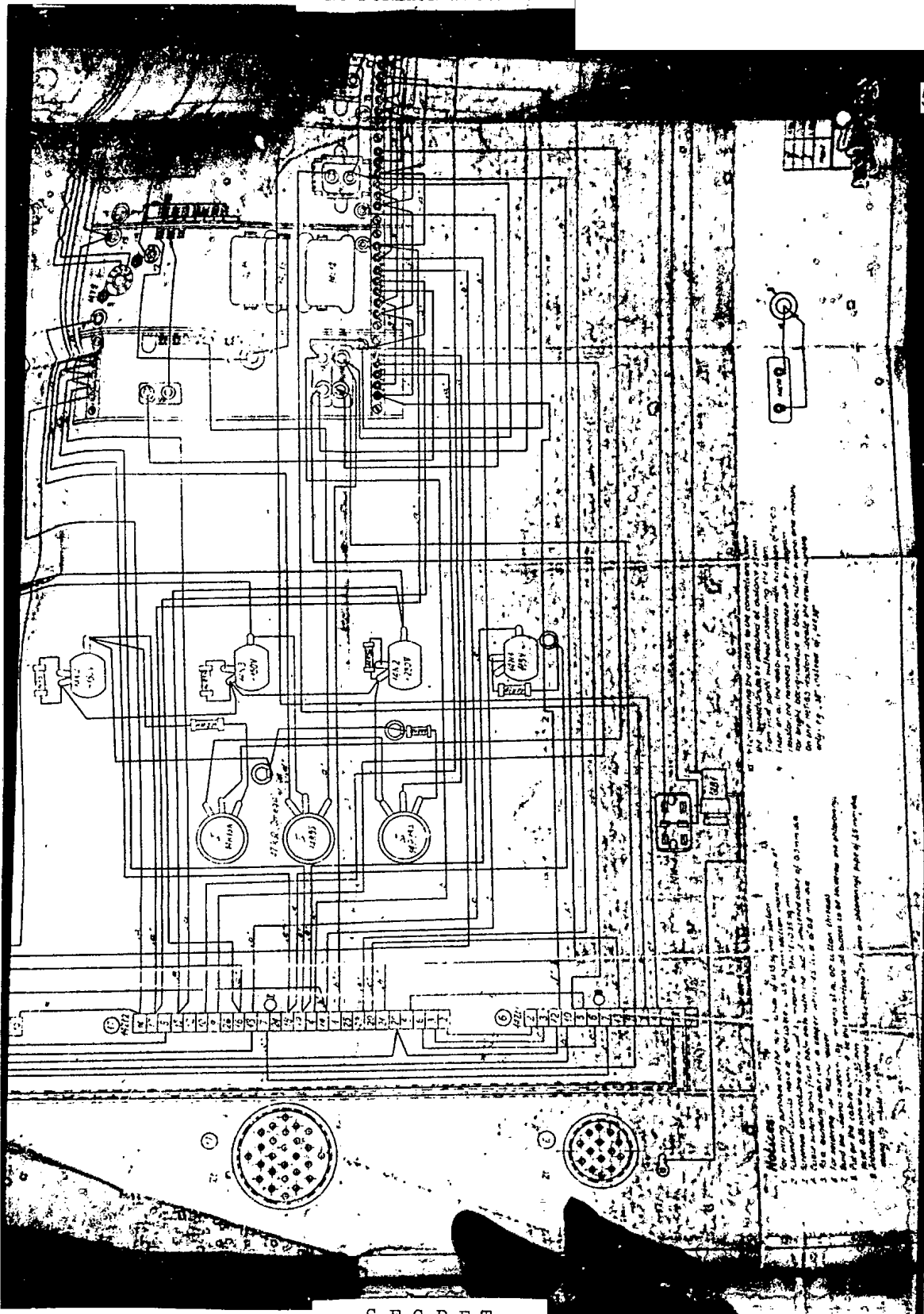

NOTES:
 1. For many cables use the same 1/4" x 1/2" x 1/2" size.
 2. For many cables use the same 1/4" x 1/2" x 1/2" size.
 3. For many cables use the same 1/4" x 1/2" x 1/2" size.
 4. For many cables use the same 1/4" x 1/2" x 1/2" size.
 5. For many cables use the same 1/4" x 1/2" x 1/2" size.
 6. For many cables use the same 1/4" x 1/2" x 1/2" size.
 7. For many cables use the same 1/4" x 1/2" x 1/2" size.
 8. For many cables use the same 1/4" x 1/2" x 1/2" size.
 9. For many cables use the same 1/4" x 1/2" x 1/2" size.
 10. For many cables use the same 1/4" x 1/2" x 1/2" size.

NOTES:
 1. For many cables use the same 1/4" x 1/2" x 1/2" size.
 2. For many cables use the same 1/4" x 1/2" x 1/2" size.
 3. For many cables use the same 1/4" x 1/2" x 1/2" size.
 4. For many cables use the same 1/4" x 1/2" x 1/2" size.
 5. For many cables use the same 1/4" x 1/2" x 1/2" size.
 6. For many cables use the same 1/4" x 1/2" x 1/2" size.
 7. For many cables use the same 1/4" x 1/2" x 1/2" size.
 8. For many cables use the same 1/4" x 1/2" x 1/2" size.
 9. For many cables use the same 1/4" x 1/2" x 1/2" size.
 10. For many cables use the same 1/4" x 1/2" x 1/2" size.

S-E-C-R-E-T
NO FOREIGN DISSEM

136

S-E-C-R-E-T
NO FOREIGN DISSEM

50X1

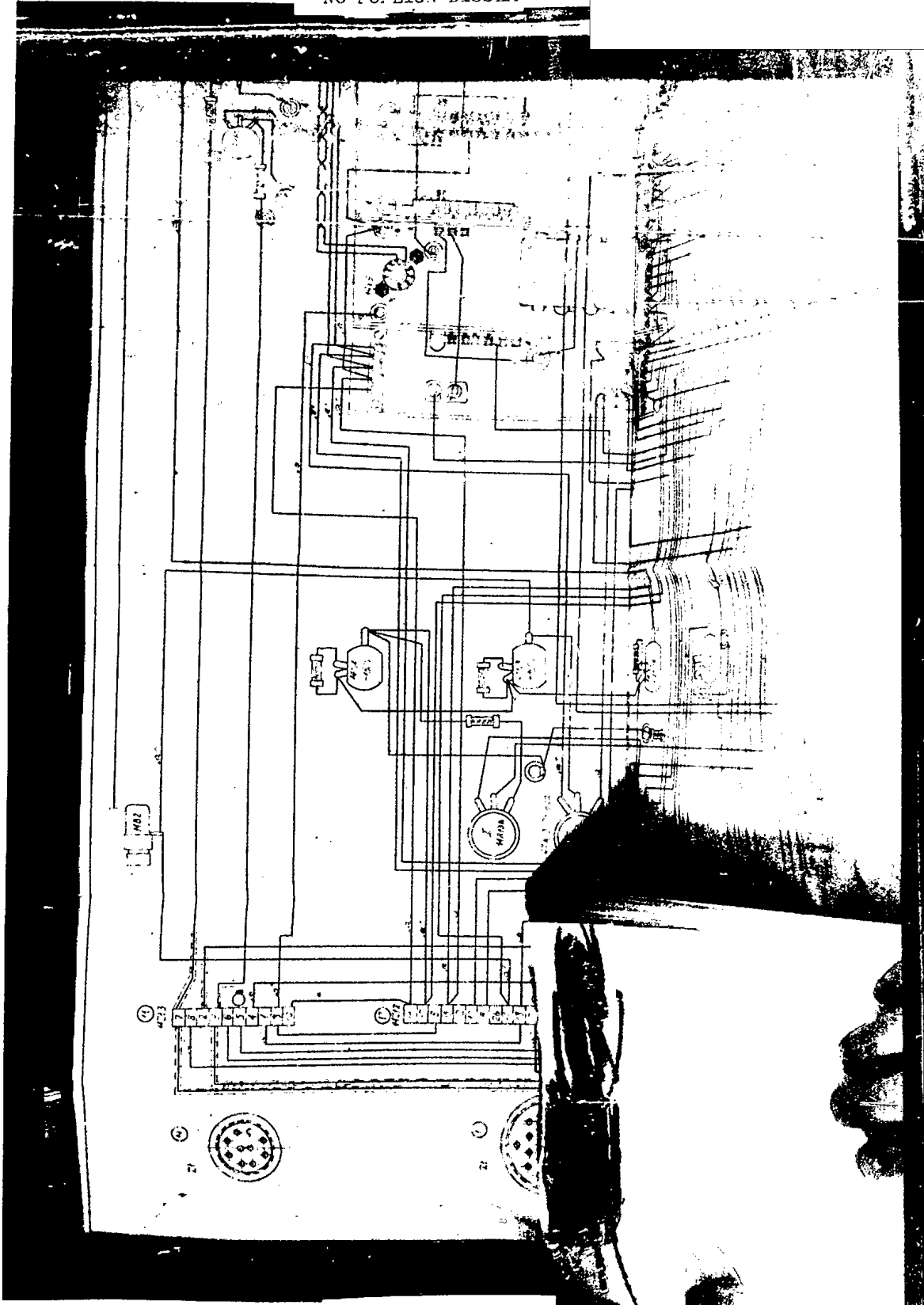

S-E-C-R-E-T

NO FOREIGN DISSEM

S-E-C-P-E-T
NO FOREIGN DISSEM

50X1

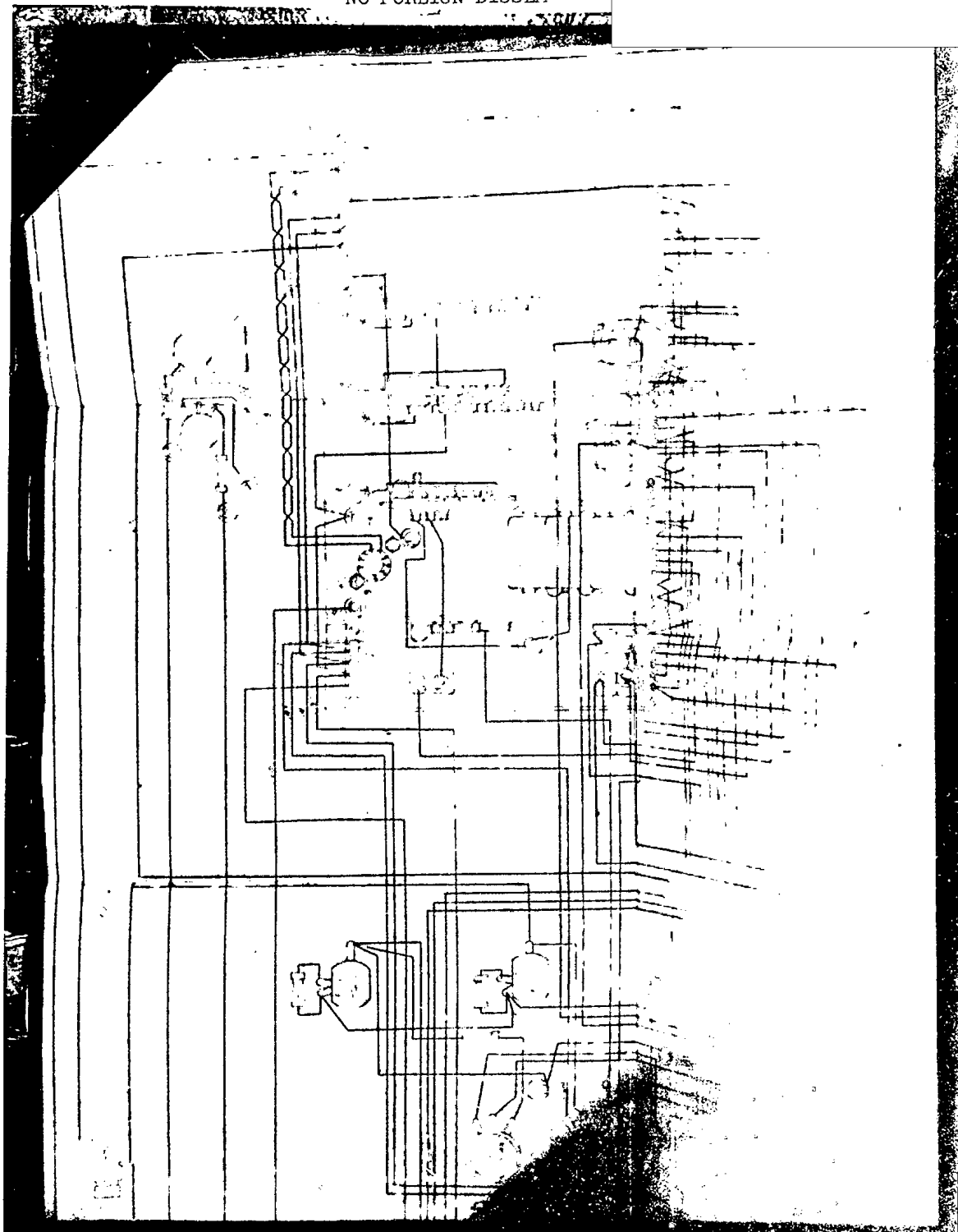

S-E-C-R-E-T

NO FOREIGN DISSEM

S-E-C-R-E-T
NO FOREIGN DISSEM

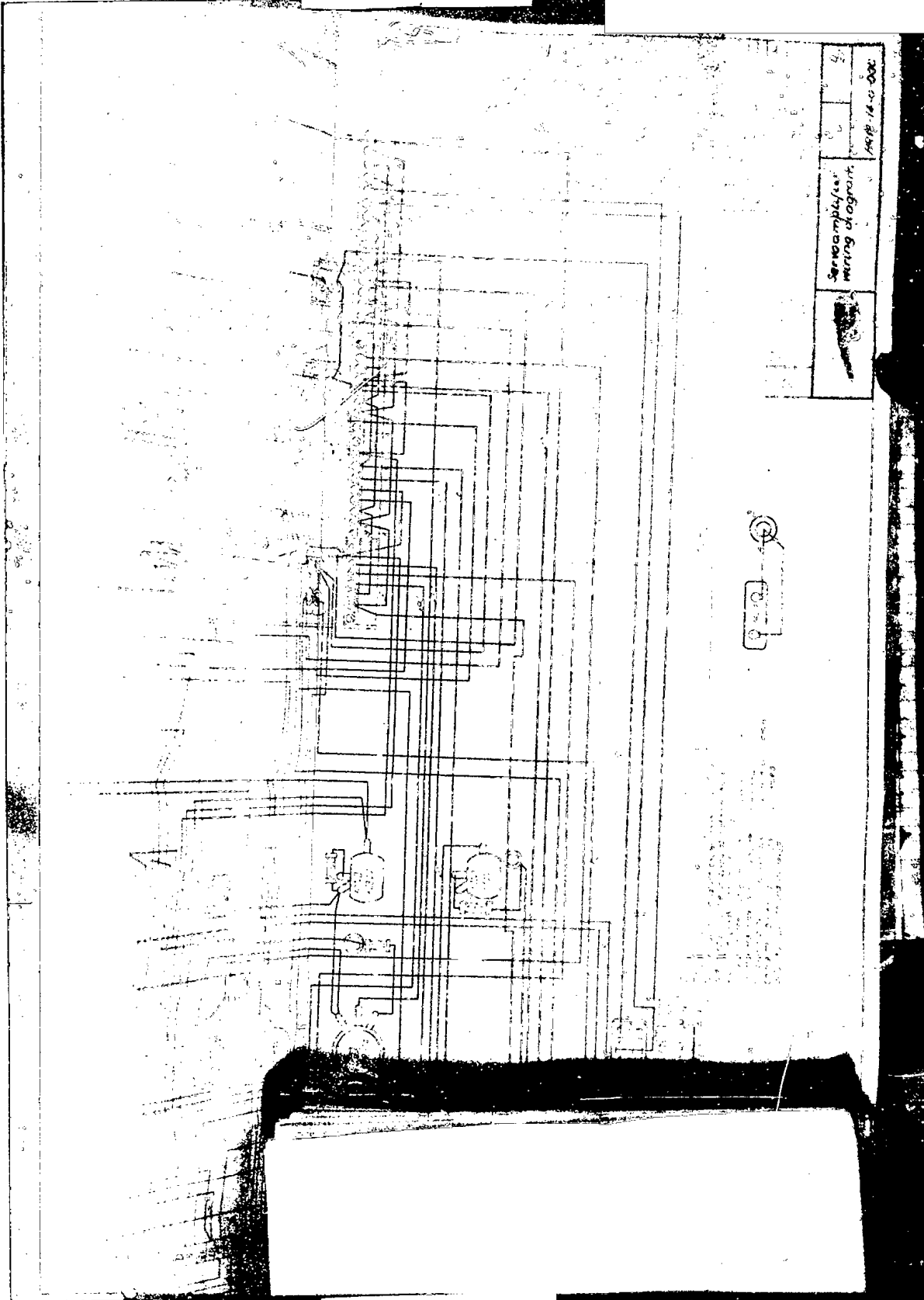

Serials	4
Drawings	
Wiring Diagram	
1948-16-50 Doc	

50X1

S-E-C-R-E-T
NO FOREIGN DISSEM

S-E-C-R-E-T
NO FOREIGN DISSEM



50X1

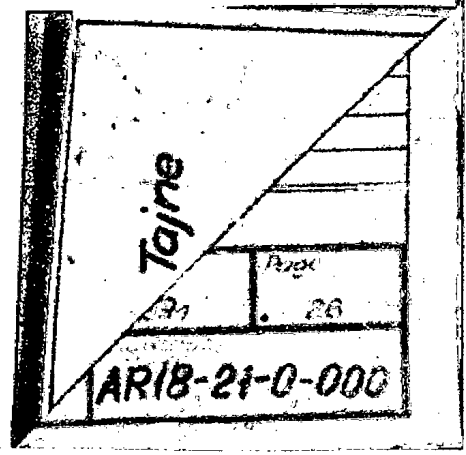

S-E-C-R-E-T
NO FOREIGN DISSEM

S-E-C-R-E-T
NO FOREIGN DISSEM

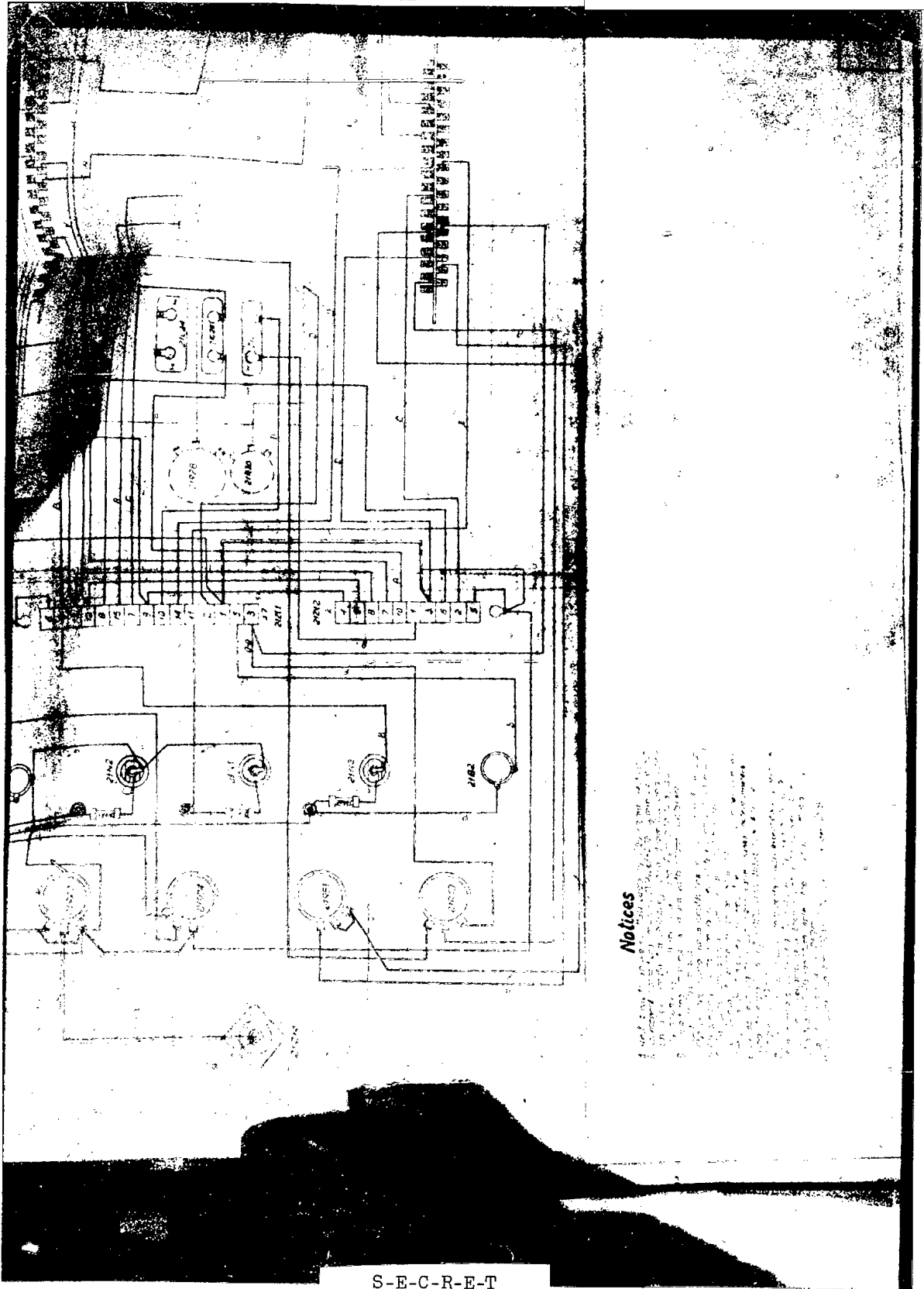

50X1

Notices

S-E-C-R-E-T

NO FOREIGN DISSEM

S-E-C-R-E-T
NO FOREIGN DISSEM

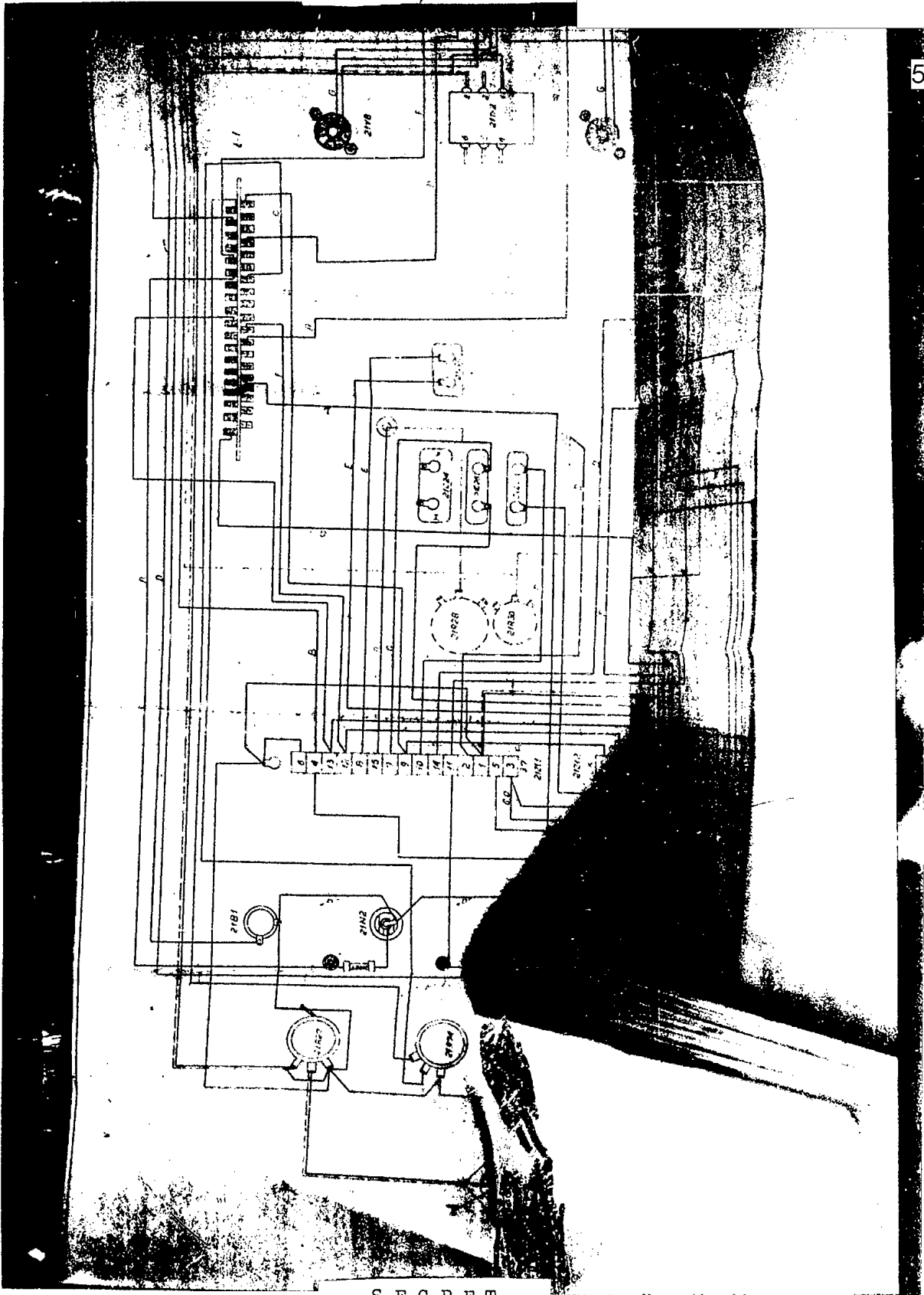

50X1

S-E-C-R-E-T
NO FOREIGN DISSEM

S-E-C-R-E-T
NO FOREIGN DISSEM

50X1

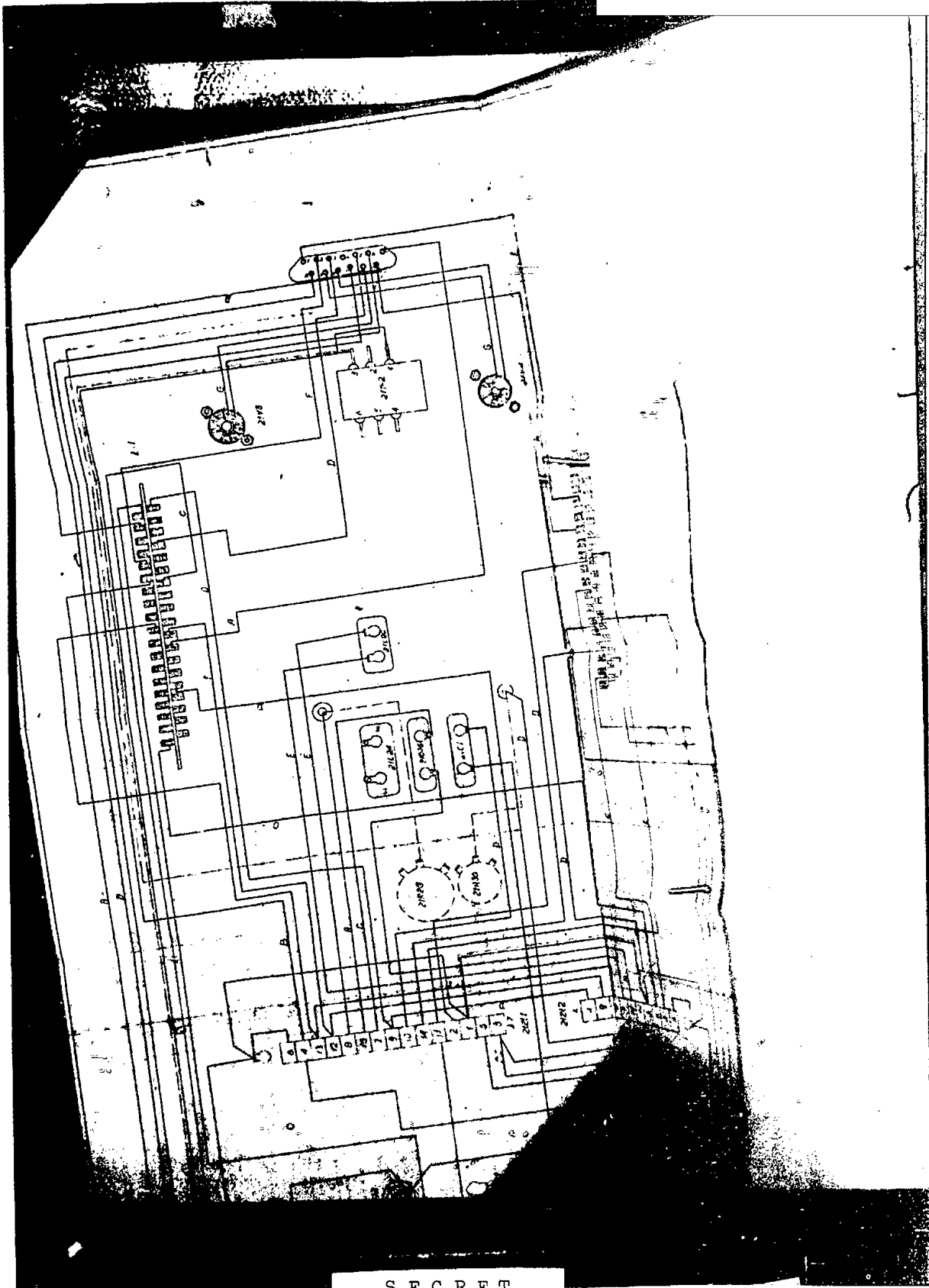

S-E-C-R-E-T
NO FOREIGN DISSEM

S-E-C-R-E-T
NO FOREIGN DISSEM

50X1

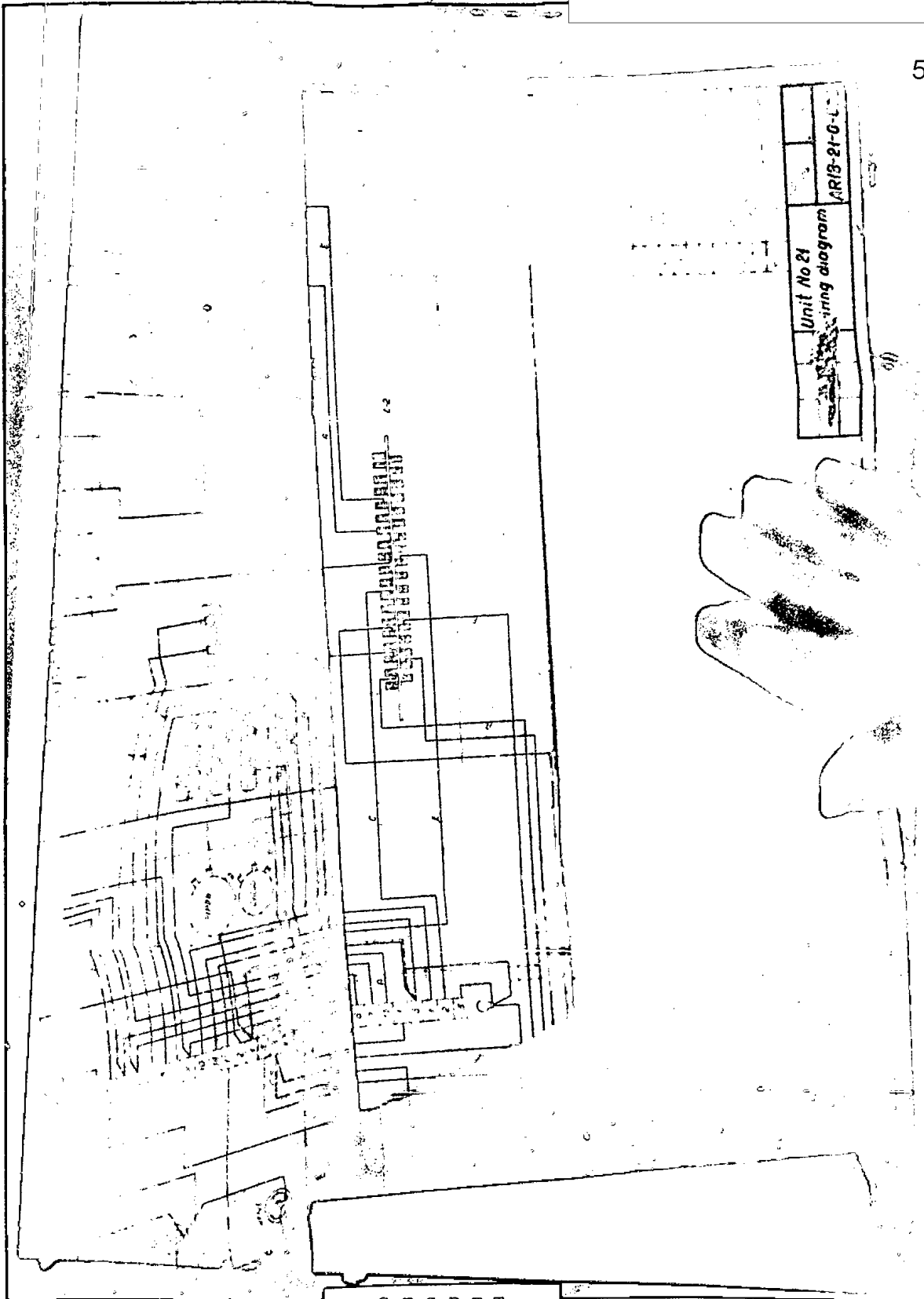

Unit No 21	ing diagram	ARIS-21-0-1
------------	-------------	-------------

S-E-C-R-E-T

NO FOREIGN DISSEM

S-E-C-R-E-T
NO FOREIGN DISSEM

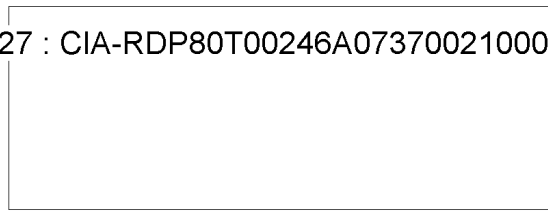

50X1

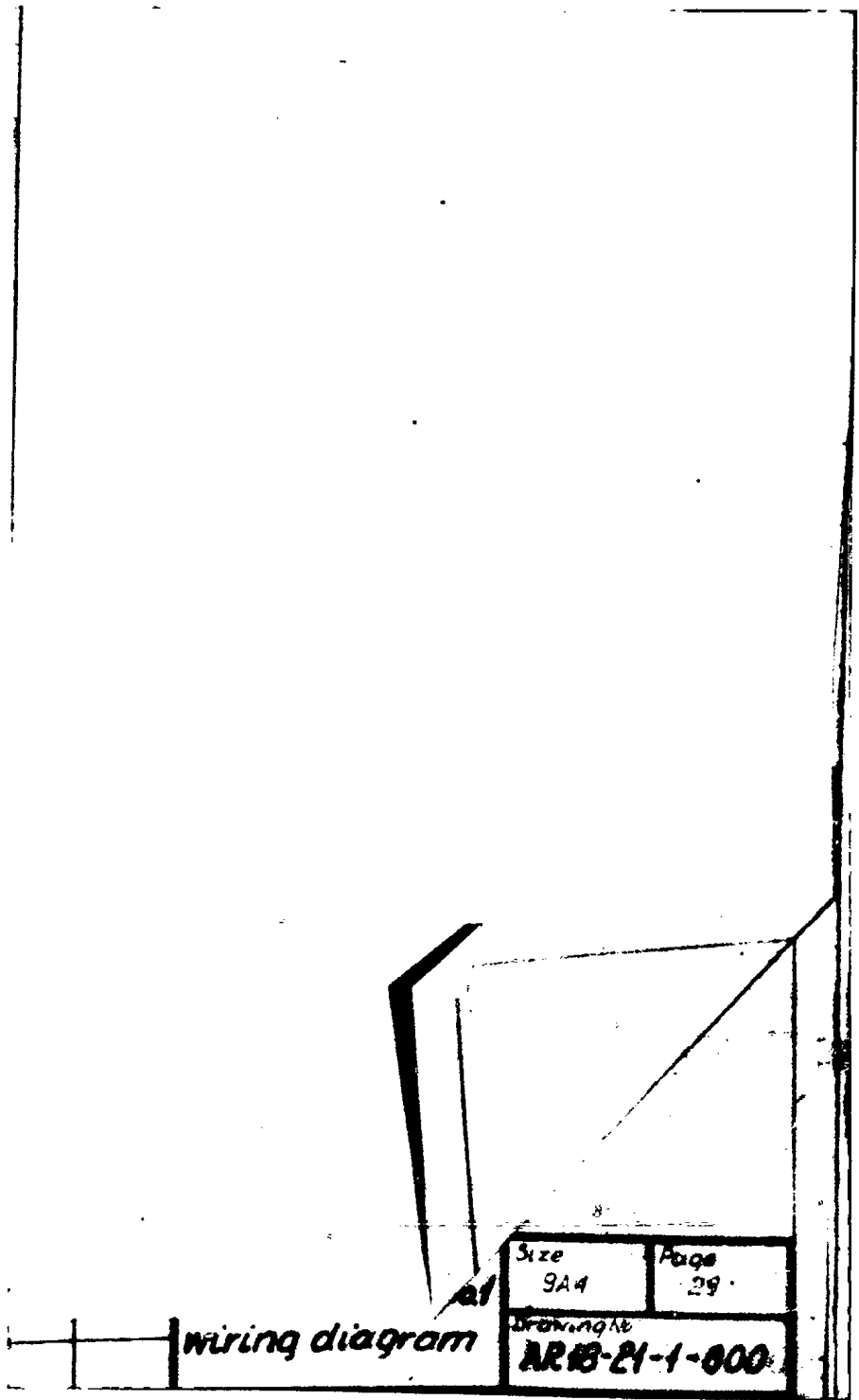

S-E-C-R-E-T
NO FOREIGN DISSEM

10

S-E-C-R-E-T
NO FOREIGN DISSEM

50X1

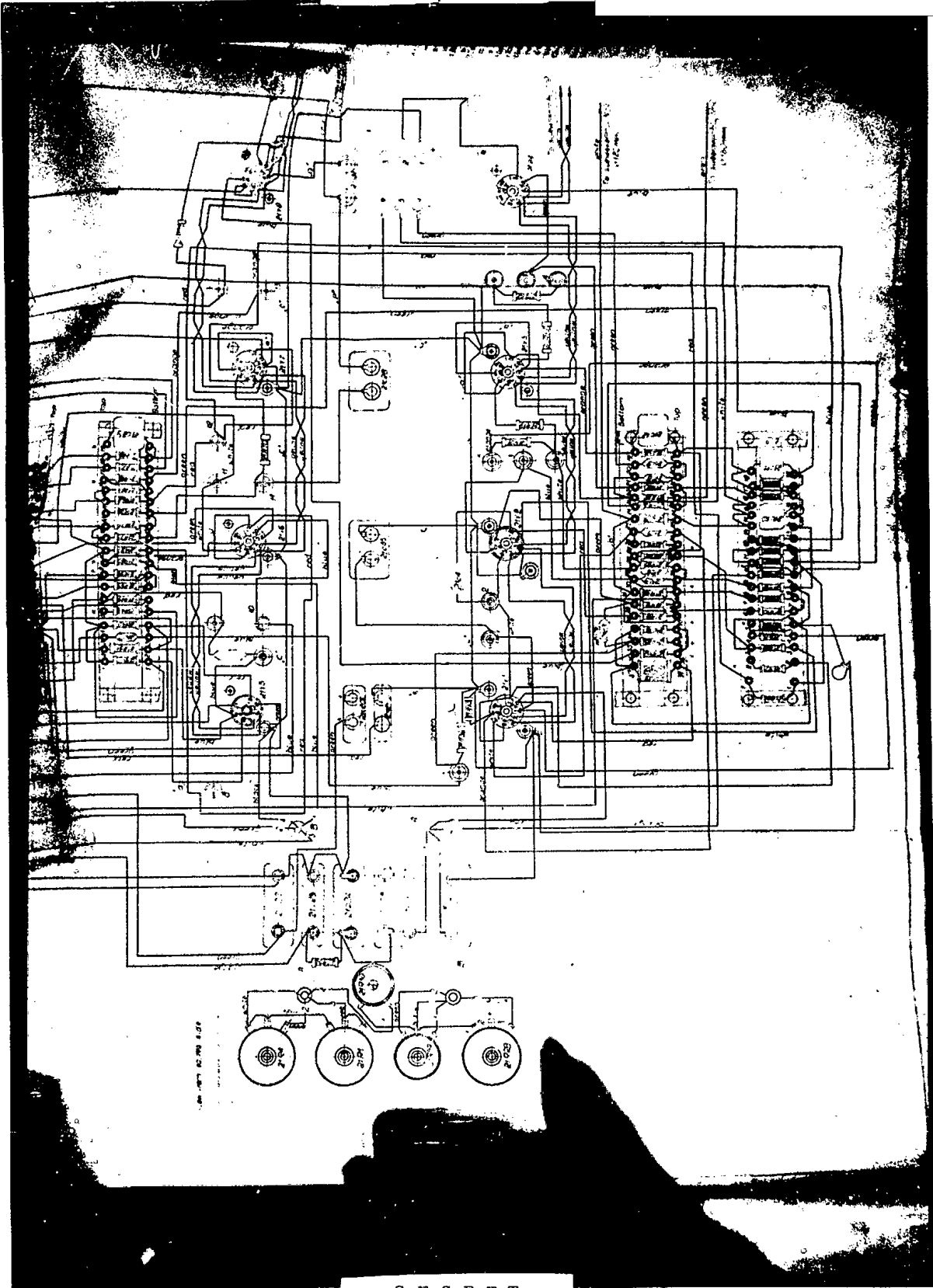

S-E-C-R-E-T
NO FOREIGN DISSEM

S-E-C-R-E-T
NO FOREIGN DISSEM

50X1

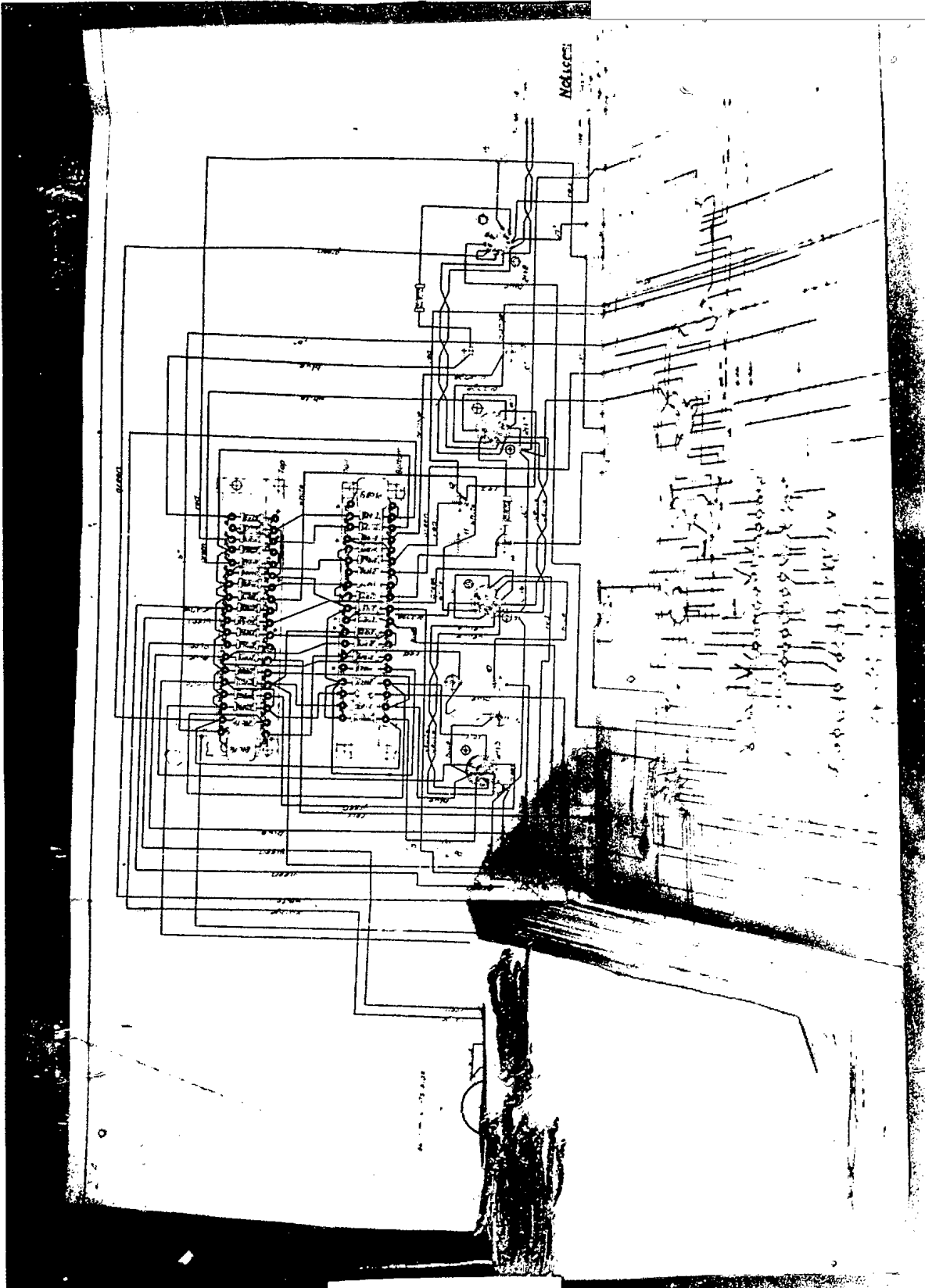

S-E-C-R-E-T

NO FOREIGN DISSEM

S-E-C-P-E-T
NO FOREIGN DISSEM

50X1

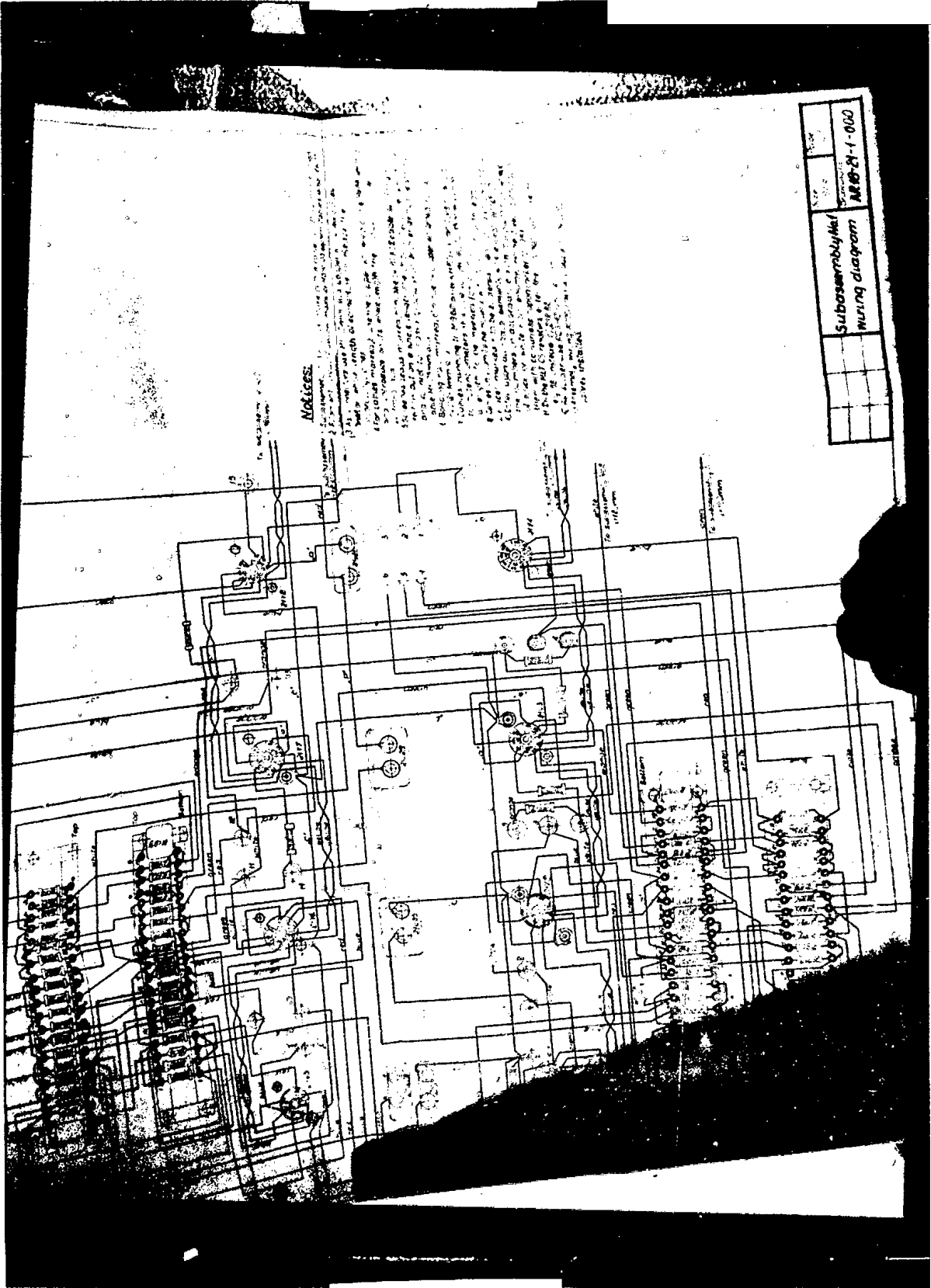

S-E-C-R-E-T

NO FOREIGN DISSEM

S-E-C-R-E-T
NO FOREIGN DISSEM

50X1

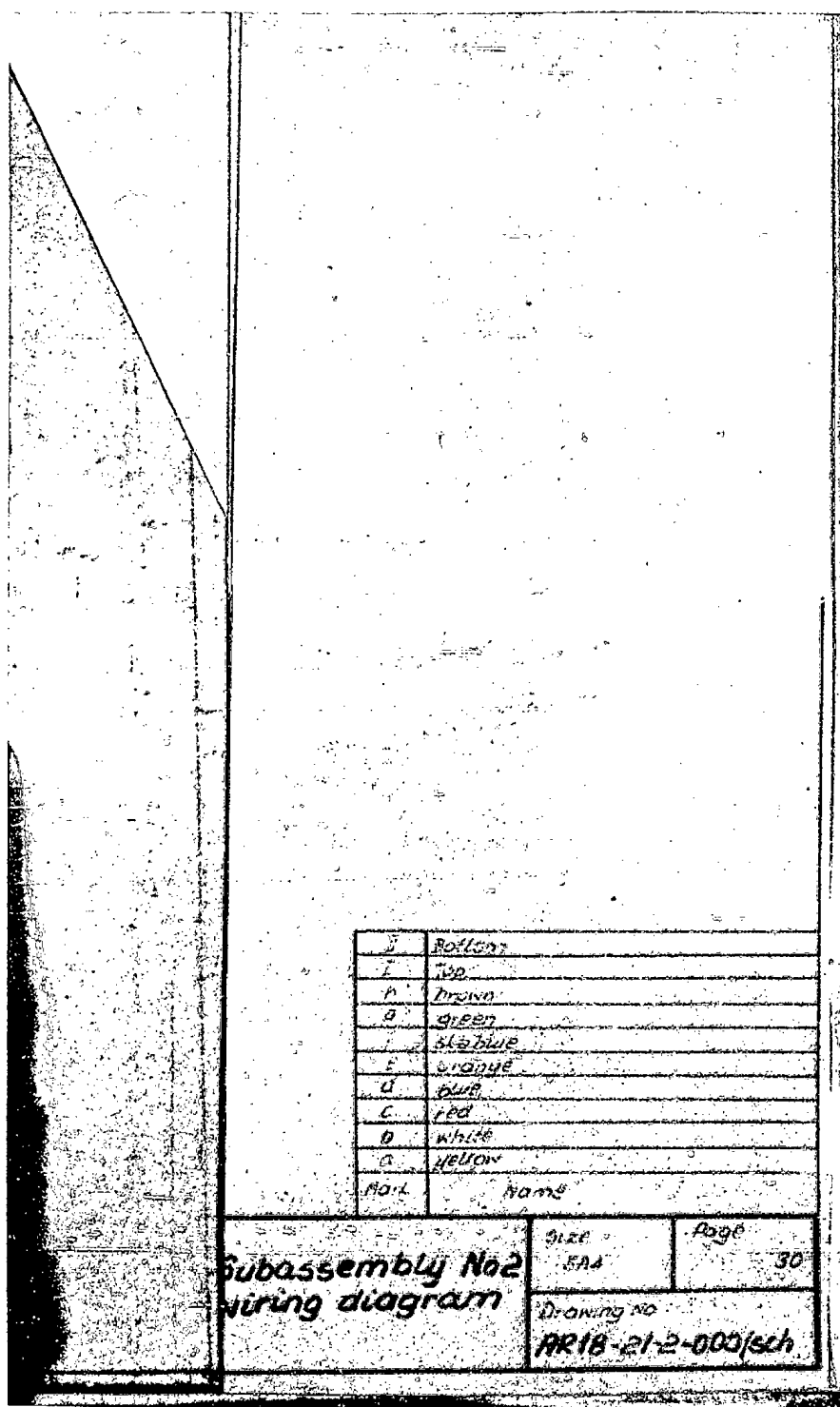

Subassembly No 2
Wiring diagram

Size	5A4	Page	30
Drawing No	AR18-21-2-000/sch		

S-E-C-R-E-T
NO FOREIGN DISSEM

49

S-E-C-R-E-T
NO FOREIGN DISSEM

50X1

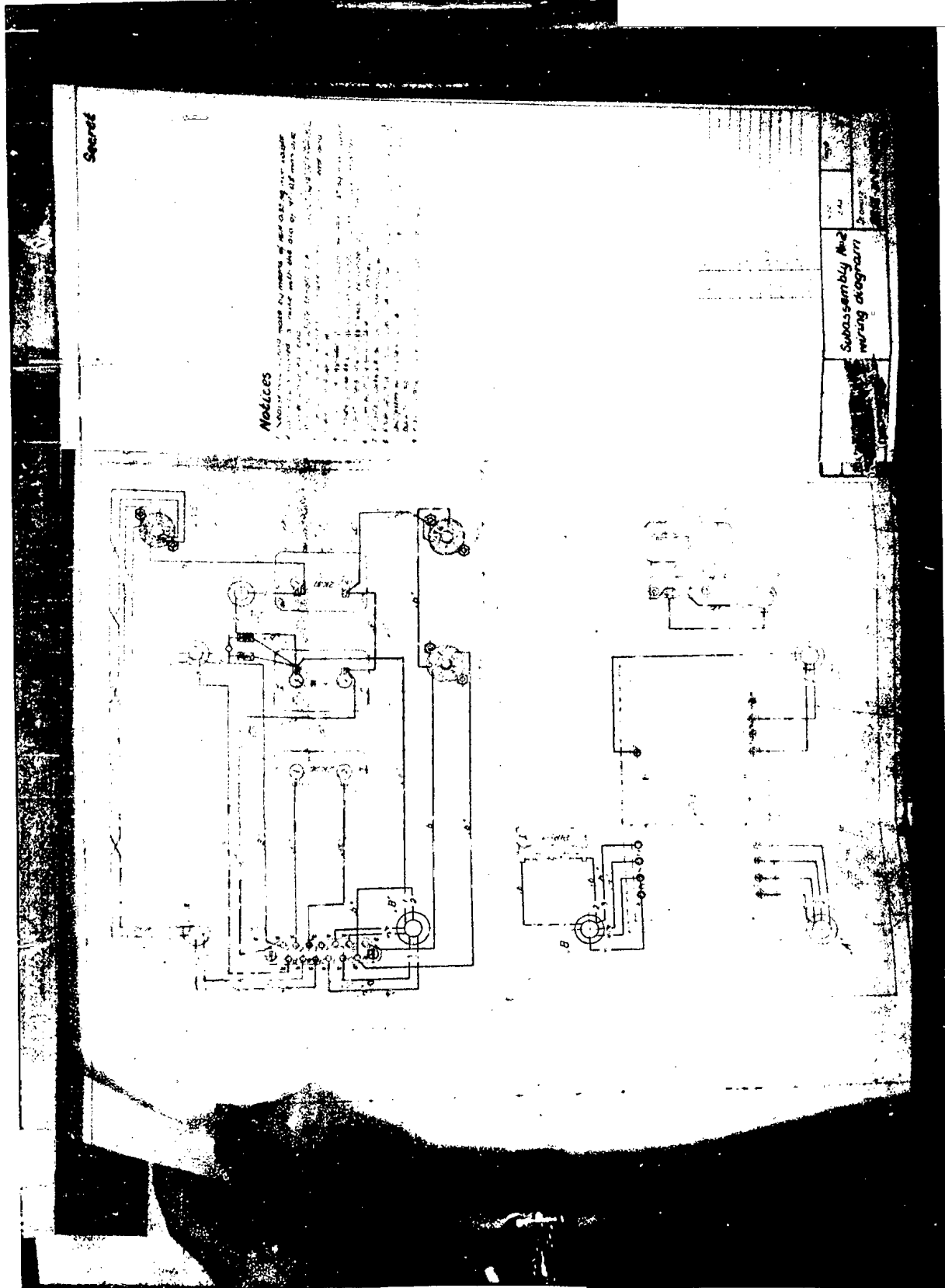

S-E-C-R-E-T
NO FOREIGN DISSEM

S-E-C-R-E-T
NO FOREIGN DISSEM

50X1

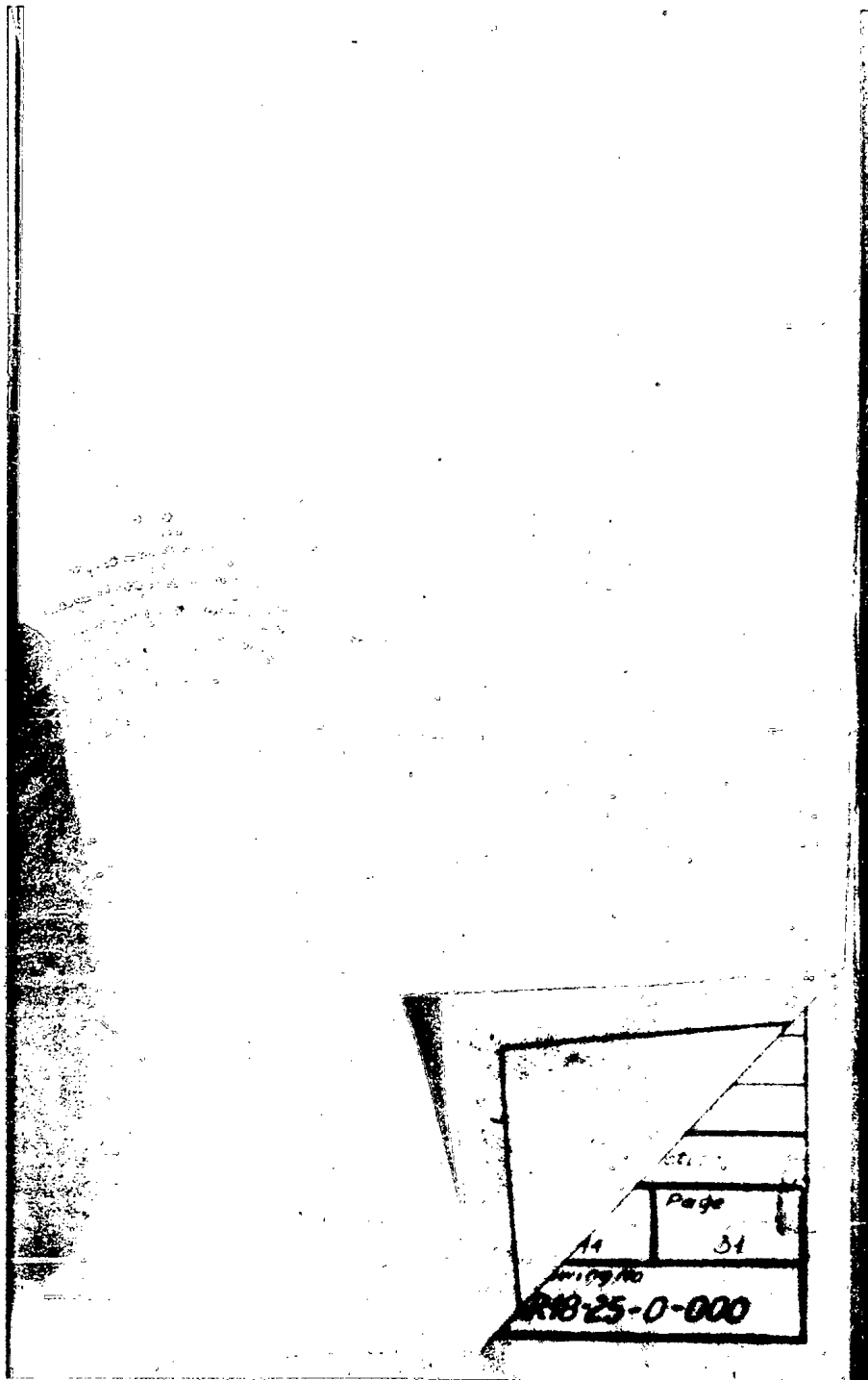

Title	
Page	
14	31
R18-25-0-000	

S-E-C-R-E-T
NO FOREIGN DISSEM

S-E-C-R-E-T
NO FOREIGN DISSEM

50X1

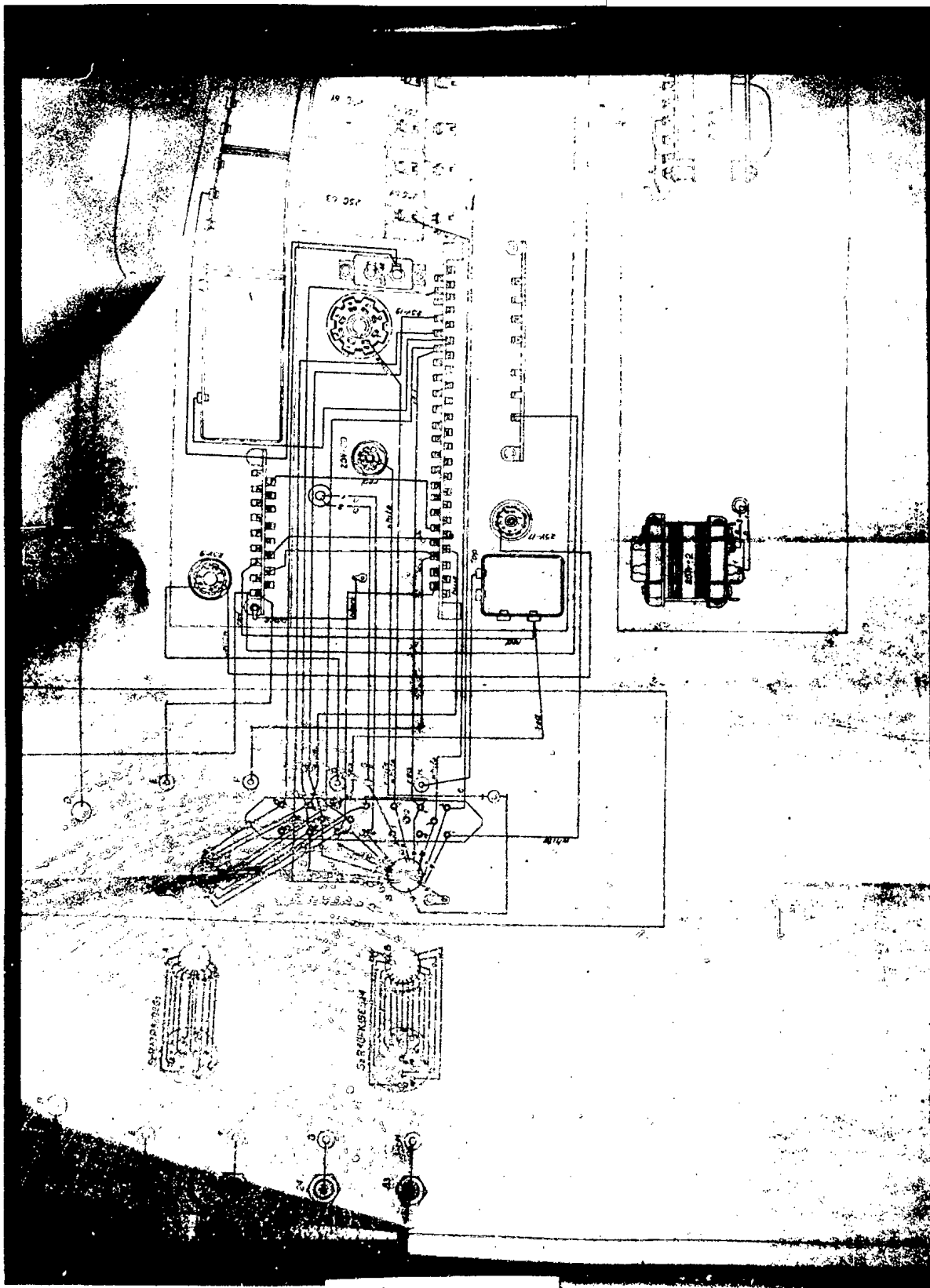

S-E-C-R-E-T

NO FOREIGN DISSEM

SECRET
NO FOREIGN DISSEM

50X1

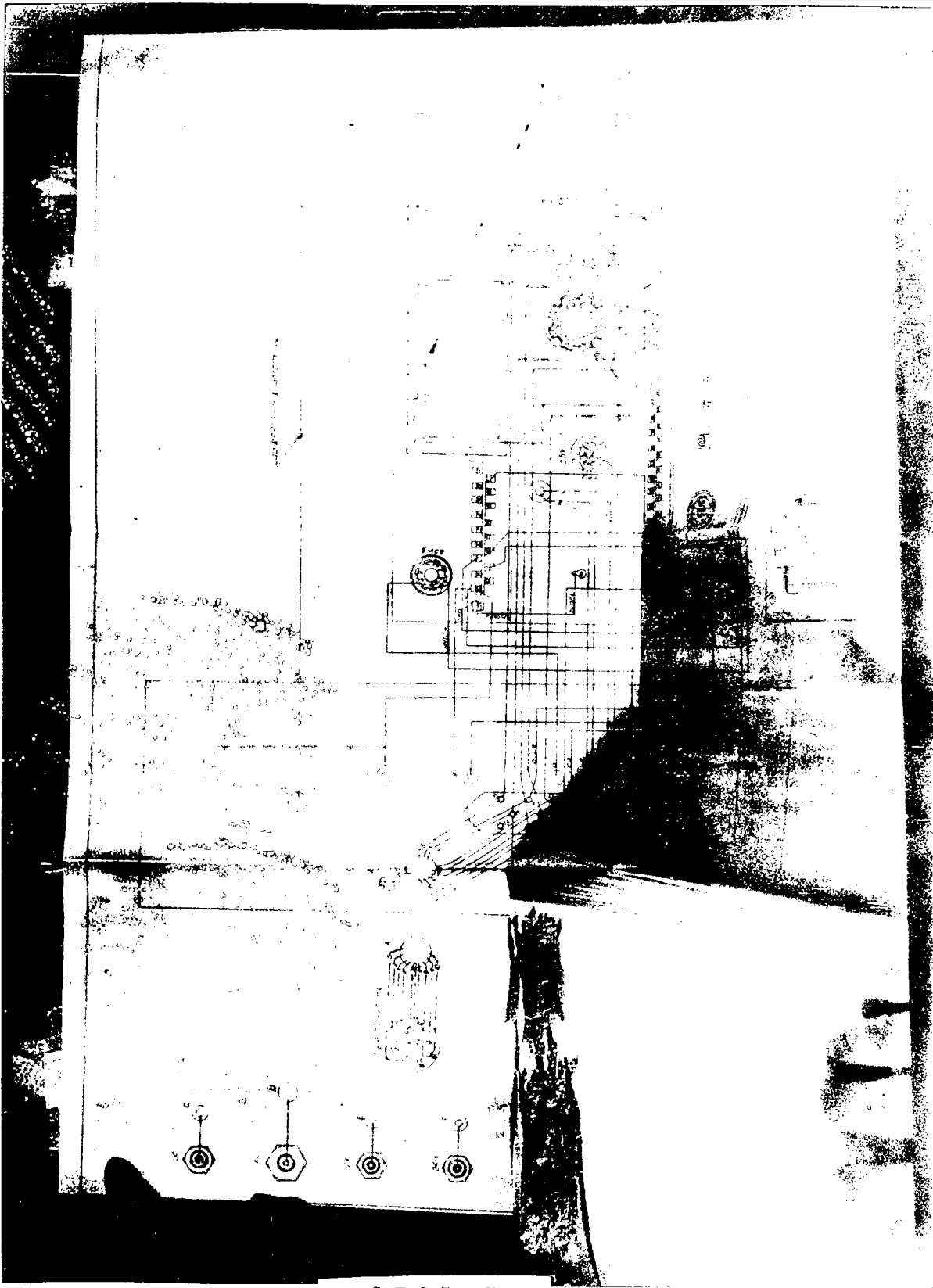

S-E-C-R-E-T

NO FOREIGN DISSEM



S-E-C-R-E-T
NO FOREIGN DISSEM

50X1

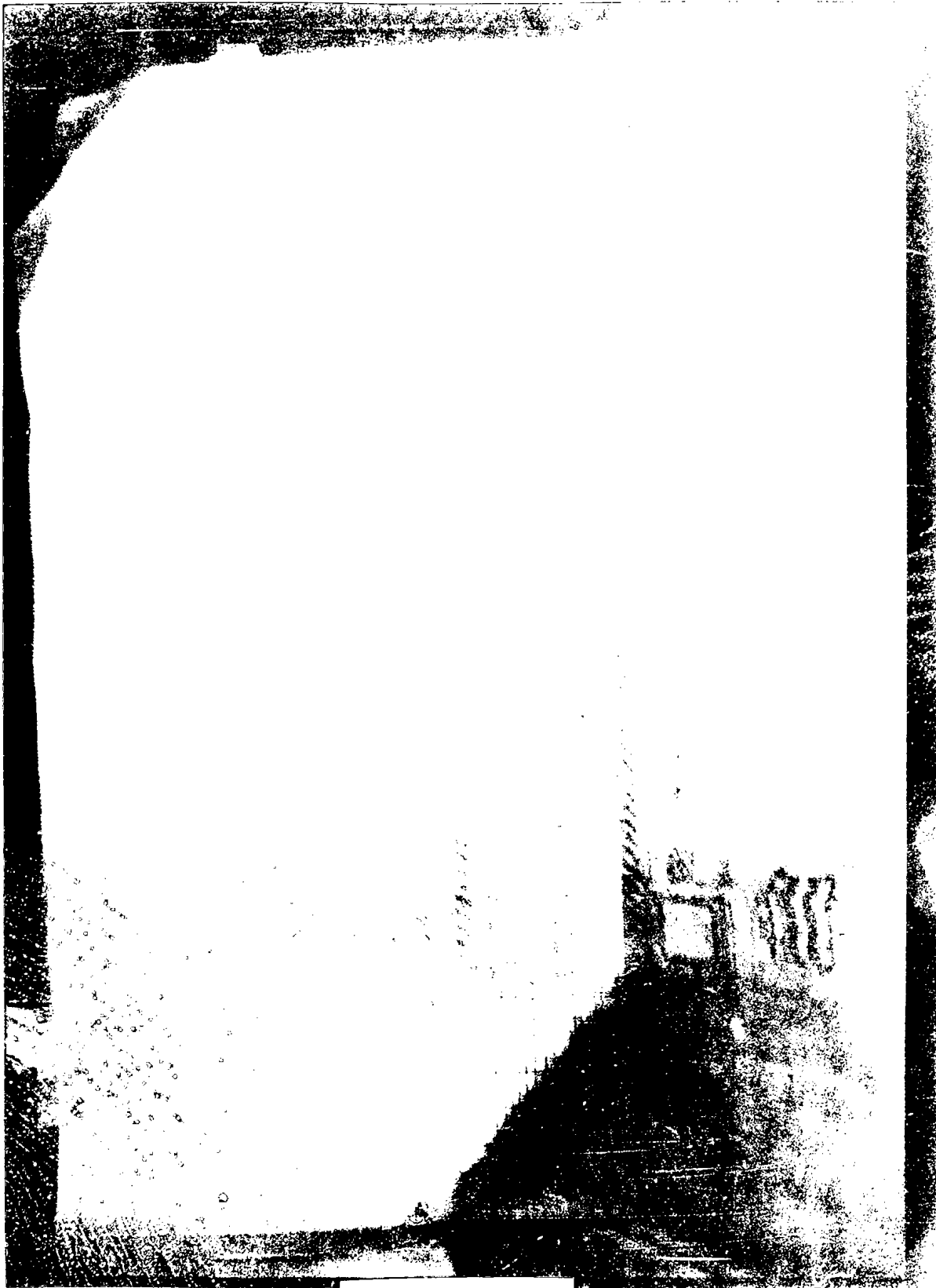

S-E-C-R-E-T

NO FOREIGN DISSEM

S-E-C-R-E-T
NO FOREIGN DISSEM

50X1

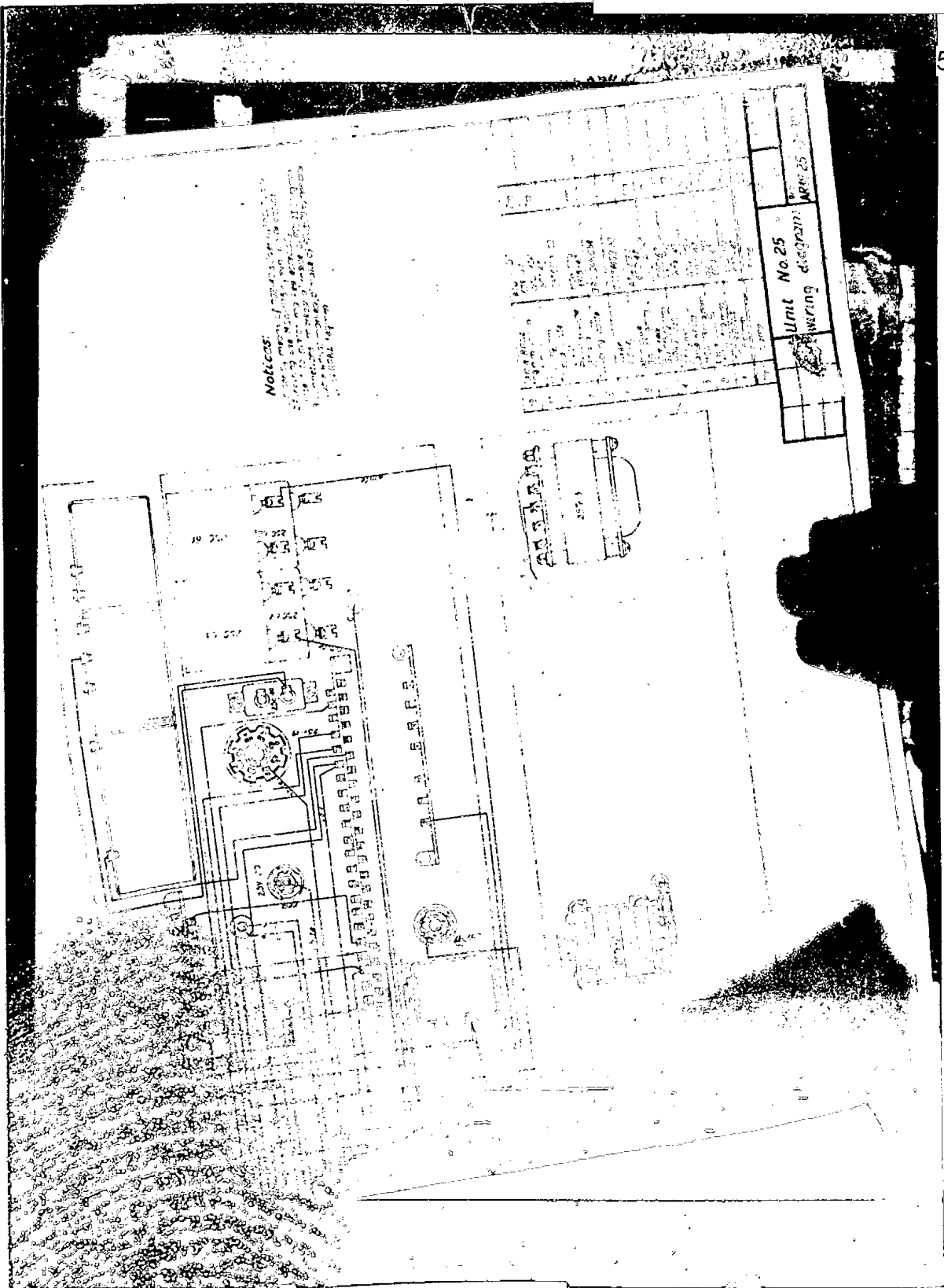

S-E-C-R-E-T
NO FOREIGN DISSEM

S-E-C-R-E-T
NO FOREIGN DISSEM

50X1

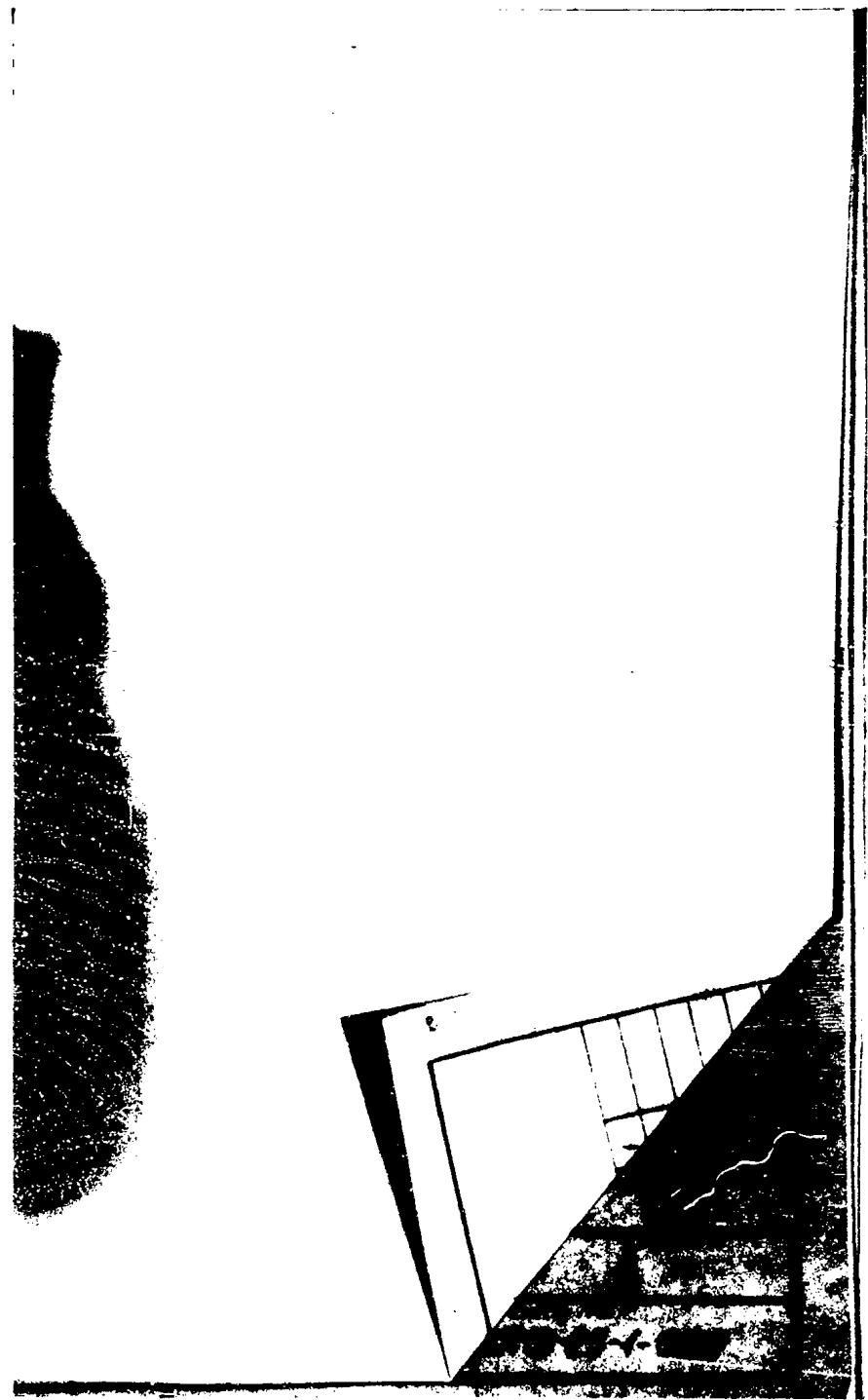

S-E-C-R-E-T
NO FOREIGN DISSEM

S-E-C-R-E-T
NO FOREIGN DISSEM

50X1

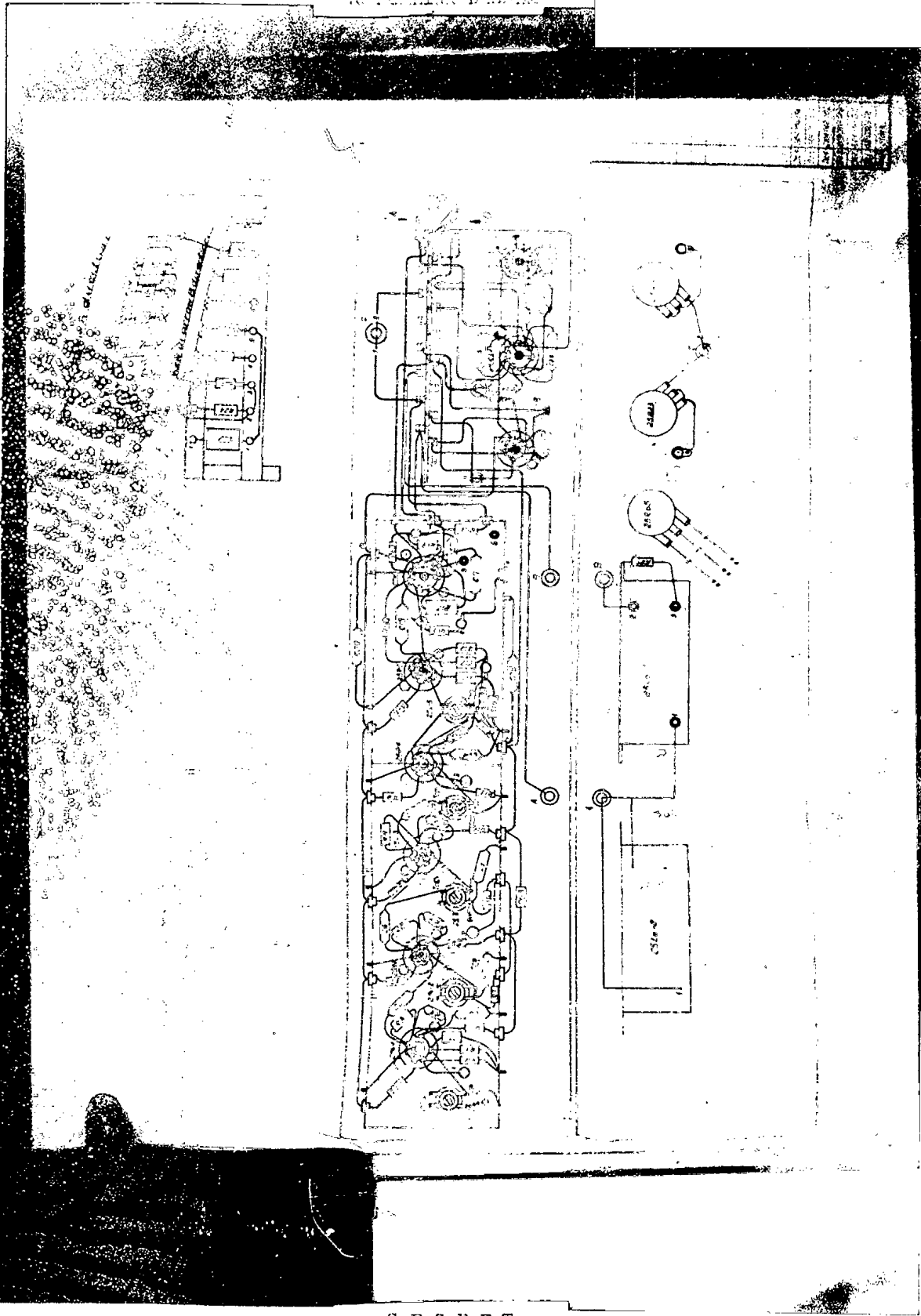

S-E-C-R-E-T

NO FOREIGN DISSEM

S-E-C-R-E-T
NO FOREIGN DISSEM

50X1

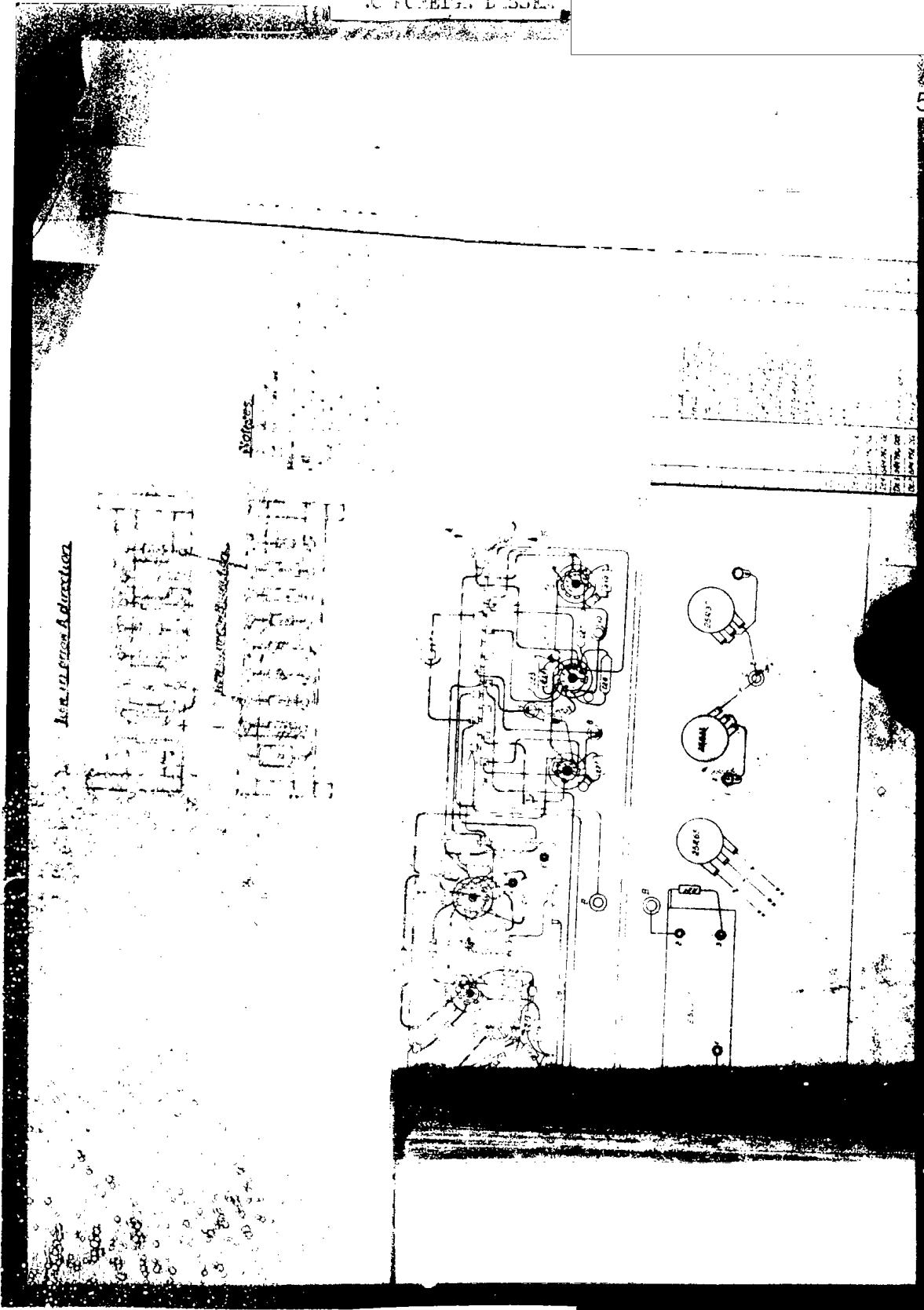

S-E-C-R-E-T

NO FOREIGN DISSEM

S-E-C-R-E-T
NO FOREIGN DISSEM

50X1

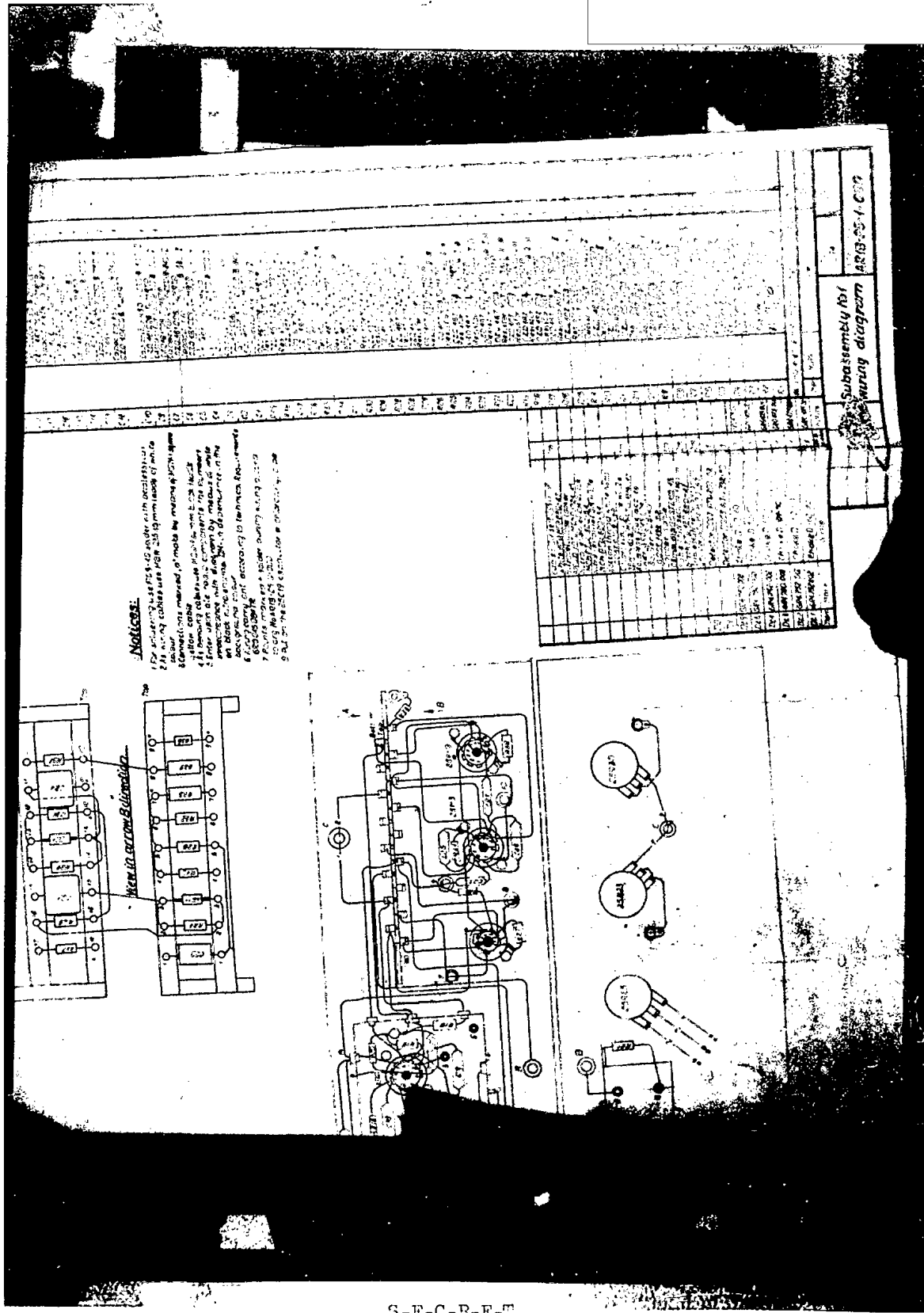

Notices:

1. The drawing is to be used only under strict instructions.
2. All work shall be done in accordance with the instructions.
3. Connections measured, or made by means of a continuity tester, shall be made in accordance with the instructions.
4. All work shall be done in accordance with the instructions.
5. All work shall be done in accordance with the instructions.
6. All work shall be done in accordance with the instructions.
7. All work shall be done in accordance with the instructions.
8. All work shall be done in accordance with the instructions.
9. All work shall be done in accordance with the instructions.
10. All work shall be done in accordance with the instructions.

Subassembly for
Wiring diagram
AR19-55-1-C09

S-E-C-R-E-T

NO FOREIGN DISSEM

S-E-C-R-E-T
NO FOREIGN DISSEM

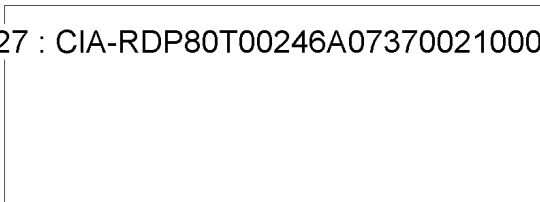

50X1

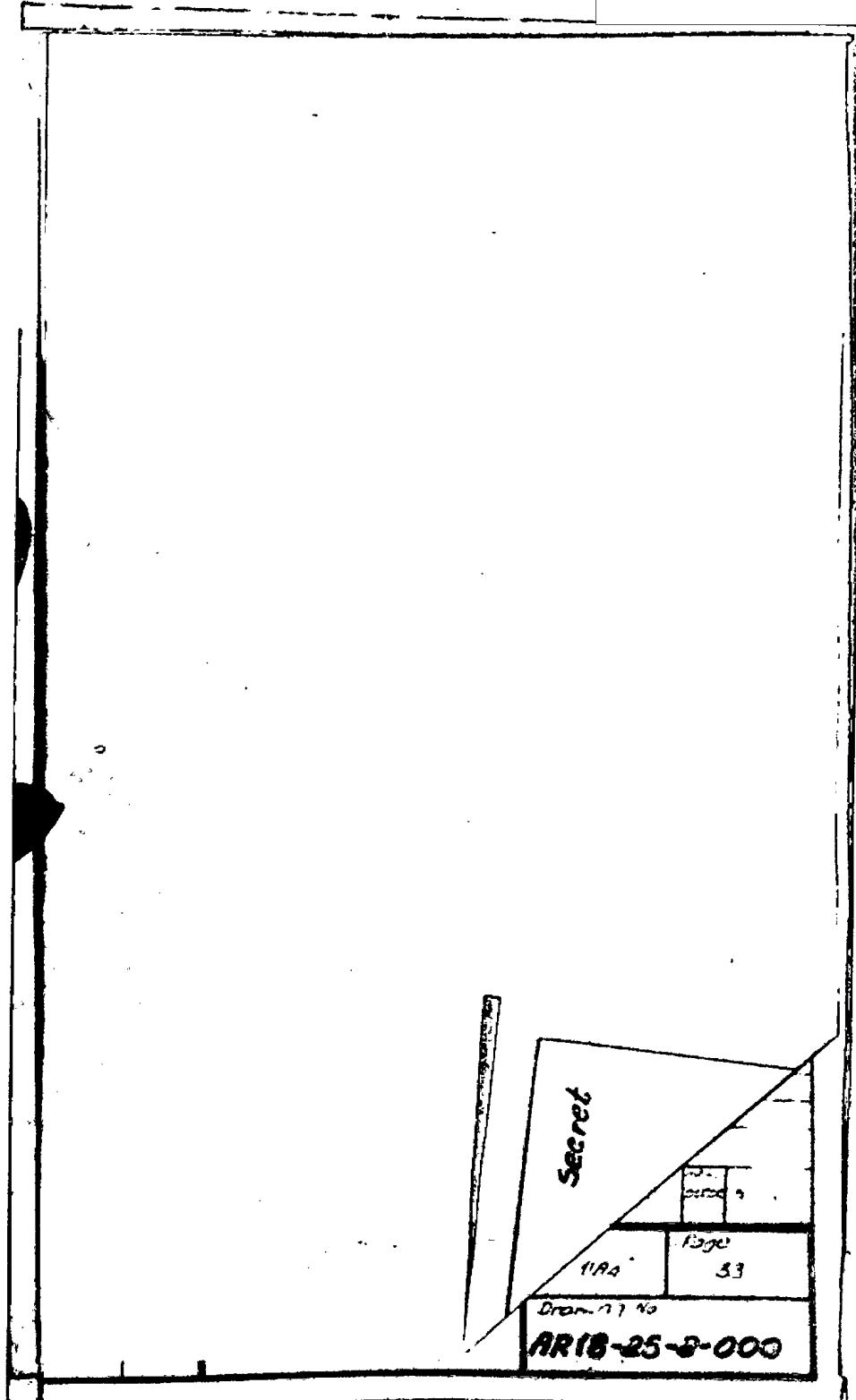

S-E-C-R-E-T

NO FOREIGN DISSEM

111

S-E-C-R-E-T
NO FOREIGN DISSEM

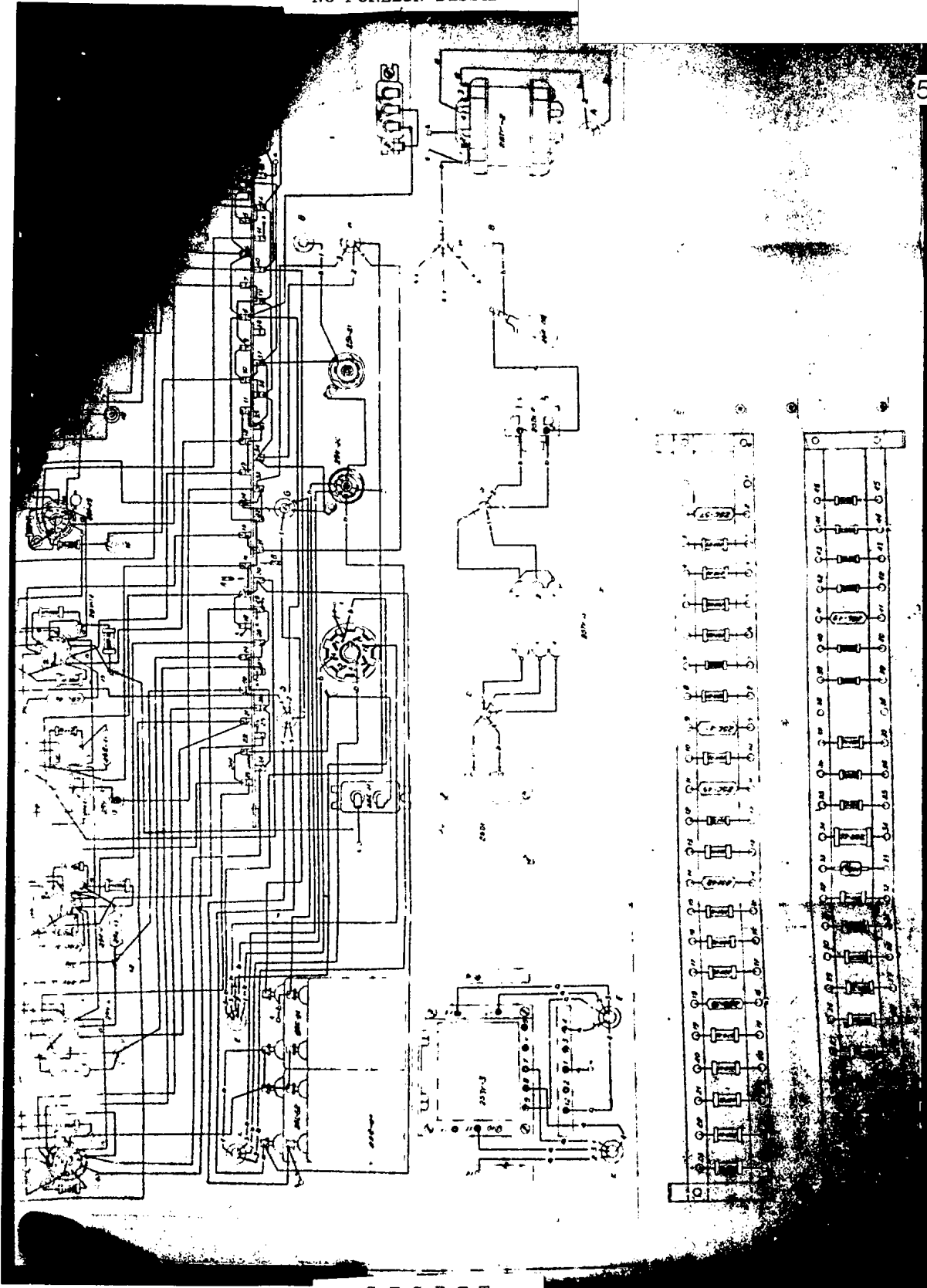

50X1

S-E-C-R-E-T
NO FOREIGN DISSEM

S-E-C-R-E-T
NO FOREIGN DISSEM



50X1

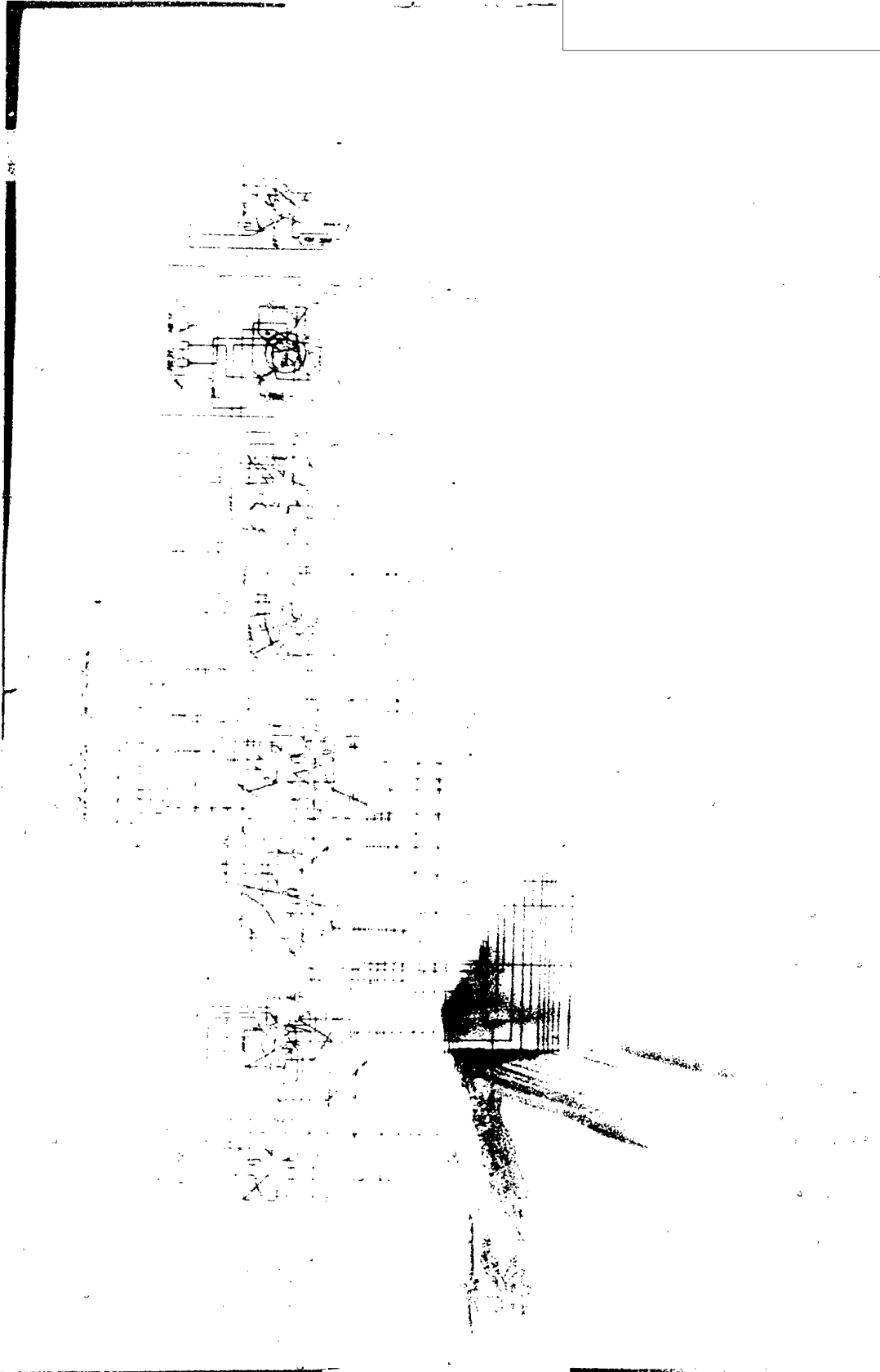

S-E-C-R-E-T
NO FOREIGN DISSEM

S-E-C-R-E-T
NO FOREIGN DISSEM

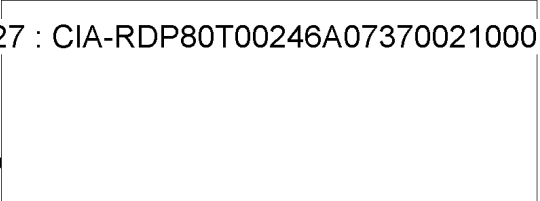

50X1

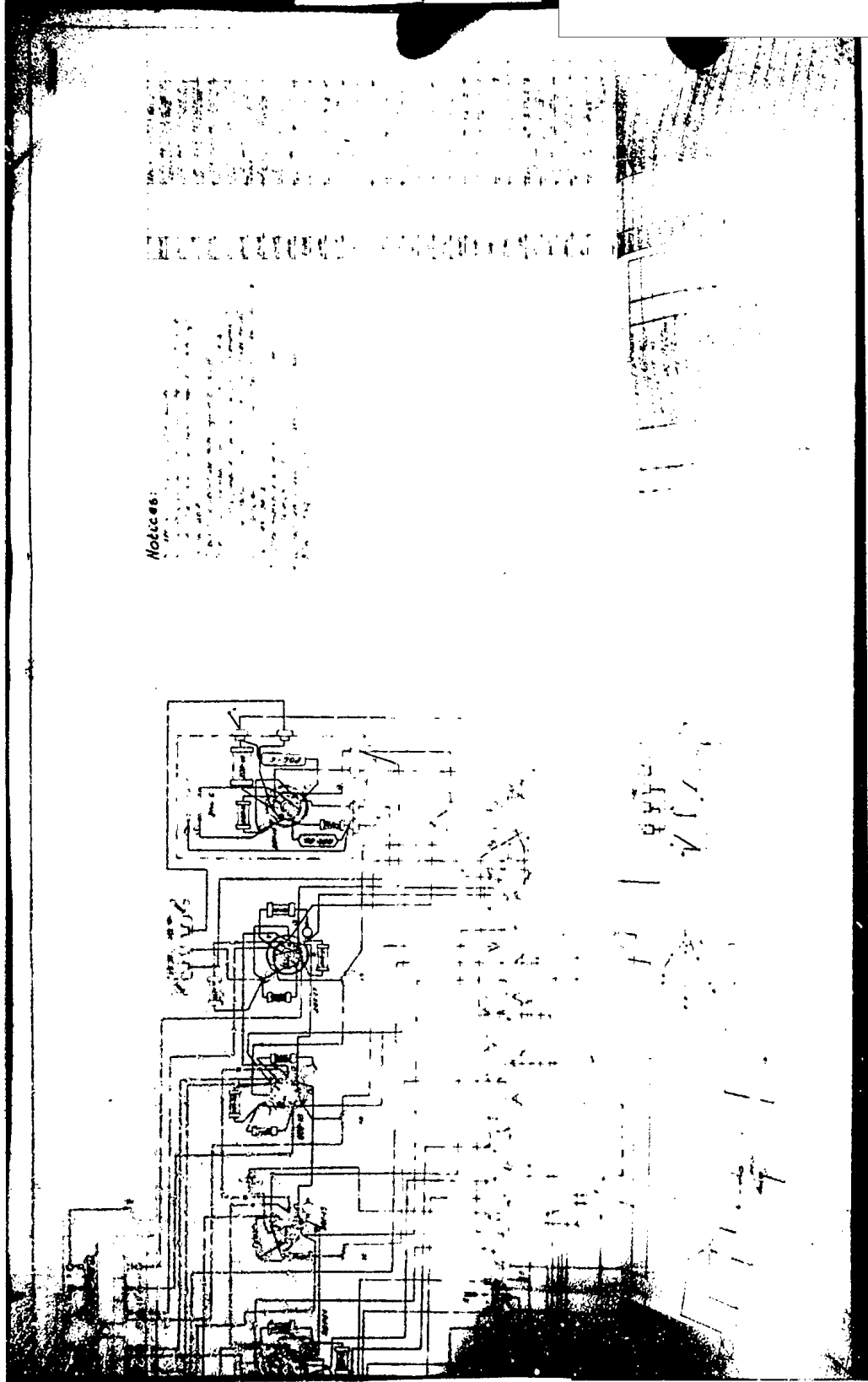

S-E-C-R-E-T

NO FOREIGN DISSEM

104

S-E-C-R-E-T
NO FOREIGN DISSEM

50X1

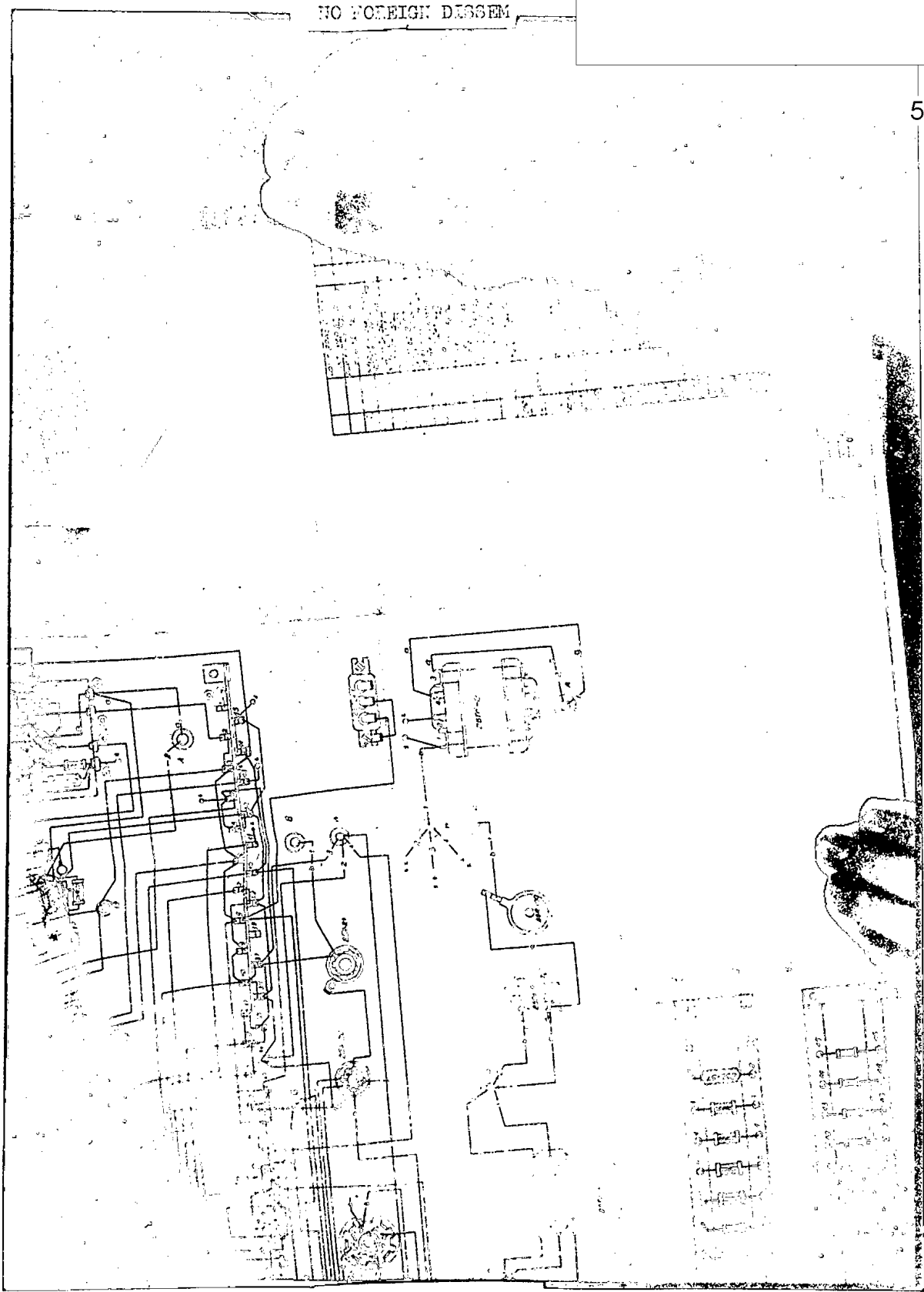

S-E-C-R-E-T

NO FOREIGN DISSEM

S-E-C-R-E-T
NO FOREIGN DISSEM

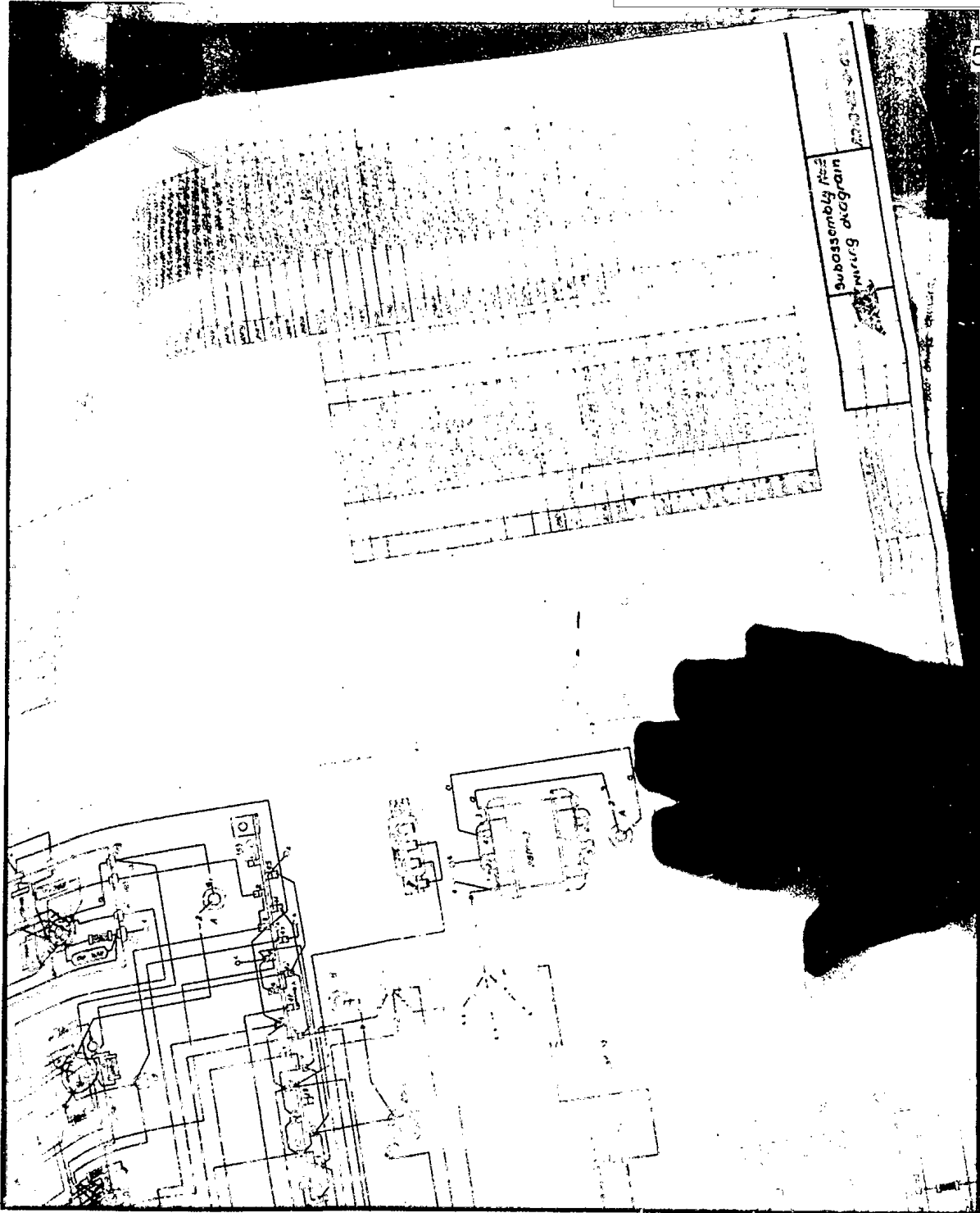

50X1

Subassembly
Wiring diagram

S-E-C-R-E-T

NO FOREIGN DISSEM

S-E-C-R-E-T
NO FOREIGN DISSEM

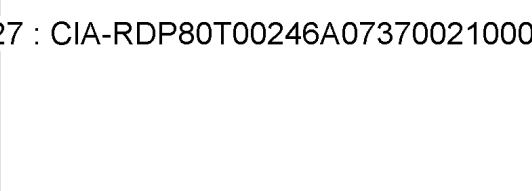

50X1

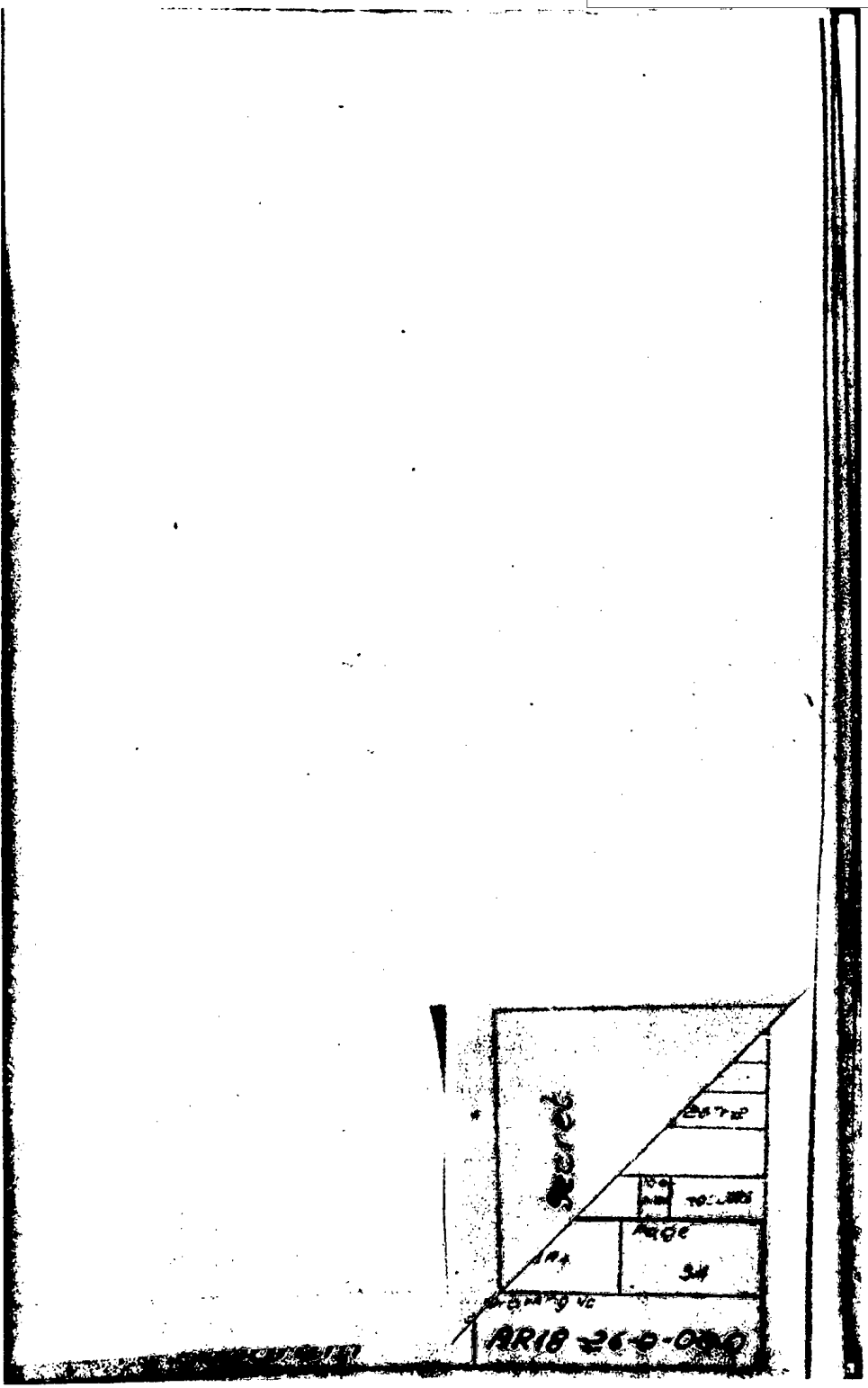

SECRET	DATE
	NO. OF COPIES
174	34
AR 18-260-000	

S-E-C-R-E-T
NO FOREIGN DISSEM

67

S-E-C-R-E-T
NO FOREIGN DISSEM

50X1

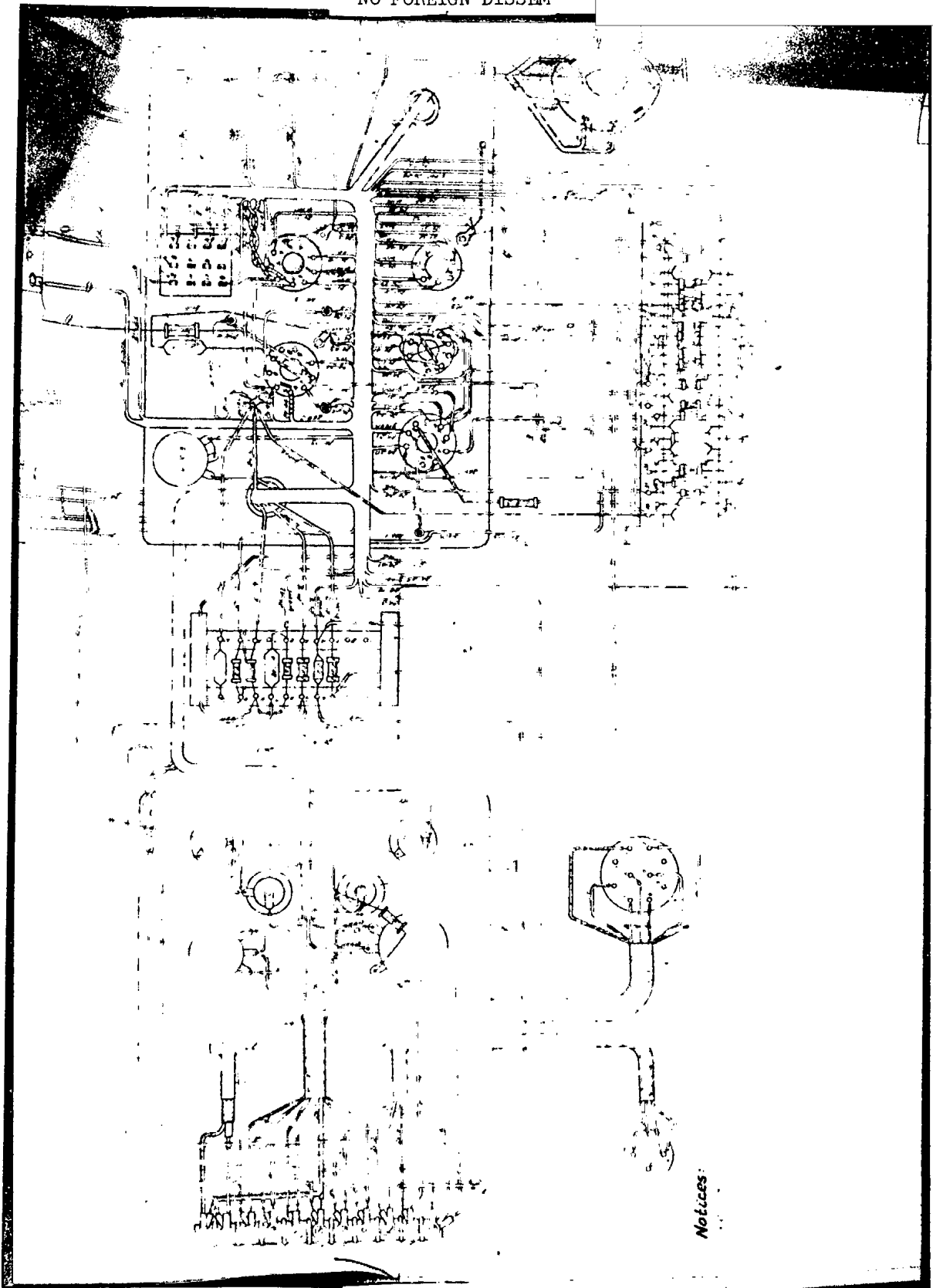

Notices:

S-E-C-R-E-T
NO FOREIGN DISSEM

S-E-C-R-E-T
NO FOREIGN DISSEM

50X1

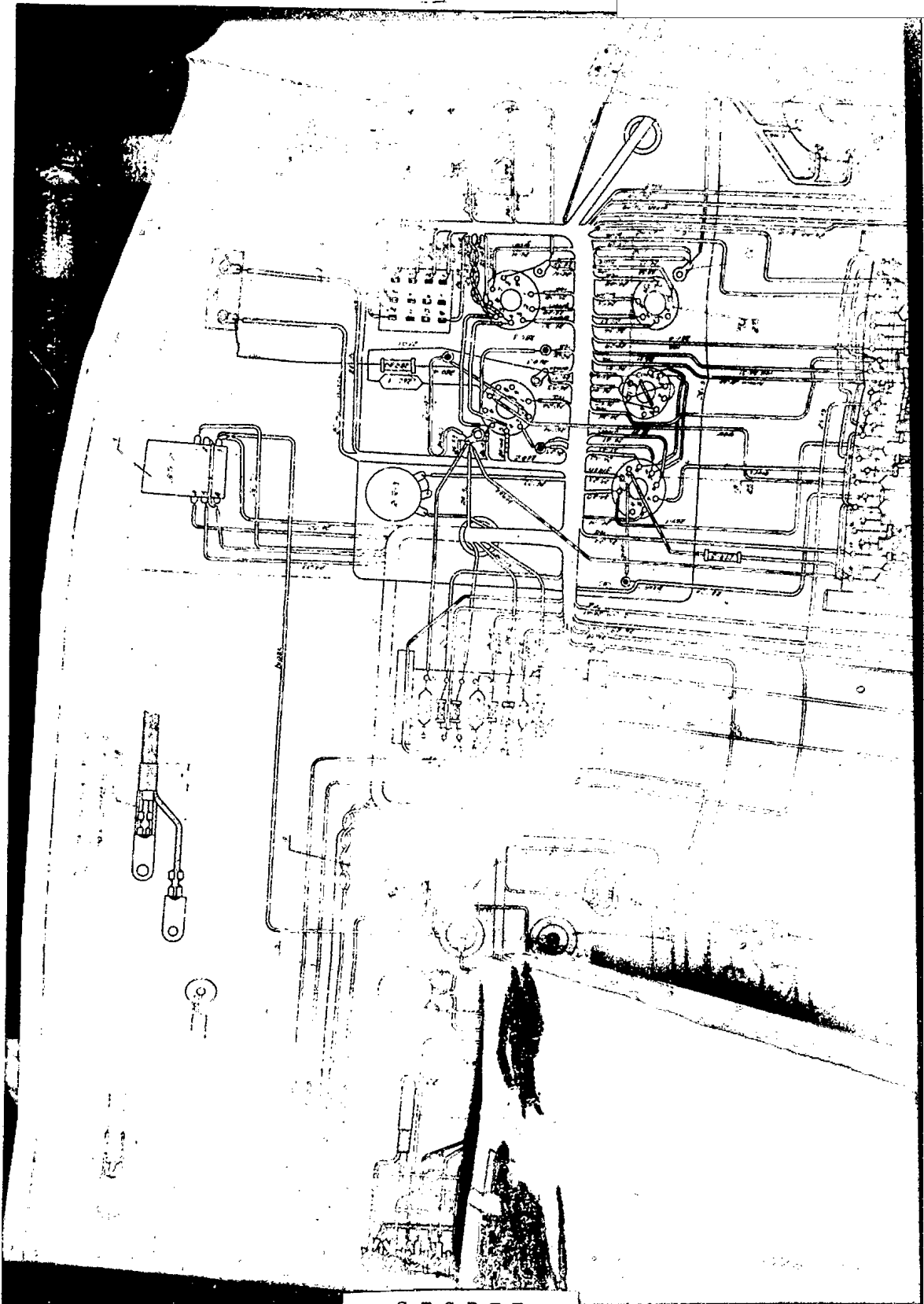

S-E-C-R-E-T
NO FOREIGN DISSEM

169

S-E-C-R-E-T
NO FOREIGN DISSEM

50X1

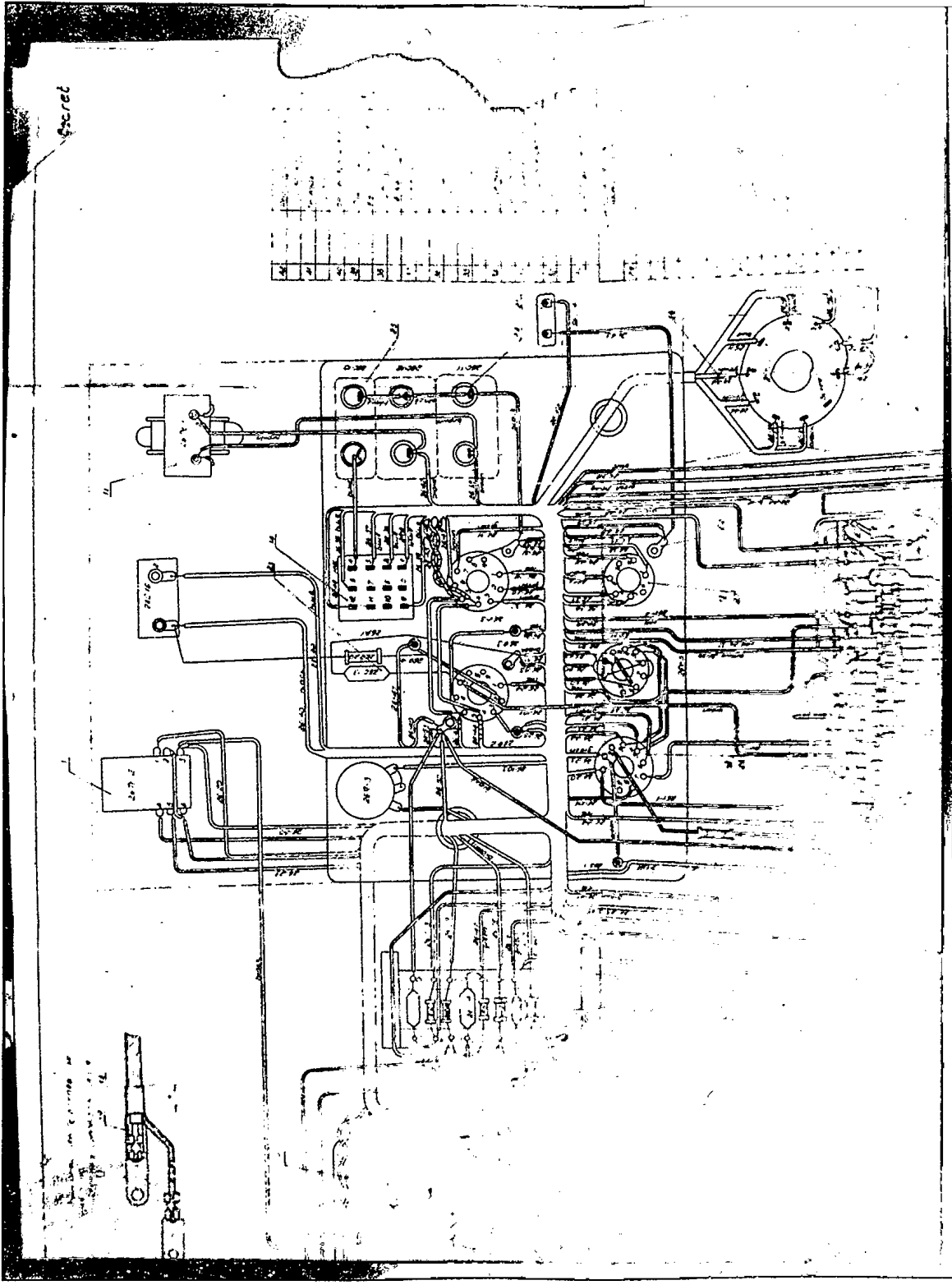

S-E-C-R-E-T
NO FOREIGN DISSEM

1.0

S-E-C-R-E-T
NO FOREIGN DISSEM

50X1

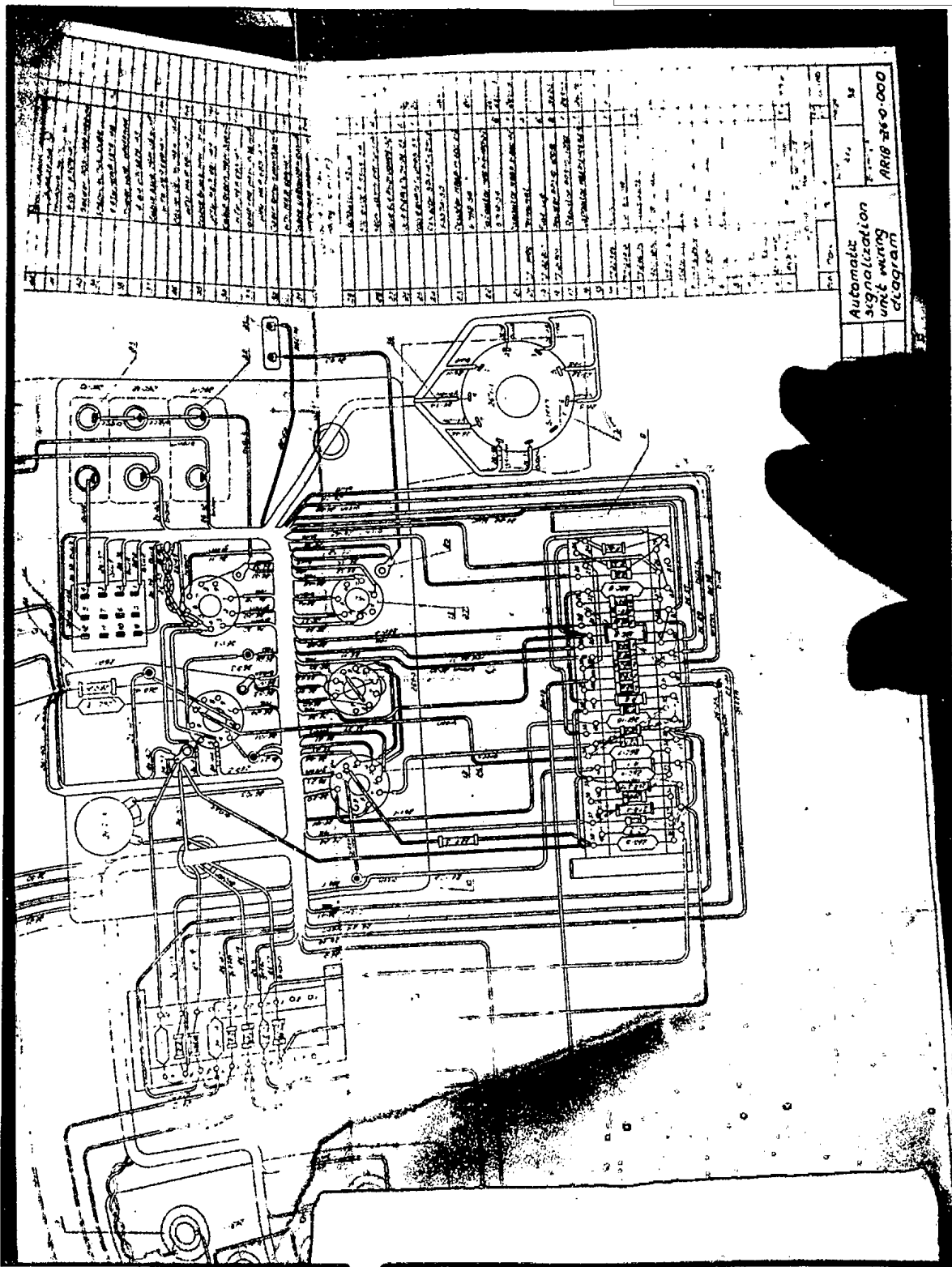

S-E-C-R-E-T
NO FOREIGN DISSEM

S-E-C-R-E-T
NO FOREIGN DISSEM

50X1

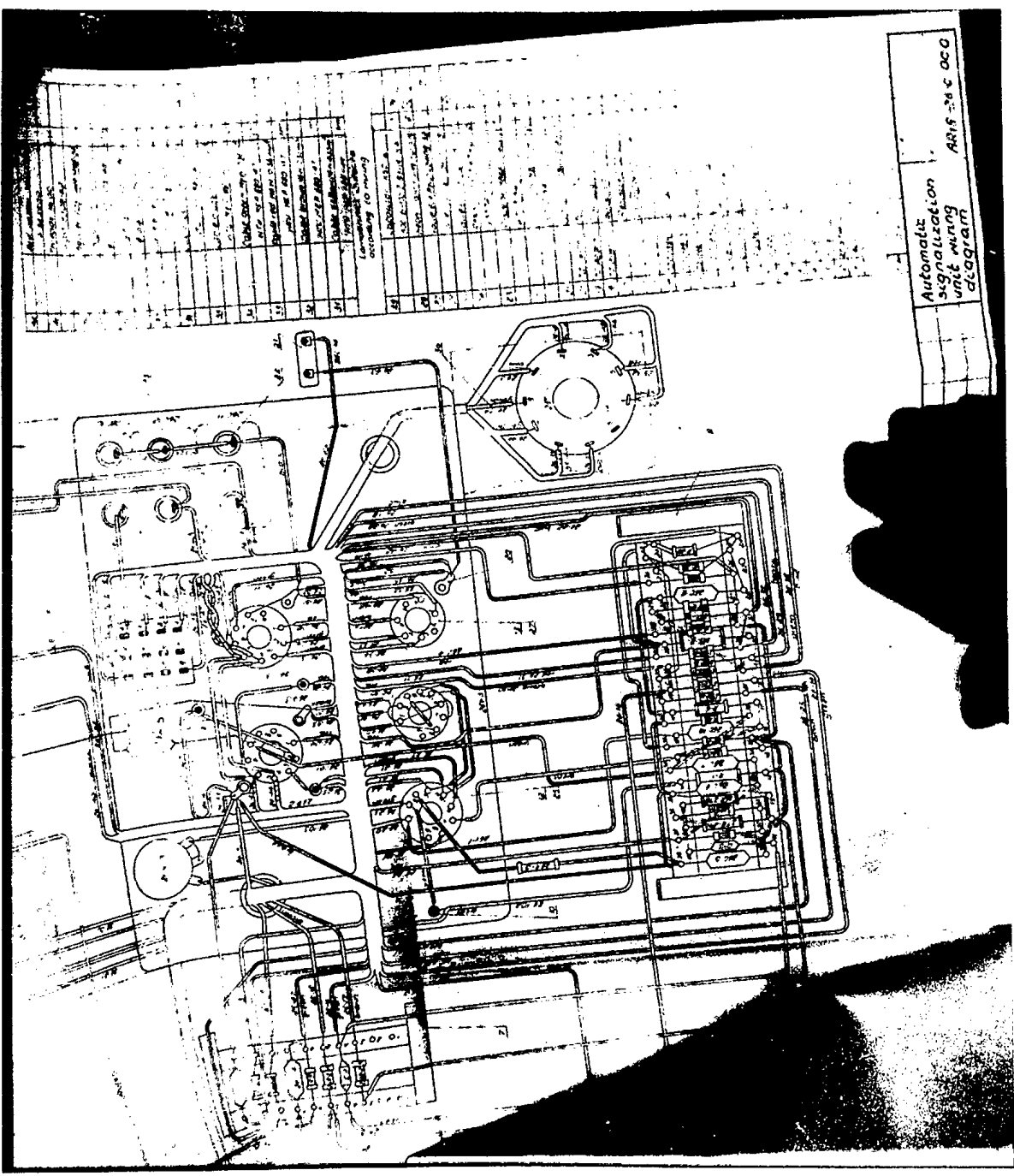

S-E-C-R-E-T
NO FOREIGN DISSEM

11'

S-E-C-R-E-T
NO FOREIGN DISSEM

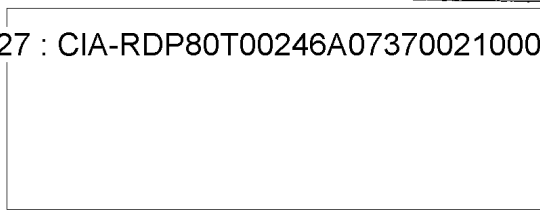

50X1

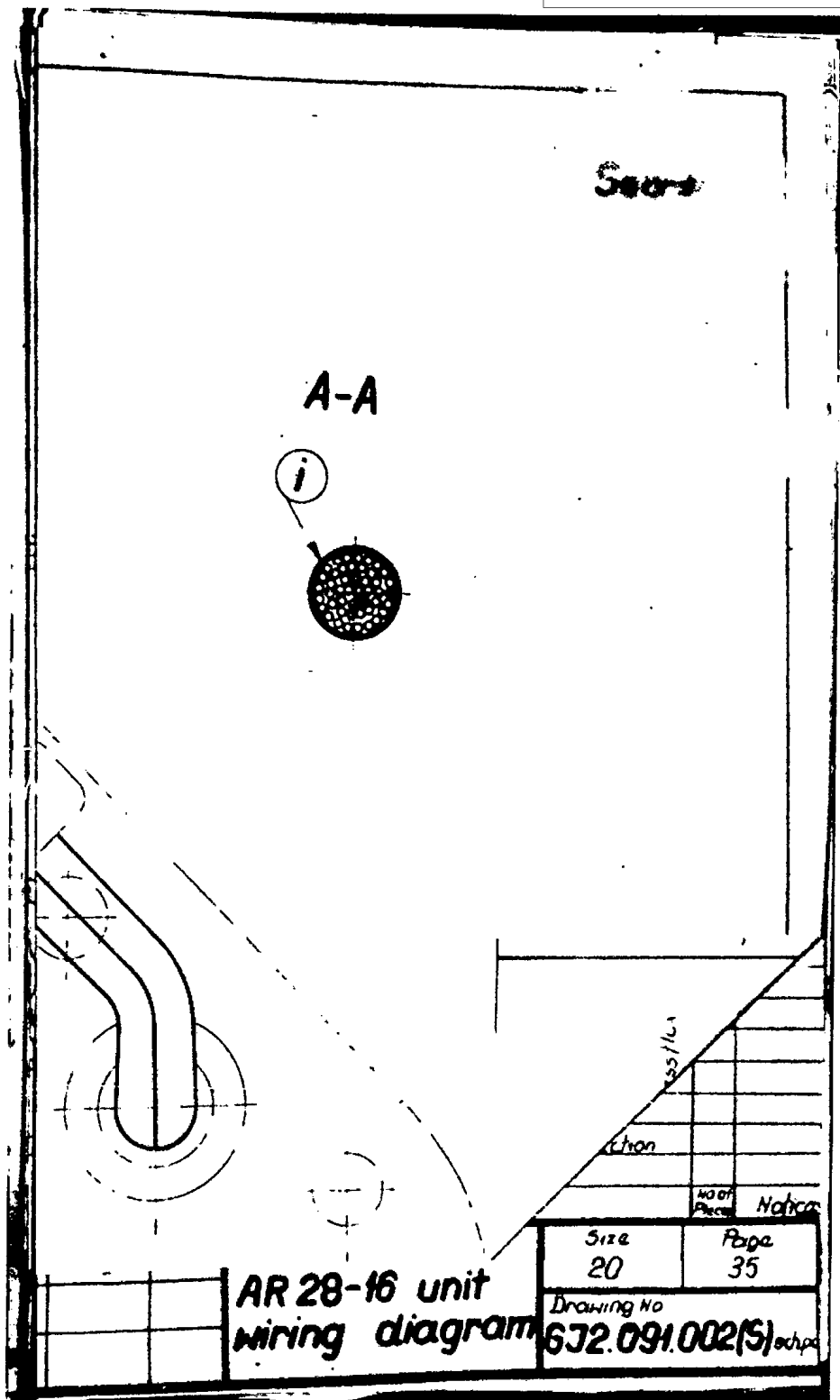

S-E-C-R-E-T
NO FOREIGN DISSEM

117

S-E-C-R-E-T
NO FOREIGN DISSEM

50X1

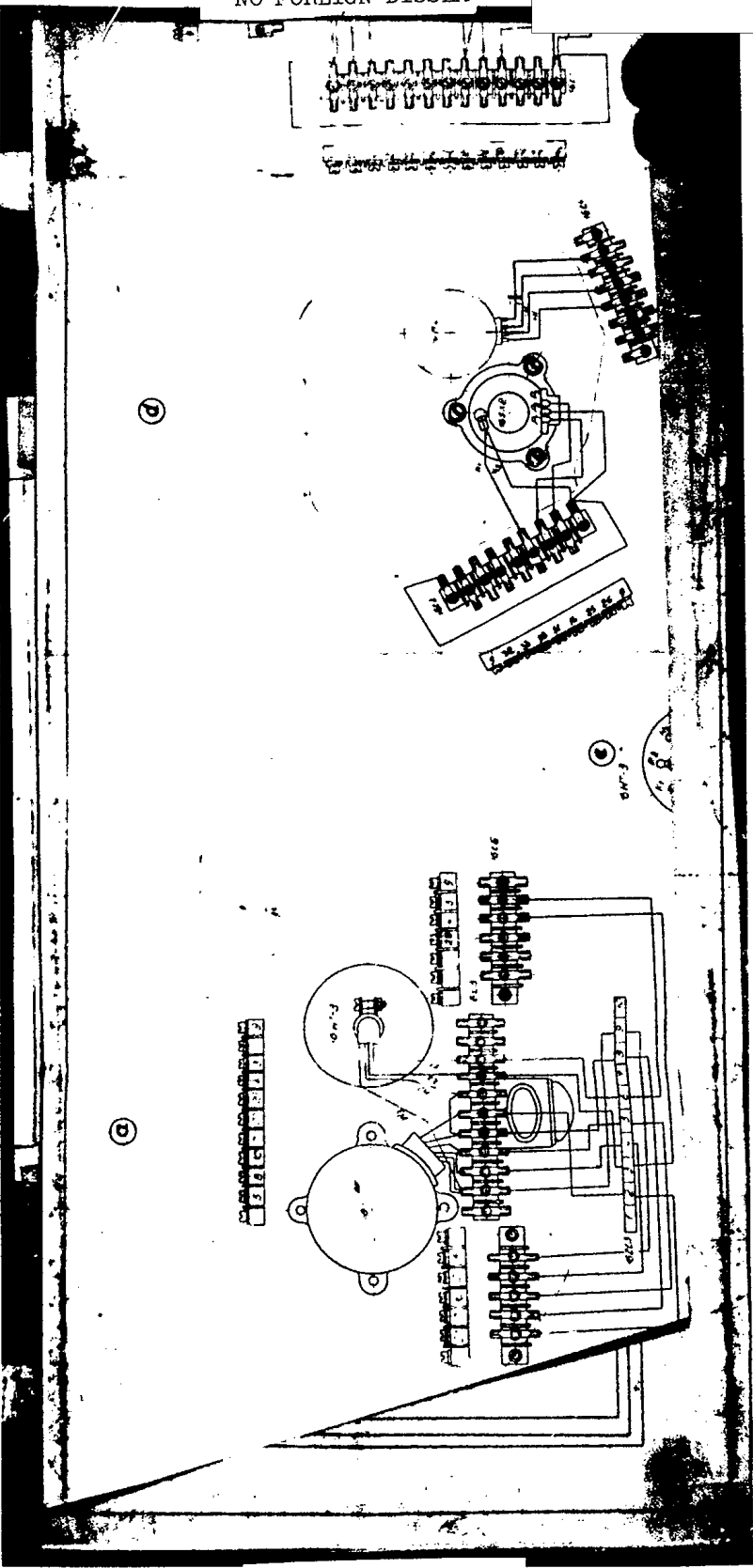

S-E-C-R-E-T
NO FOREIGN DISSEM

11"

S-E-C-R-E-T
NO FOREIGN DISSEM

50X1

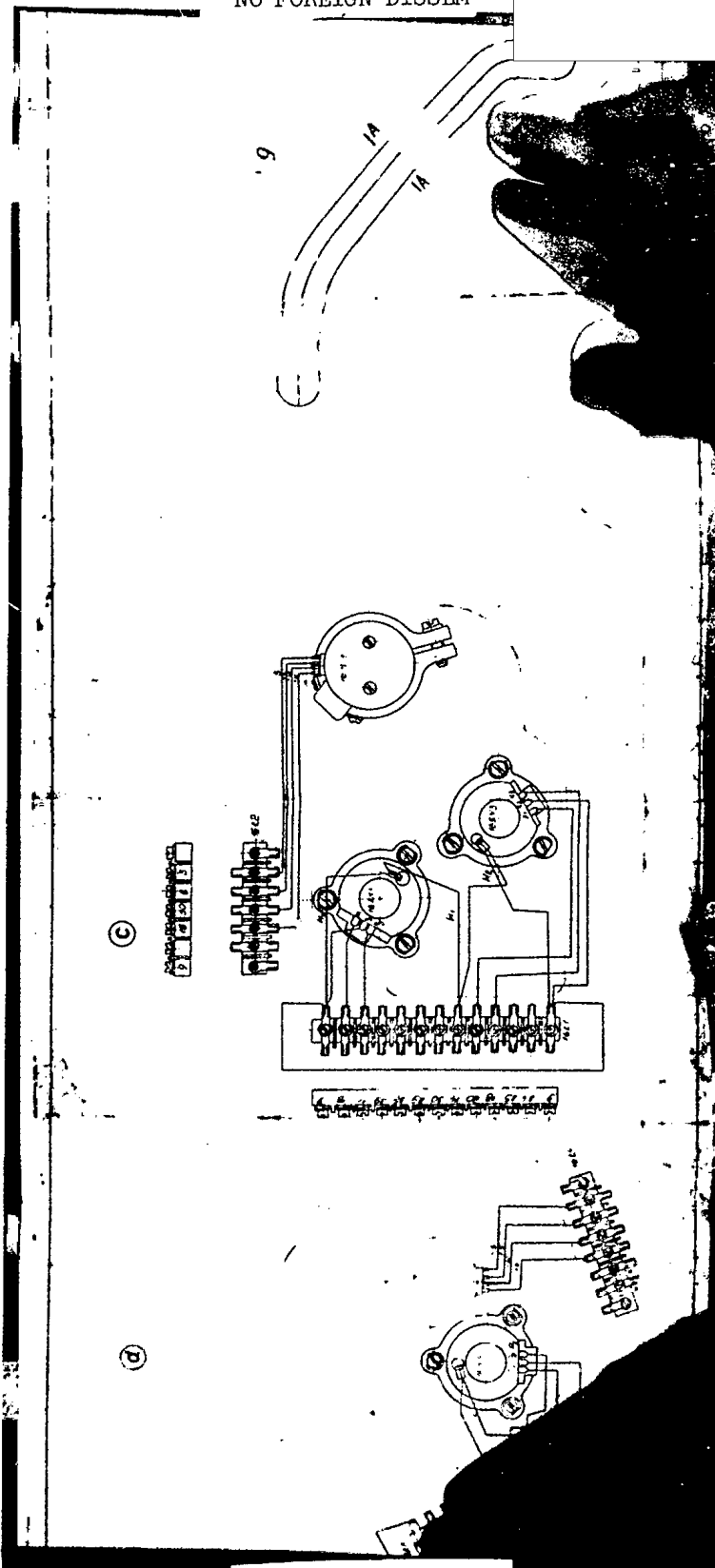

S-E-C-R-E-T
NO FOREIGN DISSEM

S-E-C-R-E-T
NO FOREIGN DISSEM



50X1

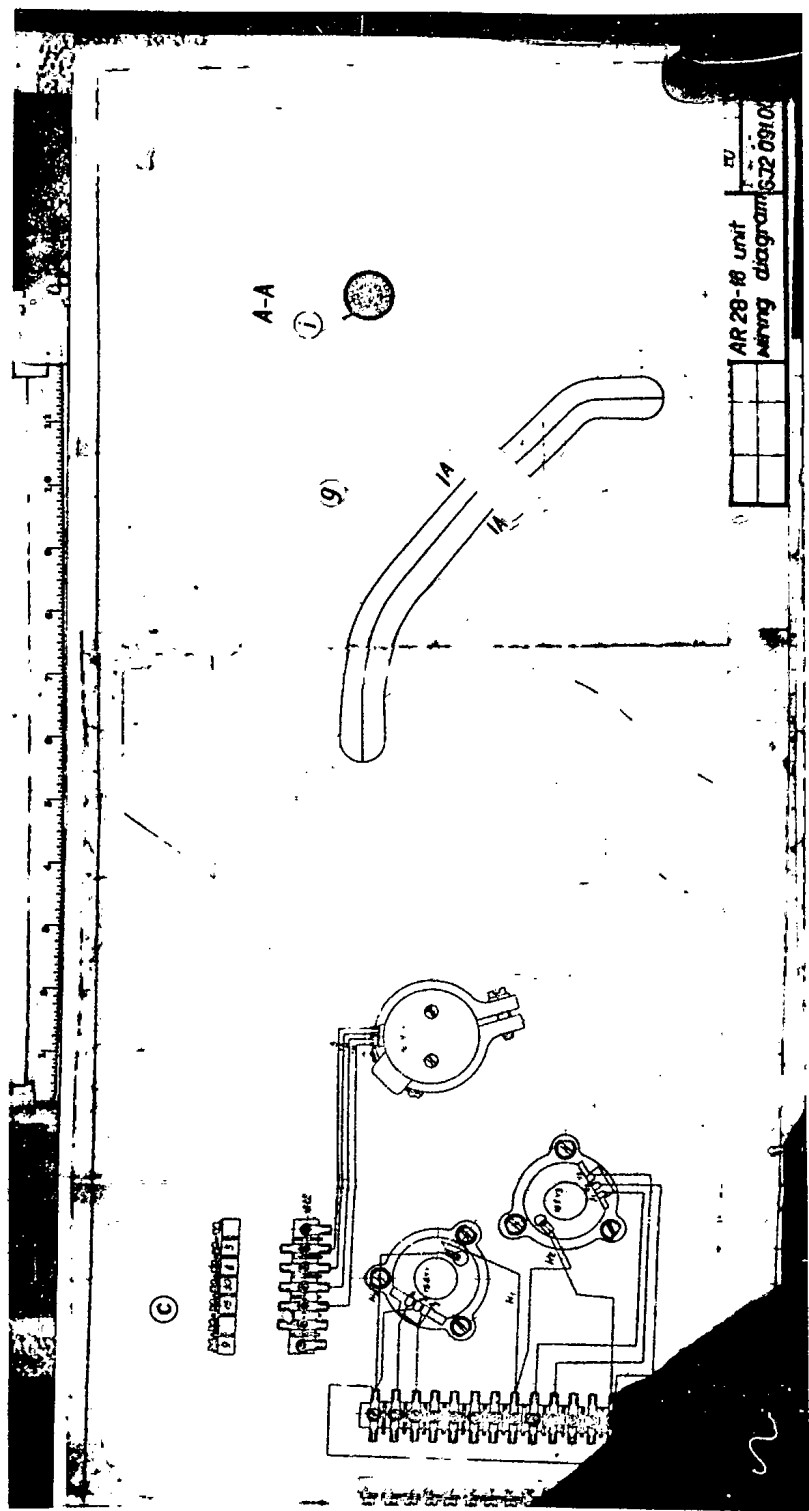

S-E-C-R-E-T
NO FOREIGN DISSEM

S-E-C-R-E-T
NO FOREIGN DISSEM

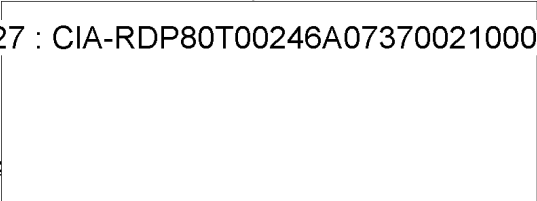

50X1

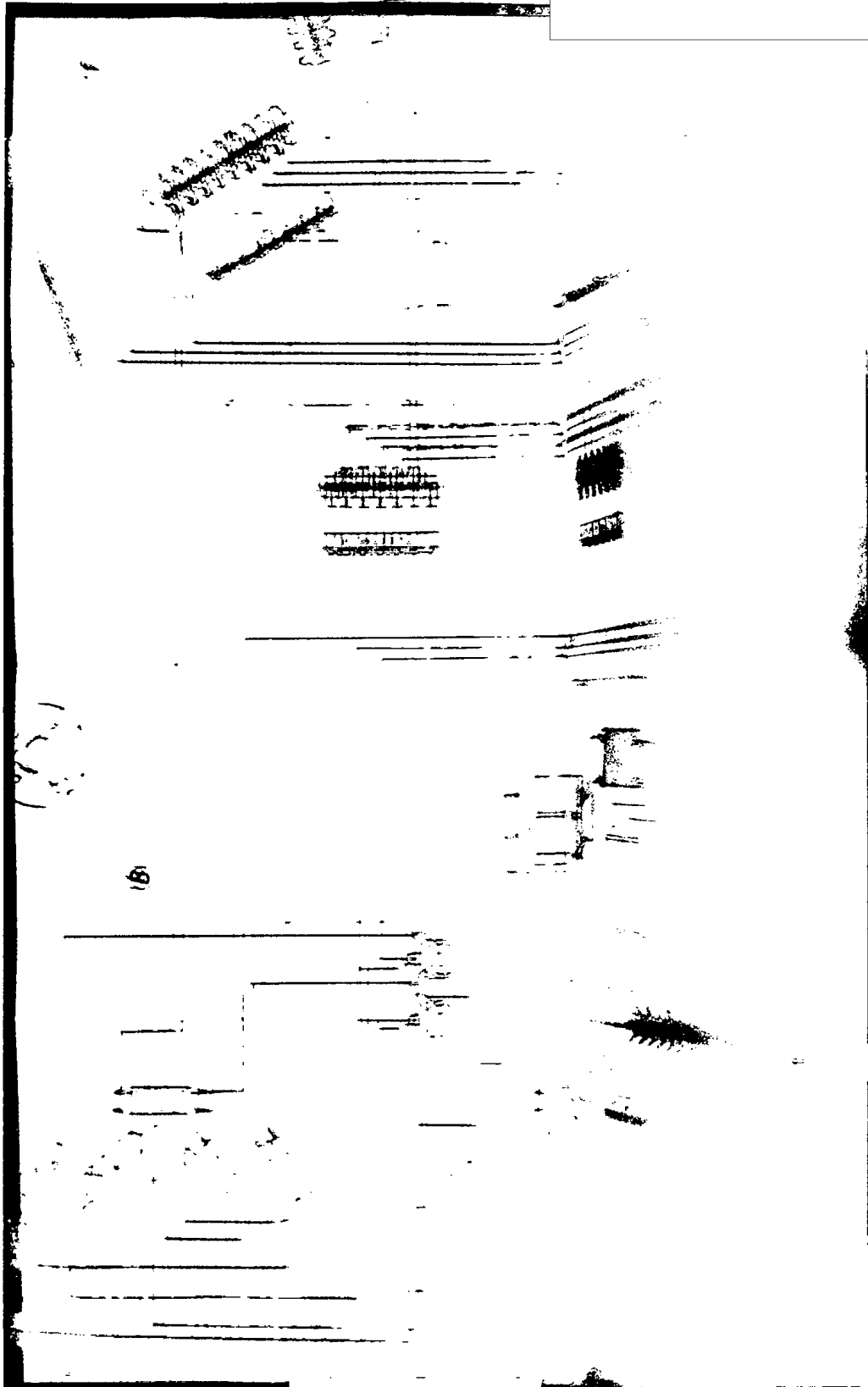

S-E-C-R-E-T
NO FOREIGN DISSEM

112

S-E-C-R-E-T
NO FOREIGN DISSEM

50X1

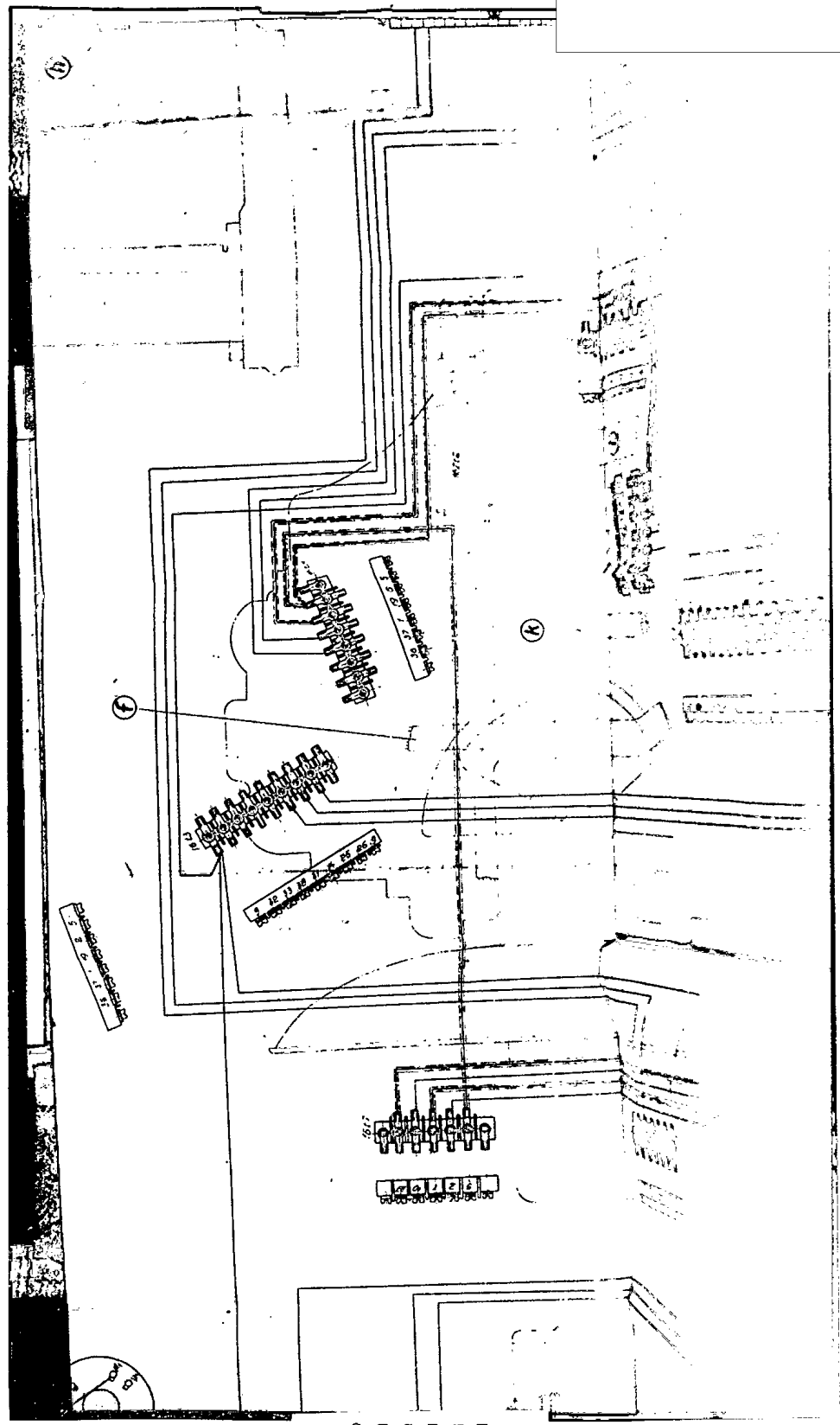

S-E-C-R-E-T

NO FOREIGN DISSEM

S-E-C-R-E-T
NO FOREIGN DISSEM

50X1

Notices

1. Squad carry out with 1st platoon
2. Squad carry out with 2nd platoon
3. Squad carry out with 3rd platoon
4. Squad carry out with 4th platoon
5. Squad carry out with 5th platoon
6. Squad carry out with 6th platoon
7. Squad carry out with 7th platoon
8. Squad carry out with 8th platoon
9. Squad carry out with 9th platoon
10. Squad carry out with 10th platoon
11. Squad carry out with 11th platoon
12. Squad carry out with 12th platoon
13. Squad carry out with 13th platoon
14. Squad carry out with 14th platoon
15. Squad carry out with 15th platoon
16. Squad carry out with 16th platoon
17. Squad carry out with 17th platoon
18. Squad carry out with 18th platoon
19. Squad carry out with 19th platoon
20. Squad carry out with 20th platoon

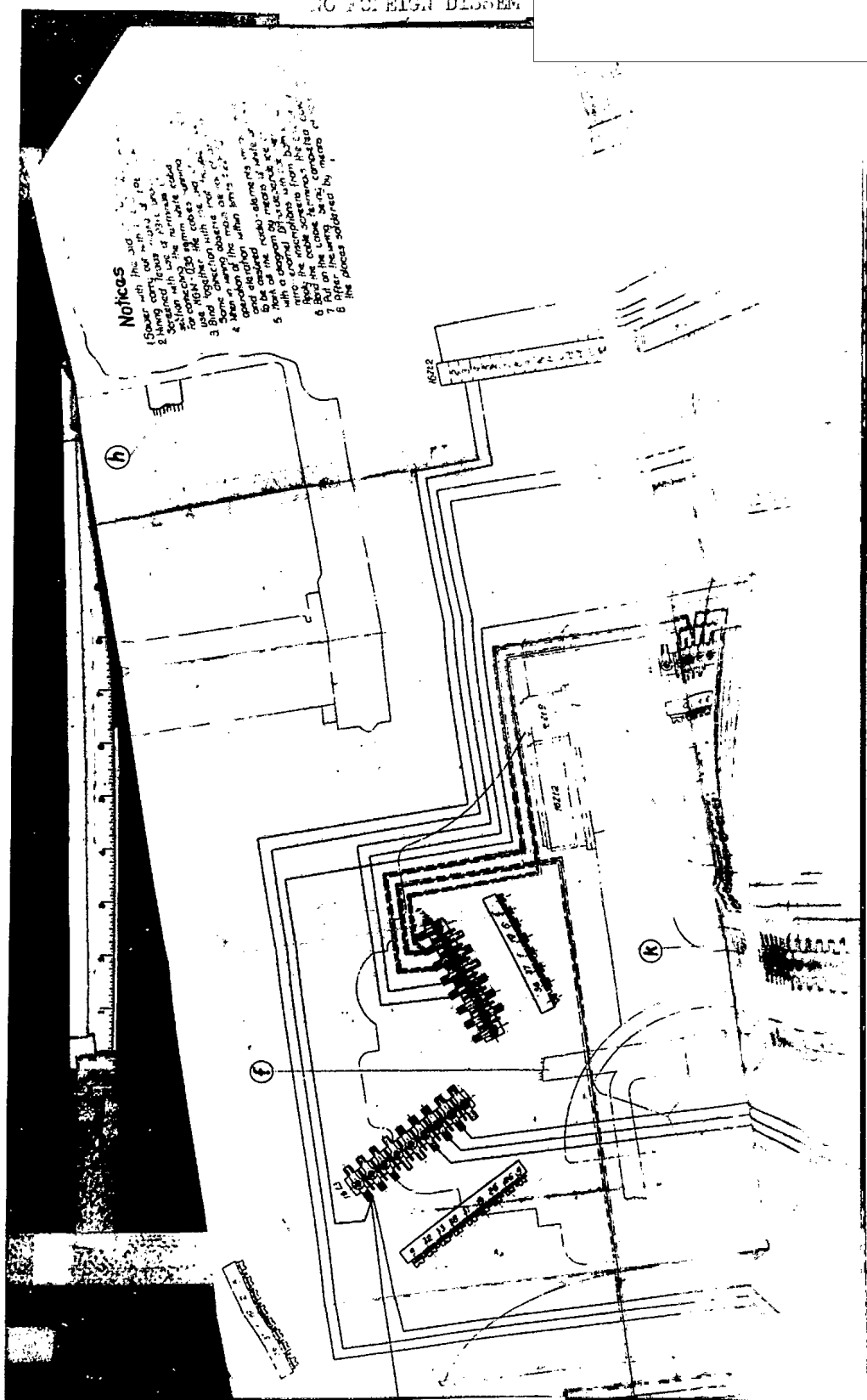

S-E-C-R-E-T

NO FOREIGN DISSEM

S-E-C-R-E-T
NO FOREIGN DISSEM

50X1

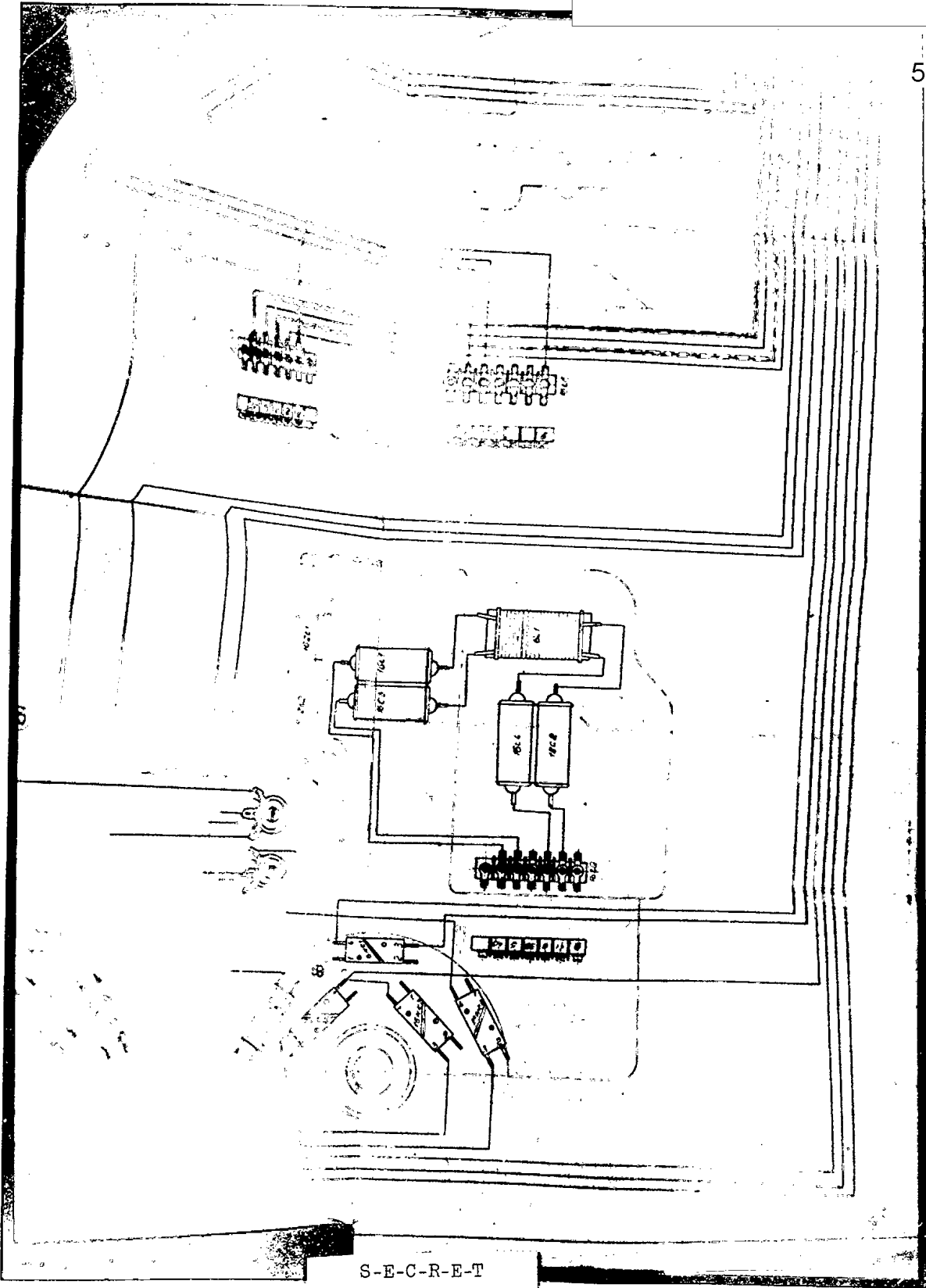

S-E-C-R-E-T
NO FOREIGN DISSEM

S-E-C-R-E-T
NO FOREIGN DISSEM

50X1

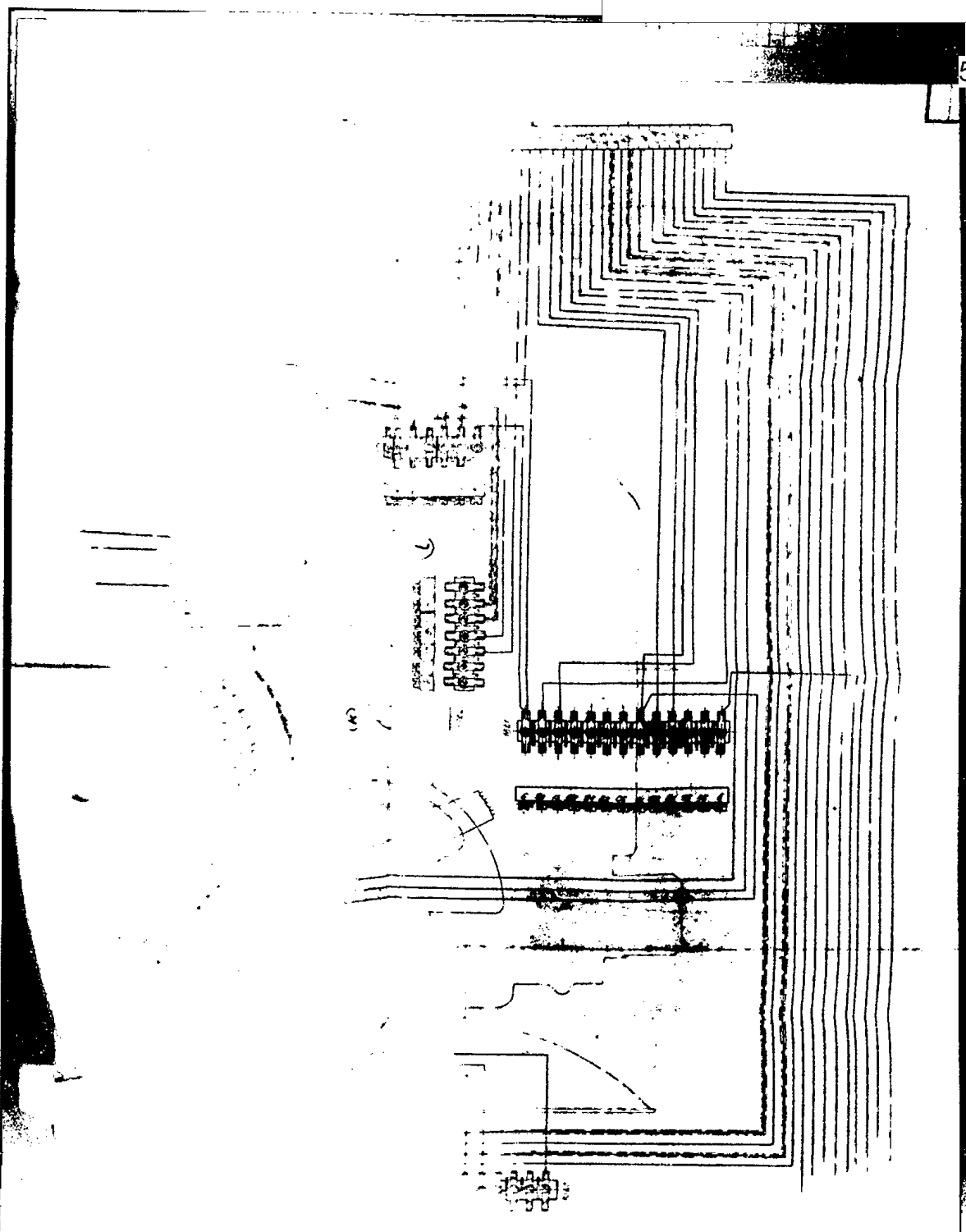

S-E-C-R-E-T
NO FOREIGN DISSEM

S-E-C-R-E-T
NO FOREIGN DISSEM

50X1

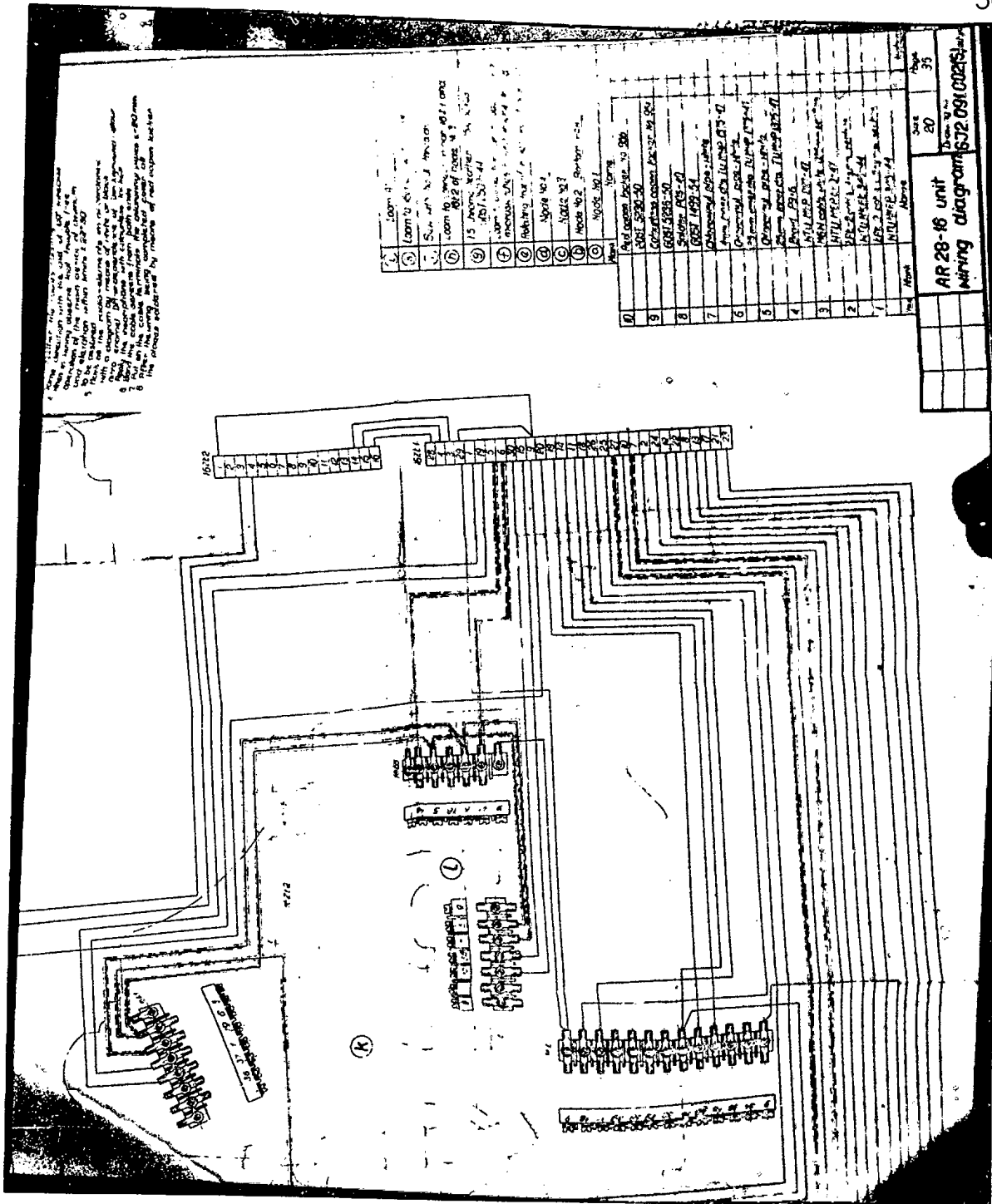

S-E-C-R-E-T
NO FOREIGN DISSEM

SECRET
NO FOREIGN DISSEM

SECRET
NO FOREIGN DISSEM