

50X1-HUM

Page Denied



50X1

50X1

SECRET
NO FOREIGN DISSEM

COUNTRY USSR # REPORT [redacted]

TITLE Technical Manuals on the Soviet SRD-1M Radio Range Finder (SCAN FIX)

DATE DISTR. 27 February 1964

NO. PAGES 2

REFERENCES [redacted]

OF [redacted] 50X1-HUM
& ACQ [redacted] 50X1-HUM

THIS IS UNEVALUATED INFORMATION. SOURCE GRADINGS ARE DEFINITIVE. APPRAISAL OF CONTENT IS TENTATIVE.

[redacted] English-language, technical manuals on the Soviet SRD-1M radio range finder (SCAN FIX), installed in the MIG-17F aircraft, [redacted] 50X1-HUM

1. Attachment I: Technical Description of the SRD-1M Radio Range Finder, 252 pages, published in 1958. A comparison of the text with the Table of Contents indicates that pages 1 through 4 of the original have been removed and replaced by a general view of the radio range finder and a diagram of the cable connections.
2. Attachment II: Collection of Diagrams for Radio Range Finder Type SRD-1M, 50 pages, published in 1958. The diagrams in the original were folded into the manual in such a manner that complete overlapping coverage was not obtained on the following:
 - a. Functional Diagram of Radio Range Finder SRD-1M
 - b. Circuit Diagram of Distance Unit.
 - c. Dimensions and Wiring Diagrams of SRD-1M Units (from ASP-4N)
 - d. Circuit Diagram of Transmit-Receive Unit.
 - e. Transmitter-Receiver Unit Wiring Diagram
 - f. Preliminary WPCZ [sic] Wiring Diagram.

34
50X1-HUM

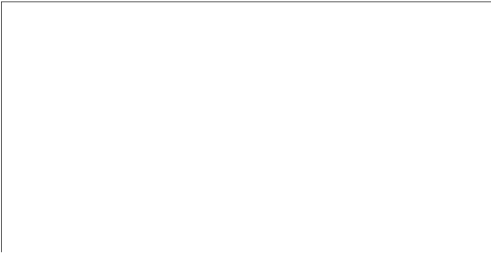

50X1-HUM

Page Denied

SECRET
NO FOREIGN DISSEM



50X1-HUM

TECHNICAL DESCRIPTION
OF THE
SRD-1M RADIO RANGE FINDER
(English Language)

50X1-HUM

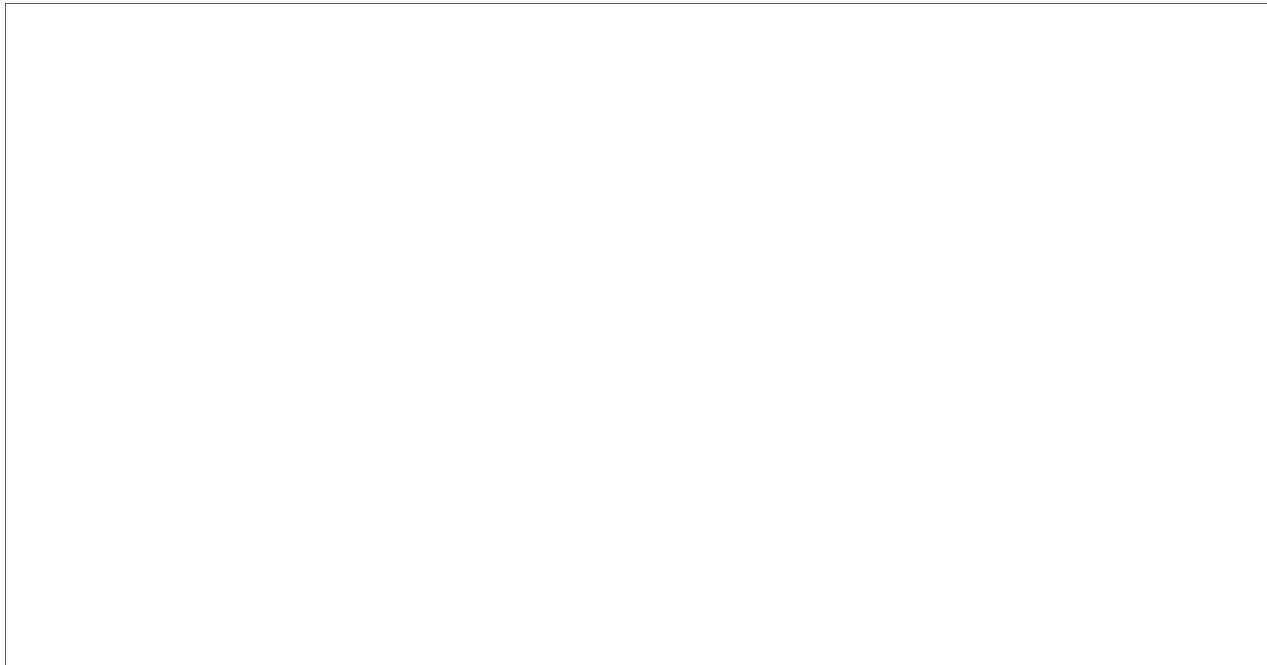



50X1-HUM

**TECHNICAL DESCRIPTION
OF THE
SRD - 1M RADIO RANGE FINDER**

S-E-C-R-E-T

(NO FOREIGN DISSEM)

S-E-C-R-E-T
NO FOREIGN DISSEM

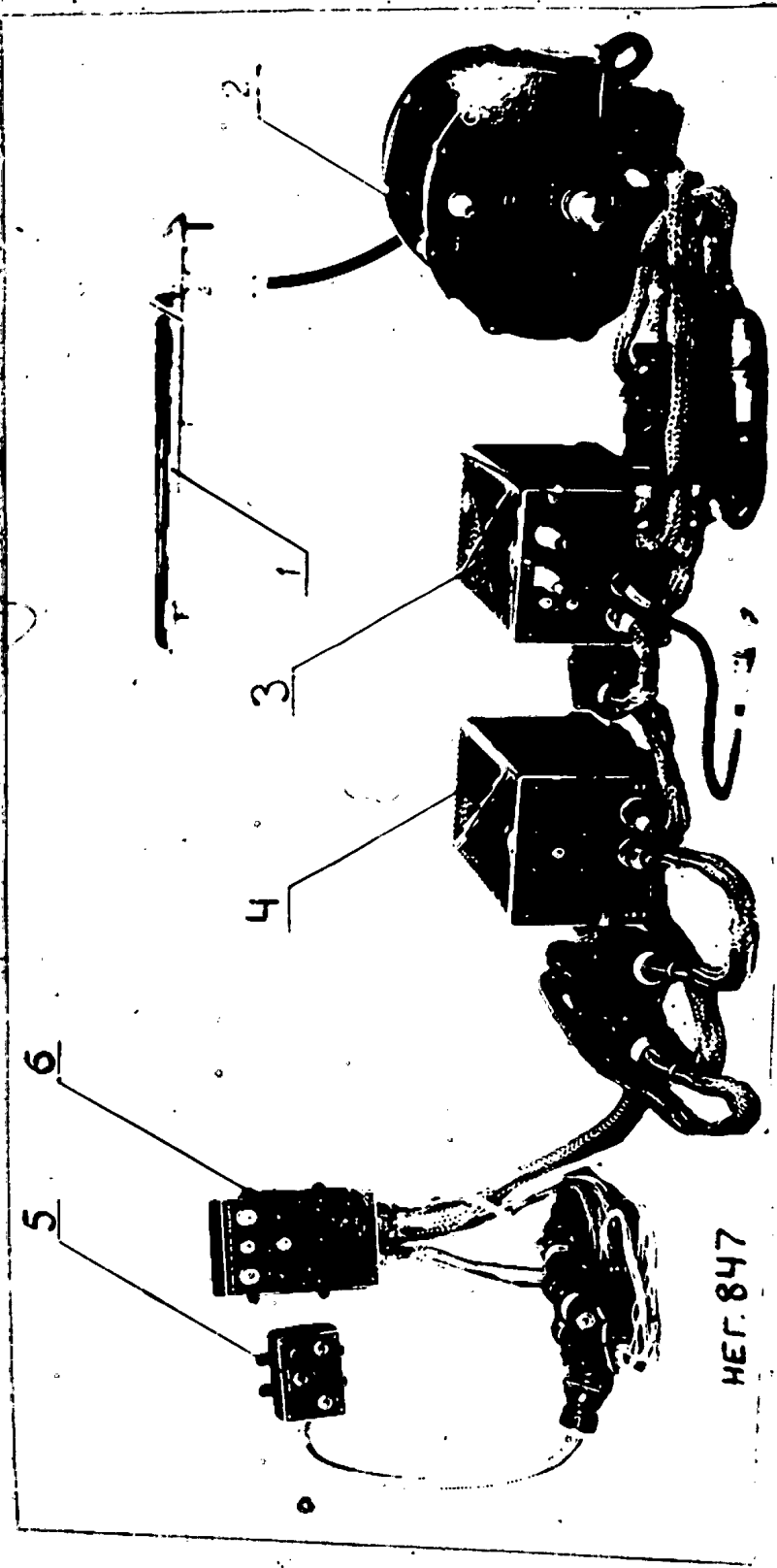

REF. 847

Fig. 1. General view of the radio range finder.
 1 - aerial assembly, 2 - transmitter-receiver unit, 3 - range unit, 4 - supply unit,
 5 - test board, 6 - control board.

50X1-HUM

S-E-C-R-E-T
NO FOREIGN DISSEM

50X1-HUM

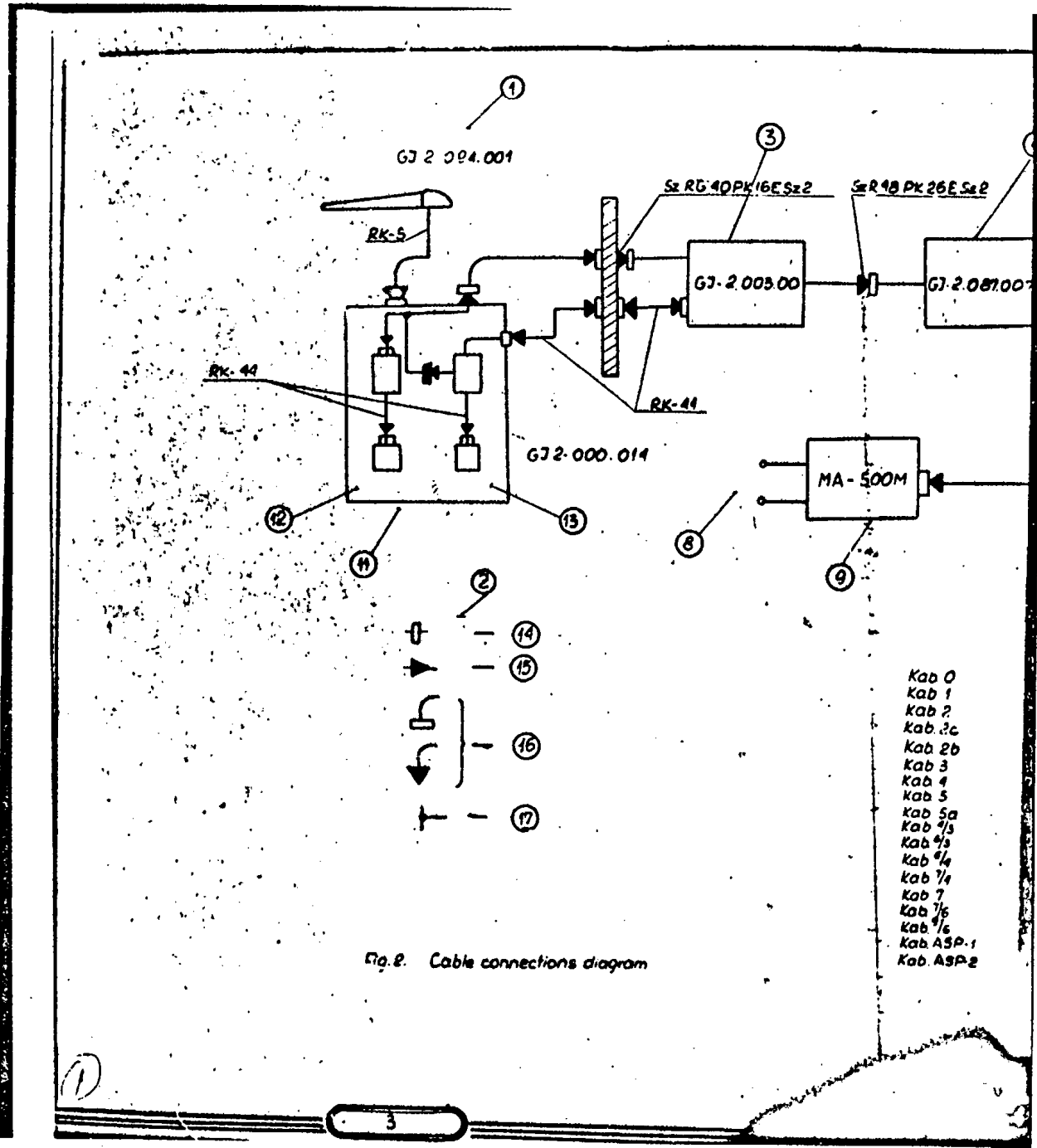
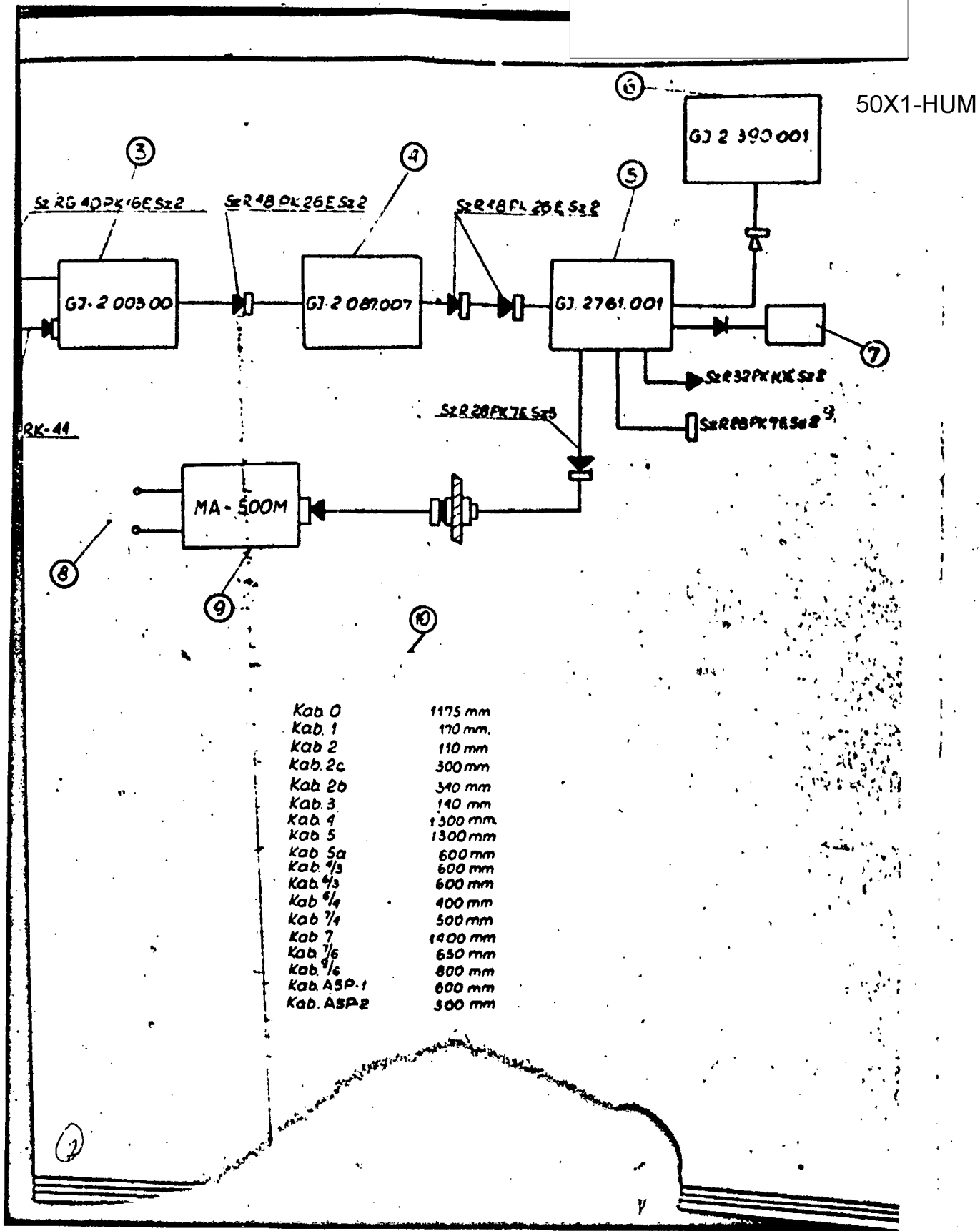

Fig. 2. Cable connections diagram

S-E-C-R-E-T
(NO FOREIGN DISSEM)

NO FOREIGN DISSEM



Kab 0	1175 mm
Kab 1	170 mm.
Kab 2	110 mm
Kab 2c	300 mm
Kab 2b	340 mm
Kab 3	140 mm
Kab 4	1300 mm.
Kab 5	1300 mm
Kab 5a	600 mm
Kab. 9/3	600 mm
Kab. 9/3	600 mm
Kab 9/4	400 mm
Kab 7/4	500 mm
Kab 7	1400 mm
Kab 7/6	650 mm
Kab. 9/6	800 mm
Kab ASP-1	800 mm
Kab. ASP2	500 mm

S-E-C-R-E-T

(NO FOREIGN DISSEM)

NO FOREIGN DISSEM

50X1-HUM

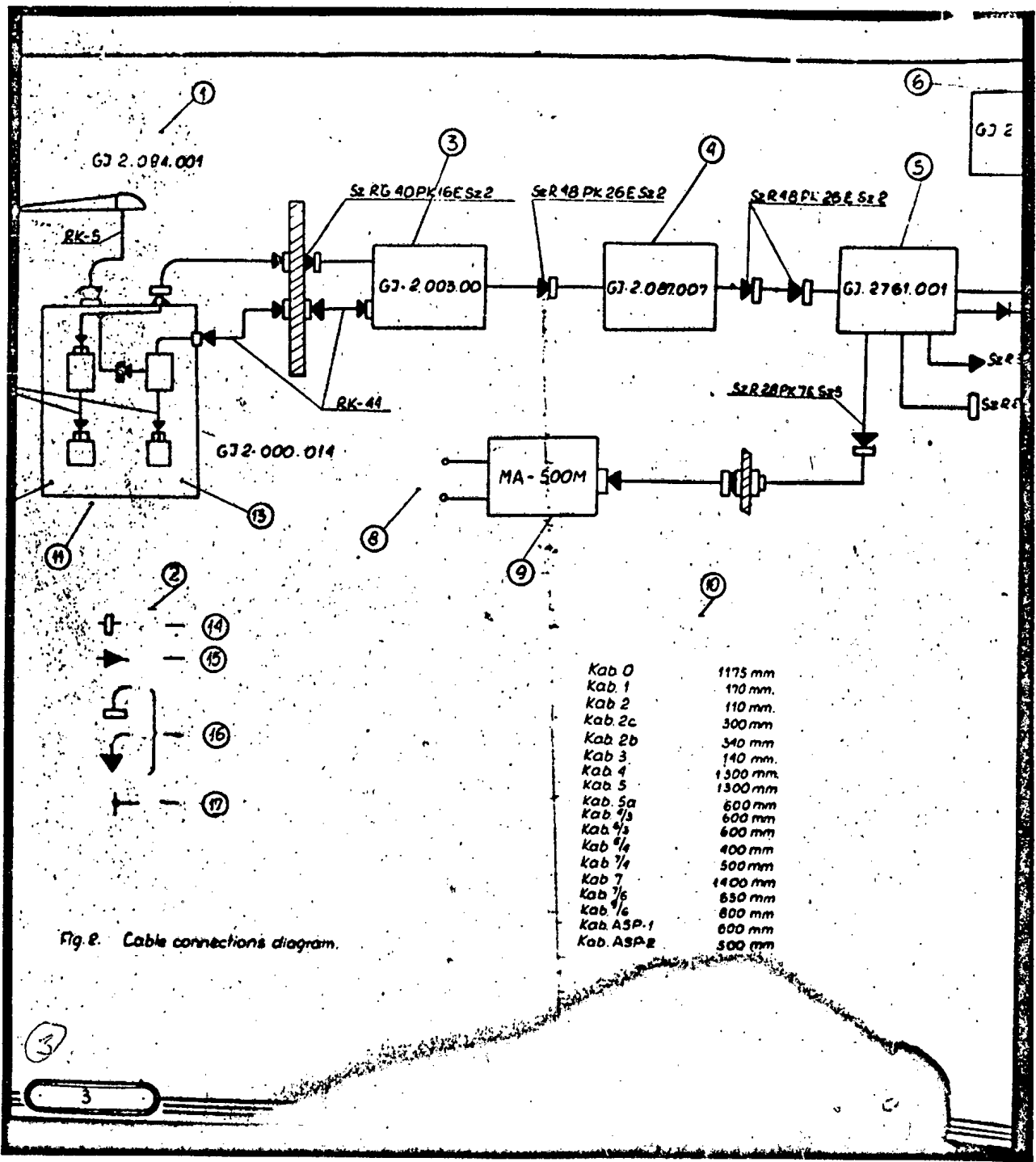

S-E-C-R-E-T
NO FOREIGN DISSEM

50X1-HUM

Fig. 2 Cable connections diagram.

- 1 - aerial
- 2 - cable No. 4
- 3 - range unit
- 4 - supply unit
- 5 - test board
- 6 - control board
- 7 - target searching switch
- 8 - 27 Volts D.C. aircraft network
- 9 - converter
- 10 - cable nominal length /between the unit and connector/
- 11 - transmitting-receiving unit
- 12 - automatic frequency control /ARCz/ mixer
- 13 - WPCz mixer /WPCz = intermediate frequency pre-amplifier/
- 14 - socket
- 15 - pin
- 16 - angular connectors
- 17 - cables distributor

S-E-C-R-E-T

(NO FOREIGN DISSEM)

50X1-HUM

- 3/ The aerial operates at $\frac{1}{2}$ power inside an angular zone $28^{\circ} \pm 2^{\circ}$ in the horizontal plane and $20^{\circ} \pm 4^{\circ}$ in the vertical one.
- 4/ Pulse power is equal to 7 kW at least.
- 5/ Modulating pulse time /duration/ reaches $0,7 \pm 0,05$ μ sec.
- 6/ Pulse frequency is equal to 930 ± 100 c/s.
- 7/ Receiving channel sensitivity reaches 55 decibels at 2000 m. It is equal to 48 decibels at 450 + 550 m relatively to 10μ V.
- 8/ Operational frequency of the magnetron generator is equal to 2800 ± 30 M.c/s.
- 9/ "Dead area" of the range finder does not exceed 300 m.
- 10/ Elementary identified /measured/ distance value exceeds 700 m.
- 11/ The 115 Volts A.C. 400 c/s circuit needs a 380 VA power.
- 12/ The range finder takes 1200 W power from the 27 Volts D.C. circuit. ± 45 Amp.
- 13/ Range finder's total weight /with cables/ but without the MA-500 W converter/ reaches 29 kg.
- 14/ The continuous operation of the range finder can last 4 hours in normal conditions. The range finder's uninterrupted operation lasts 2 hours at $+50$ and -50 deg. C.
- 15/ The guaranteed service time of the radio range finder, as installed on the aircraft, is equal to 400 flying hours in 2-years period, under the condition of performing all scheduled maintenance work according to Service and Maintenance Manual.

The guaranteed operation period is not the range finder total service life. The range finder service life is much greater than the guaranteed service period.

II. OPERATION PRINCIPLE AND COOPERATION of SRD-1M

RANGE FINDER UNITS.

1. Principle of operation.

The radio range finder operation is based on radiation in

S-E-C-R-E-T

NO FOREIGN DISSEM

NO FOREIGN DISSEM

50X1-HUM

a given zone by means of short periodical electro-magnetic pulses as well as on reception of pulses which are reflected from a target found in the radiated zone.

The distance to the target is determined due to an automatic measurement of time between the moment of high frequency pulse radiation and the moment of pulse return after the reflection from the target.

A transmitted /radiated/ pulse and a reflected one are shown in Fig. 3, plotted against time.

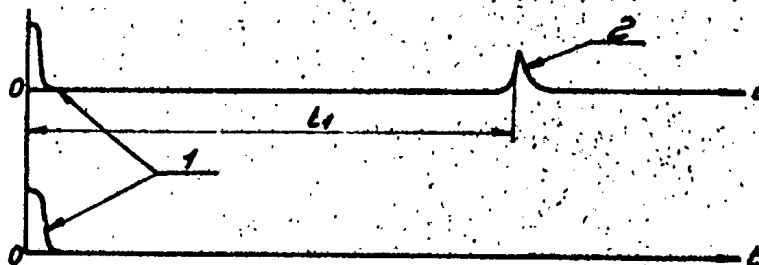

Fig. 3. Pulses plotted against time.

- 1 - probe pulse
- 2 - reflected pulse

Following equation determines a relationship between the distance to a target, speed of electro-magnetic waves propagation in a free space, lapse of time between the moment of high frequency pulse radiation and the moment of reflected pulse reception:

$$t = \frac{2D}{C}$$

where:

- t - time for high frequency pulse transmission to the target and back to range finder, in seconds.
- D - distance to the target, /meters/
- C - speed of electromagnetic waves propagation, m/s.

$$C = 3 \cdot 10^8 \text{ m/sec.}$$

S-E-C-R-E-T

NO FOREIGN DISSEM

50X1-HUM

A simplified view of an aircraft provided with a range finder and of a target aircraft is shown in Fig. 4.

The determination of time t in the range finder is performed according to voltage value. This voltage varies with time according to a linear relationship:

$$U = U_0 + Kt$$

where:

- U_0 - initial voltage
- U - voltage at the given moment
- K - constant coefficient

The measurement of time starts at the moment of high frequency pulse radiation /transmission/.

To enable the target searching according to distance in the range finder, gate pulses are transmitted /two positive pulses 0,7 μ sec long, displaced reciprocally by 0,5 μ sec./.

The gate pulses are given on synchr. circuits. A target pulse is transmitted also from the receiver output to synchr. circuits.

If there is no reflected signal, the gate pulses arise with a variable delay relatively to the station probe pulse, which varies from 2 μ sec to 13,3 μ sec with a 0,5 + 1,5 c/s frequency. It corresponds to 300 + 2000 m. gate pulses displacement on the range graduated dial.

If there is a pulse reflected from the target, a variable delay circuit of gate pulses disconnects automatically at the moment of gate pulses interference with the reflected pulse. The target interception according to distance begins, as well as the automatic target tracing. Simultaneously the range finder creates a voltage which is proportional to distance to the target. This voltage is fed to the computing circuit of the ASP-4M sight.

Fig. 6 illustrates a relationship between the range finder output voltage and the distance to a target.

2. Block-diagram of the radio range finder.

The SRD-1M radio range finder consists of 6 units /see

50X1-HUM

Fig. 7/.

The aerial is formed by a dielectric rod /stick/ cut in order to form a cross section. The rod is fastened to a metal screen.

The aerial operates /at $\frac{1}{2}$ power/ inside an angular zone $28^{\circ} \pm 2^{\circ}$ in the horizontal plane and $20^{\circ} \pm 4^{\circ}$ in the vertical one. The aerial operates in both reception and transmission conditions.

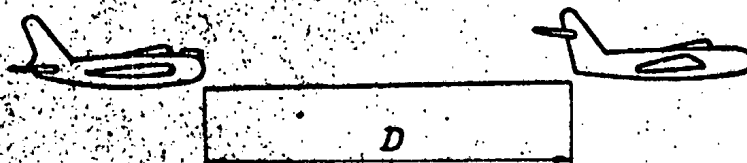

Fig. 4. Simplified view of an attacking aircraft and a flying target /target-aircraft/

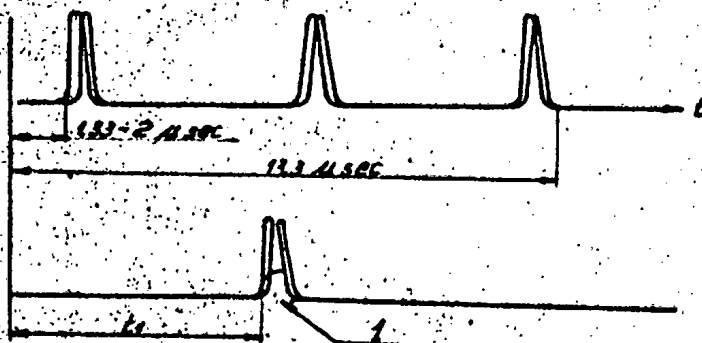

Fig. 5. Searching limits of gate pulses.
1 - signal reflected from a target.

50X1-HUM

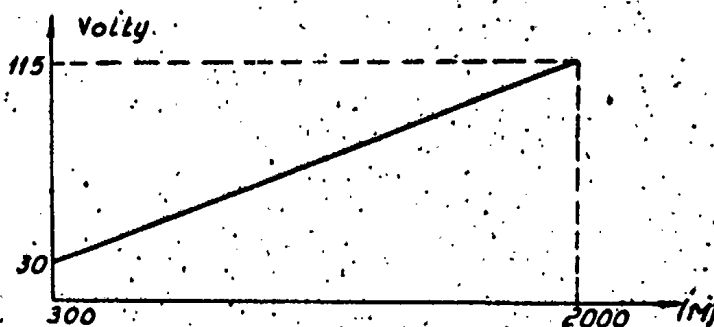

Fig. 6. Output voltage plotted against distance to target.

The receiver-transmitter unit serves for:

- creating high frequency pulses
- automatic tuning of heterodyne frequency
- reception and pre-amplification of reflected signals
- switching the aerial from reception to transmission
- synchronizing of operation of all device.

The transmitter-receiver unit consists of:

- high frequency magnetron generator with ventilator motor
- modulator
- submodulator
- limiting diode of starting and blocking pulses
- klystron oscillator
- antenna switching chamber with heater
- receiver mixer chamber
- ARCz mixer chamber /ARCz = automatic frequency control/
- intermediate frequency pre-amplifier
- automatic frequency control circuit of the high voltage rectifier
- ignition rectifier /firing rectifier/

The range unit serves for further amplification of the intermediate frequency; for registering the time of reflected pulse return as well as for generating a voltage proportional

- 0 -

S-E-C-R-E-T

(NO FOREIGN DISSEM)

NO FOREIGN DISSEM

50X1-HUM

to the distance to the target.

The range unit consists of following subassemblies:

- receiving - amplifying channel
- automatic gain control /ARC/ circuit for noises and pulses
- high speed sawtooth generator.
- comparator diode
- gate pulses generator
- synchronising circuits
- loading and discharging diodes of differential capacity
- integrator and slow sawtooth limiter according to maximum and minimum.
- slow speed sawtooth generator
- dividing circuits
- memory circuit.

The supply unit serves for supply following circuits:

- anode, grid and filament circuits of range unit valves
- " " " " " " of the ARCz circuits valve
- /ARCz - automatic frequency control/
- submodulator anode
- oscillator's control electrode
- anodes and third grids of the intermediate frequency pre-amplifier /MPCz/ in the transmitter-receiver unit,
- ASP-4M sight /supplied with regulated voltage/
- the supply unit serves also for switching on the range finder high voltage.

The supply unit consists of :

- a + 400 Volts voltage rectifier
- a - 230 " " "

voltage regulators

relay for switching on the high voltage

The test board serves for checking the electric parameters of the radio range finder, for setting the ARCz amplification /ARCz - automatic frequency control/, the dividing circuits and the "zero" distance voltage.

The test board is provided with potentiometers /for ARCz amplification setting, for setting the dividing circuits sensitivity and the "zero" distance voltage/ as well as with

- 10 -

S-E-C-R-E-T

(NO FOREIGN DISSEM)

S-E-C-R-E-T
NO FOREIGN DISSEM

50X1-HUM

two fuses. To check the electrical parameters it is necessary to connect the test board to a KPM/V check instrument.

The control board serves for switching on the radio range finder, for high voltage switching on, as well as for switching the different guns.

A neon lamp is installed in the control board. It checks the high voltage for switching on. Moreover the control board is provided with a "ballistic" switch, with a "włacz. wysokie" switch /high voltage on/, with a button "wzrost" /target abandoning/ as well as with a "właczanie radio dalmierza" switch /range finder master switch/.

Connecting cables join all described units in a set. The radio range finder is supplied from a secondary supply source i.e. from a MA-500 M converter.

The 27 Volts \pm 10 % aircraft network is a primary supply source.

3. Circuit diagram

Fig. 8 illustrating the general circuit diagram explains the principle of cooperation of the SRD-1M range finder's units.

The range finder operation conditions are not the same during the target searching /when there is no pulse reflected from a target/ and during the target tracing /when the reflected signal reaches the receiver input/. Due to this fact the description of the circuit diagram has been divided into two parts:

- a/ target searching
- b/ target tracing.

Target searching

A 2V-1 /6N3P/ submodulator blocking-generator has been applied for the range finder as a control generator. The blocking generator cooperating with the left section of 2V-1 /6N3P/ double triode, generates positive pulses with a 220 Volts amplitude and 1,3 \pm 1,5 μ sec pulse time /duration/, with a 500 c/s frequency. These pulses control the operation of the

S-E-C-R-E-T
NO FOREIGN DISSEM

NO FOREIGN DISSEM

50X1-HUM

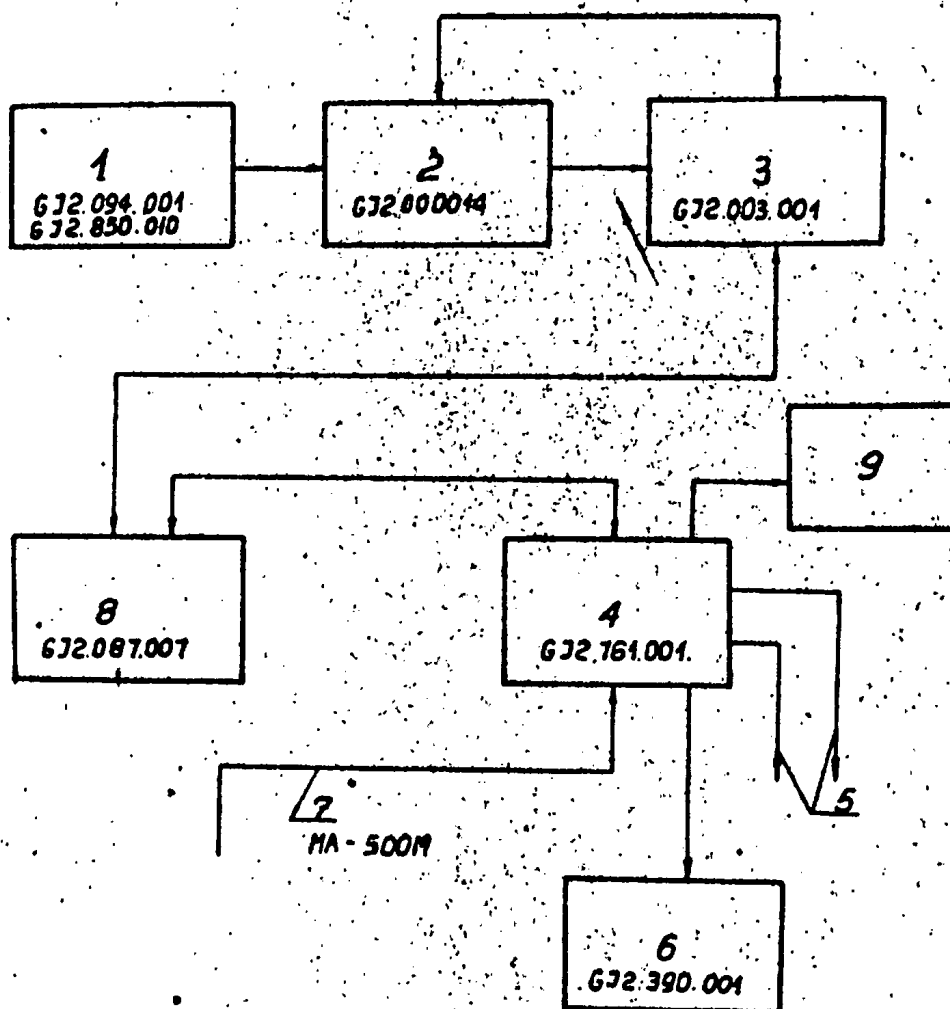

Fig. 7. Block-diagram of the SRD-1M range finder

- 1 - aerial with cable
- 2 - transmitter-receiver unit
- 3 - range unit
- 4 - test board
- 5 - to the ASP-4N
- 6 - control board
- 7 - supply from the MA-500M converter
- 8 - supply unit
- 9 - target searching switch.

- 12 -

S-E-C-R-E-T

NO FOREIGN DISSEM

S-E-C-R-E-T
NO FOREIGN DISSEM

50X1-HUM

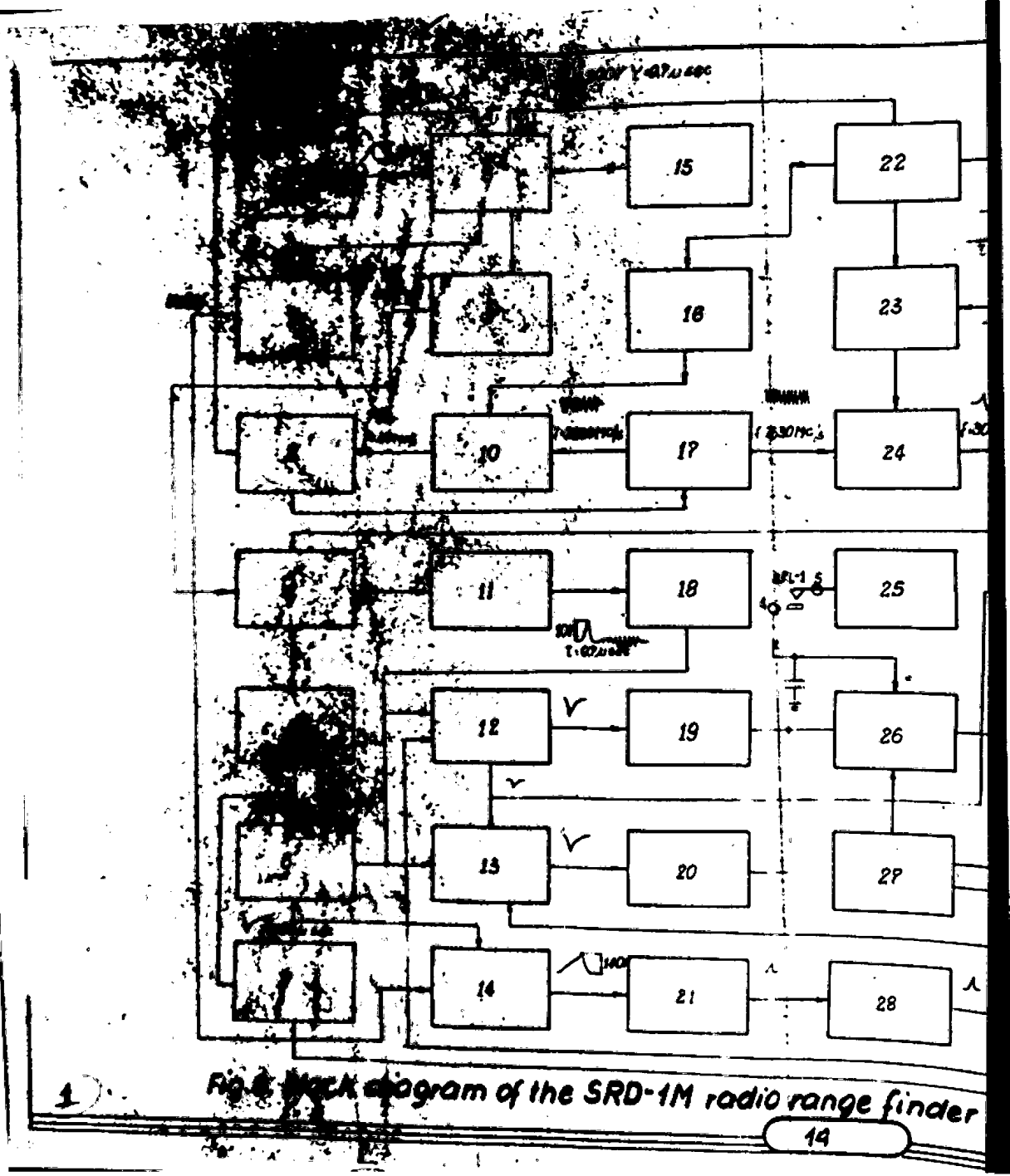

S-E-C-R-E-T
NO FOREIGN DISSEM

NO FOREIGN DISSEM

50X1-HUM

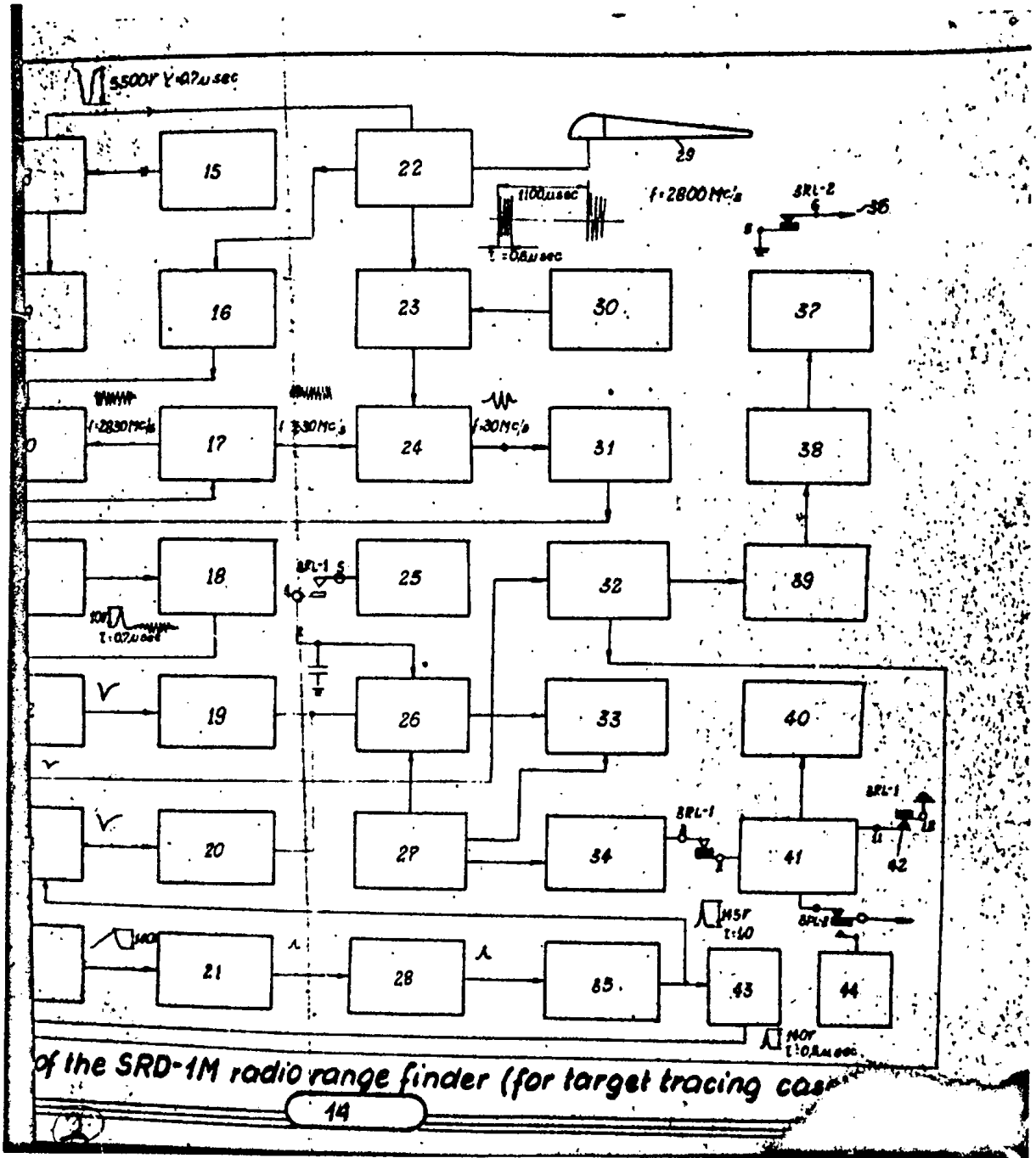

of the SRD-1M radio range finder (for target tracing case)

S-E-C-R-E-T
NO FOREIGN DISSEM

NO FOREIGN DISSEM

50X1-HUM

- 1 - 2V-1 /6N3P/ submodulator
- 2 - 2V-16b /6N1P/ starting pulse limiting diode
- 3 - ARCs /automatic frequency control/ 2V-11, 2V-12-6 ZP
2V-13 /6H2P/, 2V-14 /6H1P/, 2V-15 /6K2P/ valves
- 4 - WPCs /intermediate frequency amplifier/ 3V-14 + 3V - 17
/6Z3P/
- 5 - ARW /automatic gain control/ cathode follower 3V-22b
/6H1P/
- 6 - ARW /automatic gain control/ for noises 3V-20 /6ZP/
3V-7 /6N1P/
- 7 - ARW " " " " for pulses 3V-6 /6H1P/
- 8 - 2V-2; TG11-35/3 modulator
- 9 - blocking pulse limiting diode 2V-16b /6H1P/
- 10 - automatic frequency control mixer 2D-2 /DG-S2/
- 11 - 3V-18 /6H2P/ second detector
- 12 - 3V-21 /6ZP/ coincidence valve
- 13 - 3V-5 /6ZP/ " " "
- 14 - slow sawtooth generator 3V-1 /6H1P/; 3V-2 /6Z3P/
- 15 - high voltage rectifier 2V-7, W1-0,03/13
- 16 - attenuator /60 decibels/
- 17 - 2V-4 /K-12/ klystron heterodyne
- 18 - video-amplifier and cathode follower 3PL-1; 8V-19 /6N3P/
- 19 - integrating capacity loading diode 3V-12b /6N2P/
- 20 - 3V-12b /6X2P/ integrating capacity discharging diode
- 21 - 3V-3b /6N1P/ comparator diode
- 22 - 2P-3 /MI-120/ magnetron generator
- 23 - 2V-5 /RR-5/ aerial switching device
- 24 - receiver mixer 2D-1 /DG-S2/
- 25 - slow sawtooth generator 3V-9 /MN-7/
- 26 - amplifier 3V-8 /6Z5P/
- 27 - slow sawtooth limiting diode according to minimum
3V-11b /6H1P/
- 28 - starting amplifier 3V-4b /6N1P/
- 29 - aerial
- 30 - ignition rectifier /firing rectifier/ GG 10,012 128;
2V-6.

- 15 -

S-E-C-R-E-T

NO FOREIGN DISSEM

NO FOREIGN DISSEM

50X1-HUM

- 31 - intermediate frequency pre-amplifier 2V-8 + 2V - 10 /6ZP/
- 32 - 3V-10a /6N1P/ pre-amplifier
- 33 - 3V-22b /6N1P/ slow sawtooth limiting diode
- 34 - 3V-3b /6N1P/ cathode follower
- 35 - 3V-4b /6N1P/ blocking generator
- 36 - to the lamp of target interception in the ASP-4N sight.
- 37 - 3RL-1 relay
- 38 - 3V-11b /6N1P/ relay valve
- 39 - 3V-10b /6N1P/ peak detector
- 40 - 3RL-2 relay
- 41 - memory circuit
- 42 - ASP-4N voltage dependent on distance to target
- 43 - 0,5 usec delay line
- 44 - Voltage divider in the + 250 Volts circuit.

- 16 -

S-E-C-R-E-T

NO FOREIGN DISSEM

50X1-HUM

A part of the high frequency pulse from the magnetron generator goes through the attenuator to the ARCz mixer chamber /ARCz = automatic frequency control/.

In place of a mixer a AGS 2 /2D-2/ detector is used. At the same time continuous high frequency oscillations of the 2V-4 /K-12/ klystron oscillator are fed into the ARCz mixer chamber /ARCz = automatic frequency control/. As a result of two high frequency oscillations beating in the ARCz circuit input, a new impulse is generated. Its frequency equals to the difference between the frequency of magnetron generator oscillations and the klystron oscillator frequency. If the frequency difference between the klystron and magnetron generator oscillations exceeds 30 Mc/s, the automatic frequency control circuit generates a control voltage /which is transmitted to the klystron/ keeping therefore the klystron frequency 30 Mc/s higher than the magnetron generator one.

The shape of the ARCz starting pulse is shown in Fig. 9 /ARCz = automatic frequency control/.

The starting pulse is transmitted to the range unit by means of a starting pulse 2V-15b /5N1P/ limiting diode in order to start the high speed sawtooth generator 3V-1 /6N1P/ and 3V-2 /6Z3P/.

The shape of starting pulse is illustrated in Fig. 9.

The high speed sawtooth generator transmits sawtooth pulses to the 3V-3b /6N1P/ comparator diode.

These pulses frequency is equal to 900 c/s, their time to $< 5 \mu\text{sec}$, their amplitude equals to 145 Volts.

A sawtooth pulse generated by the high speed sawtooth generator is illustrated in Fig. 9.

Moreover a sawtooth voltage is taken from the slow speed sawtooth 3V-9 /6N-7/ generator and transmitted to the comparator diode through 4-5 contact points of 3RL-1 relay, 3V-8 /6Z5P/ amplifier, 3V-11b /5N1P/ slow sawtooth limiting diode according to minimum, as well as through the 3V-5a /6N1P/ cathode follower.

This sawtooth voltage varies from 30 to 40 Volts during $0,67 + 2 \mu\text{sec}$.

During the increase of the slow sawtooth generator amplitude, with 900 c/s frequency, in a continuous manner a gradual

intensifying voltage limiting arises concerning the amplitude and the time. Therefore a sawtooth pulse is transmitted to the 3V-4a /6N1P/ starting amplifier. The pulse beginning delays more and more relatively to the transmitter starting pulse with the searching generator voltage increase.

The pulse becomes amplified and starts the 3V-4b /6N1P/ blocking generator by the pulse's rising part. /Front/.

The blocking generator oscillates and generates a gate pulse with 140 Volts amplitude and 0,7 μ sec pulse time. The gate pulse is transmitted to the 3V-5 /6Z1P/ coincidence valve and then to the 3V-21 /6Z1P/ valve by means of a 0,5 μ sec delay time.

Fig. 6, 5 illustrate how the gate pulses pass the 300 - 2000 μ searching range with 0,5 - 1,5 c/s when the slow speed sawtooth generator voltage increases.

The slow sawtooth limiting according to maximum is obtained by the help a 3V-22a /6N1P/ valve.

Noises from the receiver cathode follower output /right section of the 3V-19 /6N3P/ valve/ come into the automatic gain control circuit for noises which includes the valves 3V-20 /6Z2P/, 3V-7 /6N1P/.

The automatic gain control /ARW/ circuit for noises creates a negative voltage according to noises voltage level. This negative voltage comes into the FPCs /intermediate frequency amplifier/ through the 3V-22b /6N1P/ cathode follower of the automatic gain control circuit, keeping thus the constant noises value in the receiver output. A 25 μ sec negative pulse comes into the 3V-20 /6Z2P/ valve from the high speed sawtooth generator circuit. This pulses block the automatic gain control circuit for noises during the reception time, eliminating thus the influence of target pulses on the ARW for noises circuit operation. /ARW = automatic gain control/

There is no voltage on the 3P-1 and 3P-2 relays windings. When the 4-5 contact points of the 3P-1 relay are closed, the output of 3V-9 slow speed sawtooth generator is thus connected to the 3V-8 amplifier input.

If the 1-2 contact points of the 3P-2 relay are closed, the direct +250 Volts voltage is transmitted from the divider to the counting circuit of the ASP-4M sight.

50X1-HUM

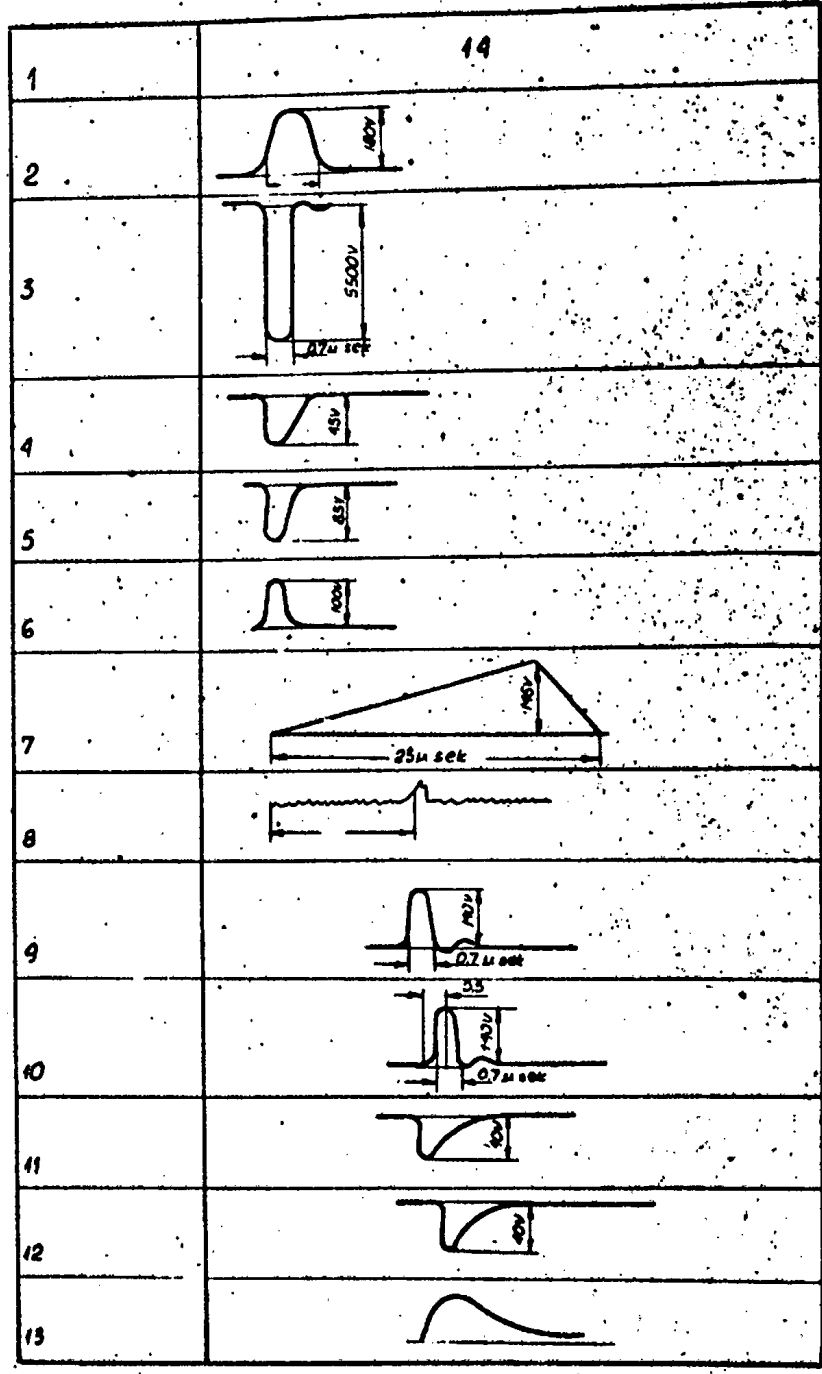

Fig. 5. Pulse voltage chart of the SRD-1K range finder.

S-E-C-R-E-T
NO FOREIGN DISSEM

50X1-HUM

Fig. 9. Pulse voltage Chart of the SRD-1M range finder.

- 1 - Measurement point /place/
- 2 - Submodulator pulse on the 2R-6
- 3 - modulating pulse on the magnetron cathode
- 4 - blocking pulse on the cathode of the 2V-16 valve left section,
- 5 - starting pulse on the cathode of the 2V-16 valve right section,
- 6 - automatic frequency control starting pulse on the 2R-51
- 7 - high speed sawtooth pulse on the 3V-2 valve control grid
- 8 - target pulse on the 3V-5 valve control grid
- 9 - gate pulse on the third grid of the 3V-5 valve.
- 10 - " " " " " " " " 3V-21 valve.
- 11 - pulse on the anode of the 3V-5 valve
- 12 - pulse on the anode of the 3V-21 valve
- 13 - " " " " " " " " 3V-10a "
- 14 - shape, time, and amplitude of pulse.

-50X1-HUM

Operation in target tracing conditions

The pulses reflected from the target come into the "nada-wanie - odbior" /transmission-reception/ chamber of the aerial switch. This switch is formed by a cavity resonance circuit tuned for the generator frequency /for the reflected signals frequency/. The reflected signal energy comes into the receiver mixing chamber from the "transmission-reception" chamber. A DG-S2 /2D-1/ crystal detector has been applied for a mixer in the receiver mixing chamber.

In the receiver mixing chamber the frequency of the reflected signal becomes mixed with heterodyne oscillations. The heterodyne operates with a K-12 /2V-1/ klystron. The mixing process results in several frequencies from which a 30 M.c./s intermediate frequency is separated on the mixer load. The receiver mixer load is formed by an input circuit of the intermediate frequency pre-amplifier /WPCz/.

The signal reflected by the target comes into the intermediate frequency main amplifier operating with valves type 6Z3P /3V-14, 3V-15, 3V-16, 3V-17/ after having passed the WPCz^{*} circuit operating with valves 6Z3P /2V-3, 2V-9, 2V-10/.

After the amplification in the WPCz^{*} and detection in the second 3V-18 /6H2P/ detector, the target signal passes to 3V-5; 3V-21 /6Z1P/ coincidence valves through the video-amplifier /3V-19 /6N3P/ valve left section/ and a cathode follower /right section of the 3V-19 valve/.

The coincidence valves start their operation at the moment of interference of the reflected target pulse and the gate pulses /see Fig. 10/

A negative pulse is obtained from the coincidence valves. This pulse is amplified by the 3V-10a /6N1P/ pre-amplifier then, it passes through the 3V-10b /6N1P/ peak detector and

* /WPCz = intermediate frequency pre-amplifier.

WPCz = intermediate frequency amplifier.

50X1-HUM.

unblocks the 3V-11a /6N1P/ relay valve.

The 3P-1 relay starts its operation when the 4-5 contact points open. The 3-2 contact points close with the slow sawtooth generator off, and a voltage proportional to the distance is taken from a 3V-3a /6N1P/ cathode follower and fed into the 3V-13 memory circuit. The 11-12 contact points close and the 3P-2 relay starts its operation.

The 5-6 contact points close, the green lamp on the ASP-4N sight glimmers indicating thus the target interception.

Then, the 2-3 contact close and a voltage proportional to the distance to the target passes to the ASP-4N sight counting /computing/ circuits.

The radio range finder begins the operation in target tracing conditions and generates a voltage which is proportional to distance to the target.

At the moment of target interception, with slow speed sawtooth generator off, this voltage remains on the C_1 integrating capacity being proportional to the distance to the target at the moment of 3P-1 operation start.

The C_1 integrating capacity is connected with the 3V-8 amplifier input. The voltage becomes thus amplified by this amplifier, then, limited by 3V-11b limiting valve and fed through the 3V-3a cathode follower to the comparator diode instead of slow sawtooth generator voltage in order to control the gate pulses displacement.

Owing to coincidence valves operation the negative pulses taken from these valves are fed to loading and discharging diodes type 3V-12a, 3V-12b /2N2P/.

The C_1 integrating capacity is charged and discharged by the help of 3V-12 a and 3V-12b diodes. It depends on the more unblocked valve.

The charging and discharging current of the C_1 integrating capacity is proportional to pulse amplitude and length in circuits of coincidence valves anodes.

The difference in charging and discharging currents of the C_1 integrating capacity causes voltage variation till the same currents are fed through both coincidence valves i.e. till the reflected pulse is stabilized between gate pulses.

NO FOREIGN DISSEM

50X1-HUM

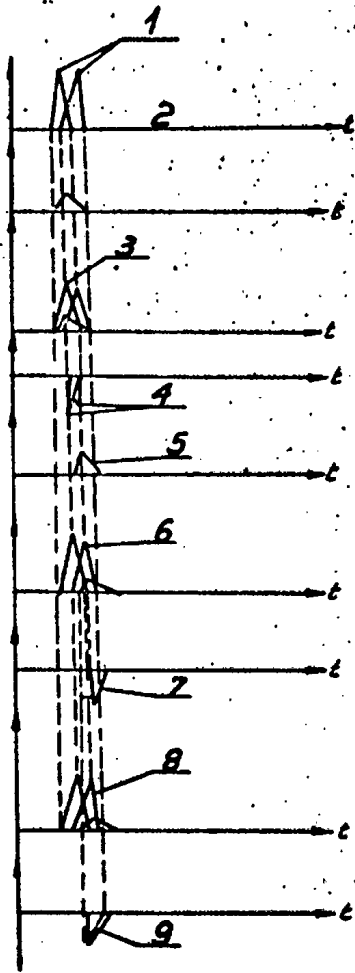

Fig. 10. Interference of a target signal with gate pulses.

S-E-C-R-E-T
NO FOREIGN DISSEM

50X1-HUM

- 1 - gate pulses
- 2 - signal reflected by the target
- 3 - interference of a target signal with the I-st gate pulse
- 4 - pulses on anodes of 3V-5 and 3V-21 coincidence valves
- 5 - signal reflected by the target
- 6 - interference of a target reflected signal with the II-nd gate pulse
- 7 - pulse on anodes of 3V-5; 3V-21 coincidence valves
- 8 - moment of target signal stabilising between two gate pulses
/between gate pulses forks/
- 9 - pulses on anodes of 3V-5 and 3V-21 coincidence valves.

- 24 -

(S-E-C-R-E-T)
NO FOREIGN DISSEM

NO FOREIGN DISSEM

50X1-HUM

In such a case the C_1 integrating capacity voltage does not vary practically.

If the target signal disappears the 3R-1 relay opens its contact points and thus the target searching is recommenced. The 3P-2 relay opens its contact points with a 3-4 sec delay. Through its contact points a range /distance/ voltage is fed to the ASR-4N sight.

The output range voltage continues to vary, at this time, according to the same curve as at the moment of target signal disappearance.

This fact is enabled owing to memory circuit which operates with a 3V-13 /6N1P/ valve.

The pulse of 3V-1Ca dividing circuits pre-amplifier is operating as an output signal in the ARW circuit for pulses /ARW = automatic gain control/

This pulse is amplified in the left section of the 3V-6 /6N1P/ valve.

Now, the amplified and "stretched out" pulse is detected by a diode /3V-6 /6N1P/ valve's left section/ and fed to the WPCz^{*} as a negative pre-voltage through a 3V-22b cathode follower in order to vary the receiver amplification.

The variation in receiver amplification is necessary to prevent the overloading of receiver circuits as well as to reduce errors in determination of distance to targets which correspond to different intensity of reflected signal. The ARW^{*} for noises circuit operation is the same during the target searching as well as during the target tracing.

Both ARW^{*} circuits /for pulses and for noises/ have a common output in the WPCz^{*} circuits through a 3V-22b cathode follower.

*/ WPCz = intermediate frequency amplifier.
ARW = automatic gain control.

- 25 -

S-E-C-R-E-T

NO FOREIGN DISSEM

NO FOREIGN DISSEM

50X1-HUM

III. ANTENNA CIRCUIT

1. Destination:

The aerial circuit is designed:

- for energy transmission from the high frequency generator to the antenna,
- for power radiation outside the aircraft
- for reflected /by target/ pulses reception
- for pulses transmission to the receiver
- to create a determined antenna radiation zone.

The SRD-1M range finder antenna assembly consists of a dielectric antenna and of a coaxial cable.

2. Operation principle of the dielectric antenna

The dielectric aerial of the SRD-1M radio range finder is a special kind of surface wave antenna. It is well known that electromagnetic waves propagate along the limit of mediums when the dielectric rod is excited by a vibrator, placed inside the rod.

The speed of these waves propagation differs from the speed of waves propagation in the air or in an illimitable dielectric medium. The propagation speed is determined by the dielectric rod cross section surface as well as by the dielectric constant of the rod material.

If the cross section surface and the rod material are chosen in order to near the surface wave propagation speed to the speed of electromagnetic waves propagation in the air, the maximum radiation direction of such a rod will be along its longitudinal axis.

The optimum value of dielectric rod length is $2,5 + 4,6 \lambda$

3. Main technical data of the SRD-1M range finder antenna circuit.

1. The antenna operates /at $\frac{1}{2}$ power/ within $28^{\circ} \pm 2^{\circ}$ in the horizontal plane and within $20^{\circ} \pm 4^{\circ}$ in the vertical one.
2. The side lobes of radiation pattern do not exceed 5% of

- 25 -

S-E-C-R-E-T

NO FOREIGN DISSEM

50X1-HUM

of relative power values created in different directions the same distance/, the values being dependent on these directions.

The radiation pattern of the SRD-1M range finder antenna in rectangular axis is represented in Fig. 11.

Expansion angle or radiation pattern width is an angle formed by two straight lines, corresponding to $\frac{1}{2}$ radiated power.

The electromagnetic energy radiated by the antenna is concentrated within the main lobe of the radiation pattern, however a part of this energy is concentrated also within side /parasite/ lobes.

The energy accumulation within side lobes causes an useless dissipation of a radiated energy part and, therefore, a reduction of station resistance against disturbances.

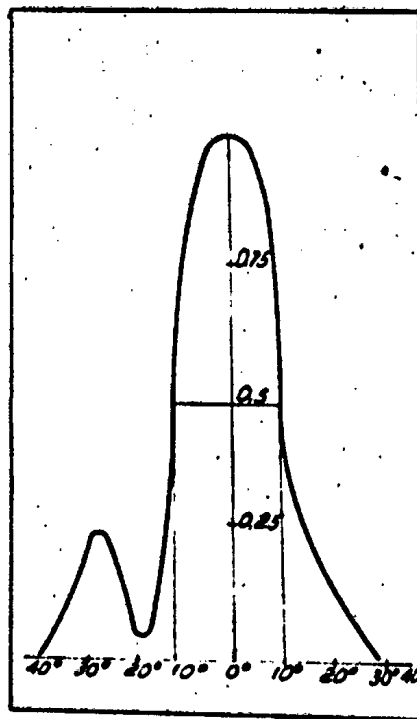
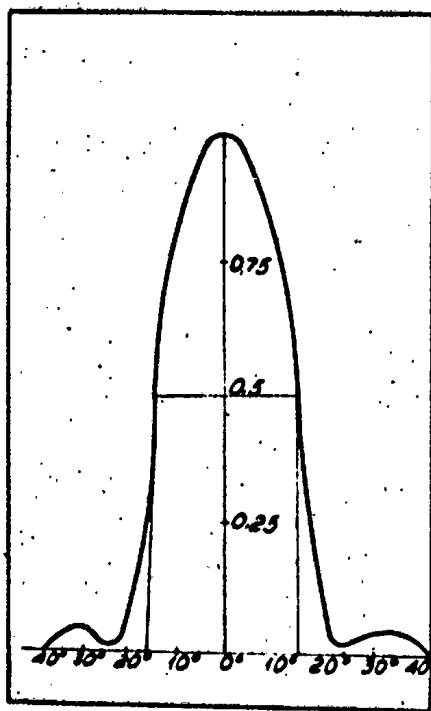

Fig. 11a. Antenna radiation pattern in horizontal plane

Fig. 11b. Antenna radiation pattern in vertical plane.

Fig. 11. Radiation pattern of the SRD-1M aerial.

Then, the intensity of side lobes radiation should be diminished as possible.

The side lobes intensity is a relationship of max. value of power density in the greatest side lobe to the max. power density value in the main lobe. This intensity is given usually in percents.

The radiation pattern of an antenna circuit depends on the length of the dielectric rod as well as on its cross section surface.

The greater the conical rod, the sharper the radiation pattern; the smaller a side lobes intensity. The cross section of the dielectric rod should be chosen according to λ_0 - length of electromagnetic wave in the air and to ϵ - dielectric constant of the rod's material.

The best cross section of the rod can be evaluated by means of a following formula:

$$S = 0,1 \div 0,25 / \frac{\lambda_0}{\epsilon - 1}$$

where:

λ_0 = length of wave in the air

ϵ = dielectric constant of the rod's material.

The coefficient 0,25 should be employed when determining the greatest diameter of the conical rod according to the formula

$$S = \frac{\pi d_{\max}^2}{4}$$

The coefficient 0,1 should be used for evaluation of minimum diameter.

A metal cap employed as a reflector is installed on the dielectric rod's end in order to obtain a single - direction radiation /transmission/ and reception.

A vibrator serves for excitation of oscillations in the antenna.

The wave matching of a coaxial feeder to the vibrator radiation impedance can be obtained by depth variation of vibrator plunging into the dielectric rod.

NO FOREIGN DISSEM

50X1-HUM

During the excitation by a vibrator /pin/ placed perpendicularly to the rod's axis an unsymmetrical H - 1,1 wave arises first of all.

An H-wave is a wave which has a longitudinal component of magnetic field, while the electric field lines are acting in perpendicular plane to the propagation direction.

Diameter of metal cap which forms a dielectric - filled waveguide should be chosen so, that an unsymmetrical H-Wave arises in the cap. This wave type gives always the max. radiation along the antenna axis.

The conical part of the dielectric rod is necessary to match the rod wave impedance with the wave impedance in the space outside the aircraft. This causes the antenna amplification factor increase and the reduction of quantity of radiation pattern side lobes.

Besides the radiation pattern, there are other important electric parameters which characterize the aerial:

η_A aerial efficiency factor
G amplification factor

The antenna efficiency factor η_A defines the energy loss in the antenna. It can be evaluated due to the following formula:

$$\eta_A = \frac{P_E}{P_A}$$

where:

P_E = power transmitted to the antenna
 P_A = power radiated by the antenna

The amplification factor "G" is a relationship between two values:

- density of power radiated in the max. radiation direction.
- power density of an omnidirectional antenna operating in the same direction without losses, and requiring the same power.

The amplification factor gives a full characteristic of an antenna since this factor taken into account the radiation resulted from directional properties of an aerial as well as

- 30 -

S-E-C-R-E-T

NO FOREIGN DISSEM

NO FOREIGN DISSEM

50X1-HUM

the radiation power drop due to antenna losses.

The amplification factor can be evaluated as a product of gain ratio multiplied by efficiency factor:

$$G = \eta \cdot \eta_A$$

where:

G = antenna amplification factor

η = " gain ratio

η_A = " efficiency factor

The electromagnetic energy is fed from the generator to the antenna or from the antenna to the receiver by means of waveguides /feeders/.

A great importance, from the point of view of full power transmission to the load, has a suitable matching of load and wave impedance of the feeder.

In this case, of suitable matching, all energy from the generator is fed to the load without reflections.

Such operation conditions are called /pure/ travelling wave conditions.

The feeder load impedance, at which /pure/ travelling wave conditions are stabilized is equal to the feeder impedance.

The wave impedance of a feeder /waveguide/ depends on feeder dimensions.

The wave impedance, for a high frequency coaxial feeder, can be calculated according to formula:

$$Z = \frac{138}{\sqrt{\epsilon}} \cdot \lg \frac{D}{d}$$

where:

D = inner diameter of an outer feeder part

d = diameter of the inner feeder load /core/

ϵ = dielectric constant of the dielectric material employed in the feeder.

If the matching is not a full one i.e. the feeder is loaded with a load which is not equal to wave impedance, a part of energy reflects and partially standing waves of current and voltage arise in the feeder.

S-E-C-R-E-T

NO FOREIGN DISSEM

50X1-HUM

A partially standing wave is noticeable due to its uneven current and voltage amplitude distribution/pattern/ along the feeder

Fig. 12 represents a diagram of voltage amplitudes appearing along the feeder in partially standing waves conditions. The matching quality is expressed in form of a standing wave or travelling wave coefficient. A standing wave coefficient is a relationship of max. voltage or current values in a feeder to their minimum values:

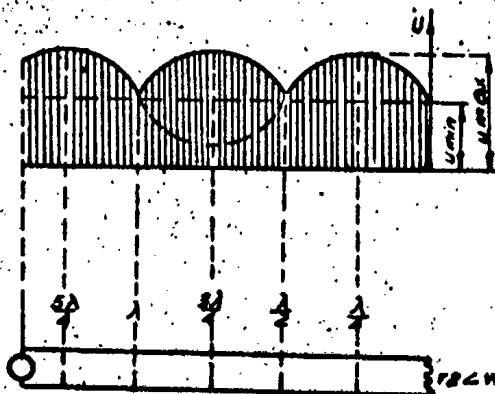

Fig. 12. Distribution of voltage amplitudes along the feeder.

The standing wave coefficient /WFS/ is equal to:

$$WFS = \frac{I_{max}}{I_{min}}$$

the travelling wave coefficient:

$$WFB = \frac{I_{min}}{I_{max}} = \frac{1}{WFS}$$

S-E-C-R-E-T

NO FOREIGN DISSEM

50X1-HUM

The better the matching, the smaller a difference between I_{max} and I_{min} , therefore the smaller the standing wave coefficient and the greater the travelling wave one.

In an ideal case, in pure travelling wave conditions, the VSWR is equal to 1 and $V_{FB} = 1$ too.

In the antenna circuit of the SRD-1M range finder the suitable matching of feeder and antenna can be obtained by means of depth variation of diving the antenna exciting vibrator.

The matching of antenna wave impedance with an ambient zone /space/ wave impedance is obtained owing to the conical shape of the dielectric rod.

The rod's wave impedance is less than the ambient space one. The conical shape causes the rod's wave impedance increase.

4. Antenna circuit construction

The antenna is formed by a conical polyethylene dielectric rod.

This rod is cut along the cross section diameter and fastened to a metallic screen. Under the influence of this screen-plate the max. /optimum/ antenna radiation direction deflects upwards from the rod axis by $12 \text{ deg} \pm 1 \text{ deg}$.

A general view of the aerial and antenna cable is shown in Fig. 13 and 14.

The thick part of the rod is covered by a metallic cap and has an aperture for the exciting vibrator.

The vibrator is formed by a prolongation of the coaxial cable inner core, by means of which the energy from the transmitter-receiver unit to the antenna is fed.

The outer part of the coaxial cable is connected with a metallic cap, which holds the dielectric rod at the base, forming thus a waveguide.

The dielectric antenna is fastened rigidly to the metallic screen plate, joined with a connector which forms a coaxial line with 50 ohms wave impedance. A high frequency feeder is connected with this coaxial line.

- 33 -

S-E-C-R-E-T

NO FOREIGN DISSEM

S-E-C-R-E-T
NO FOREIGN DISSEM

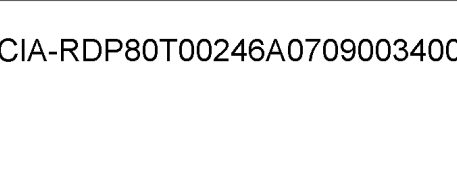

50X1-HUM

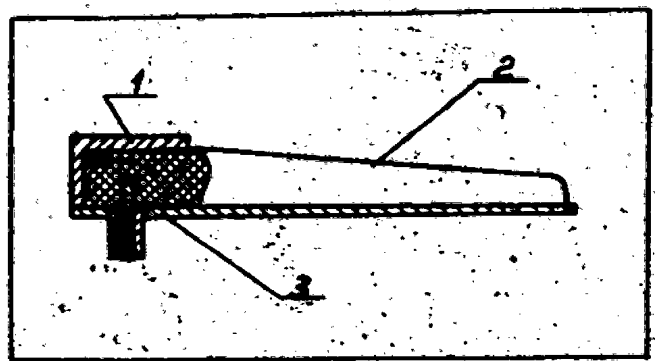

Fig. 13. Simplified drawing of the antenna.
1 - ferrite cap, 2 - dielectric rod, 3 - exciting vibrator.

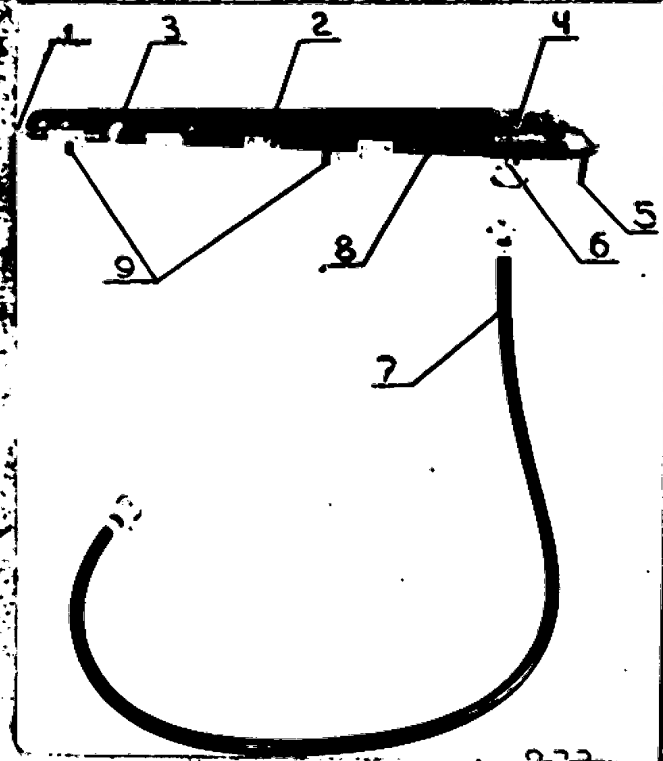

Fig. 14. General view of the antenna with cable
1 - pin, 2 - connecting plate, 3 - dielectric rod, 4 - cap
5-9 - pins, 6 - connector, 7 - coaxial cable, 9 - screen plate.

S-E-C-R-E-T
NO FOREIGN DISSEM

S-E-C-R-E-T
NO FOREIGN DISSEM

50X1-HUM

The screen plate is fastened to the fuselage front room cover by means of four threaded bolts.

When the aircraft remains on ground the antenna should be protected by a metallic cover. The cover can be removed easily.

The energy from the receiver-transmitter unit is fed to the antenna by means of a flexible 50 Ohms feeder with high frequency connector on its ends.

The high frequency feeder consists of outer part and inner core located coaxially and separated by a hard dielectric material.

The inner core of the high frequency cable has a small diameter to make the cable flexible.

The inner core has been made of several thin wires in order to reduce the impedance for high frequency as well as to make the cable flexible.

The outer part of the high frequency cable is made in form of a thin copper wire braiding. In order to protect the outer braiding of the coaxial cable against corrosion and mechanical damage, the braid is covered externally by a special plastic hose.

IV. TRANSMITTER-RECEIVER UNIT

1. Destination.

The transmitter-receiver unit belonging to the SRD-1M range finder set is designed for:

- generation of powerful high frequency pulses
- automatic tuning of heterodyne frequency
- switching the antenna from transmission to reception
- reception and pre-amplification of signals reflected from a target. Pulse, which synchronise all station operation are generated in this unit too.

2. Unit's set

The transmitter-receiver unit consists of following accessories:

- 35 -

S-E-C-R-E-T
NO FOREIGN DISSEM

NO FOREIGN DISSEM

50X1-HUM

1. Submodulator
2. Modulator
3. Magnetron generator
4. Antenna switch
5. receiver mixer
6. ARCz mixer /ARCz = automatic frequency control/
7. Klystron heterodyne
8. intermediate frequency pre-amplifier
9. high voltage rectifier
10. ignition /firing/ rectifier
11. ARCz circuit /ARCz = automatic frequency control/

3. Main technical data of the transmitter-receiver unit.

The transmitter-receiver unit has following principal

parameters:

1. Pulse power $P_{imp} = 7 \text{ kW}$.
2. H.F. frequency $f = 2800 \pm 30 \text{ M.c./s}$.
3. modulating pulse length /time/ $T_{imp} = 0,7 \pm 0,05 \text{ -usec}$.
4. H.F. frequency band width at $\frac{1}{2}$ power $\Delta f = 3,5 \text{ M.c./s}$.
5. pulse frequency $\gamma = 930 \pm 100 \text{ c/s}$
6. starting pulse amplitude - at least 85 Volts
7. " " " of the ARCz /automatic frequency control/ should be equal to 100 Volts $\pm 20\%$
8. blocking pulse amplitude - 45 Volts $\pm 20\%$
9. high frequency channel sensitivity /with the receiver/ should be at least 66 decibels at 2000 meters. It should be at least 48 decibels at 550 meters, at 10 μ W.
10. mean magnetron current - 2,4 - 5,2 mA.
11. crystal current of the main channel - 0,2 - 0,8 mA
12. " " of the ARCz channel /ARCz = automatic frequency control/ - 0,5 - 1,5 mA.
13. ignition current of the discharging valve - 60 - 120 μ A.
14. mean frequency of the intermediate frequency pre-amplifier band is equal to $30 \pm 1 \text{ M.c./s}$.
15. The unit operates normally in following atmosphere conditions:

- 36 -

S-E-C-R-E-T

NO FOREIGN DISSEM

50X1-HUM

- a/ at the ambient air temperature variation from $\pm 0^{\circ}$ to -60 deg. C
- b/ after 48 hours spent in a relative humidity $\pm 98\%$ at $+20$ deg. C ± 5 deg. C
- c/ at altitudes up to 20000 meters; that is, at the atmospheric pressure variation from 760 to 41 mm Hg.

4. Description of the unit's operation

/according to block - diagram/

Fig. 15 represents a block-diagram of the transmitter-receiver unit.

The blocking generator of the submodulator, operating with left section of 2V-1 /6N3P/ double triode, generates positive voltage pulses with 220 Volts. amplitude, $1,3 \pm 1,5$ μ sec length, 930 c/s frequency. These pulses control the modulator discharging valve operation by means of a cathode follower operating with right section of the 2V-1 /6N3P/ valve.

Modulating pulses with 5,5 kV amplitude, 0,7 μ sec. pulse time /length/ and 930 c/s frequency are formed in the modulator operating with an artificial forming line and a 2V-1 /TGL-1-35/3/ hydrogen thyatron /as a discharging valve/. Then, these pulses are fed to the 2V-3 /MI-120/ magnetron.

The magnetron generator generates pulses with 0,6 μ sec. pulse length /time/, 2800 M.c./s frequency and power at least 7 kW. High frequency pulses of the magnetron generator are fed to the antenna which radiates them outside the aircraft. The receiving device is disconnected for the probe pulse time /duration/ owing to the antenna switch in which a RR-5 /2V-7/ valve has been employed as a discharging valve.

Simultaneously with the modulating pulse, following pulses are taken from the modulator:

- a negative blocking pulse with - 45 Volts amplitude
- " " starting pulse with - 85 Volts amplitude
- a positive starting pulse for the ARCz /automatic frequency control/ with + 100 Volts amplitude.

S-E-C-R-E-T
NO FOREIGN DISSEM

50X1-HUM

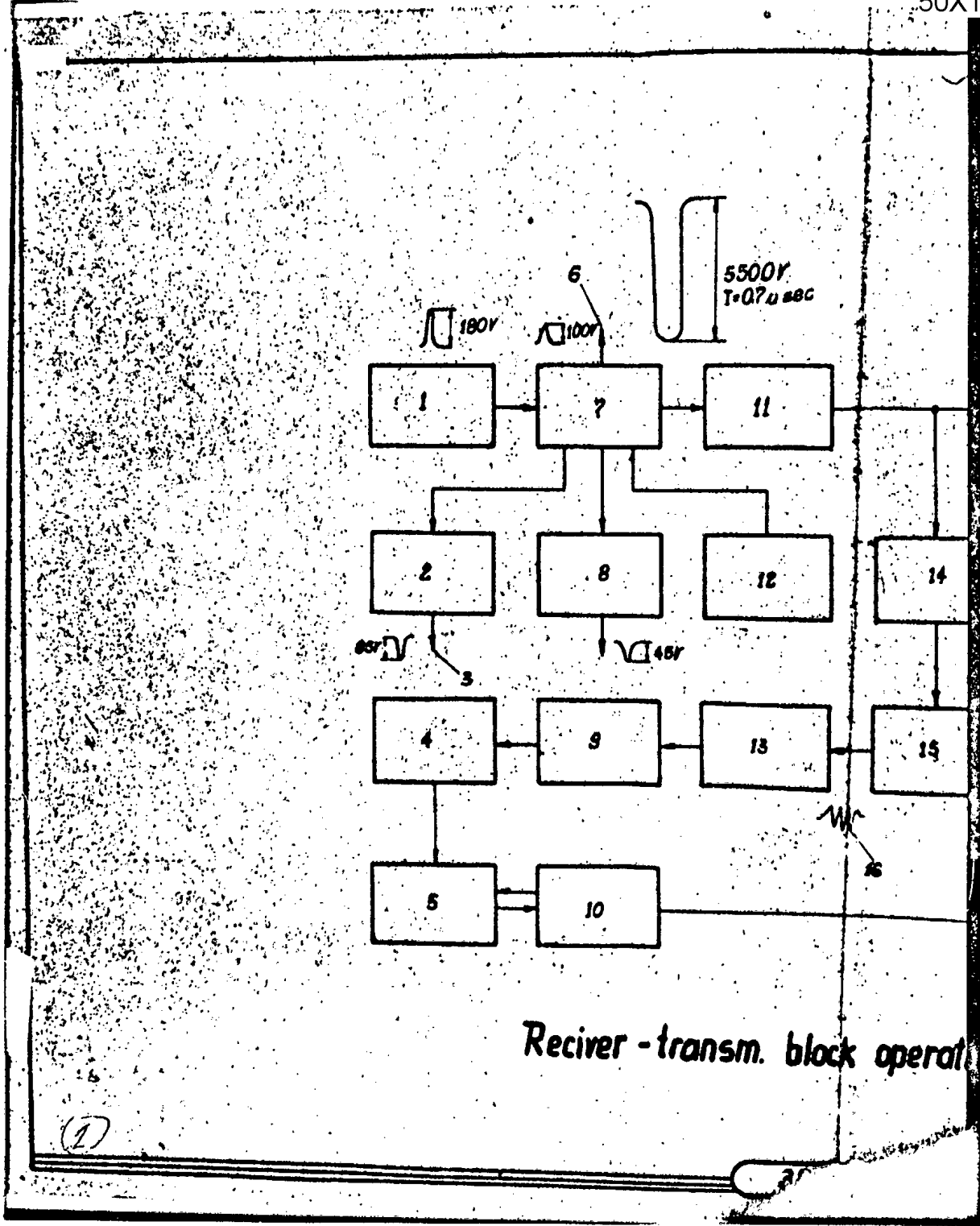

S-E-C-R-E-T
NO FOREIGN DISSEM

50X1-HUM

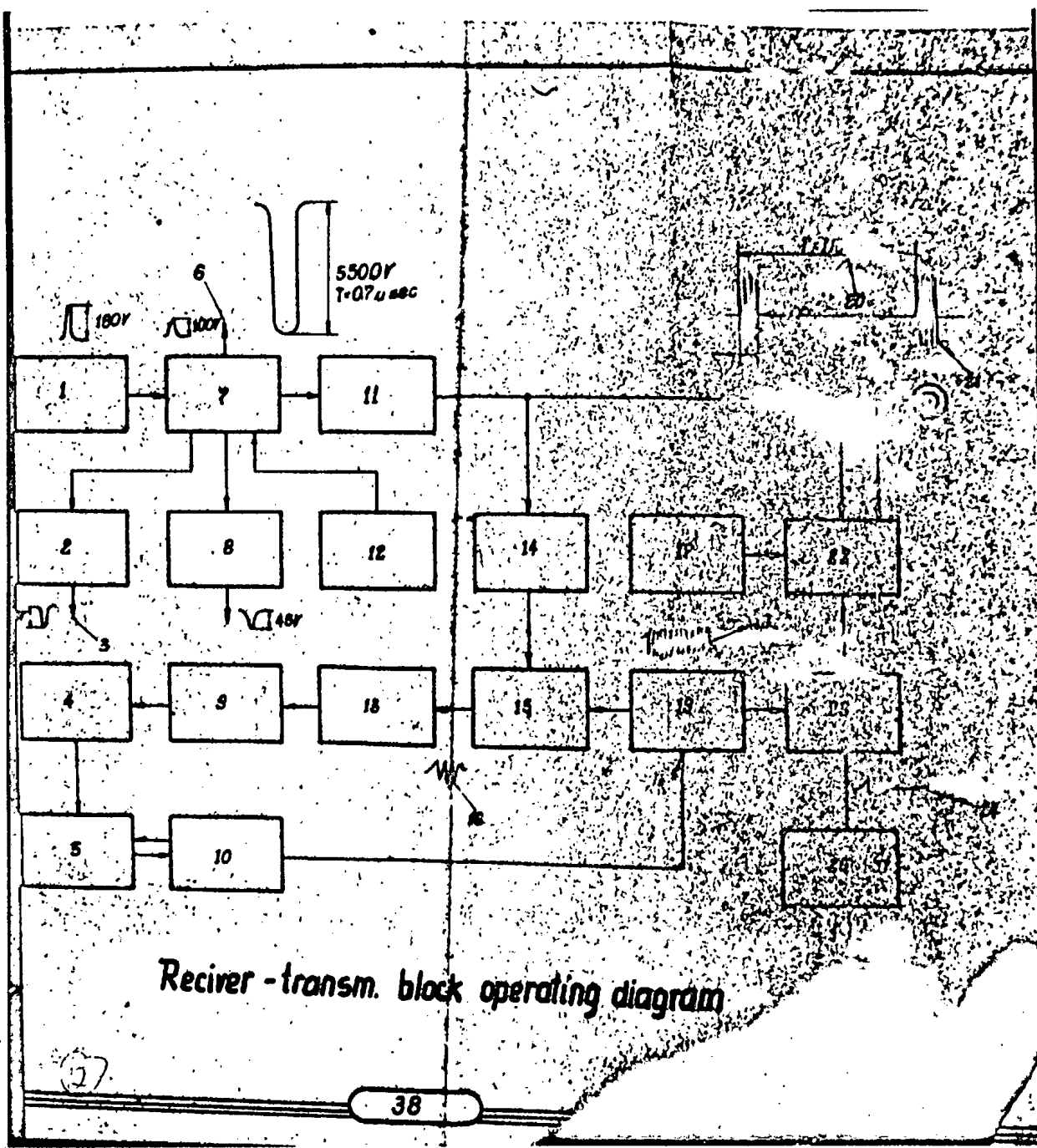

S-E-C-R-E-T
NO FOREIGN DISSEM

50X1-HUM

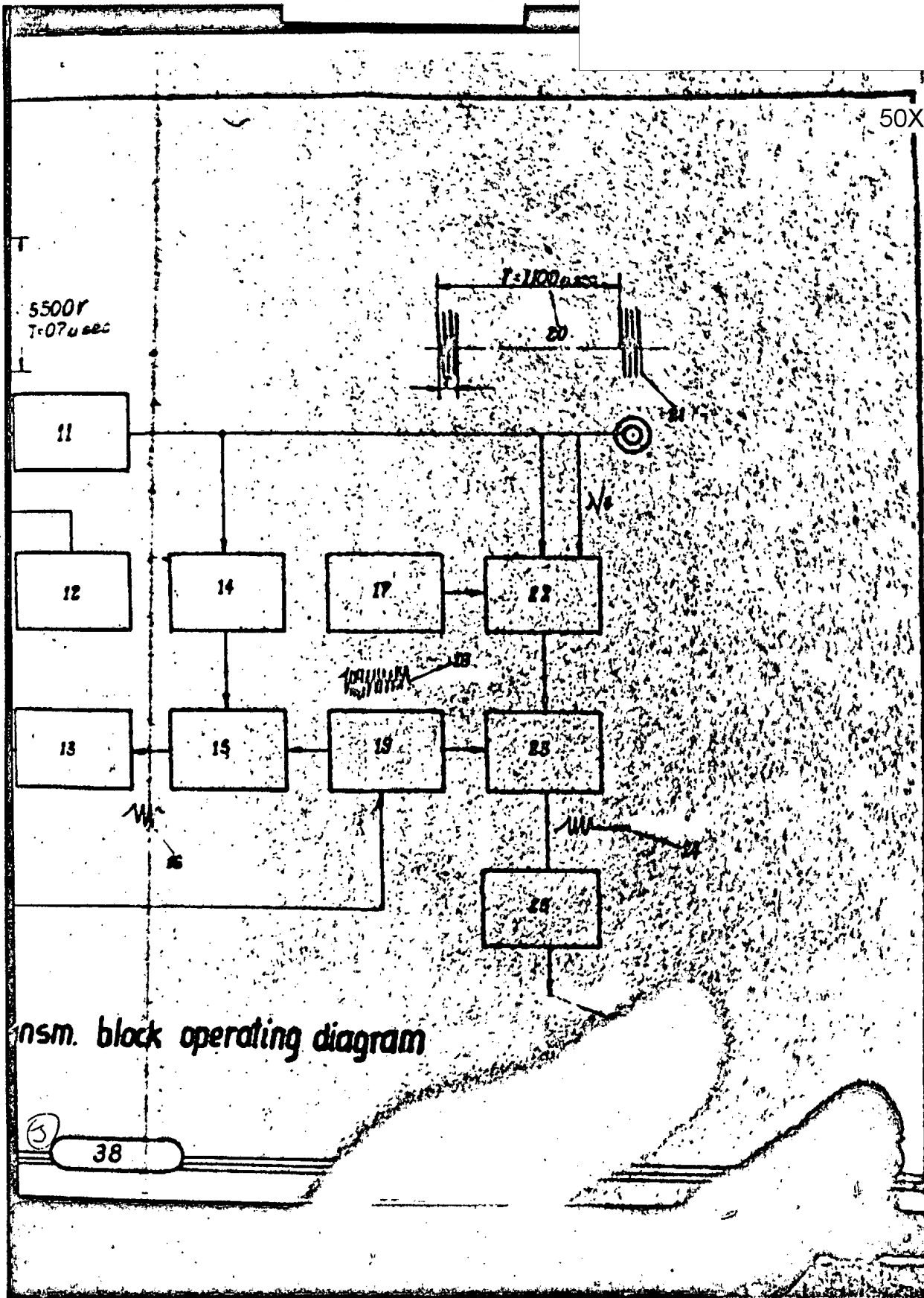

asm. block operating diagram

S-E-C-R-E-T
(NO FOREIGN DISSEM)

50X1-HUM

- 1 - 2V-1 /6N3P/ submodulator
- 2 - 2V-15b /6N1P/ starting pulse limiting diode.
- 3 - high speed sawtooth generator starting
- 4 - ARCz discriminator type 2V-13 /6x2P/
/ARCz = automatic frequency control/
- 5 - 2V-14 /6N1P/ video-amplifier
- 6 - ARCz /automatic frequency control/ starting
- 7 - 2V-2 /TGI 1-35/3/ modulator
- 8 - 2V-15b /6N1P/ blocking pulse limiting diode
- 9 - 2V-12 /6Z1P/ - II-nd stage of the automatic frequency control pre-amplifier.
- 10 - 2V-15 /6N2P/ blocking generator and regulating valve
- 11 - 2V3 /VI-120/ magnetron generator
- 12 - 2V-7 /W1-C,03/13/ high voltage rectifier
- 13 - 2V-11 /6Z1P/ - first stage of the automatic frequency control pre-amplifier.
- 14 - \approx 55 decibels attenuator
- 15 - ARCz /automatic frequency control/ mixer type 2D-2 /DG-S2/
- 16 - $f = 30$ M.c./s.
- 17 - 2V-6 /GG₁ 0,012/28/ ignition rectifier.
- 18 - $f = 2830$ M.c./s.
- 19 - 2V-4 /K-12/ klystron heterodyne
- 20 - $f = 2800$ M.c./s.
- 21 - to the antenna
- 22 - 2V-5 /RR-5/ antenna switch
- 23 - 2D-1 /DG-S2/ receiver mixer
- 24 - $f = 30$ M.c./s.
- 25 - intermediate frequency pre-amplifier type 2V-8, 2V-9, 2V-10 /6Z3P/
- 26 - to the WPCz /intermediate frequency amplifier/.

- 35 -

S-E-C-R-E-T

NO FOREIGN DISSEM

NO FOREIGN DISSEM

The blocking pulse is fed to the intermediate frequency amplifier through the 2V-16a /6N1P/ blocking pulse limiting diode in order to block the receiver for probe pulse duration /during probe pulse time/. The starting pulse is fed to the range unit through the 2V-15b /6N1P/ starting pulse limiting diode in order to start the high speed sawtooth generator. The starting pulse of the automatic frequency control is fed to the intermediate frequency amplifier of the ARCz /automatic frequency control/ circuit, 2V-12, /6Z1P/ valve, then starts the ARCz circuit.

A part of high frequency magnetron pulse energy is fed, through an attenuator, to the ARCz /automatic frequency control/ mixing chamber. In this chamber a DGS-2 /2D-2/ crystal detector has been employed as a mixer.

Simultaneously, continuous high frequency oscillations of the 2V-4 /K-12/ klystron heterodyne pass to the automatic frequency control mixing chamber in an uninterrupted manner.

As a result of two high frequency oscillations a pulse is formed on ARCz /the automatic frequency control/ circuit input.

This pulse frequency is equal to the difference between frequencies of magnetron and klystron generators.

This pulse is amplified by two stages of intermediate frequency amplifier of the ARCz /automatic frequency control/ circuit, operating with 2V-11; 2V-12 /6Z1P/ valves, then, passes to the discriminator circuit which operates with a 2V-13 /5N2P/ double diode. The detected pulse is fed from the limiter output to a two-stage pulse amplifier, which operates with a 2V-14 /6N1P/ double triode. After the amplification the pulse is fed into the regulating valve /right section of the 2V-15 /6N2P/ valve/. From this regulating valve a negative voltage is taken and fed into the klystron reflector. If the intermediate frequency variation exceeds the klystron setting range, the blocking generator /left section of 2V-15 valve/ pulses are fed to the right section of the 2V-14 valve, replacing thus pulses from the limiter. The ARCz /automatic frequency control/ circuit generates a driving voltage /control voltage/, which keeps klystron

- 40 -

S-E-C-R-E-T

NO FOREIGN DISSEM

NO FOREIGN DISSEM

50X1-HUM

oscillations frequency 30 M.c./s. higher than the magnetron generator one.

During reception, target reflected pulses pass from the antenna to the "odbior - nadawanie" /reception - transmission/ chamber of the aerial switch. The chamber is tuned for the reflected signals frequency. The reflected signal energy passes from the "reception - transmission" chamber into a receiver mixer. / DGS-2 /2D-1/ crystal detector has been used as a mixer/.

Moreover, continuous oscillations of the Klystron heterodyne are coming into the mixer in an uninterrupted manner.

As a result of mixing, several frequencies arise. They give a 30 M.c./s. intermediate frequency on the receiver mixer load /input circuit of the intermediate frequency pre-amplifier/. After having passed the stages of the intermediate frequency pre-amplifier /W-PCx/ operating with 2V-8, 2V-9, 2V-10 /6Z3P/ valves, the amplified pulses are fed to the range unit, on the input of intermediate frequency main amplifier.

The high voltage rectifier operating with a 2L-0,03/13/ 2V07/ valve serves for supply the 2V-2 modulator valve with a 1450 Volts voltage. The ignition rectifier operating with a 2V-6 /GG1-0,012/2,8/ serves for supplying the 2V-5/RR-5/ discharging valve with a - 750 Volts voltage.

5. Description of the unit's operation

/according to main block - diagram/

The main /basic/ block diagram of the transmitter-receiver unit is shown in Fig. 15.

1. Submodulator.

A block diagram of the submodulator is represented in Fig. 16.

A submodulator serves for controlling the modulator operation. A pulse with a suitable amplitude, frequency and shape is generated in the submodulator.

The submodulator operates with a 6W3P /2V-1/ double triode. It consists of two stages: a self-exciting blocking generator operating with valve's left section and a cathode

S-E-C-R-E-T

NO FOREIGN DISSEM

S-E-C-R-E-T
NO FOREIGN DISSEM

follower operating with valve's right section. 50X1-HUM.

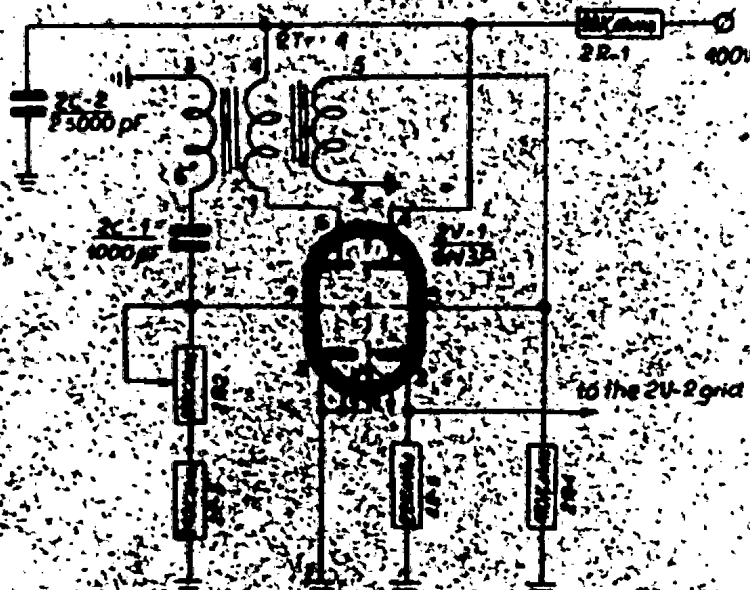

Fig. 15. Block diagram of the submodulator.

a/ Blocking generator

The blocking generator or pulse generator with transformer coupling forms a single-valve self-exciting relaxation circuit with a strong positive feed-back.

This positive feed-back enables to generate short pulses, similar to square ones in given conditions.

To explain the operation principle of the blocking generator it is necessary to consider physical phenomena occurring in the circuit /Fig. 17/ from the moment which corresponds to a blocked valve with negative voltage bias taken from a 2C-1 condenser.

S-E-C-R-E-T
(NO FOREIGN DISSEM)

50X1-HUM

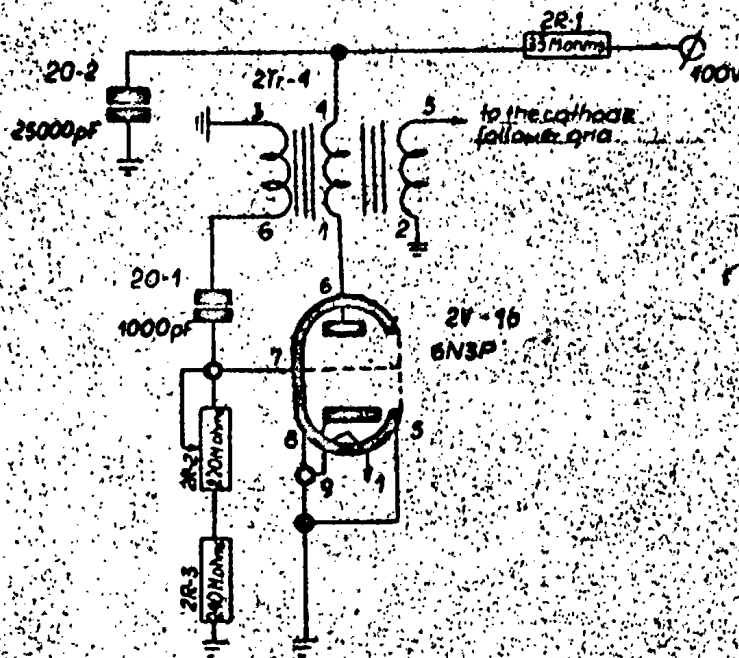

Fig. 17. Block diagram of the blocking generator

At this time the voltage on the anode is equal to +250 Volts. When the blocking generator valve is blocked the 2C-1 condenser discharges through the following circuit: 2C-1 condenser, secondary winding of a pulse transformer, 2R-1 and 2R-2 resistors.

The capacity discharging proceeds according to the exponential curve with a time constant equal to product of 2C-1 capacity multiplied by sum of both 2R-2 and 2R-3 resistances.

According to 2C-1 condenser discharging the valve grid voltage reaches the valve unblocking potential at the moment t_1 /Fig. 18a/, then an anode current is driven through the valve.

This current passing the transformer primary winding induces an electro-motive force in the secondary winding, which is connected so, that a positive voltage is fed to the grid. Owing to this fact the control grid voltage increases

S-E-C-R-E-T
NO FOREIGN DISSEM

involving thus further increase of the anode current, which causes a voltage drop on the anode. Anode current increase involves further augmentation of the valve control grid voltage, which causes a new increase of the anode current and so on.

This "avalanche" anode current increasing is called a simple blocking process.

The increase of grid voltage allows that the grid voltage becomes positive, at the moment t_2 /Fig. 18b/, and a grid current appears, which begins to load the 2C-1 condenser, enabling thus a self-inductance electro-motive force to appear in the transformer secondary winding. This self-inductance electro-motive force hinders from further "avalanche" process increase but the grid voltage increase and the voltage drop on the valve anode not stop immediately after grid current appearance; they stop after a period equal to $t_2 + t_3$. The anode current cannot increase infinitely. It reaches valve saturation current value at the moment t_3 /Fig. 18c/. At this moment, the operation point displaces on the characteristic curve into the small inclination zone, while the anode voltage reaches its minimum.

During the $t_3 + t_4$ period the grid voltage decreases relatively slow, since a small anode current variation corresponds to the small grid voltage change at this time, as a result of operation point displacement towards small inclinations zone. At this time the grid current drops due to the slow grid voltage drop while the 2C-1 condenser continues to charge through the following circuit:

2C-1 condenser; grid-valve cathode zone and secondary winding of the pulse transformer. At the t_4 moment the operation points reaches inclinations zones where the conditions for a new blocking process are fulfilled again.

The grid voltage drop begins now to involve a greater anode current decrease, which causes the decrease of fall of voltage on the primary and secondary winding of the pulse transformer.

The voltage drop on the secondary winding of the pulse transformer causes a further more intense voltage decrease

- 44 -

S-E-C-R-E-T

NO FOREIGN DISSEM

NO FOREIGN DISSEM

50X1-HUM

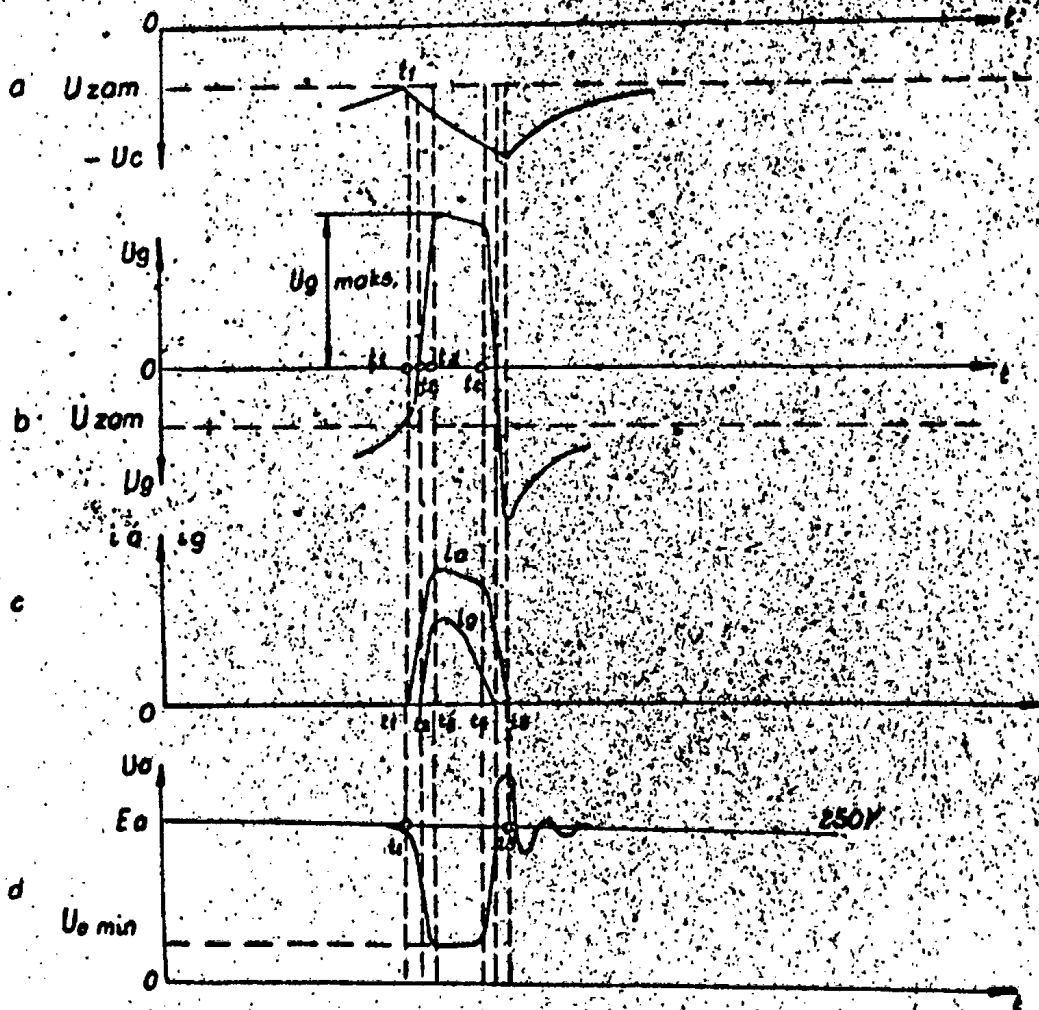

Fig. 18. Curves illustrating the current and voltage variation in the blocking generator circuit.

- 45 -

S-E-C-R-E-T

NO FOREIGN DISSEM

S-E-C-R-E-T
NO FOREIGN DISSEM

50X1-HUM

on the valve grid, which involves further anode current dr

So, a blocking process occurs. It is similar to the described above but it is acting reversely i.e. a reverse blocking process occurs causing a sudden fall of voltage on the valve grid, a grid current disappearance as well as a rapid valve blocking due to negative voltage increase on the 2C-1 capacity.

Owing to the described phenomenon the blocking generator circuit comes back to its initial operation conditions and the whole process begins once more.

The generated pulses length is determined by parameters of the valve grid circuit and by pulse transformer parameters.

The pulse frequency is usually determined by a 2C-1 condenser discharging circuit time constant.

The pulse frequency can be controlled by means of 2R-2 resistance value variation.

A 2R-3 constant resistance is employed in the circuit in order to set the frequency upper limit.

The output voltage of the blocking generator is taken from the additional winding of the pulse transformer, then, it is fed to the cathode follower grid/right section of the 2V-1 valve/. This is a positive pulse with 220 Volts amplitude, $1,3 + 1,5$ μ sec pulse time, 530 c/s frequency.

Fig. 19 shows the pulse shape on the blocking generator output.

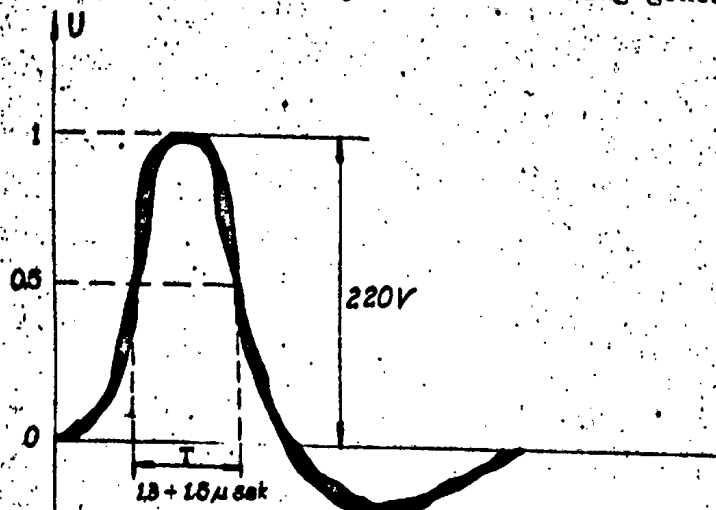

Fig. 19. Pulse shape on the blocking generator output.

- 46 -

S-E-C-R-E-T
NO FOREIGN DISSEM

NO FOREIGN DISSEM

50X1-HUM

b/ cathode follower.

Positive pulses of the blocking generator are taken from the additional winding of the pulse transformer and fed to the cathode follower grid /Fig. 20/. The cathode follower is necessary to remove the influence of the modulator on the submodulator blocking generator as well as to match the load input resistance with a blocking generator output resistance.

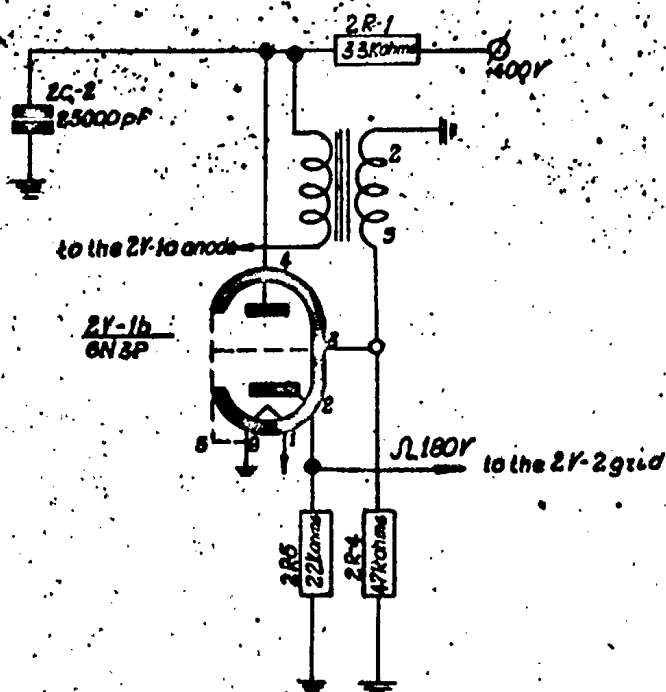

Fig. 20. Block diagram of the cathode follower.

S-E-C-R-E-T

NO FOREIGN DISSEM

The 2R-5 load resistance should be set so, that the received pulse amplitude exceeds 180 Volts. 50X1-HUM.
Fig. 21 shows the pulse shape on the cathode follower output.
To the output pulse transformer winding a 2R-4 resistor is connected in parallel. This resistance forms an additional load of this winding.

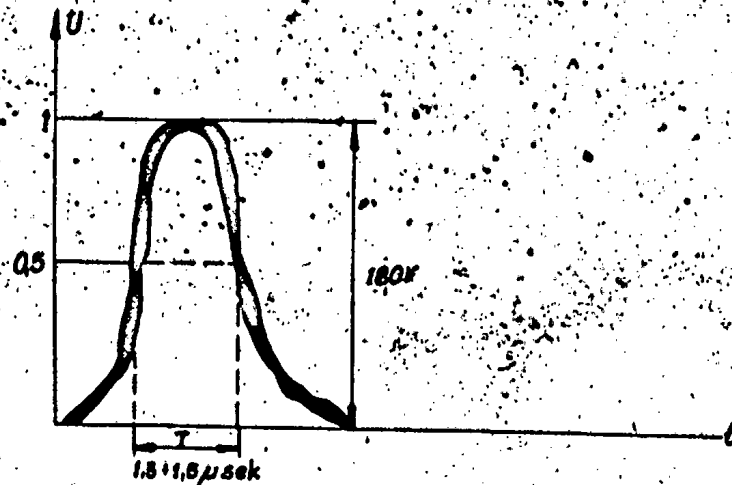

Fig. 21. Shape of pulse on the cathode follower output.

2. Modulator

The transmitter modulator forms a common circuit with a 2LF-1 artificial forming line which is discharged by means of TGI-1-35/3 thyatron. The block diagram of the modulator is represented in Fig. 22. ●

The modulator operation can be divided in two stages:
- a stage of pulse charging /loading/ of the forming line
- the stage of the forming line resonance discharging.

During the line pulse charging a negative square pulse is generated on the secondary pulse transformer winding.

This pulse has a 1500 Volts amplitude; it is fed to the magnetron /which forms the modulator load/.

NO FOREIGN DISSEM

50X1-HUM

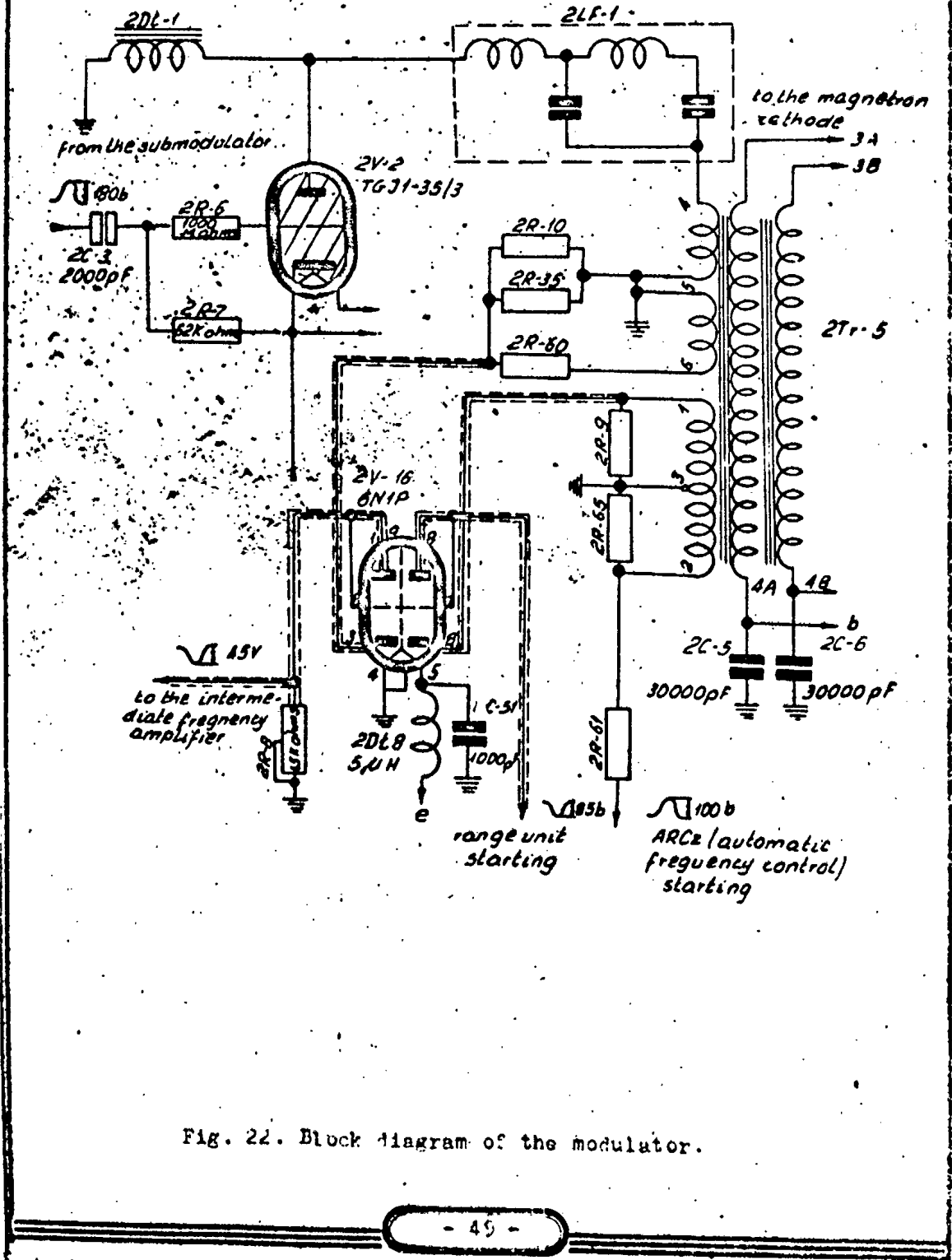

Fig. 22. Block diagram of the modulator.

S-E-C-R-E-T

NO FOREIGN DISSEM

Let us transform the modulator circuit into an equivalent circuit /Fig: 23/:

50X1-HUM

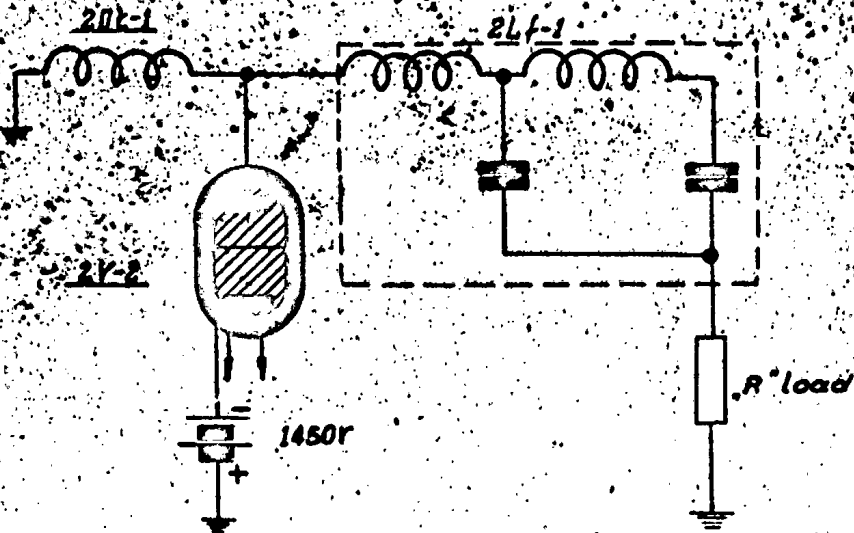

Fig. 23. Modulator's equivalent circuit.

A negative - 1450 Volts voltage is taken from the high voltage rectifier and fed to the thyatron cathode. /the rectifier operates with 2V-7 /W-1-0,03/13/ valve/.

When the positive starting pulse from the modulator appears, the thyatron ignition occurs, the thyatron resistance becomes practically equal to zero the forming line is charged from the - 1450 V. source so, that, at the charging action end, its voltage is equal to the thyatron cathode voltage i.e. to the supplying source voltage - 1450. Volts. After the charging, the thyatron stops to glimm, its resistance increases rapidly, the forming line begins slowly to discharge through the following circuit: forming line, pulse transformer primary winding, 2D1-1 choke. Fig. 24 illustrates the wiring diagram of line discharging circuit.

The discharging circuit is an oscillating circuit. Its capacity is equal to the summary C_{1f} capacity of the for-

S-E-C-R-E-T
NO FOREIGN DISSEM

ring line, its inductance is L , the inductance of a 2 D₁-1 choke. /the forming line inductance, and the transformer primary winding inductance cannot be taken into account since they are very small in comparison to the 2D₁-1 choke inductance/. 50X1-HUM

The oscillating circuit parameters are chosen in order that the own frequency cycle meets the following requirement:

$$T = \frac{2}{F_p};$$

where: F_p = submodulator pulse frequency

A voltage variations on the forming line are represented in Fig. 25 in form of a diagram.

At the own frequency cycle T /as illustrated in Fig. 25/ the submodulator starting pulse comes at the very moment, when the forming line voltage becomes equal to +1450 Volts, due to the line resonance discharging.

When the next starting pulse comes, the thyatron ignition /firing/ begins, as well as, the pulse discharging cycle.

The starting pulse is fed to the thyatron grid through the 2C-3 dividing condenser and a 2R-6 resistor, which serves for limiting the thyatron grid currents.

The 2R-7 resistance is a grid-leak resistor in the thyatron control grid circuit.

S-E-C-R-E-T
NO FOREIGN DISSEM

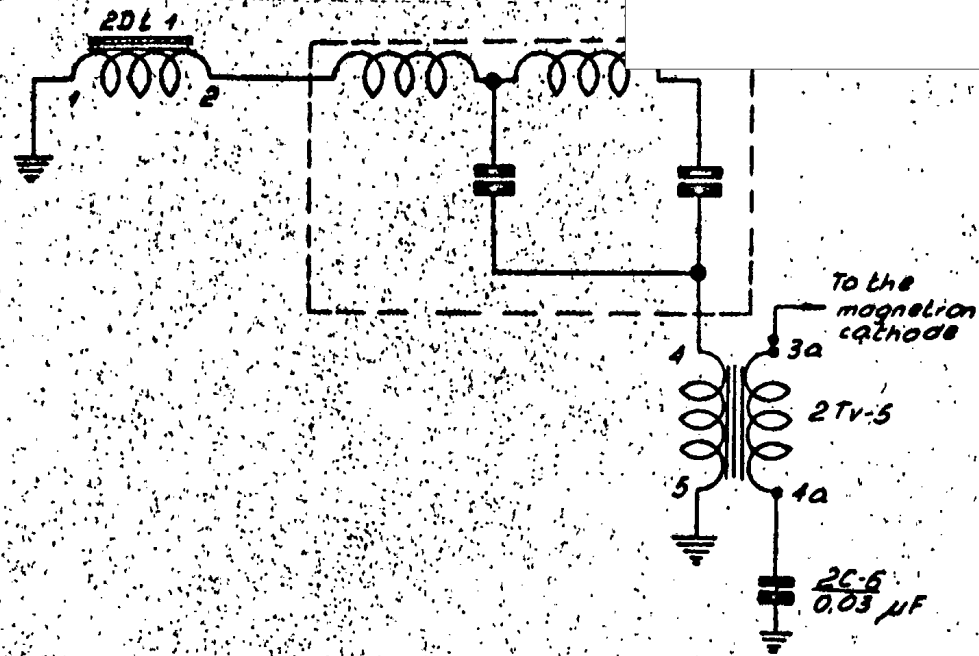

50X1-HUM

Fig. 24. Diagram of resonance discharging circuit of the forming line.

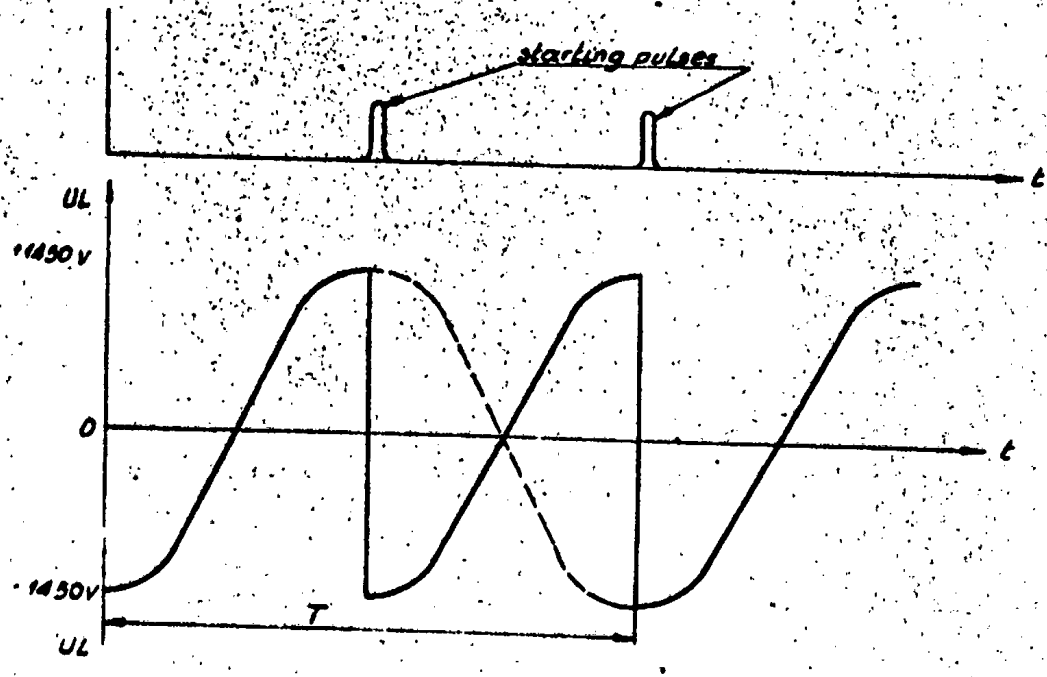

Fig. 25. Forming line voltage variations.

S-E-C-R-E-T
NO FOREIGN DISSEM

S-E-C-R-E-T
NO FOREIGN DISSEM

An equivalent circuit of pulse discharging of the forming line is shown in Fig. 26.

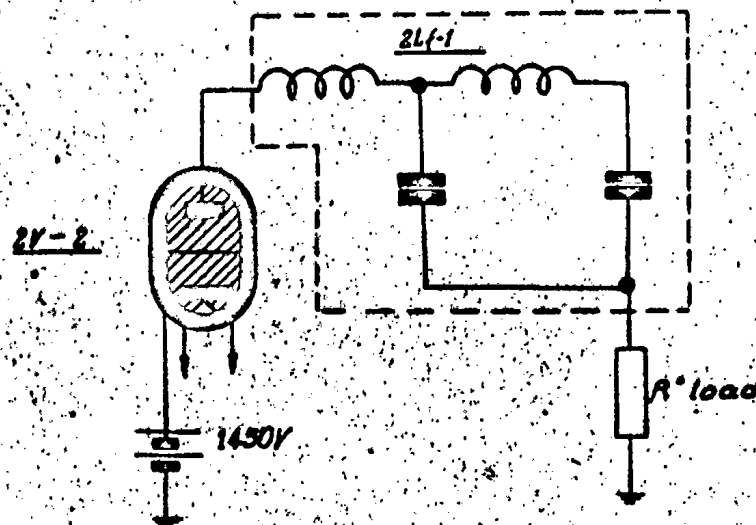

Fig. 26. Equivalent circuit of the forming line pulse discharging.

As represented in Fig. 26, at the moment of thyatron ignition there are two electro-motive forces connected in series in the forming line discharging circuit:

- an electro-motive force of battery E
- " " " " of the forming line charged up to supplying source voltage. These two electro-motive forces have two load resistances:
 - line wave impedance
 - load resistance equal to the line wave resistance.

It is known from the long line theory, that a line loaded with a resistance equal to wave impedance generates during discharging/on this resistance/a square pulse. This pulse's length is defined by parameters of an artificial long line.

S-E-C-R-E-T
(NO FOREIGN DISSEM)

NO FOREIGN DISSEM

The optimum pulse shape and the greatest efficiency coefficient can be obtained with full matching of both wave impedance and load resistance. 50X1-HUM

A double element artificial line chain type has been used in the unit modulator. Its parameters are given beneath:

total capacity $C = 5100 \text{ pF}$
 wave impedance $\rho = 54 \text{ ohms}$
 length of generated pulse: $\tau = 0,7 \text{ usec /at } 0,5/$

As mentioned above the magnetron is the modulator load. However, it cannot be connected directly to the modulator, since its resistance in given conditions differs much from the line wave impedance $\rho = 750 \text{ ohms/}$ which would cause the line's mistuning, a considerable decrease of the efficiency coefficient, and, a great deformation of starting pulse shape. To avoid this difficulty the magnetron should be connected with the modulator by means of a 2 Tr-5 pulse transformer, which enables the matching of both forming line wave impedance and magnetron resistance.

The pulse transformer ratio is chosen so, that its primary winding input resistance is equal to 50 ohms. If an internal resistance of operating thyratron is taken into account /4 ohms approx./ the forming line total load can be obtained as equal to its wave impedance i.e. to 54 ohms.

Moreover, besides matching process, the pulse transformer enables to obtain on the secondary winding a pulse with an amplitude several times greater than the pulse amplitude on the primary winding. It makes possible to use a supply source with lower voltage and simplifies the high voltage protection /squench/ of the unit circuit.

The pulse transformer is provided with a double secondary winding. This winding serves for feeding the heating /filament/ voltage to the magnetron. Such a magnetron heating /filament/ supply circuit enables to use the filament transformer which is not operating with high voltage.

The 4 A and 4 B terminals of pulse transformer secondary winding are blocked with 2C-5; 2C-5 capacities in order to form a closed circuit for the magnetron current alternate

- 54 -

S-E-C-R-E-T

NO FOREIGN DISSEM

S-E-C-R-E-T
NO FOREIGN DISSEM

50X1-HUM

component.

This forms a heating /filament/ supply circuit with grounded /bonded/ centre point as shown in Fig. 17.

The submodulator pulses cannot synchronize all station operation since the thyatron ignition moment oscillates from pulse to pulse within $0,03 + 0,04 \mu\text{sec}$ relatively to submodulator blocking generator pulse. Therefore pulses for synchronizing the station operation must be taken from pulse transformer positive windings, besides the modulating pulse. In this case a permanent operation synchronizing is obtained concerning following units: receiver, range unit, automatic frequency control circuit, station generator.

In order to start the range unit, a synchronizing pulse is taken from 1 + 3 terminals of the 2 Tr-5 pulse transformer and fed to the range unit through the 2V-16 diode /right section of the 6N1P valve/.

A negative pulse is taken from the 5 + 6 terminals of pulse transformer winding. This pulse serves for blocking the receiver during the probe pulse radiation time. The blocking pulse is fed to the divider which consists of 2R-10; 2R-35; 2R-60 resistors.

Simultaneously, these resistors shunt the winding in order to prevent the generation of parasite oscillations in the circuit.

The pulses with decreased amplitude are taken from the 2R-10 and 2R-35 resistors of the described above divider, then pulses are fed to the diode cathode /left section of a 2V-16 valve/.

This diode is shunted by a 2R-8 potentiometer by means of which a blocking pulse amplitude can be set /-45 Volts/.

A positive pulse is taken from the 2 + 3 terminals of pulse transformer winding for start the AFCz circuit /AFCz = automatic frequency control/. This pulse is fed to the third grid of the 2V-12 /621P/ valve, by means of a 2R-51 resistor.

- 55 -

S-E-C-R-E-T

NO FOREIGN DISSEM

S-E-C-R-E-T
NO FOREIGN DISSEM

50X1-HUM

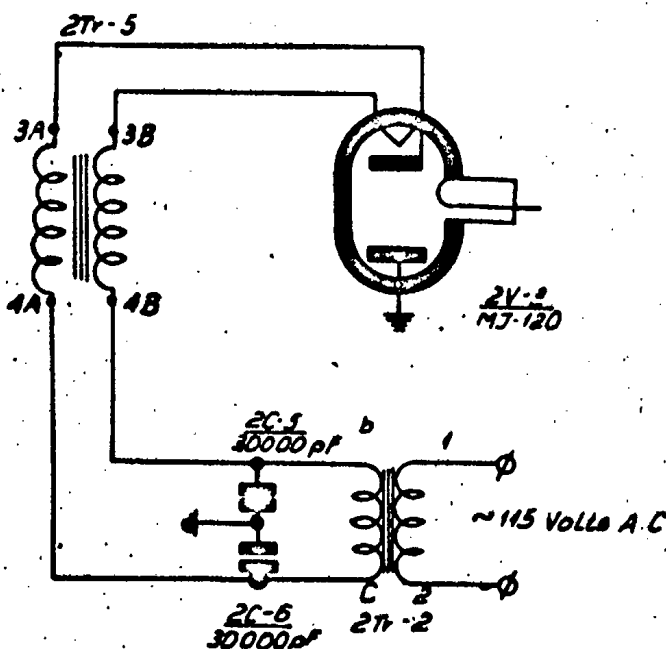

Fig. 27. Magnetron heating supply circuit diagram.

The 2R-5 and 2R-65 resistances, which shunt corresponding pulse transformer windings, serve for removing parasite oscillations formed during pulse generation.

The 2V-16 /6N1P/ diodes serve for cut off the positive parts of starting and blocking pulses. Moreover, the right diode enables to start the range unit by an external pulse generator since it eliminates the pulse source shunting by means of pulse transformer winding.

To avoid disturbances the blocking and starting pulses are fed by means of screened cables.

The applied modulator circuit shows many advantages as compared to other circuits provided with an artificial forming line. This advantage consists in the fact that in the high voltage modulator points the voltage does not exceed the voltage value of the supply source (1450 Volts) while the pulse amplitude on the load is equal to the supply source voltage.

Other circuits have a voltage on the line and on the thyatron anode equal to double voltage of the supply source.

S-E-C-R-E-T

NO FOREIGN DISSEM

NO FOREIGN DISSEM

relative to "earth", while the pulse amplitude on the load is equal to the supply source voltage. 50X1-HUM

3. High voltage rectifier

The high voltage rectifier consists of a 2 Tr-1 by-pass transformer, of a 7-1-0,03/15 7ZV-7 valve rectifier, and of a 2C-4 filtering condenser for pulsation smoothing. The rectifier serves for supply the modulator with a - 1450 Volt rectified voltage.

The high voltage rectifier operates in the half-wave rectification circuit. Its wiring diagram is shown in Fig.28.

After the switching of the 115 Volts A.C. 400 c/s supply voltage on the primary winding, a 1500 Volts /approx./ voltage is taken from the secondary winding and fed to the rectifying valve anode.

The rectifying valve allows the current to pass in one direction only /from anode to cathode/, therefore, a current can be driven through the rectifying valve with a positive voltage on the valve's anode.

Moreover, due to filtering condenser switching on, the time of current passing through the rectifying valve is less than the time of a half - cycle. This current is charged by a 2C-4 condenser through the following circuit: transformer secondary winding, rectifier valve inner resistance, 2C-4 condenser.

As soon as the current driven through the rectifying valve disappears, the 2C-4 condenser begins to discharge by means of a load resistance R_{ob} , while the discharging time constant exceeds considerably the condenser charging time constant.

The condenser plates voltage will almost not vary till the moment of a new current driving through the rectifier valve which will cause the filtering condenser charging.

According to the described above process, the 2C-4 filtering condenser smoothes the rectified voltage pulsation.

The 2 Tr-1 transformer primary winding consists of three sections.

The reduction of number of sections switched to the

- 57 -

S-E-C-R-E-T

NO FOREIGN DISSEM

50X1-HUM

115 Volts A.C. 400 c/s network by the 2 Pr-1 switch causes the voltage increase in the transformer secondary winding, increasing thus the rectified voltage of the high voltage rectifier.

The 2R-12; 2R-13; 2R-14 form a rectifier load and enable the 2C-4 condenser to discharge after the unit supply switching off.

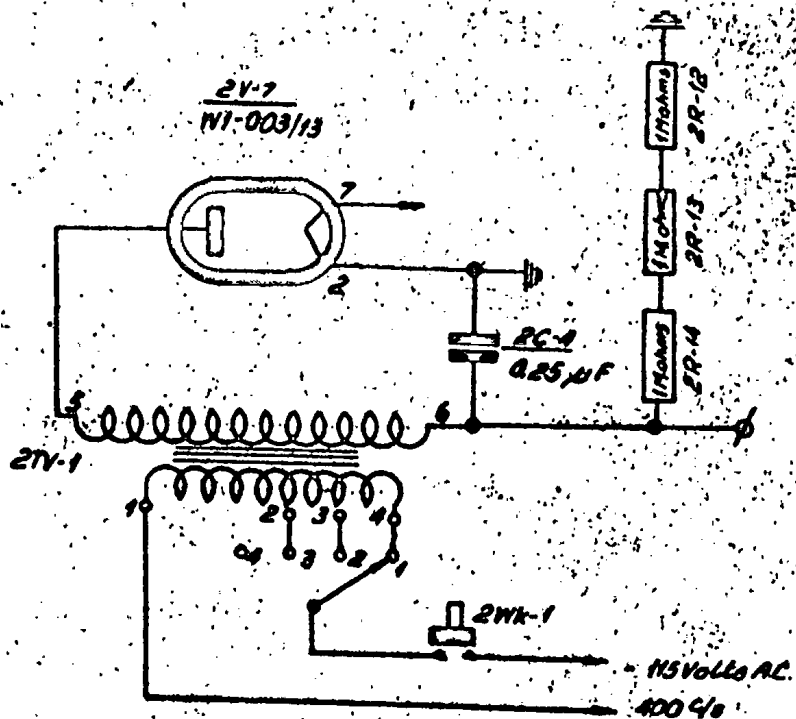

Fig. 28. Wiring diagram of the high voltage rectifier.

S-E-C-R-E-T
NO FOREIGN DISSEM

NO FOREIGN DISSEM

50X1-HUM

4. Rectifier for discharging valve ignition

The ignition rectifier consists of a 2R-3 transformer, a gas-filled valve type GG1-0,012/2,8/2V-6/ and a smoothing filter.

This filter consists of a 2R-16 resistor and 2C-7; 2C-8 condensers.

The rectifier operates in the half wave rectification circuit. Its wiring diagram is represented in Fig. 29.

After switching the 115 V.A.C. 400 c/s voltage on the transformer primary winding, the 1000 Volts voltage from the transformer secondary winding is fed to the gas-filled valve /to the valve's cathode/. The negative half-cycle of the voltage starts the gas-filled valve glimming. The 2C-7; 2C-8 condensers are charged by means of a following circuit: 2C-7; 2C-8 condensers, 2R-16 resistor, gas filled valve internal resistance, and transformer secondary winding.

As soon as the gas-filled valve stops its operation the 2C-7 and 2C-8 condensers discharge through the load resistance R_{obc} . The condensers discharging time constant is much greater than their charging time constant. Therefore, at the moment of a new ignition of the gas-filled valve, the condensers voltage will be a little lower.

So, the 2R-16 resistor and 2C-7; 2C-8 condensers smooth the pulsating voltage on the rectifier output.

The 2R-16 resistor serves simultaneously for limiting the anode current of the gas filled valve.

The 2R-17 and 2R-18 resistors are limiting the ignition current of the gas filled valve.

The 2R-19 resistor serves for limiting the discharging valve current.

The 2R-15 resistor is the rectifier's load. It protects the 2C-7 and 2C-8 condensers against breaking in case of RR-5 resonance discharging valve damage.

The ignition rectifier generates a negative - 750 Volts voltage which is fed to the firing electrode /ignition electrode/ of the RR-5 resonance discharging valve, in order to

- 55 -

S-E-C-R-E-T

NO FOREIGN DISSEM

NO FOREIGN DISSEM

accelerate its ignition at the moment of high frequency pu50X1-HUM feeding from the transmitter.

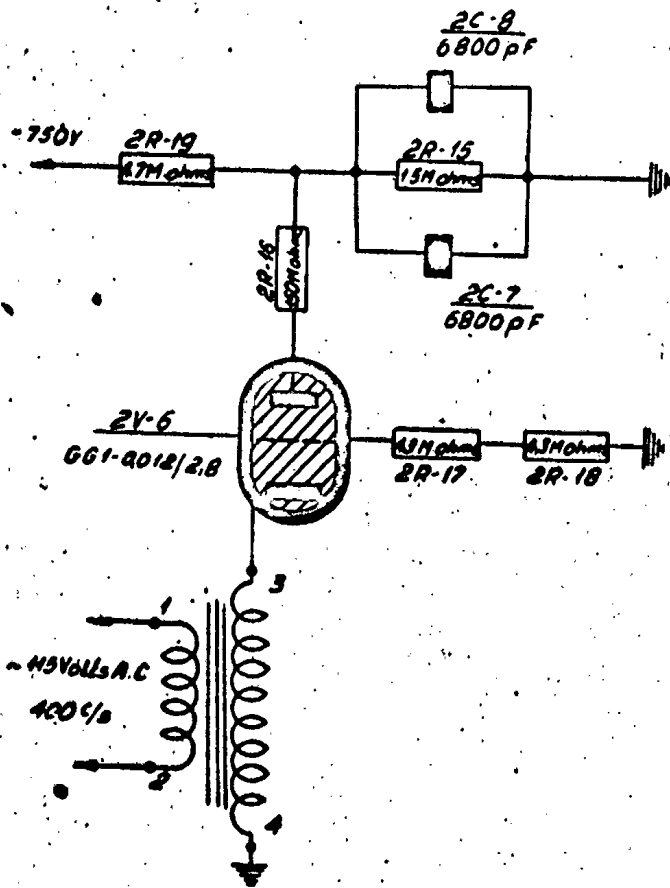

Fig. 29. Wiring diagram of the ignition rectifier.

S-E-C-R-E-T
NO FOREIGN DISSEM

NO FOREIGN DISSEM

50X1-HUM

H.F. circuits of transmitter-receiver set.1. Destination and composition.

H.F. circuits of transmitter receiver set are destined for: strong H.F. pulses generation, transferring these pulses to aerial stage, switching aerial stage from transmission to reception and changing received HF signals to I.F. signals.

The transmitter-receiver set consists of following HF circuits.

1. HF magnetron generator
2. Main concentric line
3. Aerial switch
4. Receiver mixer
5. A.F.C. mixer
6. Klystron heterodyne.

2. Circuit diagram.

The HF. circuits are fitted in the stiff metal case consisting of above mentioned stages, connected together with concentric line pieces of 50 Ohm wave impedance.

The diagram of HF circuits is shown on Fig. 30.

The magnetron /1./ is connected with main concentric line which on the other end has the connection for aerial stage.

Main concentric line is divided to three lines /3/, /17/ and /18/. No 3 line serves as a discriminator for A.F.C. mixer and it is a circular piece of wave guide, which inner diameter is less than critical.

So this piece of circular wave guide acts as a border type discriminator in which, weakened to certain level, part of HF. energy goes to A.F.C. mixer.

The dumping depends on the length of discriminator and it is unchangeable during the use of set.

A.F.C. mixer /4/ is a piece of concentric line in to which the crystal detector /5/ is connected.

The HF. oscillations of klystron heterodyne are brought to the mixer by help of coupling disc, making the capacity with central cable of the line. In effect of two HF oscillations

S-E-C-R-E-T

NO FOREIGN DISSEM

NO FOREIGN DISSEM

50X1-HUM

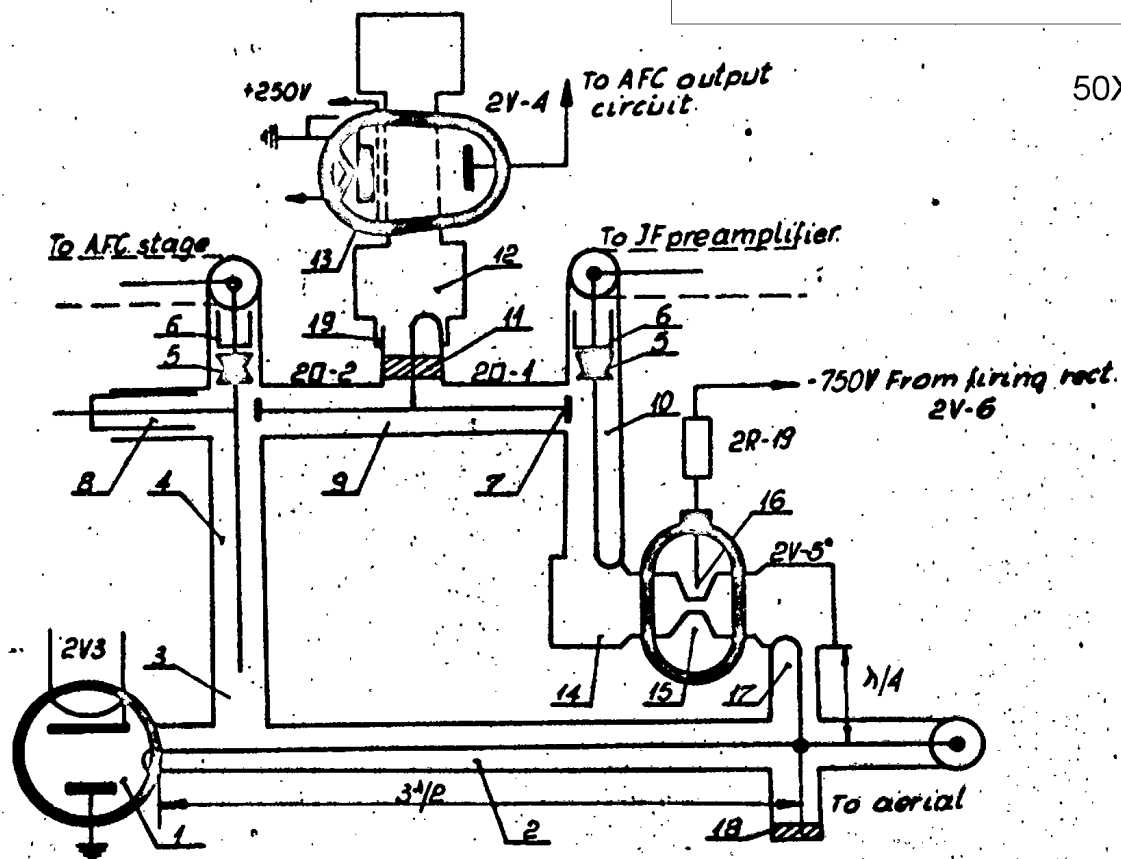

Fig. 30. H.F. circuit diagram.

- 1 - Magnetron type MI-120
- 2 - Main concentric line
- 3 - A.F.C. mixer discriminator
- 4 - A.F.C. mixer
- 5 - Mixer crystal detector /EGS-2/
- 6 - wave mixer filters
- 7 - coupling mixer disks
- 8 - Shortened piece of line
- 9 - Three way connection
- 10 - Receiver mixer
- 11 - Disc resistor
- 12 - Cavity klystrone resonator
- 13 - Klystrone K-12
- 14 - Discharging valve cavity resonator
- 15 - Discharging valve-RR-5
- 16 - Discharging valve firing electrode
- 17 - $\frac{1}{2}$ wave concentric line piece
- 18 - Matching loop
- 19 - Insulating sleeve.

E2

S-E-C-R-E-T

NO FOREIGN DISSEM

NO FOREIGN DISSEM

mixing /generator and heterodyne/ through the cristal detector, consisting of different harmonic frequencies, due to nonlinear resistance of cristal detector. From these frequencies the differencial frequency is chosen, and it is an intermediate frequency, which equals the difference of generator and heterodyne frequencies.

$$f_p = f_{het} - f_{gen}$$

where:

f_p = Intermediate frequency

f_{het} = Klystrone heterodyne frequency

f_{gen} = Magnetron generator frequency

The I.F. is obtained in the input of AFC circuit. The rest current harmonics of much higher frequency are directed to earth by the filter /6/. This filter is made of a shortened to earth concentric line piece, which length equals $\frac{1}{4}$ wavelength.

As it is well known from long lines theory, the resistance of such a piece of line equals zero, and that is why all harmonic of high frequency are shortened to earth, while the IF current passes easily through this filter.

As we can see on the diagram, the receiving end of the AFC mixer central cable has no electric connection to the outside pipe /body/ of the mixer.

That is why the circuit is open for the direct part of the current.

Shortened piece of concentric line /line /e/ serves for closing the circuit for the direct part of current. The length of this part of line can be changed by means of moving the special piston. The mixer input resistivity can be matched by this piston for obtaining maximum AFC signal in the mixer output. Second branch /17/ of main concentric line determines a $\frac{1}{4}$ wave piece of line, which has a coupling loop on its end, getting to cavity resonator /14/. Branch /18/ determines matching passive loop which is destinated for passive resistivity matching brought through branch /17/. Matching loop tuning

63

S-E-C-R-E-T

NO FOREIGN DISSEM

should be done according to minimum standing wave factor, of main concentric line by transferring HF energy.

50X1-HUM

Cavity resonator /14/ with discharging valve /15/ and $\frac{1}{2}$ wave line /17/ create aerial switch.

Cavity resonator, with discharging valve create oscillating circuit, tuned to magnetron generator frequency.

At the time of pulse radiation by the magnetron, part of its energy ramificates through a $\frac{1}{2}$ wave piece of concentric line to cavity resonator of discharging valve. The HF voltage causes the discharge in gas inside the discharging valve. Then the resistance of the discharging piece is very small.

The load of $\frac{1}{2}$ wave piece of line equals very near zero, and so the input resistance of this piece at the point of ramification from main line is very near to infinity. Magnetron pulse energy does not ramificate to the aerial switch and does not get to receiver mixer /10/ which is also coupled to cavity resonator by coupling loop.

In such a manner the receiver cristal detector /5/ is secured before the damage by the strong magnetron pulses at the time of radiation.

In any case, the small part of power can get through to receiver mixer, because the firing in the discharging valve is caused with some delay to the beginning of magnetron pulse. For hastening the discharging valve firing and so for decreasing the penetration of power to the mixer up to the safe value of cristal detector, the discharging valve has the firing electrode fitted in.

To this electrode the constant negative voltage of - 750 V is fed from firing rectifier through resistor 2R-9.

When the magnetron pulse is finished, discharging in the valve stops and after some time, which is necessary for shrink of gas ionization in valve /practically after 2 μ sec. the cavity resonator of discharging valve obtains its resonating properties.

Reflected from the target and received signal goes to main concentric line and through the $\frac{1}{2}$ wave piece to the cavity resonator of discharging valve. Because the received

signal is very weak, the discharging will not have place in the discharging valve and in cavity resonator. Discharging valve the oscillations of received frequency will be excited. These oscillations are going to the receiver mixer through coupling loop.

50X1-HUM

The work of receiver mixer is the same as the work of AFC mixer. I.F. obtained in the receiver mixer is applied to input circuit of I.F. preamplifier /WPC2/

Klystrone heterodyne consists of klystrone /13/ and cavity resonator /12/ which generates continuous HF oscillations. Energy of these oscillations is fed to three way connection /5/ by coupling loop. That energy gets through the three way connection to both mixers.

Both mixers give very little load to klystrone heterodyne. Beside that, this load has strongly pointed out character in effect of capacitance coupling with mixers by coupling disks.

In effect of that, the klystrone would work very unsatisfactorily and oscillations could stop. For satisfactory work of klystrone and for matching it to load in three way connection /before the remification/ the disk resistor is placed, which value is equals to the concentric line wave impedance, in effect 50 ohms.

DESTINATION AND CONSTRUCTION HF CIRCUIT ELEMENTS

1. Magnetron generator.

Type MI-120 multicavity magnetron is used as a HF oscillator in the SRB-1M set.

Nowadays the multicavity magnetron generators are employed as a basic types generators for radio location, working on centimeter wave length.

General advantage of multicavity magnetron generator is a possibility of obtaining big values of pulse power at small medium power and with high ability factor, which can reach 70%. SRB-1M magnetron generator radiates 500 pulses

55

S-E-C-R-E-T

NO FOREIGN DISSEM

S-E-C-R-E-T
NO FOREIGN DISSEM

a second, at frequency of 2800 Mc/s and 7 kW power in the pulse. 50X1-HUM

The working idea of magnetron is as follows. Magnetron, it is a diode, in which on the electron stream has the influence not only the electric field between the anode and cathode, but also the magnetic field caused by permanent magnets, directed vertically to electric field. In effect of magnetic and electric fields influence on the electron stream the path of electrons is curved. The electron paths are shown on Fig. 31.

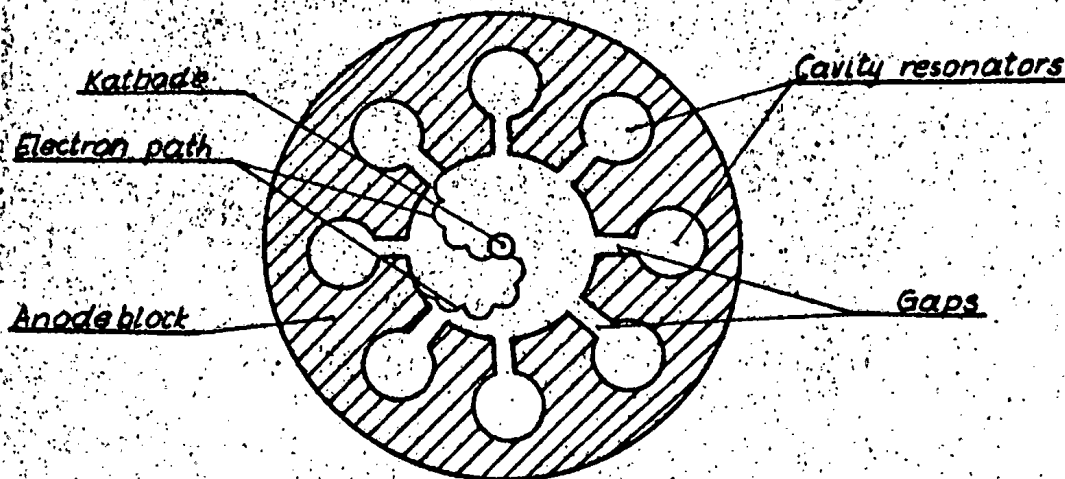

Fig. 31. Electron paths in multicavity magnetron.

This twisted path of electrons is flying by the clefts coupling cavity resonators with the area between anode and cathode, gives up its energy and excites HF oscillations in cavity resonators, which are connected to the main concentric line by coupling loop.

Fig. 34 shows the photograph where the construction of magnetron is well seen in profile.

Cavity resonators and clefts make the oscillation cir-

S-E-C-R-E-T
NO FOREIGN DISSEM

S-E-C-R-E-T
NO FOREIGN DISSEM

cuit of multicavity magnetron. The shape of one resonator with a cleft is shown on Fig. 32.

50X1-HUM

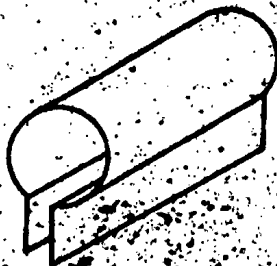

Fig. 32. Cavity resonator.

Cylindrical part of cavity resonator can be considered as an inductance L , and flat part as capacitance C , of oscillating circuit. Its own frequency f_0 can be calculated according to pattern

$$f_0 = \frac{1}{2 \sqrt{L \cdot C}}$$

Because there are several resonators in the magnetron, its oscillating circuit is very complicated.

As it is known from coupled circuits theory it has not one but several resonance frequencies. For making this circuit to oscillate one frequency and fixed, the so-called resonator connections of cavity resonators are used.

In MI-120 magnetron the connections are square shaped. They connect the resonators every one segment. Such cavity resonator connection is named single circular coupling.

Cavity resonators are displaced on the circle circumference in massive copper piece. There is coupling loop

S-E-C-R-E-T
NO FOREIGN DISSEM

S-E-C-R-E-T
NO FOREIGN DISSEM

50X1-HUM

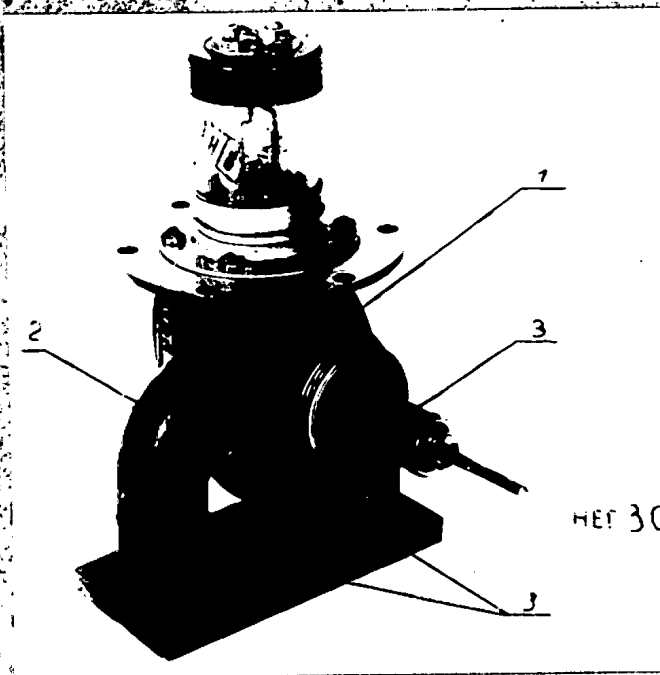

Fig. 33. General view of magnetron generator.

- 1 - Magnetron MI-120
- 2 - Magnets
- 3 - Concentric magnetron outlet.

6E

S-E-C-R-E-T

NO FOREIGN DISSEM

S-E-C-R-E-T
NO FOREIGN DISSEM

50X1-HUM

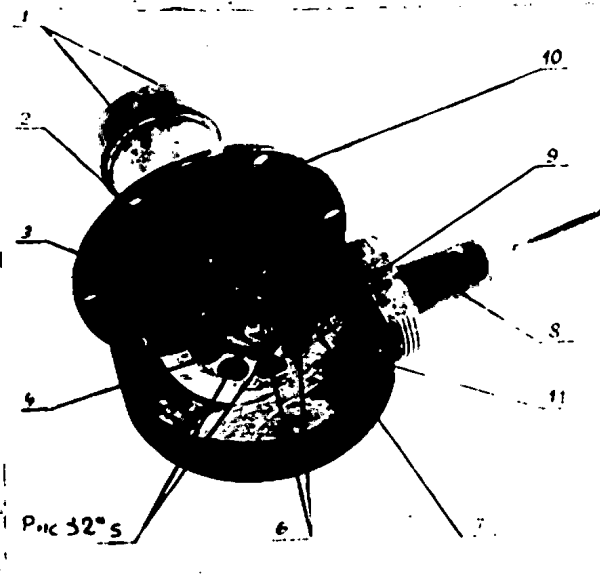

Fig. 34. Cross-section view of magnetron MI-120.

- 1 - Cathode and heater connections.
- 2 - Security disks.
- 3 - Cathode
- 4 - Joints
- 5 - Clefs
- 6 - Cavity resonators
- 7 - Anode
- 8 - Concentric outlet
- 9 - Coupling loop
- 10 - Fixing ring
- 11 - Cooling ribs.

S-E-C-R-E-T

NO FOREIGN DISSEM

placed in one of the resonators, which serves for transferring the HF oscillations to main concentric line and then to aerial. This loop is soldered at one end to resonator wall and at the other to inner wire of concentric line. Inner wire of concentric line is welded in to the glass for making the magnetron proff. 50X1-HUM

The cylindrical anode surrounds the heated cathode which is of quite big diameter to obtain large active surface, necessary for big emission current. At both sides of cathode, the securing disks are placed, to make the field structure better in the self influence area and prevents electrons dissipation in to the front part of magnetron.

The cathode is fixed inside the magnetron on stands, which are also as cathode and heater connections. Cathode and heater connections are welded in the glass pipes, fixed to the fixing collar. Thicker part of stand acts as a HF choke, which prevents the HF energy to get out through heater connections.

Permanent magnetic field is caused by the magnetic circuit, which consists of two poles fixed to steel plate. Generated magnetic field equals 1350 oersteds.

When the cathode gets a negative modulating pulse of 5500 V amplitude, magnetron starts generating the HF oscillations in form of square pulses.

Those pulses are transferred to the main concentric line by coupling loop.

During the magnetron work the anode gets very hot in effect of electron bombardment.

To prevent the overheating, it has the ribs to increase the cooling surface. Beside that, there is a ventilator placed inside the set, which blows the air round the magnetron and cools it.

For safety purpose and for montage simplicity the anode is grounded and negative pulse voltage of 5500 V is applied to the cathode.

2. Main concentric line.

NO FOREIGN DISSEM

50X1-HUM

a. Designation.

The main concentric line is designated for transferring the HF pulses from magnetron generator to aerial circuit, for transferring part HF energy to AFC chamber and for transferring reflected from target signals to the chamber of aerial transmitter-receiver switch.

b. Peculiarities of long line cuts.

Long line it is such a line with longitude can be comparable to the wavelength widening itself along this line. If long line is loaded by the impedance different to wave impedance, then the impedance of this line has an alternating value.

For each point of line, its impedance equals to voltage and current proportion at a given point.

Input impedance of line depend on load impedance and on line length.

In general, apart of load character and its value the line input impedance is as a joint value and can be presented as a dependance.

$$Z_w = r_w + jX_w$$

where:

Z_w - input line impedance

r_w - active part

X_w - passive part

Let us consider the line with open end. In given case load impedance $Z_{load} = \infty$

Open line change input impedance character is shown on Fig.35 We can see from the figure, that at a certain length of line, its input impedance becomes equal to zero.

It is obvious from the picture, that input impedance of open line, which length equals $\frac{1}{4}$ wave length = 0.

We can obtain the same result with any length of line, which equals odd number of $\frac{1}{4}$ wave length.

For open end line, which length is $\frac{1}{4}$ wave length or even number of $\frac{1}{4}$ waves, input impedance equals infinity.

S-E-C-R-E-T

NO FOREIGN DISSEM

NO FOREIGN DISSEM

50X1-HUM

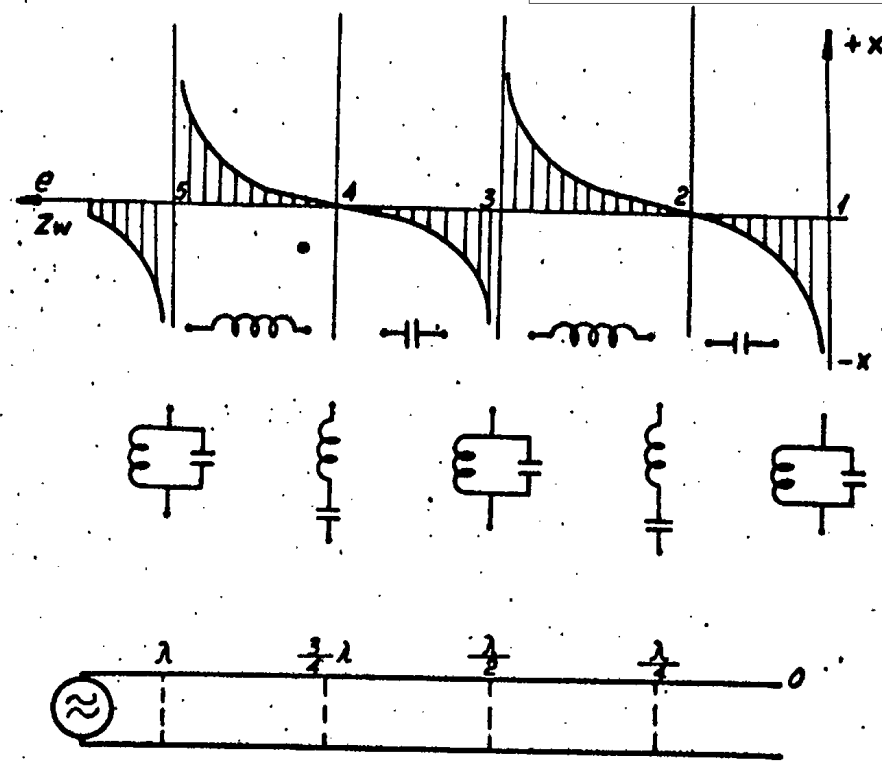

Fig. 35. Change character of line input impedance.

For intermediate values of open line its input impedance is purely passive, but at lengths line values intermediate to above described input impedance sign will change every each quarter of wave length.

Line input impedance being between odd numbers of wave length quarters has capacitance character, what is shown on figure in form of condensers.

Line input impedance being between even numbers of wave length quarters has inductance character.

at the border of length cuts $n \cdot \frac{\lambda}{4}$ line input impedance equals zero or infinity.

On fig. 35 it is shown as parallel or series resonance circuits.

At points 1, 3, 5 input impedance equals infinity what is equivalent to resonance of ideal parallel resonance circuit.

at points 2, 4 input impedance equals zero what is equivalent resonance impedance of ideal series resonance circuit.

S-E-C-R-E-T

(NO FOREIGN DISSEM)

50X1-HUM

Let us consider a line closed at its end.
 In this case, load impedance $Z_{load} = 0$.
 Change character of closed end line input impedance is shown on Fig. 36.
 Comparing input impedance change of closed line to input impedance of open line, we can state that input impedance displacement curve of closed line is $\frac{1}{2}$ wave length shifted to open line curve.

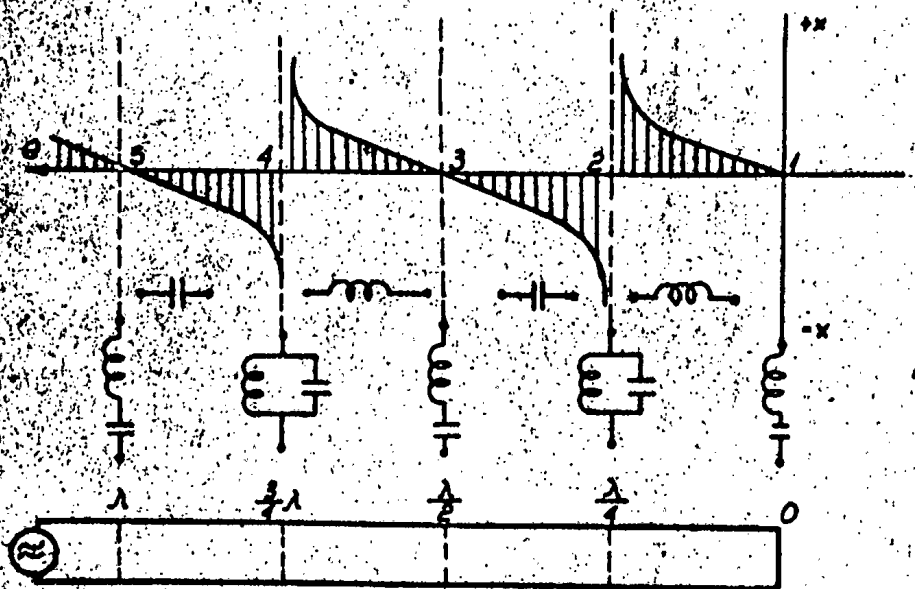

Fig. 36 Input impedance change character of closed line.

At points 1, 3, 5 input impedance equals zero, that means that closed line input impedance of odd number wave length quarters length equals zero.

At points 2, 4 input impedance of line equals infinity that means that closed line input impedance of length which is of even wave length quarters number equals infinity.

Inductive character of closed line input impedance lay

between borders of odd wave length character lay between borders of even

Closed line ends with length that is equal to even number of wave length quarters are similar to series resonant circuit tuned to resonance, but of odd numbers of wavelength quarter are similar to parallel resonance circuit.

50X1-HUM

If the load impedance is equal to line wave impedance, the input line impedance does not depend on its length and is equal to wave impedance. Such a line has no resonance peculiarity.

Line loaded with resistivity.

With the resistivity load of line, which is not equal to wave impedance two cases are possible:

when $r_{load} < \zeta$ and when $r_{load} > \zeta$
where ζ - wave impedance of line.

In both cases with line length that is equal to odd numbers of wave length quarters, its input impedance is real resistivity and has the value:

$$Z_w = \frac{\zeta^2}{r_{load}}$$

With line length that is equal multiplication of wave-length halves, its input impedance is equal to load impedance.

$$Z_w = r_{load}$$

At all intermediate wave lengths its input impedance has a joint character.

$$Z_w = r_w + jX_w$$

Then active part of input impedance changes itself from r_{load} to $\frac{\zeta^2}{r_{load}}$

Passive part of input impedance, if $r_{load} > \zeta$ has capacitive character at odd numbers of wave length quarters and at even number of quarters an inductive character.

At $R_{load} < \frac{1}{2}$ passive part of input impedance with even number of wave length quarters has capacitive character and inductance with odd numbers.

50X1-HUM

c. Construction and working idea.

The general view of main concentric line is shown on Fig. 37.

For connection with magnetron at the input end of main concentric line there is a nut fitted.

Magnetron pin gets into the central concentric line cable.

HF connection between outer pipe of main concentric line and outer pipe of magnetron output concentric cut is done by choke noncontact connection.

Output end of main concentric line has a connection getting to front plate of unit and serves for connection with cable of aerial circuit. To make the transmitter-receiver unit compact the connection is hermetic.

It is a cut of concentric line which is filled inside with rubber of low losses for HF and making the connection compact.

Main concentric line has three branches. One of them, as a suppressor for A.F.C. mixer is a round shaped waveguide cut. Its inner diameter is smaller than critical for given wave length oscillations generated by magnetron.

This cut is then border type suppressor in which ramified part of energy is weakening itself to certain level corresponding to suppressor length.

Second ramification determines $\frac{1}{4}$ wave cut of concentric line on end of which is a coupling loop for connection with cavity resonator of discharging valve.

Third ramification is as a passive matching loop, destined for compensation passive capacity part brought into the line by second ramification.

During consideration of long line cuts properties we have seen that input impedance of closed long line cut /of length a bit longer than $\frac{1}{4}$ wave length/ has capacity passive part.

Real length of concentric line loop for discharging valve cavity resonator connection is a bit bigger /because of loop/ than $\frac{1}{4}$ wave length. Apart of that, this cut during the transmission, determines closed cut of long line.

50X1-HUM

In such a manner we have, during the transmission closed cut of long line /of length a bit longer than $\frac{1}{4}$ wave length/ which brings to the main concentric line capacitive passive part.

The length of matching loop is a bit smaller than $\frac{1}{4}$. Input impedance of this loop determining closed long line cut of length shorter than $\frac{1}{4}$ has inductive passive part and compensates capacitive passive part brought by second ramification.

It gives wave impedance matching of main concentric line to load impedance and brings the working conditions to conditions of traveling wave at which all energy is transferred to the load.

The tuning with help of matching loop is done according to minimum standing wave factor of main concentric line at the terms of transferring the HF energy.

3. Aerial switch.

Aerial switch serves for switching the aerial from reception to transmission and for securing receiver input elements, before the damage during power impuls radiation by magnetron.

In SRD-1M set, the aerial switch consists of cavity resonator with discharging valve, $\frac{1}{4}$ wave and $1\frac{1}{4}$ wave long line cuts.

Cavity resonator with discharging valve represent resonance oscillating circuit, which is tuned to resonance with magnetron generator frequency. Cavity resonator consists of two half chambers in each of them there is input connection for receiver mixer coupling loop entrance and $\frac{1}{4}$ wave cut of main concentric line.

There are two tuning stoppers in one of these half chambers. The tuning is done by screwing them in or out. This causes

S-E-C-R-E-T
NO FOREIGN DISSEM

50X1-HUM

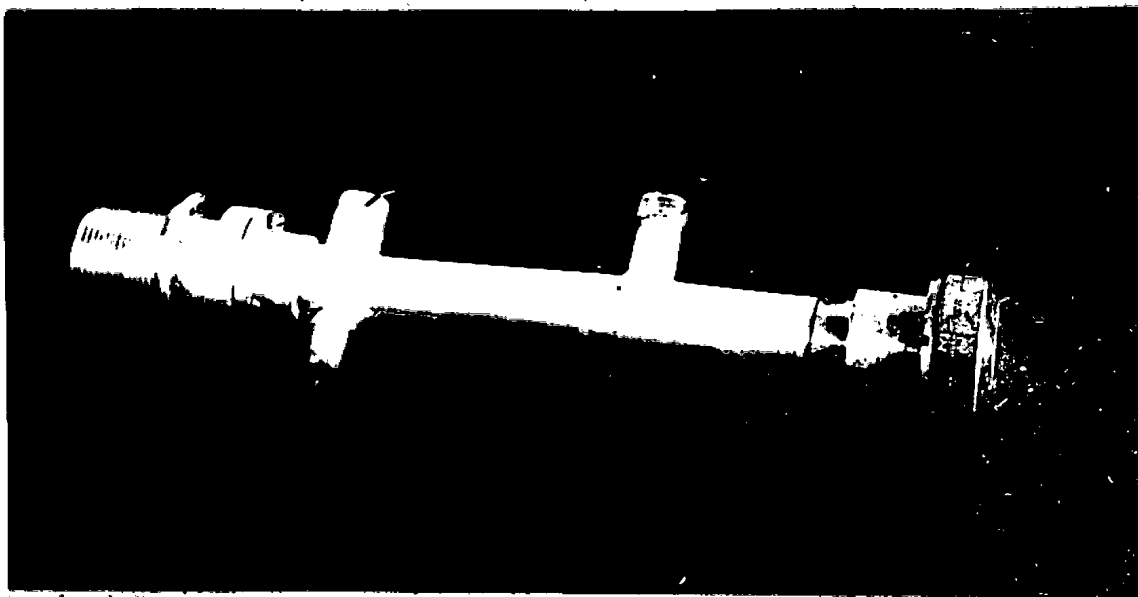

Fig. 37. General view of main concentric line.

- 1 - Choke connection for magnetic connection
- 2 - Border discriminator of APC mixer
- 3 - $\frac{1}{4}$ wave line cut of aerial switch
- 4 - Coupling loop
- 5 - Main concentric hermetic outlet
- 6 - Matching loop

S-E-C-R-E-T

NO FOREIGN DISSEM

NO FOREIGN DISSEM

the change of circumference of cavity resonator and in result its resonance frequency.

50X1-HUM

In this way the cavity resonator is tuned up to received signal frequency /magnetron frequency/. As an aerial switch discharging valve the valve RF-5 /2V-5/ is used. It is resonance gas filled discharging valve. General view of cavity resonator with discharging valve is shown on Fig. 38. The working idea of aerial switch is as follows:

At the time of pulse radiation by magnetron, a part of its energy ramificates from main concentric line through $\frac{1}{4}$ wave line cut to cavity resonator of discharging valve.

The HF voltage, which is applied to conical discharging valve electrodes, causes in the valve the discharge in gas.

The resistance of discharging valve is then very small. In effect it means that oscillating circuit /cavity resonator/ is shunted with very small resistance very near to zero, what is well seen on substitute circuit shown on Fig. 39.

In such a way the load of $\frac{1}{4}$ wave line cut, connecting the discharging valve chamber with main concentric line is very near to zero. In effect of above, the input impedance of this cut, at ramification point from main concentric line is equal infinity.

In result the magnetron pulse energy does not ramificate to aerial switch and does not come to receiver mixer, which is coupled by coupling loop with cavity resonator.

In this way the receiver mixer crystal detector is secured before the damage by magnetron power pulse at a time of radiation. Practically the small part of magnetron power pulse, in any way, will get through the aerial switch to the crystal detector of receiver mixer, because in discharging valve, at a time of discharge is small HF voltage, which helps discharging, and also because the discharge in valve does not start at the same time with start of magnetron pulse, but after some time, necessary for gass ionization in discharging valve.

For decreasing the penetrating power to safe for crystal detector value there is a firing electrode in discharging valve, on which the constant negative voltage of -750 V. is

S-E-C-R-E-T

NO FOREIGN DISSEM

S-E-C-R-E-T
NO FOREIGN DISSEM

50X1-HUM

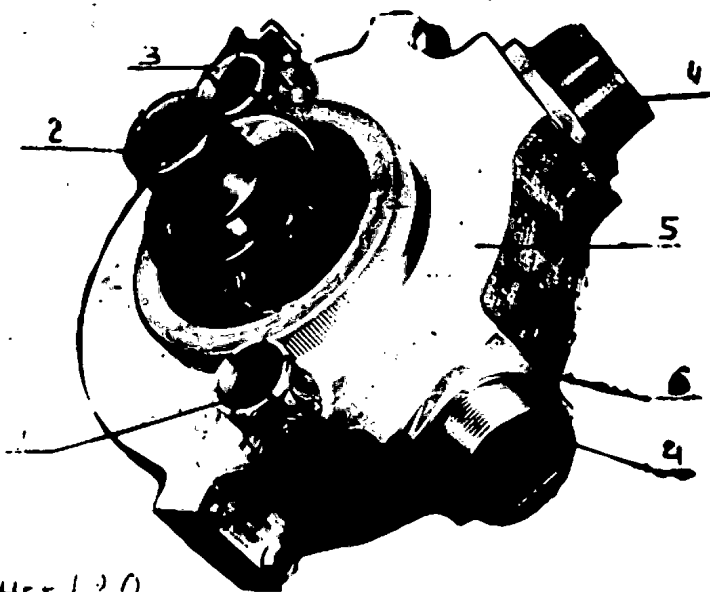

Fig. 38 General view of cavity resonator with discharging valve.

- 1 - Receiver mixer coupling loop entrance
- 2 - Discharging valve RR 5.
- 3 - $\frac{1}{4}$ wave line cut coupling loop entrance
- 4 - Tuning stoppers
- 5 - Cavity resonator
- 6 - Nut.

79

S-E-C-R-E-T

NO FOREIGN DISSEM

NO FOREIGN DISSEM

50X1-HUM

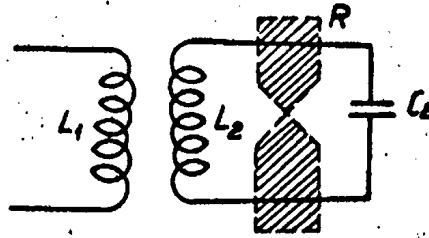

Fig. 39. Substitute circuit of discharging valve.

L_1 - coupling loop

$L_2 C_2$ - Cavity resonator circuit items

R - Discharging valve RR 5.

applied from firing rectifier through resistor 2R-19. The potential of conical electrode inside which is firing electrode equals zero.

The working idea of firing electrode is as follows: Small constant discharge inside conical electrode causes gas ionization which is hastening the ionization between conical electrodes at a time of appearance on them, HF voltage from magnetron pulse.

In this way the discharge starts quicker and the penetrating power to receiver circuits becomes smaller. When the magnetron pulse is finished, the discharge in the discharging valve stops and after some time /practically 2 μ sec./ necessary for gas deionization in valve, the cavity resonator obtains again its resonance property and the receiver becomes switched on to the aerial.

During the reception the reflected from target signal comes from aerial circuit to main concentric line. At the ramification point, serving for discharging valve chamber connection, the signal should ramificate in to two directions: to magnetron and receiver. Because the received signal power is very small there is no discharge in discharging valve and in cavity resonator the

S-E-C-R-E-T

NO FOREIGN DISSEM

NO FOREIGN DISSEM

HF oscillations will be stimulated.

get in to the receiver mixer through the coupling loop.

Because the magnetron generator does not work at that 50X1-HUM time its impedance is very big.

The distance between ramification and discharging valve chamber equals $6 \frac{\lambda}{4}$; so we can consider that this concentric line cut, as an open end of long line cut. of even $\frac{1}{2}$ wave number.

Input impedance of such a long line cut is equal infinity, and received signal energy will not ramificate toward magnetron. In practice there is a very small part of energy ramificated. When the unit works in low temperature -60°C the deionization time of discharging valve remarkable increases. It means that at the time of reflected from target signal coming, in effect of not complete deionization the discharging valve will not recover resonance properties and will have good real conductivity. It will cause big received signal losses and in effect decreasing of receiver sensitivity. For elimination of this phenomenon the cavity resonator is warmed up by special heater 2 PD-1.

The heater in shape of 2 flat rings is put on the front surface of cavity resonator. In its circuit there is a thermostat regulator connected in series.

It is a bimetal contact plate which switches the heater on at $+5^{\circ}\text{C}$ and off at $+50^{\circ}\text{C}$.

In this way the temperature of cavity resonator is kept always over $+5^{\circ}\text{C}$ that is quite sufficient for normal sensitivity of receiver set at low temperature.

The supply voltage for heater is 27 V and a power consumption 150 W.

Disassembled cavity resonator, with discharging valve is shown on fig. 40.

81

S-E-C-R-E-T

NO FOREIGN DISSEM

S-E-C-R-E-T
NO FOREIGN DISSEM

50X1-HUM

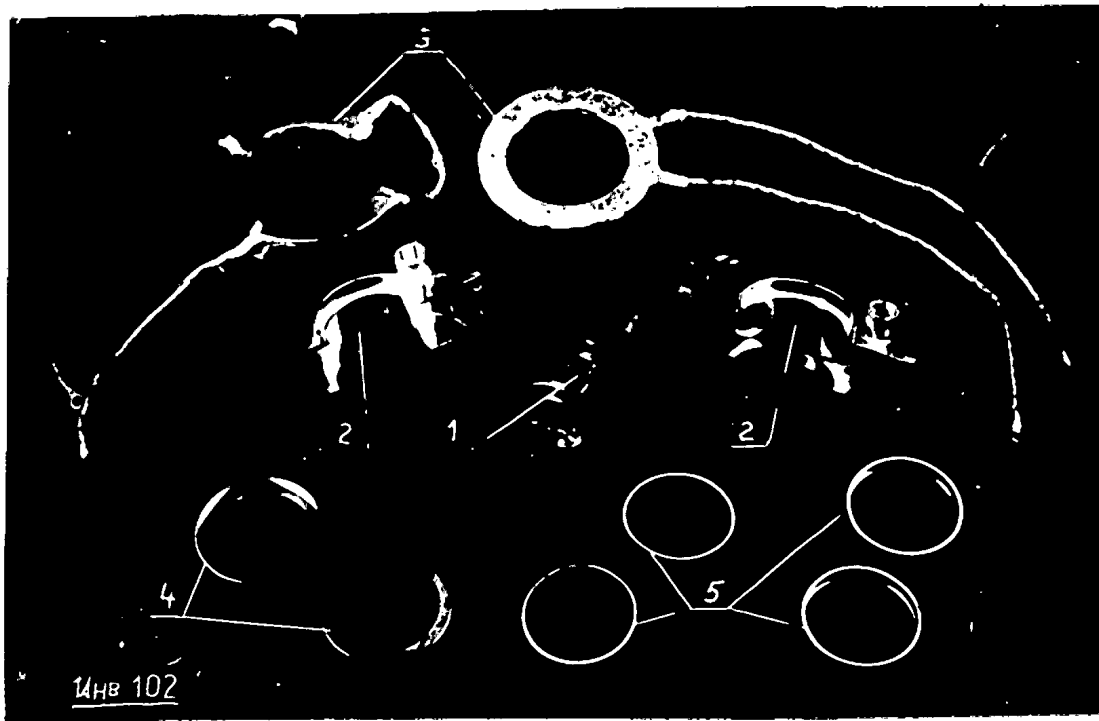

Fig. 40. Disassembling cavity resonator with discharging valve.

- 1 - Discharging valve RR-5
- 2 - Halfchambers of cavity resonator
- 3 - Heater of cavity resonator
- 4 - Nut
- 5 - Compacting rings.

S-E-C-R-E-T
NO FOREIGN DISSEM

NO FOREIGN DISSEM

4. Receiver mixer.

The concentric line cut is as a receiver mixer. It has a coupling loop on one end which fits in to the cavity resonator of discharging valve. On the other end of this line cut, there is a cristal detector type DGS-2 /27-1/ connected in to the central wire of the line. There is also the filter and a socket with coupling disc. The view of receiver mixer is shown on Fig. 41. The mixer consists of three main parts: mixer chamber with coupling loop, cristal detector fitting /support/ with filter and socket with coupling disc.

Disassembled mixer is shown on Fig. 42. The socket with coupling disc is made in form of a screw, what gives the chance to immerge it more or less in to the mixer chamber.

In this way the coupling between mixer and heterodyne is changed, because the change of immerging of coupling disc the capacity, between the disc and central wire of mixer's chamber is changed and in effect the value of power, coming from heterodyne will change.

The coupling setting to suitable value should be done according to the current value of cristal detector which should be: $I_{or} = 0,2 + 0,8 \text{ mA}$.

The cristal detector fitting with filter, determines concentric line cut, inside which there is a sleeve filled with dielectric material. The electric length of this cut is equal $\frac{1}{4}$ wave length. This $\frac{1}{4}$ wave cut is as a filter, shortening the HF parts of cristal detector current. In output of cristal detector fitting there is a socket for cable connection from IF preamplifier.

5. AFC mixer.

The view of AFC mixer is shown on Fig. 43.

The AFC mixer consists of four main parts:

1. mixer chamber, 2 shortened loop, 3 socket, with coupling disc, and 4 cristal detector fitting with filter.

Disassembled AFC mixer is shown on Fig. 44.

The receiving end of AFC mixer is connected to main concentric

83

S-E-C-R-E-T

NO FOREIGN DISSEM

50X1-HUM

S-E-C-R-E-T

NO FOREIGN DISSEM



50X1-HUM

Fig. 41. General view of receiver mixer.

- 1 - Mixer chamber.
- 2 - Coupling loop
- 3 - Socket with coupling disk.
- 4 - Crystal fitting with filter.

S-E-C-R-E-T

NO FOREIGN DISSEM

S-E-C-R-E-T
NO FOREIGN DISSEM

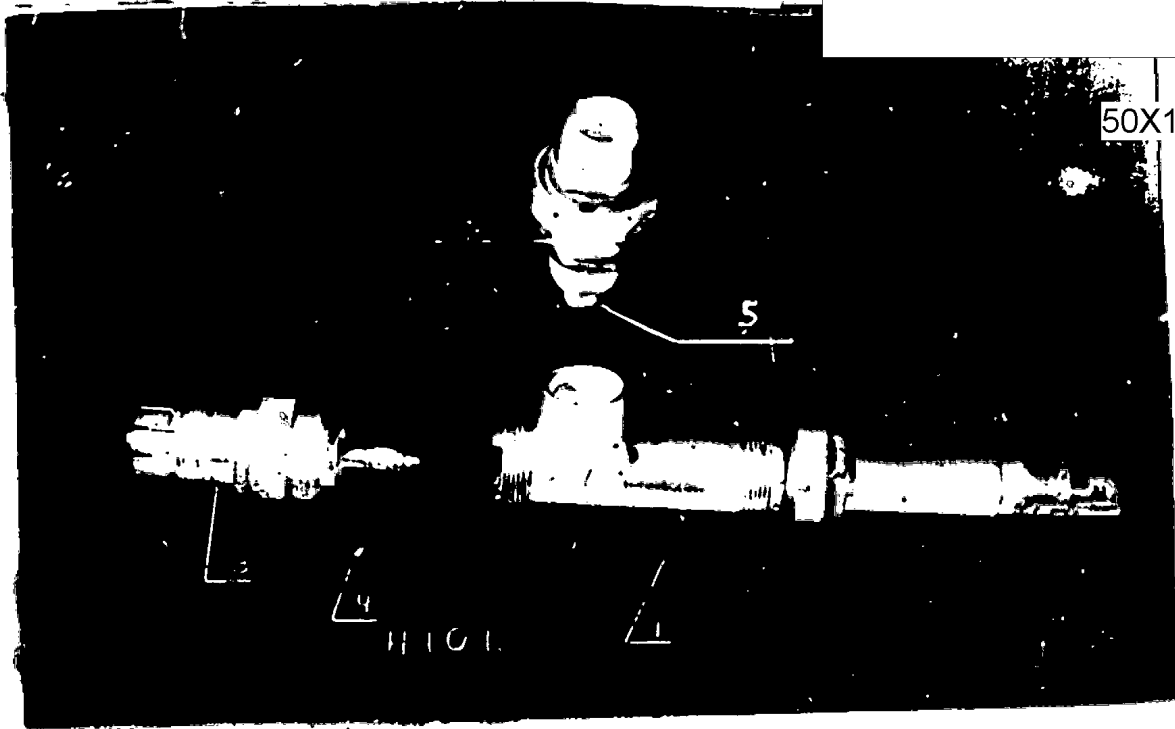

50X1-HUM

Fig. 42. Disassembled mixer of receiver.

- 1 - Mixer's chamber
- 2 - Socket with coupling disk.
- 3 - Cristal detector fitting with filter.
- 4 - Cristal detector DCS-2.
- 5 - Coupling disk.

55

S-E-C-R-E-T
NO FOREIGN DISSEM

NO FOREIGN DISSEM

line purification creating a bumper.

The socket with coupling disk has similar function and has the same construction as a socket with coupling disk of receiver mixer. The coupling with heterodyne is set in such a way that crystal detector current should be

$$I_{cr} = 0.5 \pm 1.5 \text{ mA.}$$

Shortened loop, as it was stated above, is designated for making a closed circuit for direct part of crystal current and also serves for mixer input impedance matching.

Shortening piece of loop is made in shape of a screw and can be moved for length change of shortened loop. The length of this loop should be set up in such a way that will cause the maximum signal in the output of mixer.

Crystal detector fitting with a filter has the same construction as in receiver mixer.

Also the DGS-2 /2D-2/ crystal detector is used in A⁷C mixer.

6. Klystron heterodyns.

Local heterodyne of transmitter-receiver unit is built on klystron with reflecting electrode type K-12 /2V-4/. General view of klystron heterodyne is shown on Fig. 45.

As we can see on the figure, the klystron heterodyne consists of klystron with reflecting electrode, cavity resonator and coupling loop. The coupling loop transfers the HF energy from cavity resonator.

Klystron heterodyne represents a self-oscillating generator of sinusoidal oscillations. This generator converts a direct current energy into radio frequency energy by alternately slowing down and speeding up an electron beam. This beam passing the grids of cavity resonator generates in it HF oscillations.

These oscillations generate the alternating HF field between resonator grids. The speed of traveling electrons in the space between the grids will be estimated by value and sign of grids voltage.

06

S-E-C-R-E-T

NO FOREIGN DISSEM

S-E-C-R-E-T
NO FOREIGN DISSEM

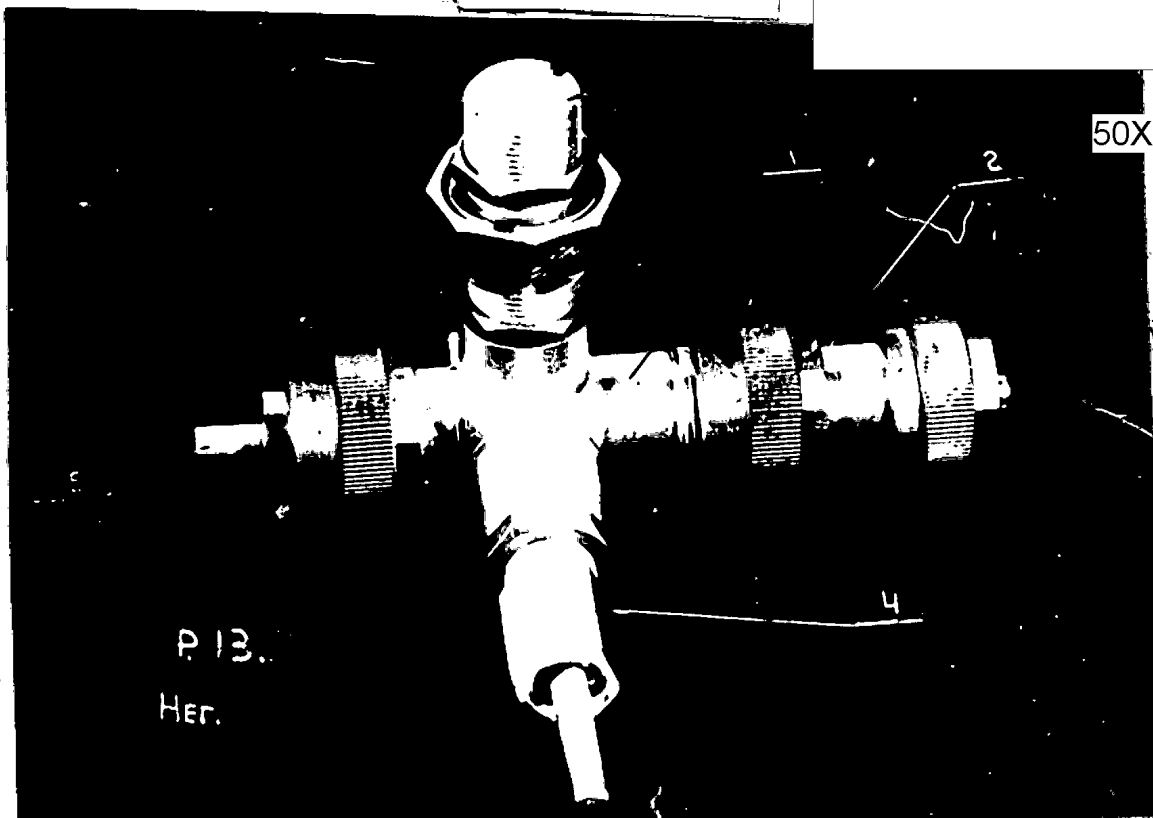

50X1-HUM

Fig. 43. General view of AFC mixer.

- 1 - Mixer's chamber
- 2 - Cristal detector fitting with filter
- 3 - Socket with coupling disk
- 4 - Shortening piston
- 5 - Mixer's receiving pin.

87

S-E-C-R-E-T

NO FOREIGN DISSEM

S-E-C-R-E-T
NO FOREIGN DISSEM

50X1-HUM

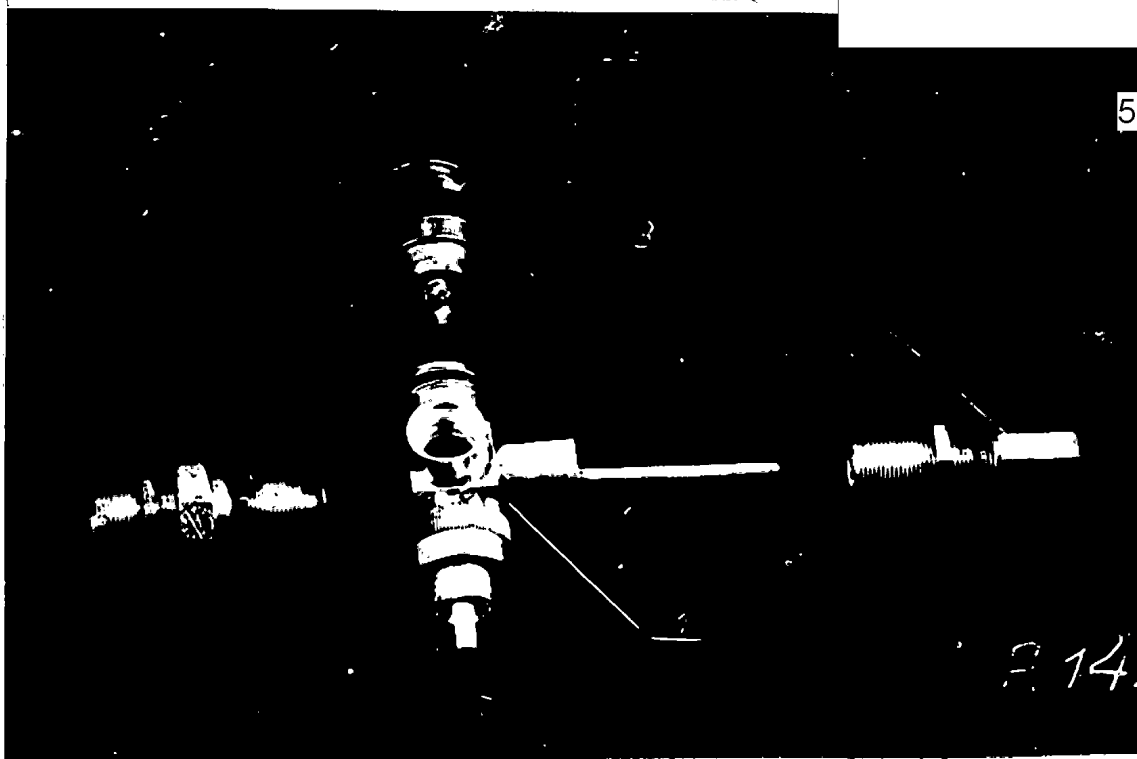

Fig. 44. Disassembled A7C mixer

- 1 - Mixer's chamber
- 2 - Cristal detector fitting with filter
- 3 - Cristal detector DCS-2
- 4 - Shortening piston
- 5 - Socket with coupling disk.

38

S-E-C-R-E-T
NO FOREIGN DISSEM

S-E-C-R-E-T
NO FOREIGN DISSEM

50X1-HUM

For understanding purpose let us consider the klystron circuit with reflecting electrode, shown on Fig. 46.

In the space between the grids the traveling electrons are getting into the alternating RF field which will speed them up or slow down with certain constant speed, obtained by the influence of positive voltage on speeding electrode.

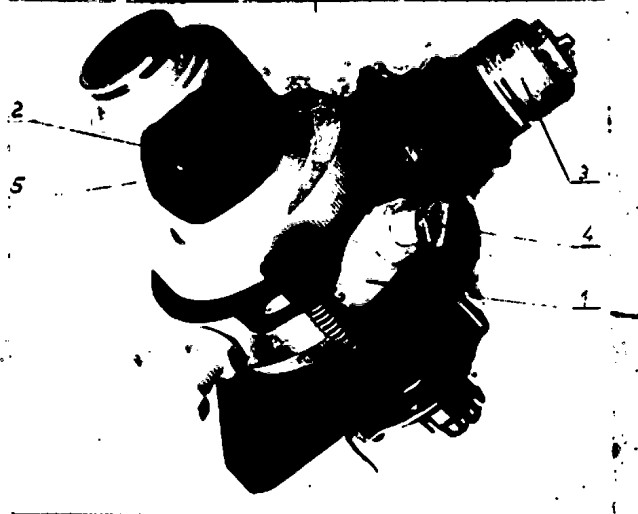

Fig. 45: General view of klystron heterodyne

- 1 - Klystron cavity resonator
- 2 - Klystron with reflecting electrode K-12
- 3 - Coupling loop body
- 4 - Tuning screw
- 5 - Bracket for reflecting electrode fitting

S-E-C-R-E-T

NO FOREIGN DISSEM

50X1-HUM

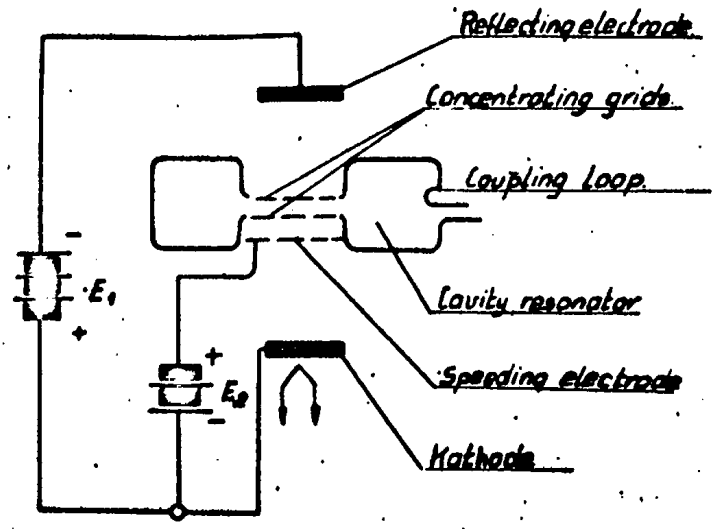
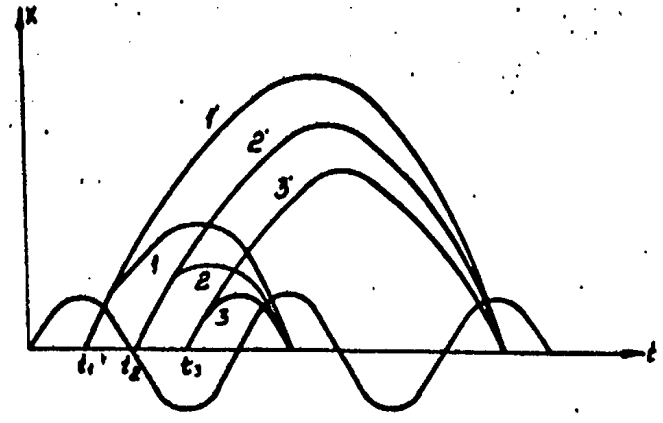

Fig. 46. Klystron diagram with reflecting electrode.



U_{HF} - HF voltage
 X - Distance from centre point of concentrating grids to reflecting electrode.

Fig. 47. Working characteristics of klystron with reflecting electrode.

NO FOREIGN DISSEM

50X1-HUM

At the time t_1 (Fig. 47) corresponding to positive potential on the top grid and to negative potential on bottom grid the electrons that will get into the space between grids find themselves in the speeding field, because the field direction is identical with electron travel direction.

In effect of this the speed of electrons is growing.

At the time t_2 the potential difference between the grids is zero and that is why the electrons coming to the space between grids are passing this space without the speeding up.

Electrons which get into the space between grids at the time t_3 will find themselves in slowing down electric field because the electric field lines are directed, at this moment in the opposite direction to the electron travel. That is why the electrons are getting out from the space between grids slower.

In effect of above described process the electron beam is modulated in its speed at the output of the between grid space. Further up this beam gets into the slowing down electric field generated by the reflecting electrode, which is biased with negative voltage.

That is why the electron motion at first is slower and then they are returned to control grids.

Obtaining suitable matching of reciprocal proportions between alternating voltage frequency between grids and constant voltage on the electrodes, we can obtain contemporary electron travel of various speeds through the middle of concentrating grids space.

At the suitable matching of klystron working conditions with reflecting electrode we can also enforce a group of electrons with big space load to the return into the area between concentrating grids, at such a time, when the voltage between grids is at its positive maximum. In this case the group of electrons will move itself in the slowing down electric field between the grids and will give up its energy, keeping up the oscillations in the cavity resonator.

By suitable matching of working conditions we can change the time of electrons return to the area between

11

S-E-C-R-E-T

NO FOREIGN DISSEM

S-E-C-R-E-T
NO FOREIGN DISSEM

50X1-HUM

concentrating grids and by that to change the power and frequency of generated by Klystron heterodyne oscillations.

Dependance of output power and frequency change of klystron from the voltage on reflecting electrode is shown on Fig. 48.

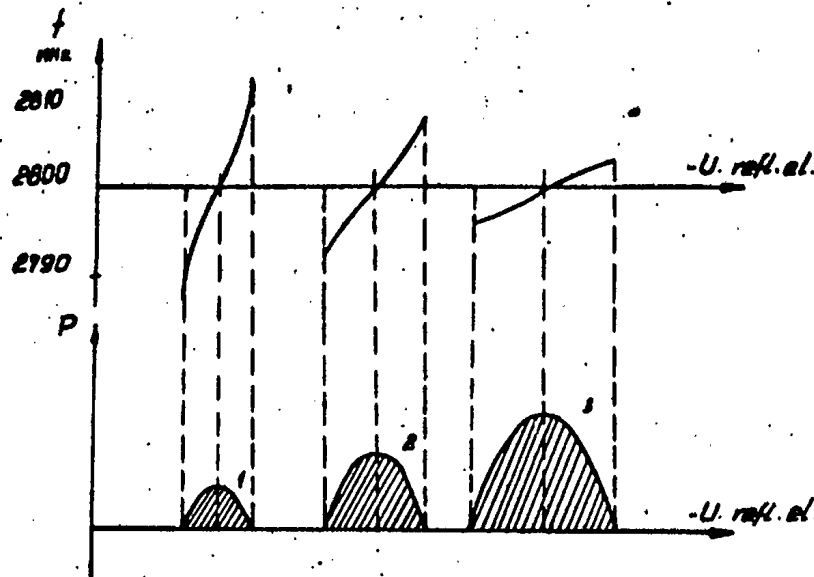

Fig. 48. Dependence of output power and frequency oscillations of klystron on reflecting electrode voltage.

As we can see on the figure there are moments when Klystron heterodyne does not generate any oscillations. It happens when the electrons are returning to the area between grids at the time of speeding up field distance in this area.

The energy of this field is used for speeding up the electrons and the oscillations are not kept up in the resonator.

We can also see on the figure that maximum output power is rising up with the increase of negative voltage on the reflecting electrode and obtains the maximum value at the return of electrons during one cycle of HF oscillations. It is represented by curves No 1, 2, 3 on Fig. 47 and maximum

S-E-C-R-E-T

NO FOREIGN DISSEM

50X1-HUM

generation area by curve No 3 on Fig. 43.

But, as it is shown on Fig. 48 at the change of voltage on reflecting electrode, corresponding to the arc, shown by curve No 3 the obtained range of generated frequency is not very big what can not cover necessary tuning range of klystron heterodyne.

To cover the necessary tuning range and also to obtain sufficient power of klystron heterodyne the tuning is made at the area shown by curve No 2.

The negative voltage for klystron reflecting electrode is taken from AFC circuit. The circuit 2R-20, 2C-9 in this stage is as a filter.

To speeding up electrode and grids, connected to cavity resonator the positive voltage of + 250 V is applied. In this way the cavity resonator is under the voltage of + 250 V in respect to the body.

Disassembled klystron heterodyne is shown on Fig. 49. Resonator of klystron heterodyne consists of two cylindrical cavities with tuning screws. Growing these screws in or out we can alter the circumference of resonator and so its resonating frequency, what means tuning to wanted frequency.

There is a hole in one cavity through which the HF energy is applied by the coupling loop.

Because the + 250 V HF voltage is on the resonator body, the coupling loop must be insulated by special sleeve, made of HF insulating material. The HF circuit is then closed through the sleeve as through the capacitance.

The surface of coupling loop should be situated in middle surface cavity resonator and fixed up by special supports on the plastic body of coupling loop.

The coupling loop is soldered up to short concentric line cut with connector on its end, for connection to three way ramificator.

The output power of klystron K-12 with the voltages $U_f = 5,3$ V, $U_r = 250$ V and at optimal voltage on reflecting electrode, at optimal coupling with load and KSFN, no more than 1,2 eqivs 70 mW at $\lambda = 10,7$ cm /2800 Mc/s/.

93

S-E-C-R-E-T

NO FOREIGN DISSEM

S-E-C-R-E-T
NO FOREIGN DISSEM

50X1-HUM

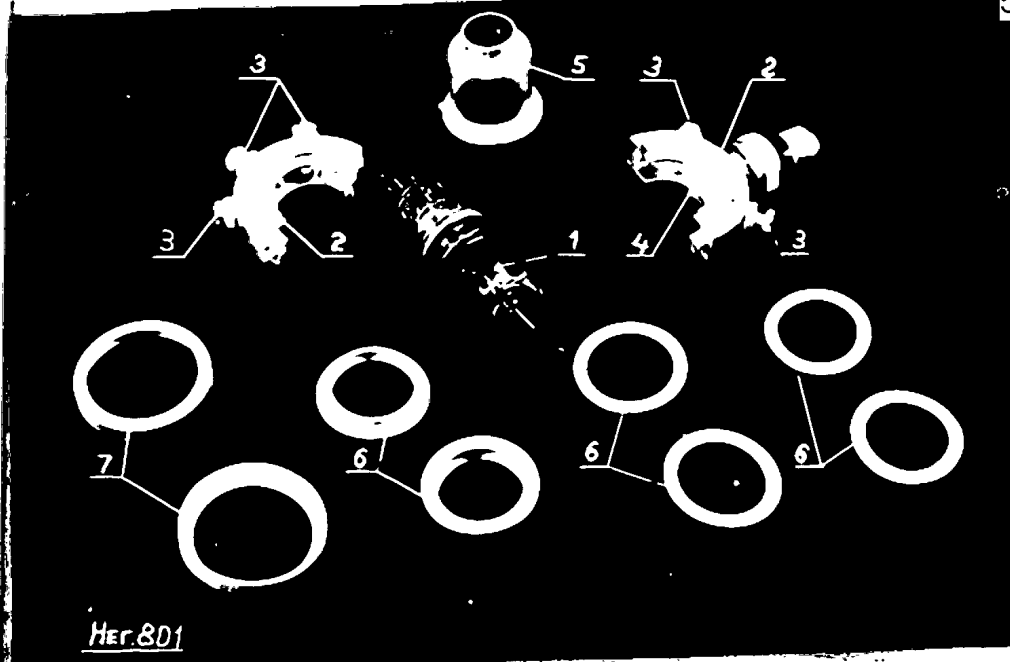

Fig. 49. Disassembled klystron heterodyne.

- 1 - Klystron
- 2 - Resonator cavities
- 3 - Tuning screws
- 4 - Coupling loop
- 5 - Screen
- 6 - Compact rings
- 7 - Nuts

Three way ramificator.

The three way ramificator is destined for transferring the HF energy of klystron heterodyne AFC. mixer and to receiver mixer.

General view of three way ramificator is shown on Fig. 50 To secure the stabilized work of heterodyne and to match its load with cavity resonator impedance there is a disk resistor fitted at the inlet of three way ramificator, the value of which is equal to concentric line wave impedance / 50 ohm'.

S-E-C-R-E-T

NO FOREIGN DISSEM

S-E-C-R-E-T
NO FOREIGN DISSEM

50X1-HUM

The disk resistor is made of ceramic plate covered on both sides with carbon. It is fixed vertically to the concentric axis.

General view of HF stage of transmitter-receiver unit in complete state is shown on fig. 51.

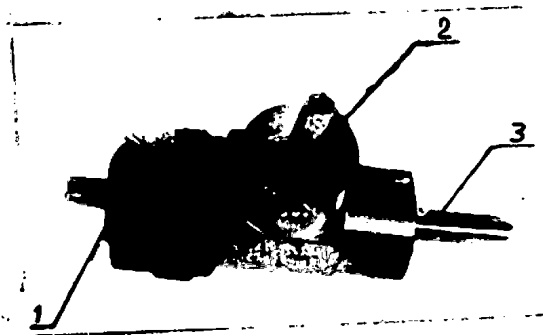

Fig. 50. General view of three way ramificator.

- 1 - Junction for coupling loop body connection of klyatron heterodyne.
- 2 - Outlet to AFC mixer
- 3 - Outlet to receiver mixer

55

S-E-C-R-E-T

NO FOREIGN DISSEM

S-E-C-R-E-T

NO FOREIGN DISSEM

50X1-HUM

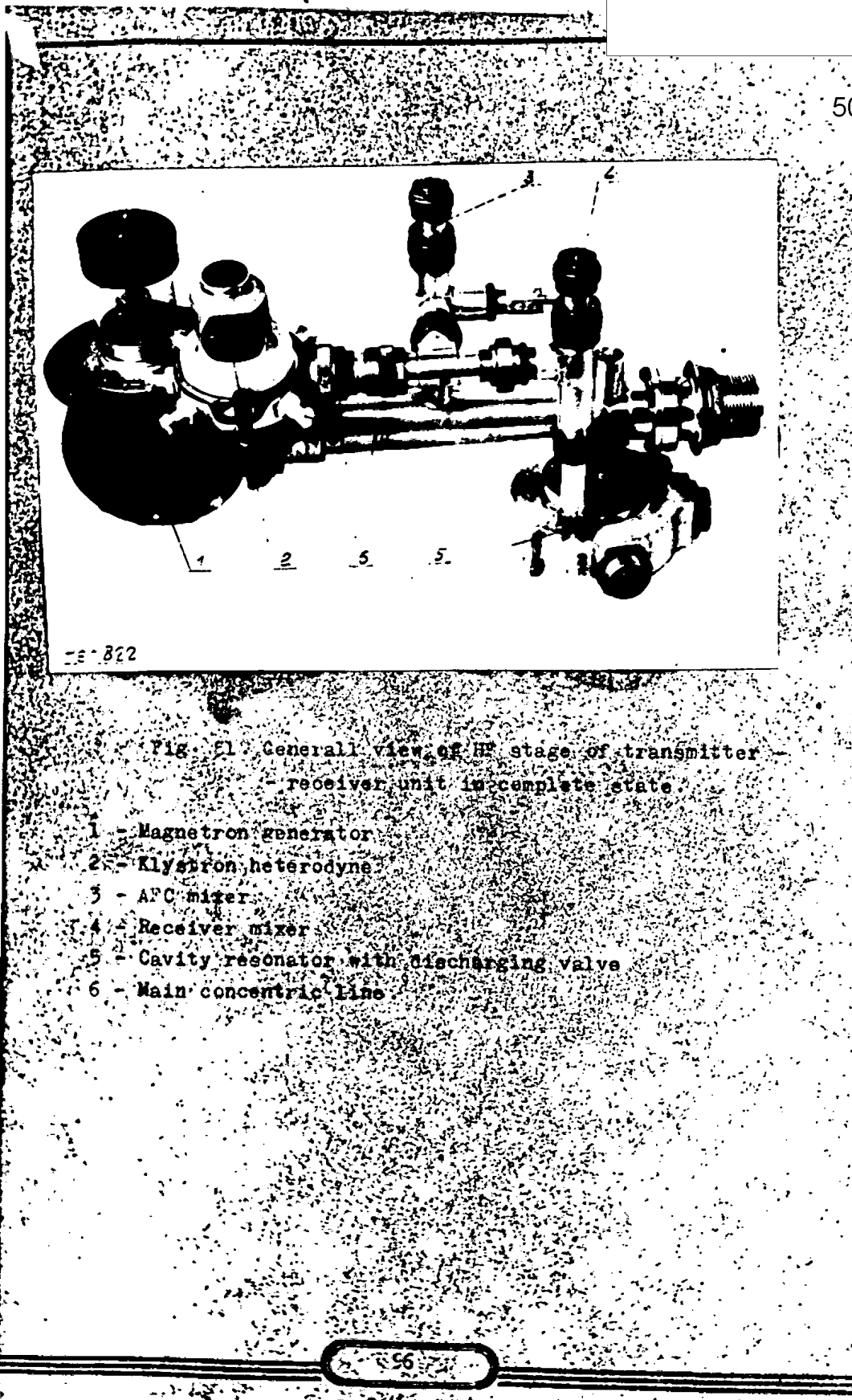

Fig. 51. General view of HF stage of transmitter-receiver unit in complete state.

- 1 - Magnetron generator
- 2 - Klystron heterodyne
- 3 - APC mixer
- 4 - Receiver mixer
- 5 - Cavity resonator with discharging valve
- 6 - Main concentric line

822

S-E-C-R-E-T

NO FOREIGN DISSEM

NO FOREIGN DISSEM

50X1-HUM.

AUTOMATIC FREQUENCY CONTROL OF KLYSTRON /AFC/

During the work of the set, magnetron generator frequency and klystron heterodyne may change in some way.

This change may be caused by change of temperature, humidity, supplying voltages and other reasons.

Will also change the intermediate frequency, which equals

$$f_i = f_h - f_g$$

where:

f_i - intermediate frequency

f_h - heterodyne frequency

f_g - generator frequency

But receiver signal amplification which is considerably different to medium intermediate frequency, being 30 Mc/s will be small.

The fundamental term of constant receiver amplification is the stability of intermediate frequency. AFC stage is just destined for this purpose and works in such a way that at any generator frequency change the klystron heterodyne is retuned by the change of the voltage on reflecting electrode /electronic retuning/. This retuning takes place in such a way that intermediate frequency / f_i / remains constant, because the heterodyne frequency is changed in value of frequency change in magnetron generator.

The given AFC circuit is build according to double channel diagram what means the AFC circuit has a separate channel for HF and is switched on by the pulse of its own transmitter. There is a hole in main concentric line through which a part of magnetron generator energy is transferred to mixing chamber of AFC. This concentric line ramification represents a border attenuator with suppressing of 53 + 5% dB.

The suppression is calculated of the admissible power coming to crystal to ensure the normal work of crystal.

Together with this power to AFC mixing chamber there are unquenched HF oscillation transferred continuously from

97

S-E-C-R-E-T

NO FOREIGN DISSEM

S-E-C-R-E-T
NO FOREIGN DISSEM

50X1-HUM

Klystron heterodyne. During the action of two HF oscillations /heterodyne and generator/ the HF current will flow through the crystal detector. Because the resistance of crystal detector is nonlinear, this current consists of various frequency harmonics, among which there is a harmonic equal to the difference of generator and heterodyne. The input circuit of AFC stage acts as a load for crystal detector on which the frequency difference voltage dissipates. The other harmonics will not get to AFC input because of filter which is represented by concentric line cut open on its end of $\frac{1}{4}$ wave length / $\frac{\lambda}{4}$ /. The input impedance of such a cut equals zero and that is why all HF harmonics are shortened, while the frequency difference current harmonic is easily passing through the filter.

As we can see from the diagram the receiving plug of inner concentric line wire has no electric connection with the body. Therefore, to make the circuit for constant part of AFC crystal current, the shorted concentric line cut is used. The length of this cut can be changed by altering the movable piston along the line. In this manner we obtain the matching of input impedance of AFC mixer to obtain maximum signal in the mixer output. The value of this signal should be 0,15 - 0,5 V.

Because of its work character the AFC circuit is a "searching" stage. AFC secures heterodyne retuning in wide range of "searching" with any speed.

The AFC "searching" is obtained by saw tooth negative voltage applied on Klystron reflecting electrode.

The circuit diagram of AFC is shown on Fig. 52.

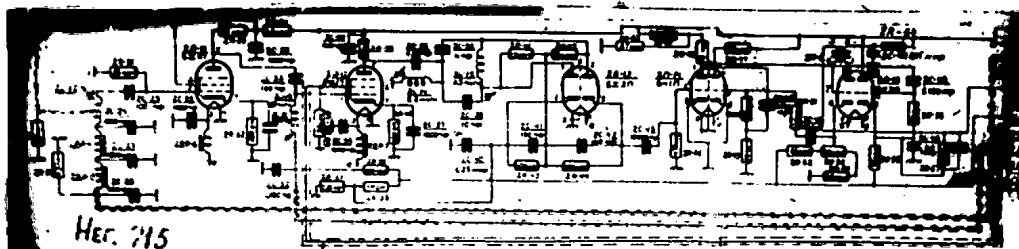

S-E-C-R-E-T

NO FOREIGN DISSEM

50X1-HUM

The AFC stage works in following way:

At the time of probing pulse radiation from cristal mixer 2D-2 /DGS-2/ the frequency difference pulse is applied to input circuit 2L-12 which is coupled with first IF amplifier stage by autotransformer. Direct part of AFC cristal current passes through chokes 2D1-4, 2D1-5 and 2R-30 resistor to the ground. Direct part voltage of cristal current is launched to control stage from 2R-30 resistor by screened cable. The filter consisting of capacitance 2C-27, 2C-28 and chokes 2D1-4, 2D1-5 serves to separate the alternating part of cristal current from control panel.

The control grid of AFC stage first IF amplifier receives the signal from 2L-12 circuit through capacitor 2C-25.

This grid has the automatic grid bias which is obtained due to voltage drop on 2R-32 resistor. Condenser 2C-31 serves as a blocking capacity for HV. The anode and screen grid voltage is fed through resistors 2R-34 and 2R-33. Condenser 2C-30 serves for valve 2V-11 screen grid blocking and filtering.

The resonance circuit of 2V-11 valve consisting of coil 2L-13, output capacity of 2V-11 valve and input capacity of 2V-12 valve is used as a anode load for valve 2V-11.

First intermediate frequency amplifier is tuned to 30 Mc. Amplified pulse of frequency difference is applied to the control grid of valve 2V-12. This IF stage works the same as the first. The amplification of this stage is controlled by negative grid bias change on control grid of valve 2V-12. The grid bias voltage change is obtained from potentiometer 6R-3 /AFC amplification/ fitted on control panel. Such a control is necessary for obtaining the wanted amplitude of signal at the input of AFC discriminator.

At normal state the valve 2V-12 is blocked for anode current as there is a zero potential on screen grid by its connection through resistor 2R-28 to ground.

At the time of probe pulse radiation the screen grid of valve 2V-12 receives the positive ^{pulse} from modulator circuit. This starting pulse has the amplitude of 100 V and causes unblocking the valve. In this way the AFC stage works only from its own signal and makes the work impossible from other

NO FOREIGN DISSEM

50X1-HUM

signals and by that makes all AFC circuit resistable for distortions.

From the anode load of valve 2V-12 a resonance circuit of coil 2L-14 and output capacitance of this valve, the signals is fed on to the discriminator build of valve 2V-13 /5R2P/.

Discriminator is a basic unit ^{of} VFC stage. It converts the frequency difference changes to direct voltage changes. The value and sign of direct voltage change are designated by value and sign of frequency difference change to the frequency corresponding zero signal error of discriminator or as we shall it call, balance frequency. The input circuit of discriminator /coil 2L-15 and condensers 2C-38, 2C-39/ determine its more important characteristics: pass band wideness and balance frequency.

The simplified circuit of discriminator is shown on Fig. 53 in comparison to main circuit diagram of set /Fig. 66/. Discriminator input is made in shape of two oscillating circuits with fixed tuning and with a bit pushed as under the resonance frequencies. The voltage from those circuits is fed to two diodes /left and right half of valve 2V-13/. Resistor 2R-44 and condenser 2C-41 are used as a load for one diode and resistor 2R-43 and condenser 2C-42 as a load for second diode of valve 2V-13.

These loads are connected together in such a way that the arising voltages are mixed. So the discriminator output voltage equals to the voltages difference removed from the load of each diode of valve 2V-13.

Arising, in input circuits, voltage value is changed due to the value of IF. In effect the value of substitute impedance is changed. By that the values of currents flowing through the left and right half of the valve 2V-13 are changed and so the result voltage at the resistors 2R-43 and 2R-44. For better presentation of discriminator work all conversion phases of input discriminator circuit from basic to substitute circuits are shown. On the diagram condenser C₃ represents the capacity of both diodes. Condensers 2C-38, 2C-39 and C₃ making triangle are converted to substitute star of con-

103

S-E-C-R-E-T

NO FOREIGN DISSEM

NO FOREIGN DISSEM

50X1-HUM

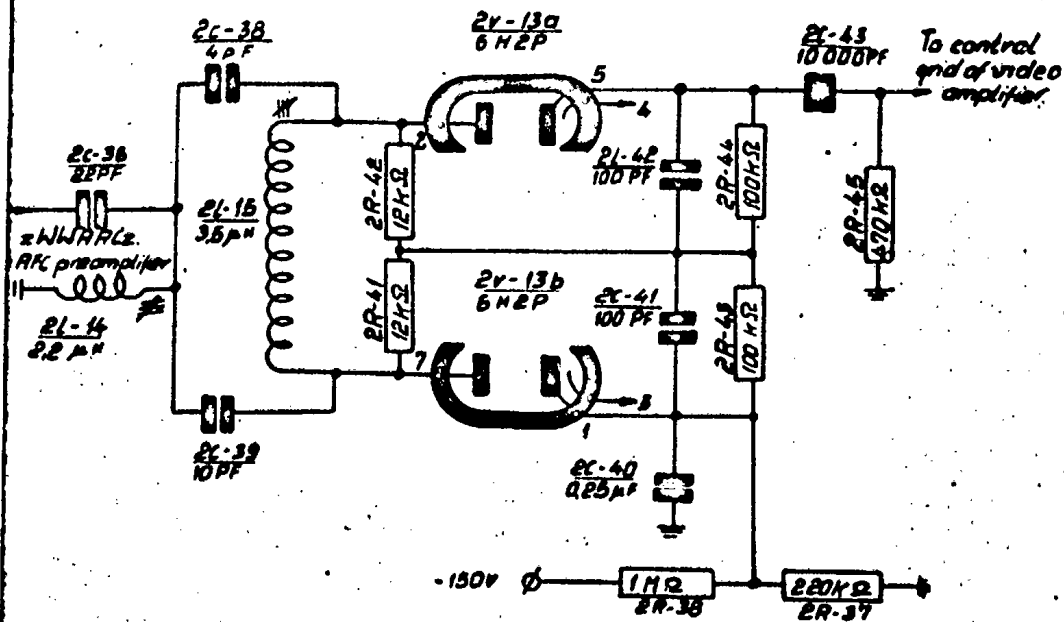
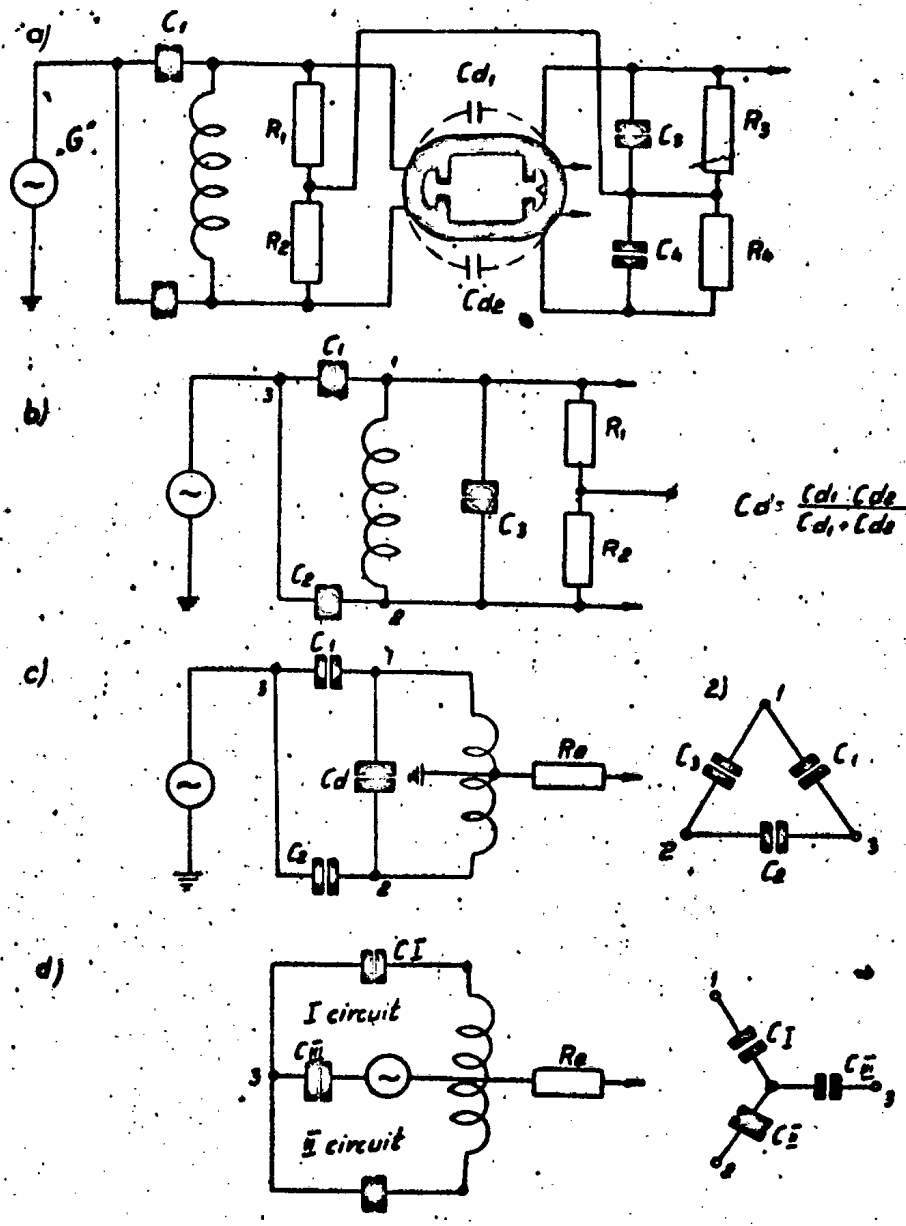

Fig. 53. Discriminator wiring diagram.

S-E-C-R-E-T

NO FOREIGN DISSEM

50X1-HUM



$$Cd = \frac{Cd_1 \cdot Cde}{Cd_1 + Cde}$$

Fig. 54. Conversion of basic discriminator input circuit to the substitute circuit.

TOP

S-E-C-R-E-T
 NO FOREIGN DISSEM

S-E-C-R-E-T

NO FOREIGN DISSEM

50X1-HUM

condensers C_I , C_{II} , C_{III} . Resistors 2R-41, 2R-42 make a center point, coil 2L-15 is converted to resistor R_2 connected to the center point of coil 2L-15.

Fig. 55 shows a full substitute diagram of discriminator. The amplifier with valve 2V-12 precedent the discriminator is shown as "G" /substitute generator/.

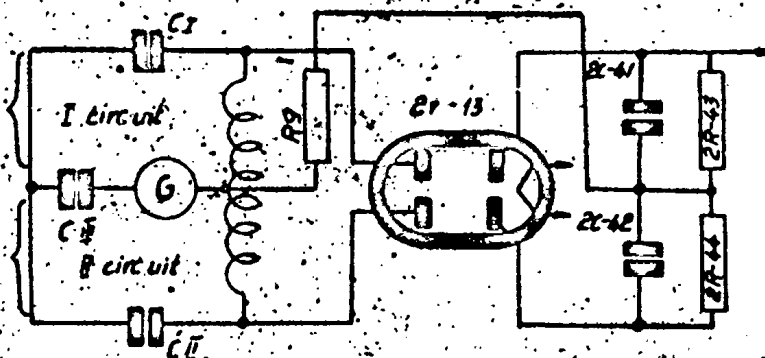

Fig. 55 Full substitute diagram of discriminator.

The halves of coil 2L-15 and condensers C_I , C_{II} are made as two resonance circuits in series for the load to "G" generator. Both those circuits /I and II/ are tuned to lower frequency than IF. /30 Mc/s./

First circuit /I/ consisting of one part of coil 2L-15 and condenser C_I has the big conductance and higher tuning frequency than the other, consisting of second part of coil 2L-15 and condenser C_{II} . It is because C_I is smaller than C_{II} and resonance frequency is growing when the circuit capacity is getting smaller.

But the conductance depends on its parameters.

$$Q = \frac{1}{R} \sqrt{\frac{L}{C}}$$

where: R - circuit resistivity
L - " inductance
C - " capacity

So we can see that the smaller capacity the better conductance of circuit the other parameters constant.

Fig. 56 shows the frequency characteristic separately for circuits I and II and also the full frequency

S-E-C-R-E-T

NO FOREIGN DISSEM

50X1-HUM

characteristic of discriminator /frequency characteristic difference of circuit I and II/. By the change of inductance value of coil 2L-15 there is in some way retuning possible of circuits I and II and so in some way the balance frequency of discriminator characteristic. Obtained amplitude of negative or positive top of frequency characteristic being asymmetrical, is completely admissible, because in considering stage the only positive top of discriminator frequency characteristic is used.

The symmetry of hump we can obtain by means of some mistuning of IF amplifier circuit 2L-14.

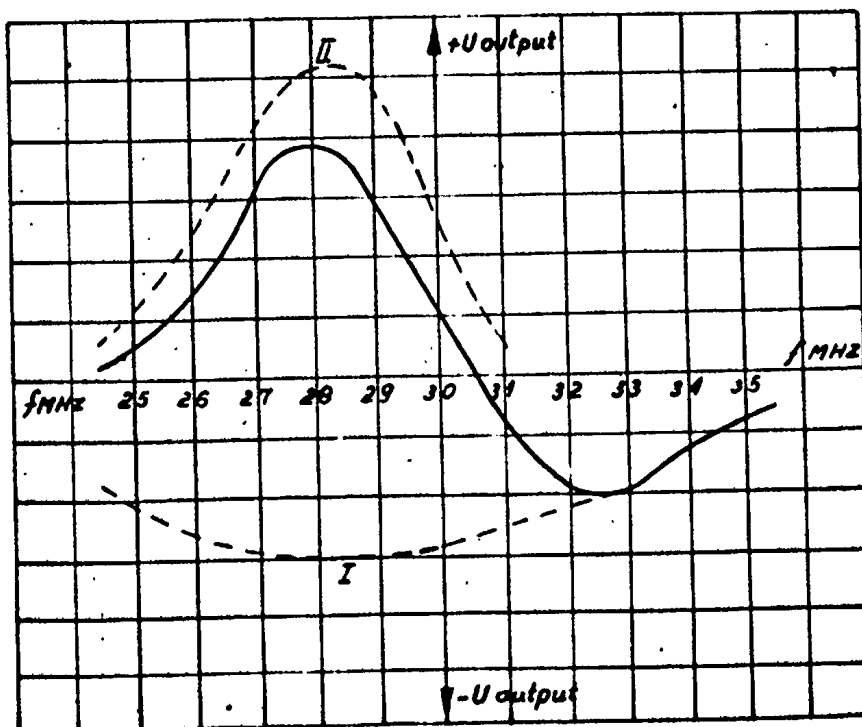

Fig. 56 Discriminator frequency characteristic.

In the discriminator output, in effect of delivering to its input the frequency difference pulse, appears the videopulse /"error signal"/. As it is seen from discriminator frequency characteristic, the value and sign of signal

50X1-HUM

error appearing every time during pulse generation; depends on how much, at the given time, the pulse frequency difference, differs from balance frequency.

If frequency difference is smaller from balance frequency, the signal error is positive, and has bigger amplitude the more difference frequency differs from balance frequency, and otherwise, if frequency difference is bigger from balance frequency, then error signal is negative, and has the bigger amplitude, the more difference frequency differs from balance frequency.

From discriminator output the error signal is launched to control grid of videamplifier valve 2V-14a /6N1P/ via condenser 2C-43 and from anode load 2R-46 it is fed on to second stage of videamplifier /valve 2V-14b/. From the anode of valve 2V-14b the videosignal is fed via condenser 2C-47 to the control grid of control valve 2V-15b /6N2P/ which works as a grid detector. Let us consider the work of grid detector, shown on Fig. 57 at the time of coming positive and negative videopulses.

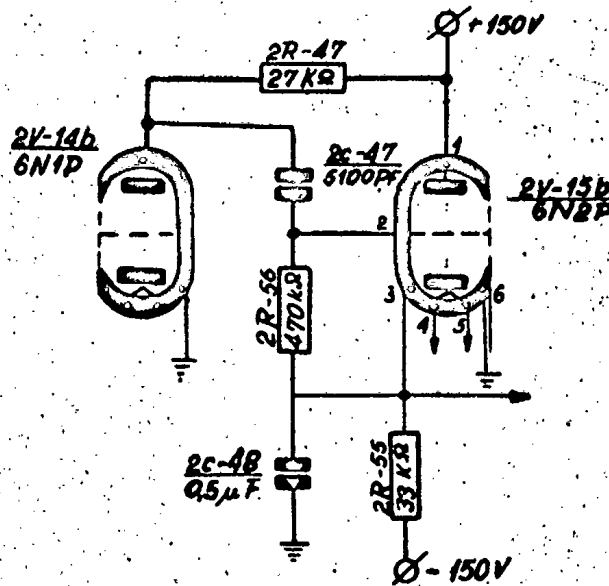

Fig. 57. Grid detector diagram.

NO FOREIGN DISSEM

50X1-HUM

When at the last stage of videopulse appears the positive videopulse, then the condenser 2C-47 will become charged via circuit: 2C-47 grid - cathode of 2V-15b, 2C-48 ground + 150 V supply source, 2R-47 and 2C-47. Time constant of this circuit is small, and that is why the condenser will manage to get charged nearly up to the value of this signal amplitude. When the videopulse is finished condenser starts to discharge via: valve 2V-14b inner resistance, ground, condenser 2C-48, resistor 2R-56, condenser 2C-47.

Time constant of this circuit is very big, condenser 2C-47 will be not completely discharged to the time of next videopulse coming.

Due to the discharge current on the resistor 2R-56 the voltage will appear applied with negative value to the control grid, what will decrease the flowing current through the valve 2V-15b.

Then on resistance 2R-55 the voltage drop will be decreased and will increase the negative voltage in the output, which is sent to reflecting electrode of klystron heterodyne, and in this manner the klystron generator frequency will be increased. That is why the next pulse, which comes to AFC circuit, will have bigger difference frequency. In the discriminator, this pulse will be transferred to videopulse of smaller amplitude than previous videopulse.

It is seen from discriminator frequency characteristic. Because condenser 2C-47 will not manage to get discharged until next videopulse coming, its charging will only be completed by this pulse but to smaller value.

On fig. 58 the work of grid detector is shown in object view.

In case of pulse coming to the input, which difference frequency is 30 Mc/s the grid detector is balanced, that means that condenser charging is completed to such a value from which it will have enough time to discharge until next videopulse is coming. In output of AFC the voltage klystron reflecting electrode will change in this case very little and klystron frequency will last practically constant.

106

S-E-C-R-E-T

NO FOREIGN DISSEM

NO FOREIGN DISSEM

50X1-HUM

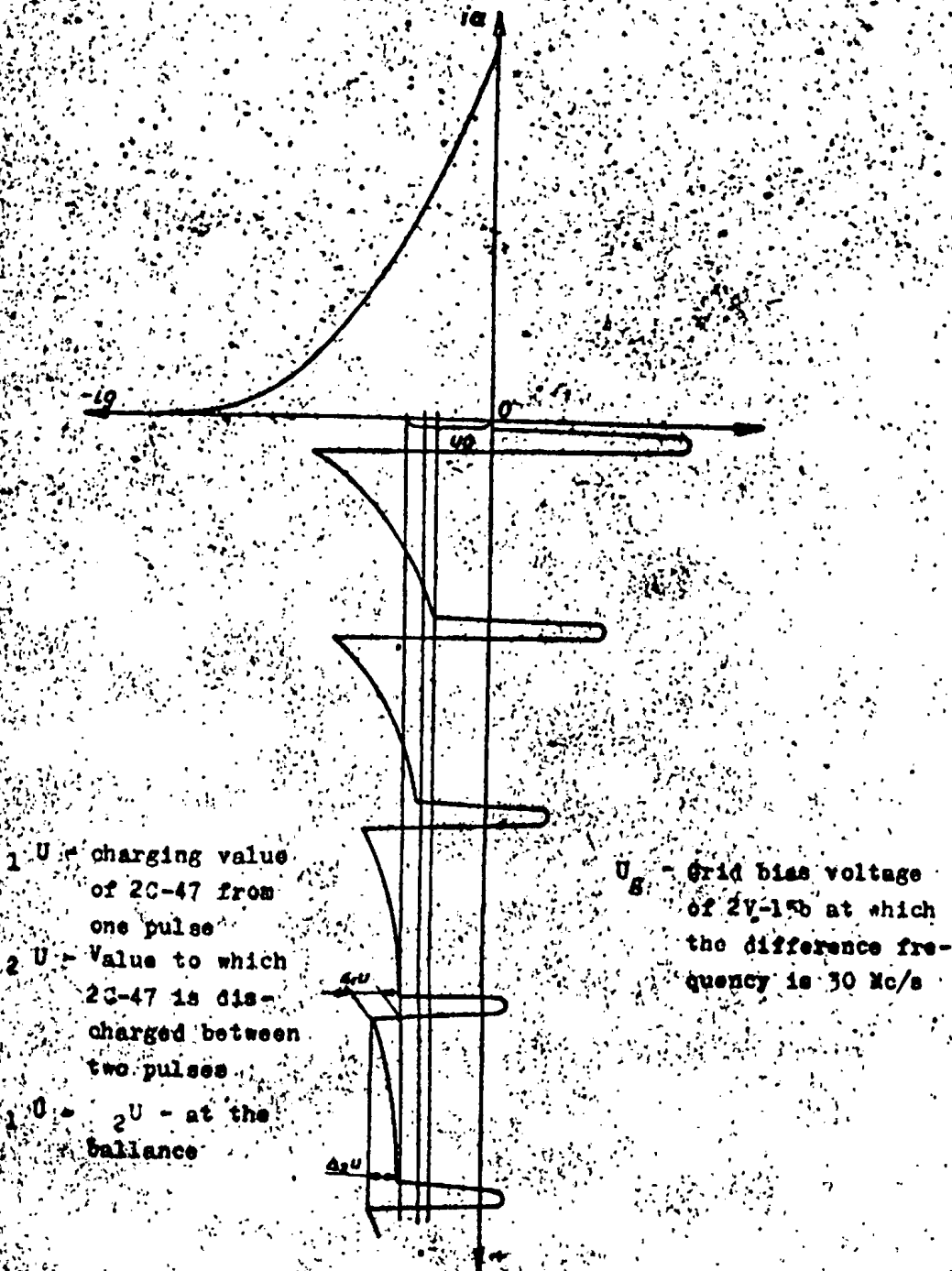

- 1. U_1 - charging value of 2C-47 from one pulse
- 2. U_2 - Value to which 2C-47 is discharged between two pulses
- 3. U_3 - $2U_2$ - at the balance

U_4 - Grid bias voltage of 2V-15b at which the difference frequency is 30 Mc/s

Fig. 5B. Voltage change character on the grid of grid detector.

S-E-C-R-E-T

NO FOREIGN DISSEM

NO FOREIGN DISSEM

50X1-HUM

If the difference frequency will change in such a way that it will become bigger from bellance frequency, then in discriminator output and also in output of videocomplifier the negative pulses will appear, which will not charge the condenser 2C-47 but will help to its discharge.

The negative voltage on the grid of 2V-15b will quickly decrease, what will bring to anode current increase, of valve 2V-15b.

Negative voltage on cathode of 2V-15b will also quickly decrease and will reach such a value, at which the blocking generator valve 2V-15a will be unblocked! Ebove mentioned blocking generator, generates continuous sinusoidal oscillations and works as an ordinary autogenerator with transformer feed back. Sinusoidal oscillations of this generator are fed to the grid videocomplifier /valve 2V-14b/ from cathode of valve 2V-15a via condenser 2C-46 and resistor 2R-51.

Because of zero potential on control grid of this valve the positive half cycles of sinusoidal oscillations will be cut off due to valve grid currents, and negative halfcycles will be amplified. From resistor 2R-47, which is as an anode load for valve 2V-14b, amplified positive pulses are passed to grid detector /valve 2V-15b/.

In effect of these positive pulses detection, the condenser 2C-47 is charged. At the same time the negative grid bias of valve 2V-15b increases, what brings to decreasing of anode current of this valve and increasing of negative voltage on its cathode.

This negative voltage increasing will reach such a value, at which the blocking generator valve will be blocked and oscillations will stop.

After this the capacitance 2C-48 starts slowly to discharge according to exponential curve until the blocking generator is again unblocked.

The same will happen in case, when difference frequency will reach the value below 27 Mc/s.

This "searching" will last until the difference frequency will reach the value of 30 Mc/s.

108

S-E-C-R-E-T

NO FOREIGN DISSEM

S-E-C-R-E-T

NO FOREIGN DISSEM

50X1-HUM

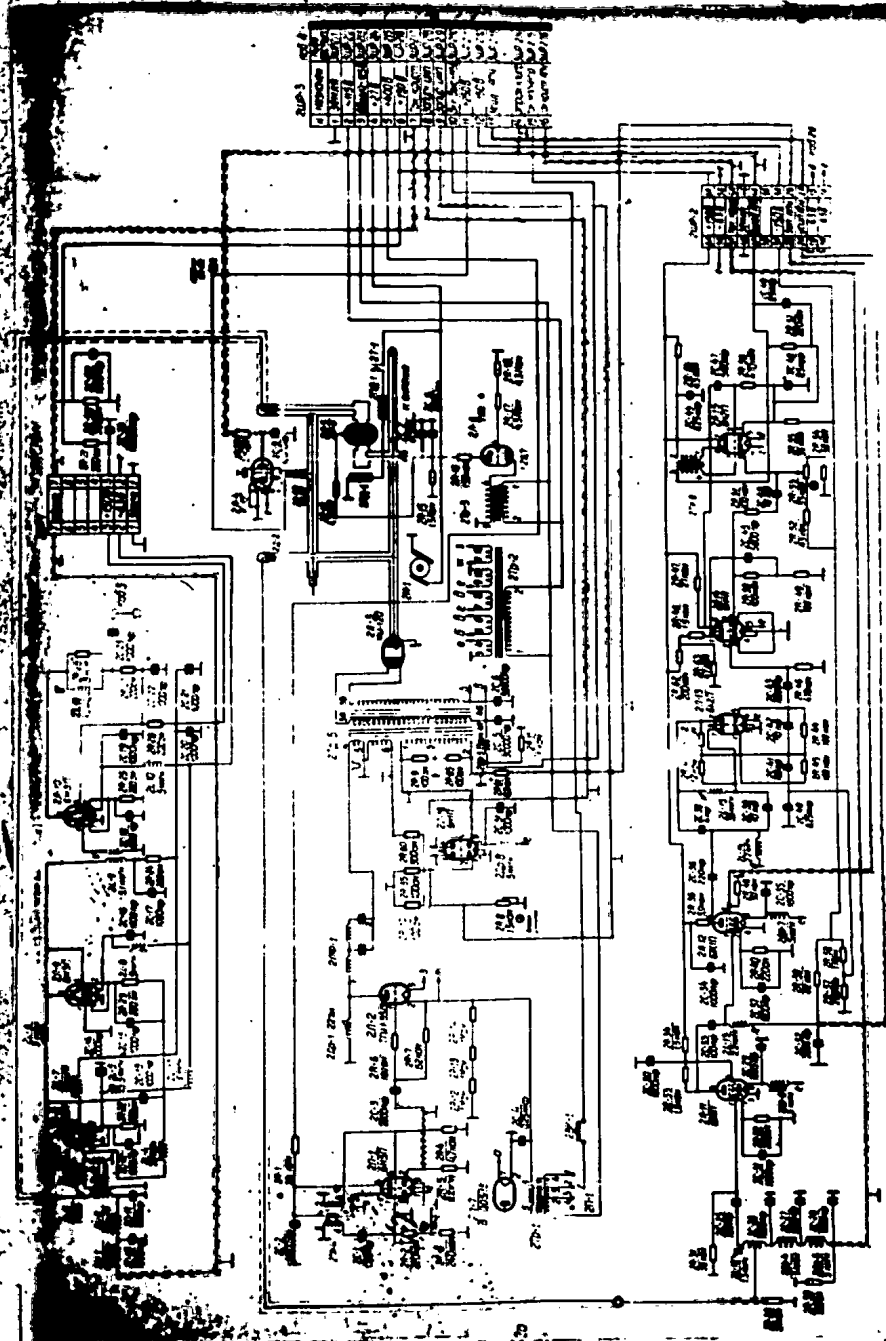

Fig! 59. Circuit diagram of transmitter-receiver unit.

109

S-E-C-R-E-T

NO FOREIGN DISSEM

NO FOREIGN DISSEM

50X1-HUM

Then the AFC stage will automatically return to controlling action, and blocking generator is at this time blocked.

For AFC searching voltage setting, the potentiometer 2R-53 is used, which controls the blocking generator cathode voltage /2V-15v/

This voltage should be so established, that the klystron frequency control would cause difference frequency change in range $27 \pm 30,6 \Delta\omega/s$.

Figures 60 and 61 show the general view ⁱⁿ montage view of AFC unit.

CONSTRUCTION OF UNIT

The transmitter receiver unit is fitted on welded support ^{which} is fixed by screws to the front panel of the unit. This support is placed in cylindrical cover with loose ring, serving for fixing to the front panel.

To make the unit compact, there is a cut off in the front panel, for placing the rubber ring. To this rubber ring cover, collar is pressed by screws and springs.

There are ribs made on the cover for better cooling of the unit.

110

S-E-C-R-E-T

NO FOREIGN DISSEM

S-E-C-R-E-T
NO FOREIGN DISSEM

50X1-HUM

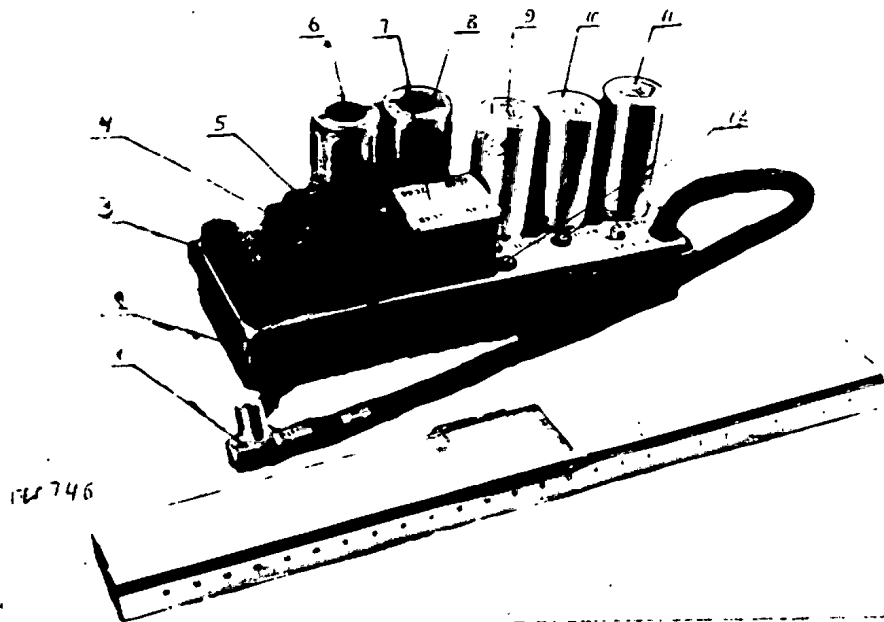

Fig. 60. General view of AFC unit.

- 1 - HF cable with connection
- 2 - Removable cover
- 3 - Supply connection
- 4 - Potentiometer 2R-53
- 5 - Pulse transformer 2Tr-5
- 6 - Blocking generator valve 2V-15
- 7 - Condensers 2C-40, 2C-44, 2C-48, 2C-49
- 8 - Videoamplifier valve 2V-14
- 9 - Discriminator valve 2V-13
- 10 - AFC preamplifier valve 2V-12
- 11 - " " " 2V-11
- 12.- Control points.

S-E-C-R-E-T

NO FOREIGN DISSEM

S-E-C-R-E-T
NO FOREIGN DISSEM

50X1-HUM

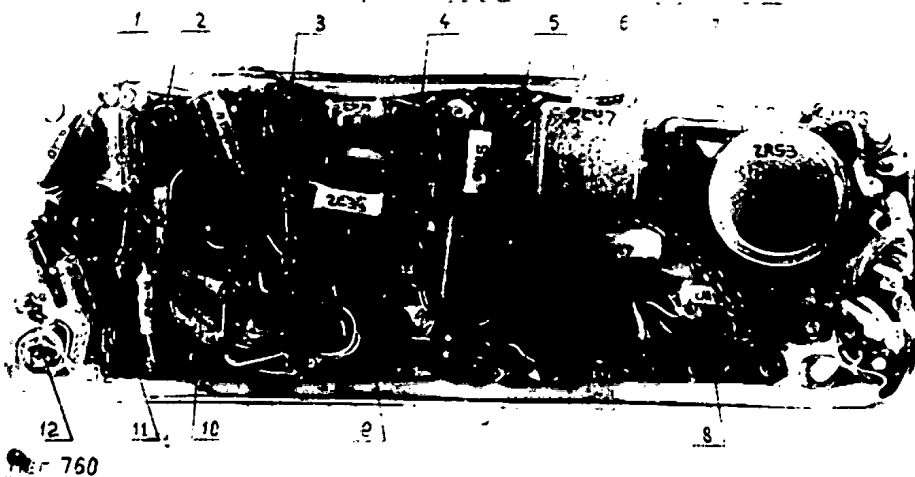

Fig. 760

Fig. 61. The bottom view of AFC unit.

- 1 - AFC preamplifier valve 2V-11
- 2 - Induction coil 2L-13
- 3 - " " 2L-14
- 4 - Discriminator circuit induction coil 2L-15
- 5 - Videoamplifier valve 2V-14
- 6 - Blocking generator and control valve 2V-15
- 7 - Potentiometer of resistance voltage setting
- 8 - Transformer 2 Tr-6
- 9 - Discriminator valve 2V-13
- 10 - AFC preamplifier valve 2V-12
- 11 - Induction coil 2L-12
- 12 - HF concentric input socket

The general view of unit is shown on Fig. 62.

On the front panel of unit there are following items fitted:

1. 16 - pin hermetic connection
2. HF hermetic connection "antenna" /"aerial"/ to which the aerial feeder of transmitter-receiver unit is connected.
3. HF hermetic connection for I.F. preamplifier and IF amplifier.
4. Stoper covering the inlet for discharging valve chamber regulation.
5. Junction for air supply.

112

S-E-C-R-E-T

NO FOREIGN DISSEM

S-E-C-R-E-T
NO FOREIGN DISSEM

50X1-HUM

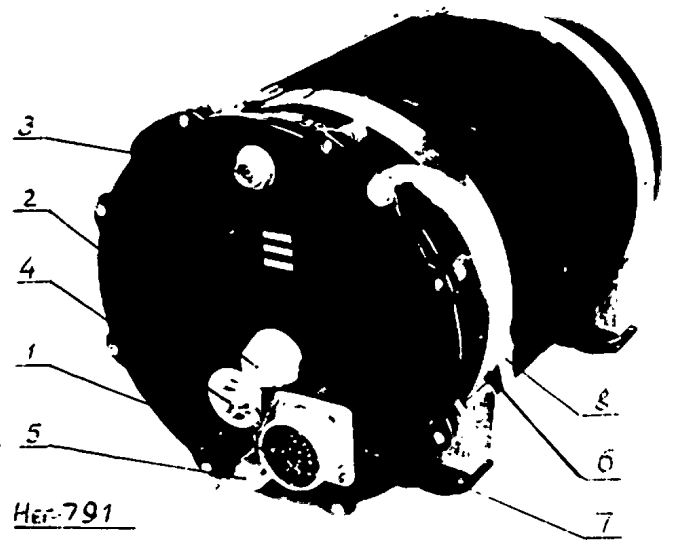

Fig. 62: General view of transmitter-receiver unit

- 1 - 16 pin hermetic junction
- 2 - HF hermetic junction for connection the transmitter-receiver unit with aerial feeder
- 3 - IF amplifier hermetic junction for connection of IF pre-amplifier and IF amplifier
- 4 - Stopper, covering the hole for discharging valve chamber regulation
- 5 - Junction for air supply
- 6 - Fitting rings /belts/
- 7 - Absorbers
- 8 - Earthing bar

S-E-C-R-E-T

NO FOREIGN DISSEM

S-E-C-R-E-T
NO FOREIGN DISSEM

50X1-HUM

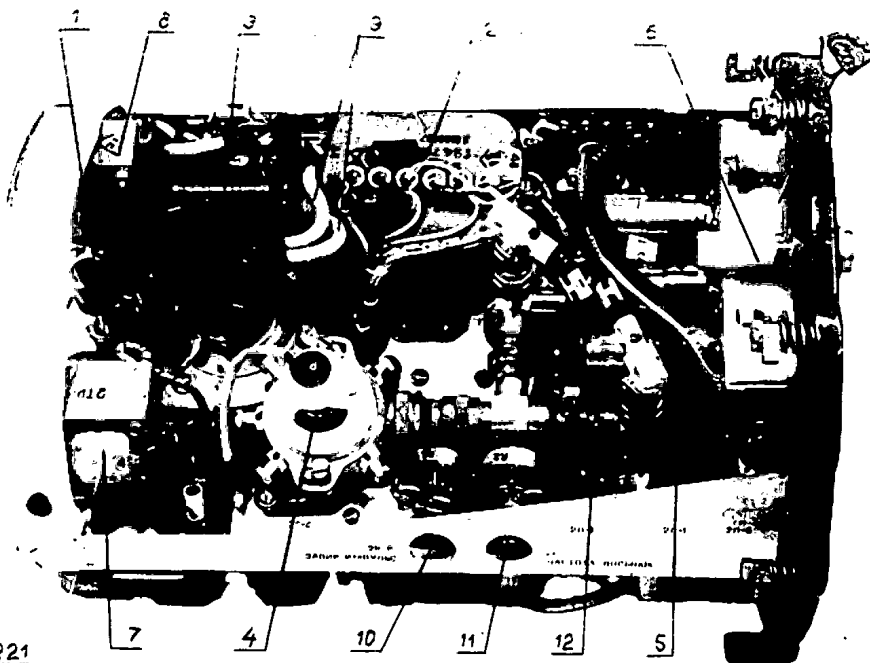

Fig. 63. Top view of transmitter receiver unit.

- 1 - Thyatron TGI - 1 - 35/3
- 2 - Pulse transformer 2Tr-5
- 3 - Forming lines 2LF-1
- 4 - Klystron generator
- 5 - Submodulator valve 6N3P
- 6 - I.F. preamplifier
- 7 - High voltage transformer 2 Tr-1
- 8 - Loading choke 2D1-1
- 9 - Magnetron fillament and cathode connection outlets.
- 10 - Potentiometer 2R-8 for blocking pulse amplitude regulation
- 11 - Potentiometer 2R-2 for frequency pulse repeating regulation
- 12 - Valve 6N1P

114

S-E-C-R-E-T

NO FOREIGN DISSEM

50X1-HUM

On the top of support there are fitted: Thyatron TQI-1-35/3, pulse transformer 2 Tr-5, forming line 2L1-1, klystron generator build on klystron K-12, submodulator valve 6N1P /2V-1/, I.F. preamplifier, HT transformer 2Tr-1, loading choke 2D1-1, potentiometer 2R-8 for blocking pulse amplitude regulation, potentiometer 2R-2 for frequency repeating pulse regulation, gas filled valve GG1-0,012/2,8 /2V-6/, valve 6N1P /2V-15/, receiver mixing chamber, A.C mixing chamber. The top view of unit fitting is shown on Fig. 63.

On the bottom of the support there are fitted: aerial switch chamber with heater, temperature regulator, A.C lable, ventilator motor, HT rectifier condenser, firing rectifier transformer of discharging valve 2Tr-3, magnetron generator, klystron valve socket K-12, kenetron WI-0,03/13, voltage switch 2P-1, blocking switch 2WK-1.

Under the ventilator motor the main concentric line passes, going from magnetron to hermetic junction "antenna" /"aerial"/.

Magnetron generator is displaced in such a way that magnets with oscillating circuit of magnetron are situated on the bottom of unit, but outlets of magnetron heaters and cathode are situated in top part of unit.

The bottom and back views of unit are shown on Fig. 64 and 65.

The transmitter-receiver unit is fixed with two belts with locking devices to the frames with shockabsorbers type "Lord" which are fixed to the aircraft frame.

S-E-C-R-E-T

NO FOREIGN DISSEM

50X1-HUM

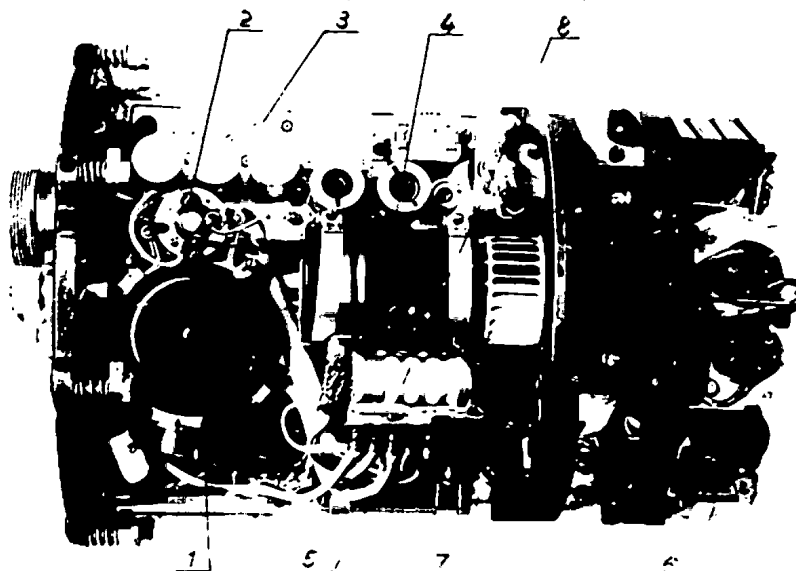

Her 795

Fig. 54. Bottom view of transmitter-receiver unit.

- 1 - Aerial switch with heater
- 2 - Temperature regulator
- 3 - AFC stage
- 4 - Ventilator motor
- 5 - HT rectifier condenser
- 6 - Rectifier transformer of discharging valve firing 2Tr-3
- 7 - Klyatron K-12 valve socket.

315

S-E-C-R-E-T

NO FOREIGN DISSEM

S-E-C-R-E-T
NO FOREIGN DISSEM

50X1-HUM

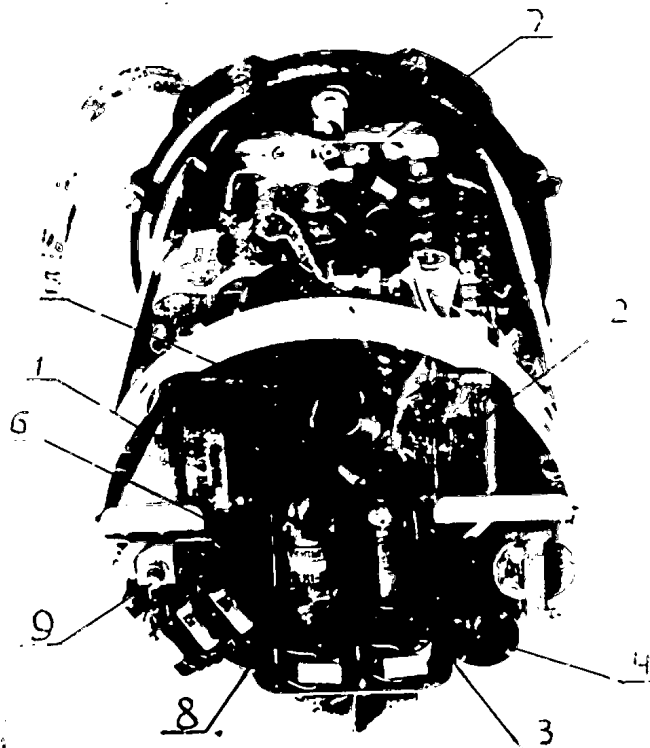

U.S. 855

HEF. 874

Fig. 65. Back view of transmitter-receiver unit without cover.

- 1 - Loading choke 2D1-1
- 2 - HT transformer 2Tr-1
- 3 - Magnetron MI-0,03/13
- 4 - Voltage switch 2P-1
- 5 - Magnetron MI-120
- 6 - Magnetic circuit of magnetron
- 7 - IF preamplifier unit
- 8 - Thyratron TGI-1-35/3
- 9 - Blocking switch

-117-

S-E-C-R-E-T

NO FOREIGN DISSEM

50X1-HUM

V. RANGE UNIT:

Destination of unit.

Range unit serves for:

1. I.F. signals amplification and for transformation them into the video signals.
2. Searching, intercepting and tracing for target, according to distance /range/ 300 - 2000 m, and for voltage generation, proportional to the distance from target, for transferring this voltage to the diopter ASP-4N.
3. Signalisation of target catch on ASP-4N diopter.

The basic part of range unit circuit does the automatic searching and target catching, automatic target tracing and generates the proportional to distance voltage transferred to calculating mechanism of automatic diopter ASP-4N.

In case of no target, a part of unit does the continuous searching in all range area with frequency of 0,5 + 1,5 c/s. In case of reflected from target signal appearance, the searching circuit is switched off and the target tracing circuit starts to work, which generates the voltage proportional to the distance from target. In case of several target appearance in the radiated by radiorange finder area, the circuit, generating the range voltage will catch the nearest target and in range unit output the proportional ^{voltage} to the distance from this target will be fixed up.

During the dismissing or approaching of the target the distance voltage will accordingly ^{decrease} decrease or rise up.

Basic technical characteristics of unit.

1. Searching range 300 m /no more/ to /2000 m /not less/
2. Distance voltage 400 m - 35 V
2000 m - 115 V
3. Maximum error at the distance estimation in the range 300 + 2000 m does not exceed 25 m.
4. Searching frequency 0,5 + 1,5 c/s
5. Separation ability 250 m /not worse/
6. Time of "memory" 3 + 4 sec.

S-E-C-R-E-T

NO FOREIGN DISSEM

S-E-C-R-E-T
NO FOREIGN DISSEM

50X1-HUM

Description of unit work according to block diagram.

The block diagram is shown on Fig. 66.

a/ "Searching" work system.

Negative starting pulse of transmitter-receiver unit switches the speed saw tooth generator built on valves 3V-1 /6N1P/ 3V-2 /6Z3P/. Speed saw tooth generator delivers the saw tooth pulses to comparing diode 3V-3b /6N1P/. Those pulses have 25 μ sec time constant, 145 V amplitude and are synchronized to starting pulses of transmitter-receiver unit. Besides that, the comparator diode receives the saw tooth voltage from slow saw tooth generator 3V-9 /6N1-7/ changed in range 30 + 155 V of 0,5 + 1,5 c/s frequency via 4-5 contacts of relay 3R1-1, amplifier 3V-8 /6Z5P/, slow saw tooth diode limiter 3V-11b and cathode follower 3V-3a. In effect of this the comparator diode circuit generates a positive pulse, the beginning of which, according to probe pulse, is a certain time delayed.

The time of delay will be defined by slow saw tooth voltage value. In this way the amplifier of blocking generator starting 3V-4a /6N1-P/ will receive the pulse, the beginning of which, will be ever more delayed in proportion to transmitter starting pulse as the slow saw tooth voltage will rise up.

This pulse is amplified in starting amplifier and with its positive front part starts blocking generator to work 3V-4b /6N1P/. Blocking generator excites itself and generates "gate" pulse of 14 V amplitude and time constant 0,7 μ sec. This is delivered to coincidence valve 3V-5 /6Z1P/ and to coincidence valve 3V-21 /6Z1P/ via delaying line of 0,5 μ sec. As we can see from Fig. 67 the gate pulses are passing searching range 300 + 2000 m with 0,5 + 1,5 c/s frequency as the slow saw tooth generator voltage is rising up.

Slow saw tooth limitation, relatively to maximum, gives valve 3V-22 /6N1P/. The noise from receiver cathode follower 3V-19b /6N1P/ is fed to automatic gain control /AGC./ circuit for noise, made of valves 3V-20 /6Z2P/, 3V-7 /6N1P/. Noise AGC circuit, relatively to noise values, generates a negative voltage, which via AGC 3V-22b /6N1P/ circuit cathode follower

S-E-C-R-E-T
NO FOREIGN DISSEM

NO FOREIGN DISSEM

50X1-HUM

is fed to IF amplifier keeping the noise level in receiver output on the same level. From speed saw tooth generator circuit there is a negative pulse of 25 μ sec. time constant fed to noise AGC. 3V-20 /622P/ input, which chokes the noise AGC circuit during reception and excludes the target pulse influence on noise AGC.

Windings of relays 3R1-1 and 3R1-2 have no voltage. Contacts 4-5 of relay 3R1-1 are closed and output of slow saw tooth generator 3V-9 is connected to amplifier input 3V-8.

Contacts 5-6 of relay 3R1-2 are open and green lamp target interception in the ASP-4N diometer does not light.

Contacts 1-2 of relay 3R1-2 are closed and to calculating circuits of diometer ASP-4N the constant voltage of + 250 V from divider is applied.

b/ Work for "tracing"

Reflected from target pulses, preamplified in the transmitter-receiver set, are applied to the input of IF amplifier 3V-14, 3V-17 /623P/ Amplified in IF amplifier and detected by second detector 3V-18 /612P/ signal is applied via videoamplifier 3V-19a and cathode follower 3V-19b to coincidence valves 3V-5 and 3V-21 /621P/.

At the mixing of reflected from target pulse with gate pulse, occurs the coincidence valve start to work. From coincidence valves the negative pulse, amplified in preamplifier 3V-10a /6N1P/ and via peak detector is applied to relay valve 3V-11a /6N1P/ Relay 3R1-1 is excited, the contacts 4-5 are getting open, disconnecting the slow saw tooth generator. Contacts 3-2 are getting closed and proportional to distance voltage from cathode follower 3V-3a /6N1P/ is applied to memory circuit 3V-13 /6N1P/. Contacts 11-12 are getting closed and right section of valve 3V-13 gets unblocked and relay 3R1-2 starts to work.

Contacts 5-3 of this relay are getting closed and the green lamp "catching" in the diometer ASP-4N starts to light. Contacts 2-3 are getting closed and proportional to distance voltage is applied ^{via} cathode follower, cathode load 3V-13a to calculating circuits of diometer ASP-4N.

12c

S-E-C-R-E-T

NO FOREIGN DISSEM

NO FOREIGN DISSEM

50X1-HUM

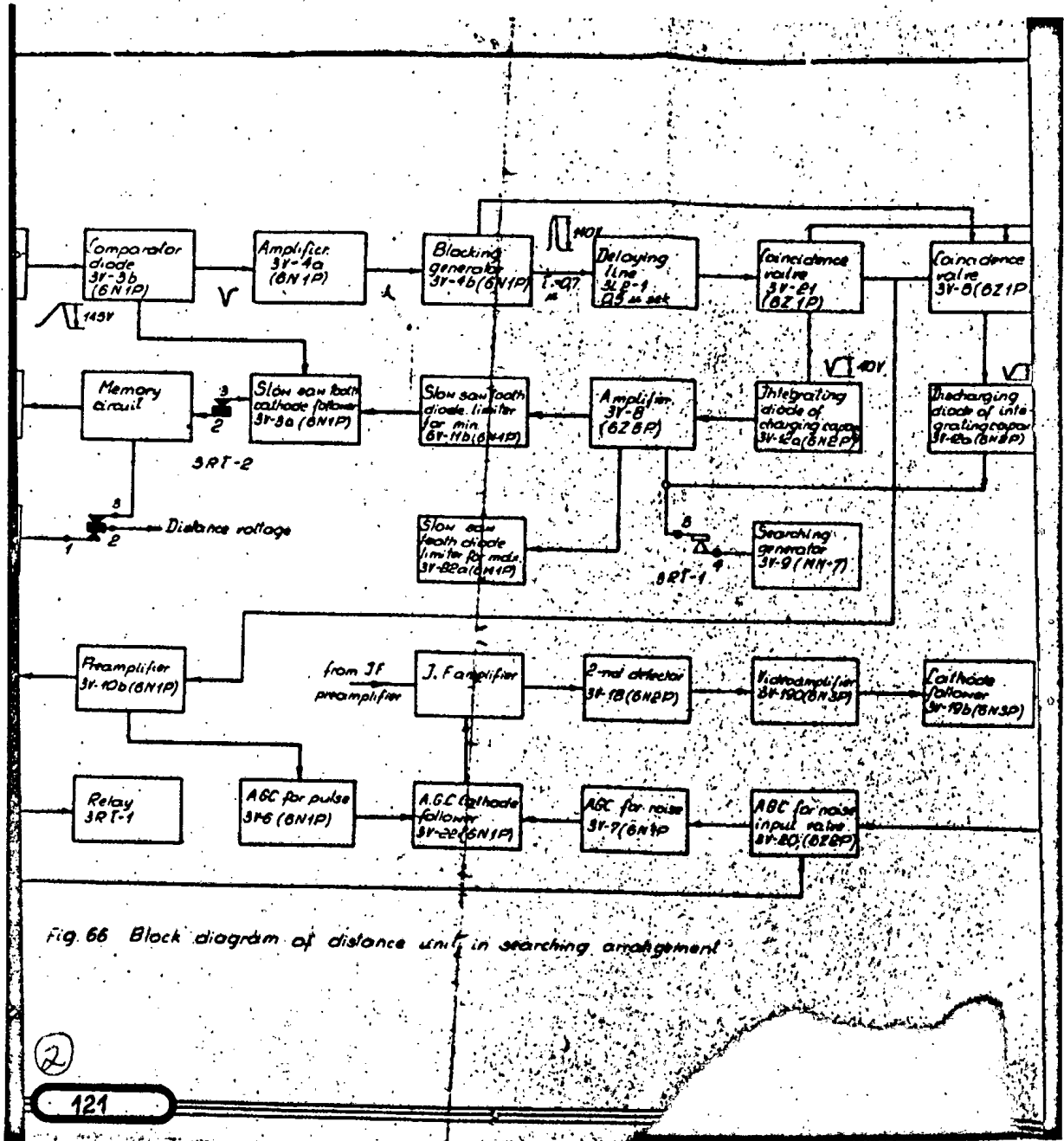

S-E-C-R-E-T

NO FOREIGN DISSEM

50X1-HUM

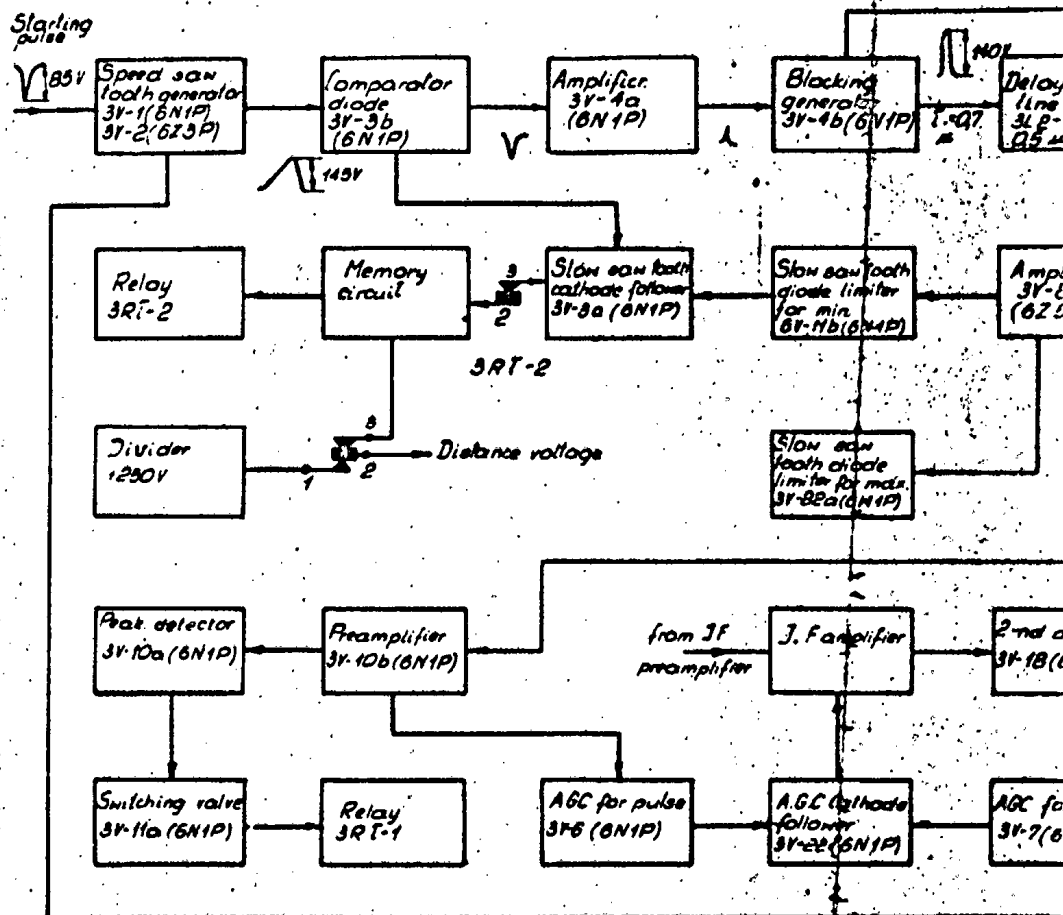

Fig. 66 Block diagram of distance unit in searching mode

(1)

S-E-C-R-E-T
 NO FOREIGN DISSEM

NO FOREIGN DISSEM

50X1-HUM

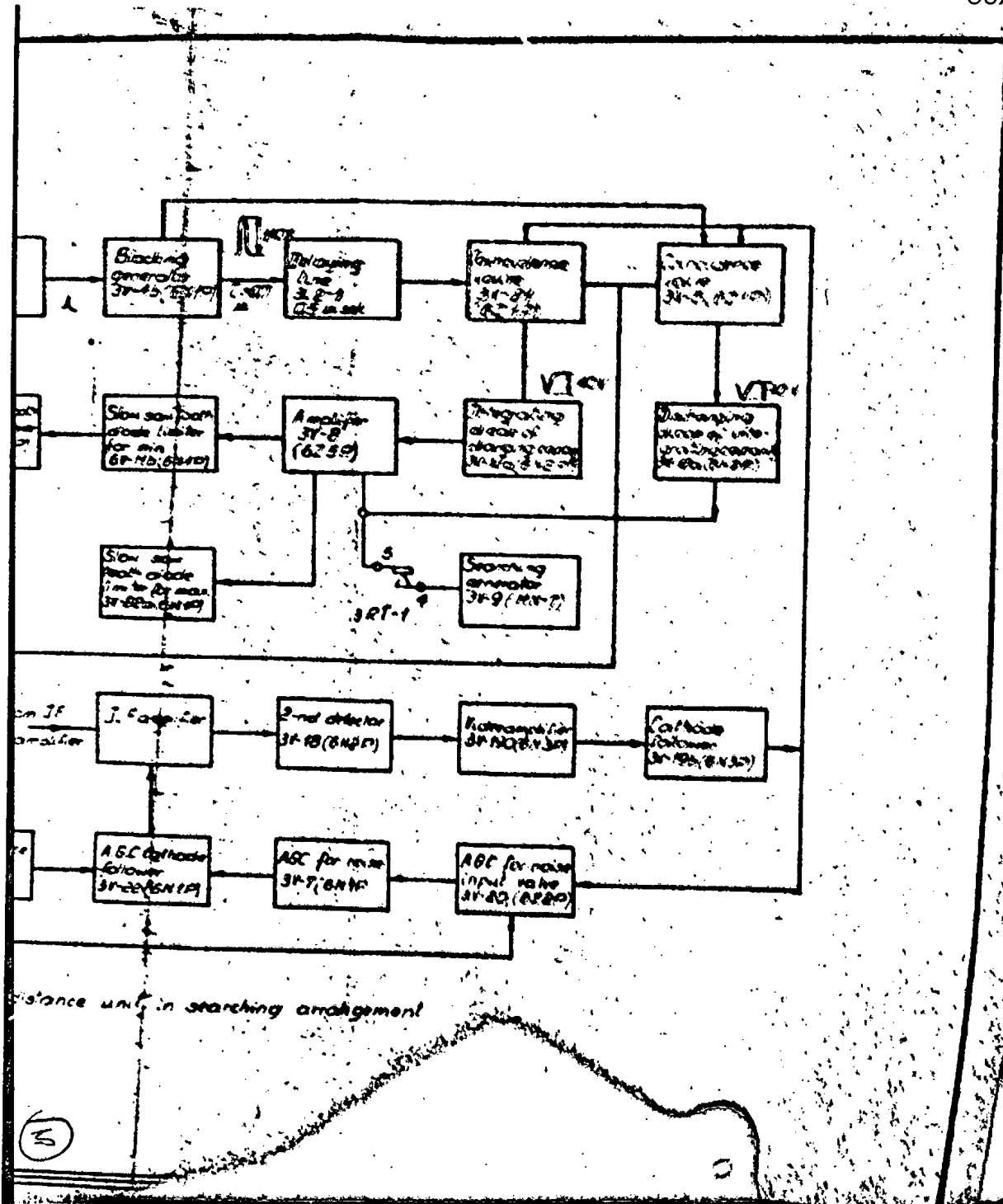

S-E-C-R-E-T

NO FOREIGN DISSEM

50X1-HUM

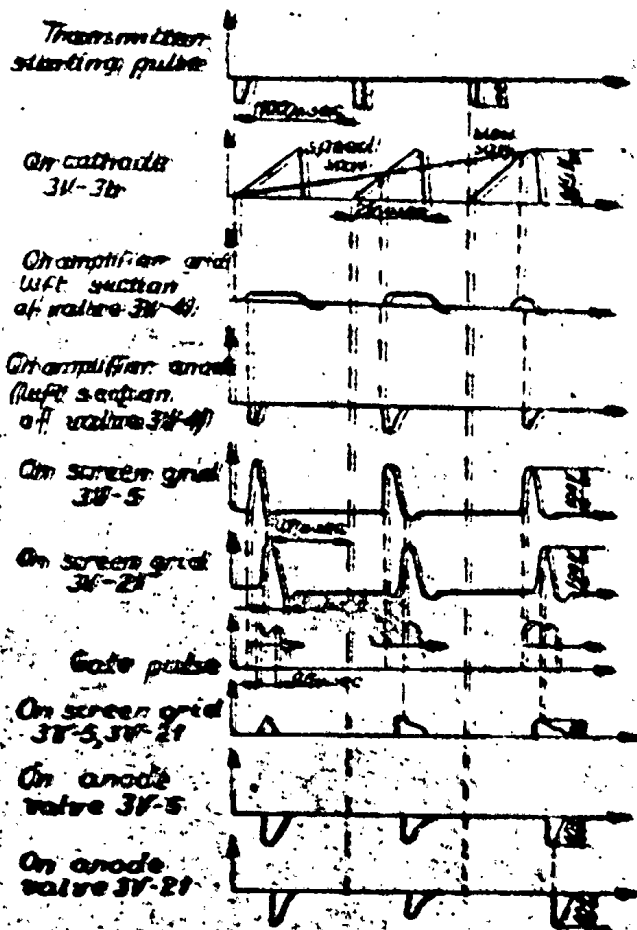

Fig. 67. Oscillogram of gate pulse generation and transferring.

NO FOREIGN DISSEM

50X1-HUM

Unit circuit starts to work for "tracing" and generates the voltage proportional to distance from target.

At slow saw tooth generator switching on, during target interception an integrating capacity C_1 will last the voltage which existed there at the moment of 3R1-1 relay work that is proportional to distance from target.

Integrating capacity C_1 during the work for searching is connected to input of 3V-8 amplifier. Its voltage amplified by this amplifier and cathode follower 3V-3a is applied to comparing diode, instead of slow saw tooth generator voltage, and controls displacement of gate pulses according to distance. During the work for interception from coincidence valve circuits the negative pulses are applied to charging and discharging diodes of integrating capacity: 3V-12a, 3V-13 /6N1P/.

Charging and discharging of integrating capacity C_1 take place. The charging and discharging current of integrating capacity C_1 is in proportion to amplitude and time constant of pulse on coincidence valve anodes. The charging and discharging currents difference of integration capacity, causes on it the voltage change. This voltage change will take place until the current difference will not be equal to zero that means until the reflected pulse will not balance itself between gate pulses.

In this case the voltage on integrating capacity C_1 practically does not change. At the target signal shrinkage relay 3R1-1 releases and repeats "searching" according to distance. But relay 3R1-2 through which contacts acquires distance voltage applying to dioptr ASP-4N. relays with 3-4 sec delay.

Output distance voltage during that delay changes its value according to the same rule and with the same speed as before target abandonment. That makes the "memory" circuit build on valve 3V-13 /6N1P/. As an input signal for pulse AGC. /ARW/ the preamplifier pulse of dividing circuits 3V-10a is used. This pulse is amplified in left section of valve 3V-5 /5N1P/. Then amplified and stretched pulse is detected on diode 3V-5 /right section of valve 5N1P/ and as a negative bias, applied

123

S-E-C-R-E-T

NO FOREIGN DISSEM

50X1-HUM

via cathode follower 3V-22b /6N1P/ to IF amplifier, changing the receiver amplification. This is necessary for preventing the receiver circuits before overloading and for decreasing the error of range estimation to the targets of various intensity.

The work of noise AGC /ARN/ circuits is similar to work for searching and tracing. Pulse AGC /ARN/ noise AGC. have common output to IF amplifier circuits via cathode follower 3V-22b.

Work description of unit according to circuit diagram.

Wiring diagram of range unit is shown on Fig. 54.

1. Speed saw tooth generator.

As the speed saw tooth generator in the range unit the generator of rising up saw tooth voltage generator with positive feed back is used. For speed saw tooth generator the valves 6N1P /3V-1/ and 6Z3P /3V-2/ are used. It is shown on Fig. 58. At the normal state the valve 3V-1b is unblocked because of positive potential on control grid, applied from anode source + 250 V via resistor 3R-2.

On the anode of valve 3V-1b the voltage of 5V will be fixed up and the condensers 3C-3 and 3C-4 will be charged to this potential.

The low voltage on the anode 3V-1b we can explain by positive voltage on grid and because of that big anode current which causes big voltage drop on anode load resistors 3R-2, 3R-3 and 3R-4. In normal working conditions on the cathode of 3V-1a the negative starting pulse of 85 V amplitude is applied which unblocks this valve.

The capacitor 3C-1 is then charged by capacitor 3C-66 and inner resistance of valve 3V-1a to the starting pulse amplitude value, and in effect, the valve 3V-1b is blocked but capacitors 3C-3 and 3C-4 are getting charged from + 250V source via 3R-8, 3R-9, 3R-4, 3R-3, 3C-4 and negative terminal of source.

The capacity charging from the source of constant /electromotive force/ occurs, as we know according to

124

S-E-C-R-E-T

NO FOREIGN DISSEM

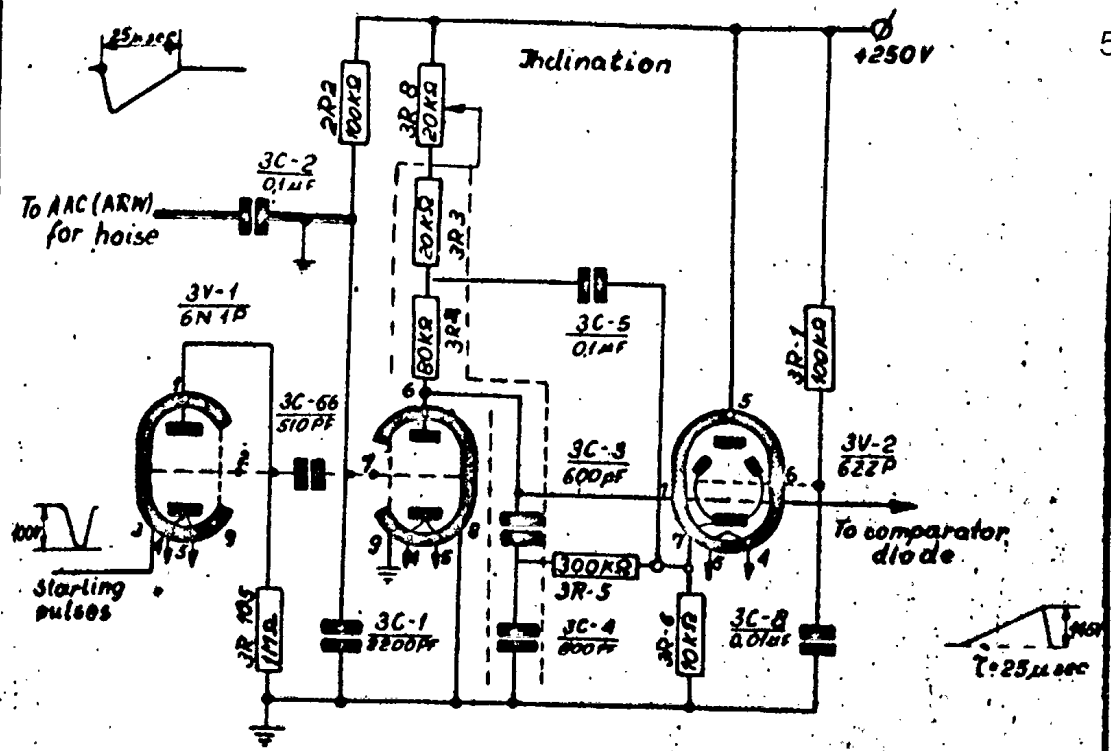

50X1-HUM

Remark:

Condensers and resistors led about by dotted line are fitted in the thermobox 3 Th-1.

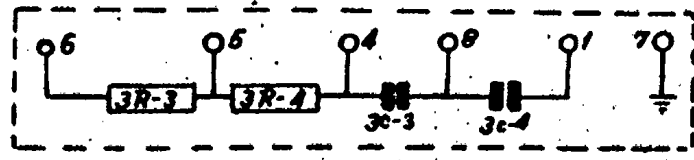

Fig. 68. Diagram of speed saw tooth generator.

50X1-HUM

exponential curve and can be expressed by the equation

$$U_c = U_{c_0} + \frac{1}{C_0} \int_0^t i / t \cdot dt.$$

To obtain direct proportional dependance between the distance voltage and a distance from target, there is necessary the saw tooth voltage of linear change.

Linearity of voltage change on the condenser, we can obtain by the term of charging current stability.

From the above equation we cause that at charging current stability, that is with $i / t = i_0 = \text{const.}$ the voltage on the capacity will have linear change.

In this case

$$U_c = U_0 + \frac{I}{C} t$$

where: U_c - voltage on capacity

U_0 - primary voltage on capacity

I - charging current

C - capacity of condenser

t - time

To obtain the constant charging current in the speed saw tooth generator, the so called cathode tracing stage is applied with valve 3V-2 / 5-3P/ which establishes positive feedback. This positive feedback keeps constant potential difference on ends of resistor 3R-4, which causes stability of current flowing through this resistor.

The cathode tracing stage represents an ordinary cathode follower, on grid of which the voltage from anode 3V-1b is applied and from cathode, the voltage change, through capacity 3C-5 of feedback is applied on the other end of resistor 3R-4.

The capacitor 3C-5 is specially selected many times bigger than condensers 3C-3 and 3C-4 because the voltage drop on resistor 3R-4 should not depend on voltage change on capacitor 3C-5 during speed saw tooth rising up. The load of big condenser will be not noticeable in short time. But because

50X1-HUM

the cathode follower transferring factor is always smaller than 1, and the voltage on capacitor 3C-5 is not constant, during the speed saw tooth rising up, the charging current of condensers 3C-3 and 3C-4 is also not constant. To compensate this instability of charging current, and to improve the saw tooth voltage linearity, the integrating circuit 3R-5, 3C-4 is used, which has following destination.

Because the cathode potential of cathode follower is almost twice bigger than the potential in point of condensers 3C-3 and 3C-4 connection, therefore via resistor 3R-5 flows the charging current of condenser 3C-4. Every voltage increase on this condenser will additionally increase the voltage on the grid of cathode follower 3V-2 and by that will additionally increase the speed saw tooth voltage.

Saw tooth voltages curves are shown on Fig. 69.

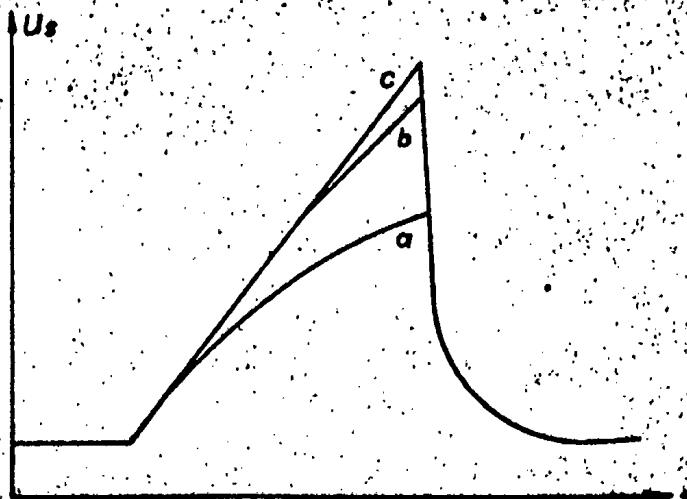

Fig. 69.

- a/ exponential condenser charging
- b/ Speed saw tooth generator output voltage with cathode-tracing stage but without integrating circuit 3R-5, 3C-4.
- c/ The same after integrating circuit 3R-5, 3C-4 amplification.

50X1-HUM

Saw tooth voltage rising up will take place until valve 3V-1b will be not unblocked. The time of unblocking is estimated by condenser 3C-1 discharging time constant, which gets discharged via: Condenser 3C-1, + 250 V supply source inner resistance, resistor 3R-2. The time constant is so selected, that the voltage on condenser 3C-1 obtains the necessary voltage for valve 3V-1b unblocking after 25 μ sec. from the time of starting pulse coming.

During the time of valve 3V-1b unblocking, the condensers 3C-3 and 3C-4 will get discharged through the inner resistance of this valve.

In 25 μ sec. lineally, rising voltage obtains the value of 140 V. The value of speed saw tooth amplitude is controlled by 3R-3 potentiometer / "nachylene" / /inclination/ fitted on the front panel of the range unit. The output voltage of speed saw tooth generator, from cathode follower 3V-2 grid, is applied on anode of comparator diode 3V-3b.

3R-7 is a extinguish resistor in screen grid circuit of valve 3V-2, 3C-8 is as a blocking condenser.

With speed saw tooth generation the negative pulse from 3C-1 via condenser 3C-2 to ABC /ARW/ for noise is applied and blocks it for 25 μ sec.

2. Slow saw tooth generator.

Slow saw tooth generator or "searching" generator is destinated for slowly rising up saw tooth voltage during the work for searching. The frequency of this voltage is 0,5 + 1,5 c/s.

The diagram of "searching" generator made with neon valve type NN-7 /3V-9/ is shown on Fig. 7C.

The work of this generator is as follows:

At the time of switching the supply voltage on, the condenser 3C-15 starts to get charged from negative voltage source - 150V via resistor 3R-30, which estimates condenser 3C-15 charging time constant.

The time constant of condenser 3C-15 charging is selected in such a way, that the slow saw tooth oscillations frequency must be 0,5 + 1,5 c/s.

NO FOREIGN DISSEM

50X1-HUM

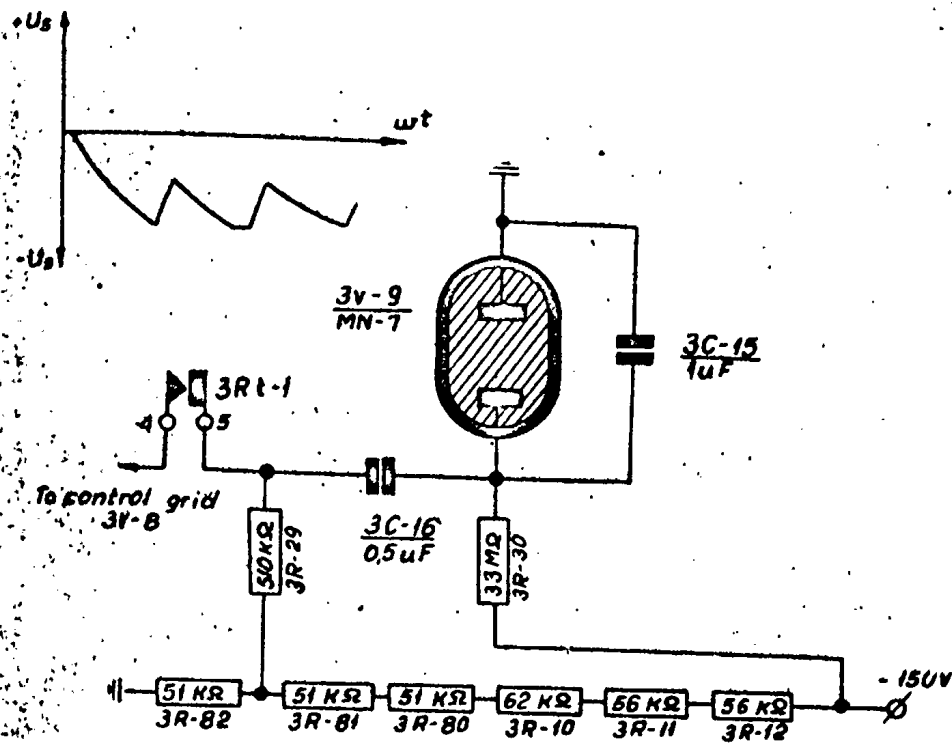

Fig. 70. Slow saw tooth generator-circuit diagram.

When the voltage on condenser 3C-15 obtains the value necessary for neon valve firing, the valve loses its inner resistivity and the condenser quickly gets discharged through its inner resistance.

Alternating with frequency of $0,5 + 1,5$ c/s saw tooth voltage is applied via condenser 3C-1b and contacts 4-5 of relay 3R-1 to the control grid of valve 3V-9.

During the searching work contacts 4-5 of relay 3R-1 are closed. Slow saw tooth generator is connected to control grid of amplifier /valve 3V-8/ and to integrating condenser C_1 . Amplified in valve 3V-8 slow saw tooth voltage is applied via slow saw tooth diode limiter /3V-11/ and cathode follower /3V-3a/ to the cathode of comparing diode /3V-3b/. This voltage estimates the time of unblocking the diode with speed

129

S-E-C-R-E-T

NO FOREIGN DISSEM

NO FOREIGN DISSEM

50X1-HUM

saw tooth voltage, what also estimates the delay of gate pulse forming start.

The slow saw tooth voltage, by its own rising up, causes always rising delay of gate pulse forming, according to probing pulse of transmitter. Due to this action the gate pulses are shifted in time.

During decreasing of slow saw tooth voltage, the gate pulses are quickly returning to the previous state and after, according to slow saw tooth voltage rise, start again to get maximum.

In this way slow saw tooth voltages are forcing the gate pulse to move for target searching, which is in the distance of 2000 m from aircraft. At the time of target interception the relay 3R-1 starts to work and contacts 4-5 are open, disconnecting the "searching" generator from control grid of valve 3V-2. Radiorange finder changes its work from "searching" to "tracing" target.

Resistor 3R-29 is a grid leak resistor for amplifying valve 3V-3.

3. Diode comparator.

Comparator diode serves to produce the certain delay during starting pulse of gate pulse generator.

The delay in time is estimated with regard to the probe pulse. Comparator diode circuit is made with one section of valve type 6N1P /3V-3b/ and shown on Fig. 71.

The delay in time is obtained practically by comparing two voltages: slow saw tooth voltage, applied to cathode of diode 3V-3b and speed saw tooth voltage applied to anode of this diode.

Diode 3V-3b will get unblocked only when the voltage on its anode will be equal to the voltage on its cathode.

From this time the current passing through the diode will cause the voltage drop on resistor 3R-14 in shape of limited pulse from the bottom of speed saw tooth /see Fig. 72/.

This saw tooth pulse is applied to difference circuit, consisting of capacitor 3C-7 and resistance grid-cathode of

S-E-C-R-E-T

NO FOREIGN DISSEM

NO FOREIGN DISSEM

50X1-HUM

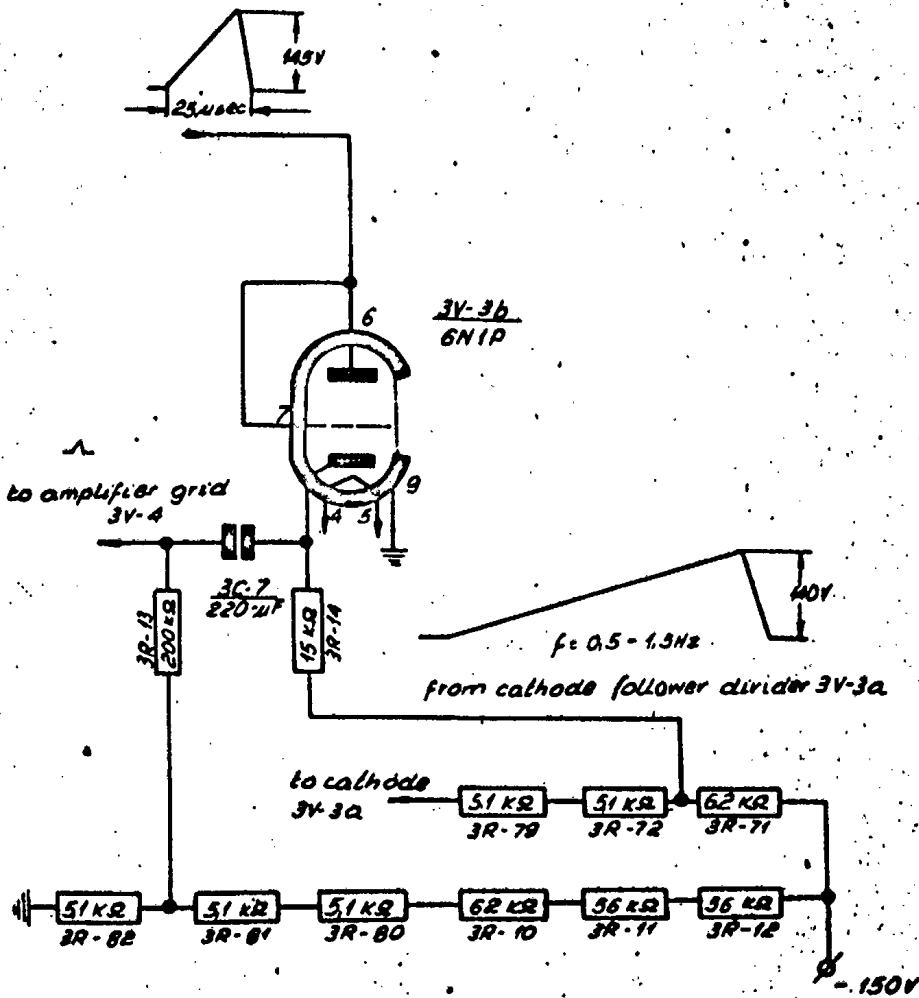

Fig. 71. Comparator diode circuit diagram.

S-E-C-R-E-T

NO FOREIGN DISSEM

50X1-HUM

blocking generator starting amplifier valve.

Differentiated pulse starts, with its front part, gate pulse generator. In this way we can see, that the start point of gate pulse generator, estimated by comparator diode unblocking time, will be delayed with regard to probing pulse for certain time Δt / see Fig. 72/

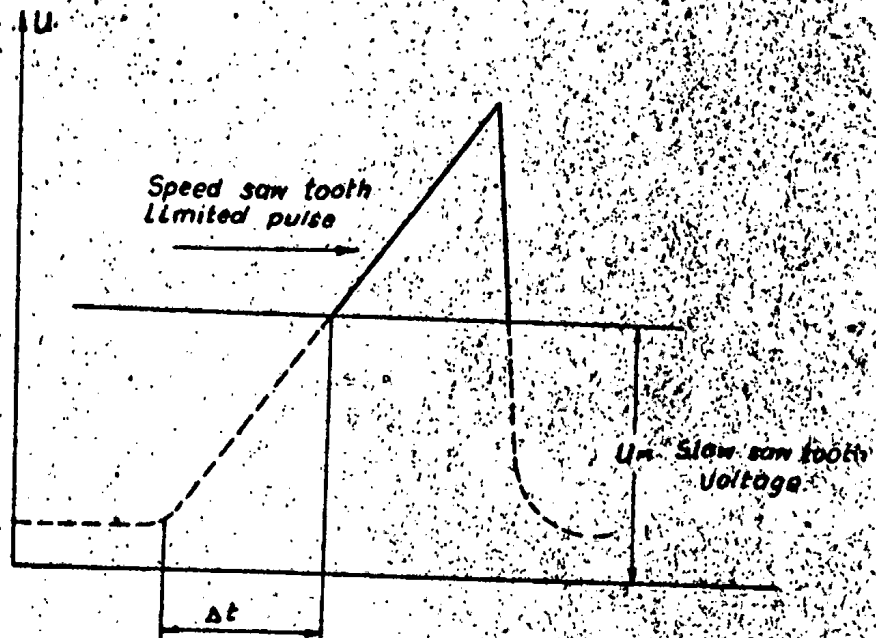

Fig. 72. Limiting character of speed saw tooth pulse.

As it is seen from the figure this delay time is estimated by voltage value on cathode of comparator diode. At the work for searching, this voltage changes itself slowly from 30 V to 140 V with frequency 0,5 r 1,5 c/s. At the work for interception, voltages on cathode of valve 3V-3b are controlled by integrator circuit, and according to dismissing or approaching of the target, these voltage will increase or decrease. This will change the limiting level of speed saw and by that, the time of delay gate pulse forming beginning.

The working idea of differential circuit 3C7 and 3C8, shown on Fig. 73 we can explain in the following way.

NO FOREIGN DISSEM

50X1-HUM

78 - Valve 3V-4a-grid-cathode inner resistance/
 Applying the positive saw tooth pulse to the circuit input
 in this circuit, will pass condenser 3C-7 charging current.

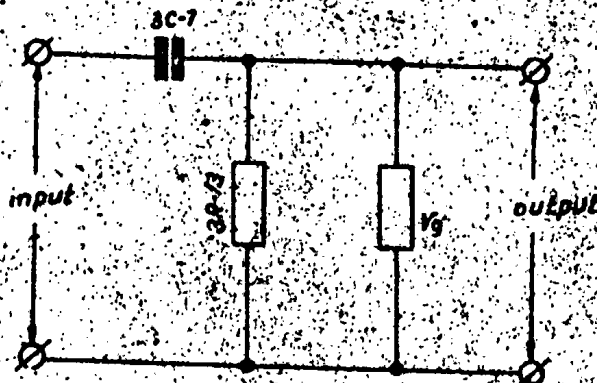

Fig. 73. Substitute diagram of differential circuit.

At the zero potential on starting amplifier, the grid current will appear. The constant part of this current will cause the voltage drop on resistor 3R-13.

Normal condenser charging, due to applied constant voltage, performs according to exponentially decreasing current.

Because in this case the applied voltage is not constant but linearly rising up, therefore the current in circuit will last more or less constant. The process that takes place in differential circuit, we can compare to reverse process of speed saw tooth arising. When, for obtaining the linear saw tooth voltage the stability of charging current was necessary, then, in given case, we obtaining the constant current due to circuit input application of voltage linearly changing itself.

Beside the voltage growth in input is compensated by the voltage growth on capacity 3C-7. Because the current in the circuit is constant, also the voltage drop on resistor 3R-13 will last constant, and the voltage in differential circuit output will be very near to square shaped.

At the moment of speed saw tooth pulse finishing, condenser 3C-7 starts to discharge itself via left plate of condenser 3C-7, resistor 3R-14, 3R-71; inner resistance of -150 V supply source, earth, resistors 3R-82, 3R-13 and right plate of condenser 3C-7. On resistor 3R-13 appears then negative

133

S-E-C-R-E-T

NO FOREIGN DISSEM

50X1-HUM

exponentially decreasing voltage pulse.
The voltage curve in differential circuit output is shown on Fig. 74

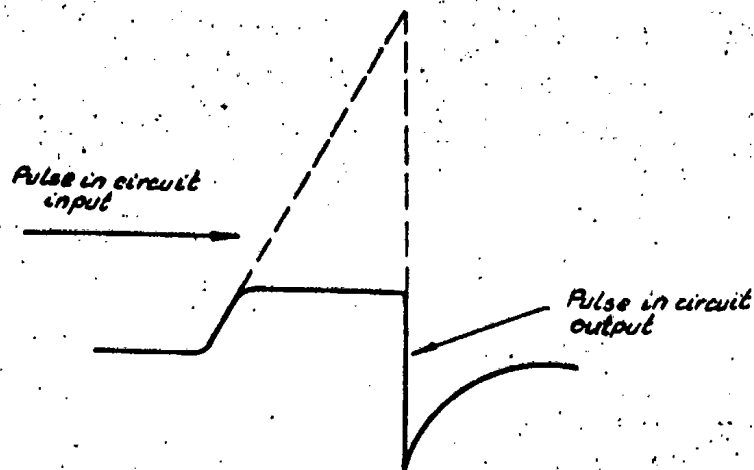

Fig. 74. Voltage change character in differential circuit output.

4. Gate pulse generator.

Gate pulse generator is an ordinary blocking generator with starting amplifier build with valve 3V-4 /6N1P/

Circuit diagram of this generator is shown on Fig. 75. With the left section of valve 3V-4 there is the starting amplifier build, and with the right section the "awaiting" blocking generator. Pulse transformer 3Tr-1 is used as an anode load for both valves.

To the control grid of starting amplifier via resistor 3R-15 the - 4.5 V negative bias is applied from - 150 V voltage divider, which consists of resistors 3R-10, 3R-11, 3R-12, 3R-80, 3R-81, 3R-82.

S-E-C-R-E-T

NO FOREIGN DISSEM

NO FOREIGN DISSEM

50X1-HUM

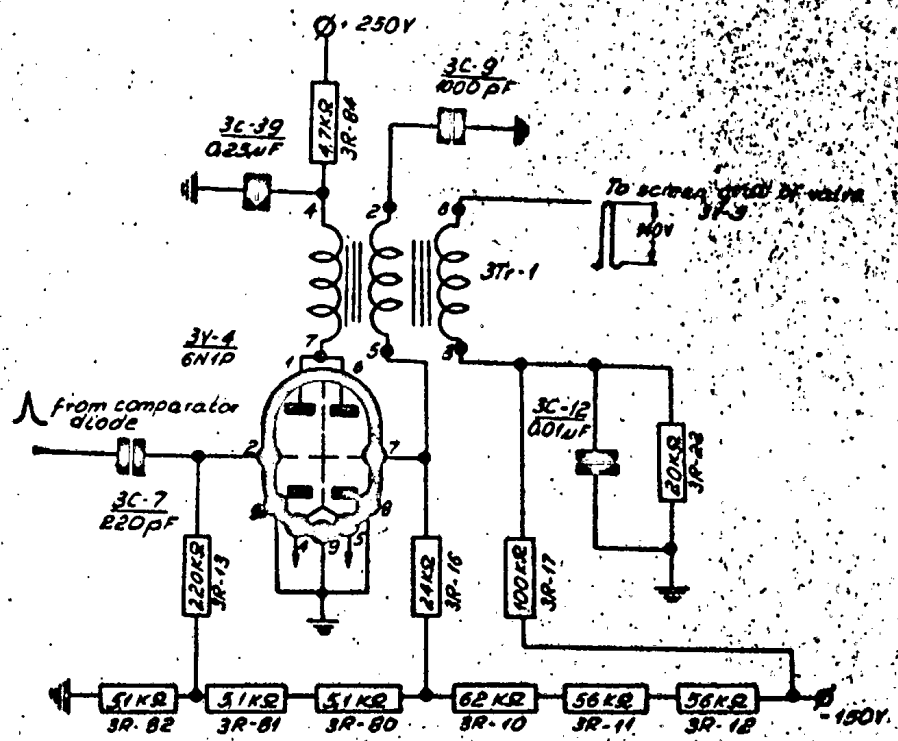

Fig. 75. Circuit diagram of gate pulse generator.

S-E-C-R-E-T
NO FOREIGN DISSEM

NO FOREIGN DISSEM

50X1-HUM

From this divider - 14V negative voltage via resistor 3R-16 is applied to the control grid of blocking generator valve, which is blocking the valve.

Such a blocked, in normal state, generator is called "awaiting" it means, that it can be put to work only by an outside pulse /externally excited/.

The action of gate pulse generation occurs in following manner. To the starting amplifier grid the square pulse is applied from differential circuit output. The front part of this pulse corresponds to the beginning of, limited from the bottom, speed saw tooth pulse triangle.

This square pulse with its front part unblocks the amplifier valve /left section of valve 3V-4/. The passing through the valve current causes the voltage drop on common anode load.

In effect of this in the secondary /grid/ winding appears the positive rising up voltage, which unblocks blocking generator valve. Appearing then anode current of this valve will make additional voltage drop in primary winding of pulse transformer what then causes the voltage growth in the secondary winding, what means voltage increase on grid. That again will cause anode current increase.

This process of voltage increasing on grid and anode current increasing take place very quickly and is known as straight blocking process /avalanche process/.

The inclination "S" of the front part of pulse, determined as a proportion of pulse amplitude to time constant of its front part is very big:

$$S = \frac{U}{t}$$

where: U - pulse amplitude

t - time constant of its front part

For example with U = 140 V and t = 0,035 μsec S will be:

$$S = \frac{140}{0,035 \cdot 10^{-6}} = 4 \cdot 10^5 \text{ V/sec.}$$

S-E-C-R-E-T

NO FOREIGN DISSEM

NO FOREIGN DISSEM

50X1-HUM

In effect of finish straight blocking process the anode voltage will fall down nearly to zero because of voltage drop on primary winding of pulse transformer.

The grid voltage will extremely increase and become positive because of produced EMF.

When the grid voltage reaches zero value appears the grid current and condenser 3C-9 will start quickly to get charged according to exponential curve with time constant.

$$T = C \cdot \int g$$

where: T - charging time constant

C - capacity of condenser 3C-9

$\int g$ - Grid-cathode inner resistance of blocking generator valve.

The resistance of secondary winding, which is also in the 3C-9 charging circuit we can omit, as it is very small. Anode current accretion of valve can not last for ever because at end of straight blocking process due to low anode voltage and high grid voltage the anode current is limited by valve current saturation.

Valve working point is shifted on valve characteristic to the range of small inclination.

From time of grid currents appearance the negative voltage on condenser 3C-9 starts to increase, decreasing the positive grid voltage. Because the voltage in secondary winding increases further up to the end of straight blocking generator process the result voltage on grid will still get increased. But when the straight blocking process is ended, the grid voltage will start slowly decrease, because of still proceeding the condenser 3C-9 charging. The anode current then also slowly decreases, because the valve works at this time in characteristic range of small inclination.

In this time the flat part of pulse is formed.

As the voltage gets decreased the valve working point is slowly shifted into the valve characteristic range of big inclination. Grid voltage decreasing causes remarkable anode current decreasing, that in turn causes remarkable voltage drop in primary and secondary pulse transformer windings. The speed of grid

S-E-C-R-E-T

NO FOREIGN DISSEM

S-E-C-R-E-T
NO FOREIGN DISSEM

50X1-HUM

voltage decrease grows up what hastenes the working point shifting into the valve characteristic range of big inclination.

This in turn causes quick anode current decrease. This process is also avalanche and is called reverse blocking process. In effect of this the grid voltage rapidly becomes negative and the valve gets blocked.

When the valve is blocked, in pulse transformer windings appear the negative pulses of big EMF value.

After the valve is blocked, condenser 3C-9 starts to discharge in the circuit of: right plate of condenser 3C-9, ground resistors 3R-82, 3R-81, 3R-80, 3R-16, secondary winding of pulse transformer and left plate of condenser 3C-9 and till the next starting pulse comes, the voltage on condenser 3C-9 and also on blocking generator grid will be equal to the voltage taken from divider 3R-12, 3R-11, 3R-10, 3R-80, 3R-81, 3R-82.

Positive gate pulse of 140 V amplitude taken from this pulse transformer winding is applied to the screen grid of valve 3V-5 and via delaying line 3Lz-1 of 0,5 μ sec delay is applied to the screen grid of valve 3V-21.

Condenser 3C-31 and resistor 3R-84, connected into the anode circuit of gate pulse generator, make the decoupling circuit, which makes the blocking generator work more stable.

5. Coincidence stages.

Coincidence stages are build with valves 3V-5, 3V-21 and shown on figure 76.

In normal state the valves are blocked by negative bias - 25 V, on screen grids from voltage divider 3R-22, 3R-17; cathode bias of valve 3V-5 from divider 3R-16, 3R-33; + 2V bias of valve 3V-21 from divider 3R-23, 3R-90.

The cathode bias of valve 3V-5 is controlled by potentiometer 3R-33 in range from + 0,5 V to + 6 V., what is necessary to keep equal currents of valves 3V-5 and 3V-21. Those valve currents are not equal due to different declination of characteristics. When the unit is working, the screen grid the gate pulses are applied. To the screen grid of valve

S-E-C-R-E-T

NO FOREIGN DISSEM

NO FOREIGN DISSEM

50X1-HUM

3V-5 these pulses are applied directly, but to the screen grid of valve 2V-21 via delaying line 3L2-1 with the delay of 0,5 μ sec. Applied gate pulses make the screen grids unblock but the valves are still blocked for anode current by positive bias on cathodes.

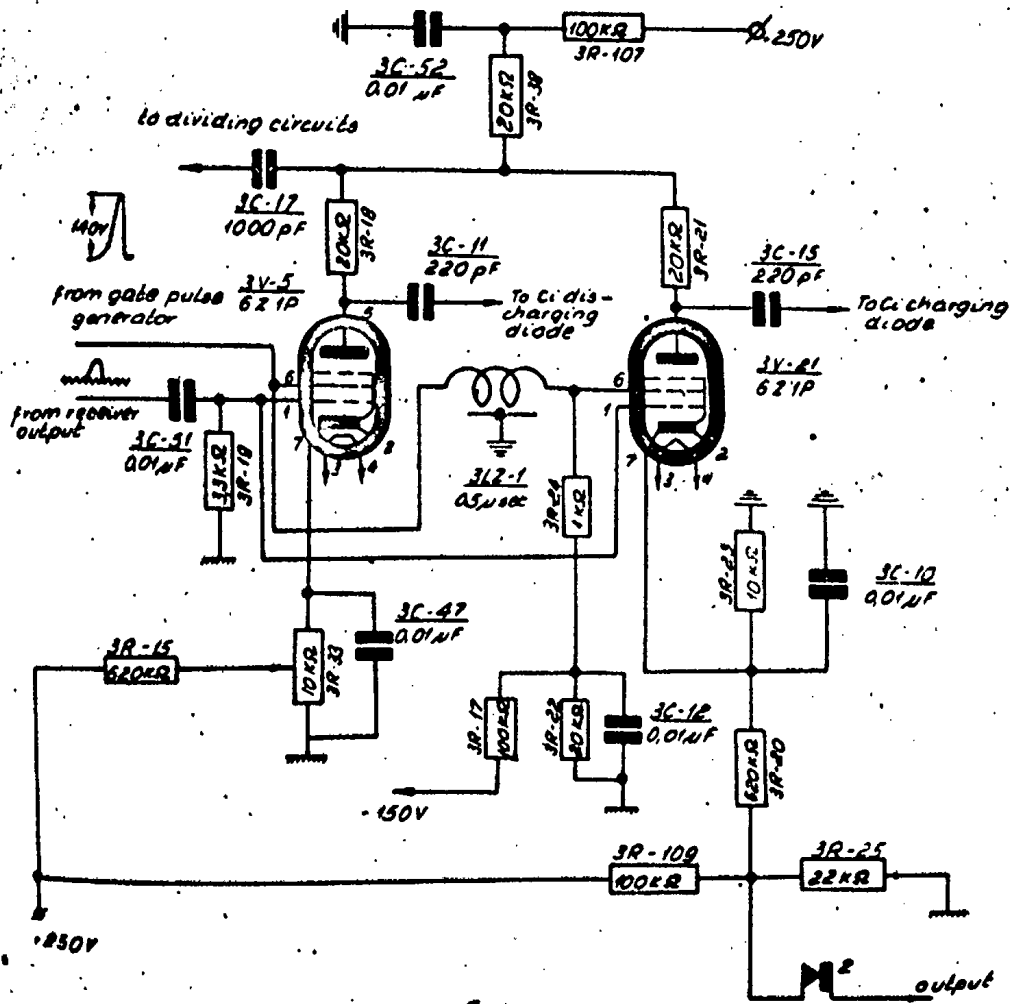

Fig. 76. Firing diagram of coincidence stages.

S-E-C-R-E-T
NO FOREIGN DISSEM

NO FOREIGN DISSEM

50X1-HUM

The blocked state will last until the valves control grids will receive the reflected from target pulse from receiver output.

When the reflected from target pulse will come at the same time as the gate pulse, the valves will get unblocked for anode current. At the same time, the negative pulses will approach on anodes which control the action of integrating capacity charging and discharging diodes. From resistor 3R-3S, which is a common anode load for coincidence valves, the negative pulse is taken and via condenser 3C-17 applied to the control grid of dividing circuits amplifier - /valve 3V-10a/.

When the distance from target will get changed, then the reflected pulse is symmetrically placed between gate pulses and a moderate voltage value on integrating capacity C_1 at the repeating, of process will last unchanged, and the distance voltage will change neither. At the dismissing from target, the reflected pulse will be more covered with second gate pulse and the negative pulse on 3R-21 anode load of valve 3V-21 will rise up, but on 3R-18 anode load of valve 3V-5 will decrease. It causes that the integrating capacity C_1 will get charged more than discharged during the target pulses coming. The growth of voltage on C_1 is transferred via valves 3V-9, 3V-11a, 3V-3a to the coincidence diode cathode and causes the gate pulses shifting towards far targets. At the decreasing of distance from target, the reflected pulse will be more covered with first gate pulse, and the pulse on anode of valve 3V-5 will rise up, but on anode of valve 3V-21 decreases itself that brings to discharge of integrating capacity C_1 . Voltage decreasing on C_1 is applied to the cathode of coincidence diode /3V-3b/ and causes the gate pulse shifting towards small distances /ranges/.

When the speed of target distance change is bigger, also the shift of reflected from target pulse is bigger, to the state of balance between gate pulses.

The value of this shift estimates dynamical error. Resistor 3R-24 serves, for delaying line 3Lx-1 matching. Resistor 3R-11 is a control grid leak resistor for coincidence

S-E-C-R-E-T

NO FOREIGN DISSEM

NO FOREIGN DISSEM

50X1-HUM

valves. Circuit 3R-107 and 3C-52 creates the decoupling filter in the coincidence valves supply circuit and secures stability of valves work.

6. Dividing circuits.

The distance /range/ unit switching from searching to training is done ^{by} dividing circuits shown on Fig. 77.

The negative pulse taken from common anode load of coincidence valves 3R-38 is applied via condenser 3C-17 to the amplifier grid, build with left section of valve 3V-10a. From resistor 3R-35, which is an anode load of valve 3V-10a, amplified pulse is applied via condenser 3C-18 to the pik-detector grid, made with right section of valve 3V-10b. During the work for searching, the valve 3V-10b is blocked by negative bias, brought from resistor 6R-1 and valve 3V-11b by bias voltage, brought from resistor 3R-41.

When the positive pulse is applied to the grid of pik-detector /valve 3V-10b/ the valve gets unblocked, and the passing current charges then the condenser 3C-19a via: + 250V, inner resistance of valve 3V-10b, condenser 3C-19a, ground /that is - minus of supply source/.

Because the time constant of circuit charging is small. /small inner resistance of valve at the time a current passing/, the condenser 3C-19a will get charged to its maximum value in time of pulse. That is why the grid of valve 3V-11a will have the positive potential, and valve will be unblocked.

The anode current, passing through the winding of relay 3R-1, will cause its activity. During the time between pulses the condenser 3C-19a starts to discharge in two circuits: first - top plate of condenser 29-19a, resistors 3R-31, 3R-41, ground and bottom plate of condenser 3C-19a; second - to plate of condenser 3C-19a, resistor 3R-36, 6R-1, - 15 V, ground, and bottom plate of condenser 3C-19a.

Because the discharging time constant is several times bigger than charging time constant /big value of above mentioned resistors/ so till the next pulse from anodes of coincidence valves coming, this condenser 3C-19a will get very little. Every next pulse charges again the condenser 3C-19a.

S-E-C-R-E-T

NO FOREIGN DISSEM

50X1-HUM

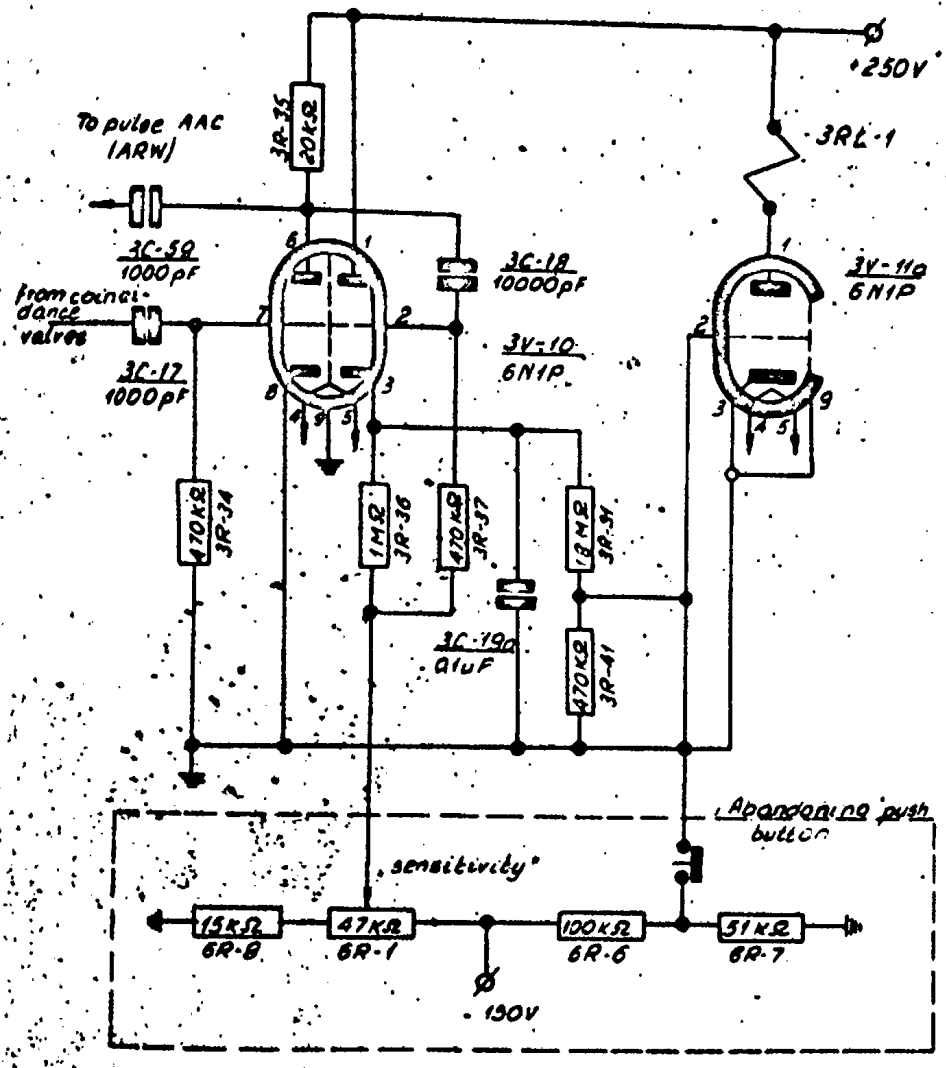

Fig. 77. Dividing circuits diagram.

S-E-C-R-E-T
NO FOREIGN DISSEM

50X1-HUM

to its maximum, keeping the positive potential on the grid valve 3V-11a, what means, that the relay 3R1-1 will be active all the time. During the activity of relay 3R1-1 the contacts 4-5 are open and slow saw tooth generator is disconnected from grid of amplifier 3V-8; Contacts 1-2 are also open but contacts 2-3 are closed, connecting grid of cathode follower 3V-13a to cathode 3V-3a from which, proportional to distance from target, voltage is taken; Contacts 11-12 are closed and connect the grid of 3V613b via resistor 3R-112 to the ground, increasing the grid potential to the value, at which the valve 3V-13b is unblocked and relay 3R1-2 forced to work.

The contacts of relays 3R1-2 are shown on Fig. 78.

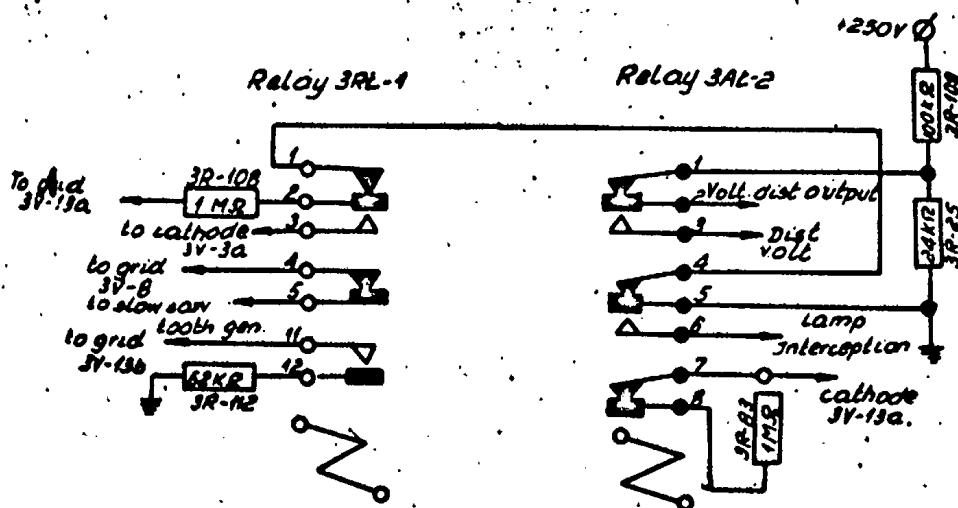

Fig. 78. Contacts of relays 3R1-1 and 3R1-2.

During the activity of relay 3R1-2 the following contacts are connected: Contacts 4-5 are disconnected and contacts 5-6 closed, switching the signalling lamp "interception" in ASP-4N dioster. Contacts 1-2 are open, but 2-3 closed.

S-E-C-R-E-T
NO FOREIGN DISSEM

50X1-HUM

At that time the "distance /range/ voltage is applied to 3V-4N diode from cathode of valves 3V-13a. Contacts 7-8 of relay 3R-2 are open, switching into the "memory" circuit the resistor 3R-3.

7. Integrating capacity charging and discharging diodes.

For integrating capacity C_1 charging and discharging diodes circuit work explanation, and also the work of integrator itself, the idea of integrating capacity should be understood.

That is why, before charging and discharging diodes circuit work consideration, we shall consider about integrating capacity.

In integrator circuit (see Fig. 76) the capacity 3C-14 is connected between the grid of 3V-3 and cathode of 3V-3a. As it was stated before, the cathode voltage of 3V-3a is controlled in phase with anode voltage of 3V-3 and that is why capacity 3C-14 is connected between the anode and control grid of 3V-3, that is shown on Fig. 76.

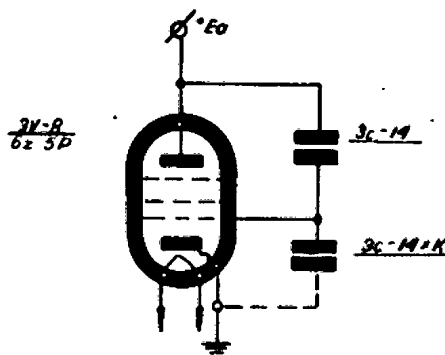

Fig. 76.

Mathematically we can prove, that the connection of capacity between grid and anode of the valve is equal to the connection of "N" times higher capacity between grid and cathode of this valve.

S-E-C-R-E-T

NO FOREIGN DISSEM

S-E-C-R-E-T
NO FOREIGN DISSEM

50X1-HUM

Then, the connection of condenser 3C-14 between grid and anode of valve 3V-8 is equal to the connection, between grid and cathode of valve 3V-8, the capacity "K" times bigger than condenser 3C-14.

This equivalent capacity we shall call integrating capacity and shall mark it as C_1 .

Then

$$C_1 = 3C-14 \times K$$

where: K - amplification factor of amplifying stage build with valve 6Z5P /3V-8/ without feed back coupling.

We can see from diagram shown on Fig. 64, that the voltage change on C_1 will be transferred to the cathode of comparing diode, by the same circuits as slow saw tooth voltage, that means, that the voltage value on C_1 will estimate the time delay of gate pulse forming beginning, and also will estimate the output value of distance voltage. Just for this C_1 capacity voltage regulation, at target approach or dismissing, the charging and discharging diodes are determined. The circuit, of integrating capacity charging and discharging diodes is build with double diode 6H2P /3V-12/ shown on Fig. 79.

The work of circuit is as follows:

At the work for "searching" both diodes are blocked. Diode 3V-10a is blocked by negative voltage, applied to the anode from -150 V divider, consisting of resistors 3R-10, 3R-11, 3R-12, 3R-80, 3R-81, 3R-82. Diode 3V-12b is blocked by anode negative voltage, which via contacts 4-5 of 3R3-1 relay is applied from slow saw tooth generator.

In this way the anode voltage of diode 3V-12b is always equal to grid voltage of amplifier 3V-8 that is, integrating capacity voltage.

At the time of reflected from target pulses appearance to coincidence stages, the interception relay 3R2-1 disconnects slow saw tooth generator from grid of 3V-8 valve, and by that from 3V-12b anode and integrating capacity C_1 . The voltage on integrating capacity C_1 is such as the slow saw tooth voltage

S-E-C-R-E-T
NO FOREIGN DISSEM

50X1-HUM

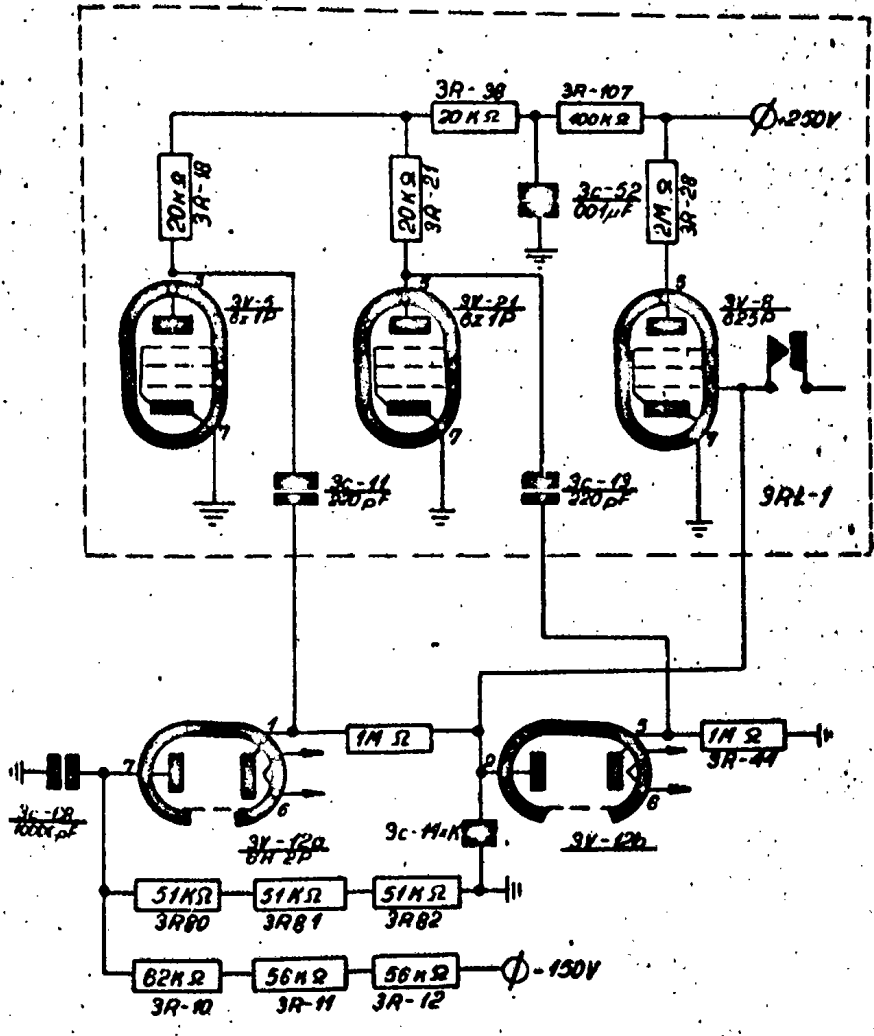

Fig. 80. Circuit diagram of integrating capacity charging and discharging diodes.

S-E-C-R-E-T
NO FOREIGN DISSEM

NO FOREIGN DISSEM

50X1-HUM

was at the time of interception, that is at a time of 3R-1 relay contacts 4-5 disconnection. After the target interception the voltage on C_1 is controlled by integrating capacity charging and discharging diodes.

When the reflected from target signal is in phase with second gate pulse, the negative pulse from 3V-21 anode is applied via condenser 3C-13 to the cathode of diode 3V-12b and unblocks it. Condenser 3C-13 starts then to get discharged in the circuit: capacity 3C-13, inner resistance of diode 3V-21, ground, integrating capacity C_1 and inner resistance of diode 3V-12b. At the same time the integrating capacity C_1 gets charged, that means, it receives the higher potential

It causes the anode voltage of 3V-8 increase and so the cathode voltage of 3V-3a and 3V-3b, what brings to gate pulses shift towards farther targets.

In breaks between reflected from target pulses, condenser 3C-13 regains its charging via circuit: +250 V, resistors 3R-107, 3R-38, 3R-21, capacity 3C-13, resistor 3R-44 and ground / i.o. - 250 supply source.

Because of big time constant of this circuit, the condenser 3C-13 charging lasts about 800 μ sec.

Because the time between two pulses is 1100 μ sec. so the charging of condenser 3C-13 will be completed till next reflected from target pulse coming.

When the target pulse is in phase with first gate pulse, the valve 3V-5 is unblocked. From its anode the negative pulse is applied via condenser 3C-11 to the cathode of diode 3V-12a and makes it unblocked.

The capacity 3C-11 starts to get discharged via circuit: Condenser 3C-11, inner resistance of valve 3V-5, condenser 3C-62 and inner resistance of valve 3V-12a.

The C_1 potential does not change then.

After the valve 3V-5 blocking, the capacity 3C-11 regains its charging via circuit: +250 V, resistors 3R-107, 3R-38, 3R-12, condenser 3C-11, resistor 3R-44, integrating capacity C_1 and ground. This condenser 3C-11 charging lasts the same time as condenser 3C-13 charging process, that is 800 μ sec.

In this manner the full condenser 3C-11 charging is

S-E-C-R-E-T

NO FOREIGN DISSEM

NO FOREIGN DISSEM

50X1-HUM

completed till next pulse comes.

During condenser 3C-11 charging restoration, the voltage on integrating capacity C_1 becomes less negative, that brings the gate pulse shift to the side of nearer targets. This gate pulse shifting process will take place till the target pulse will situate itself between gate pulses.

The charging and discharging of integrating capacity C_1 difference will then equal zero.

The C_1 integrating capacity voltage change diagram is shown on Fig. 81.

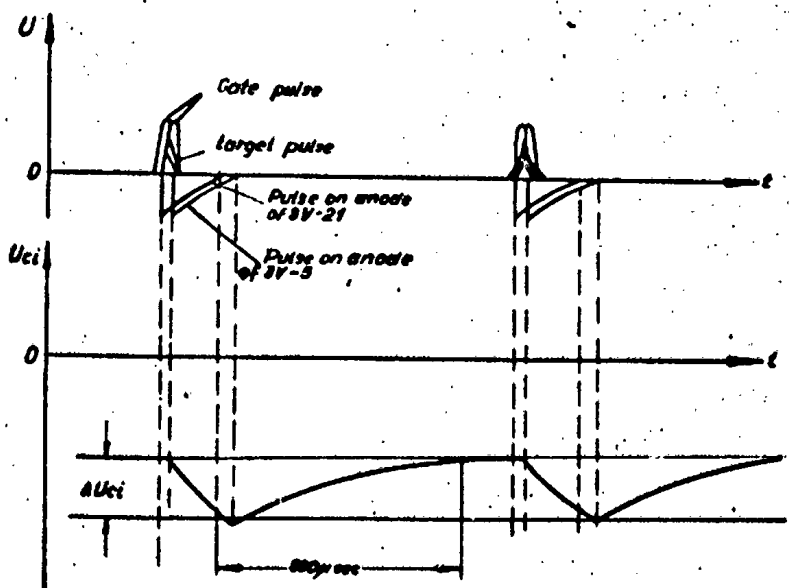

Fig. 81. Voltage change on C_1 at unchanged distance from target.

Integrating capacity charging and discharging currents are estimated by time and amplitude of pulses on anodes of coincidence valves 3V-5 and 3V-21.

At the target dismissing the target pulse will be more in phase with second gate pulse. Then the pulse on anode 3V-21 will be bigger than the pulse on anode of 3V-5 and C_1 charging current will be bigger than discharging current.

The voltage on C_1 will be more negative, that, as it was

S-E-C-R-E-T

NO FOREIGN DISSEM

NO FOREIGN DISSEM

50X1-HUM

stated above, will bring to gate pulse shifting towards further targets. The voltage change C_1 , in this case, is shown on Fig. 82.

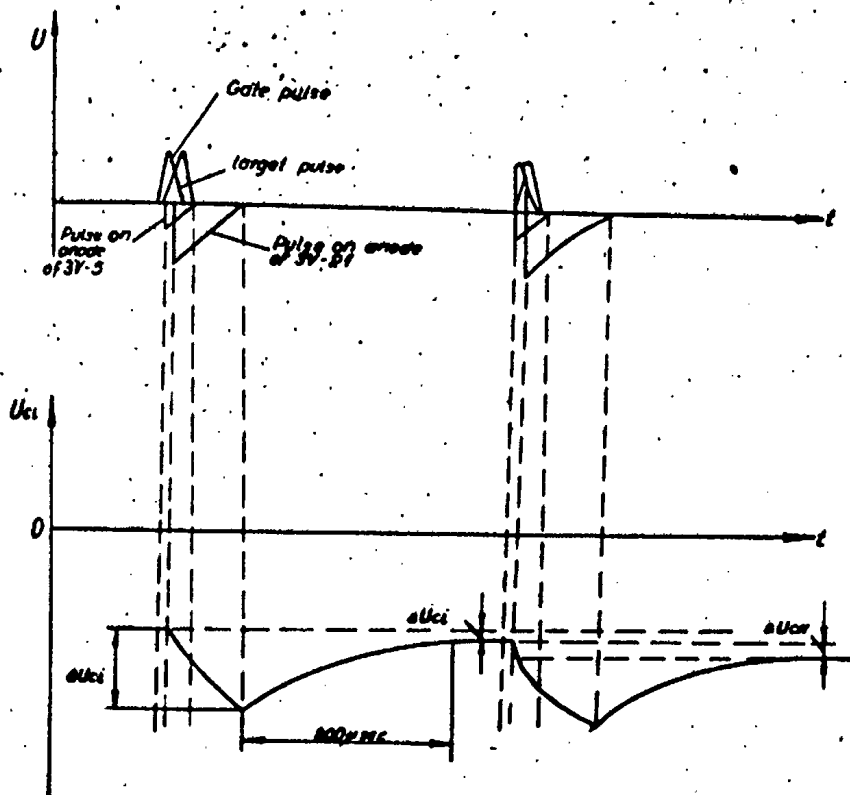

Fig. 82. C_1 voltage change at target dismissing.

During the target approach the pulse on anode of 3V-5 increases, but on anode of 3V-21 decreases.

The negative voltage on integrating capacity gets decreased, that brings the gate pulse shift towards nearer targets. The C_1 voltage change, in this case, is shown on Fig. 83.

The C_1 voltage change in this case we can explain in following way.

Because the time of charging restoration of 3C-11 /und also the charging time of C_1 is unchanged, due to unchanged time constant of condenser 3C-11 charging circuit, the voltage

S-E-C-R-E-T

NO FOREIGN DISSEM

NO FOREIGN DISSEM

50X1-HUM

change on C_1 will be estimated by the value of C_1 charging current /i.e. by time and amplitude of pulses on 3V-21 anode/. This estimates charging value of integrating capacity ΔU_{C_1} during one pulse on anode of 3V-21.

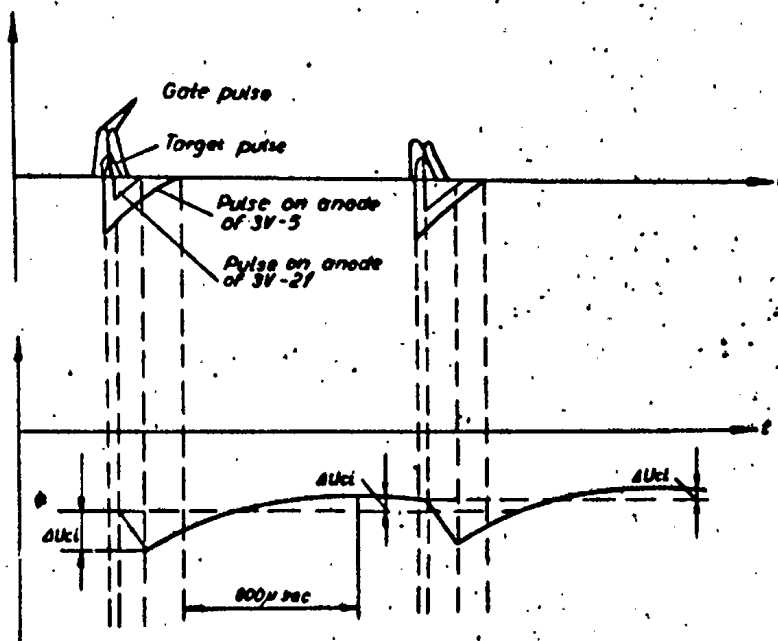

Fig. 23. C_1 voltage change during target approach.

In case of target approach, integrating capacity voltage, between two pulses, will increase to the value ΔU_{C_1} . This voltage increase will be very insensible during one cycle. But integrator circuit will add all these insensible changes and transfers them into remarkable voltage changes in the circuit output.

This amplifier voltage summary is applied to the cathode of diode comparator /3V-3b/ and shifts the gate pulses toward nearer targets.

150

S-E-C-R-E-T

NO FOREIGN DISSEM

50X1-HUM

8. Integrator and slow saw tooth limiter.

The circuit diagram of integrator and slow saw tooth limiters for maximum and minimum is shown on Fig. 84.

This circuit works as follows:

At the work for searching the control grid of amplifier build with pentode 6ZP /3V-9/ receives the negative saw tooth voltage of frequency 0,5 + 1,5 c/s via contacts 4-5 of relay 3R1-1 from slow saw tooth generator. These amplified and shifted in phase oscillations from anode circuit of 3V-8 are applied via limiter for minimum /3V-11b/ to the grid of cathode follower, build with one section of double triode 6N1P /3V-3a/. As a load for cathode follower, the divider of resistors 3R-73, 3R-72, 3R-71 is used.

The other end of this limiter is connected to -150 V of supply source. The slow saw tooth voltage, changing in range from 30 + 140 V is applied to cathode of comparing diode /3V-3b/ from resistor 3R-71. This controls the delay of gate pulse forming beginning.

The slow saw tooth limiter for minimum is build with one section of double triode 6N1P /3V-11b/ connected as a diode. The cathode potential of diode limiter should be established by specially selected resistor 3R-35 of +250 V voltage divider consisting of resistors 3R-40, 3R-39, 3R-42. This selection should guarantee the gate pulse forming beginning with delay of 1,33 + 2 μ sec. relatively to probe pulse, what excludes a possibility of its interception. This delay time corresponds to 200 + 300 m. distance and estimates the dead area for searching. The limiter for maximum works with one section of double triode 6N1P /3V-22a/ also connected as a diode.

The cathode potential of 3V-22a is fixed by switch 5PK-1 position. In position "2000 m" the +150 V voltage is applied to cathode which will guarantee the searching range not less than 2000 m.

In the switch position "1200 m" the positive voltage from divider 6R-2, 6R-5, fitted in control panel, is applied to cathode of diode 3V-22a. This cathode voltage set by

50X1-HUM

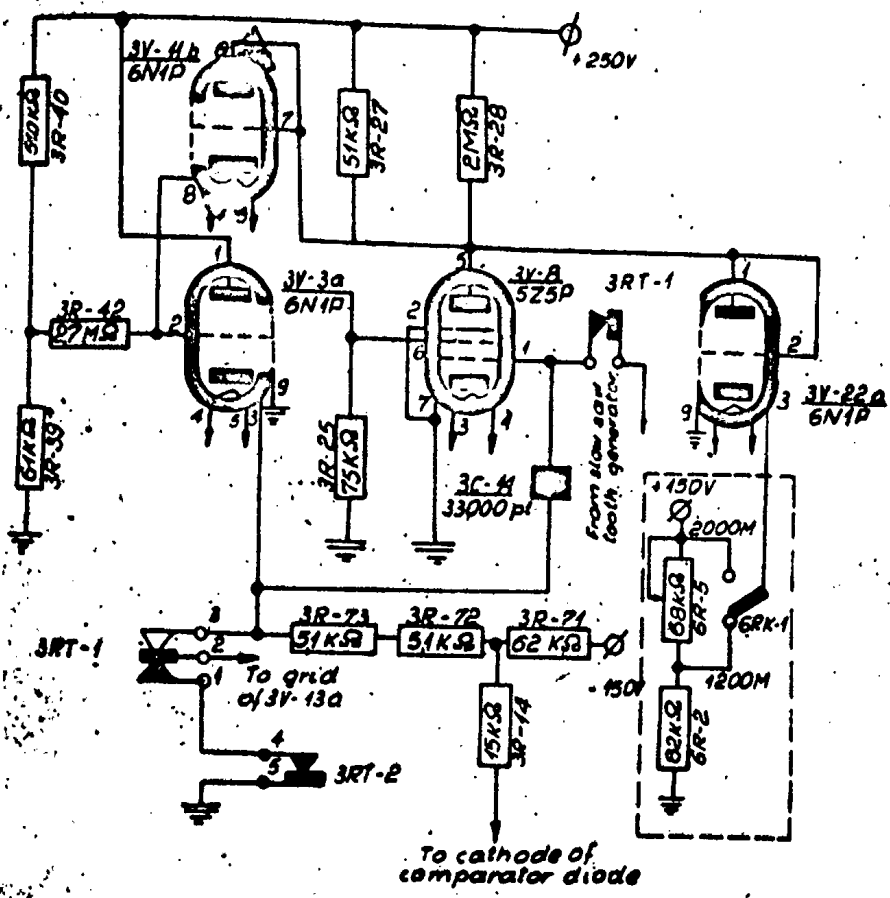

Fig. 04. Circuit diagram of integrator and slow saw tooth limiters.

NO FOREIGN DISSEM

50X1-HUM

potentiometer 6R-5, should be of such a value, which will guarantee the searching within range of 1200 + 1500 m. Maximum searching limitation /within range 1200 + 1500 m/ is very necessary for avoiding the possibility of reflected from ground signal interception during the action on low altitude /1200 m/. These reflected from ground signals will be stronger than signals reflected from target /see Fig. 85/.

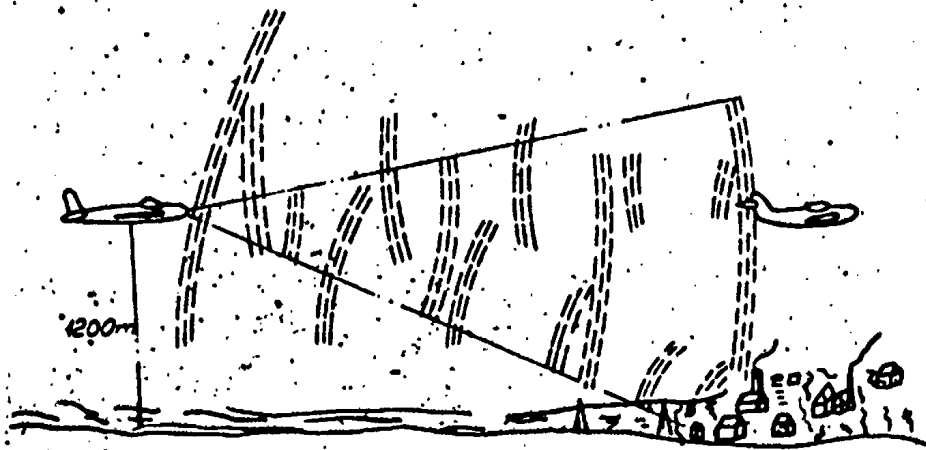

Fig. 85. Pulse character reflected from target and from ground features.

Slow saw tooth voltage change character on diode limiter cathode after limitation for maximum and minimum is shown on Fig. 86.

During interception conditions the contacts 4-5 of relay 3R1-1 are getting open and disconnect the slow saw tooth generator from integrator circuit. From this time the output voltage, of integrating capacity $C_1 / 30-14 \times K /$ charging and discharging diodes circuit, is applied to control grid of amplifier 3V-3. This voltage is equal to slow saw tooth voltage at the time of relay 3R1-1 contacts 4-5 disconnection.

13

S-E-C-R-E-T

NO FOREIGN DISSEM

50X1-HUM

This voltage, during interception conditions is controlled by integrating capacity C_1 , charging and discharging diodes and at unchangeable distance from target is constant.

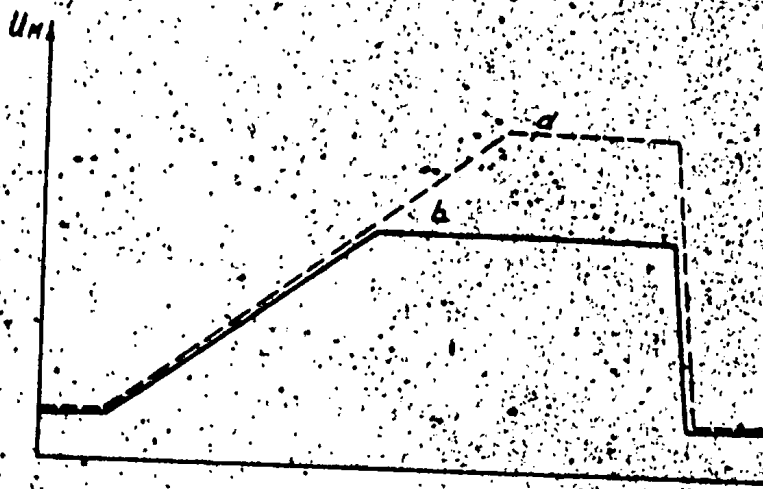

Fig. 96. Slow saw tooth voltage change character.

a/ at "2000 M" switch position

b/ at "1200 M" switch position.

During the approach to target, the delay time of reflected from target pulse, relatively to the time of radiated probe pulse, decreases and target pulse is more in phase with first gate pulse. This causes the decrease of negative voltage on integrating capacity, that means - on the grid of 3V-8 amplifier.

The anode voltage of 3V-8 valve will be "K" times decreased due to increased anode current. This decreased voltage will be applied via cathode follower 3V-3a to the cathode of comparator diode 3V-3b and will cause gate pulses shift towards nearer targets. During target dismissing the absolute voltage value on integrating capacity C_1 gets increased. It causes the amplification of "K" times increased voltage on anode of 3V-8 amplifier. Also the cathode voltage of comparator diode is relatively increased. But increased cathode voltage of

S-E-C-R-E-T

NO FOREIGN DISSEM

S-E-C-R-E-T
NO FOREIGN DISSEM

50X1-HUM

3V-3b causes the gate pulse shifting towards farther targets.

The gate pulse shifting process will last till reflected from target pulse will balance itself between gate pulses.

At the same time with target pulse "tracing" from integrator target the proportional to distance voltage is applied to the grid of cathode follower from 3V-3a cathode via contacts 2-3 of 3R-1 relay. The proportional to distance voltage from cathode load is applied to ASP-4N diode.

From the centre of 3R-26 and 3R-27 divider the voltage of about ± 140 V is applied to the screen grid of valve 3V-8.

1. Memory circuit.

The "memory" circuit is shown on Fig. 57. It is built with double triode type 6N1P /3V-13/

Right section of this valve represents an electronic relay with delayed release but with left section the cathode follower circuit is made.

The "memory" circuit is destined for continuous distance voltage supply to automatic diode ASP-4N.

The continuity of this voltage supply may be stopped for some time due to 3R-2 relay work delay.

During the work for "searching" the valve 3V-13b is blocked by negative bias, applied to control grid from divider 3R-17, 3R-18 via connected in series resistors 3R-10 and 3R-11. Condenser 3C-22, connected between valve grid and ground is charged to blocking voltage value from resistor 3R-17. At the moment of target interception, the open of searching contacts 11-12 are getting closed and the grid is then connected via resistor 3R-11a to the ground. Condenser 3C-22 starts then to get recharged in the circuit: bottom plate of 3C-22; ground, 3R-11a and top plate of 3C-22. The voltage across nearly to zero and the valve 3V-13b is unblocked.

The anode current of this valve passes then through the winding of relay 3R-2. The signal lamp "target" interception in diode ASP-4N is switched on by closed contacts 5-6.

The closed contacts 2-3 of relay 3R-2 switch on the

14

S-E-C-R-E-T
NO FOREIGN DISSEM

NO FOREIGN DISSEM

50X1-HUM

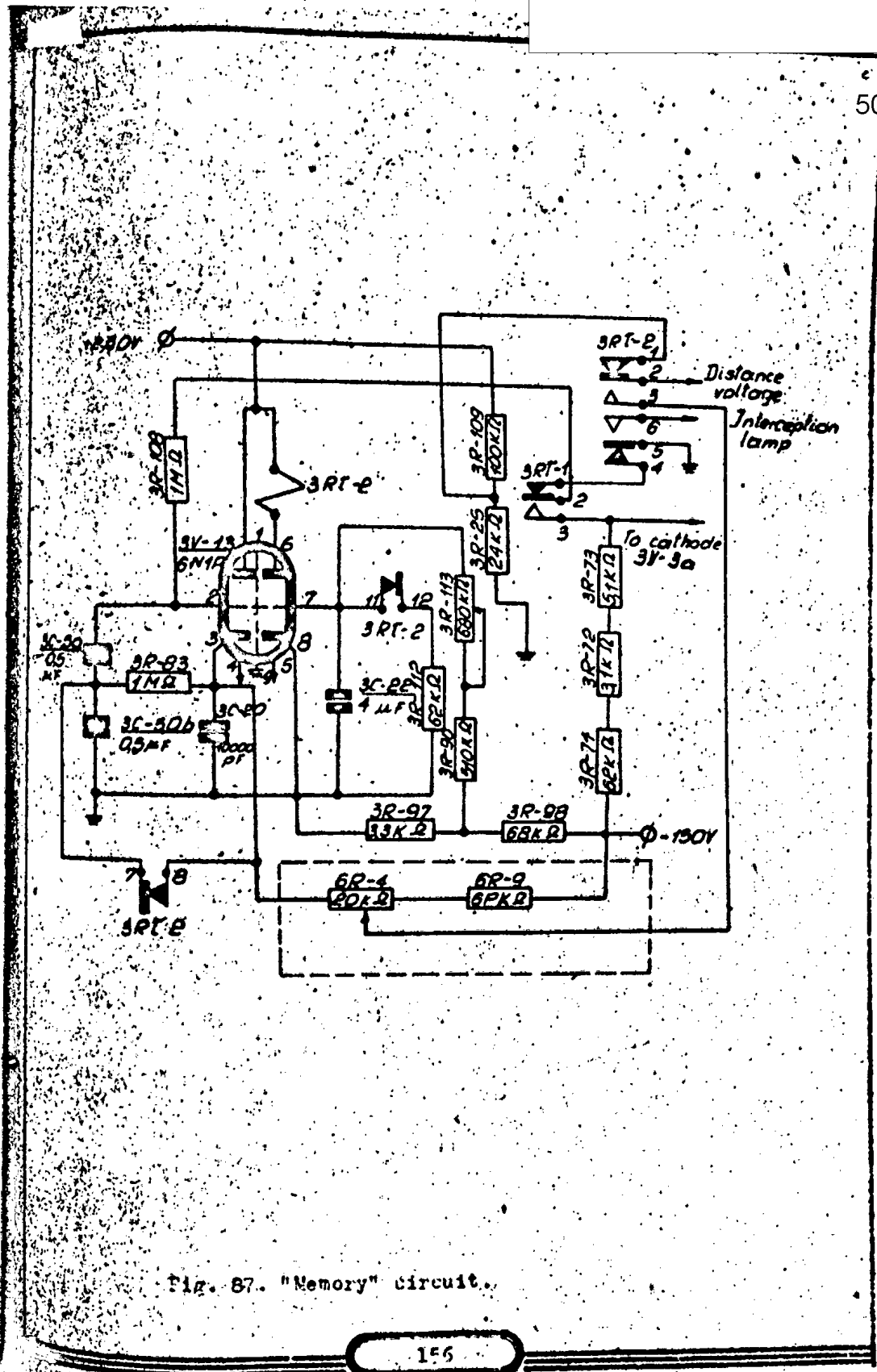

Fig. 87. "Memory" circuit.

S-E-C-R-E-T
NO FOREIGN DISSEM

NO FOREIGN DISSEM

50X1-HUM

proportional to distance voltage to diode ASP-4H from the cathode of left section 3V-13 valve. By open contacts 7 - 8 resistor 3R-53 is switched into the "memory" circuit.

Let us suppose, that somehow the target signal disappeared. It may happen, for instance, at decrease of effective target reflecting surface which takes place at the change of target-aircraft position in air, at increase of suppression of probe and reflected pulse energy, what can happen when aircraft is covered by rain clouds.

The signal can also disappear from other reasons.

When the target signal disappears, there is no current in the winding of relay 3R-1. Contacts 11 - 12 are open and condenser 3C-22 starts to get discharged in the circuit: top condenser plate, resistors 3R-113, 3R-50, 3R-58, inner resistance of -150 V supply source, ground and bottom plate of condenser. Relay 3R-2 is still in working conditions and to the diode still the proportional to real distance voltage is applied. It will last till the voltage on condenser 3C-22 will reach the value necessary to block the valve 3V-13b, then because of no current in relay 3R-2 winding, the contacts will get the position of "searching". Time constant of 3C-22 charging circuit defines the time of 3R-2 relay release.

The smaller is the resistor 3R-113, the quicker the valve 3V-13b is blocked. The delay time can be set in range 2.5 ± 6 sec by potentiometer 3R-113.

The cathode follower, built with left section of 3V-13 valve enables to "remember" relative target speed and to preserve change condition of distance voltage, the same as it was during reflected from target pulses before their dismissing.

This circuit is one of various "memory" circuits and works in following way.

At a time of target interception to the grid 3V-13a the proportional to distance from target voltage is applied from cathode 3V-13a via resistor 3R-108 and contacts 2 - 3 of 3R-1 relay. When the distance to target is unchanged this voltage is constant and the current passing the valve 3V-13c

157

S-E-C-R-E-T

NO FOREIGN DISSEM

50X1-HUM

is also constant. The diode ASP-4N will set the constant voltage from cathode load of 3V-13a. The voltage of condenser 3C-50b is equal to the voltage of condenser 3C-20. Now let us say, that the distance from target changes itself with some constant speed, it means that with constant speed, the voltage on cathode of 3V-3a will change itself, and also on control grid of 3V-13a that means on condenser 3C-50. Also with constant speed the anode current will be changed. The current change speed depends on speed of distance from target change.

Now we can write for the case of distance from target increase.

$$\frac{dI}{dt} = \text{const.}$$

With the same speed, the cathode voltage of 3V-13a will change itself that means on condenser 3C-20, and we can write.

$$\frac{dU_{c-20}}{dt} = \text{const.}$$

The voltage on condenser 3C-50b will change itself with constant speed, but it will be different to the voltage value on condenser 3C-20 because of voltage drop on resistor 3R-83 during the charging of condensers 3C-20 and 3C-50b in the circuit. Top plate of 3C-20, resistor 3R-83, 3C-50b, ground, when the reflected from target pulse disappears, there is no current in the winding of relay 3R2-1. Contacts 2-3 are open and the grid of valve 3V-13a is disconnected from cathode of 3V-3a. From this time the anode current of 3V-13a is controlled automatically by positive feedback between cathode and grid, made by the circuit 3R-83, 3C-50b.

Condenser 3C-20 and 3C-50b voltages tend to equalize their absolute values, but the voltage change on condenser 3C-50b causes the voltage change on grid of 3V-13a, and the anode current of this valve. This keeps the constant speed of voltage change on condenser 3C-20.

This change will take place with previous speed if we shall state with some approximation that the transferring

S-E-C-R-E-T

NO FOREIGN DISSEM

S-E-C-R-E-T
NO FOREIGN DISSEM

50X1-HUM

factor of cathode follower is equal to 1. We can ensure it in following way.

Considering our cathode follower as an ideal, with transferring factor equal to 1 we can consider the input conductance as equal to 0. The potential difference between grid and cathode will then be also equal 0 /zero/, it means that the voltage on condenser 3C-50a and voltage drop on resistor 3R-83 will be equal:

$$U_{C-50a} / t / = U_{R-83} / t /$$

At the target signal disappearance, the grid of 3V-13a is disconnected from cathode of 3V-3a and has no proportional to distance voltage. The voltage on 3C-50a is unchanged, because there is no circuit for its discharging.

Also the current passing the resistor 3R-83 will be constant because its voltage is equal to the voltage of condenser 3C-50a.

The current, passing resistor 3R-83 equals:

$$i_{R-83} / t / = \frac{U_{R-83}}{R_{83}} = \frac{U_{C-50a}}{R_{83}} = \text{Const.}$$

Because the voltage on condenser 3C-50b is just defined by this current we can write:

$$U_{C-50b} / t / = \frac{1}{C_{50b}} \int_0^t i_{R-83} / t / dt$$

$$\frac{dU_{C-50b}}{dt} = \frac{1}{C_{50b}} \cdot \frac{U_{C-50a}}{R_{83}} = \text{Const.}$$

The voltage on condenser 3C-20 will change with the same speed, because it is equal to voltage drop summary on resistor 3R-83 and 3C-50b /See Fig. 89/.

$$dU_{C-20} / t / = U_{R-83} + U_{C-50b} / t / = i_{R-83} \cdot R_{83} + \frac{1}{C} \cdot \frac{U_{C-50a}}{R_{83}} \cdot t$$

and then the speed of this voltage change will be equal:

S-E-C-R-E-T

NO FOREIGN DISSEM

NO FOREIGN DISSEM

50X1-HUM

$$\frac{dU_{C-20}/t}{dt} = \frac{1}{C_{50b}} \cdot \frac{U_{C-50a}}{R_{83}} = \text{Const.}$$

it means: will be constant in time. . . .
 the valve anode current consists of current passing through resistor 3R-83 and resistors 6R-4 and 6R-9. The voltage drop on these resistors corresponds to voltage on condenser 3C-20. Because the current passing the resistor 3R-83 is constant, constant will the voltage change on condenser 3C-50b, that is on grid of 3V-13a and the anode current will change itself with constant speed.

Because the current, passing the resistor 3R-83 is constant in time, then the current passing resistor 6R-4 and 6R-9 will change itself and cause the changed voltage drop on those resistors. This, in turn will change the distance voltage, which is drawn from potentiometer 4R-4 and applied to automatic dioper ASP-4N via contacts 2-7 of relay 3R1-2.

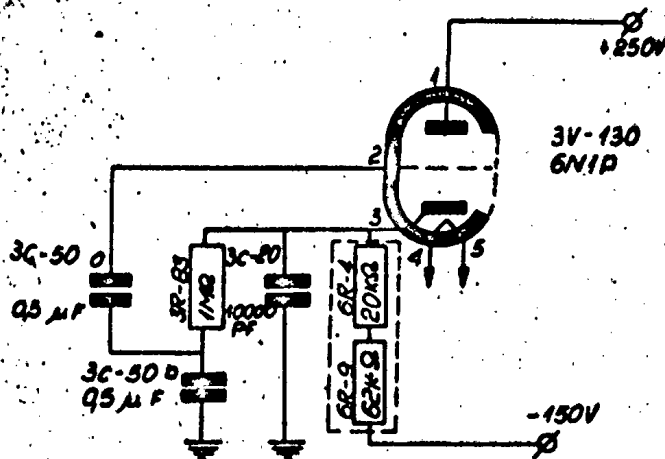

FIG. 29

In this way, at the target signal shrinkage, the "read" circuit generates changing in time voltage, proportional to the voltage, which was generated on capacitor 3C-50b, by the

S-E-C-R-E-T

NO FOREIGN DISSEM

NO FOREIGN DISSEM

50X1-HUM

integrator circuit output voltage /cathode 3V-3a/.

Because of this, at shortlasting, reflected from target pulse shrinkages, the dioptr will still be supplied with distance voltage, corresponding to real distance to target.

If during the time, defined by relay 3R1-2 release, delay /3 + 4 sec./, the target appears again, then again the interception will happen and there will be no error in distance definition.

If the target shrinkage lasts longer than 3 + 4 sec. the relay 3 R1-2 will release and the "memory" circuit starts "searching". To the dioptr the voltage corresponding to distance 500 + 140 m is applied from divider 3R-25, 3R-109 via contacts 1 and 2 of relay 3R1-2.

To avoid the reaction of memory circuit for short lasting target signals shrinkages, there is a delay fore-seen in relay 3R1-2 work. It is obtained by 3V-13 b grid connection to the ground via resistor 3R-112 at a time of interception. Then the 3C-24 voltage decreases to the necessary for valve 3V-13b unblocking value not, instantly, but after some time from the moment of 3R1-1 relay stimulation.

For switching the "tracing cathode follower" circuit off at shortlasting interceptions, resistor 3R-83 is shorted by contacts 7-8 of relay 3R1-2.

It excludes the possibility of wrong "remembrance" of big speed.

10. Receiver automatic gain control for noise /AGC/.

/AGC for noise/

A.G.C. for noise is destinated for keeping constant noise level in the receiver output. This helps to obtain constant sensitivity of receiver channel. A.G.C. for noise stage is build with valves 3V-20 /622P/ and 3V-7 /5H1P/ and shown on Fig. 8c.

The first stage is made as a resistor amplifier with valve 3V-20.

The second stage with left section of 3V-7 valve works as a grid detector. The third stage with right section of 3V-7, works as a d.c. amplifier.

S-E-C-R-E-T

NO FOREIGN DISSEM

NO FOREIGN DISSEM

50X1-HUM

This circuit works in following way:

The noise from receiver output comes to the input of amplifier stage /valve 3V-20/ via condenser 3C-42.

Amplified and inverted in phase noise from resistor 3R-102, which is an anode load of valve 3V-20 is applied to the left section of valve 3V-7. This stage, as it was said above works as a grid detector. Detected and amplified noise voltage is applied from anode load resistor 3R-46 of valve 3V-7a through condenser 3C-54 to the grid of valve 3V-7b d.c. amplifier.

The 3V-7b valve is normally blocked by negative, relatively to the cathode, grid voltage, applied there from resistor 3R-74 of - 150 V voltage divider.

To avoid the influence of reflected from ground pulses on A.G.C. for noise circuit, the AGC stage is blocked for $25 + 30 \mu\text{sec.}$ from the moment of probe pulse radiation.

Blocking negative pulse is applied to the suppressor grid of 3V-20 through condenser 3C-2 from speed saw tooth generator and blocks the valve for period of $25 + 30 \mu\text{sec.}$

Because of this action the AGC circuit does not work during $25 + 30 \mu\text{sec.}$ /see Fig. 10/.

From the resistor 3R-69, being a part of above mentioned divider, the negative voltage is applied to the cathode of 3V-7b. At the same time this resistor is as a cathode load for valve 3V-7b. Resistor 3R-69 is blocked by condenser 3C-64 to remove the influence of alternating component on the working conditions of d.c. amplifier.

The valve 3V-7b will get unblocked when to its grid will come detected and amplified noise voltage. Then through the valve will pass the current, which on the anode load /resistor 3R-68/ causes the voltage drop, and charges, at the same time, the 3C-65 blocking condenser.

This negative /relatively to ground/ voltage drop charges the condenser 3C-15b through resistor 3R-59 and then is applied to the grid of cathode follower 3V-2. b which is a output stage for receiver automatic gain control circuit.

S-E-C-R-E-T

NO FOREIGN DISSEM

50X1-HUM

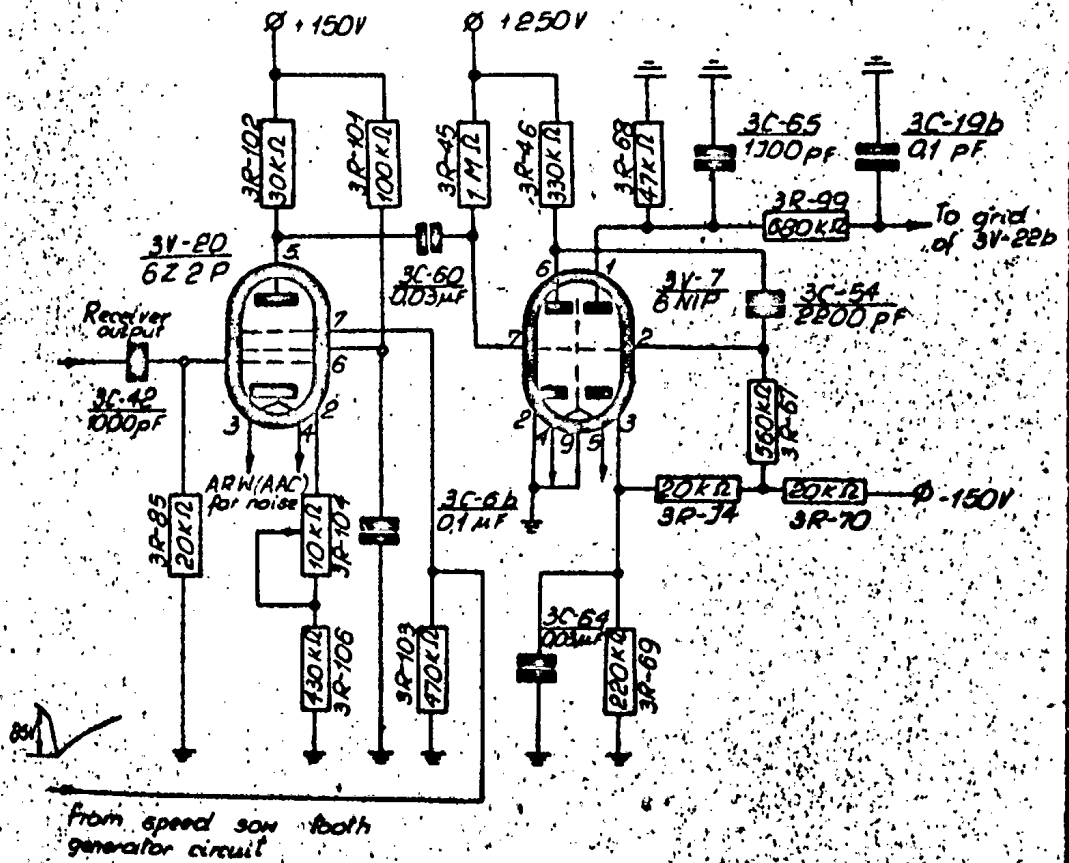

Fig. 8S. The circuit of automatic gain control (A.G.C.) for noise.

S-E-C-R-E-T
NO FOREIGN DISSEM

50X1-HUM

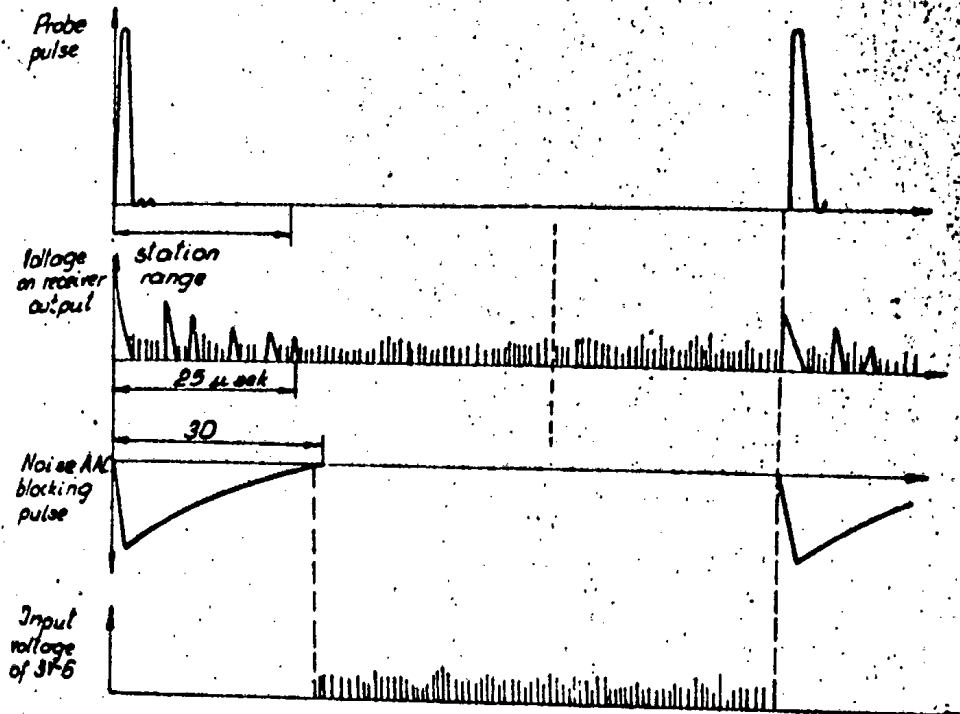

Fig. 10. Noise automatic gain control work; spread in time.

The /A.G.C./ ARW negative voltage from the cathode load of valve 2V-22b is applied to control grids of IF amplifier two first valves. This decreases the amplification and noise level in the receiver output.

Initial noise level in the receiver output is established by potentiometer 3R-104, connected into the cathode circuit of input amplifier of noise /A.G.C./ ARW stage. /valve 3V-20'.

By the change of resistor 3R-104 value, at the grid of valve 3V-20, such an initial voltage is selected, which secures in the receiver output the noise level at about 10 - 14 v.

Subsequently in the noise ARW /A.G.C./ circuit this noise level is kept automatically.

But the A.G.C. output voltage will be changed slightly

NO FOREIGN DISSEM

50X1-HUM

because the voltage on condenser 3C-19b will ^{change} a little due to big 3C-19b discharging time constant. This condenser, during the blocking of 3V-20 will get discharged in the circuit: top plate of 3C-19b, ground, resistors 3R-68, 3R-69, and bottom plate of condenser 3C-19b.

Resistors 3R-85 and 3R-103 are grids leak resistors for control and suppressor grids of valve 3V-20 respectively. Resistor 3R-101 is used as a voltage drop resistor for screen grid of valve 3V-20, blocked by condenser 3C-66.

Resistor 3R-67 is used as a grid leak resistor for control grid of 3V-7t.

11. Receiver automatic gain control for pulse /pulse ARW

Pulse ARW /AGC/ is very necessary to secure the receiver before overcharging it by signals of big amplitude, to keep the output signals on the same level and for decreasing the error in distance from target determination by signals of various intensity. The distance determination error at signals of various amplitude is shown on figure 11.

Pulse ARW /AGC/ /See Fig. 12/ works only from intercepted signal. Necessity of this can be explained as follows.

As we can see from Fig. 11 to receiver input may come the signals of various intensity, reflected from several targets, the example of which is shown on Fig. 11.

Because the pulse automatic gain control /ARW/ works relatively to signal amplitude, so to bigger amplitude corresponds smaller receiver amplification.

If the pulse A.G.C. circuit will react to all pulses, coming to receiver input it will apply the negative grid bias to receiver valves proportional to signal of bigger amplitude. Therefore, at target signal interception, coming to receiver input at the same time with another signal of bigger amplitude, the pulse AGC circuit will apply the grid bias proportional to bigger signal. In this case, the receiver amplification will be decreased and may happen such a case, that intercepted signal will be cut off, that means, that it will disappear because of small receiver amplification. Therefore all pulse

S-E-C-R-E-T

NO FOREIGN DISSEM

S-E-C-R-E-T
NO FOREIGN DISSEM

50X1-HUM

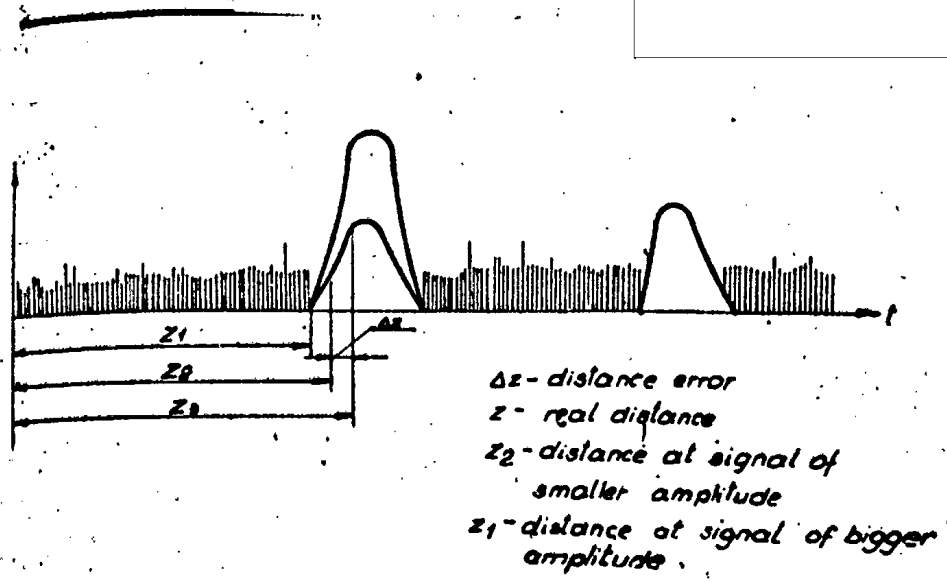

Fig. 51. Distance determination error relatively to target signal of various amplitude.

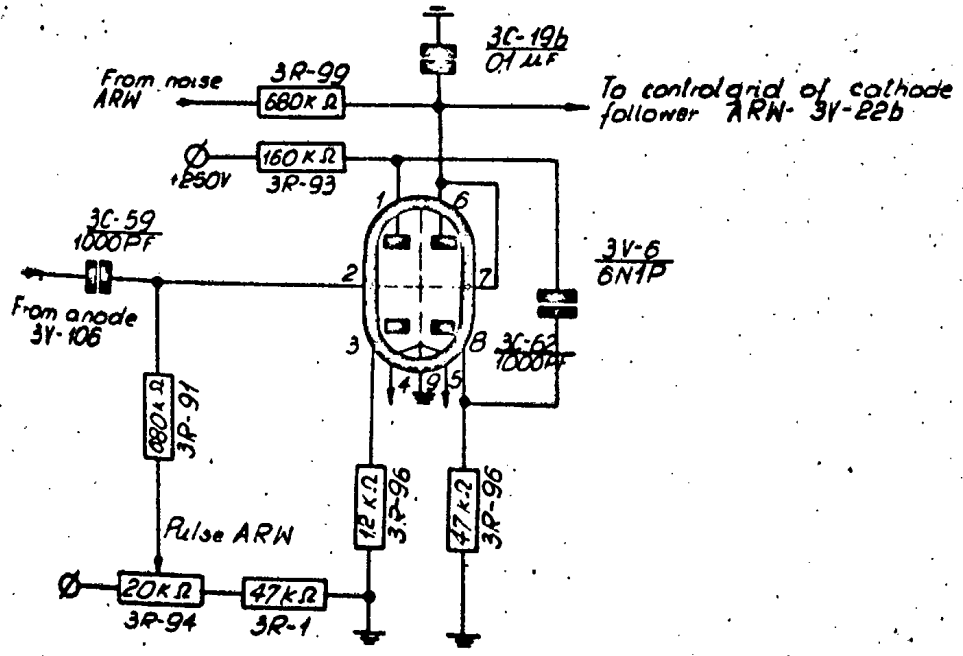

Fig. 52. Pulse automatic main control (App. 1).

S-E-C-R-E-T
NO FOREIGN DISSEM

NO FOREIGN DISSEM

50X1-HUM

AGC works only at target interception conditions.

At the target interception on the anode of left section valve 3V-10 /6N1P/ will appear positive stretched pulse, which will be applied to the control grid of left section valve 3V-6 /6N1P/. This stage represents a common resistor amplifier. In normal conditions this stage is blocked by negative grid bias on control grid, applied there from divider 3R-54 and 3R-1.

Potentiometer 3R-54 let us control the initial grid bias, what means that it let us to generate the delay in pulse amplification. This is necessary to avoid AGC reaction to weak signals at long distance.

Resistor 3R-93 is used as a load for left section of valve 3V-6: from this resistor the amplified negative pulse is applied through condenser 3C-62 to the diode detector, build with right section of valve 3V-6.

Resistors 3R-68 and 3R-95, blocked with condenser 3C-19b, are used as detector load.

The bigger signal amplitude comes to the pulse AGC input circuit, the bigger current will pass through the diode and to higher voltage condenser 3C-19b will get charged.

The condenser is charged via circuit: ground, 3C-19b, diode inner resistance, condenser 3C-62, left section of valve 3V-6 inner resistance, resistor 3R-95, ground.

Relatively to ground, negative voltage from condenser 3C-19b is applied to control grids of first two valves of IF amplifier via cathode follower.

12. AGC cathode follower.

Circuit diagram of AGC cathode follower is shown on fig. 93. The cathode follower is made with valve 3V-22a /6N1P/ and serves for matching of AGC circuit /noise AGC and pulse AGC/ with control grid circuits of IF amplifier first two stages. +150 V is applied to the anode of cathode follower and -150 V. to its cathode via resistor 3R-111.

The circuit works in following way: When the incoming negative signal of the control grid increases the smaller is the voltage drop on the resistor 3R-111, and more negative po-

S-E-C-R-E-T

NO FOREIGN DISSEM

NO FOREIGN DISSEM

50X1-HUM

tential, relatively to ground will have the cathode of 3V-22b. The AGC voltage from cathode of this valve is applied to the receiver. Crystal detector 3Lr./EGC-4/ excludes the possibility of positive AGC voltage appearance which passes through the crystal diode to ground.

Resistor 3R-110 is a limiter for current passing through crystal detector.

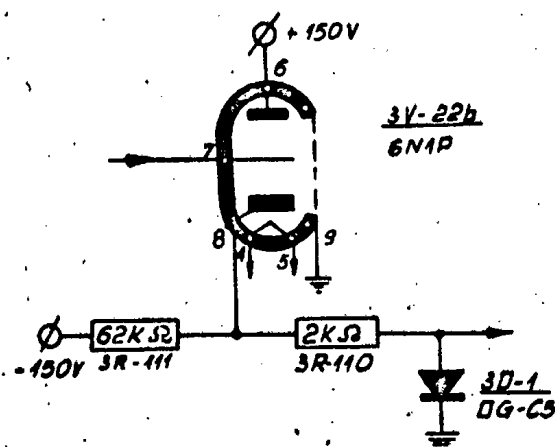

Fig. 53. Cathode follower of AGC circuit.

Construction of unit.

The basic part of construction is a compressed chassis. At the corners of chassis there are frames fitted of angular alloy to make the chassis more stiff. To the front side of unit there is a front panel fitted to which there are two flexible cables 4/3 and 6/3 fixed. Cable 4/3 connects the unit with transmitter-receiver unit and cable 6/3 with power unit /see Fig. 54/. Beside that, to the front panel of the unit there are a concentric HJ junction 5 fitted for connection with I.F. preamplifier, concentric junction "receiver output", potentiometer "LC balance", potentiometer "inclination", potentiometer "noise AGC" and potentiometer "pulse AGC".

158

S-E-C-R-E-T

NO FOREIGN DISSEM

S-E-C-R-E-T
NO FOREIGN DISSEM

50X1-HUM

On the chassis base of the unit there are fitted: all the valves, pulse transformer 3B1-1, delay line 3B2-1, I.T. amplifier, relay 3B3-1 and 3B4-2.

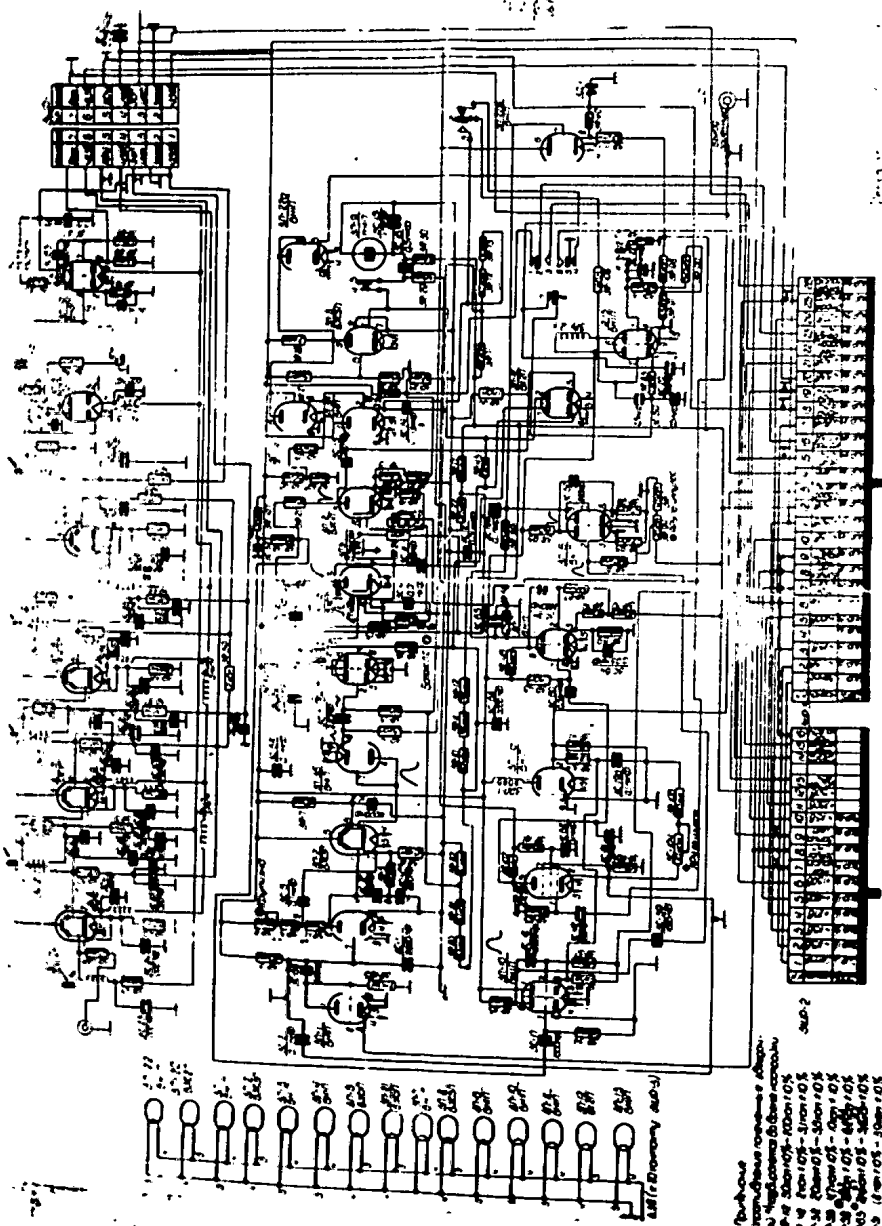

Fig. 1. Circuit diagram of remote unit.

155

S-E-C-R-E-T

NO FOREIGN DISSEM

S-E-C-R-E-T
NO FOREIGN DISSEM

50X1-HUM

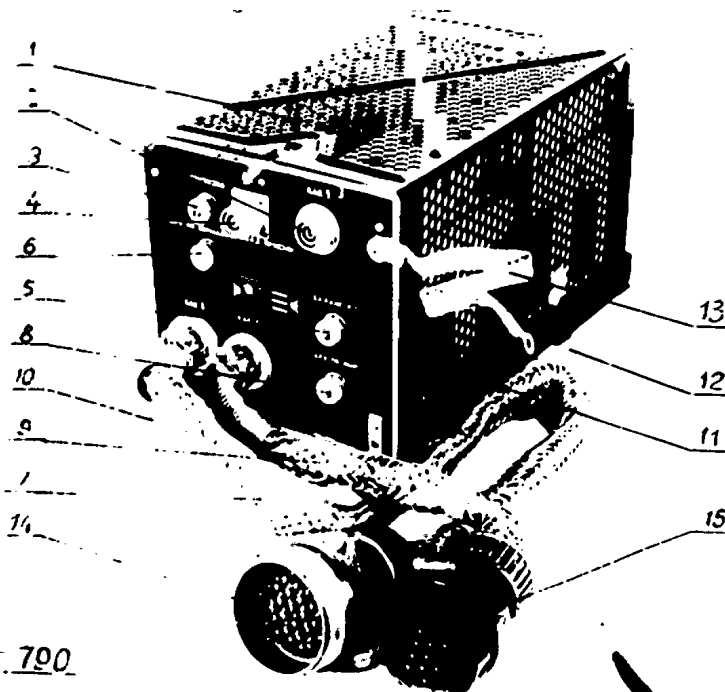

Fig. 95. General view of range unit.

- 1 - Cover
- 2 - HF concentric junction
- 3 - Potentiometer "declination"
- 4 - Concentric junction "receiver output"
- 5 - Potentiometer "L.C. balance"
- 6 - " " "Noise AGC."
- 7 - Cable for connection with power unit
- 8 - Potentiometer "pulse AGC"
- 9 - Cable for connection with transmitter-receiver unit
- 10 - Fixing nut
- 11 - Shockabsorber frame.
- 12 - Shockabsorber type "Lord"
- 13 - Earthing bar
- 14 - 15 pin junction

170

S-E-C-R-E-T

NO FOREIGN DISSEM

S-E-C-R-E-T
NO FOREIGN DISSEM

50X1-HUM

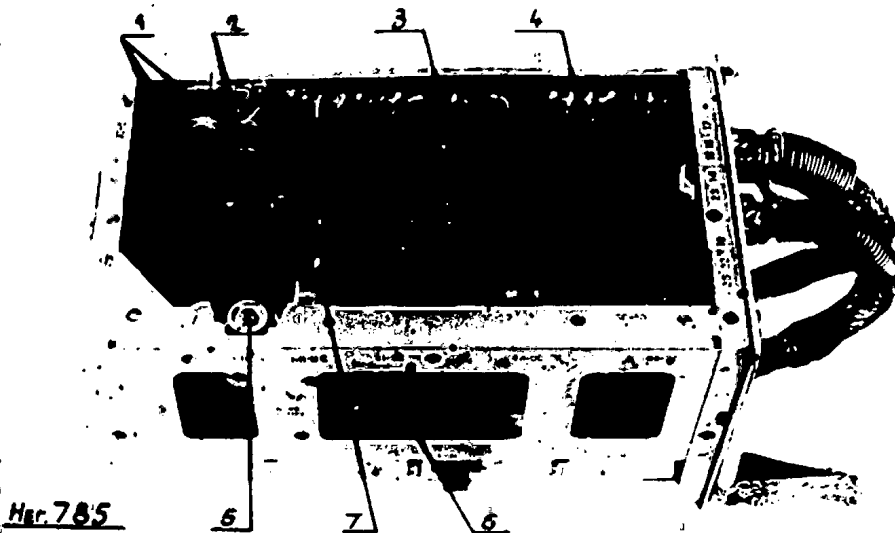

Fig. 96. Bottom view of unit.

- 1 - Precision divider 3R-10, 3R-11, 3R-12.
- 2 - " " 3R-71, 3R-72, 3R-73.
- 3 - Pulse transformer 3Tr-1.
- 4 - Delay line 3Lz-1.
- 5 - Potentiometer for "memory" time setting 3R-113.
- 6 - Slow saw tooth generator 3V-9.
- 7 - Potentiometer of blocking pulse control 3R-114.

S-E-C-R-E-T

NO FOREIGN DISSEM

S-E-C-R-E-T
NO FOREIGN DISSEM

50X1-HUM

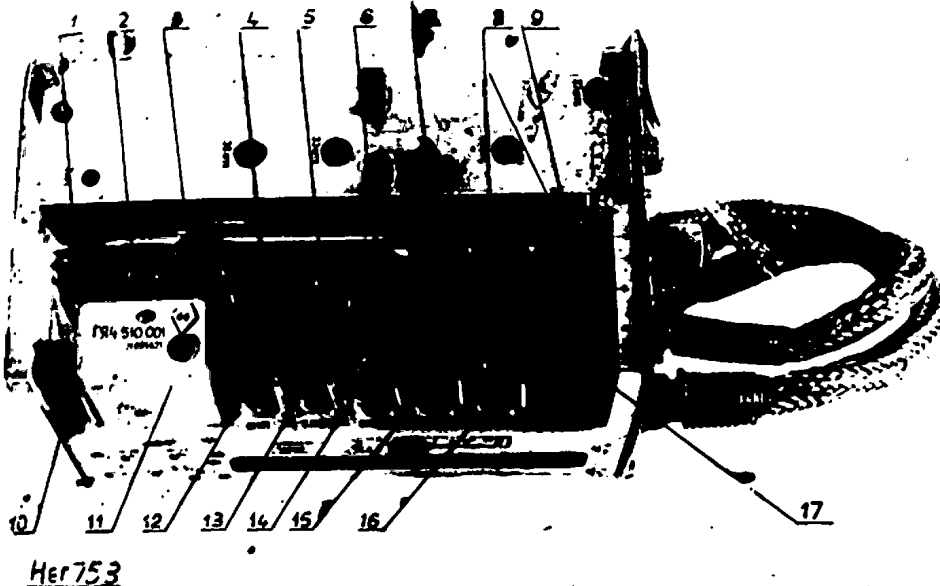

Fig. 57. View of range unit with cover removed.

- 1 - Noise AGC input valve 3V-20.
- 2 - Noise AGC valve 3V-7
- 3 - Pulse AGC valve 3V-6
- 4 - Charging and discharging diode 3V-12
- 5, 6 Coincidence valves 3V-5 and 3V-21
- 7 - Locking generator 3V-4
- 8 - Cathode follower 3V-2
- 9 - Speed saw tooth generator 3V-1
- 10 - Valve of "memory" circuit 3V-13
- 11 - Interception relay 3R3-1
- 12 - Valve-relay and slow saw tooth limiter 3V-11
- 13 - Slow saw tooth amplifier 3V-3
- 14 - Amplifier and peak detector 3V-10.
- 15 - Searching diode limiter for maximum and AGC cathode follower 3V-22
- 15 - Comparator diode and slow saw tooth cathode follower 3V-3
- 17 - Thermocouple.

100

S-E-C-R-E-T

NO FOREIGN DISSEM

NO FOREIGN DISSEM

50X1-HUM

All the wiring is made with cable type MCG.
Resistor and condensers are fitted on two panels.
Oil paper condensers are fitted to the side walls of chassis
and fixed by screws.

The construction of unit renders the change of any item
during the use of unit on aircraft.

The unit is secured by the cover. The fixing of the unit
with cover to the frame is made by special nuts.

The frame of unit has shockabsorbers type "Lord".
To secure the chassis position relatively to the frame the
wedge fixing device is used. The unit has its own cooling by
perforated cover.

The IF amplifier is placed on the chassis with valves
upside down and fixed by spring fixing device, which let it
get into the place automatically when it is put in.

The supply of IF amplifier is brought through the junction
of special construction, which is fitted to receiver chassis
and gets the connection with socket when the receiver is put
in.

The view of the unit with cover removed and bottom view
is shown on Fig. 96 and 97.

173

S-E-C-R-E-T

NO FOREIGN DISSEM

S-E-C-R-E-T
NO FOREIGN DISSEM

50X1-HUM

VI. RECEIVER1. Destination and composition

The radio range finder SRD-1M receiver is constituted for: reflected from target pulse amplifier, separation those pulses from distortions and transformation them into the Videopulses.

Receiver consist of following items:

1. Resonance switch
2. Receiver mixer
3. Klystron heterodyne
4. I.V. preamplifier /WPCz/
5. Basic I.F. amplifier /WPCz/
5. Second detector
7. Video amplifier
8. Cathode follower
9. Pulse and noise automatic gain control /ARE/
10. Klystron heterodyne automatic frequency control /ARCz/

2. Receiver work description according to block diagram.

Receiver block diagram is shown on Fig. 99.

From aerial the reflected from target pulses are coming to the aerial switch chamber "receiver-transmitter". As an aerial switch, from reception to transmission, the resonance switch 2V-5 /RR-5/ is used. From aerial switch chamber the reflected signal energy goes to mixer chamber. As a mixer the crystal detector type DC-32 /2D-1/ is used.

The frequency of reflected signal is mixed with klystron heterodyne oscillations in the receiver mixer chamber. Klystron type K-12 /2V-4/ is used. In result of mixing process the 30 Mc/s frequency is obtained. As a load for receiver mixer the input circuit of intermediate frequency preamplifier is used /WPCz/.

From IF preamplifier, build with valves 623F /2V-8/, 2V-10 the reflected from target signal is applied to basic intermediate frequency /IF/ amplifier build with valves type

174

S-E-C-R-E-T

(NO FOREIGN DISSEM)

50X1-HUM

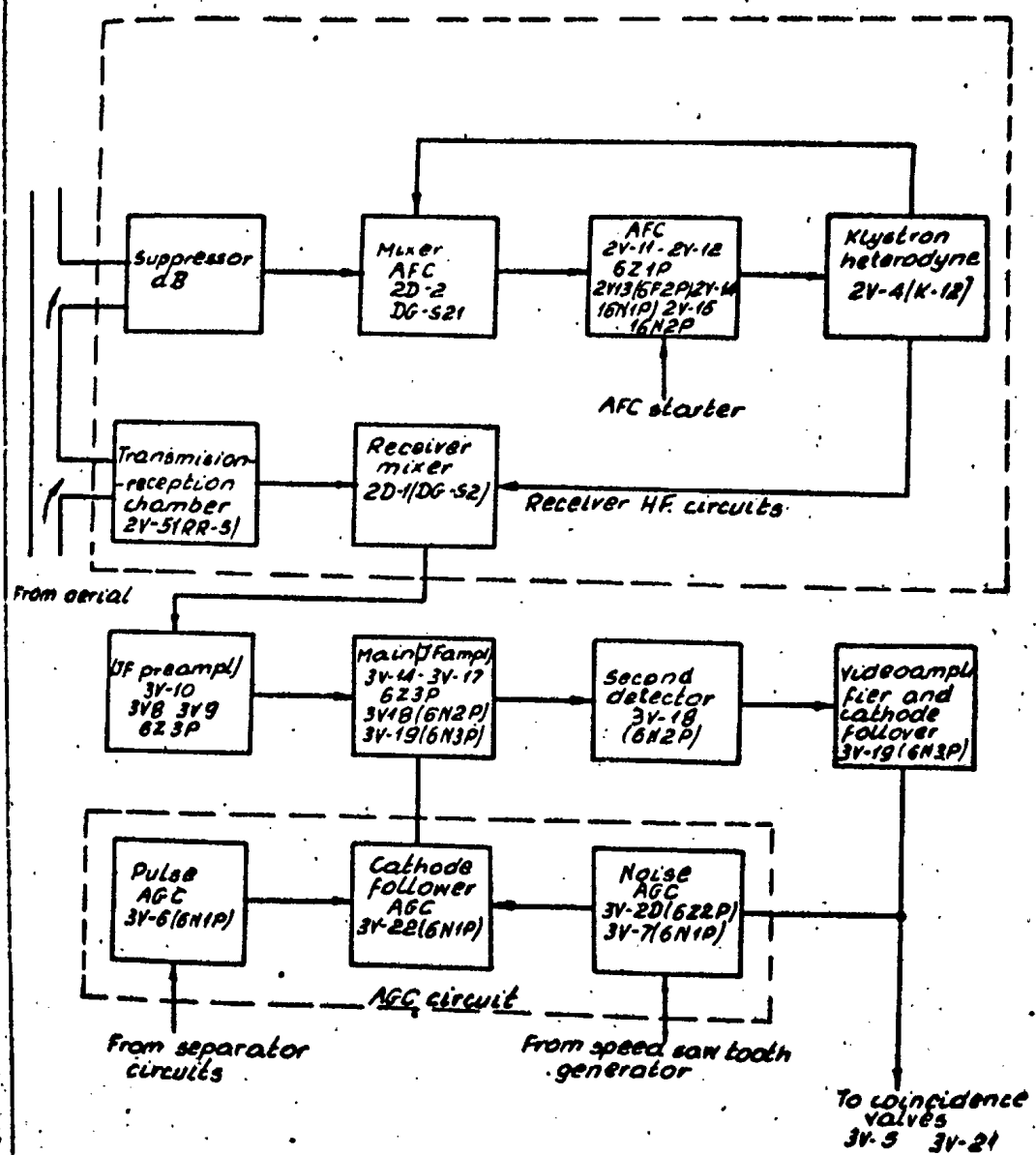

Fig 98 Receiver block diagram

NO FOREIGN DISSEM

50X1-HUM

623P /3V-14, 3V-15, 3V-16 and 3V-17/. Amplified and demodulated in second detector /3V-18/ 622P target signal is passed to coincidence valves 3V-5, 3V-1 /621P/ and to noise AGC circuit via video amplifier /left section of 3V-19 /6N3P/ and cathode follower /right section of valve 3V-19 /6N3P/.

Pulse AGC and noise AGC have common output to basic intermediate frequency amplifier via cathode follower 3V-22b /6N1P/ AFC circuit has a separate HF channel.

At the work for transmission the part of searching pulse energy goes through suppressor to AFC mixer where also the klystron heterodyne oscillations are coming.

In the input circuit of AFC we obtain the pulse which is equal to frequency difference. Due to this pulse, the AFC circuit generates the control voltage applied to klystron heterodyne.

The control voltage should be of such a value, so the klystron heterodyne frequency could be by 30 Mc/s higher than reflected signals frequency.

The working idea of receiver HF circuits and AGC circuit is accurately described in transmitter-receiver unit and range unit description.

3. Intermediate frequency amplifier.

a/ Destination and composition.

The intermediate frequency amplifier is destined for reflected signals amplification to the value necessary for driving the second detector.

The IF amplifier is built on the idea of so called triple stage mistuning and consists of IF preamplifier and IF basic amplifier.

b/ Main technical data of IF amplifier.

1. IF pass band 6 ± 1 Mc/s
2. Band pass mean frequency 30 ± 1 Mc/s
3. IF amplifier amplification factor not less than 80.000
4. Sensitivity not more than 20 μ sec.
5. Unevenness of pass band not more than 25 %

S-E-C-R-E-T

NO FOREIGN DISSEM

50X1-HUM

✓ Work description of IF amplifier according to circuit diagram.

1. General idea.

Each stage of IF amplifier is build on the idea of resonance amplifier with transformer coupling of anode and grid circuits.

The circuits of coils inductance, input or output valve interelectrode capacities and coils resistivities.

IF amplifier stages consist of two circuits with triple mistuned stages, tuned to frequencies 27, 30 and 33 Mc/s respectively.

First circuit of triple mistuned stages is displaced in stages with IF preamplifier and basic IF amplifier.

It has the amplification factor of 150 and band pass frequency of 6 Mc/s. The second circuit is displaced in stage with basic IF amplifier, has band pass frequency of 6 Mc/s and amplification factor of 600.

First circuit consists of:

1. Input tuning system to 30 Mc/s consisting of stages: triode with earthed cathode, triode with earthed grid /2V-8, 2V-9/ and circuits 2L-3, 2L-16, 2L-18.
2. Stage tuned to frequency 27 Mc/s /2V-9/ with circuit 2L-9/.
3. Stage with valve 2V-10 and circuit 3L-11 tuned to 33 Mc/s stage with valve 3V-14 and circuit 3L-1 tuned to 27 Mc/s
4. Stage with valve 3V-14 and circuit 3L-2 tuned to 33 Mc/s

Second circuit of triple mistuned stages consists of:

1. Stage with valve 3V-15 and circuit 3L-3 tuned to frequency 27 Mc/s.
2. Stage with valve 3V-10 and circuit 3L-4 tuned to 33 Mc/s
3. Stage with valve 3V-17 and circuit 3L-16 tuned to 30 Mc/s.

2. Intermediate frequency preamplifier /WPCz/

IF preamplifier is as three stage amplifier build with valves 6Z3P /2V-8, 2V-9, 2V-10/.

S-E-C-R-E-T
NO FOREIGN DISSEM

50X1-HUM

The circuit diagram of IF preamplifier is shown on Fig. 19.

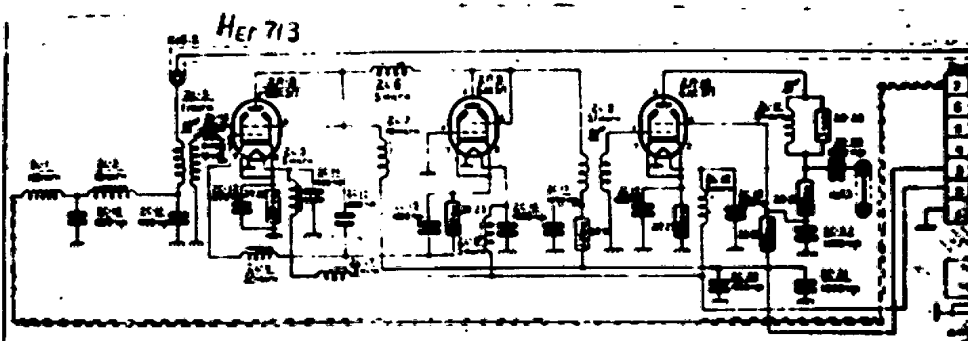

Fig. 19. Circuit diagram of IF preamplifier.

First two stages are built in circuit "triode with earthed cathode - triode with earthed grid. The third stage is a simple pentode amplifier. The shown circuit in its first two stages decreases the noise factor in the output and secures the higher stability in case of valve bounce.

The connection of valves as triodes is more advantageous because the triodes have smaller own distortions than pentodes. The circuit with earthed cathode triodes and earthed grid triodes let us obtain smaller distortions in circuit input and higher power amplification. The output of first stage is loaded by small resistivity between grid and cathode of second stage with valve 2V-9.

As a load for crystal detector, the IF preamplifier input circuit consisting of shokes 2D7-16, 2D7-13, input capacitance of valve 2V-9 and mixer shaker capacitance, is used.

178

S-E-C-R-E-T
NO FOREIGN DISSEM

S-E-C-R-E-T
NO FOREIGN DISSEM

50X1-HUM

The input circuit has a resonance frequency equal to I.F. 30 Mc/s and pass band of 15 Mc/s.

The wide pass band of input circuit is necessary for tuning stability, which could be affected by the change of crystal.

The simplified circuit of I.F. preamplifier is shown on Fig. 100.

From the input circuit the I.F. signal is applied to the control grid of valve 2V-8.

As we can see on the diagram, the first stage is build with triode, loaded by the circuit grid-cathode of next stage.

The voltage amplification factor is defined according to the sample:

$$K_1 = S_1 \cdot R_{we}$$

where: K_1 - amplification factor of first stage

S_1 - First valve characteristic inclination

R_{we} - Input resistivity of second stage.

Approximatively we can say that the input resistivity of second valve is equal.

$$R_{we} \approx \frac{1}{S_2}$$

Because first and second valves are the same /623P/ so the characteristic inclinations are also the same and the amplification factor of first stage approximately is equal 1

$$K_1 \approx 1;$$

Noise influence of second stage on common noise level of I.F. amplifier will be very small and also the possibility of first stage selfoscillations is excluded.

To remove the positive feed back coupling in valve 2V-8 by interelectrode capacity anode - grid, the neutralizing choke 2D2-4 is used. This choke with anode - grid capacity make a parallel circuit, tuned to 30 Mc/s. Such a circuit has a very big resonance resistivity for this frequency.

S-E-C-R-E-T

NO FOREIGN DISSEM

50X1-HUM

The neutralising here has no critical value, so this stage is of small amplification $k_1 \approx 1$.

The second valve 2V-9 is loaded by circuit 2L-9. This stage has typically voltage amplification character. Because of big anode - grid capacitance the positive feed back coupling in this stage is possible. To remove this possibility the neutralising choke 2L-5 is used.

This choke and anode - cathode capacitance make a parallel circuit, tuned to 30 Mc/s which has a big resonance resistivity for I.F. signals.

The stage with valve 2V-10 is loaded by circuit 2L-11 and tuned to 33 Mc/s. It is a pentode IF amplifier. For IF amplifier matching with input circuit of I.F. amplifier, the IF voltage is not brought from 2L-11 circuit but from 220 ohm resistor 2R-27. If the concentric cable was connected straight to the anode, then it would shunt the circuit with its own capacitance and the amplification factor of valve 2V-10 would be smaller than 1. With applied connection the amplification factor of this stage is equal 3.

The concentric cable is matched on the side of IF amplifier by autotransformer coupling. The part of circuit, loaded by concentric cable, has 100 ohm resistivity which is near to wave impedance of concentric cable. It is necessary for signal losses decreasing in the cable.

There is automatic grid bias applied to control grids of IF preamplifier stages /valves 2V-8, 2V-9, 2V-10/ due to the voltage drop on cathode resistors 2R-22, 2R-23, 2R-25, blocked by condensers 2C-12, 2C-15, 2C-12.

The anodes are supplied by +150 V stabilized voltage. The anode of 2V-8 is decoupled for I.F. by choke 2L-7 and condenser 2C-13.

The resistors 2R-24, 2R-25 and condensers 2C-17, 2C-22, 2C-20, 2C-21 are used for anode and screen grid circuits decoupling for HF currents /valves 2V-9, 2V-10/.

To remove the feed back coupling through filament circuits, these circuits are decoupled by filters consisting of condensers 2C-14, 2C-16, 2C-18 and chokes 2L-6, 2L-8, 2L-10, 2L-17.

181

S-E-C-R-E-T

NO FOREIGN DISSEM

NO FOREIGN DISSEM

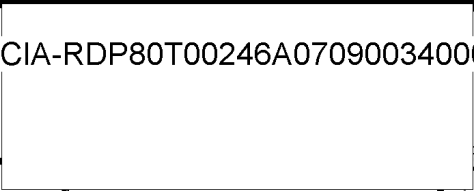

50X1-HUM

Chokes 2D1-1, 2D1-2, and condensers 2C-10, 2C-11 make the pass filter for alternating component of basic signal crystal current circuit.

The IF signal amplified in IF preamplifier is applied to 1F. basic amplifier from dividing condenser 2C-23 via concentric cable.

The frequency characteristic of first circuit with triple mistuned stages is shown on Fig. 101.

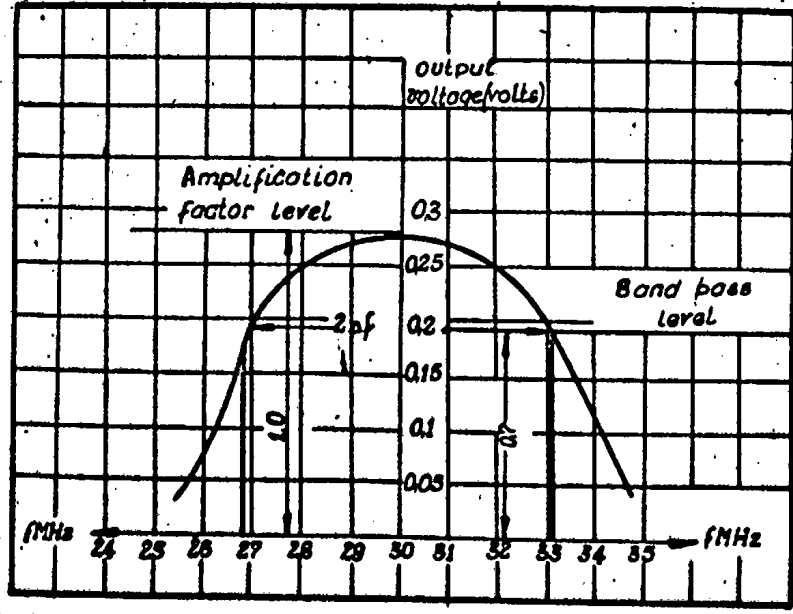

Fig. 101. Frequency characteristic of first circuit with triple mistuned stages.

S-E-C-R-E-T

NO FOREIGN DISSEM

S-E-C-R-E-T
NO FOREIGN DISSEM

50X1-HUM

3. Basic IF amplifier.

The IF signals are applied from preamplifier to IF amplifier, consisting of four stages, built with valves, 6Z3P, 3V-14, 3V-15, 3V-16, 3V-17. It is a typical resonance amplifier with one circuit tuned.

The series supply system is applied for anode circuits. The circuit diagram of IF amplifier is shown on Fig. 102.

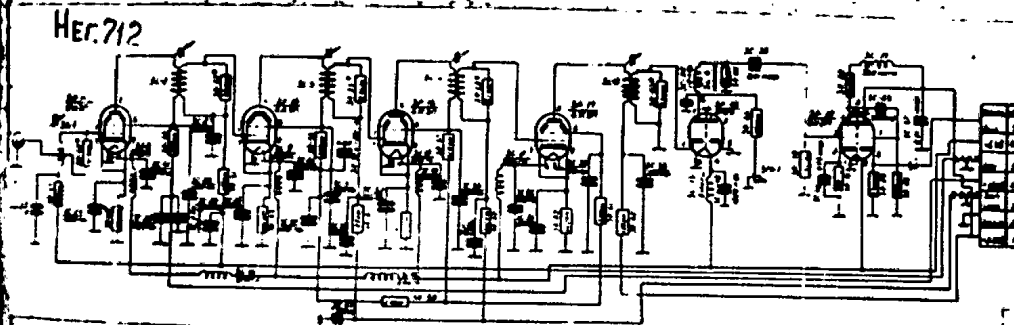

Fig. 102. Circuit diagram of IF amplifier.

The circuit 3L-1 is tuned to 27 Mc/s.

Resistor 3R-52 is a shunt resistance for widening of circuit pass band.

In the anode circuits of valves 3V-14, 3V-15, 3V-16, 3V-17 there are circuits 3L-2, 3L-3, 3L-4, 3L-15 tuned to frequencies 33, 27, 33, 30 Mc/s respectively.

Valve control grid bias voltage is obtained from voltage drop on cathode resistors 3R-49, 3R-53, 3R-55, 3R-60.

These resistors are blocked for IR by capacitors 3C-24, 3C-29, 3C-32 and 3C-34.

For anode circuits HF decoupling the following resistors

S-E-C-R-E-T
NO FOREIGN DISSEM

NO FOREIGN DISSEM

50X1-HUM

and condensers are used: 3R-50, 3C-26, 3C-25, 3R-54, 3C-31, 3C-30, 3R-57, 3C-33, 3R-61, 3C-35, 3R-62, 3C-36.

For Filament circuits HF decoupling the following chokes and condensers are used: 3D1-8, 3C-41, 3D1-14, 3D1-5, 3C-43, 3D1-15, 3D1-10, 3C-44, 3D1-11, 3C-45.

Resistors 3R-48, 3R-52, 3R-55, 3R-58, 3R-63 connected in parallel to each circuit serve for pass band widening.

These resistors are matched in such a way at the tuning, that each stage should give necessary amplification at the constant pass band.

Figures 103 and 104 represent frequency characteristics for second stage of triple stages mistuning and for complete IF amplifier /WPCz and WPCz/.

AGC of IF amplifier is obtained by negative voltage application from range unit to control grids of valves 3V-14 and 3V-15.

Resistors 3R-47, 3R-61 and condenser 3C-23, 3C-27, 3C-29 are used as filters for HF currents.

During the HF pulse radiation, part of its energy comes to receiver input due to aerial switch inactivity. This energy overloads the last stages of IF amplifier. To remove this phenomenon two last stages with valves 3V-16, 3V-17 are blocked by negative pulse, applied to control grids from transmitter-receiver unit. This negative pulse blocks two last stages of IF amplifier during the acting of probe pulse.

Detector and videoamplifier.

IF signals demodulation is done by diode detector build with left section of valve 3V-18 /6H2P/.

The basic advantages of diode detector are its characteristic linearity and impossibility of overloading it by strong signals.

The circuit diagram of diode is shown on Fig. 105.

The IF signal voltage from circuit 3L-16 is applied to the diode cathode.

On the detector load resistor 3R-65 the rectified negative video signal voltage is obtained which via pass circuit

S-E-C-R-E-T

NO FOREIGN DISSEM

50X1-HUM

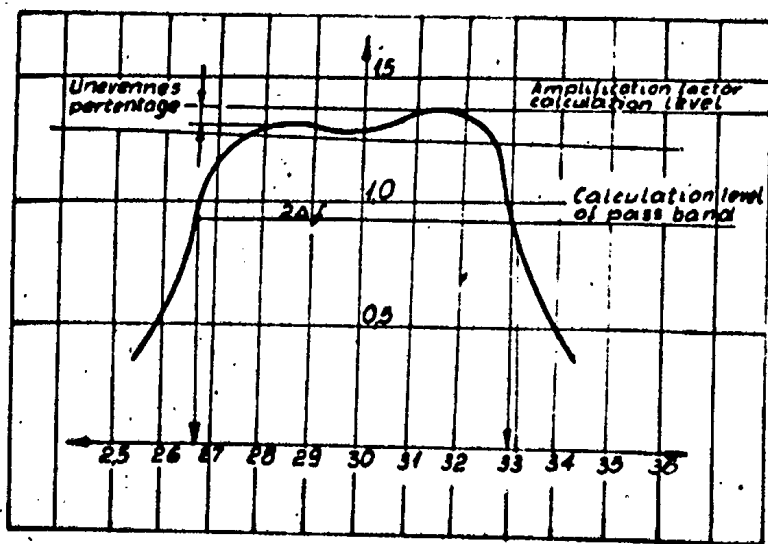

Fig. 103. Frequency characteristic of a circuit with triple stages.

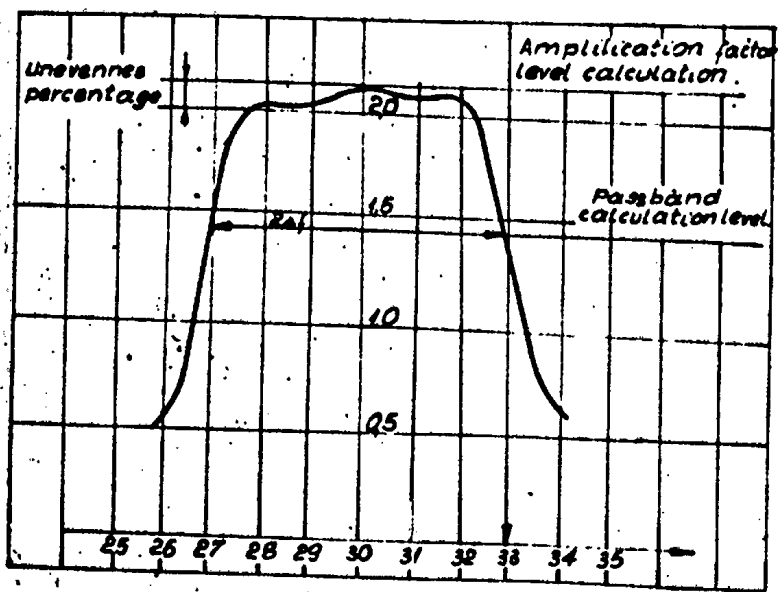
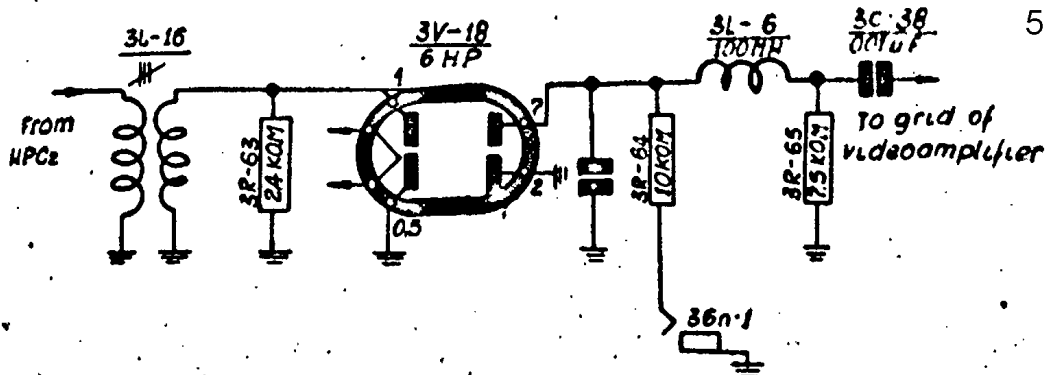

Fig. 104. I.F. amplifier frequency characteristic.

185

S-E-C-R-E-T
NO FOREIGN DISSEM



50X1-HUM

Fig. 105. Diode detector circuit diagram.

3C-38, 3R-75 is applied to the grid of video amplifier. This is made with valve 3V-19. The choke 3L-6 has a big resistivity for IF currents and will not pass the IF component to video amplifier input.

The pass circuit 3C-38, 3R-75 does not pass the long lasting distortions to video amplifier input.

This ordinary differential circuit has a big time constant about 5000 μsec.

Modulated pulses are amplified in video amplifier, build with left section of valve 6N3P / 3V-19/ see Fig. 106

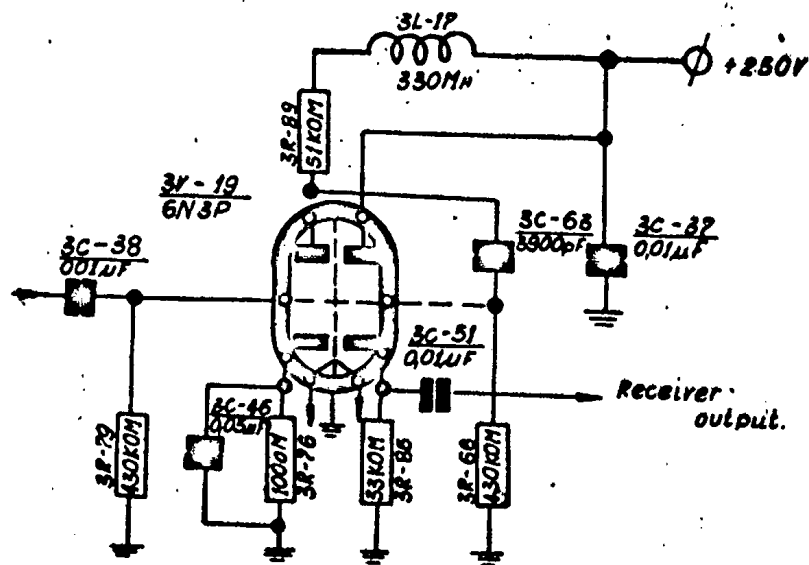

Fig. 106. Video amplifier and cathode follower.

NO FOREIGN DISSEM

50X1-HUM

The basic demands for videoamplifier stages are: wide band pass and minimum time of voltage accrescence.

Accrescence time decreasing in the stage we obtain by stages load resistances decreasing and shunting capacities.

The shunting can be decreased below the certain value defined by input and output valves capacity and wiring capacity. Load resistance decreasing causes amplification factor decreasing.

That is why in videoamplifier stages acceleration circuits of voltage accrescence are used. /correction circuit/

In given videoamplifier the frequency characteristic correction is done by inductance 3L-17.

The amplification factor of our videoamplifier is about 14 at pass band about 1,5 Mc/s.

The amplified videopulse is applied to cathode follower via dividing condenser 3C-63. The cathode follower circuit is made with right section of valve 3V-19 /6N3P/ see Fig.106.

The cathode follower is necessary for videoamplifier output was not shunted by coincidence valves.

From cathode follower the videosignal is applied to control grids of coincidence valves.

Receiver construction.

The IF amplifier is build in two units: IF preamplifier unit and IF amplifier /Fig. 107/ IF preamplifier unit is situated in transmitter-receiver unit and IF amplifier in range unit.

To obtain the maximum signal to noise proportion there is necessary that the IF amplifier should be placed near to crystal mixer. That is why such a displacement is used. Because the transmitter-receiver unit with its crystal mixer is of small size, it would be very difficult to put it all the IF amplifier.

That is why it is divided into two units: 2WPCz and WPCz IF amplifier and preamplifier are connected between themselves with two meter long HF cable EK-44, consisting of two parts, connected to each other with HF. hermetic junction.

S-E-C-R-E-T

NO FOREIGN DISSEM

S-E-C-R-E-T
NO FOREIGN DISSEM

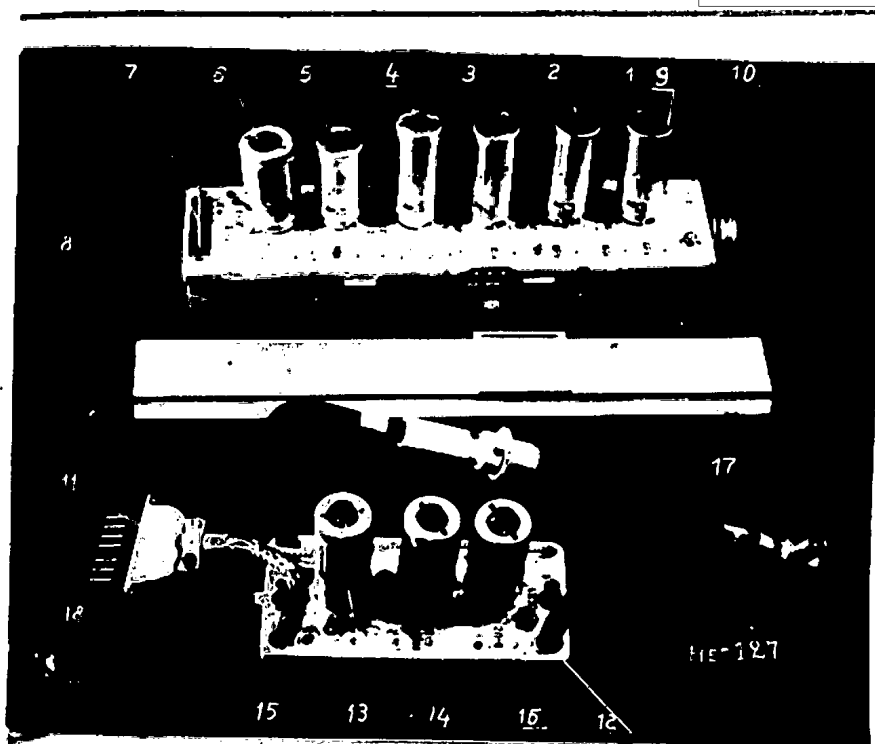

Fig. 107. General view of IF preamplifier and IF amplifier units.

- 1 - Valve 3V-14
- 2 - " 3V-15
- 3 - " 3V-16
- 4 - " 3V-17
- 5 - " 3V-18
- 6 - " 3V-19
- 7 - Supply socket
- 8 - Bottom case
- 9 - Screen
- 10 - HF. junction
- 11 - Supply socket
- 12 - Chassis WPCz
- 13 - Valve 2V-10
- 14 - " 2V-9
- 15 - Bottom case
- 16 - Valve 2V-8
- 17 - RF cable and junction
- 18 - Chassis fixing bolt

189

S-E-C-R-E-T

NO FOREIGN DISSEM

50X1-HUM

The fixing of IF amplifier units to the unit common chassis is done by clamp bolts.

The IF preamplifier unit is fixed to the transmitter-receiver chassis by unremoveable screws.

The input of IF amplifier is made in form of HF junction and is fixed to the side wall of unit.

It is connected with HF cable through concentric junction, placed on front panel of range unit.

The use of such an input decreases the number of cables for connection IF amplifier and preamplifier.

The supply for the units is brought via 7 pin socket. The passing insulators are also used as control points.

For IF amplifier tuning purpose, the two pin socket is used, to which the voltmeter of high resistance is connected by cable with bolt plugs at each end.

On the covers of IF amplifier and preamplifier there are holes of 8 mm diameter situated just opposite coil cores of each circuit.

Beside that at each hole, there is a number corresponding to circuit frequency tuning. Using these holes the receiver can be tuned without cover removing.

The covers are fixed to chassis by spring buttons. The side walls of covers are covered by enamel or insulation varnish to secure the circuit elements before connection to earth.

To increase the IF amplifier work stability there is foreseen:

1. Screening is done on the inner side of chassis.
2. Chassis and covers are silver plated.
3. The use of buttons making good contacts to all side surfaces between the chassis and cover.

IF amplifier is placed in range unit with valves upside down. In this situation there is no necessity to remove the unit, but to take the cover off for service.

The valve screens are not only screening the valves, but also pressing them down into the sockets making good pin contacts. It is necessary for airborne apparatus.

S-E-C-R-E-T

NO FOREIGN DISSEM

S-E-C-R-E-T
NO FOREIGN DISSEM

50X1-HUM

Because the valve sockets are fixed stiff to the chassis, they are unremovable during the service.

The screen base is fixed to the chassis by electrical rivets.

The view of IF amplifier and presampler is shown on Fig. 108 and 109.

150

S-E-C-R-E-T
NO FOREIGN DISSEM

S-E-C-R-E-T
NO FOREIGN DISSEM

50X1-HUM

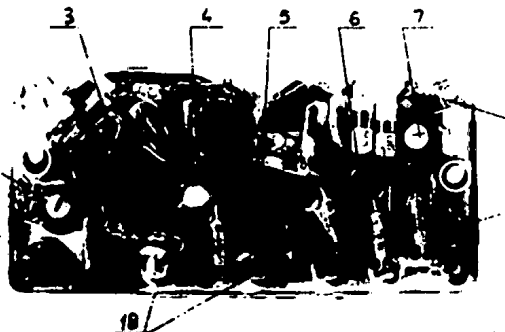

Fig. 108. The bottom view of IF preamplifier.

- 1 - HF output
- 2 - Induction coil 2L-11
- 3 - Valve 2V-10
- 4 - Induction coil 2L-9
- 5 - Valve 2V-9
- 6 - " 2V-8
- 7 - Induction coil 2L-3
- 8 - HF input
- 9 - Choke 2P-1
- 10 - Control points

S-E-C-R-E-T

NO FOREIGN DISSEM

S-E-C-R-E-T
NO FOREIGN DISSEM

50X1-HUM

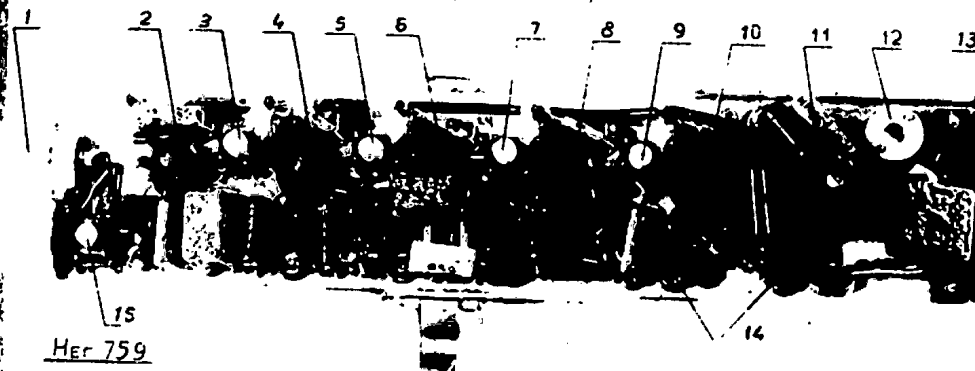

Fig. 108: Bottom view of IP amplifier.

- 1 - HF junction
- 2 - Valve 3V-14
- 3 - Induction coil 3L-2
- 4 - Valve 3V-15
- 5 - Induction coil 3L-3
- 6 - Valve 3V-16
- 7 - Induction coil 3L-4
- 8 - Valve 3V-17
- 9 - Induction coil 3L-16
- 10 - Valve 3V-18
- 11 - " 3V-19
- 12 - Socket 3GN-1
- 13 - Supply socket
- 14 - Control points
- 15 - Induction coil 3L-1

S-E-C-R-E-T
NO FOREIGN DISSEM

NO FOREIGN DISSEM

50X1-HUM

POWER SUPPLY UNIT1. Destination - Main technical data

The power supply unit serves: for supplying the anode, grid and heater circuits of the electronic tubes of the range unit, for supplying the cathode, grid and heater circuits of the ARCz /automatic frequency control/ unit, for supplying the anodes of the submodulator and of the heterodyne control electrode, the anodes and screen grids of WPCz /intermediate frequency pre-amplifier/ of the transmitter-receiver unit and also for the switching on the high voltage of the radio range finder.

The power supply unit supplies the following voltages:

a/ to the transmitter-receiver unit

- 1.- D.C. voltage +400 V $\pm 10\%$ /not stabilised/
Output current 1,2 mA
- 2.- D.C. voltage +250 V $\pm 2,5$ V /stabilised/
Output current 40 mA
- 3.- D.C. voltage +150 V $\begin{matrix} +10\% \\ -5\% \end{matrix}$ /stabilised/
Output current 40 mA
- 4.- D.C. voltage -150 V $\begin{matrix} -10\% \\ +5\% \end{matrix}$ /stabilised/
Output current 5 mA

b/ to the range unit

- 1.- D.C. voltage +250 V /stabilised/
Output current 40 mA
- 2.- D.C. voltage +150 V $\begin{matrix} +10\% \\ -5\% \end{matrix}$ /stabilised/
Output current 40 mA
- 3.- D.C. voltage -150 V /stabilised/
Output current 5 mA
- 4.- A.C. voltage 6,3 V $\pm 10\%$
Output current 8 A

c/ to the ASP - 4R gun-sight

- 1.- D.C. voltage +250 V /stabilised/ for supplying the computing arrangement of the gun sight. Output current 42 mA.

- 18 -

S-E-C-R-E-T

NO FOREIGN DISSEM

NO FOREIGN DISSEM

50X1-HUM

2. The block diagram of the power supply unit.

The functional circuit of the power supply unit consists of 5 basic elements /see Fig. 110/

- 1.- Rectifier +400 V
- 2.- Rectifier - 250 V
- 3.- Voltage stabilizers: +150 V, +150V, - 150 V.
- 4.- Voltage stabilizer + 250 V
- 5.- The unit for switching on the high voltage to the radio range finder.

The block diagram of the power supply unit is given in Fig. 110.

The 115 V 400 c/s A.C. voltage is fed to the primary winding of the mains transformer 4 Tr-1. From the secondary winding the following voltages are taken:

360 V - to the rectifier + 400 V which consists of two kenotrons, type 4V-1, 4V-10 /5C9S/ and a filter, type TT /4D2-1, 4C-1, 4C-2/;

250 V - to the rectifier - 250 V consisting of a kenotron type 4V-2 /6C4P/ and filter type TT /4D2-2, 4C-3, 4C-8/

The rectified voltage + 400 V is fed to the electronic stabilizer + 250 V which consists of a "resistance" stabilizer 4V-8 /SG3S/, control tube 4V-4 /6N2P/ and regulating tubes 4V-3, 4V-9 /6P3S/. The output voltage of the stabilizer + 250 V is fed to the transmitter-receiver unit, range unit and to the computing circuit of the ASP-4N gunsight.

Apart from that, the rectified voltage + 400 V is fed to the voltage stabilizer + 150 V operating with a 4V-7 /SG1P/ valve, and a voltage stabilizer + 150 V operating with a 4V-6 /SG1P/ valve. The first voltage stabilizer supplies the W.P.Cz valves of the range unit and the second one the WPCz valves of the transmitter-receiver unit. /WPCz = intermediate frequency amplifier/.

The rectified voltage - 250 V is given to the voltage stabilizer - 150 V built on a 4V-5 /SP1P/ valve, the output of which supplies the transmitter-receiver and range units.

The voltage stabilizers /4V-5, 4V-6, 4V-7, 4V-8/ assure the constancy of the output voltage not only during variation

S-E-C-R-E-T

NO FOREIGN DISSEM

NO FOREIGN DISSEM

50X1-HUM

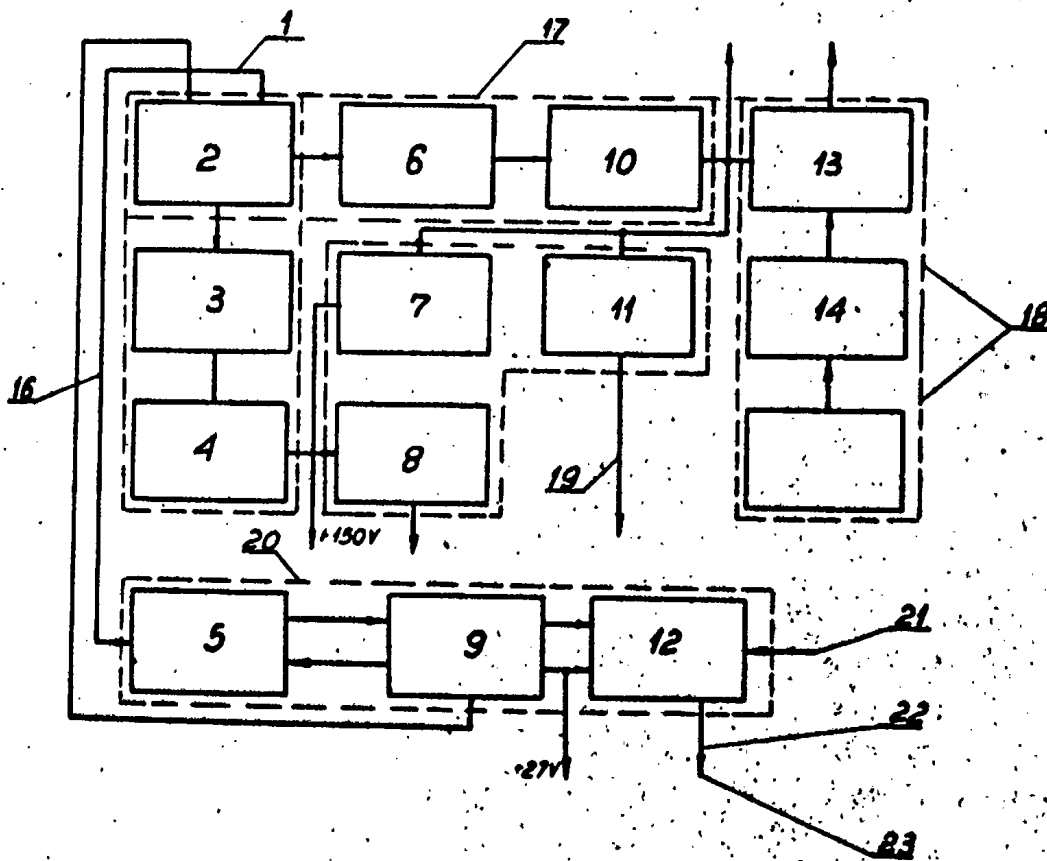

Fig. 110. Block diagram of the power supply unit.

S-E-C-R-E-T
NO FOREIGN DISSEM

NO FOREIGN DISSEM

50X1-HUM

- 1 - 115 Volts A.C. 400 c/s
- 2 - 4Tr-1 mains transformer
- 3 - 6C4P /4V-2/ rectifying valve
- 4 - filter type 4DT-2, 4C-8, 4C-3
- 5 - 4TrL-1 thermo-relay
- 6 - 5C9S /4V-1; 4V-10/ rectifying valves
- 7 - 4V-6 /SG-1P/ voltage regulator + 150 Volts
- 8 - 4V-5 /SG-1P/ " " " "
- 9 - 4RL-1 relay
- 10 - 4DT-1, 4C-1, 4C-2 filter
- 11 - 4V-7 /SG-1P/ voltage regulator + 150 Volts
- 12 - 4HL-2 relay
- 13 - regulating valves type 4V-3, 4V-9 /5P3S; 6P3S/
- 14 - control valve type 4V-4 /6K2P/
- 15 - 4V-8 /SG3S/ blocking voltage
- 16 - 230 Volts rectifier
- 17 - + 400 Volts rectifier
- 18 - electronic stabilization
- 19 - voltage ionic stabilisation /regulation/
- 20 - high voltage switch
- 21 - " " " "
- 22 - 115 Volts A.C. 400 c/s
- 23 - to the receiver-transmitter unit.

- 196 -

S-E-C-R-E-T

NO FOREIGN DISSEM

NO FOREIGN DISSEM

50X1-HUM

of input voltage but also during changes of output load.

The electronic voltage stabilization assures high stability of the +250 V voltage.

Due to mains voltage increase or drop, owing to load current decrease or increase, the output voltage of the ionic voltage regulator increases a little or drops, causing thus the increase or drop of the 4V-4 control valve negative grid bias. It causes increase or drop of the 4V-3, 4V-9 control valves grid bias.

Then, the regulating valves resistance drop or increase occurs and their voltage drop increases or decreases.

The voltage drop on the regulating valves increases or decreases according to the output voltage increase or drop.

At the moment of range finder switching on, the +27 V. D.C. voltage is fed to the contact points of the 4TR1-1 relay and to the terminals of the 4R1-1 electromagnetic relay. Simultaneously a 115 Volts A.C. 400 c/s is fed to the 4TR1-1 thermo-relay coil through the 4R1-1 relay contact points as well as to the contact points of the 4R1-2 electromagnetic relay.

After 1,5 min the thermo-relay starts and switches on the 4R1-1 relay /which, alternately, disconnects the supply of the 4TR1-1 thermo-relay winding/.

After a new 1,5 min period the thermo-relay opens its contact points and closes the +27 V.D.C. circuit with the 4R1-2 relay winding. If the "wysokie napięcie" switch /high voltage/ is on, the A.C. 115 V. 400 c/s voltage is fed to the primary winding of the 2Tr-1 high voltage transformer of the transmitter-receiver unit.

3. Component parts of the power supply unit circuit.

The main block diagram of the power supply unit is represented in Fig. 125.

a/ 400 Volts rectifier

The +400 Volts rectifier consists of following parts.

- 4Tr-1 by-pass transformer
- two 5CS S /4V-1; 4V-10/ kenotrons

S-E-C-R-E-T

NO FOREIGN DISSEM

NO FOREIGN DISSEM

50X1-HUM

- smoothing filter II, which consists of a 4DT-1 choke and two 4C-1; 4C-2 condensers.

The 400 Volts rectifier is built according to the full - wave rectification circuit. Its block diagrams is shown in Fig. 111.

At the moment of the supply voltage 115 V.A.C. 400 c/s feeding to the transformer primary winding, a 360 Volts /approx./ voltage is taken from the secondary winding, then, it is fed to the kenotrons' anodes.

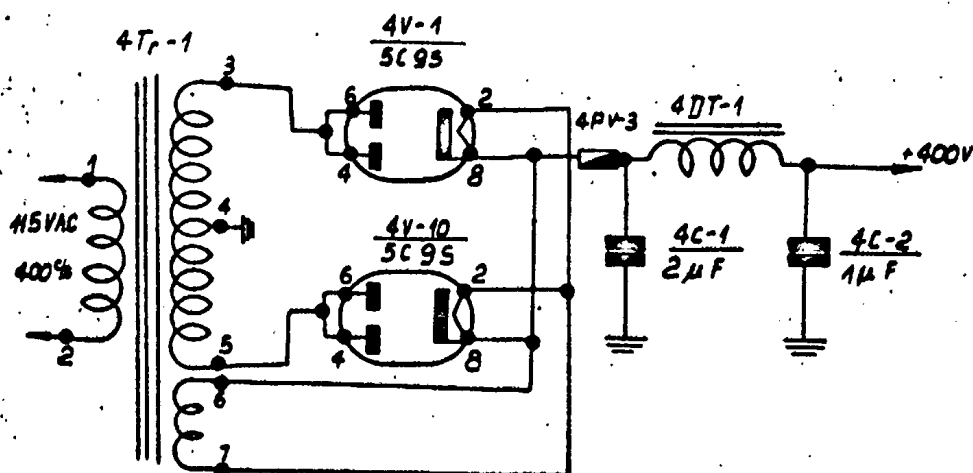

Fig. 111. Block diagram of the + 400 Volts rectifier.

The kenotrons have an one-direction conductance /from anode to cathode/ only. Owing to this fact the current of each half-section of the transformer secondary winding /with centre terminal/ can be driven-only during $\frac{1}{2}$ cycle of the A.C. 115 Volts 400 c/s voltage. The current of both sections

- 198 -

S-E-C-R-E-T

NO FOREIGN DISSEM

NO FOREIGN DISSEM

50X1-HUM

of the transformer secondary winding is displaced in time by a $\frac{1}{2}$ cycle. The current of the R_n load is driven in one direction only. During the positive half-cycle of the A.C. 115 Volts 400 c/s voltage /Fig. 112a/ the 4V-1 kenotron anode current is positive too /Fig. 113 b/. Therefore, the current pulse /Fig. 112 g/ will be driven through the following circuit:

- transformer secondary winding /4-3 terminals/
- 4V-1 valve internal resistance
- smoothing filter type 4D \bar{x} -1; 4C-1; 4C-2.
- load R_n

The filter condensers are charged during the first $\frac{1}{2}$ cycle and the choke accumulates the energy of the magnetic field.

Then the condensers discharge on the R_n load, while the condensers discharging time constant is greater than their charging time constant.

When the current driven through the 4D \bar{x} -1 choke decreases, the magnetic field, which accumulated in the choke decays, but there is a tendency to keep the load current valve stable /self-inductance phenomenon/. During the negative half-cycle of the A.C. 115 Volts 400 c/s voltage, the voltage on the 4V-10 kenotron anode is a positive one /Fig. 112c/, therefore, the current pulse /Fig. 112e/ passes through the following circuit: secondary winding of the transformer /terminals 4-5/, internal resistance of the 4V-10 valve, smoothing filter, load R_n . The filter condenser charging begins at the moment when the voltage in point A exceeds the voltage on filter condensers. The discharging /in R_n load/ begins at the moment when the maximum of the first negative half cycle of the A.C. 115 Volts 400 c/s voltage is reached. /Fig. 112a/.

The operation of the filter choke is analogous to the case of positive half-cycle of the A.C. 115 V 400 c/s voltage. During the second positive half-cycle of the A.C. 115 Volts 400 c/s voltage, the filter condensers begin to be charged when the voltage in point A exceeds the voltage on filter condensers and the discharging /in R_n load/ begins at the

S-E-C-R-E-T

NO FOREIGN DISSEM

50X1-HUM

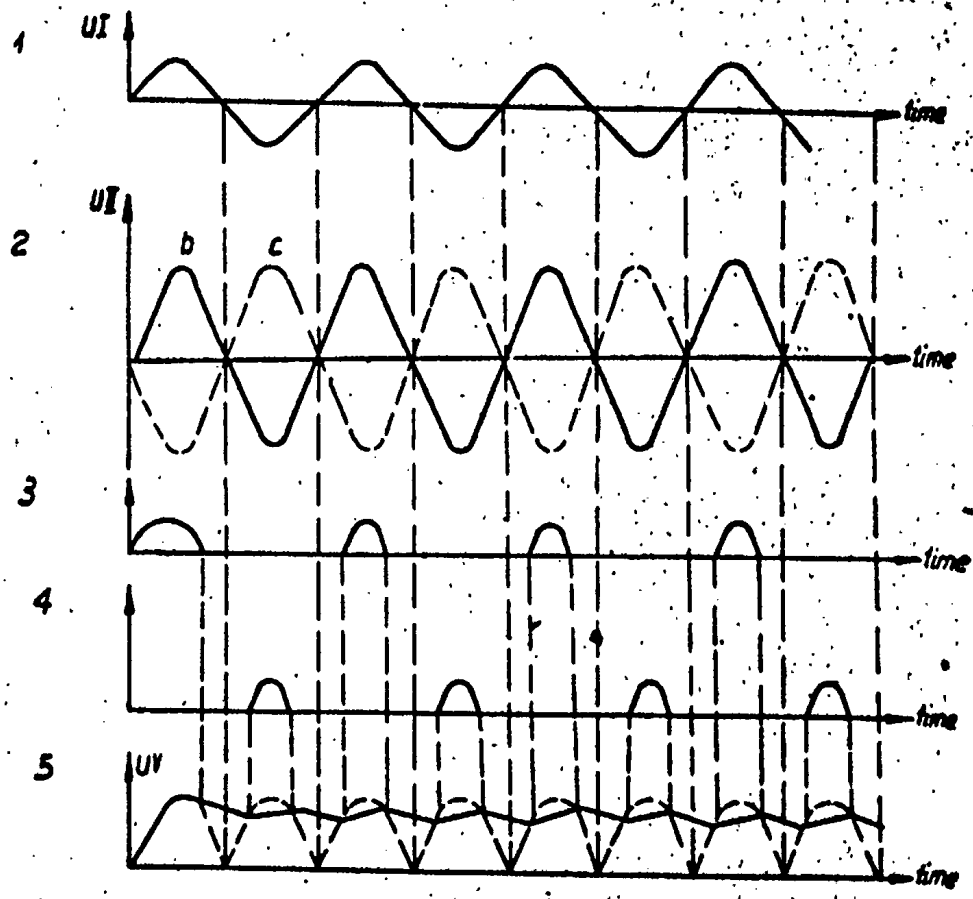

Fig.. 112. Currents and voltages in the +400 Volts rectifier circuits.

- 1 - Mains voltage A.C. 115 Volts 600 c/s /a/
- 2 - Voltage on the rectifying valves anodes /b-c/
- 3 - Current of the rectifying valve /d/
- 4 - " " " " /e/
- 5 - rectified voltage /f/

S-E-C-R-E-T
NO FOREIGN DISSEM

NO FOREIGN DISSEM

50X1-HUM

moment when the maximum of the second positive cycle of the A.C. 115 Volts 400 c/s is reached, and so on.

During the negative half cycle of the A.C. 115 V 400 c/s voltage /Fig. 112 a/ the current pulse /Fig. 112 g/ is driven through the following circuit: transformer secondary winding /terminals No 4 and 5/, internal resistance of the 4V-1C valve, 4D1-1 choke winding and R_n load.

The filter condensers begin to be charged when the voltage in point A exceeds the voltage on filter condensers. The discharging will begin at the moment coinciding with the maximum of the first negative voltage cycle. /Fig. 112a/

The choke filter operation is analogous to the case of positive half cycle of the A.C. 115 Volts 400 c/s voltage.

So, the voltage in point A /Fig. 112e/ in the filter output will not differ practically from the direct voltage.

The heating /filament/ voltage of the +400 Volts rectifier valves is taken from the additional secondary winding of the transformer /terminals No 6-7/.

The anodes of each kenotron are inter-connected in order to reduce the power loss on the anodes at greater load.

b/ - 230 V voltage rectifier.

The - 230 V voltage rectifier is built according to the full-wave rectification circuit /Fig. 113/ It consists of a 4 Tr-1 transformer, a 6C4P /4V-2/ kenotron, smoothing filter type II which is formed by a 4D1-2 choke and two 4C-3; 4C-8 condensers.

Moreover, a 150 mA fuse type 4Pr-2 is included to the circuit of the kenotron cathode.

The operation of the - 230 V voltage rectifier is the same as the + 400 Volts rectifier operation with a sole difference that the filter condensers are charged from the centre terminal of the transformer winding.

The heating /filament/ voltage of the - 230 Volts rectifier valves is taken from the additional secondary winding of the transformer /terminals No 8-9/.

S-E-C-R-E-T

NO FOREIGN DISSEM

NO FOREIGN DISSEM

50X1-HUM

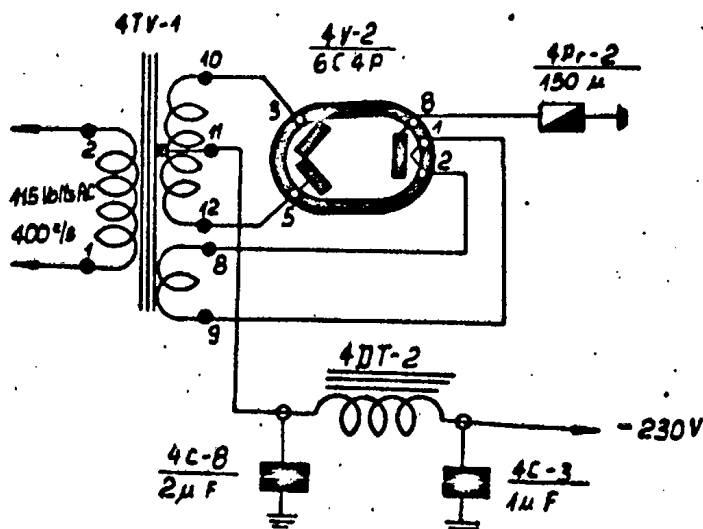

Fig. 113. Circuits of the - 230 Volts rectifier.

Ionic stabilization /voltage regulation/

The voltage regulators provided with a non-linear resistance allow to reduce the output voltage oscillations as compared to the oscillations of the input voltage.

Such a non-linear resistance should have a part of volt-ampere characteristic curve, corresponding to voltage drop, which depends, a little only, on the current driven through this non-linear element. /Fig. 114; curve AB/

The non-linear resistance with the described volt-ampere characteristic is connected in series with the regulated /stabilised/ voltage source and on additional real resistivity /Fig. 115/

The useful load should be connected parallel with stabilising element. If the value of U_1 voltage varies, the current driven through the resistance R and the stabilising element varies too, while the voltage on the load is the same.

S-E-C-R-E-T

NO FOREIGN DISSEM

50X1-HUM

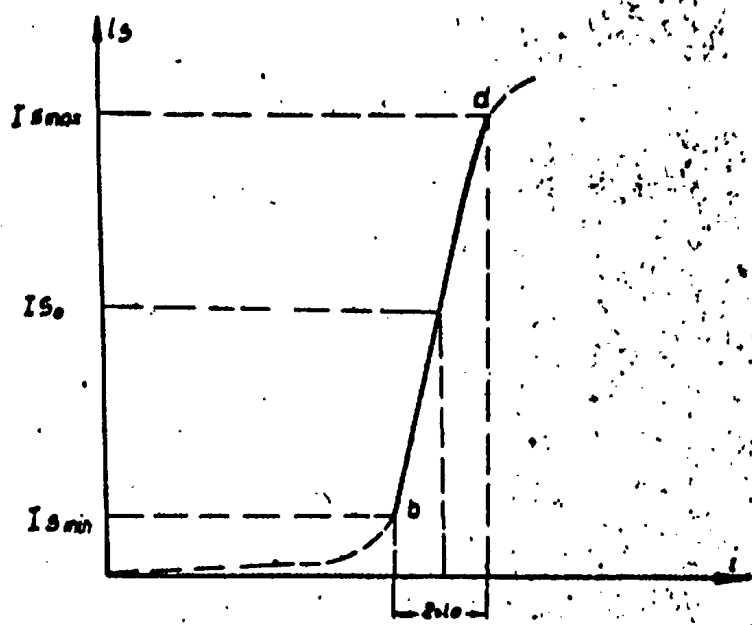

Fig. 114. The volt-ampere characteristic of the non-linear resistance.

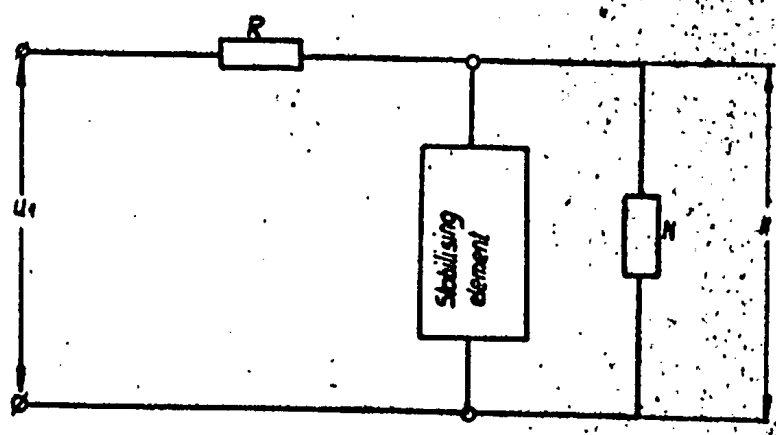

Fig. 115. Wiring diagram illustrating the connection of the non-linear resistance.

50X1-HUM

If the value of the load R_n varies, the value of current driven through the resistance R remains the same, however, the distribution of current between the stabilizing element and the load varies too, while the voltage U_n is a constant one as in the former case.

The gas-filled valves are used as stabilizing elements, since their volt-ampere characteristic curve has a considerable slope.

The parameters of the voltage regulator are chosen and set so that the voltage on the regulator's input is sufficient to involve the regulator's ignition at the moment of switching on.

c/ The +150 Volts ionic voltage regulator for supplying the valves of the WPCz and ARCz:

/WPCz = intermediate frequency pre-amplifier; ARCz = automatic frequency control/.

The ionic voltage regulator for +150 Volts operates with a 4V-6 valve /SG-1P voltage regulator/ See Fig. 116.

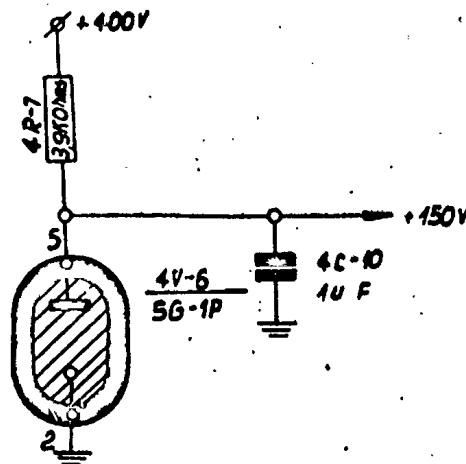

Fig. 116. The +150 V ionic voltage regulator for supplying the valves of the intermediate frequency pre-amplifier and the automatic frequency control circuit.

NO FOREIGN DISSEM

50X1-HUM

The voltage regulator is a neon lamp with large surface electrodes. The increase of electrodes surface enlarges the operational range of the voltage regulator's characteristic, which corresponds to a normal ignition /gliminz/.

Till the operational point lies on the volt-ampere curve steep slope, the voltage on the load is approximately constant regardless to reason of current variation, that is, of the current which is taken from the direct voltage source supplying the +150 V. voltage regulator circuit.

If the load resistance R_n increases or drops, the current which is driven through the 4R-7 resistor remains constant, but the distribution of currents between the stabilising element and the load varies, while the +150 V. output voltage remains constant as in the preceding case.

The 4R-1 resistor is a load resistance of the SG1P /4V-6/ voltage regulator.

4/ +150 V. ionic voltage regulator for supplying the
WPCz valves /WPCz = intermediate frequency amplifier/.

The ionic voltage regulator for supplying the valves of the intermediate frequency amplifier is formed by means of a AG1P /4V-7/ valve. /see Fig. 117/

The operation principle of this voltage regulator is the same as the operation of the above-described voltage regulator for supplying the valves of the intermediate frequency pre-amplifier and the automatic frequency control circuit.

Both voltage regulator are supplied from the same +400 Volts mains.

The 4R-8 resistor is a load resistance of the 4V-7 voltage regulator.

S-E-C-R-E-T

NO FOREIGN DISSEM

D-E-C-R-E-T
NO FOREIGN DISSEM

50X1-HUM

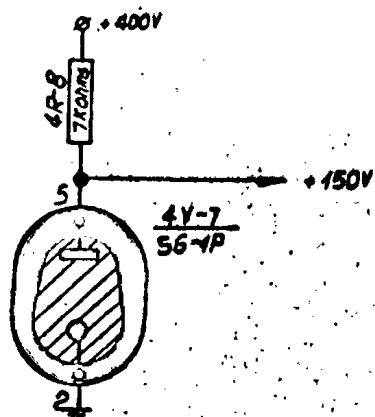

Fig. 117. The +150 V ionic voltage regulator

e/ +105 V ionic voltage regulator.

The ionic voltage regulator for +105 Volts is formed by means of a 6G3S /4V-8/ valve. It serves for electronic /ionic/ stabilization of voltage /See Fig. 118/.

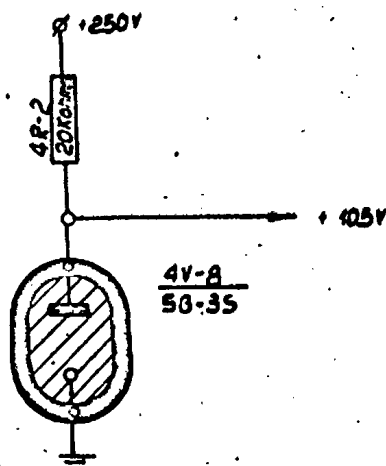

Fig. 118. The +105 Volts ionic voltage regulator.

- 206 -

S-E-C-R-E-T

NO FOREIGN DISSEM

NO FOREIGN DISSEM

50X1-HUM

The operation of this voltage regulator is the same as the operation of previously described voltage regulators. The +105V voltage regulator is supplied from the +250 Volts mains. The 4R-2 resistor is the load resistance of the voltage regulator.

f/ - 150 Volts ionic voltage regulator

The -150 Volts ionic voltage regulator is formed by means of a 5G1P /4V-5/ valve. It serves for supplying the range unit and the ARCs /automatic frequency control/ circuit /see Fig. 119/.

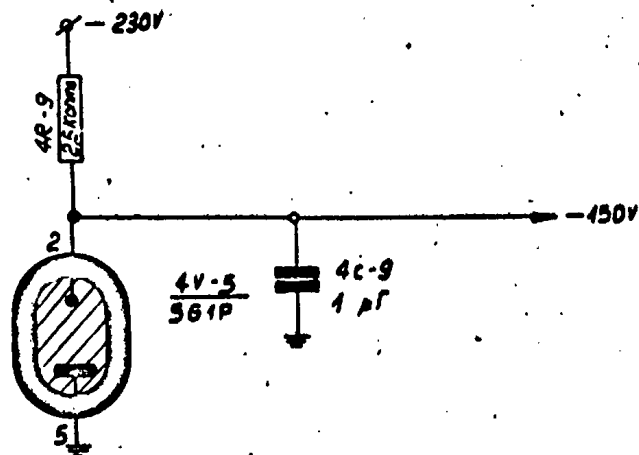

Fig. 119. The -150 Volts ionic voltage regulator.

The operation of the -150 Volts ionic voltage regulator is the same as the operation of above-described voltage regulators with a sole difference that in this case the voltage regulator anode is grounded while its cathode is connected to the -230 Volts rectifier by means of a load resistance 4R-9. A 4C-9 capacity is connected in order to improve the filtration.

- 207 -

S-E-C-R-E-T

NO FOREIGN DISSEM

NO FOREIGN DISSEM

50X1-HUM

Electronic stabilization of +250 V voltage /voltage ionic regulation/.

The electronic /ionic/ voltage regulator consists of regulating valves type 4V-3 and 4V-9 /6P3S/, control valve type 4V-4 /6N2P/, ionic 4V-8 /6G3S/ regulator, which is a source of the +10⁵ reference voltage, voltage dividers formed by 4R-3; 4R-4; 4R-5 and 4R-6 resistors. The voltage regulator's block diagram is illustrated in Fig. 120.

The operation principle of the ionic /electronic/ voltage regulator can be determined as follows:

If the input voltage of the regulator increases, due to mains voltage increase or owing to current drop in load R_n , the output voltage of the voltage regulator increases.

Due to increase of current driven through the divider, the voltage on the 4V-4 valve /right section/ control grid increases while the voltage on the cathode remains equal to the reference voltage +10⁵ Volts.

The anode current of the right section of the 4V-4 valve and the voltage drop on the 4R-14 anode resistance are increasing. Owing to this fact the voltage on the anode of this valve section decreases causing the potential reduction of the cathode of the valve left section.

The grid bias voltage on the 4V-4 valve /left section/, /which is formed by a difference between the voltage on the 4R-4; 4R-5; 4R-6 resistors and the cathode voltage/, will be positive, it will increase gradually. The anode current and the voltage drop on the 4R-1 resistance increase causing thus the increase of the negative grid bias on the 4V-3 and 4V-9 regulating valves.

The internal resistances of the regulating valves increase involving thus the greater voltage drops on them, while the nominal value of the circuit output voltage decreases.

When the regulator input voltage decreases /due to mains voltage decrease or owing to the increase of current in the load I_n /, the voltage on the regulator output drops and involves the decrease of current driven through the divider, reducing suitably the potential of the control grid of the

- 208 -

S-E-C-R-E-T

NO FOREIGN DISSEM

50X1-HUM

4V-4 valve right section. The potential reduction /drop/ on the control grid of the 2V-4 valve right section causes the anode current drop, then, the decrease of the voltage drop on the 4R-14 resistance and the negative voltage bias increase on the left section of the 4V-4 valve. The anode current of the left section and the voltage drop on the 4R-1 resistance decrease, then, the negative voltage bias of the 4V-3 and 4V-9 regulating valves drops causing thus valves' internal resistance reduction and involving the voltage drop on them, according to the reduction /decrease/ of the stabilized /regulated/ voltage. So, the 4V-3 and 4V-9 regulating valves connected with a load in series are used as an alternating resistance, depending on the input voltage and on the load currents.

In order to diminish the power loss on the regulating valves anodes, a 4R-13 shunting resistance is connected in parallel with the valves. A 20 mA /approx./ current is driven through that resistance. The regulating valves should operate exclusively with negative voltage bias on the control grids.

The 4V-8 /SG3S/ voltage regulator is used as a source of stabilized /regulated/ "reference" voltage, in the electronic voltage regulation circuit. The grid potential of the 4V-4 /6N2P/ valve right section varies relatively to the "reference" voltage.

The 4R-2 resistance serves for limiting the current which is driven through the 4V-8 voltage regulator.

The 4C-4, 4C-5, 4C-7 and 4C-6 condensers serve for render impossible the self-excitation of the circuit.

The 4R-11 and 4R-12 resistors enable the operation of the regulating valves as tetrodes.

The high voltage switching on.

The switching on of the high voltage, separately from the switching on of the heating /filament/ circuits of the transmitter-receiver unit valves is enabled owing to time-relay use. The time-relay consists of a 4TR 1-1 thermo-relay, two electromagnetic relays type 4R1-2 and 4R1-2 /see Fig. 1-1/.

50X1-HUM

After switching on the MA-500 converter, the alternating + 115 V. 400 c/s voltage is fed to the radio range finder.

One phase only of the A.C. 115 Volts 400 c/s voltage is fed to the primary winding of the 2TR-1 high voltage transformer; the second phase is broken by the contact points of the 4R1-2 relay.

The circuit for feeding the A.C. 115 V 400 c/s voltage to the primary winding of the 2TR-1 high voltage transformer /or the circuit for high voltage switching on/ operates according to the following order:

After switching on the MA - 500 converter, the + 27 V. voltage is fed, at the same time, to the second terminal of the 4R1-1 relay and to the third terminal of the 4TR1-1 thermo-relay. The A.C. 115 V 400 c/s voltage is fed to the 4TR1-1 thermo relay winding and to the terminals No 2 + 6 of the 4R1-2 relay by means of the terminals No 5-6 of the 4R1-1 relay.

After a 1,5 min. lapse of time the 4TR1-1 thermo relay starts its operation. It closes the contact points No 3 and 4, connecting thus the 4R1-1 relay winding to the + 27 Volts network.

When being switched on, the 4R1-1 relay closes its contact points No 1 and 2, feeding thus the + 27 Volts voltage to the terminal No 4 of the 4R1-1 thermo relay.

The contacts points No 5 + 6 of the 4R1-1 relay open and disconnect thus the 115 Volts mains for the 4TR1-1 thermo relay winding.

The thermo relay is switched on after 1,5 min. lapse of time after the stop of A.C. 115 Volts voltage feeding to the relay winding. The thermo relay closes the + 27 Volts network circuit for the 4R1-2 relay by its contact points 4-5. Then the 4R1-2 relay starts its operation and the A.C. 115 Volts 400 c/s voltage is fed to the primary winding of the 2TR-1 high voltage transformer /by means of contact points 2-1 and 5-4 of the 4R1-2/ in this case only, when the switch marked "radio-optyka" on the ASP-4N gun sight switch is shifted to the position marked "radio", i.e. when the curth is

S-E-C-R-E-T

NO FOREIGN DISSEM

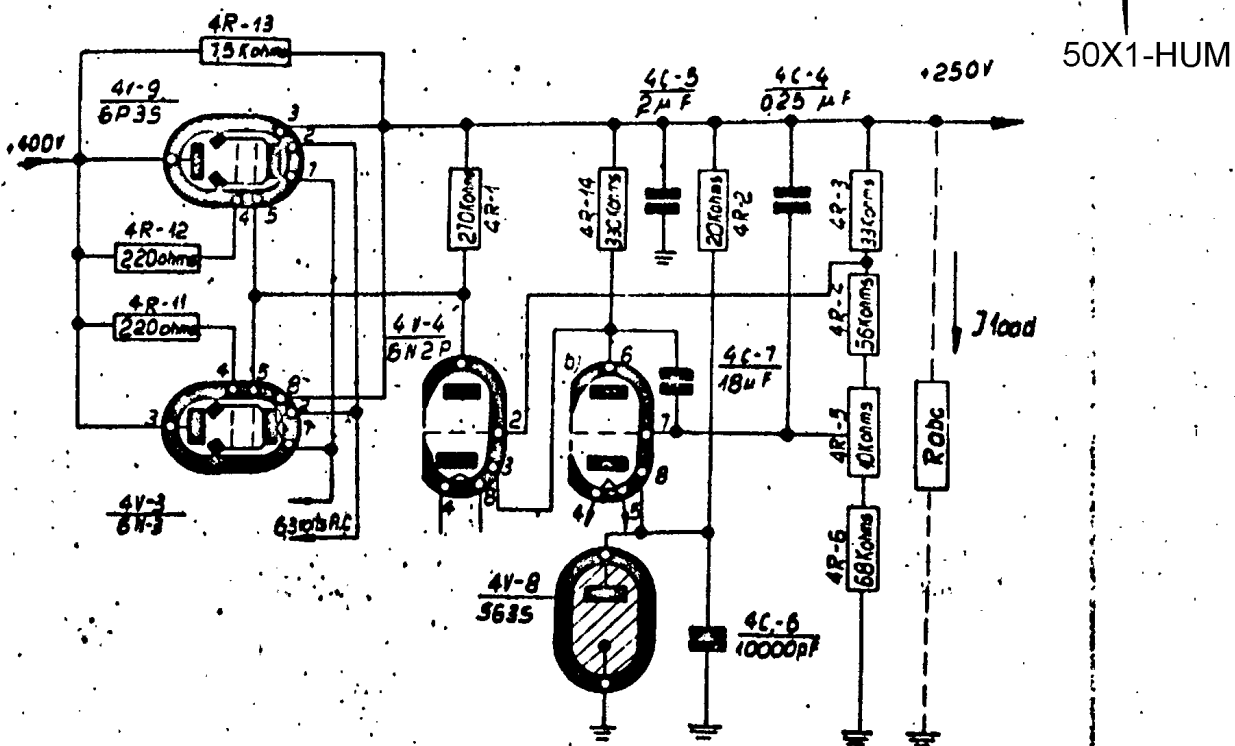

Fig. 120 . +250 Volts ionic /electronic/ voltage regulator.

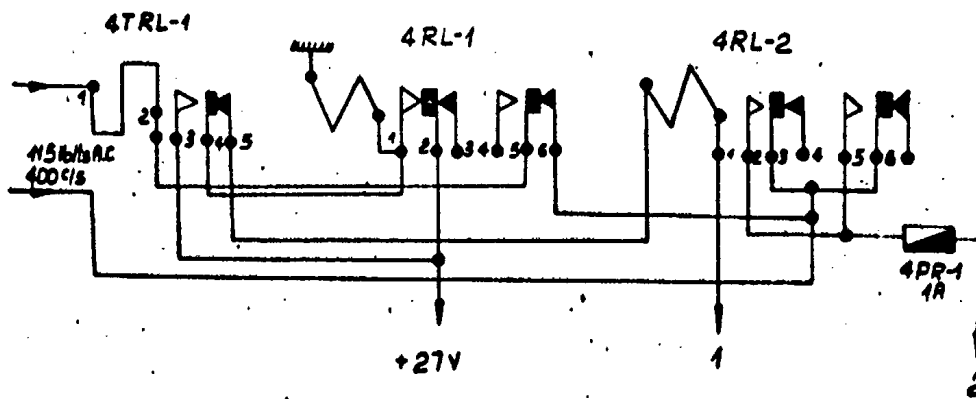

Fig. 121. Time relay
 1 - high voltage switching on
 2 - 115 Volts A.C. 400 c/s to the unit No 2

50X1-HUM

connected to the second end of the 4R₁-2 relay winding by means of the "włączenie wysokiego" /high voltage on/ cable.

If the mentioned switch is in position marked "optyka", the 4R₁-2 relay cannot start its operation and the A.C. 115 Volts 400 c/s voltage cannot be fed to the primary winding of the high voltage transformer.

A neon lamp, located close to the ASP-4N gun sight switch, serves for signalling that the high voltage is switched on.

4. Construction of power supply unit.

The power supply unit is mounted on a base /formed by extruded parts/. The unit is protected by a housing /see Fig. 122/. On the supply unit front plate following accessories are located:

- two cable terminals No 5 - 6 with 26 - contact points connectors
- the potentiometer "ustawienie 250 V" /250 Volts setting/
- two fuses

Following accessories are installed on the upper surface of the base:

- 4TR-1 mains transformer, which is fastened by 4 bolts.
- two oil-impregnated paper condensers, fixed by means of special fasteners.
- two 4D₁-1 and 4D₁-2 chokes fastened by two bolts.
- glass sealed resistors type 4R-7, 4R-8 and 4R-10.
- ten radio valves type 5G3S /1 valve/; 6P3S /2 valves/; 5G1P /3 valves/; 6N2P /1 valve/; 6C4P /1 valve/; 5C9S /2 valves/.

The 6P3S valves are provided with special fastenings, formed by rings and springs. Condensers, a thermo relay, the AR 40-50 relay and the T I - 15015 /A/ relay are mounted to the lower surface of the supply unit base. The supply unit is mounted to the airframe by means of a special frame provided with shock-absorbers type "Lord", which are screwed rigidly to the bracket by the help of 16 bolts.

S-E-C-R-E-T
NO FOREIGN DISSEM

50X1-HUM

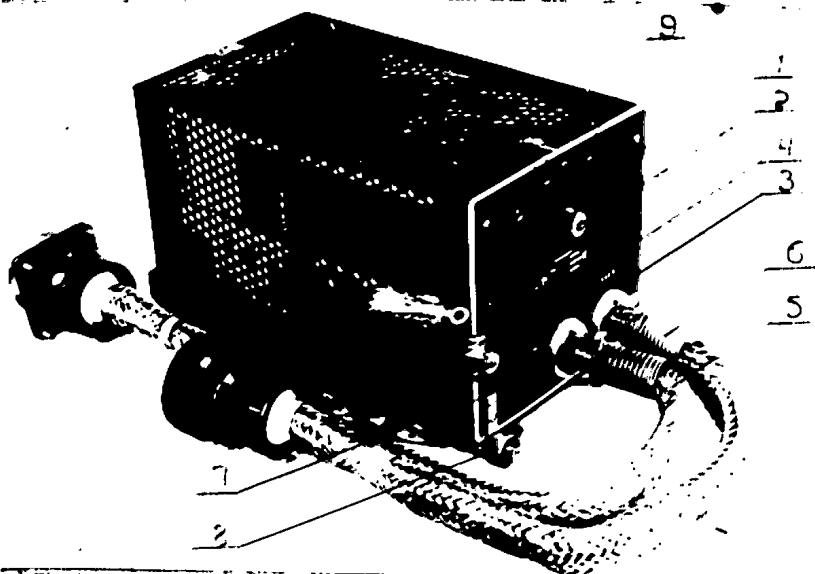

Fig. 122. General view of the power supply unit.

- 1 - 150 m A fuse in the - 230 Volts rectifier circuit
- 2 - potentiometer for setting the + 250 Volts voltage
- 3 - front plate /wall/
- 4 - bonding
- 5 - cable for connection with test board
- 6 - " " " " the range unit /6/8/
- 7 - 1 A fuse in the A.C. 115 Volts 400 c/s circuit
- 8 - nut
- 9 - 0,25 A fuse in the 400 Volts circuit.

S-E-C-R-E-T
NO FOREIGN DISSEM

S-E-C-R-E-T
NO FOREIGN DISSEM

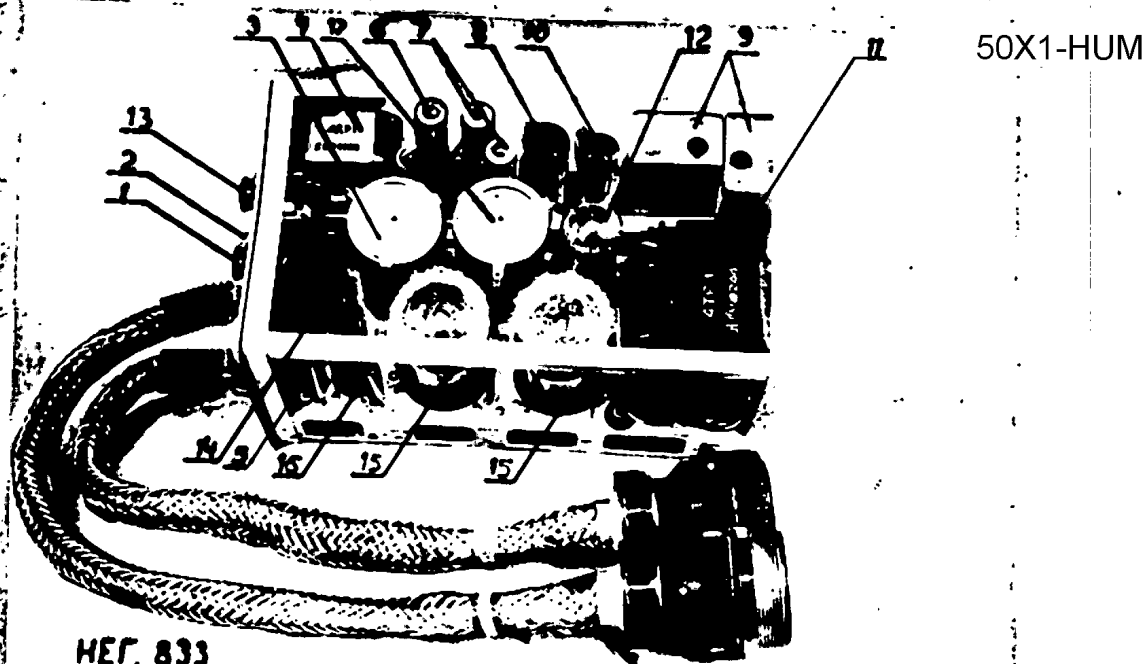

Fig. 123. Power supply unit with removed housing.

- 1 - 0,15 A - 250 Volts fuse
- 2 - potentiometer for setting + 250 Volts
- 3 - 4V - 10 kenotron.
- 4 - 4D2-1 choke
- 5 - +150 Volts voltage regulator type 4V-6
- 6 - 4R-13 resistor
- 7 - 4R-7 and 4R-3 resistors
- 8 - 4V-4 control valve
- 9 - 4R-1-1 and 4R1-2 relais
- 10 - 4V-2 kenotron
- 11 - 4TR-1 mains transformer
- 12 - 4V-8 valve
- 13 - 4V-3 regulating valve
- 14 - +150 Volts voltage regulator type 4V-7
- 15 - regulating valve type 4V-9
- 16 - -150 Volts voltage regulator type 4V-5
- 17 - 4V-1 kenotron.

- 214 -

S-E-C-R-E-T
NO FOREIGN DISSEM

S-E-C-R-E-T
NO FOREIGN DISSEM

50X1-HUM

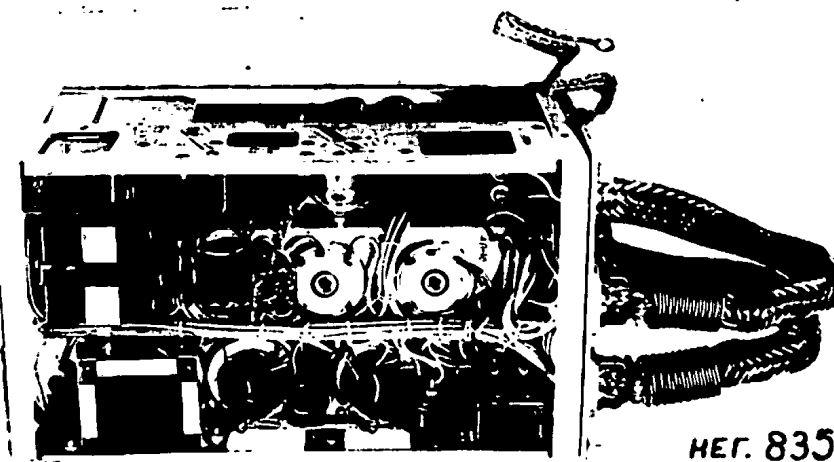

Fig. 124. Supply unit with removed housing /bottom/

- 1 - "resistance" voltage regulator type 4V-8 /EG-3S/
- 2 - kenotrons type 4V-1 and 4V-10
- 3 - 3TR1-1 thermo relay
- 4 - 1A fuse holder in the 115 Volts circuit
- 5 - regulating valves type 4V-3 and 4V-9 /6P3S/
- 6 - 4C-1 filter condenser

- 215 -

S-E-C-R-E-T
NO FOREIGN DISSEM

S-E-C-R-E-T
NO FOREIGN DISSEM

50X1-HUM

The base is mounted to the frame by means of two plain knurled nuts. The frame is joined with the housing by means of a fixing fastener and a ratched gear placed on the unit top. In case of valves replacement or a technical inspection of installation, the unit base must be removed from the housing, the knurled nuts on the front plate should be a little unscrewed and the ratchet released.

The valves can be removed in an usual way except for valves type 6F3S, which are provided with special fasteners. During the replacement of other parts, pay attention to their fixing. The supply unit with removed housing is represented in Fig. 123, the unit bottom side is shown in Fig. 124

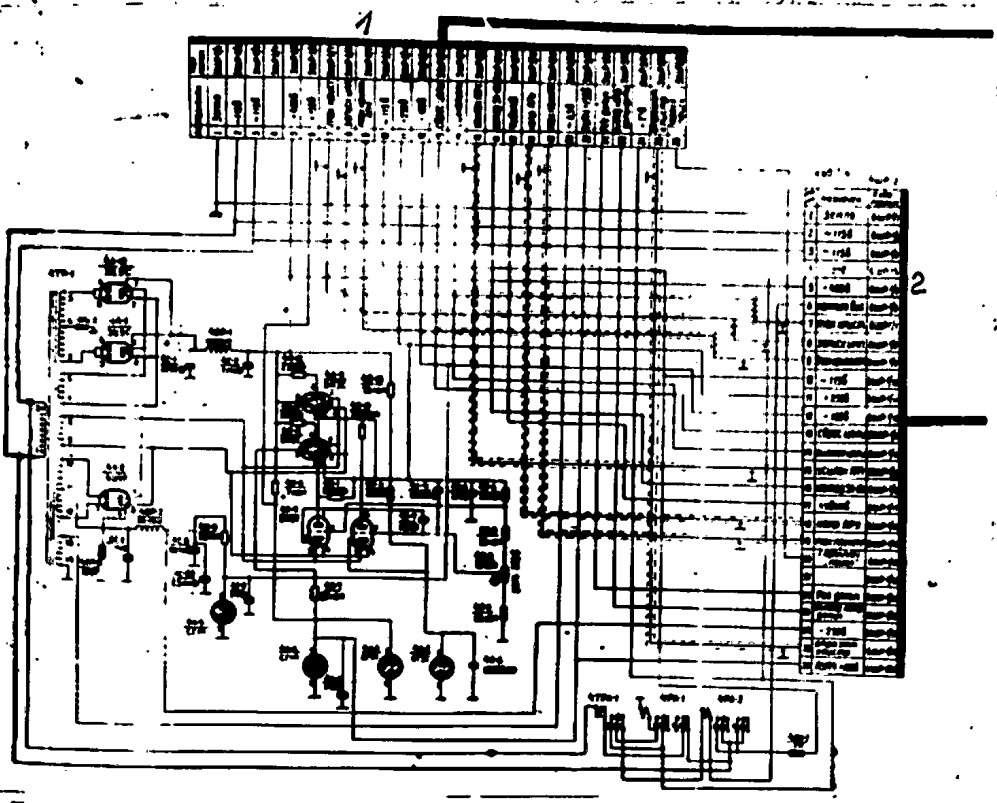

Fig. 125. Block diagram of the power supply unit.

7 216 -

S-E-C-R-E-T
NO FOREIGN DISSEM

S-E-C-R-E-T
NO FOREIGN DISSEM

50X1-HUM

1/			2/		
Order No	Specification Marking	Connected to:	Order No	Specification Marking	Connected to:
1	earth	3Sz.R3/1	1	earth	6Sz.E 1/1
2	A.C. 115 volts	" 3/2	2	A.C. 115 V	" 1/2
3	"	" 3/3	3	"	" 1/3
4	"	" 3/4	4	+27 V	" 1/4
5	+400 V	" 3/5	5	+400 V.	" 1/5
6	+150 V	" 3/6	5	H.V. commutation	" 1/6.
7	crystal current	" 3/7	7	crystal current	" 1/7
8	starting pulse	" 3/8	8	starting pulse	" 1/8
9	APCz crystal current	" 3/9	9	AP4 crystal current	" 1/9
10	A.C. 115 Volts	" 3/10	10	A.C. 115 Volts	" 1/10
11	+250 V	" 3/11	11	+250 V	" 1/11
12	-150 V	" 3/12	12	-150 V	" 1/12
13	target abandonment	" 3/13	13	target abandonment	" 1/13
14	target signal	" 3/14	14	target signal	" 1/14
15	APCz amplification	" 3/15	15	AP4 amplification	" 1/15
16	cathode 3L-13a	" 3/16	16	3L-13a cathode	" 1/16
17	sensitivity	" 3/17	17	sensitivity	" 1/17
18	automatic frequency control voltage	" 3/18	18	"APCz" voltage	" 1/18
19	magnetron current	" 3/19	19	magnetron current	" 1/19
20	A.C. 6.3 V	" 3/20	20	search switch	" 1/20
21	+150 V intermediate frequency pre-amplifier	" 3/21	21	"	" 1/21
22	range setting	" 3/22	22	range setting	" 1/22
23	range voltage output	" 3/23	23	range voltage output	" 1/23
24	+27 V	" 3/24	24	-250 V	" 1/24
25	klystron reflecting electrode	" 3/25	25	klystron reflecting electrode	" 1/25
26	search switch	" 3/26	26	"P124" +150 V	" 1/26

S-E-C-R-E-T

NO FOREIGN DISSEM

VIII. C O N T R O L B O A R D1. Destination - Main technical data.

The control board is a unit, in which all ground and flight control devices of the range finder are assembled.

The radio range finder control is performed directly by means of switches located on the upper plate of the control board.

2. Block diagram of the control board.

The block diagram of the control board is represented in Fig. 125.

The 5P-1 switch serves for the range finder switching on and off.

This switch is included to the main circuit of the remote control/start/ relay, which is installed in the MA-500 converter filter box.

When the switch is in its "włącz" /on/ position, the + 27 Volts voltage is fed to the winding of the converter relay. The relay contact points closing causes the operation start of the converter motor.

The switch type 5P-2 serves for switching on the high voltage transformer and TG11-35/3 modulator valve circuit by means of a 4R1-2 relay. The switching on is signalled by a 5V-1 lamp supplied with an A.C. 115 V. 400 c/s voltage.

The switch type 5P-3 serves for ballistic control according to installed armament type.

The push-button 5PK-1 serves for the intercepted target abandonment. When the button marked "zrzut" /target abandonment/ is depressed, the 3V-11b relay valve of the range unit is blocked.

3. Construction of the control board.

The control board is built on a base, which is covered by a housing.

S-E-C-R-E-T
NO FOREIGN DISSEM

50X1-HUM

The housing and the base are screwed by means of 4 bolts. A cable is protruding from the base side plate. The cable is joined with the test board by means of a connector.

Following accessories are placed on the control board upper plate:

- 5P-1 switch - "włącz - wyłącz" /on - off/
- 5P-2 " - "włącz wysokie" /high voltage on/
- ballistic switch
- PK-1 switch - "zrzuć" /target abandonment/
- lamp signalling that the high voltage is on.

The unit construction and accessories location are shown in Fig. 126 and 126a.

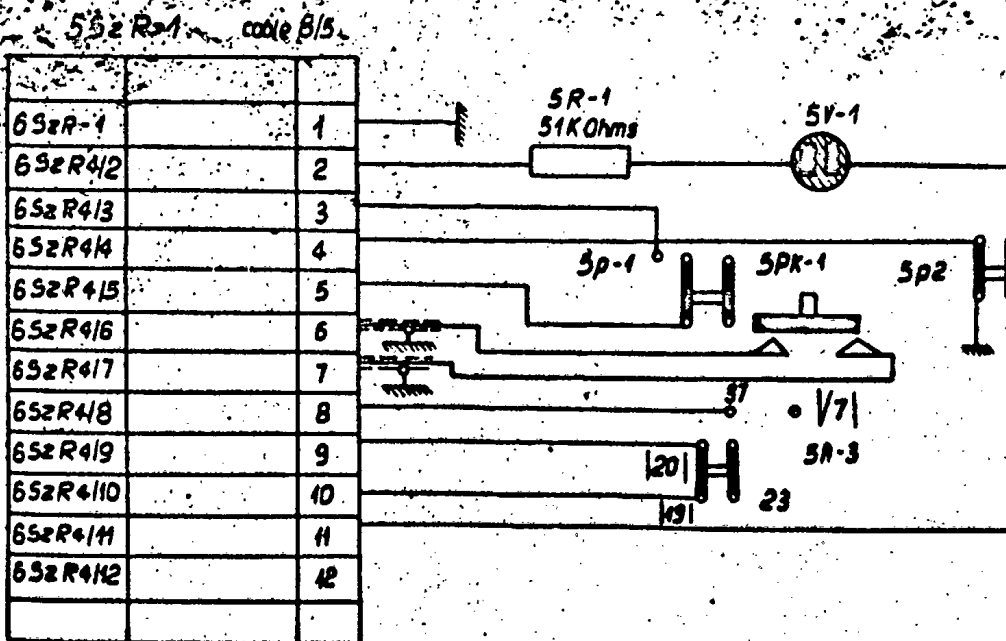

Fig. 125 a. Block diagram of the control board.

S-E-C-R-E-T
NO FOREIGN DISSEM

S-E-C-R-E-T
NO FOREIGN DISSEM

50X1-HUM

connected to:		Order No
6 SzR-1	earth	1
6 SzR 4/2	A.C. 115 Volts	2
6 SzR 4/3	Start	3
6 SzR 4/4	high voltage on	4
6 SzR 4/5	Start	5
6 SzR 4/6	target abandonment	6
6 SzR 4/7	" "	7
6 SzR 4/8	ballistic 37	8
6 SzR 4/9	switch	9
6 SzR 4/10	ballistic 25	10
6 SzR 4/11	115 Volts A.C.	11
6 SzR 4/12	" "	12

- 220 -

S-E-C-R-E-T

NO FOREIGN DISSEM

S-E-C-R-E-T
NO FOREIGN DISSEM

50X1-HUM

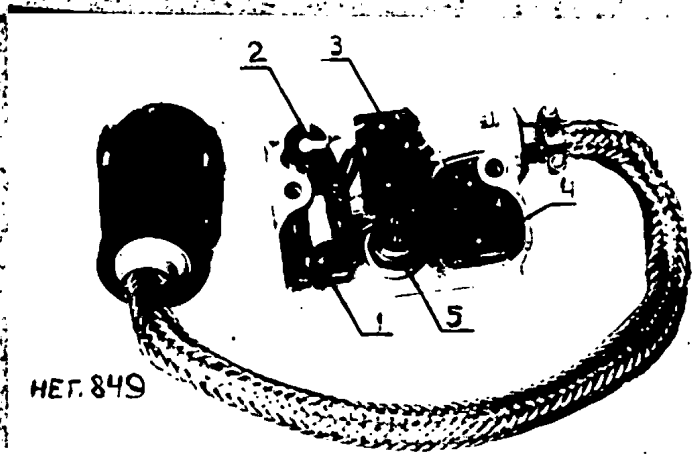

Fig. 126a. Location of control board accessories.

- 1 - switch for switching on
- 2 - lamp signalling the high voltage on
- 3 - tumbler for high voltage switching on
- 4 - ballistic switch
- 5 - press-button marked "zrzut" /target abandonment/

S-E-C-R-E-T
NO FOREIGN DISSEM

NO FOREIGN DISSEM

50X1-HUM

IX. TEST BOARD.

1. Destination.

The test board serves for:

- checking the electrical parameters of the radio range finder.
- controlling the amplification of the automatic frequency control circuit.
- setting the sensitivity of dividing circuits
- setting the voltage "Zero" - range

The electric parameters of the range finder can be checked by means of the KPM/M instrument connected to the test board.

2. Block diagram of the test board.

The block diagram of the test board is represented in Fig.127.

The 5A fuse type 6PR-1 is employed in the A.C. 115 V 400 c/s mains circuit. If the SRD-1M radio range finder or the ASP-4N gun sight takes more current /more than 5A/ from the A.C. 115 V. 400 c/s mains, the 6PR-1 fuse blow occurs. Due to this fuse blow the 115 V.A.C. 400 c/s mains circuit is broken.

The 10 A fuse type 6PR-2 is employed in the +27 Volts network. If the SRD-1M range finder or the ASP-4N gun sight take more current /more than 10A/, the 6PR-2 fuse blow occurs. Due to this fuse blow the 27V network circuit is broken.

The potentiometer "Zmocnienie ARCz" /automatic frequency control amplification/ type 6R-3 serves for setting the control grid bias of the 2V-12 valve of the intermediate frequency amplifier of the ARCz circuit /ARCz = automatic frequency control/.

The 6C-1 condenser blocks the 6R-3 resistance for the high frequency current.

The potentiometer "Czułość" /sensitivity/ type 6R-1 and the 5R-8 resistor serve for creating the condition of operation start and further operation of the range unit dividing circuits /see the description of dividing circuits/.

S-E-C-R-E-T

(NO FOREIGN DISSEM)

S-E-C-R-E-T
NO FOREIGN DISSEM

50X1-HUM

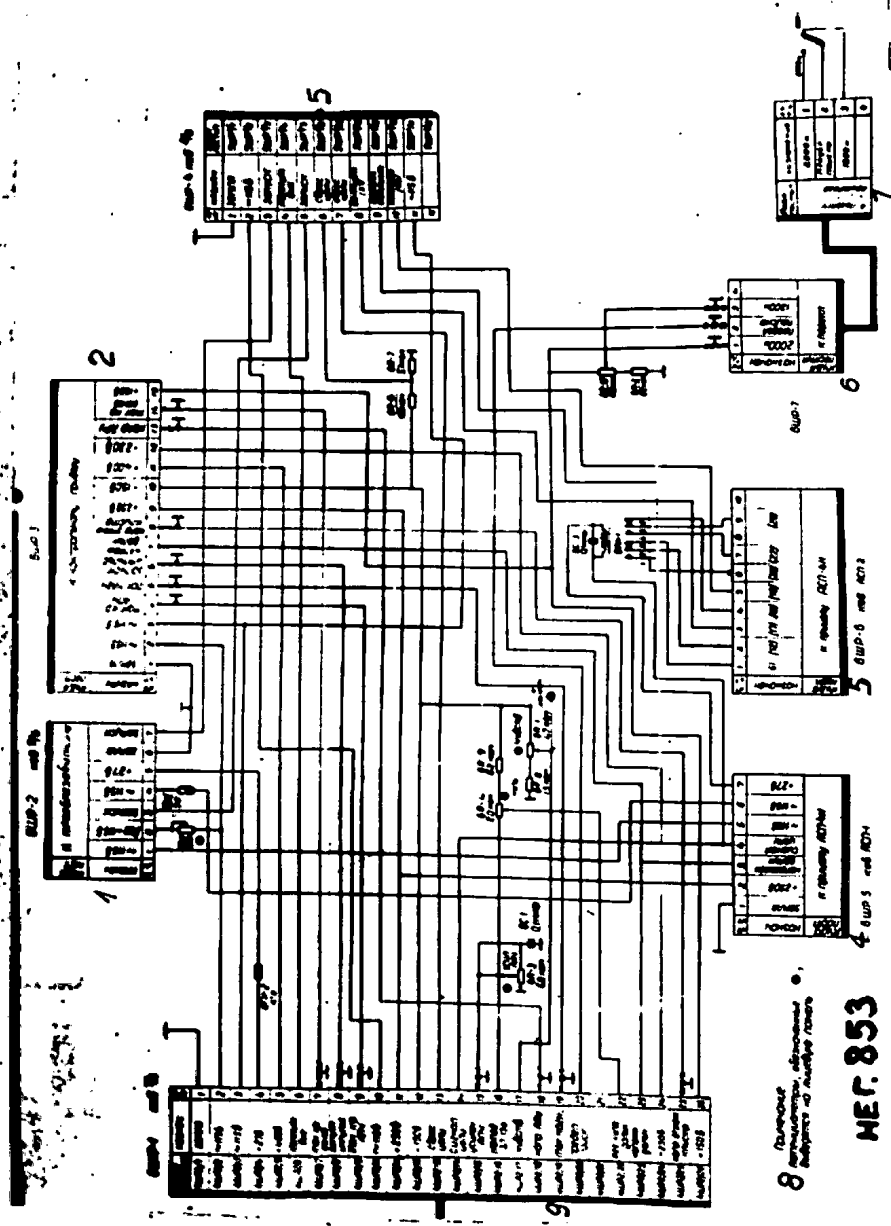

Fig. 127. Block diagram of the test board.

S-E-C-R-E-T
NO FOREIGN DISSEM

NO FOREIGN DISSEM

50X1-HUM

1/			2/		
Order No	Marking/ specification	connected to:	Order No	Marking/ specification	connected to:
1	115 Volts A.C.	to the converter	1	earth	to the test instrument
2	115 V.A.C. control		2	115 Volts A.C.	
3	start		3	" - "	
4	115 Volts A.C.		4	"AP4" crystal current	
5	+27 V.		5	magnetron current	
6	earth		5	starting pulse	
7	start		7	range voltage	
3/			8	klystron reflecting electrode voltage	
Order No	Marking	connected to:	9	+ 250 Volts	
1	earth	FSzR 1/1	10	- 150 Volts	
2	115 Volts A.C.	• 1/2	11	+ 400 Volts	
3	start	• 1/3	12	- 230 Volts	
4	H.V. commutation	• 1/4	13	automatic frequency control voltage	
5	start	• 1/5	14	main crystal current	
6	target abandoning	• 1/6	15	+150 Volts	
7	" "	• 1/7			
8	ballistic 37	• 1/8			
9	ballistic switch	• 1/9			
10	ballistic 23	• 1/10			
11	115 Volts A.C.	• 1/11			
12	" - "	• 1/12			

S-E-C-R-E-T

NO FOREIGN DISSEM

50X1-HUM

4/

connected to:	Marking	Order No.
to the ASP-4N gun sight	earth	1
	+250 Volts	2
	range voltage	3
	target signal	4
	115 Volts A.C.	5
	" "	6
	+27 Volts	7

5/

connected to:	Marking	Order No.
to the ASP-4N gun sight	/16/	1
	/12/	2
	/17/	3
	/18/	4
	/19/	5
	/20/	6
	/22/	7
	-	8
	/26/	9
	-	10

6/

connected to:	Marking	Order No.
to the switch	2000m	1
	searching range	2
	1200 m	3
	-	4

7/

connected to:	Marking	Order No.
to the test board	2000 m	1
	searching range	2
	1200 m	3
	-	4

8/

Note:

● -- marked potentiometer are located on the front panel.

S-E-C-R-E-T
 (NO FOREIGN DISSEM)

NO FOREIGN DISSEM

50X1-HUM

9/

connected to:	marking	Order No
4 SzR 2/1	earth	1
" 2/2	115 Volts A.C.	2
" 2/3	"	3
" 2/4	+27 V	4
" 2/5	+400 V	5
" 2/6	H.V. commutation	6
" 2/7	main crystal current	7
" 2/8	starting pulse	8
" 2/9	AP 4 crystal current	9
" 2/10	115 Volts A.C.	10
" 2/11	+250 V	11
" 2/12	-150 V	12
" 2/13	target abandoning	13
" 2/14	target signal	14
" 2/15	"AP4" amplification	15
" 2/16	3L-13a cathode	16
" 2/17	sensitivity	17
" 2/18	ARCz /automatic frequency control/ voltage	18
" 2/19	magnetron current	19
" 2/20	searching range	20
" 2/21		21
" 2/22	zero-range setting	22
" 2/23	range voltage	23
" 2/24	-230 Volts	24
" 2/25	klystron reflecting electrode voltage	25
" 2/26	+150 Volts	26

- 227 -

S-E-C-R-E-T

NO FOREIGN DISSEM

NO FOREIGN DISSEM

50X1-HUM

The potentiometer "zero", type 6R-4, and a 6R-5 resistor form the load of the cathode follower of the memory circuit, from which a voltage is taken for "zero" range setting.

The 6R-6 and 6R-7 resistors form the - 150 V. voltage divider, from which a - 30 V voltage is taken and fed to the control grid of the 3V-11a relay valve, in case of depressing the button "zrzuć cel" /target abandonment/.

This voltage switches the range finder for the target searching conditions. The 6C-2b condenser blocks the - 150 V supply source.

The 6R-2 potentiometer and the 6R-5 resistor form the divider connected into the + 150 V network. A voltage bias is taken from the divider and fed to the cathode of the 3V-22a valve of the maximum searching range relay.

The 6C-2a condenser blocks the + 150 V supply source.

The switch "1200 + 2000 m" type 6PK-1 serves for switching the maximum searching ranges according to flight altitude. When the 6PK-1 switch is shifted in 2000 m position, a + 150 Volts voltage is fed to the cathode of search limiting diode type 3V-22a.

When the 6PK-1 switch is shifted in its 1200 m a voltage is fed from the 6R-2 potentiometer to the 2V-22a limiting diode cathode. This voltage is set during the 3V-22 valve replacement.

Construction of the test board.

The test board is installed on a rigid base. It is protected by a housing, which is fastened to the base by means of 4 bolts. Following accessories are placed on the upper plate of the test board base:

- 1- potentiometer "Czułość" /sensitivity/
- 2- "- "Zero"
- 3- "- "zmocnienie ARC" /automatic frequency control amplification/
- 4- "115 V 5A" fuse
- 5- "27 V. 10A" fuse
- 6- "1200 + 2000 m" switch
- 7- 15-contact points test connector with a cap.

- 228 -

S-E-C-R-E-T

NO FOREIGN DISSEM

NO FOREIGN DISSEM

50X1-HUM

Following four cables are lead out from the base side:

1. Cable /ASP-1/ for connecting the test board with the ASP-4N gun sight.
2. Cable /ASP-2/ for connecting the test board with the ASP-4N sight.
3. Cable 7/6 for connecting the test board with the supply unit.
4. Cable 5/5 for connecting the test board with the MA-500 converter. The cable is provided with a terminal for connecting the target searching switch.

The construction of the unit as well as the accessories location is represented in Fig. 128 and 129.

Location of range finder units on the aircraft

The SRD-1M range finder set is located partially in the pressurized cockpit and partially in the aircraft fuselage.

The range unit and the supply unit are installed in the pilot's cockpit behind the instrument panel near the frame No 4.

The control board is mounted on the port side of the pilot's cockpit between the frames No 4 and 5. The test board is placed in the cockpit rear part close to the port track /guide rail/ of the pilot's seat between the frames No 8 and 9.

The transmitter-receiver unit is installed in the front room of the fuselage in the airplane axis, between the frames No 1 and 3.

The antenna is rigidly mounted on the fuselage front room cover between the frames No 1 and 4. The converter type MA-500 is located below the pilot's cockpit at the starboard side of the fuselage between the frames No 5 and 6.

The location of range finder units is represented in Fig. 130.

All units are interconnected by means of cables. The transmitter-receiver unit, the range unit and the power supply unit are mounted on shock absorber type "Lord" which

S-E-C-R-E-T

NO FOREIGN DISSEM

S-E-C-R-E-T
NO FOREIGN DISSEM

50X1-HUM

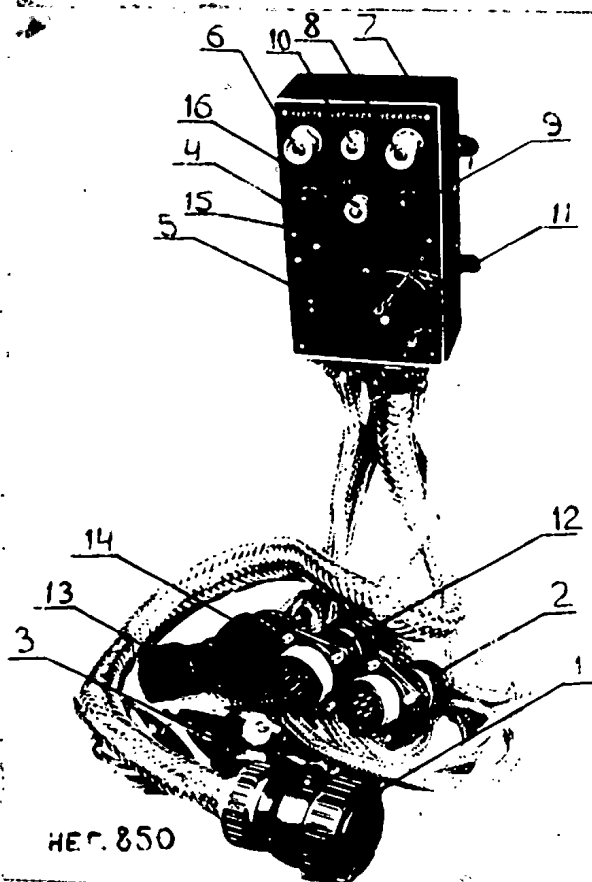

Fig. 128. General view of the test board.

- 1 - Cable for connecting the test board with the supply unit
- 2 - " " " " " " " the KA-500 converter.
- 3 - target searching switch 1200 + 2000 m
- 4 - 115 V. 5A fuse
- 5 - front plate
- 6 - potentiometer "czułość" /sensitivity/
- 7 - housing
- 8 - potentiometer "ARCz" /ARCz = automatic frequency control/
- 9 - 27 V. 10 A fuse
- 10 - potentiometer "zero"
- 11 - test connector
- 12, 13 - Cables for connecting the test board with the ASP-4N sight
- 14 - cable for connection with the control board
- 15 - Socket "obwody rozdzielające" /dividing circuits/.

S-E-C-R-E-T
NO FOREIGN DISSEM

S-E-C-R-E-T
NO FOREIGN DISSEM

50X1-HUM

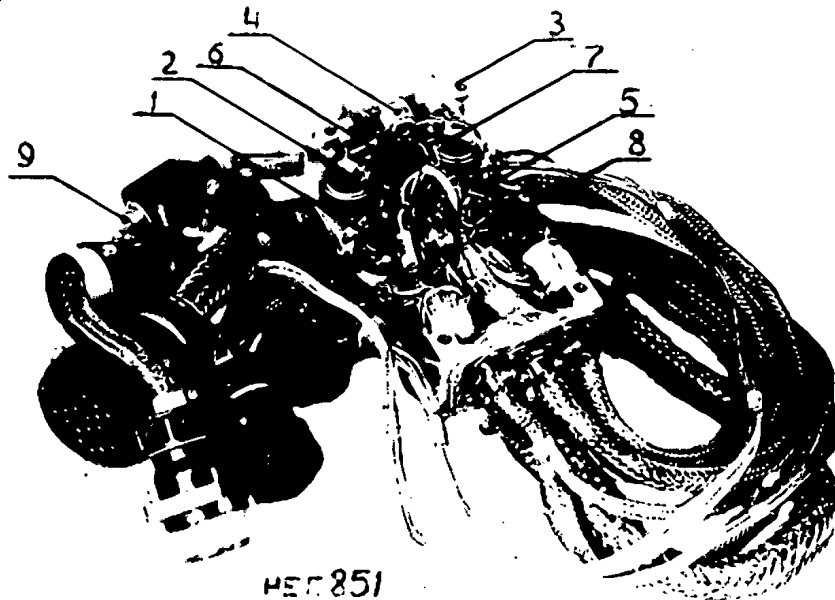

Fig. 129. Test board /bottom/

- 1 - 27 V. 10A. fuse holder
- 2 - ARCz potentiometer /ARCz - automatic frequency control/
- 3 - base
- 4 - fine resistor type 6R-9
- 5 - 115 V. 5A fuse holder
- 6 - potentiometer "zero"
- 7 - potentiometer for sensitivity setting
- 8 - potentiometer for controlling the searching range - 1200 m
- 9 - switch for searching ranges 1200 + 2000 m

S-E-C-R-E-T
NO FOREIGN DISSEM

50X1-HUM

are screwed to the frame. The aerial, the control board and the test board are mounted without shock absorbers, by means of special bolts.

The units provided with shock absorbing frames are mounted to these frames by means of special clips, nuts and pin fasteners, which enable the quick release, removal and installation.

- 232 -

S-E-C-R-E-T

NO FOREIGN DISSEM

50X1-HUM

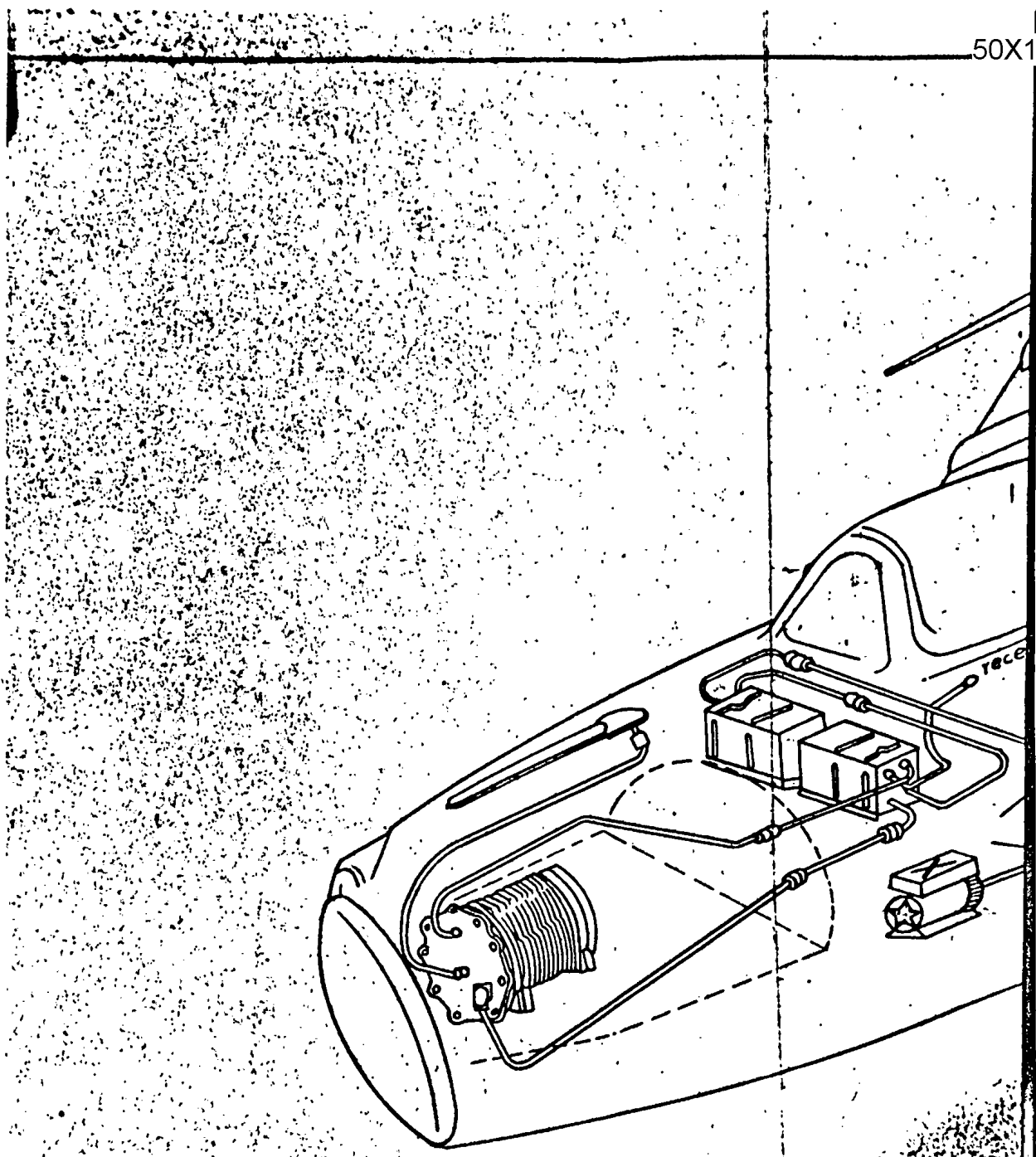

1 Fig. 130. Location of the SRD-1M range finder units on the Mig-17 aircraft

S-E-C-R-E-T
NO FOREIGN DISSEM

50X1-HUM

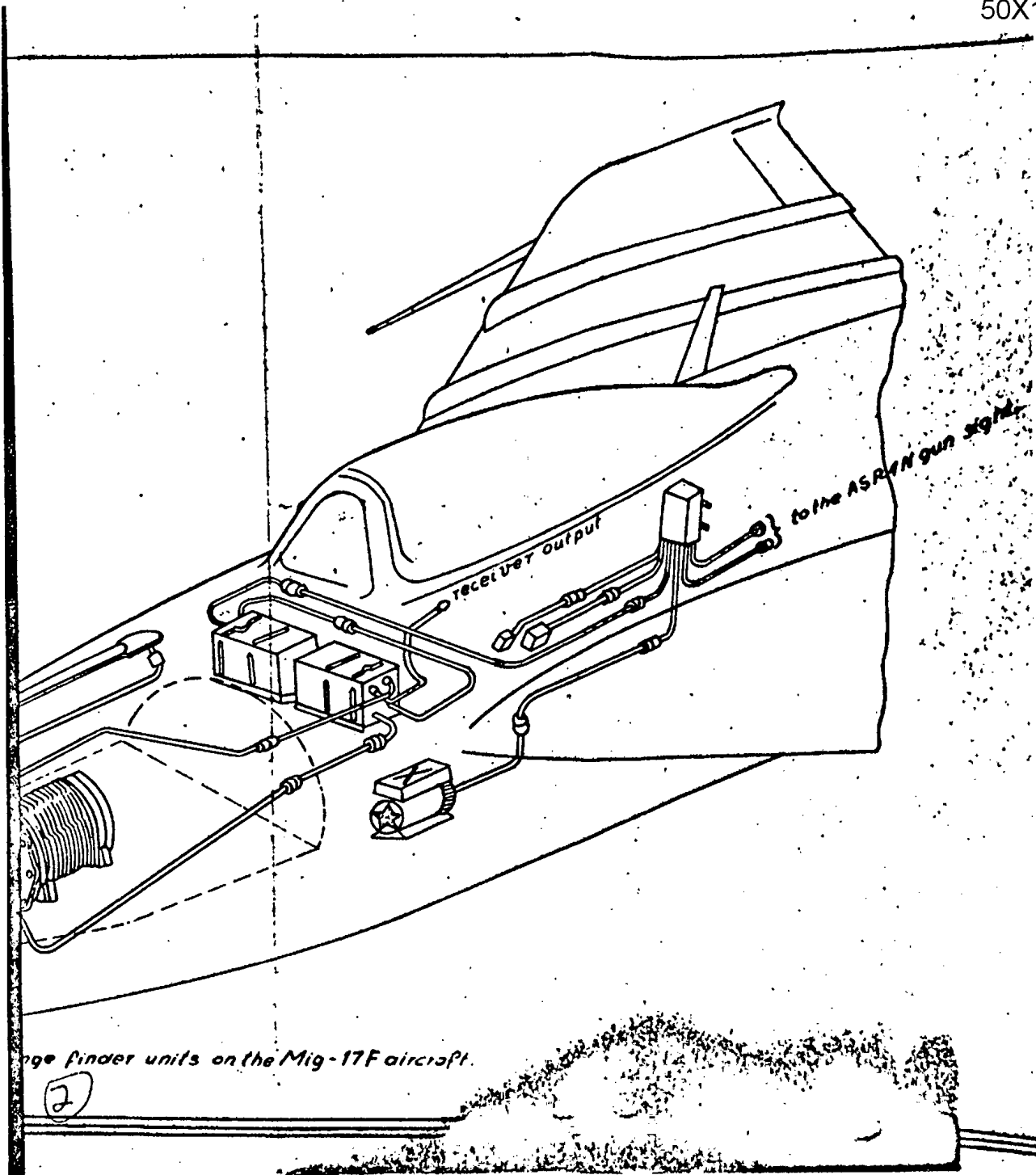

Range finder units on the Mig-17F aircraft.

S-E-C-R-E-T
NO FOREIGN DISSEM

NO FOREIGN DISSEM

50X1-HUM

X. RADIO RANGE FINDER SRD-1M OPERATION
DESCRIPTION ACC. TO BLOCK DIAGRAM

The block diagram of the radio range finder is shown on the figure 131.

a/Operation in "the target searching" mode

The blocking generator submodulator 2V-1 (6N3P) is used as the control generator of the set. The blocking generator is formed by the left section of the double triode 2V-1 (6N3P), which is generating the positive voltage impulses of 220 V amplitude, of 1,3 to 1,5 μ sec duration and of 900 c/s repeating frequency, they are transferred from the impulse transformer 2TR-4 third coil to the control grid of the cathode follower (right hand side of the valve 2V-1).

The submodulator impulses are transferred from the cathode loading 2R-5 to the condenser 2C-3 and the resistance 2R-6 and then to the modulator discharge valve grid and control its operation. The modulated impulses are formed in the modulator with the artificial forming line 2LF-1 and the hydrogen thyatron 2V-2 (TOL-1-35/3), which is acting as a switch. As a result of forming in the secondary coil of the impulse transformer 2TR-5 there are produced the impulses of the repeating frequency 900c/s, of 0,7 μ sec duration and of 5,5 kV amplitude range, which are transmitted to the magnetron cathode 2V-3 (NI-12U).

The magnetron generator is producing impulses, their frequency is 2 800 Mc/s and the impulse power is not less than 7 kW.

The magnetron generator impulses of substantial power

- 235 -

S-E-C-R-E-T

NO FOREIGN DISSEM

50X1-HUM

and high frequency are coming to the antenna by the coaxial cable and are radiated into the space. Owing to the presence of the antenna switch, consisting of the half-wave and quarter wave concentric line segment and the "receiving-transmitting" chamber, where the valve of the type 6R-5 (2V-7) is used as a resonance switch, the receiving set is switched out when the search impulse is operating.

The negative starting impulse and the positive starting impulse of the ARCz (automatic frequency control) are taken with the modulated impulse from the impulse transformer 2TR-5, the divider formed by the resistances 2R-10, 2R-35, 2R-60 gives the negative blocking impulse.

The left hand side of the diode 2V-16 (6X1P) cuts off the positive hump of the closing impulse. The closing impulse of 45 V amplitude is coming from the potentiometer 2R-8 to the control grids of the last two valves 3V-16 and 3V-17 (6Z3P) and closes the receiver when the search impulse is operating.

The starting impulse of the 100 V amplitude is transferred thru the resistance 2R-61 to the screen grid of the valve 2V-12 (6Z1P) and switches on the automatic frequency control set (ARCs).

The part of the high power energy and of high frequency is coming from the magnetron thru the attenuator to the mixer chamber ARCs, where as a mixer a crystal detector of DCS-2 (2D-2) type is used. At the same time to the mixer chamber ARCs are coming the continuous high frequency vibrations of the klystron heterodyne 2V-4 (K-12). As a result of the two high frequency vibrations in the input circuit of the ARCs is generated an impulse, the

- 235 -

S-E-C-R-E-T

NO FOREIGN DISSEM

NO FOREIGN DISSEM

50X1-HUM

frequency of it is equal to the klystron frequency and the magnetron generator frequency difference.

That impulse is amplified in the two stages of the medium frequency amplifier of the ARCz set, consisting of the valves 2V-11 and 2V-12 (6Z1P).

The amplified impulse is coming to the discriminator circuit, formed by the double triode of 2V-13 (6H2P) type. The demodulated impulse leaves the discriminator and enters the two staged impulse amplifier, formed by the double triode of 2V-14 type (6N1P), it is amplified and then enters the regulating grid (right hand side of the valve 2V-15 /6N1P/), from its cathode is taken the negative voltage to the klystron reflecting electrode. If the change of the middle frequency exceeds the klystron regulating range then the blocking generator impulses (left hand side of the 2V-15 valve) are entering the control grid of the right hand side of the 2V-14 valve instead of the impulses coming of the discriminator.

The ARCz set is generating the control voltage, which is supporting the klystron frequency 30 Mc/s higher than the magnetron generator frequency.

The starting impulse of 85 V amplitude is entering the range block thru the right hand side of the starting impulse limiter diode 2V-16 (6N1P) in order to start the "high speed" sawtooth generator 3V-1/6N1P/, 3V-2/6Z3P/.

The "h. speed sawtooth" generator gives the sawtooth shaped impulses of the repeating frequency 900 c/s, of 25 μ sec duration and of 145 V amplitude to the anode of the comparator diode 3V-3b (6N1P). To the cathode of the comparator diode is given the voltage of the "low speed sawtooth" generator 3V-9 (6N-7) thru the contacts 4 and

- 236 -

S-E-C-R-E-T

NO FOREIGN DISSEM

S-E-C-R-E-T
NO FOREIGN DISSEM

50X1-HUM

5 of the relays 3R1-1, the amplifier 3V-8 (6Z5P), the diode-limiter of "low speed sawtooth" minimum 3V-11b (6X1P) and the cathode follower 3V-3a (6X1P), the voltage is oscillating between 30 and 140 V during 0,67 to 2 sec.

When the amplitude of the low speed sawtooth generator is increasing at every moment of the repeating frequency 900 c/s increases the limiting of the "h.s. sawtooth" voltage, amplitude and the length. In that way on the starting amplifier grid (left hand section of the valve 3V-4 /6X1P/) is coming the sawtooth shaped impulse, its beginning is coming later behind the transmitter starting impulse in time of the searching generator voltage increasing.

That impulse is amplified, then comes to the blocking generator of the gate impulse, from the secondary winding of the impulse transformer and causes its operation by the positive front shunt. The blocking generator is excited and a gate impulse of 140 V amplitude, 0,7 μ sec duration is generated, it is coming directly to the screen grid of the coincidence valve, and thru delay line of 0,5 μ sec to the screen grid of the coincidence valve 3V-21.

When the low speed sawtooth generator voltage increases, as shown in the figure 65, the gate impulses are pacing the search range of 300 to 2 000 m at frequency 0,5 to 1,5 c/s.

The maximum limiting of the low speed sawtooth is made by the 3V-22 (6X1P) valve, the voltage of the cathode is chosen by appropriate position of the 6PK-1 switch. When the switch is in "2 000 m" position the maximum range of 2 000 m is assured. When the switch is in "1 200 m" position then the maximum range is limited to 1 200 - 1 500 m.

- 237 -

S-E-C-R-E-T

NO FOREIGN DISSEM

NO FOREIGN DISSEM

50X1-HUM

The noises of the cathode follower output (right hand section of the 3V-19 /6N3P/ valve) are coming to the ARW noise set, which is formed by the valves 3V-20 (6Z2P) and 3V-7 (6N1P). ARW - automatic gain control.

The noises are amplified on the 3V-20 valve, demodulated by the grid detector (left hand section of the 3V-7 valve) and amplified by the direct current amplifier (right hand section of the 3V-7 valve). The ARW noise set generates the negative voltage depending on the noise magnitude, which is transferred to the control grids of the first valves WPCz 3V-14, 3V-15 (6Z3P) thru the cathode follower of the ARW 3V22b (6N1P) set. In that way a constant noise level in the receiver is maintained.

The negative impulse of 25 μ sec duration is coming from the high speed sawtooth generator set to the grid of the 3V-20 valve (pentode). That impulse blocks the ARW noise set during receiving and at the same time eliminates the target impulse influence on the ARW noise set operation. The windings of the relay 3R-1 and 3R1-2 connected to one of the circuits of the divider circuits relay valves and of the memory circuit are without the current because of the negative bias on the control grids of these valves.

When the contacts 4 and 5 of the 3R1-1 relays are closed, then the low speed sawtooth generator output (3V-9) is disconnected off the control grid of the amplifier valve (3V-8).

When the contacts 5 and 6 of the 3R1-2 are open then the green bulb of the "Target interception" at the sight ASP-4N is not shining.

When the contact 1-2 of the relays 3R1-2 are connected to the calculating operating circuits then to the sight

- 238 -

S-E-C-R-E-T

NO FOREIGN DISSEM

S-E-C-R-E-T
NO FOREIGN DISSEM

ASP-4N is supplied a constant direct voltage 50X1-HUM
the contacts 11 and 12 of the relay 3R1-1 are open, the
contacts 1 and 2 of the 3R1-1 relay are closed, the con-
tacts /4-5 and 7-8 / of the relay 3R1-1 closed, then the
memory coil is not operating.

b/ Operation in the "target determining" mode.

The impulses reflected by the target are coming from
the antenna to the "receiving-transmitting" chamber of
the antenna switch, which is formed as a cavity circuit
tuned to the generator frequency (reflected impulse fre-
quency). The reflected impulse energy is coming from the
"receiving-transmitting" chamber to the receiver mixer
chamber, as the mixer is used the crystal detector of DGS-
2 (2D-1) type.

In the receiver mixer chamber are generated several
frequencies, from which the middle frequency of 30Mc/s is
separated on the mixer loading. The mixer loading is for-
med by the input circuit of the WPCs (intermediate fre-
quency pre-amplifier) set. After leaving the WPCs stage,
formed by the valves of 6Z5P (3V-12, 3V-13, 3V-14, 3V-17)
type the impulse reflected by the target is coming to
the WPCs (intermediate frequency amplifier), formed by the
valves of 6Z5P type (3V-14, 3V-15, 3V-16, 3V-17). The tar-
get impulse amplified in the WPCs, demodulated by the se-
cond detector of the 3V-18 (6H2P) type, is coming thru
the video-pulse amplifier (left hand section of the
valve 3V-19) (6K3P) and the cathode follower (right hand
section of the 3V-19 valve) to the control grid of the
coincidence valves 3V-5, 3V-21 (6Z1P).

When the target reflected impulse and the gate impul-

S-E-C-R-E-T
NO FOREIGN DISSEM

S-E-C-R-E-T
NO FOREIGN DISSEM

se coincide in time then the coincidence valve, 50X1-HUM

The negative impulse is taken from the general coincidence valve anode loading, it is amplified in the pre-amplifier 3V-10a (6B1P) and thru the peak detector 3V-10b (6B1P) is unblocked the relay valve 3V-11a (6B1P).

The relay 3R1-1 operates, then the contacts 4 and 5 are opened, the low speed sawtooth generator is disconnected, the contacts 3-2 are closed and the grid of the following cathode follower (left hand section of the 3V-13 valve) is engaging the cathode of the 3V-13a valve, the contacts 11 and 12 are closing giving the mass to the grid of the right hand section of the 3V-13 valve, in anode circuit of it the relay 3R1-2 is switched on.

The right hand section of the 3V-13 valve is unblocked the relay 3R1-2 operates, at the same time the contacts 5 and 6 are closed and the green bulb of the "interception" is shining. In the sight ASP-4B the contacts 7 and 8 are opened and the resistance 3B-85 is switched in the memory circuit. The contacts 2 and 1 are closed and the voltage proportional to the target range is given to the circuits of the sighting system of the ASP-4B sight. The range finder system is set in the "sighting" mode and is generating the voltage proportional to the target range. When the target is intercepted and the low speed sawtooth generator is disengaged by the voltage proportional to the target range, the integral capacitor voltage is remaining which was at the moment of the relay 3R1-1 operation.

Example - $C_1 = 3 \text{ C} - 14 \text{ K K}$

where K is the 3V-7 amplifier amplification factor without the feedback, the 3C-14 condenser in the integra-

S-E-C-R-E-T
NO FOREIGN DISSEM

NO FOREIGN DISSEM

50X1-HUM

tor system.

The integral capacitance C_1 at the "tracking" mode similar as also in the target searching mode is connected to the control grid of the amplifier 3V-8. The voltage on it is amplified by the amplifier, is limited by the limiter 3V-11b, is transferred by the cathode follower 3V-6a to the cathode of the equalizing diode instead of the low speed sawtooth generator voltage and it controls the gate impulse range shifting. The negative impulses on the anodes are results of the coincidence valves operation, they are coming to the charging and discharging diodes of the integral capacitance 3V-12a, 3V-12b (6N2P).

The charging and discharging of the capacitance C_1 is done by means of the diodes 3V-12a and 3V-12b depending on that which of the 3V-5, 3V-21 valves is blocked. The charging and discharging current of the capacitance C_1 is proportional to the amplitude and the impulse length on the anode of the valves 3V-5 and 3V-21. The difference of the charging and discharging current of the capacitance C_1 is causing the voltage change on it till the moment of equalizing the current flowing thru the both valves takes place, i.e. till the reflected impulses are equal to the gate impulses. In that case the voltage on the integral capacitance is practically the same.

When the target impulses are lost then the relay 3R-1 of the separating circuits set ceases to operate and renews the range searching.

The relay, which causes the range voltage transfer thru its contacts to the ACP-4N sight ceases to operate 3 to 4 sec. later. At the same time the output voltage during the delay period can change to such a stage and with such spe-

- 241 -

S-E-C-R-E-T

NO FOREIGN DISSEM

S-E-C-R-E-T
NO FOREIGN DISSEM

ed as in the case of the intercepted target drop. That is secured by the memory circuit formed by the valve 3V-13 /6K1P/.

50X1-HUM

As a input impulse on the ARW circuit auto. gain control) is used the impulse from the anode of the pre-amplifier of the separating circuits 3V-10a. That impulse is fed to the control grid of the left hand section of the 3V-6 (6K1P) valve and is amplified.

Further the amplified and elongated impulse is demodulated on the diode (right hand section of the 3V-6 valve) and in the form of negative bias is transferred thru the cathode follower 3V-22b (6K1P) to the control grid of the two first valves WPCz. In that way the receiver amplification is changed, it is necessary as not to overload the receiver stages and in order to minimize the errors when determining the target ranges of various reflecting intensity.

The ARW noise operation in the search and in the following mode is the same.

The ARW impulse and ARW noises have the general output in the WPCz stage thru the cathode follower 3V-22b.

The radio range finder SRD-1M alternating voltage 115 V 400 c/s is supplied by the inverter of the UA-500 type, which is fed by the aircraft board net +27 V.

The radio range finder stabilized voltage is supplied by the supply unit GJ.2.087.007.

The receiving-transmitting unit is supplied by the rectified voltage taken from the supply unit and from separate rectifiers, contained in the unit.

- 242 -

S-E-C-R-E-T
NO FOREIGN DISSEM

S-E-C-R-E-T
NO FOREIGN DISSEM

50X1-HUM

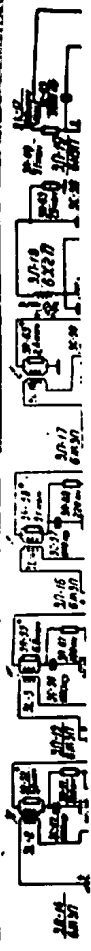

Fig. 131. The radio range finder SRD-1H block diagram.

(2)

283

S-E-C-R-E-T
NO FOREIGN DISSEM

S-E-C-R-E-T
NO FOREIGN DISSEM

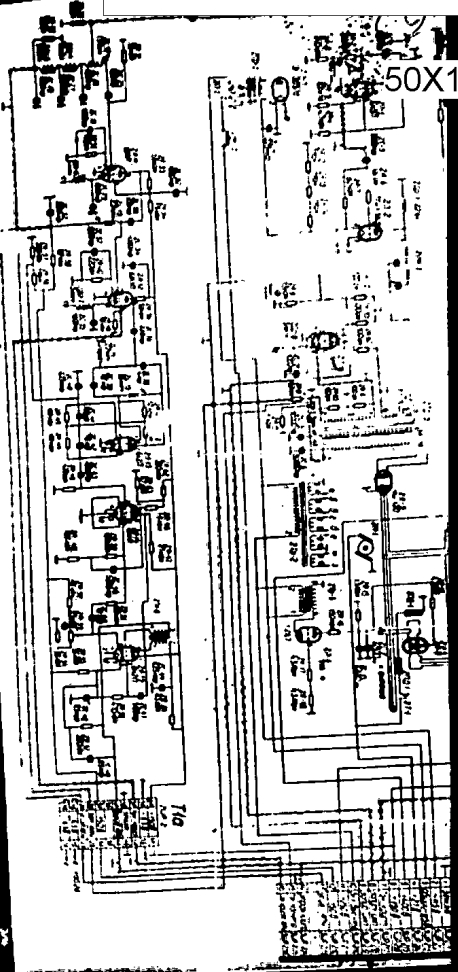
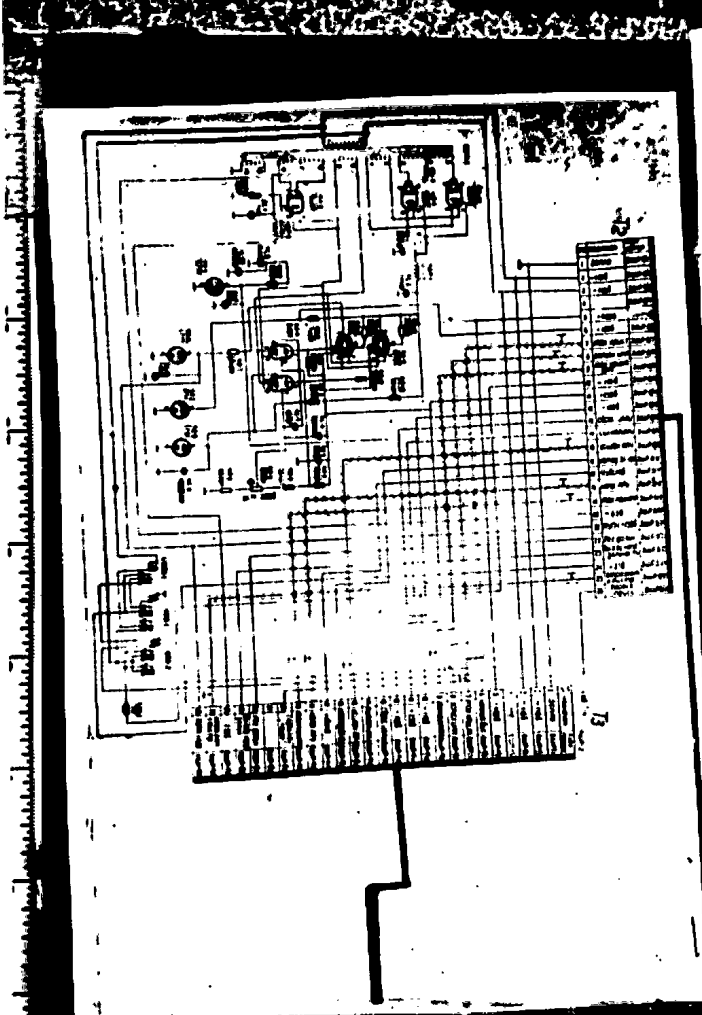

50X1-HUM

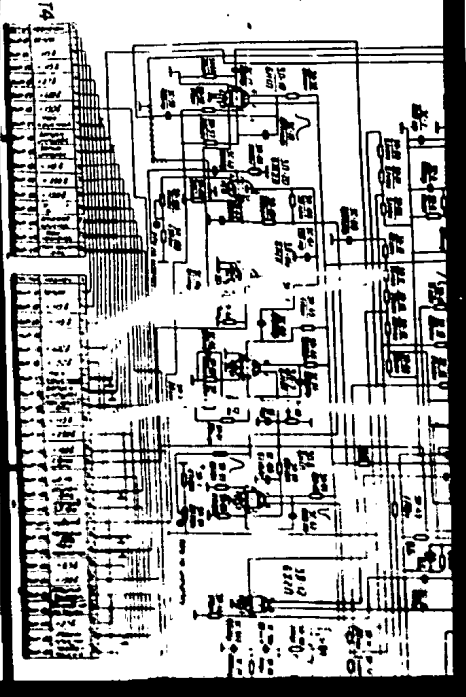
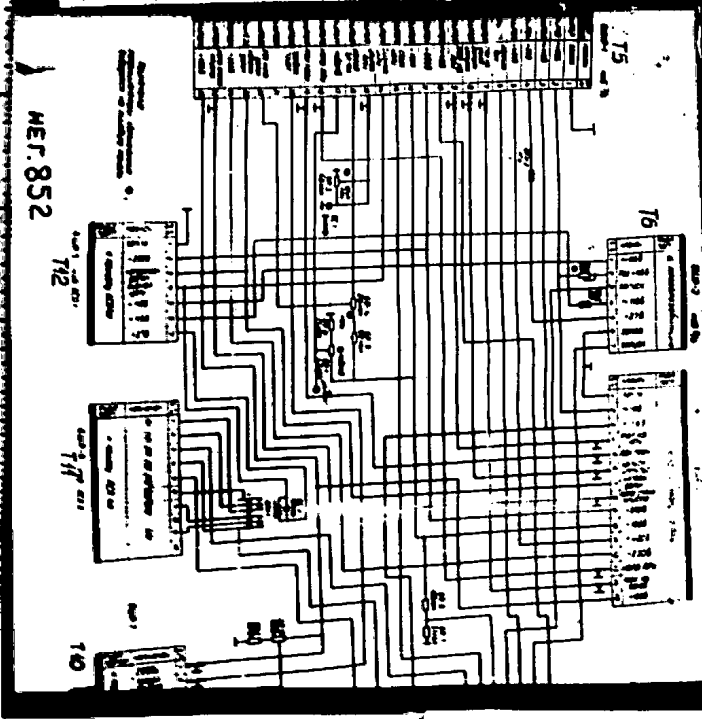

S-E-C-R-E-T
NO FOREIGN DISSEM

S-E-C-R-E-T
NO FOREIGN DISSEM

50X1-HUM

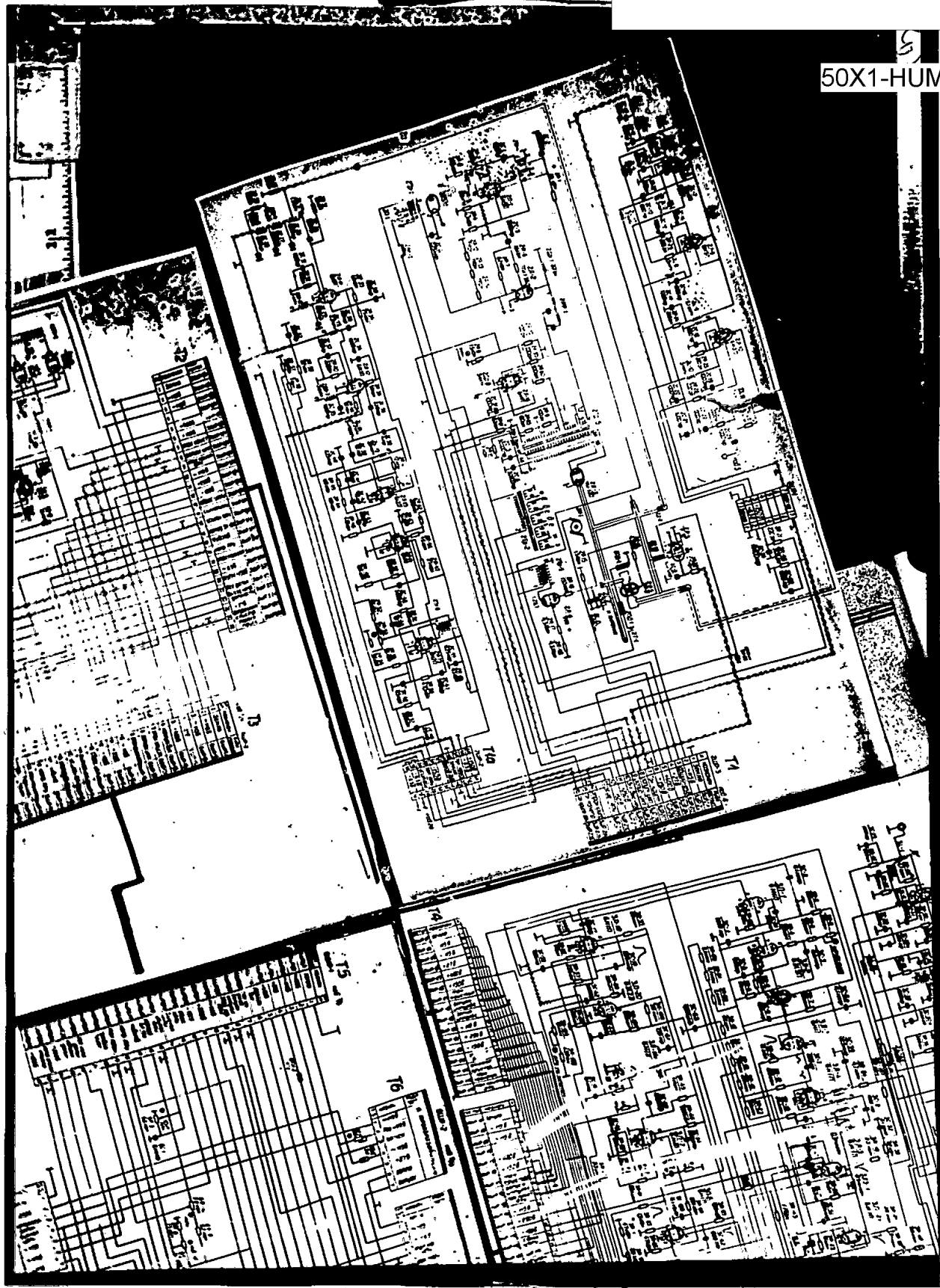

S-E-C-R-E-T
NO FOREIGN DISSEM

S-E-C-R-E-T
NO FOREIGN DISSEM

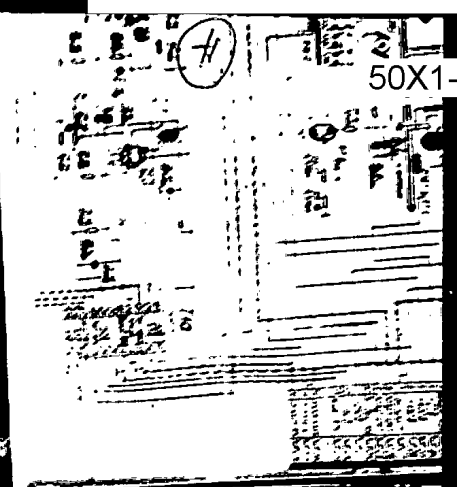
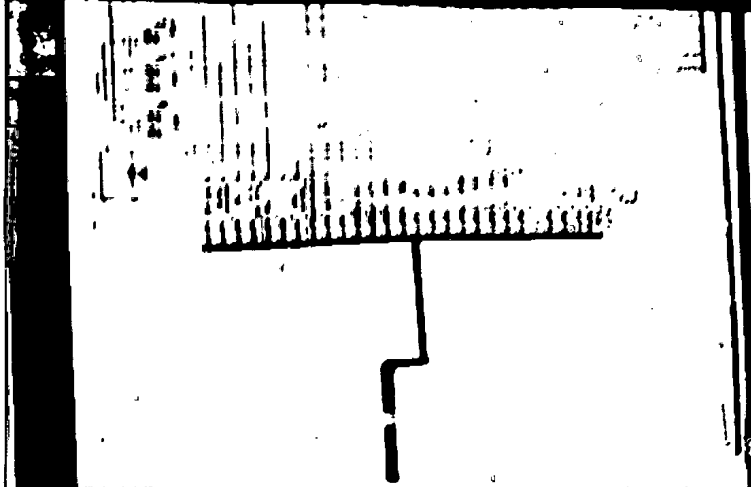

50X1-HUM

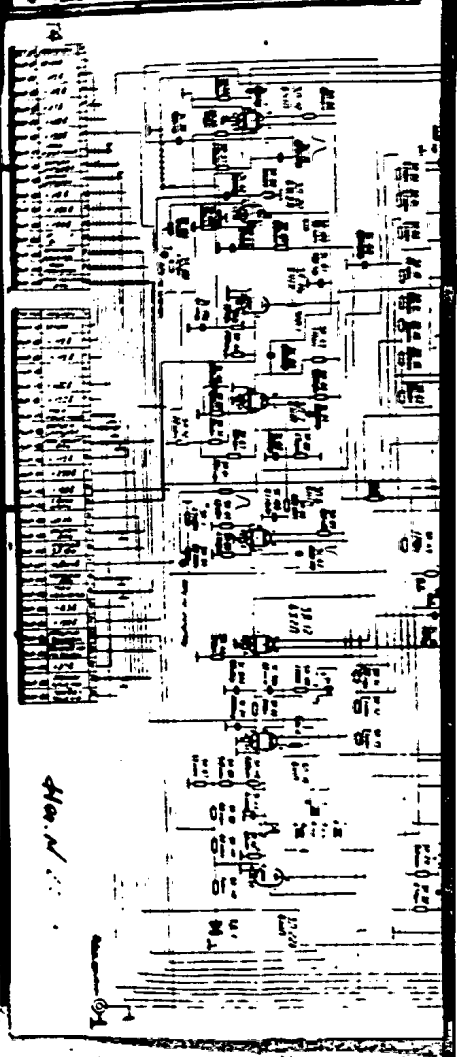
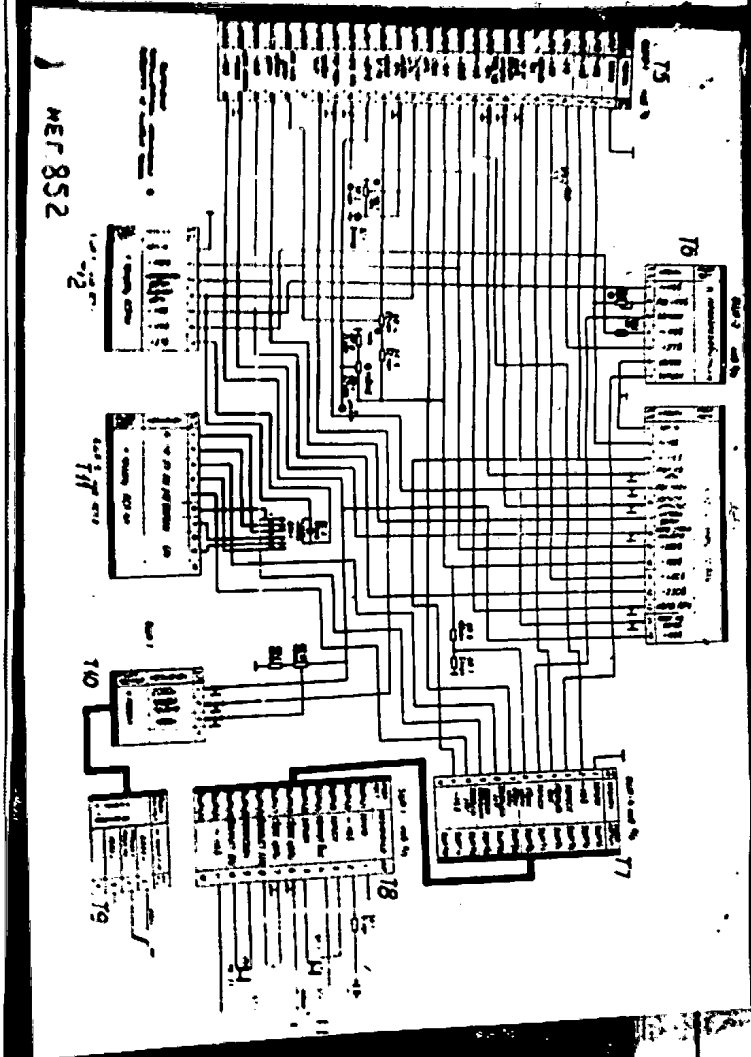

S-E-C-R-E-T
NO FOREIGN DISSEM

S-E-C-R-E-T
NO FOREIGN DISSEM

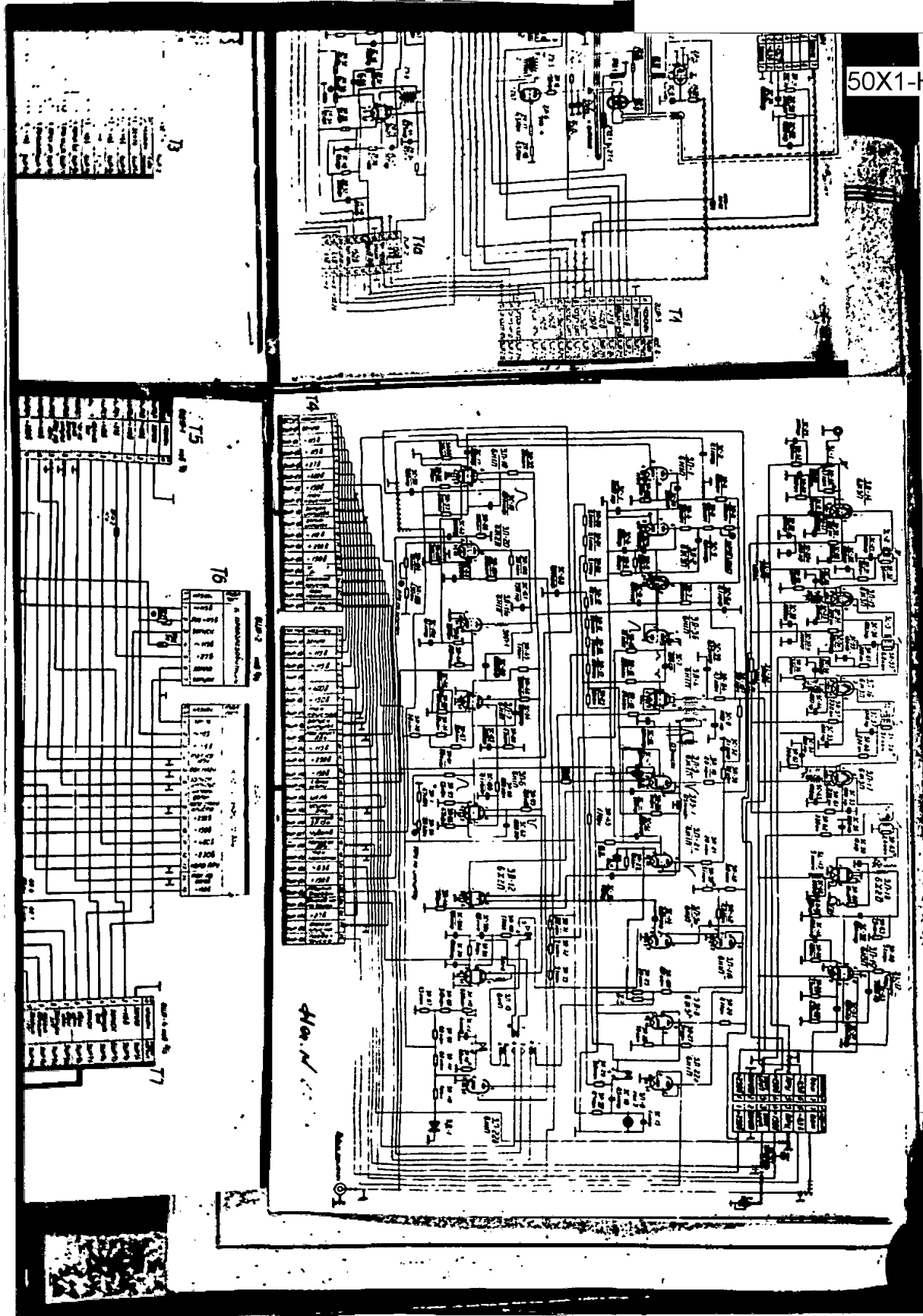

50X1-HUM

S-E-C-R-E-T
NO FOREIGN DISSEM

NO FOREIGN DISSEM

50X1-HUM

- 1 - ground
- 2 - connected to
- 3 - general
- 4 - crystal current
- 5 - starting
- 6 - target aband
- 7 - target pulse
- 8 - amplification
- 9 - cathode
- 10 - sensitivity
- 11 - voltage
- 12 - magnet, current
- 13 - galv. contr.
- 14 - range output voltage
- 15 - klystron reflecting electrode
- 16 - switch
- 17 - h.v. commutation
- 18 - starting impulse
- 19 - galv. contr.
- 20 - galv. output voltage
- 21 - start. impulse
- 22 - magnet. current
- 23 - galv. zero setting
- 24 - klystron reflecting voltage
- 25 - ballistic
- 26 - switch
- 27 - sight

Notice: Potentiometers, marked , are lead out on the control panel.

- 244 -

S-E-C-R-E-T

NO FOREIGN DISSEM

NO FOREIGN DISSEM

Appendix

50X1-HUM

XI . LIST OF FIGURES

(which are contained in the technical description)

Fig.no.	Name	page
1	General view of the radio range finder	
2	Cable connections diagram	
3	Pulses plotted against time	
4	Simplified view of an attacking aircraft and a flying target	
5	Searching limits of gate pulses	
6	Output voltage plotted against distance to target	
7	Block-diagram of the SRD-1M range finder	
8	Operation-diagram of the SRD-1M range finder	
9	Pulse voltage Chart of the SRD-1M range finder	
10	Interference of a target signal with gate pulses	
11	Radiation pattern of the SRD-1M aerial	
12	Distribution of voltage amplitudes along the feeder	
13	Simplified drawing of the antenna	
14	General view of the antenna with cable	
15	Operation-diagram of the receiving-transmitting unit	
16	Block diagram of the submodulator	
17	Block diagram of the blocking generator	
18	Curves illustrating the current and the voltage variation in the blocking generator circuit	
19	Pulse shape on the blocking generator output	
20	Block diagram of the cathode follower	
21	Shape of pulse on the cathode follower output	
22	Block diagram of the modulator	
23	Modulators equivalent circuit	
24	Diagram of resonance discharging circuit of the forming line	

S-E-C-R-E-T

NO FOREIGN DISSEM

Fig. no.	Name	Page
25	Forming line voltage variations	
26	Equivalent circuit of the forming line pulse discharging	
27	Magnetron heating supply circuit diagram	
28	Wiring diagram of the high voltage rectifier	
29	Wiring diagram of the ignition rectifier	
30	H.F. circuit diagram	
31	Electron paths in multicavity magnetron	
32	Cavity resonator	
33	General view of magnetron generator	
34	Cross-section view of magnetron MJ-120	
35	Change character of the line input impedance	
36	Input impedance change character of closed line	
37	General view of main concentric line	
38	General view of cavity resonator with discharging valve	
39	Substitute circuit of discharging valve	
40	Disassembled cavity resonator with discharging valve	
41	General view of receiver mixer	
42	Disassembled mixer of receiver	
43	General view of AFC mixer	
44	Disassembled AFC mixer	
45	General view of klystron heterodyne	
46	Klystron diagram with reflecting electrode	
47	Working characteristic of klystron with reflecting electrode	
48	Dependance of output power and frequency oscillations of klystron on reflecting electrode voltage	
49	Disassembled klystron heterodyne	
50	General view of three way ramificator	
51	General view of H.F. stage of transmitter receiver unit in complete state	
52	AFC circuit diagram	
53	Discriminator wiring diagram	

50X1-HUM

NO FOREIGN DISSEM

Fig. no.	Name	Page
54	Conversion of basic discriminator input circuit to the substitute circuit	
55	Full substitute diagram of discriminator	
56	Discriminator frequency characteristic	
57	Grid detector diagram	
58	Voltage change on the grid of grid detector	
59	Circuit diagram of transmitter-receiver unit	
60	General view of AFC unit	
61	The bottom view of AFC unit	
62	General view of transmitter-receiver unit	
63	Top view of transmitter-receiver unit	
64	Bottom view of transmitter-receiver unit	
65	Back view of transmitter-receiver unit with cover	
66	Operation diagram of the range block in search mode	
67	Oscylogram of the forming and pacing of the gate pulses	
68	Diagram of speed sawtooth generator	
69	Sawtooth voltage curves	
70	Slow sawtooth generator circuit diagram	
71	Comparator diode circuit diagram	
72	Limiting character of speed sawtooth pulse	
73	Substitute diagram of differential circuit	
74	Voltage change character in differential circuit output	
75	Circuit diagram of gate pulse generator	
76	Wiring diagram of coincidence stages	
77	Dividing circuits diagram	
78	Contacts of relay 3R1-1 and 3R1-2	
79	Integrator circuit	
80	Circuit diagram of integrating capacity charging and discharging diodes	
81	Voltage change on C_1 at unchanged distance from target	
82	C_1 voltage change at target dismissing	
83	C_1 voltage change during target approach	
84	Circuit diagram of integrator and slow sawtooth limiters	

50X1-HUM

- 247 -

S-E-C-R-E-T

NO FOREIGN DISSEM

50X1-HUM

Fig. no. Name Page

- 85 Pulse character reflected from target and from ground features
- 86 Slow sawtooth voltage change character
- 87 "Memory" circuit
- 88 Impedance circuit ~~3A-83~~ and 3C-50b
- 89 The circuit of automatic gain control (AGC) for noise
- 90 Noise automatic gain control work, spread in time
- 91 Distance determination error relatively to target signal of various amplitude
- 92 Pulse automatic gain control (ARW)
- 93 Cathode follower of AGC circuit
- 94 Circuit diagram of range unit
- 95 General view of range unit
- 96 Bottom view of unit
- 97 View of range unit with cover removed
- 98 Receiver block diagram
- 99 Circuit diagram of JF preamplifier
- 100 Simplified circuit of JF preamplifier
- 101 Frequency characteristic of first circuit with triple mistuned stages
- 102 Circuit diagram of JF amplifier
- 103 Frequency characteristic of second circuit with triple stages mistuning
- 104 JF amplifier frequency characteristic
- 105 Diode detector circuit diagram
- 106 Video amplifier and cathode follower
- 107 General view of JF preamplifier and JF amplifier units
- 108 The bottom view of JF preamplifier
- 109 Bottom view of JF amplifier
- 110 Block diagram of the power supply unit
- 111 Block diagram of the + 400 V rectifier
- 112 Currents and voltages in the + 400 V rectifier circuits
- 113 Circuit of the - 250 V rectifier
- 114 The volt-ampere characteristic of the non-linear resistance

S-E-C-R-E-T

NO FOREIGN DISSEM

S-E-C-R-E-T

NO FOREIGN DISSEM

50X1-HUM

Fig. no.	Name	Page
115	Wiring diagram illustrating the connection of the non-linear resistance	
116	The + 150 V ionic voltage regulator	
117	The + 150 V ionic voltage regulator	
118	The + 105 V ionic voltage regulator	
119	The -150 V ionic voltage regulator	
120	The + 250 V ionic voltage regulator	
121	Time relay	
122	General view of the power supply unit	
123	Power supply unit with removed housing	
124	Supply unit with removed housing	
125	Block diagram of the power supply unit	
126	Control board	
127	Block diagram of the test board	
128	General view of the test board	
129	Test board (bottom)	
130	Location of the SRD-1M range finder units on the MiG-17 F aircraft	
131	The radio range finder SRD-1M block diagram	

- 249 -

S-E-C-R-E-T

NO FOREIGN DISSEM

NO FOREIGN DISSEM

50X1-HUM

XII . LIST OF CONTENTS

- I General
 - 1. Destination and use
 - 2. Range finder set
 - 3. Main technical data
- II Operation principle and cooperation of SRD-1M range finder units
 - 1. Principle of operation
 - 2. Block diagram of the radio range finder
 - 3. Circuit diagram
- III Antenna circuit
 - 1. Destination
 - 2. Operation principle of the dielectric antenna
 - 3. Main technical data of the SRD-1M range finder antenna circuit
 - 4. Antenna circuit construction
- IV Transmitter-receiver unit
 - 1. Destination
 - 2. Unit set
 - 3. Main technical data of the transmitter-receiver unit
 - 4. Description of the units operation
 - 5. Description of the units operation (acc. to main block diagram)
 - 1. Submodulator
 - a/ Blocking generator
 - b/ Cathode follower
 - 2. Modulator
 - 3. High voltage rectifier
 - 4. Rectifier for discharging valve ignition
- HF circuits of transmitter-receiver set
 - 1. Destination and composition
 - 2. Circuit diagram
- Description and construction HF circuit elements
 - 1. Magnetron generator
 - 2. Main concentric line
 - a/ Designation

S-E-C-R-E-T

NO FOREIGN DISSEM

50X1-HUM

- b/ Peculiarities of long line cuts
- c/ Construction and working idea

- 3. Aerial switch
- 4. Receiver mixer
- 5. AFC mixer
- 6. Klystron heterodyne
- 7. Three way ramificator
- 8. Automatic frequency control of klystron (AFC)

Construction of unit

V. Range unit

- Destination of unit
- Basic technical characteristics of unit
- Description of unit work according to diagram
- Work description of unit according to circuit diagram

- 1/Speed sawtooth generator
- 2/Slow sawtooth generator
- 3/Diode comparator
- 4/Gate pulse generator
- 5/Coincidence stages
- 6/Dividing circuits
- 7/Integrating capacity charging and discharging diodes
- 8/Integrator and slow sawtooth limiter
- 9/"Memory" circuit
- 10/Receiver automatic gain control for noise (AGC) (ARW for noise)
- 11/Receiver automatic gain control for pulse (pulse ARW)
- 12/AGC cathode follower

Construction of unit

VI. Receiver

- 1. Destination and composition
- 2. Receiver work description according to block diagram
- 3. Intermediate frequency amplifier
 - a/ Destination and composition
 - b/ Main technical data of IF amplifier
 - c/ Work description of IF amplifier to circuit diagram
 - d/ Detector and video amplifier

S-E-C-R-E-T

NO FOREIGN DISSEM

S-E-C-R-E-T
NO FOREIGN DISSEM

50X1-HUM

Receiver construction

VII. Power supply unit

1. Destination and main technical data
2. The block diagram of the power supply unit
3. Component parts of the power supply unit circuit
 - a/+400 V rectifier
 - b/-230 V rectifier
- Ionic stabilization
 - c/The +150 Volts ionic voltage regulator for supplying the valves of the WPCz and ARCz
 - d/+ 150 ionic voltage regulator for supplying the WPCz valves
 - e/+ 105 V ionic voltage regulator
 - f/- 150 Volts ionic voltage regulator
- Electronic stabilizer of + 250 voltage
4. The high voltage switching on
5. Construction of power supply unit

VIII. Control board

1. Destination and main technical data
2. Block diagram of the control board
3. Construction of the control board

IX. Test board

1. Destination
 2. Block diagram of the test board
- Construction of the test board
Location of range finder units on the aircraft

X. Radio range finder SRD-1M operation description acc. to block diagram

XI Appendix - List of figures

XIII List of contents

S-E-C-R-E-T

NO FOREIGN DISSEM

SECRET
NO FOREIGN DISSEM

50X1-HUM

SECRET
NO FOREIGN DISSEM

SECRET
NO FOREIGN DISSEM

Attachment II to
CSLT-3/714,415
50X1-HUM

**COLLECTION OF DIAGRAMS
FOR RADIO RANGE FINDER TYPE SRD-1M
(English Language)**

34

~~EXCLUDED RECORDS~~
*Return to Archives & Records Center
Immediately After Use*

~~JOB~~ ~~BOX~~

**LIBRARY FILE COPY
DO NOT DESTROY**

SECRET
NO FOREIGN DISSEM

6711

GROUP 1
Excluded from automatic
downgrading and
declassification

S-E-C-R-E-T
NO FOREIGN DISSEM

50X1-HUM

DIAGRAMS COLLECTION
OF RADIORANGE FINDER TYPE BRD-1M



S-E-C-R-E-T
NO FOREIGN DISSEM

NO FOREIGN DISSEM

50X1-HUM

Contents.

	Page
1. Functional diagram of radio range finder SRD-1M	3
2. Block diagram of radio range finder SRD-1M	4
3. List of items	5
4. Circuit diagram of transmitter-receiver unit	23
5. Circuit diagram of distance set	24
5. Circuit diagram of power supply	25
7. Connection diagram of radio range finder	26
8. Dimension and cording diagram	27
9. List of items	28
10. Circuit diagram of No 2 set.	35
11. Wiring diagram of No. 2 set.	36
12. of WPCs	37
13. of APCs	38
14. Circuit diagram of No 3 set.	39
15. List of items	40
16. Wiring diagram of No 4 set	45
17. of WPCs	46
18. of power supply	47
19. Connection diagram of No 5 set	52
20. Wiring diagram of No 6 set	53

S-E-C-R-E-T

NO FOREIGN DISSEM

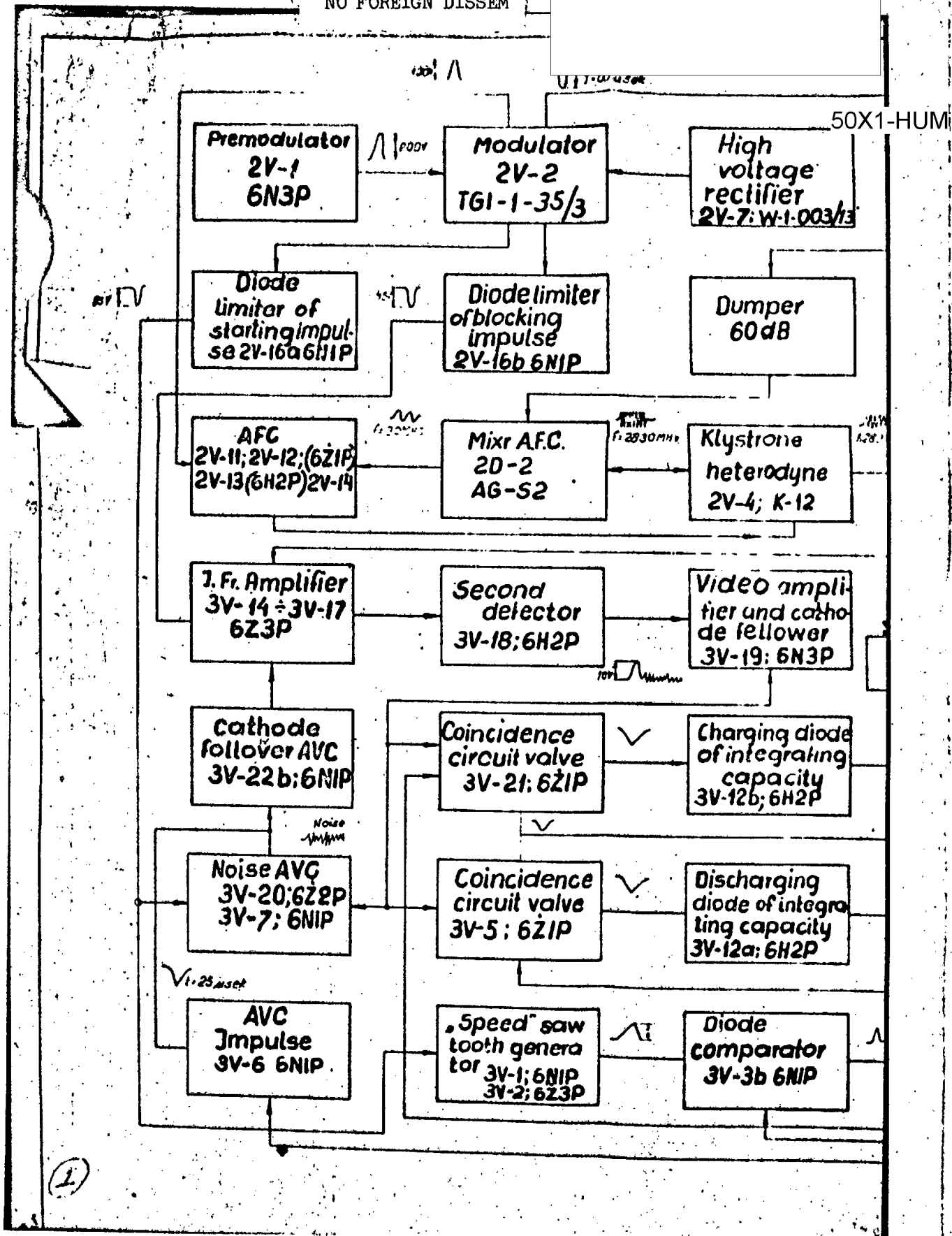

S-E-C-R-E-T
(NO FOREIGN DISSEM)

50X1-HUM

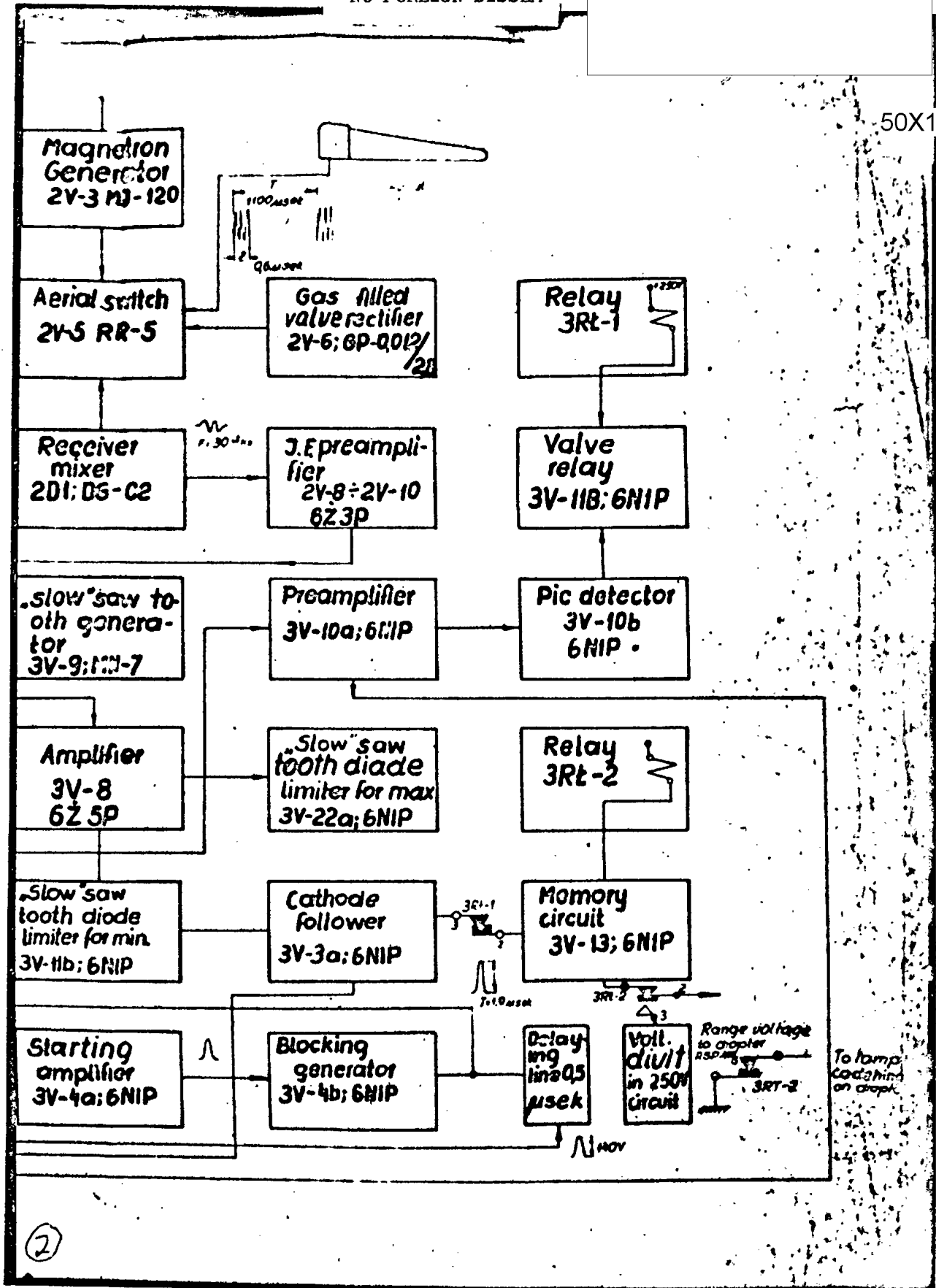

S-E-C-R-E-T
(NO FOREIGN DISSEM)

NO FOREIGN DISSEM

50X1-HUM

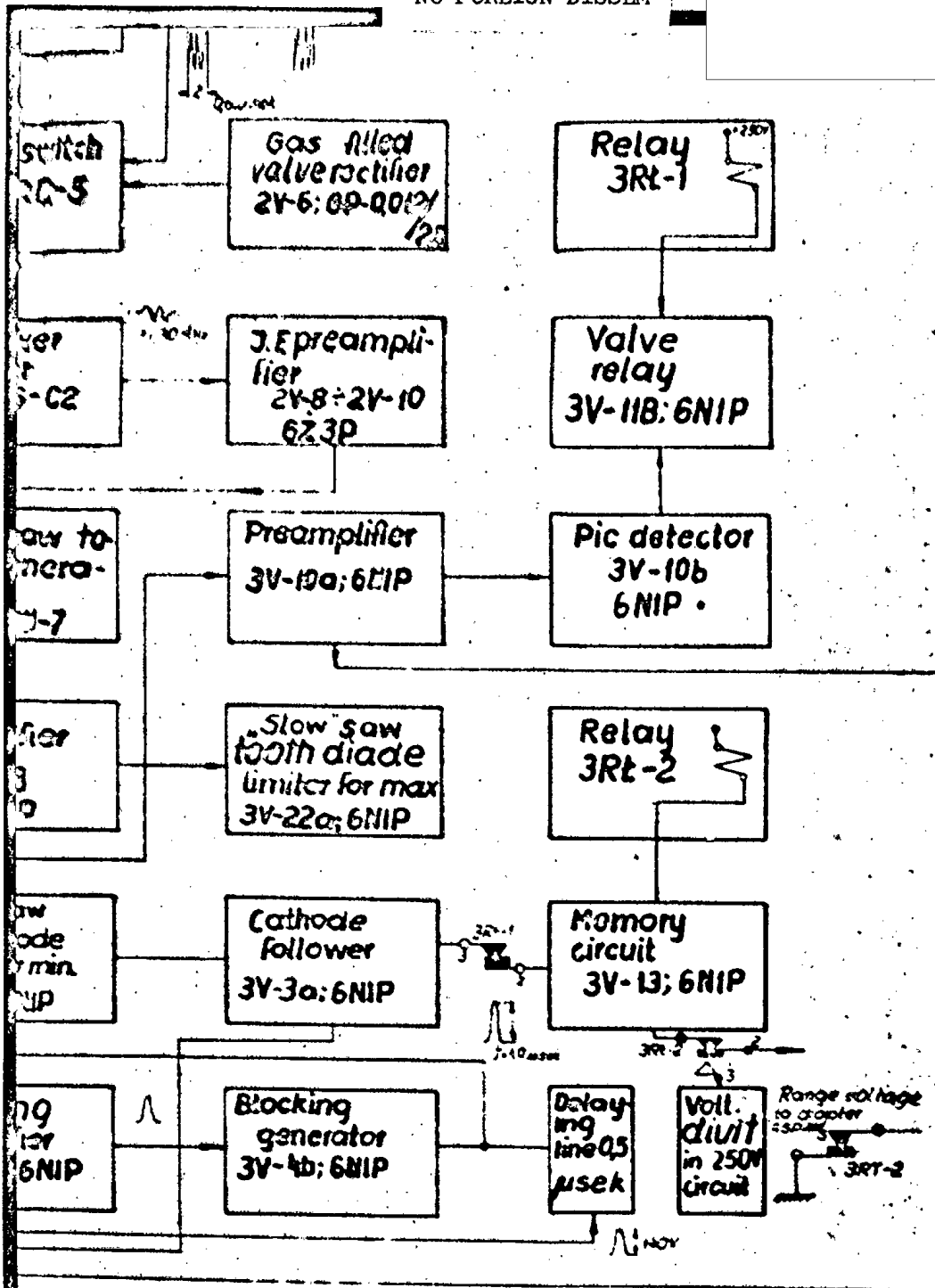

③ Radiorange Finder SRD-1M functional block diagram

GJol.3M.008Sch
page 3

S-E-C-R-E-T
NO FOREIGN DISSEM

S-E-C-R-E-T
NO FOREIGN DISSEM

50X1-HUM

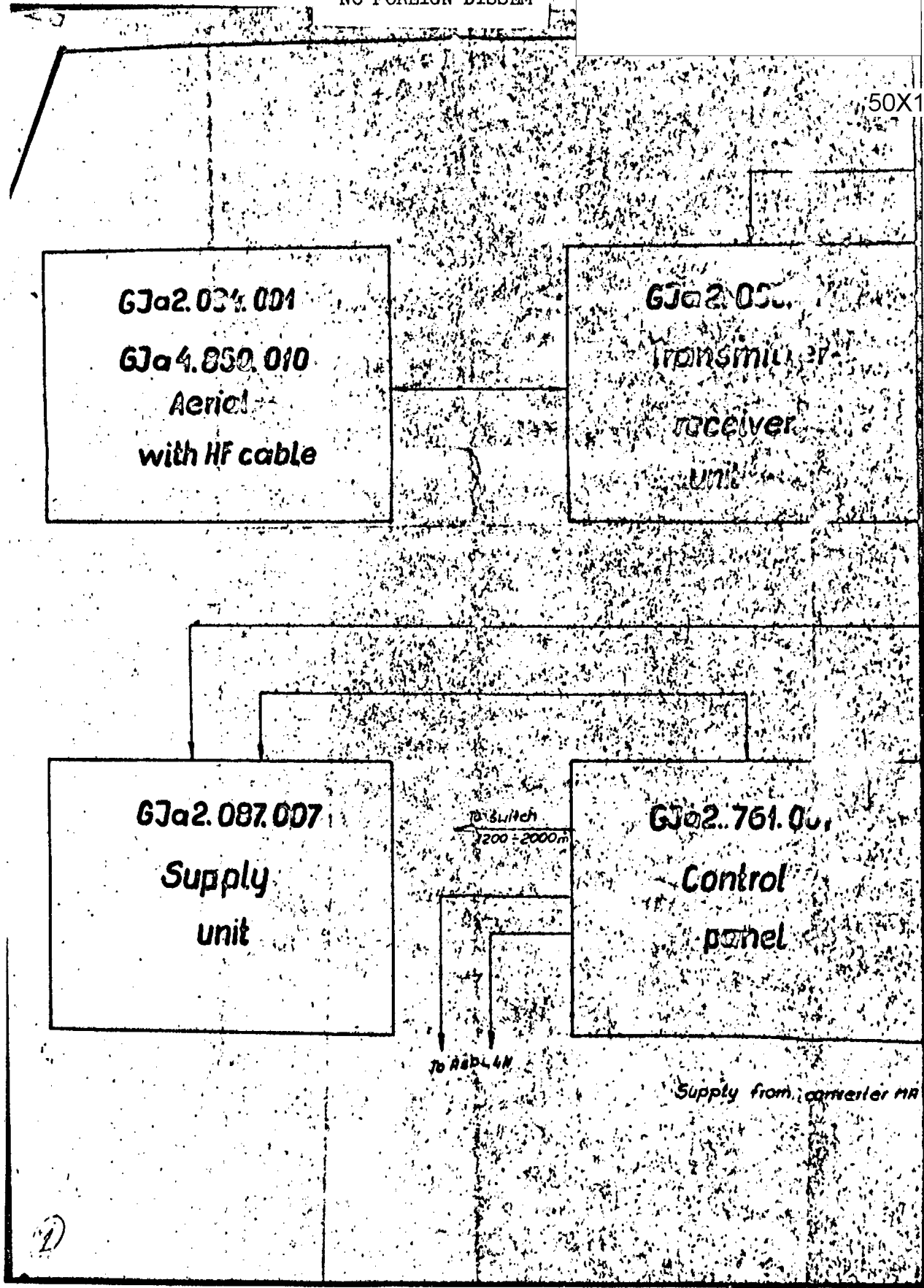

S-E-C-R-E-T
NO FOREIGN DISSEM

NO FOREIGN DISSEM

50X1-HUM

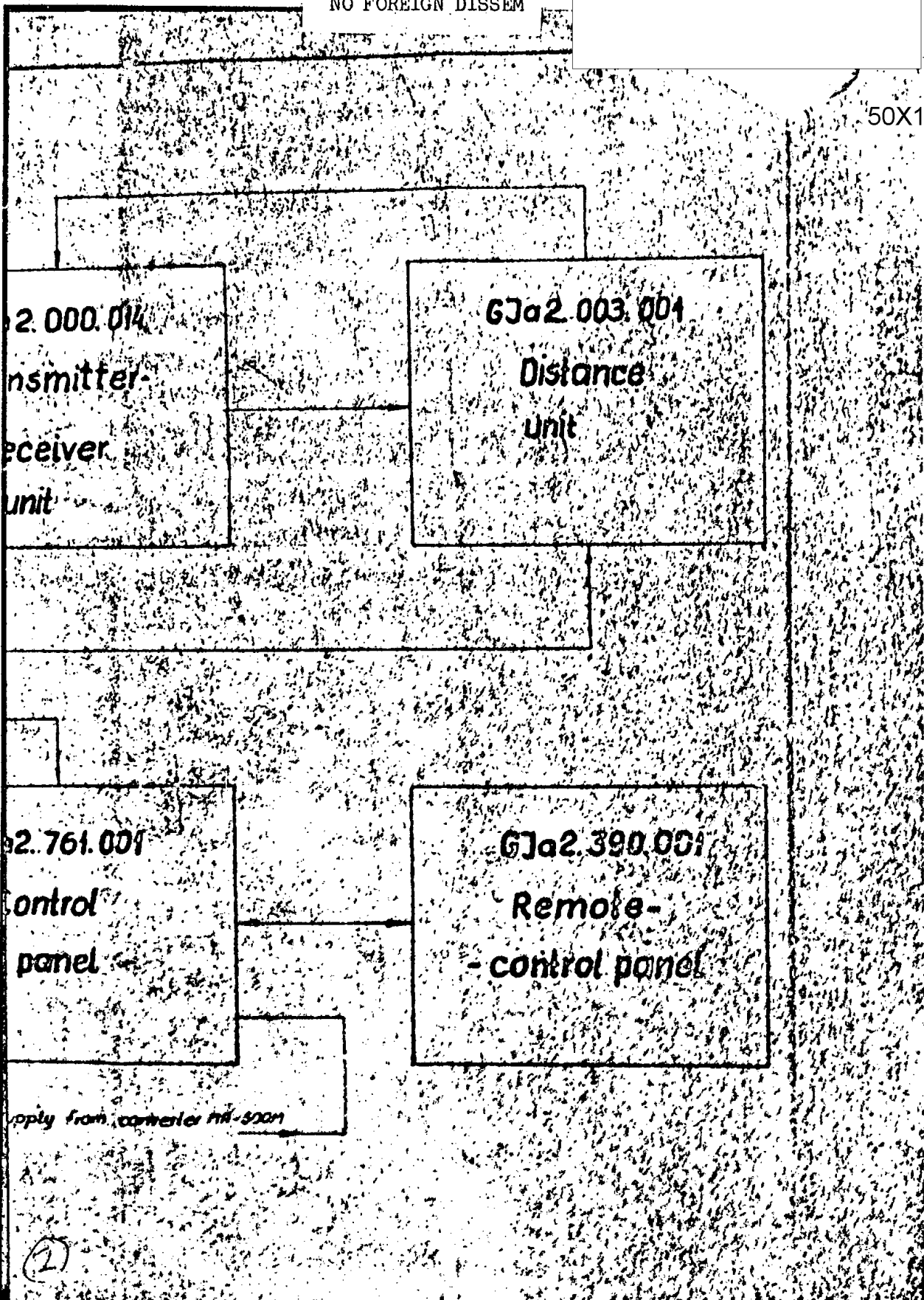

S-E-C-R-E-T

NO FOREIGN DISSEM

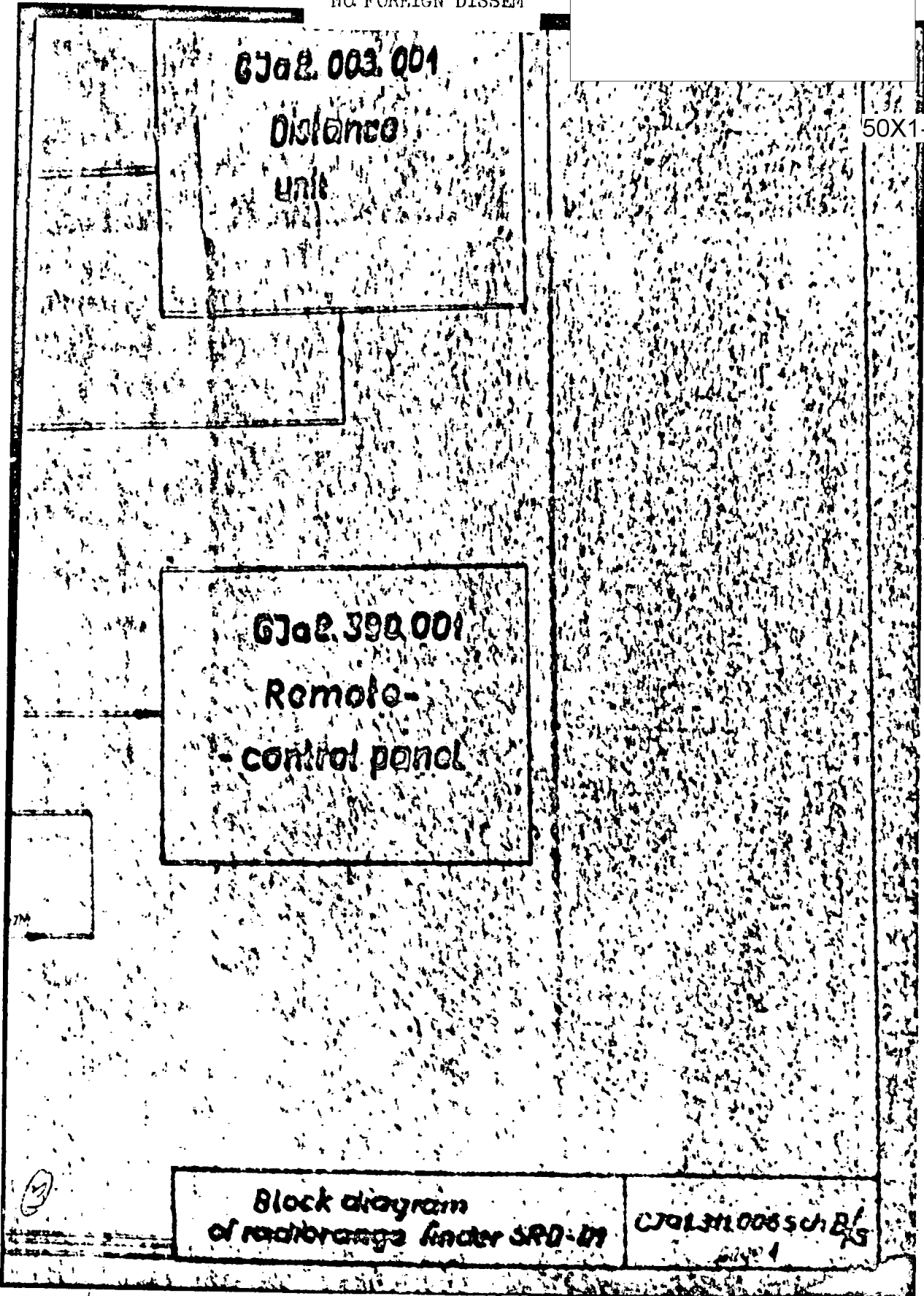

50X1-HUM

S-E-C-R-E-T
NO FOREIGN DISSEM

50X1-HUM

List of items					
Pos. No.	COST. FTU. Cat. norm.	Name and type	Value	Q-ty	Remarks
1	2	3	4	5	6
2R-1	020467.003TU	Resistor MLP-1-120 K Ω -II-B	12K Ω	1	
2R-2	GCST 5574-50	SP-II-2b-220 Ω	220K Ω	1	
2R-3	020467.003TU	" MET-2-240 K Ω -II-B	240K Ω	1	
2R-4	020467.003TU	" MET-2-47 K Ω -II-B	24K Ω	1	
2R-5	020467.003TU	" MIT-2-22K Ω -II-B	2,2K Ω	1	
2R-6	020467.003TU	" MET-2-100 Ω -II-B	100 Ω	1	
2R-7	020467.003TU	" MET-2-62 K Ω -II-B	62K Ω	1	
2R-8	GCST5574-50	" SP-II-2b-1,5-A	1,5K Ω	1	
2R-9	020467.003TU	" MET-2-100 Ω -II-B	100 Ω	1	
2R-10	020467.003TU	" MET-1-100 Ω -II-B	100 Ω	1	
2R-11	020467.003TU	" MET-2-1K Ω -II-B	1K Ω	1	
R-12	020467.003TU	" MET-2-1K Ω -II-B	1K Ω	1	
R-13	020467.003TU	" MET-2-1M Ω -II-B	1M Ω	1	
R-14	020467.003TU	" MET-2-1M Ω -II-B	1M Ω	1	
R-15	020467.003TU	" MET-2-1,5M Ω -II-B	1,5M Ω	1	
R-16	020467.002TU	" MET-2-150K Ω -II-B	150K Ω	1	
R-17	020467.003TU	" MET-1-4,3K Ω -II-B	4,3M Ω	1	
R-18	020467.003TU	" MET-1-4,3M Ω -II-B	4,3M Ω	1	
R-19	020467.003TU	" MET-1-4,7M Ω -II-B	4,7M Ω	1	
R-20	020467.003TU	" MET-1-4,7K Ω -II-B	4,7K Ω	1	
R-21	020467.003TU	" MET-2-220 Ω -I-B	220 Ω	1	
R-22	020467.003TU	" MET-0,5-200 Ω -I-A	200 Ω	1	
R-23	020467.003TU	" MET-0,5-200 Ω -I-A	200 Ω	1	
R-24	020467.003TU	" MET-0,5-220 Ω -I-A	220 Ω	1	
R-25	020467.003TU	" MET-0,5-200 Ω 6I-A	200 Ω	1	
R-26	020467.003TU	" MET-0,5-220 Ω -I-A	220 Ω	1	

Radiorange finder. SKD-1M
 List of items to el. diagram.

5

S-E-C-R-E-T
 NO FOREIGN DISSEM

NO FOREIGN DISSEM

50X1-HUM

1	2	3	4	5	6
2R-27	OZ0467.003TU	Resistor MET-0,5-220Ω-I-A	220 Ω	1	
2R-28	OZ0467.003TU	" MET-C,5-3KΩ-I-A	3K Ω	1	
2R-29	OZ0457.003TU	" MET-C,5-3,2KΩ-II-B	3,2K Ω	1	
2R-30	OZ0467.003TU	" MET-C,5-300Ω-II-B	300 Ω	1	
2R-31	OZ0467.003TU	" MET-C,5-55KΩ-II-B	55K Ω	1	
2R-32	OZ0467.003TU	" MET-0,5-200Ω-II-B	200 Ω	1	
2R-33	OZ0467.003TU	" MET-0,5-1,8KΩ-II-B	1,8K Ω	1	
2R-34	OZ0467.003TU	" MET-C,5-1,5KΩ-II-B	1,5K Ω	1	
2R-35	OZ0467.003TU	" MET-1-100Ω-II-B	100 Ω	1	
2R-36	OZ0467.003TU	" MET-C,5-3,2KΩ-II-B	3,2K Ω	1	
2R-37	OZ0467.003TU	" MET-0,5-220KΩ-II-B	220K Ω	1	
2R-38	OZ0467.003TU	" MET-0,5-1MΩ-II-B	1M Ω	1	
2R-39	OZ0467.003TU	" MET-1-8KΩ-II-B	8K Ω	1	
2R-40	OZ0467.003TU	" MET-0,5-220Ω-II-B	220 Ω	1	
2R-41	OZ0467.003TU	" MET-0,5-11KΩ-II-B	11K Ω	1	
2R-42	OZ0467.003TU	" MET-0,5-12KΩ-II-B	12K Ω	1	
2R-43	OZ0467.003TU	" MET-0,5-100KΩ-II-B	100 Ω	1	
2R-44	OZ0467.003TU	" MET-0,5-100KΩ-II-B	100K Ω	1	
2R-45	OZ0467.003TU	" MET-0,5-470KΩ-II-B	470K Ω	1	
2R-46	OZ0467.003TU	" MET-0,5-15KΩ-II-B	15K Ω	1	
2R-47	OZ0467.003TU	" MET-1,27KΩ-II-B	27K Ω	1	
2R-48	OZ0467.003TU	" MET-0,5-30KΩ-II-B	30K Ω	1	
2R-49	OZ0467.003TU	" MET-0,5-100KΩ-II-B	100K Ω	1	
2R-50	OZ0467.003TU	" MET-0,5-100KΩ-II-B	100K Ω	1	
2R-51	OZ0467.003TU	" MET-0,5-100KΩ-II-B	100K Ω	1	
2R-52	OZ0467.003TU	" MET-0,5-43KΩ-II-B	43K Ω	1	
2R-53	GOST5574-50	" SP-II-2b-33AΩ	33K Ω	1	
2R-54	OZ0467.003TU	" MET-0,5-30KΩ-II-B	30K Ω	1	
2R-55	OZ0467.003TU	" MET-1-33KΩ-II-B	33K Ω	1	
2R-56	OZ0467.003TU	" MET-0,5-470KΩ-II-B	470K Ω	1	
2R-57	OZ0467.003TU	" MET-0,5-220KΩ-II-B	220K Ω	1	
2R-58	OZ0467.003TU	" MET-0,5-300Ω-II-B	300 Ω	1	
2R-59	GJ7.714.001	Tick resistance 50Ω±10%	50 Ω	1	
2R-60	OZ0467.003TU	Resistor MET-2-300Ω-II-B	300 Ω	1	
2R-61	OZ0467.003TU	" MET-1-8,2KΩ-II-B	8,2K Ω	1	±15KΩ
2R-62	OZ0467.003TU	" MET-0,5-200KΩ-I-B	200K Ω	1	

S-E-C-R-E-T

NO FOREIGN DISSEM

NO FOREIGN DISSEM

1	2	3	4	5	6
2R-53	020467.003TU	Resistor M/T-0,5-47K Ω -II-B	47K Ω	1	
2R-54	020467.003TU	" M/T-0,5-43-43K Ω -II-B	43K Ω	1	
2R-55	020467.003TU	" M/T-2-100 Ω -II-B	100 Ω	1	
2C-1	GOST6119-54	Condenser KSO-2-500-1000-G-I	1000pF	1	
2C-2	GOST6118-52	" KBG-J-600-25000	25000pF	1	
2C-3	GOST6119-54	" KSO-8-2500-B-2000-II	2000pF	1	
2C-4	GOST5629-51	" KBGP-2-0,25-II	0,25 μ F	1	
2C-5	GOST6119-54	" KSO-8-500-B-30000-II	30000pF	1	
2C-6	GOST6119-54	" KSO-8-500-B-30000-II	30000pF	1	
2C-7	GOST6119-54	" KSO-8-1500-B-6800-II	6800pF	1	
2C-8	GOST6119-54	" KSO-8-1500-B-6800-II	6800pF	1	
2C-9	GOST6119-54	" KSO-5-250-B-10000-II	10000pF	1	
2C-10	GOST6119-54	" KSO-2-500-D-1000-I	1000pF	1	
2C-11	GOST6119-54	" KSO-2-500-G-1000-I	1000pF	1	
2C-12	GOST6119-54	" KSO-2-500-G-1000-I	1000pF	1	
2C-13	GOST6119-54	" KSO-2-500-G-1000-I	1000pF	1	
2C-14	GOST6119-54	" KSO-2-500-G-1000-I	1000pF	1	
2C-15	GOST6119-54	" KSO-2-500-G-1000-I	1000pF	1	
2C-16	GOST6119-54	" KSO-2-500-G-1000-I	1000pF	1	
2C-17	GOST6119-54	" KSO-2-500-G-1000-I	1000pF	1	
2C-18	GOST6119-54	" KSO-2-500-G-1000-I	1000pF	1	
2C-19	GOST6119-54	" KSO-2-500-G-1000-I	1000pF	1	
2C-20	GOST6119-54	" KSO-2-500-G-1000-I	1000pF	1	
2C-21	GOST6119-54	" KSO-2-500-G-1000-I	1000pF	1	
2C-22	GOST6119-54	" KSO-2-500-G-1000-I	1000pF	1	
2C-23	GOST6119-54	" KSO-2-500-G-1000-I	1000pF	1	
2C-24	GOST6119-54	" KSO-2-250-W-10000-II	10000pF	1	

50X1-HUM

7

S-E-C-R-E-T

NO FOREIGN DISSEM

NO FOREIGN DISSEM

1	2	3	4	5	6
2C-25	GOST6119-54	Condenser KSO-1-250-B-100-II	100 pF	1	
2C-26	GOST6119-54	" KSO-2-500-B-1000-II	1000pF	1	
2C-27	GOST6119-54	" KSO-2-500-B-1000-II	1000pF	1	
2C-28	GOST6119-54	" KSO-2-500-B-1000-II	1000pF	1	
2C-29	GOST6119-54	" KSO-2-500-B-1000-II	1000pF	1	
2C-30	GOST6119-54	" KSO-2-500-B-1000-II	1000pF	1	
2C-31	GOST6119-54	" KSO-2-500-B-1000-II	1000pF	1	
2C-32	GOST6119-54	" KSO-5-500-B-2200-II	2200pF	1	
2C-33	GOST6119-54	" KSO-1-250-B-100-II	100pF	1	
2C-34	GOST6119-54	" KSO-2-500-B-1000-II	1000pF	1	
2C-35	GOST6119-54	" KSO-2-500-B-1000-II	1000pF	1	
2C-36	GOST6119-54	" KSO-1-250-B-220-II	220pF	1	
2C-37	GOST6119-54	" KSO-2-500-B-1000-II	1000pF	1	
2C-38	GOST7159-54	" KTK-1-M-4-II	4pF	1	
2C-39	GOST7159-54	" KTK-1-M-10-II	10pF	1	
2C-40	OZ0462.008TU	" MBGP-1-200-2x0,25-II	0,25μF	1	
2C-41	GOST6119-54	" KSO-1-250-B-100-II	100pF	1	
2C-42	GOST6119-54	" KSO-1-250-B-100-II	100pF	1	
2C-43	GOST6119-54	" KSO-5-250-B-10000-II	10000pF	1	
2C-44	OZ0462.008TU	" MBGP-1-200-2x0,25-II	0,25μF	1	
2C-45	GOST6119-54	" KSO-5-500-B-5600-II	5600pF	1	
2C-46	GOST7159-54	" KTK-1-M-10-II	10pF	1	
2C-47	GOST6119-54	" KSO-5-500-5100-II	5100pF	1	
2C-48	OZ0462.008TU	" MBGP-1-200-2x0,5-II	2x0,5μF	1	
2C-49	OZ0462.008TU	" MBGP-1-200-2x0,5-II	2x0,5μF	1	
2C-50	GOST6119-54	" KSO-2-500B-1000-II	1000pF	1	
2C-51	GOST6119-54	" KSO-2-500B-1000-II	1000pF	1	
2C-52	GOST6119-54	" KSO-5-250B-10000-II	10000pF	1	

50X1-HUM

8

S-E-C-R-E-T

NO FOREIGN DISSEM

NO FOREIGN DISSEM

	IRM-2-2-mont.0,5			
2L-1	TU5/240KB794MAP TJ-21359w	choke	160µH	1
2L-2	TU-7/41 GJ-778003SP	choke	10µH	1
2L-3	TU5/470KB794MAP TU-21359	Circuit coil.	1M µH	1
2L-4	TU-U7/41NJJ-17 TU-21359	Choke D-0,1	20 µH	1
2L-5	TU-U7/41NJJ-17 TU-21359	Choke D-1,2	5 µH	1
2L-6	TU-U7/41NJJ-17 TU-21359	Choke D-1,2	5 µH	1
2L-7	TU-U7/41NJJ-17 TU-21359	Choke D-0,1	10 µH	1
2L-8	TU-U7/41NJJ-17 GJ4.778.002	Choke D-1,2	5 µH	1
2L-9	TU5/170KB794MAP TU-21359	Coil	3.1µH	1
2L-10	TU-U7/41nJJ-17 GJ4.777.001	Choke D-1,2	5 µH	1
2L-11	TU5/170KB794MAP	Coil	3,4 µH	1
2L-12	AR-18-3-1-mont.12	Coil 1,2a	1,3 µH	1
2L-13	GJ4.778.001	Coil 1,2a	2,2 µH	1
2L-14	GJ4.777.002	Coil 1,2a	2,2 µH	1
2L-15	GJ4.777.003	Coil 1,2a	3,5 µH	1
2L-16	IRM-2-2mont.12 UTU-230 TU-21359	Choke D-0,1	2,8 µH	1

50X1-HUM

9

S-E-C-R-E-T

NO FOREIGN DISSEM

NO FOREIGN DISSEM

1	2	3	4	5	6
2L-17	TU-U7/41NJ-17	Choke D-1,2	2 μ H	1	
	1RM-2-2-mont.11				
2L-18	CzTU-23C	Choke D-0,1	4,8 μ H	1	
2V-1	CzTU01-120-54a	Valve 5N3P			
2V-2		Valve TGJ-1-35/5		1	
2V-3	CzTU06.653.52	Valve MJ-120		1	
2V-4	CzTU09.102.52	Valve K-12		1	
2V-5	CzTU12r401.52	Valve RR-5		1	
2V-6	TS3.341.000TU	Valve TH2		1	
2V-7	CzTU13.402.52	Valve W-1-0,03/13		1	
2V-8	CzTU01.116.53	Valve 6Z3P		1	
2V-9	CzTU01.116.53	Valve 6Z3P		1	
2V-10	CzTU01.116.53	Valve 6Z3P		1	
2V-11	CzTU01.103.53	Valve 6Z1P		1	
2V-12	CzTU01.103.53	Valve 6Z1P		1	
2V-13	CzTU01.108.53	Valve 6H2P		1	
2V-14	CzTU01.105.53	Valve 6N1P		1	
2V-15	CzTU01.106.53	Valve 6N2P		1	
2V-16	CzTU01.108.53	Valve 6N1P		1	
2Dr-1	GJ4750002	Loading choke	22 μ H±20%	1	2RM-2-4- -000
2Dr-3	GJ6139.005	Coil with stand	75 μ H	1	2RM-2-0 mont.20
2Dr-4	TJ-21359	Choke 1,2a	5 μ H	1	
2Dr-5	TJ-21359	Choke 1,2a	5 μ H	1	
2Dr-6	TJ-21359	Choke 1,2a	5 μ H	1	
2Dr-7	TJ-21359	Choke 1,2a	5 μ H	1	
2Dr-8	TJ-21359	Choke 1,2a	5 μ H	1	
2LF-1	GJ2066001sp	Forming line		1	2PA-2-3- 000

50X1-HUM

10

S-E-C-R-E-T

NO FOREIGN DISSEM

NO FOREIGN DISSEM

1	2	3	4	5	6
2Tr-1	GJ4715002Sp	HT transformer		1	2RM-2-7-000
2Tr-2	GJ4710001Sp	Filament transformer		1	2RM-2-6-000
2Tr-3	GJ4716001Sp	Ignition transformer		1	2RM-2-5-000
2Tr-4	TJ-0779	Impulse transformer		1	
2Tr-5	GJ4720001Sp	Impulse transformer		1	2RM-2-2-000
2Tr-6	TJ-9575	Transformer		1	
2F6-1	GJ3261001Sp	Heater		1	2RM-2-0-000
2T-1	1RM-2-21-000	Thermoregulator		1	
2P-1	TJ-3765	4 position switch		1	
28K-1	TJ-6753	Blocking switch KM-5A		1	
2D-1	CzTU04.109.52	Cristal detector DG-S2		1	
2D-2	CzTU04.109.52	" " DG-S2		1	
2SzR-1	GJ6.605-195	7 pin plug		1	2RM-2-9-mont.01
2SzR-2	1RM-6-1-mont.01	7 pin socket		1	
2SzR-3	GJ6.605.195	11 pin plug		1	2RM-2-1-3-mont103
2SzR-4	GJ6.604.191	11 pin socket		1	2RM-2-1-3-mont.01
2SzR-5	TU119z-du ^P /J296	Plug SzRG40U16ESz2		1	
Kab.2	GJ4.850.008Sp	HF cable Nr. 2		1	2RM-7-10-000
Kab.2A	GJ4.850.009Sp	HF cable Nr. 2A		1	2RM-7-11-000
Kab.3	GJ4.850.007Sp	HF cable		1	2RM-7-b-000
2M-1	TUz-du ^P /J2359	Ventilator motor 2D-7 /left rev./		1	
	8A751002b.	Magnets MR-394		2	

50X1-HUM

11

S-E-C-R-E-T

NO FOREIGN DISSEM

S-E-C-R-E-T
NO FOREIGN DISSEM

50X1-HUM

1	2	3	4	5
3R-1	OZ0467.003TU	Resistor MET-1-47K Ω -II	47K Ω	1
3R-2	OZ0467.003TU	" MET-1-100K Ω -II	100K Ω	1
3R-5	OZ0467.003TU	" MET-1-300K Ω -II	300K Ω	1
3R-6	OZ0467.003TU	" MET-2-10K Ω -II	10K Ω	1
3R-7	OZ0467.003TU	" MET-1-100K Ω -II	100K Ω	1
3R-8	WT4.685.006	" FP3-11-20 -II	20K Ω	1
3R-10	WP4675001	" PT-1+1%	52K Ω	1
3R-11	WP4675001	" PT-1+1%	56K Ω	1
3R-12	WP4675001	" PT-1+1%	56K Ω	1
3R-13	OZ0467.003TU	" MET-1-200K Ω -II	200K Ω	1
3R-14	OZ0467.003TU	" MET-1-15K Ω -II	15K Ω	1
3R-15	OZ0467.003TU	" MET-1-620K Ω -II	620K Ω	1
3R-16	OZ0467.003TU	" MET-1-24K Ω -II	24K Ω	1
3R-17	OZ0467.003TU	" MET-1-100K Ω -II	100K Ω	1
3R-18	OZ0467.003TU	" MET-1-20K Ω -II	20K Ω	1
3R-19	OZ0467.003TU	" MET-1,3,3K Ω -II	3,3K Ω	1
3R-20	OZ0467.003TU	" MET-1-620K Ω -II	620K Ω	1
3R-21	OZ0467.003TU	" MET-1-20K Ω -II	20K Ω	1
3R-22	OZ0467.003TU	" MET-1-10K Ω -II	10K Ω	1
3R-23	OZ0467.003TU	" MET-1-10K Ω -II	10K Ω	1
3R-24	OZ0467.003TU	" MET-1-1K Ω -II	1K Ω	1
3R-25	OZ0467.003TU	" MET-1-22K Ω -II	22K Ω	1
3R-26	OZ0467.003TU	" MET-1-75K Ω -II	75K Ω	1
3R-27	OZ0467.003TU	" MET-1-51K Ω -II	51K Ω	1
3R-28	OZ0467.003TU	" MET-1-2M Ω -II	2M Ω	1

S-E-C-R-E-T
NO FOREIGN DISSEM

NO FOREIGN DISSEM

1	2	3	4	5	5
3R-29	OZ0467.003TU	Resistor MET-1-510K Ω -II	510K Ω	1	
3R-30	OZ0467.003TU	" MET-1-3,3M Ω -II	3,3M Ω	1	
3R-31	OZ0467.003TU	" MET-1-1,8M Ω -II	1,8M Ω	1	18 \pm 3,9 \pm 10%
3R-33	WT4.685.006	" PP3-10-10%	10K Ω	1	
3R-34	OZ0467.003TU	" MET-1-470K Ω -II	470K Ω	1	
3R-35	OZ0467.003TU	" MET-2-20K Ω -II	20K Ω	1	
3R-36	OZ0467.003TU	" MET-1-1M Ω -II	1M Ω	1	
3R-37	OZ0467.003TU	" MET-1-470K Ω -II	470K Ω	1	
3R-38	OZ0467.003TU	" MET-1-20K Ω -II	20K Ω	1	
3R-39	OZ0467.003TU	" MET-1-51K Ω -II*	51K Ω	1	63K Ω \pm 10% 110K Ω \pm 10%
3R-40	OZ0467.003TU	" MET-1-510K Ω	510K Ω	1	
3R-41	OZ0467.003TU	" MET-1-470K Ω -II	470K Ω	1	
3R-42	OZ0467.003TU	" MET-1,2,7M Ω	2,7M Ω	1	
3R-43	OZ0467.003TU	" MET-1-1M Ω -II	1M Ω	1	
3R-44	OZ0467.003TU	" MET-1-1M Ω -II	1M Ω	1	
3R-45	OZ0467.003TU	" MET-1-1M Ω -II	1M Ω	1	
3R-46	OZ0467.003TU	" MET-1-330K Ω -II	330K Ω	1	
3R-47	OZ0467.003TU	" MET-0,5-220 Ω -I	220 Ω	1	
3R-48	OZ0467.003TU	" MET-0,5-4700 Ω -I*	4700 Ω	1	2K Ω \pm 10% 51K Ω \pm 10%
3R-49	OZ0467.003TU	2 MET-0,5-200 Ω -I-A	200 Ω	1	
3R-50	OZ0467.003TU	" MET-0,5-220 Ω -I	220 Ω	1	
3R-51	OZ0467.003TU	" MET-0,5-220 Ω -I	220 Ω	1	
3R-52	OZ0467.003TU	" MET-0,5-5,6K Ω -I*	5,6K Ω	1	2K Ω \pm 10% 5,6K Ω \pm 10%
3R-53	OZ0467.003TU	" MET-0,5-200 Ω -I-A	200 Ω	1	
3R-54	OZ0467.003TU	" MET-0,5-220 Ω -I	220 Ω	1	
3R-55	OZ0467.003TU	" MET-0,5-6800 Ω -I*	6800 Ω	1	5,6K Ω \pm 10% 12K Ω \pm 10%
3R-56	OZ0467.003TU	" MET-0,5-200 Ω -I	200 Ω	1	

50X1-HUM

13

S-E-C-R-E-T

NO FOREIGN DISSEM

NO FOREIGN DISSEM

1	2	3	4	5
3R-57	OZ0467.003TU	Resistor MET-0,5-220Ω -I	220Ω	1
3R-58	OZ0467.003TU	" MET-0,5-5100Ω -I*	5100Ω	1 ^{4,7KΩ ± 10%} _{5,2KΩ ± 10%}
3R-59	OZ0467.003TU	" MET-1-2000Ω -I	2000Ω	1
3R-60	OZ0467.003TU	" MET-0,5-220Ω -I	220Ω	1
3R-61	OZ0467.003TU	" MET-0,5-220Ω -I	220Ω	1
3R-62	OZ0467.003TU	" MET-0,5-220Ω -I	220Ω	1
3R-63	OZ0467.003TU	" MET-0,5-2,4KΩ -I*	2,4KΩ	1 ^{4,7KΩ ± 10%} _{2,2KΩ ± 10%}
3R-64	OZ0467.003TU	" MET-0,5-10000Ω -I	10000Ω	1
3R-65	OZ0467.003TU	" MET-0,5-7,5KΩ -I	7,5KΩ	1
3R-66	OZ0467.003TU	" MET-0,5-430KΩ -I	430KΩ	1
3R-67	OZ0467.003TU	" MET-1-560KΩ -II	560KΩ	1
3R-68	OZ0467.003TU	" MET-1-47KΩ -II	47KΩ	1
3R-69	OZ0467.003TU	" MET-1-220KΩ -II	220KΩ	1
3R-70	OZ0467.003TU	" MET-1-20KΩ -II	20KΩ	1
3R-71	WP4.675.001	" PT-1 ± 1%	62KΩ	1
3R-72	WP4.675.004	" PT-0,5 ± 1%	5,1KΩ	1
3R-73	WP4.675.004	" PT-0,5 ± 1%	5,1KΩ	1
3R-74	OZ0467.003TU	" MET-1-20KΩ -II	20KΩ	1
3R-76	OZ0467.003TU	" MET-1-100Ω -II	100Ω	1
3R-79	OZ0467.003TU	" MET-0,5-450KΩ -II	450KΩ	1
3R-80	WP4.675.004	" PT-0,5 ± 1%	5,1KΩ	1
3R-81	WP4.675.004	" PT-0,5 ± 1%	5,1KΩ	1
3R-82	WP4.675.004	" PT-0,5 ± 1%	5,1KΩ	1
3R-83	OZ0467.003TU	" MET-1-1MΩ -II	1MΩ	1
3R-84	OZ0467.003TU	" MET-1-4,7KΩ -II	4,7KΩ	1
3R-85	OZ0467.003TU	" MET-1-20KΩ -II	20KΩ	1

50X1-HUM

S-E-C-R-E-T

NO FOREIGN DISSEM

NO FOREIGN DISSEM

1	2	3	4	5	6
3R-86	OZ0467.003TU	Resistor MET-1-3,3K Ω -II	3,3K Ω	1	
3R-87	OZ0467.003TU	" MET-0,5-220 Ω -II	220 Ω	1	
3R-88	OZ0467.003TU	" MET-0,5-220 Ω -II	220 Ω	1	
3R-89	OZ0467.003TU	" MET-2-51K Ω -II	51K Ω	1	
3R-90	OZ0467.003TU	" MET-1-510K Ω -II	510K Ω	1	
3R-91	OZ0467.003TU	" MET-1-580K Ω -II	580K Ω	1	
3R-92	OZ0467.003TU	" MET-1-150K Ω -II	150K Ω	1	
3R-94	OZ0467.003TU	" PP3-11-20K Ω -II	20K Ω	1	
3R-95	WT4.685.005	" MET-1-1,2K Ω -II	1,2K Ω	1	
3R-96	OZ0467.003TU	" MET-1-47K Ω -II	47K Ω	1	
3R-97	OZ0467.003TU	" MET-1-3,3K Ω -II	3,3K Ω	1	
3R-98	OZ0467.003TU	" MET-1-68K Ω -II	68K Ω	1	
3R-99	OZ0467.003TU	" MET-1-680K Ω -II	580K Ω	1	
3R-101	OZ0467.003TU	" MET-1-100K Ω -II	100K Ω	1	
3R-102	OZ0467.003TU	" MET-1-30K Ω -II	30K Ω	1	
3R-103	OZ0467.003TU	" MET-1-470K Ω -II	470K Ω	1	
3R-104	WTU685.006	" PP3-11-10 \pm 10%	10K Ω	1	
3R-105	OZ0467.003TU	" MET-1-1M Ω -II	1M Ω	1	
3R-106	OZ0467.003TU	" MET-1-430 Ω -II	430 Ω	1	
3R-107	OZ0467.003TU	" MET-1-100 Ω -II	100 Ω	1	
3R-108	OZ0467.003TU	" MET-1-1M Ω -II	1M Ω	1	
3R-109	OZ0467.003TU	" MET-1-100K Ω -II	100K Ω	1	
3R-110	OZ0467.003TU	" MET-1-1K Ω -II	1K Ω	1	
3R-111	OZ0467.003TU	" MET-2-62K Ω -I	62K Ω	1	
3R-112	OZ0467.003TU	" MET-1-62K Ω -I	62K Ω	1	50K Ω 310 Ω 100K Ω
3R-113	OZ0467.003TU	" SP-II-2a-680-13A	680K Ω	1	
3R-114	OOST5574-50	" SP-II-2a-33-13A	33K Ω	1	

50X1-HUM

15

S-E-C-R-E-T

NO FOREIGN DISSEM

NO FOREIGN DISSEM

1	2	3		
3C-1	GOST6119-54	Condenser KSO-5-500G-2200-II	2200pF	1
3C-2	OZ0462.008TU	" MBGP-2-4002x0,1-II	2x0,1μF	1
3C-5	OZ0462.008TU	" MBGP-2-400-2x0,1-II	2x0,1μF	1
3C-6	OZ0462.008TU	" MBGP-2-400-2x0,1-II	2x0,1μF	1
3C-7	GOST6119-54	" KSO-2-500W220-II	220pF	1
3C-8	OZ0462.011TU	" BGM-2x0,01-400-II	0,01μF	1
3C-9	GOST6119-54	" KSO-5-500W-1000-II	1000pF	1
3C-10	OZ0462.011TU	" BGM-2-400-0,01-II	0,01μF	1
3C-11	GOST6119-54	" KSO-2-500W-220-II	220pF	1
3C-12	OZ0462.011TU	" BGM-2-400-0,01-II	0,01μF	1
3C-13	GOST6119-54	" KSO-2-500W-220-II	220pF	1
3C-14	OZ0462.011TU	" BGM-2-400-0,03-II	0,03μF	1
3C-15	OZ0462.008TU	" MBGP-2-200-1-II	1 μF	1
3C-16	OZ0462.008TU	" MBGP-2-200-0,5-II	0,5μF	1
3C-17	GOST6119-54	" KSO-2-500W-1000-II	1000pF	1
3C-18	OZ0462.011TU	" BGM-2-400-0,01-II	0,01μF	1
3C-19a	OZ0462.011TU	" MBGP-2-400-2x0,1-II	2x0,1μF	1
3C-19b	OZ0462.011TU	" MBGP-2-400-2x0,1-II	2x0,1μF	1
3C-20	OZ0462.011TU	" BGM-2-400-0,01-II	0,01μF	1
3C-21	OZ0462.011TU	" BGM-2-400-0,05-III	0,05μF	1
3C-22	OZ0462.008TU	" MBGP-4-200-4,0-II	4μF	1
3C-23	OZ0462.008TU	" KSO-2-500G-1000-I	1000pF	1
3C-24	GOST6119-54	" KSO-2-500G-1000-I	1000pF	1
3C-25	GOST6119-54	" KSO-2-500G-1000-I	1000pF	1
3C-25a	GOST6119-54	" KSO-2-500-1000-I	1000pF	1
3C-25b	GOST6119-54	" KSO-2-500G-1000-I	1000pF	1
3C-27	GOST6119-54	" KSO-2-500G-1000-I	1000pF	1
3C-28	GOST6119-54	" KSO-2-500G-1000-I	1000pF	1

50X1-HUM

16

S-E-C-R-E-T

NO FOREIGN DISSEM

NO FOREIGN DISSEM

1	2	3	4	5	6
3C-29	GOST6119-54	Condenser KSO-2-500G-1000-I	1000pF	1	
3C-30	GOST6119-54	" KSO-2-500G-1000-I	1000pF	1	
3C-30a	GOST6119-54	" KSO-2-500G-1000-I	1000pF	1	
3C-31	GOST6119-54	" KSO-2-500G-1000-I	1000pF	1	
3C-32	GOST6119-54	" KSO-2-500G-1000-I	1000pF	1	
3C-33	GOST6119-54	" KSO-2-500G-1000-I	1000pF	1	
3C-34	GOST6119-54	" KSO-2-500G-1000-I	1000pF	1	
3C-35	GOST6119-54	" KSO-2-500G-1000-I	1000pF	1	
3C-36	GOST6119-54	" KSO-2-500G-1000-I	1000pF	1	
3C-37	OZ0462.011TU	" BGM-2-400-0,01-II	0,01μF	1	
3C-38	OZ0462.011TU	" BGM-2-400-0,01-II	0,01μF	1	
3C-39	OZ0462.008TU	" MBGP-2-400-0,25-II	0,25μF	1	
3C-41	GOST6119-54	" KSO-2-500-G-1000-I	1000pF	1	
3C-42	GOST6119-54	" KSO-2-500-W-1000-II	1000pF	1	
3C-43	GOST6119-54	" KSO-2-500-G-1000-II	1000pF	1	
3C-44	GOST6119-54	" KSO-2-500-G-1000-II	1000pF	1	
3C-45	GOST6119-54	" KSO-2-500-G-1000-I	1000pF	1	
3C-46	OZ0462.011TU	" BGM-2-400-0,05-II	0,05μF	1	
3C-47	OZ0462.011TU	" BGM-2-400-0,01-II	0,01μF	1	
3C-48	GOST6119-54	" KSO-2-500-G-1000-I	1000pF	1	
3C-50	OZ0462.008TU	" MBGP-2-200-2x0,5-II	2x0,5μF	1	
3C-51	OZ0462.011TU	" BGM-2-400-0,01-II	0,01μF	1	
3C-52	OZ0462.011TU	" BGM-2-400-0,01-II	0,01μF	1	
3C-54	GOST6119-54	" KSO-5-500b-2200-00	2200pF	1	
3C-55	GOST6119-54	" KSO-2-500-G-120-I	120pF	1	
3C-55	GOST6119-54	" KSO-2-500-G-1000-I	1000pF	1	

50X1-HUM

17

S-E-C-R-E-T

NO FOREIGN DISSEM

NO FOREIGN DISSEM

1	2	3	4	5
3C-57	GOST6119-54	Condenser KSO-2-500-G-1000-I	1000pF	1
3C-58	GOST7159-54	" KTK-1-D-10-II	10pF	1
3C-59	GOST6119-54	" KSO-2-500-F-1000-I	1000pF	1
3C-60	GOST6118-52	" KBCU-200-W-0,03-II	0,03μF	1
3C-61	GOST6119-54	" KSO-2-500-W-150-II	150pF	1
3C-62	GOST6119-54	" KSO-2-500-W-1000-II	1000pF	1
3C-63	GOST6119-54	" KSO-5-500-W-3900-II	3900pF	1
3C-64	GOST6118-52	" KBCU-200-0,3-II	0,03μF	1
3C-65	GOST6119-54	" KSO-5-500-W-4700-II	4700pF	1
3C-66	GOST6119-54	" KSO-5-500-W-5100-II	5100pF	1
3C-67				
3C-68	OZ0462.011TU	" BGM-2-400-0,01-II	0,01pF	1
3L-1	IRM-3-2-z0,3	Circuit coil		1
3L-2	IRM-3-2-z0,4	" "		1
3L-3	IRM-3-2-z0,2	" "		1
3L-4	IRM-3-2-z0,4	" "		1
3L-5	IRM-3-2-z0,5	" "		1
3L-6	SzJ-21359	Choke D-0,1-100μH	100μH	1
3L-8	SzJ-21359	Choke D-1,2	5μH	1
3L-9	SzJ-21359	" D-1,2	5μH	1
3L-10	SzJ-21359	" D-1,2	5μH	1
3L-11	SzJ-21359	" D-1,2	5μH	1
3L-13	SzJ-21359	" D-1,2	5μH	1
3L-14	SzJ-21359	" D-1,2	5μH	1
3L-15	SzJ-21359	" D-1,2	5μH	1

50X1-HUM

18

S-E-C-R-E-T

NO FOREIGN DISSEM

NO FOREIGN DISSEM

50X1-HUM

1	2	3	4	5	6
3L-17	SZJ-22820	Choke D-0,33	330uH	1	
3V-1	CzTUN0110553	Valve type 6N1P		1	
3V-2	CzTUN0111653	" " 6Z3P		1	
3V-3	CzTUN0110553	" " 6N1P		1	
3V-4	CzTUN0110553	" " 6N1P		1	
3V-5	CzTUN0110353	" " 6Z1P		1	
3V-6	CzTUN0110553	" " 6N1P		1	
3V-7	CzTUN0110553	" " 6N1P		1	
3V-8	CzTUN0111653	" " 6Z5P		1	
3V-10	CzTUN0110553	" " 6N1P		1	
3V-11	CzTUN0110553	" " 6N1P		1	
3V-12	CzTUN0110853	" " 6H2P		1	
3V-13	CzTUN0110553	" " 6N1P		1	
3V-14	CzTUN0111653	" " 6Z3P		1	
3V-15	CzTUN0111653	" " 6Z3P		1	
3V-16	CzTUN0111653	" " 6Z3P		1	
3V-17	CzTUN0111653	" " 6Z3P		1	
3V-18	CzTUN0110853	" " 6H2P		1	
3V-19	CzTUN112054	" " 5N3P		1	
3V-20	CzTUNC110453	" " 6Z2P		1	
3V-21	CzTUN0110353	" " 6Z1P		1	
3V-22	CzTUN0110553	" " 6N1P		1	
3V-9	TU1-3-19	Neon lamp MN-7		1	

19

S-E-C-R-E-T

NO FOREIGN DISSEM

S-E-C-R-E-T
NO FOREIGN DISSEM

50X1-HUM

1	2	3	4	5	6
3D-1		Detector DCG-4		1	
3TF-1	TU-0779	Impulse transformer			
	GJ4510001Sp	Relay		2	
3P4-1	GJ2065002Sp	Delaying line 0,5 msec.	1000- Ω	1	
3SzR-1	1RM-3-2-z0,2	Socket		1	
3ZsR-2	TU119 ₂₉₅	" SzRG40PK16ESz2		1	
3SzR-3	TU102 ₂₉₆	Plug SzR48PK26ESz2		1	

Remarks: Items marked /x/ should
be chosen when tuning.
/xx/ are fitted in the thermic relay unit.

S-E-C-R-E-T
NO FOREIGN DISSEM

S-E-C-R-E-T
NO FOREIGN DISSEM

1	2	3	4	5	6
4R-1	OZ0467003TU	Resistor MTT-1-270K Ω -II	270K Ω	1	
4R-2	OZ0467003TU	" MTT-2-20K Ω -II	20K Ω	1	
4R-3	WP467001Sp	" PT-1-33K Ω \pm 1%	33K Ω	1	
4R-4	WP475001Sp	" PT-1-56K Ω \pm 1%	56K Ω	1	
4R-5	WP4635006	" PP3-11-10K Ω \pm 10%	10K Ω	1	
4R-6	WP4675001Sp	" PT-1-68K Ω \pm 1%	68K Ω	1	
4R-7	NO467000TU	" PEV-20-40K Ω -II	40K Ω	1	
4R-8	NO467000TU	" PEV-20-7K Ω -I	7K Ω	1	
4R-9	NO467000TU	" PEV-10-2,5K Ω -II	2,5K Ω	1	
4R-11	OZ0467003TU	" MTT-0,5-220K Ω -II	220K Ω	1	
4R-12	OZ0467003TU	" MTT-0,5-220 Ω -II	220 Ω	1	
4R-13	NO467000TU	" PEV-20-7,5K Ω -II	7,5K Ω	1	
4R-14	OZ0467003TU	" MTT-1-330K Ω -II	330K Ω	1	
4C-1	OZ0462008TU	Condensar MBGP-1-600-2-II/A	2 μ F	1	
4C-2	OZ0462008TU	" MBGP-1-600-1-II-A	1 μ F	1	
4C-3	OZ0462008TU	" MBGP-2-450-0,5-II/A	1,0 μ F	1	
4C-4	OZ0462008TU	" MBGP-2-400-0,25-II/A	0,25 μ F	1	
4C-5	OZ0462008TU	" MBGP-1-400-2-II/A	2 μ F	1	
4C-6	QOST5119-54	" KSO-5-250-G-10000-II	10000pF	1	
4C-7	QOST7159-54	" KTK-1K-18-II	18pF	1	
4C-8	OZ0462008TU	" MBGP-1-400-2-II	2 μ F	1	
4C-9	OZ0462008TU	" MBGP-2-260-1-II	1 μ F	1	
4C-10	OZ0462008TU	" MBGP-7-260-1-II	1 μ F	1	
4V-1	G2TU0122454	Kenotron 5C9C		1	
4V-2	G2TU0175452	" 6C4P		1	
4V-3	G2TU0111054	Beam thetrode 6P3S		1	
4V-4	G2TU0110653	Double triode 6N2P		1	

50X1-HUM

21

S-E-C-R-E-T
NO FOREIGN DISSEM

NO FOREIGN DISSEM

50X1-HUM

1	2	3	4	5	6
4V-5	CzTU0210153	Stabiliser SG1P		1	
4V-6	CzTU0270054	" SG1P			
4V-7	CzTU0270054	" SG1P			
4V-8	CzTU0270154	" 8G3S		1	
4V-9	CzTU0111054	Valve 5P3S		1	
4V-10	CzTU0122454	Rectifying valve 509S		1	
4TP-1	GJ47150013p	Transformer		1	
	/2RX-4-7-000/				
4Dr-1	1RE-4-5-000	Choke		1	
4Dr-2	1RE-4-4-000	"		1	
4R-1	AR40-50-000	Relay		1	
4R-2	TU-15015	"		1	
4TRP-1	AR18-2-55-000/A	Thermic relay		1	
4Pr-1	GOST5010-53	Fuse PG-30-1	1A	1	
4Pr-2	GOST5010-53	" PK-30-0,15	0,15A		
	KAP				
4S2r-1	TU1023 296	Socket SzR48PK2BESz2		1	
	KAP				
4S2s-2	TU-1023 295	Plug SzR48PK2BESz2		1	

S-E-C-R-E-T
NO FOREIGN DISSEM

S-E-C-R-E-T
NO FOREIGN DISSEM

50X1-HUM

1	2	3	4	5	6
5R-1	OZ0467003TU	Resistor WLT-1-51K2-II		51K-1	
5PR-1		Button 5K			1
5P-1	WT3602005Sp	Two way switch			1
5P-2	WT3602005Sp	"			1
5P-3	WT3602005Sp	"			1
6L-1		Eulb.			
		SM-31TU-1-3-108 z-d P/J 410b			1

S-E-C-R-E-T
(NO FOREIGN DISSEM)

50X1-HUM

1	2	3	4	5
6R-1	GOST5574-50	Resistor SP-II-2a-47A-13	47KΩ	1
6R-2	OZ0467003TU	" RT-1-82KΩ-IIA	82KΩ	1
6R-3	WT4685006Sp	" PP3-11-560Ω ± 10%	560Ω	1
6R-4	WT4685006Sp	" PP3-11-20KΩ ± 10%	20KΩ	1
6R-5	GOST5574-50	" SP-II-2a-6,8A-13	6,8KΩ	1
6R-6	OZ0467003TU	" RT-100KΩ-IIA	100KΩ	1
6R-7	OZ0467003TU	" RT-51KΩ-IIA	51KΩ	1
6R-8	OZ0467003TU	" RT-1-15KΩ-IIA	15KΩ	1
6R-9	WP3675004Sp	" PT-0,5-62KΩ-1%	62KΩ	1
6R-10	GOST5574-50	" SP-II-2A-68A-13	68KΩ	1
6C-1	GOST6118-52	Condenser KBGU-200-0,1-II	0,1μF	1
6C-2	GOST6118-52	" KBFU-200-0,1-II	0,1μF	1
6S2r-1	TU102P/J296	Socket SzR48PK26LSz2		1
6S2r-2	TU102P/J296	Plug SzR28PK7ESz9		1
6S2r-3	TU102P/J296	Socket SzR36PK15ZC4		1
6S2r-4	TU102P/J296	" SzR32PK12K3z1		1
6S2r-5	TU102P/J296	" SzR28PK7ESz9		1
6S2r-6	TU102P/J296	Plug SzR32PK10ESz2		1
6S2r-7	TU102P/J296	Socket SzR20PK4N08		1
6Pr-1	GOST5010-53	Fuse PC-30-5	5A	1
6Pr-2	TU-A ODD 539053-54	Fuse SP-10a	10A	1
RL-1	TU-15015	Relay		

S-E-C-R-E-T
NO FOREIGN DISSEM

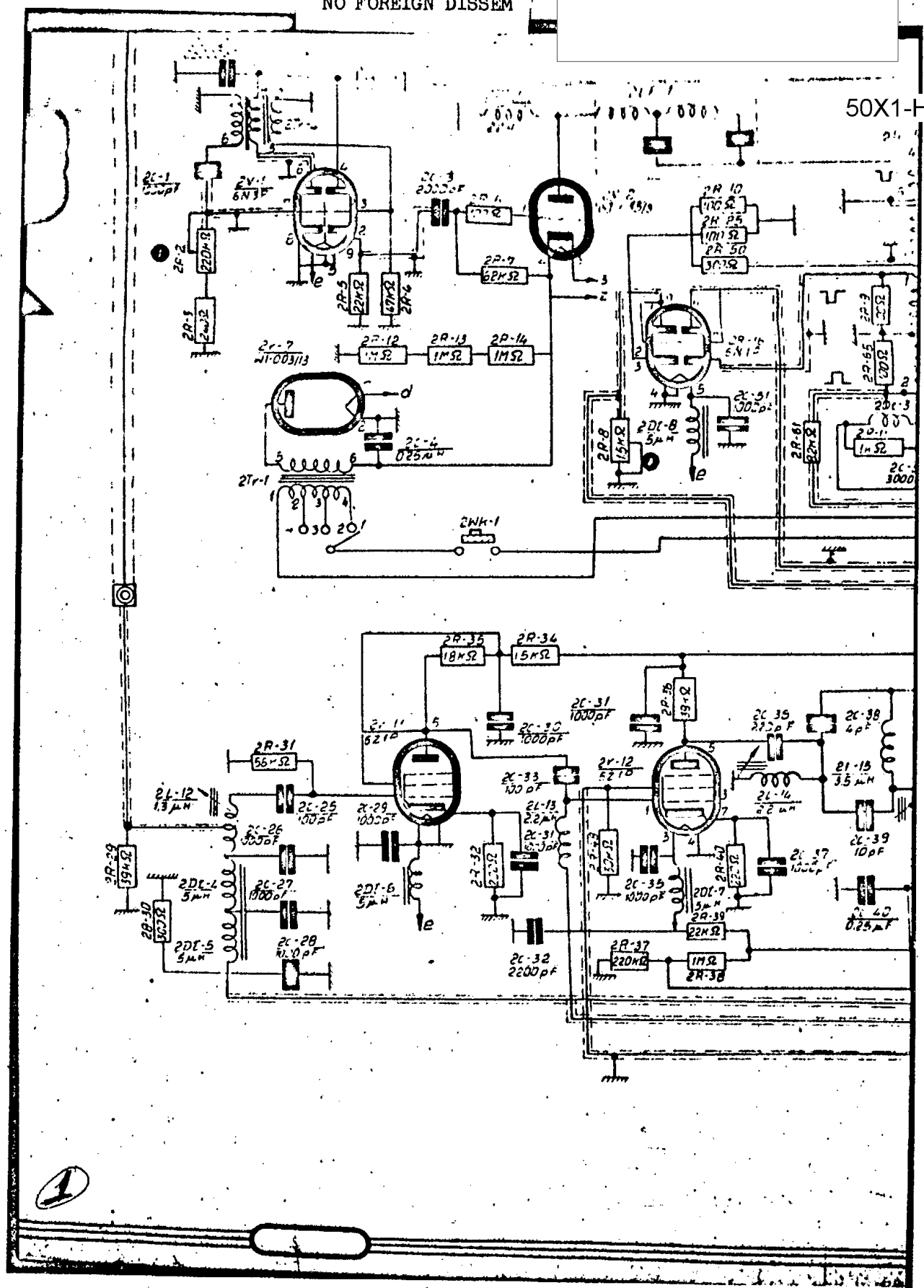

S-E-C-R-E-T
NO FOREIGN DISSEM

50X1-HUM

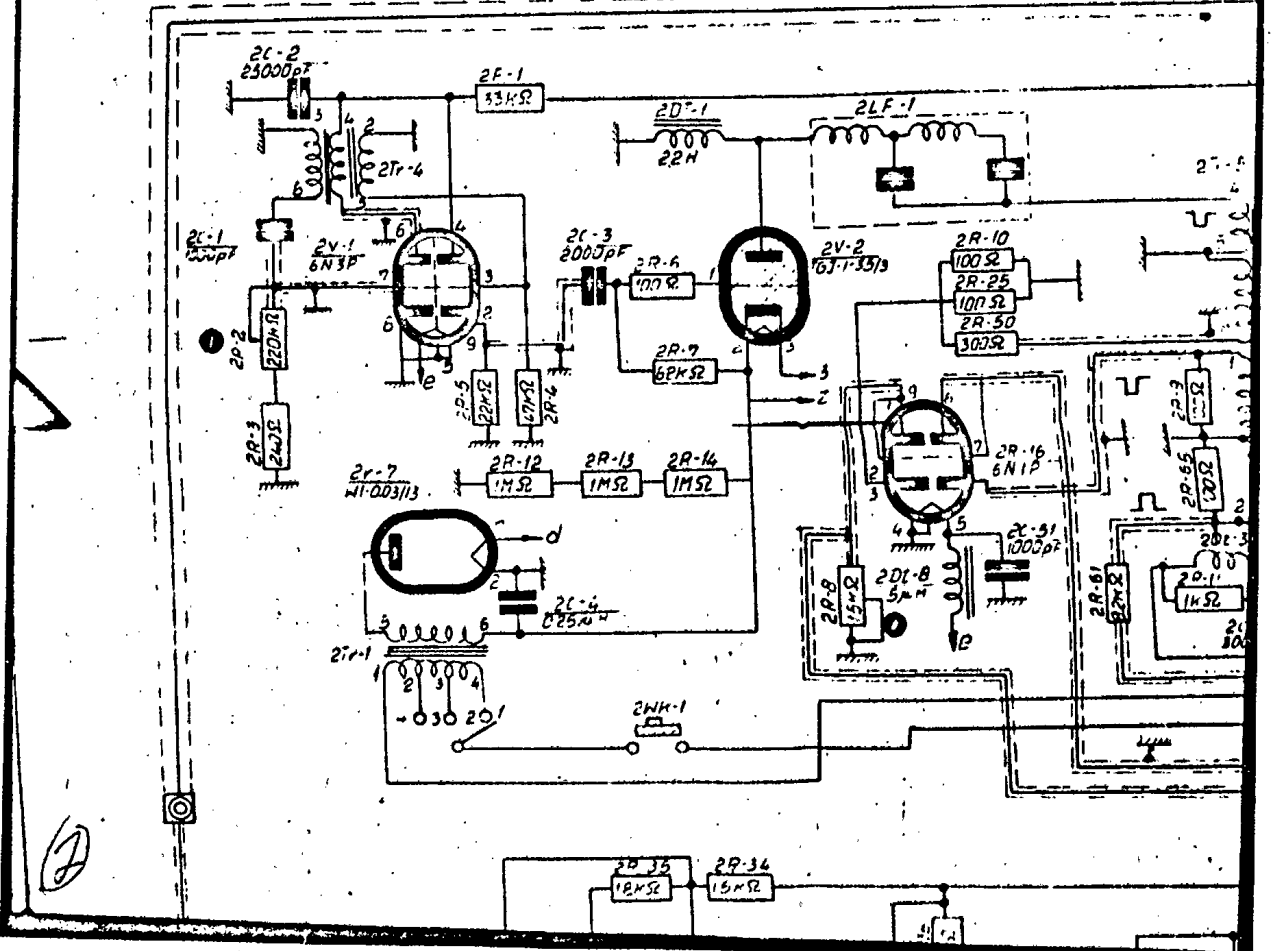
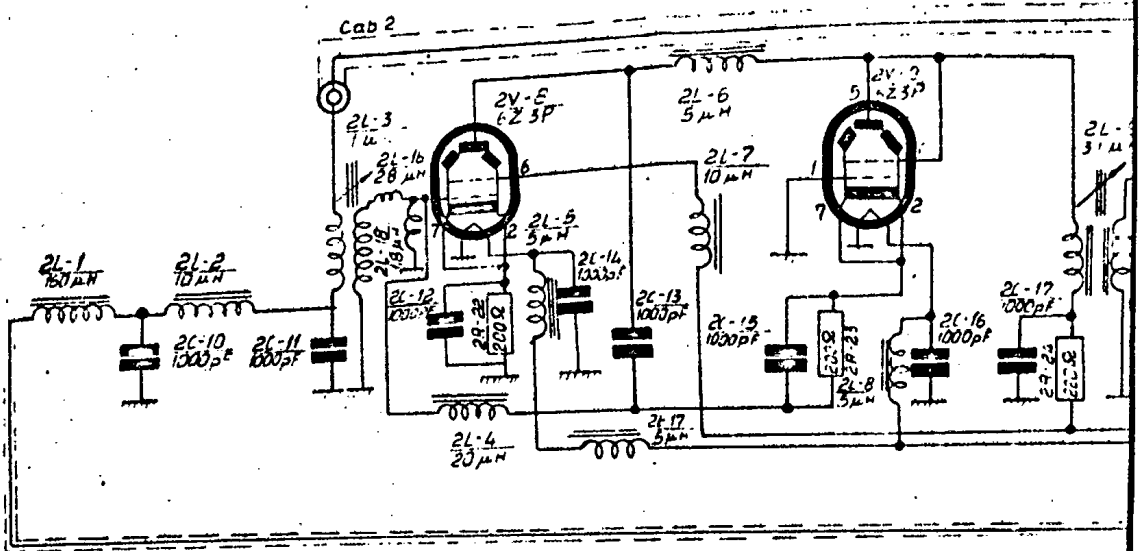

S-E-C-R-E-T
NO FOREIGN DISSEM

NO FOREIGN DISSEM

50X1-HUM

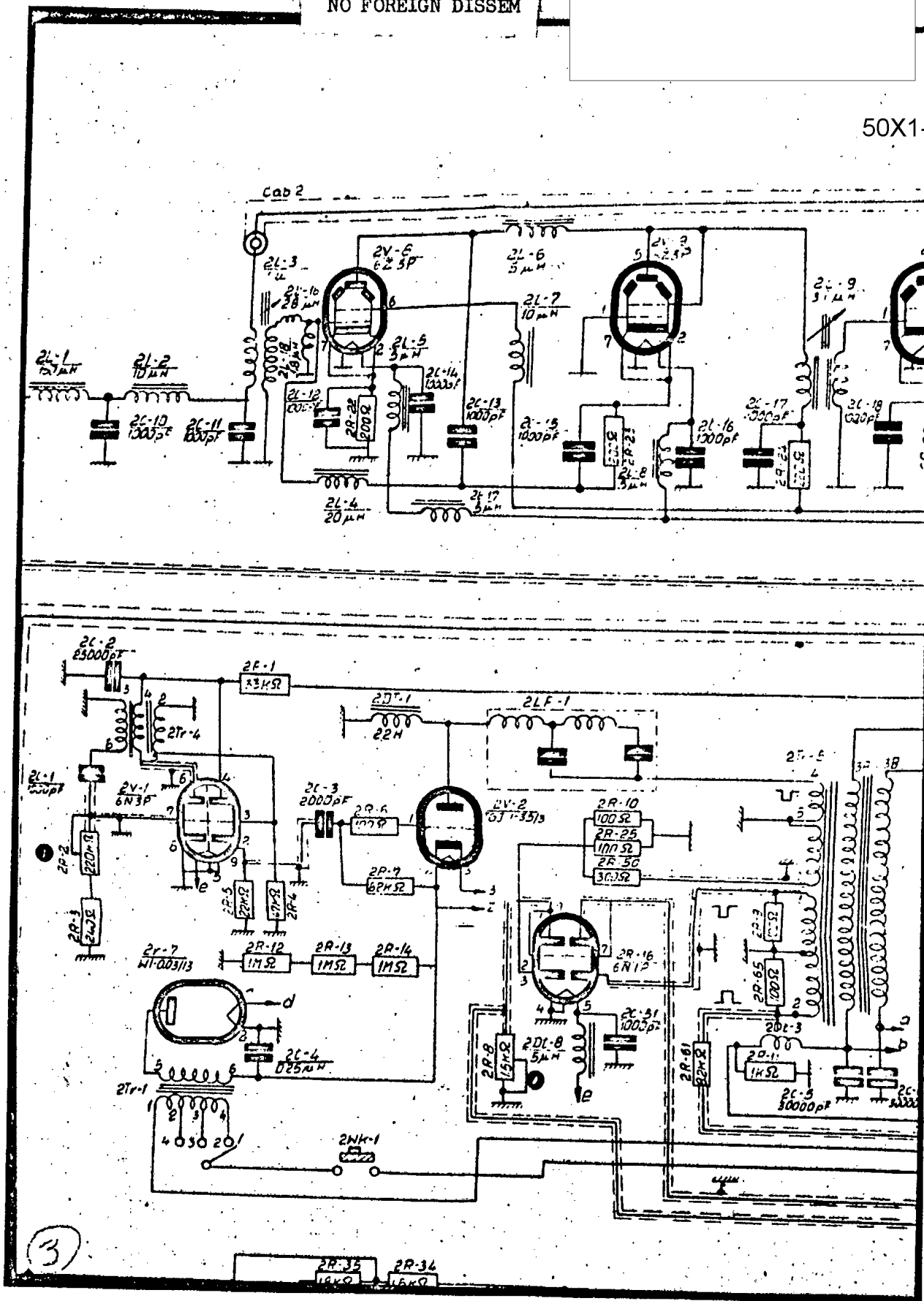

S-E-C-R-E-T

NO FOREIGN DISSEM

NO FOREIGN DISSEM

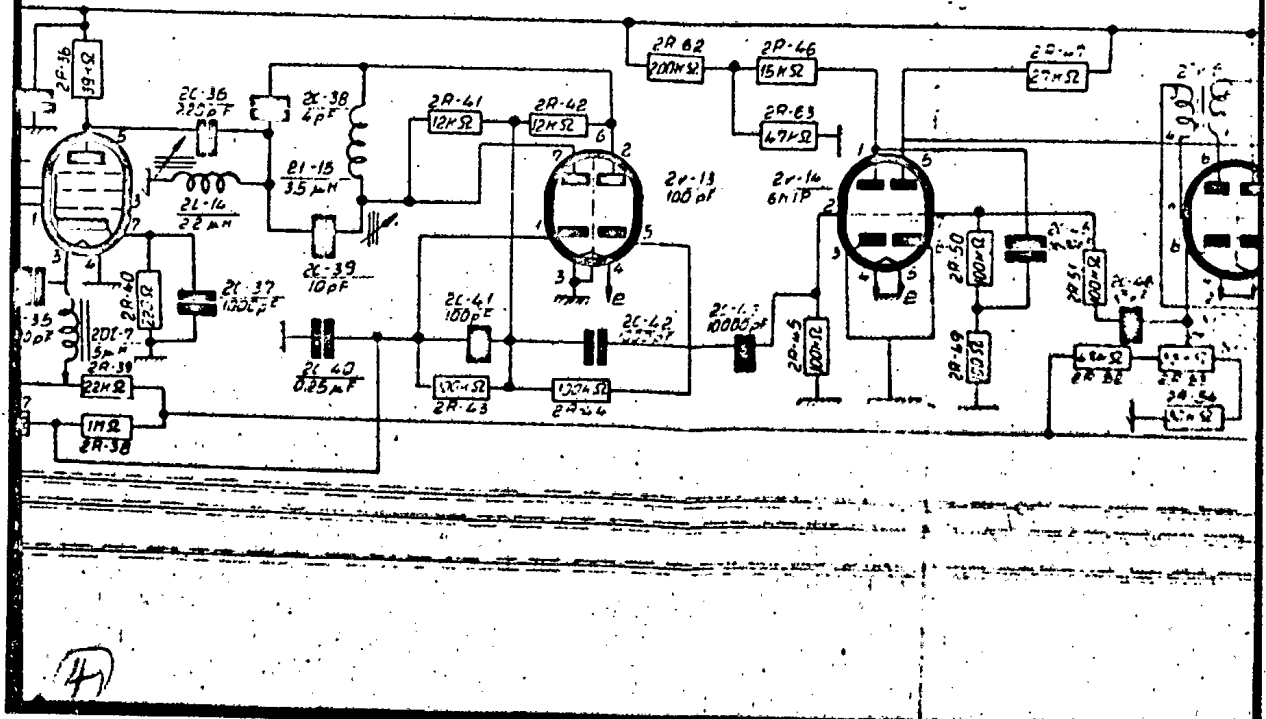
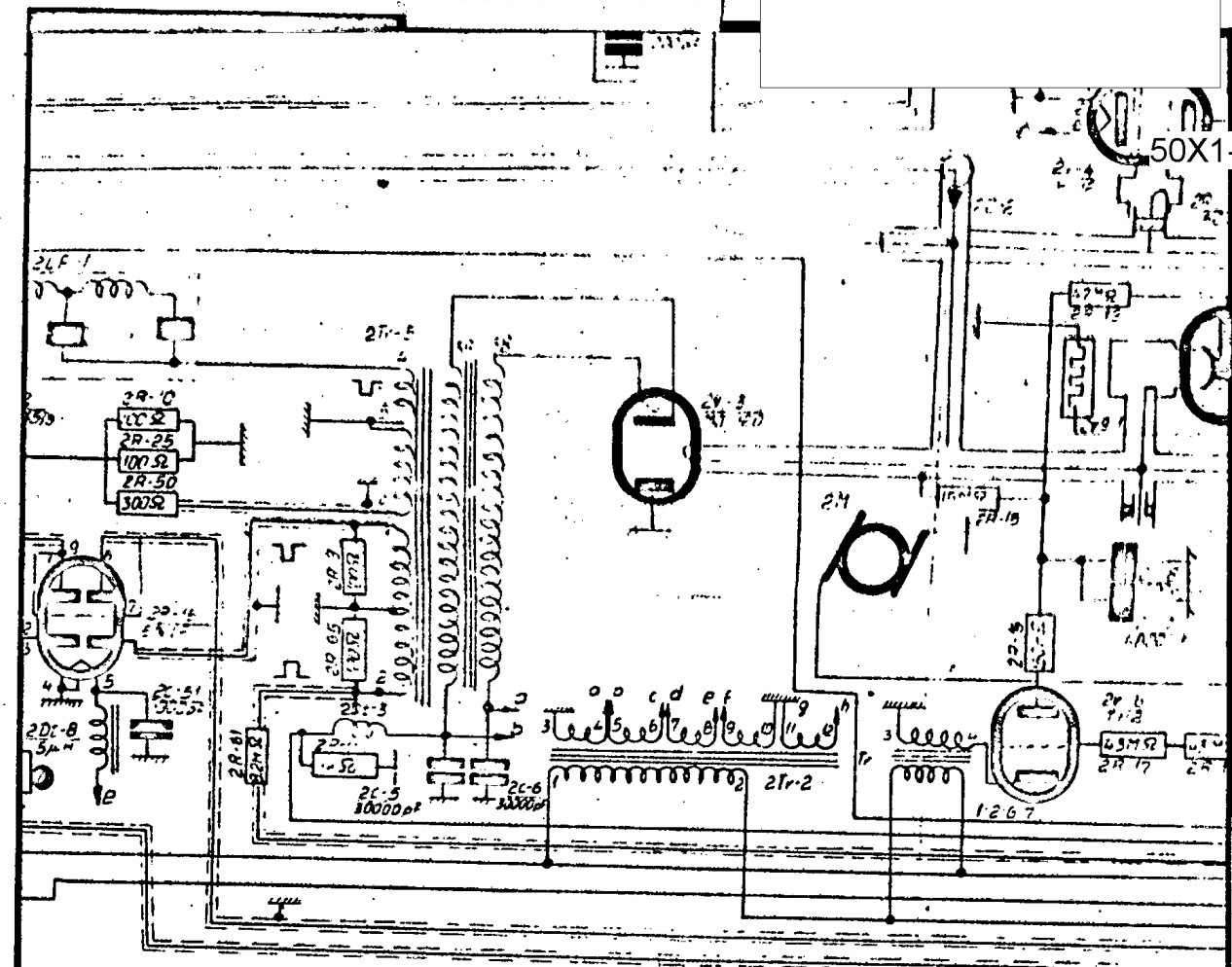

S-E-C-R-E-T

NO FOREIGN DISSEM

NO FOREIGN DISSEM

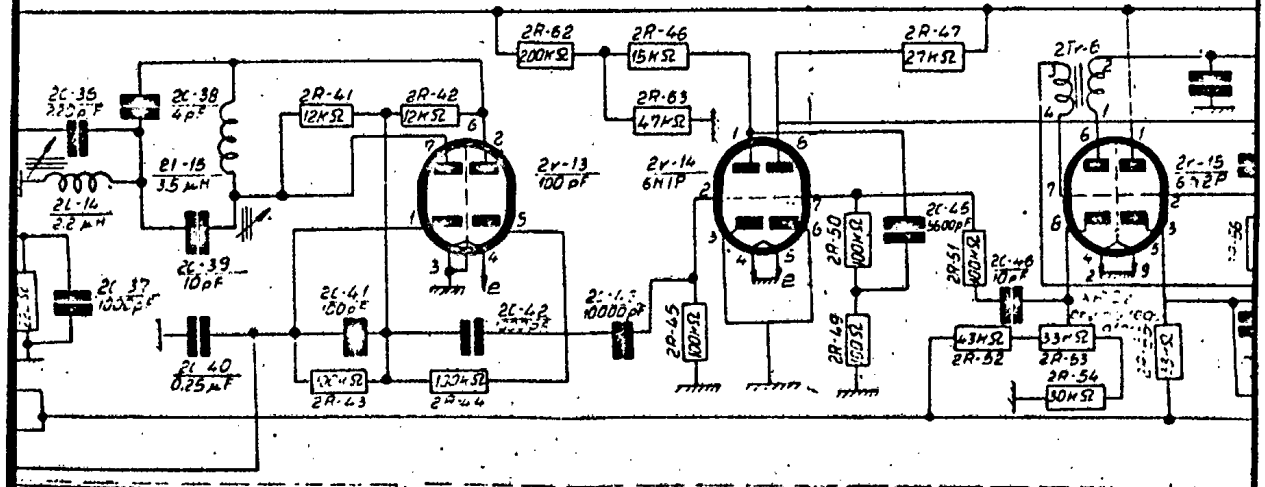
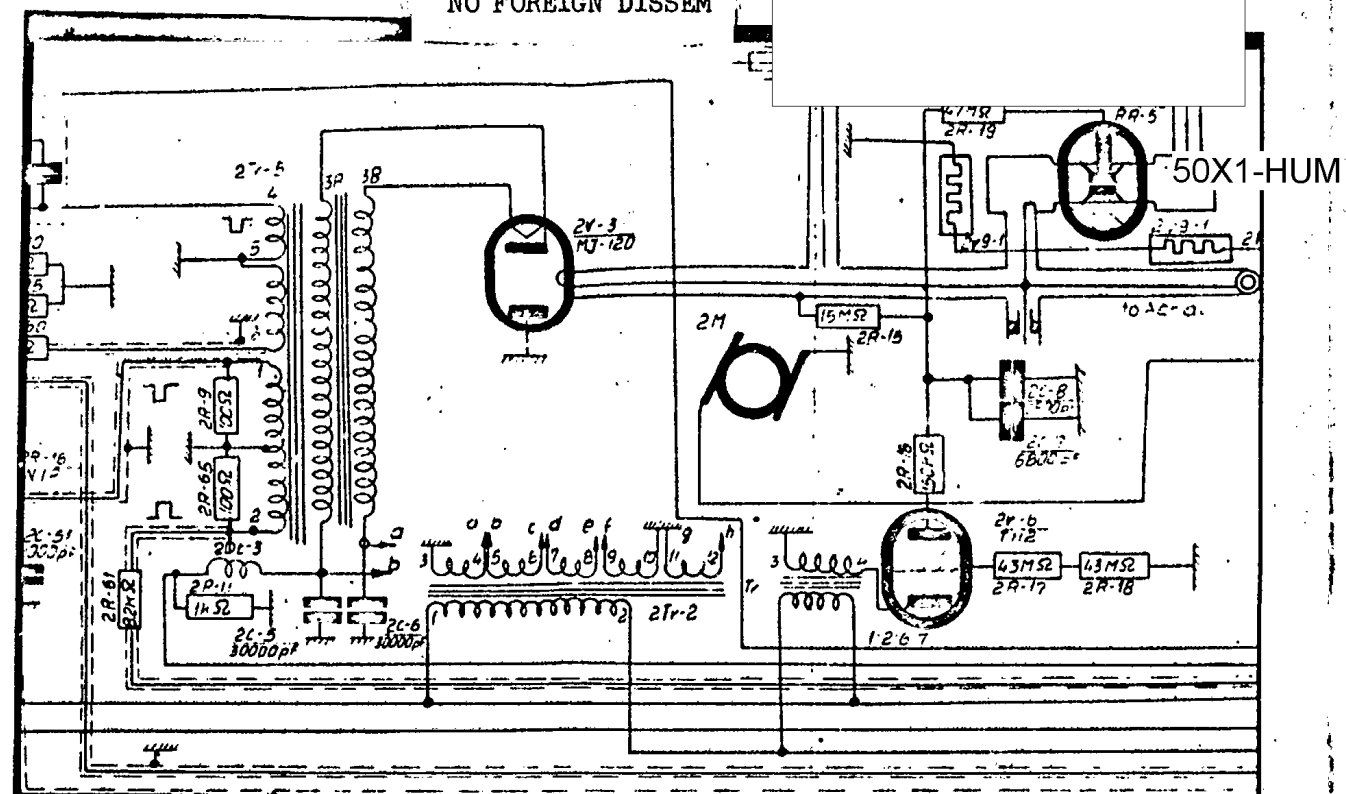

S-E-C-R-E-T

NO FOREIGN DISSEM

NO FOREIGN DISSEM

50X1-HUM

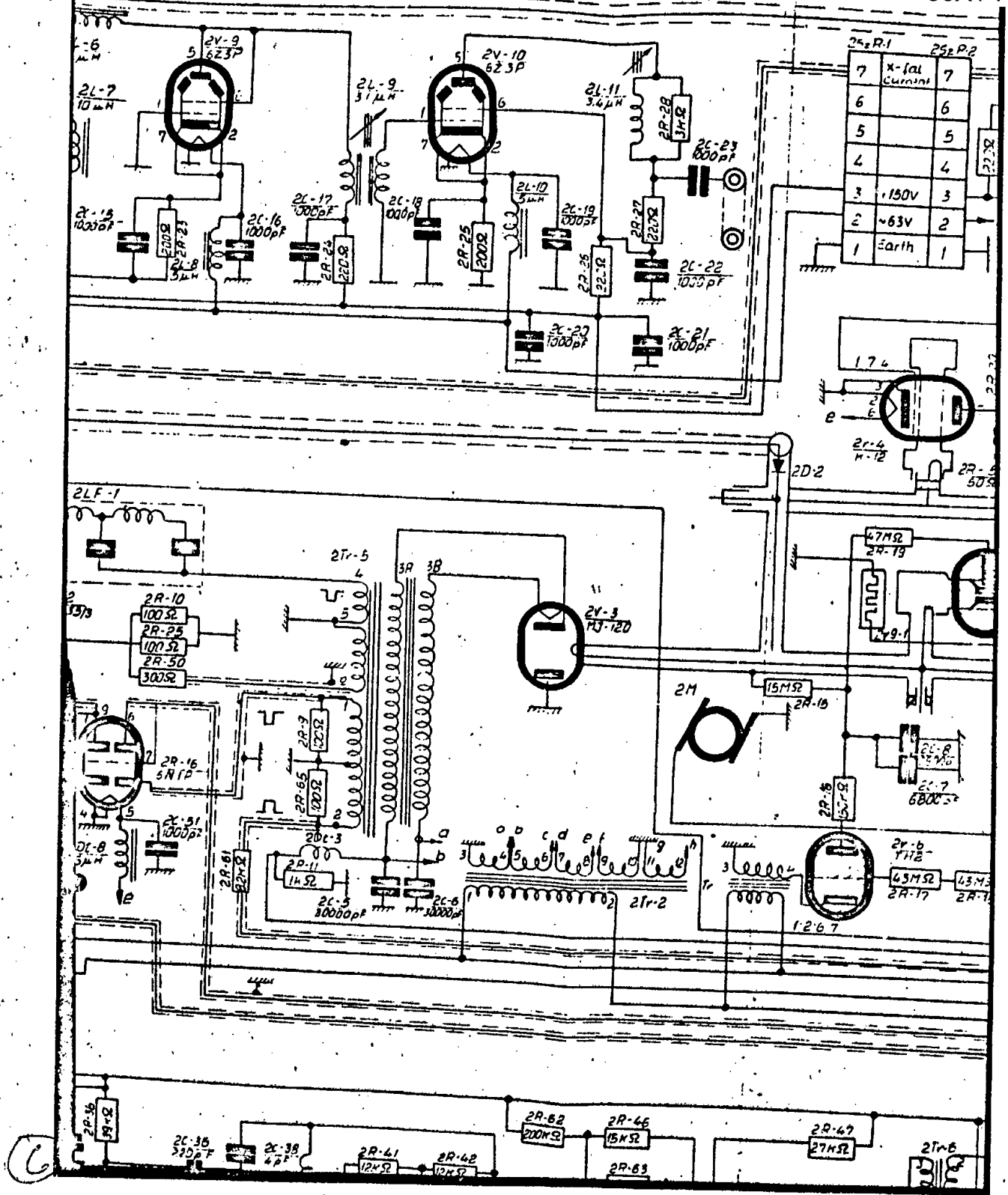

S-E-C-R-E-T

NO FOREIGN DISSEM

NO FOREIGN DISSEM

50X1-HUM

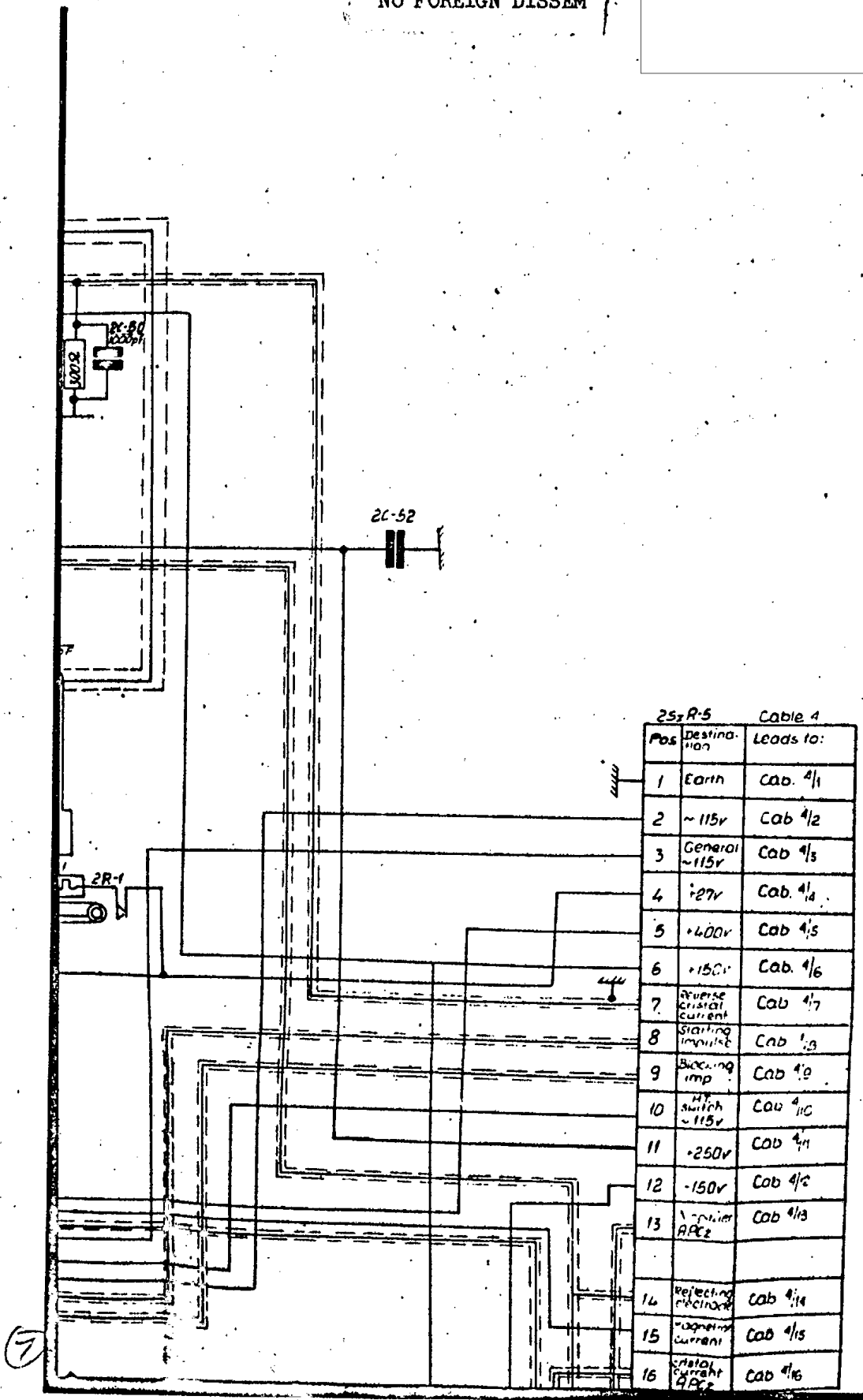

Pos	Destination	Leads to:
1	Earth	Cab 4/1
2	~115v	Cab 4/2
3	General ~115v	Cab 4/3
4	+27v	Cab 4/4
5	+400v	Cab 4/5
6	+150v	Cab 4/6
7	Reverse crystal current	Cab 4/7
8	Starting impulse	Cab 4/8
9	Backward imp	Cab 4/9
10	HT switch ~115v	Cab 4/10
11	+250v	Cab 4/11
12	-150v	Cab 4/12
13	Amplifier APC2	Cab 4/13
14	Reflecting electron	Cab 4/14
15	Upstream current	Cab 4/15
16	Crystal current APC2	Cab 4/16

S-E-C-R-E-T

NO FOREIGN DISSEM

NO FOREIGN DISSEM

50X1-HUM

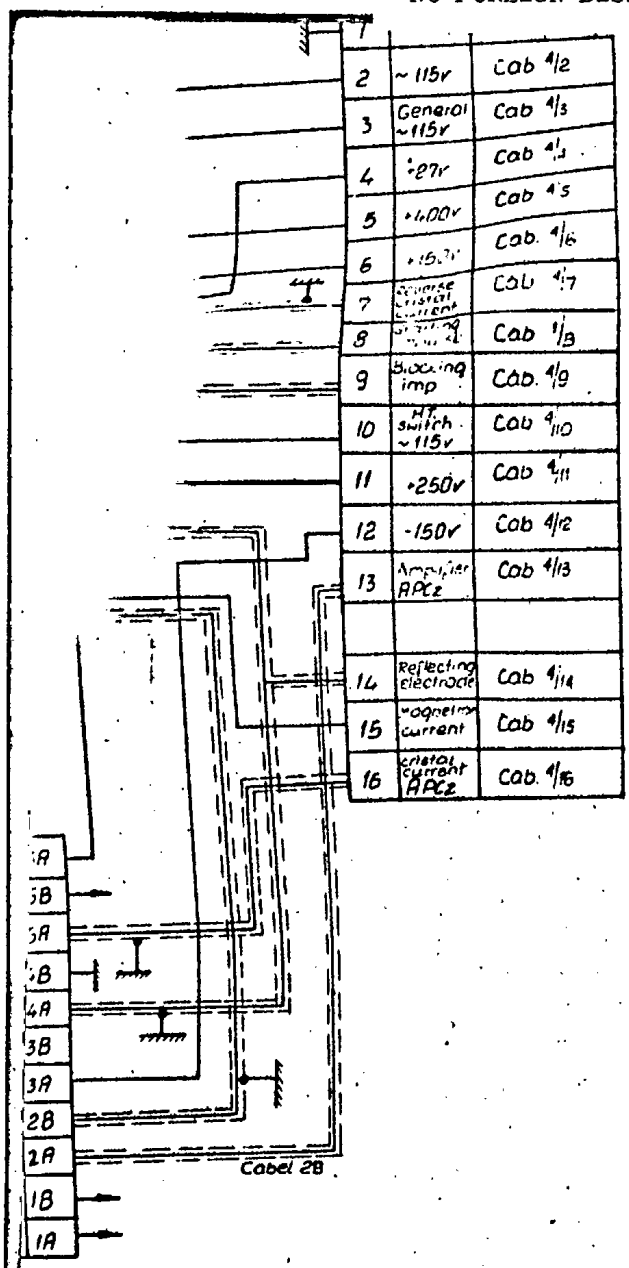

9

Nr. 2 Set.
 Transmitter - receiver set
 Circuit diagram.

57a 200700/schE/s
 page 25

S-E-C-R-E-T

NO FOREIGN DISSEM

NO FOREIGN DISSEM

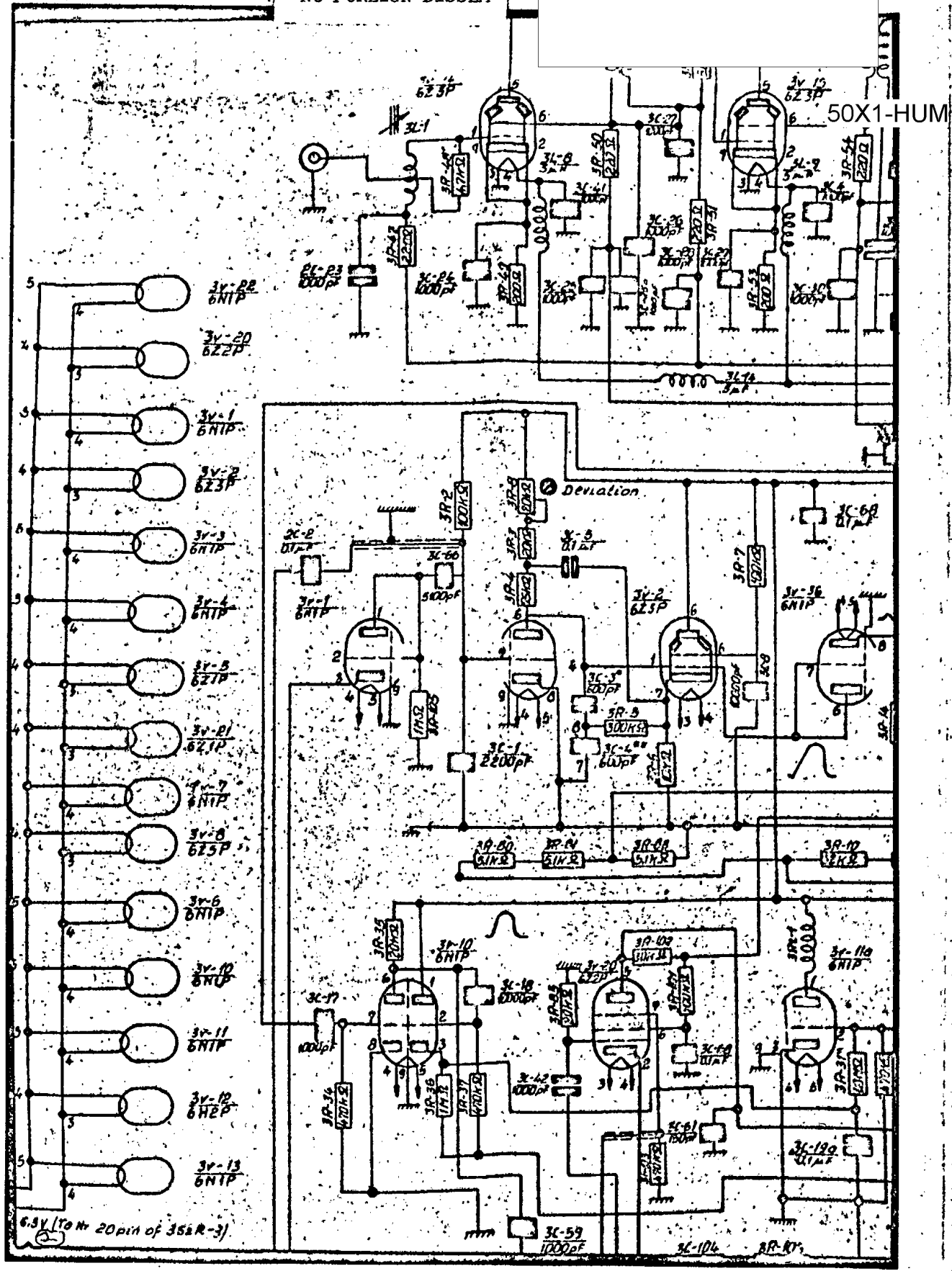

S-E-C-R-E-T
NO FOREIGN DISSEM

NO FOREIGN DISSEM

50X1-HUM.

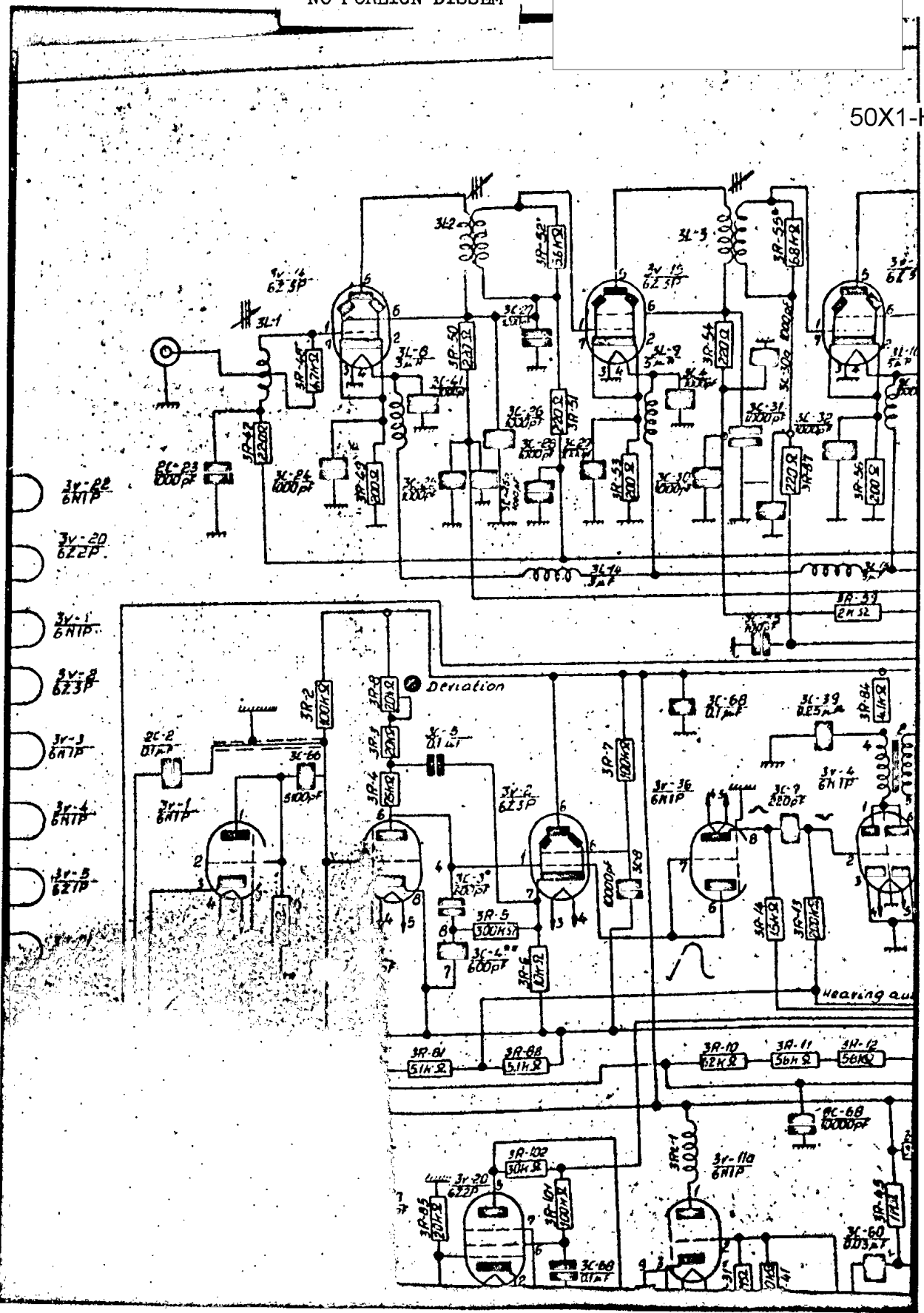

S-E-C-R-E-T

NO FOREIGN DISSEM

NO FOREIGN DISSEM

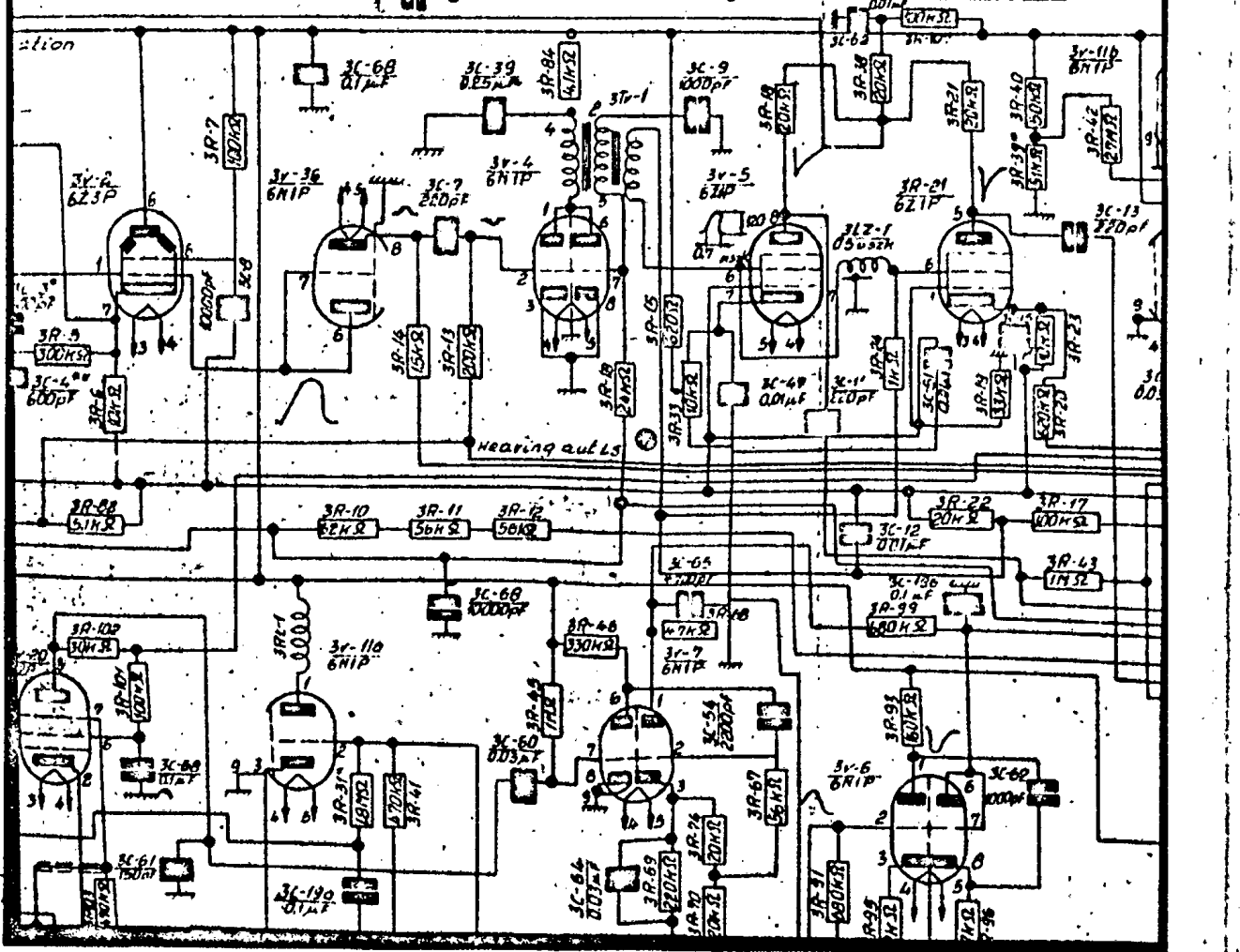
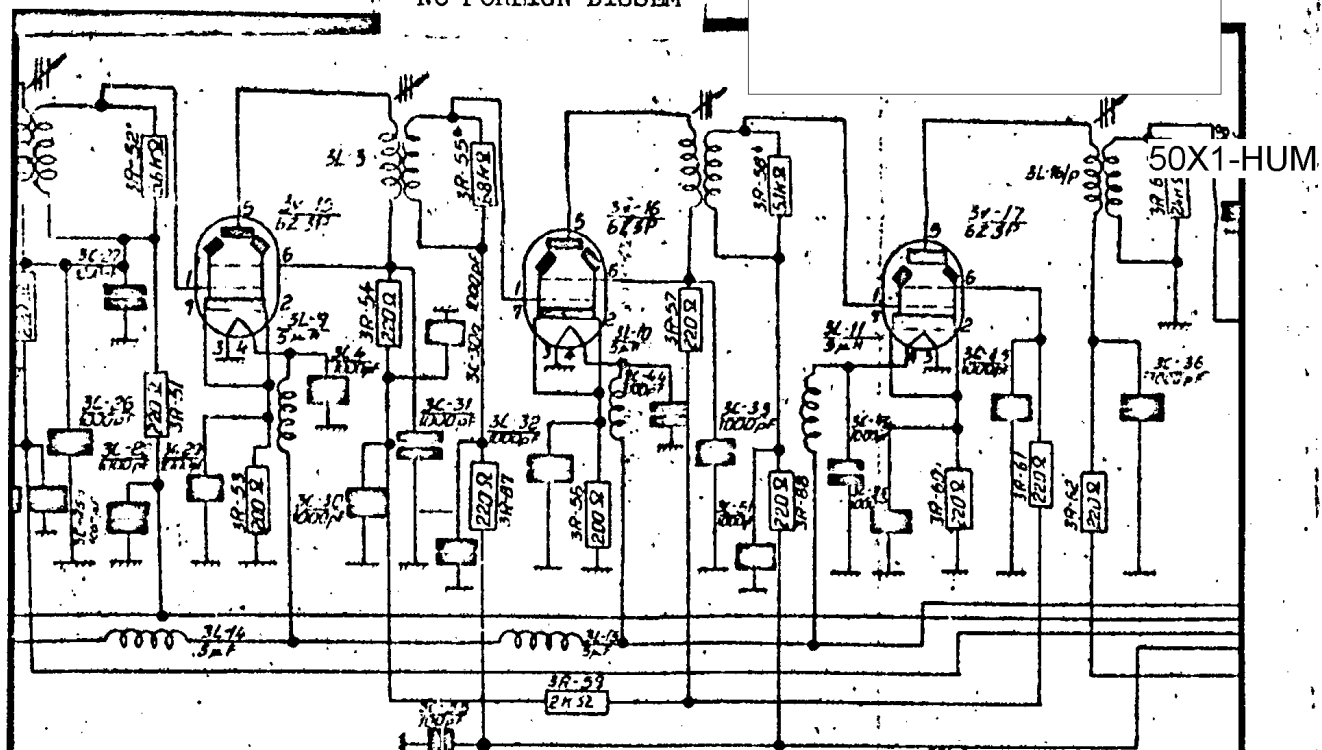

S-E-C-R-E-T

NO FOREIGN DISSEM

NO FOREIGN DISSEM

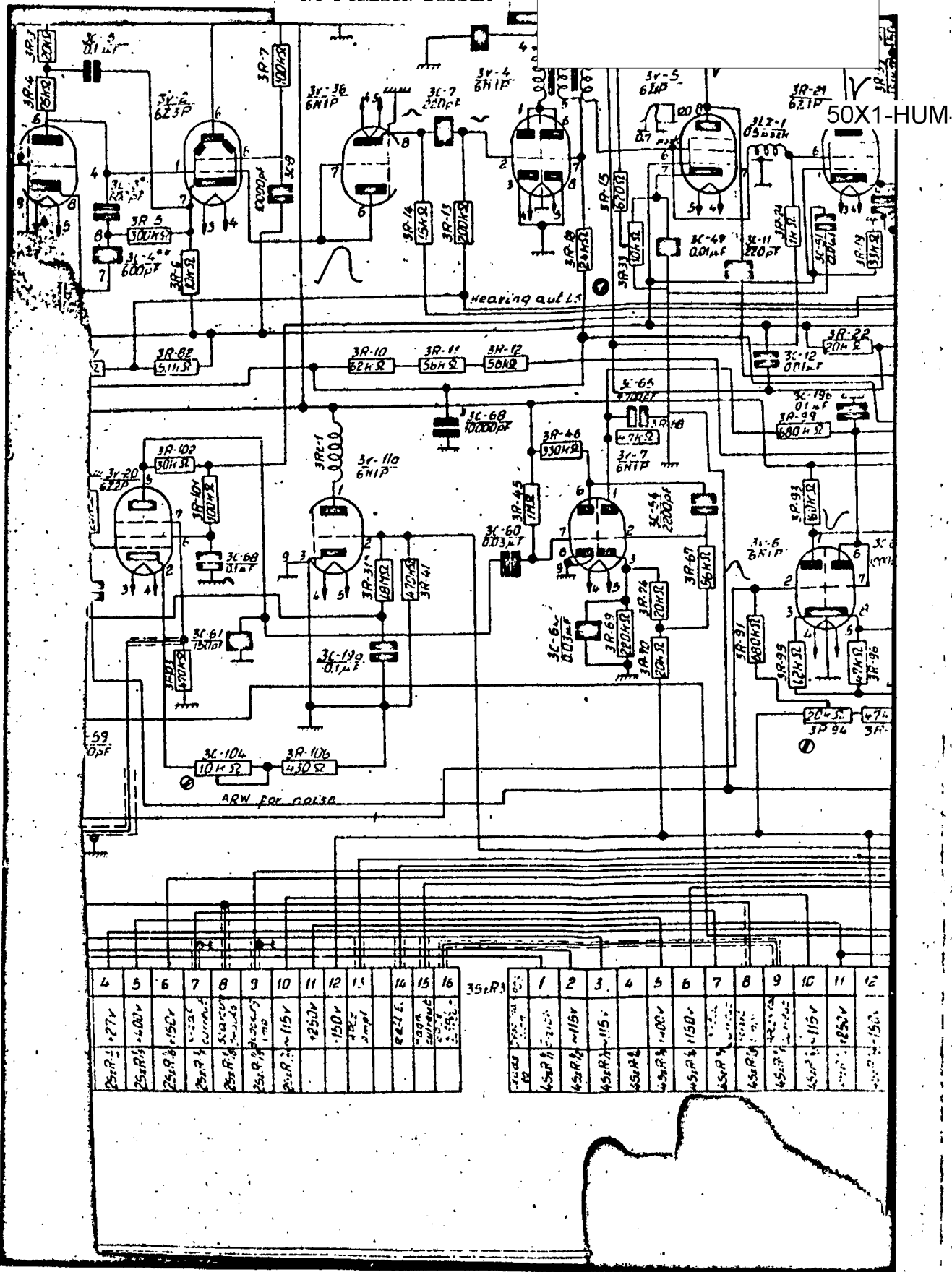

4	5	6	7	8	9	10	11	12	13	14	15	16	15	16	35.2R	1	2	3	4	5	6	7	8	9	10	11	12
25.2R	25.2R	25.2R	25.2R	25.2R	25.2R	25.2R	25.2R	25.2R	25.2R	25.2R	25.2R	25.2R	25.2R	25.2R	25.2R	45.2R	45.2R	45.2R	45.2R	45.2R	45.2R	45.2R	45.2R	45.2R	45.2R	45.2R	45.2R
+27V	+20V	+150V	current	current	current	current	current	current	current	current	current	current	current	current	current	-115V	-115V	-115V	-115V	-115V	-115V	-115V	-115V	-115V	-115V	-115V	-115V
10K	430	10K	430	10K	430	10K	430	10K	430	10K	430	10K	430	10K	430	10K	430	10K	430	10K	430	10K	430	10K	430	10K	430

S-E-C-R-E-T
NO FOREIGN DISSEM

NO FOREIGN DISSEM

50X1-HUM

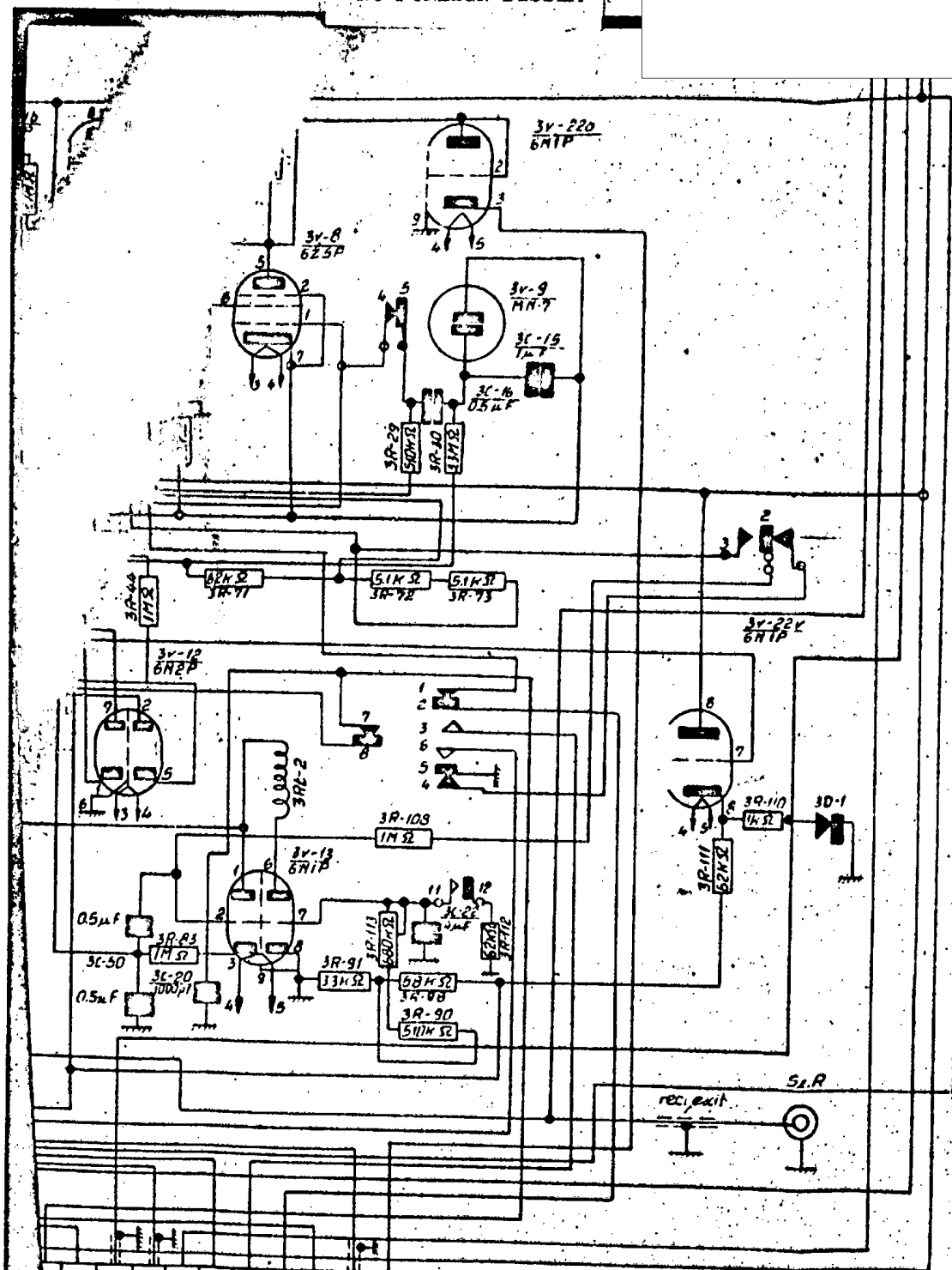

17	18	19	20	21	22	23	24	25	26
6Z5P	6N2P	6AR5	6AR5	6AR5	6AR5	6AR5	6AR5	6AR5	6AR5
6Z5P	6N2P	6AR5	6AR5	6AR5	6AR5	6AR5	6AR5	6AR5	6AR5

6

S-E-C-R-E-T

NO FOREIGN DISSEM

NO FOREIGN DISSEM

50X1-HUM

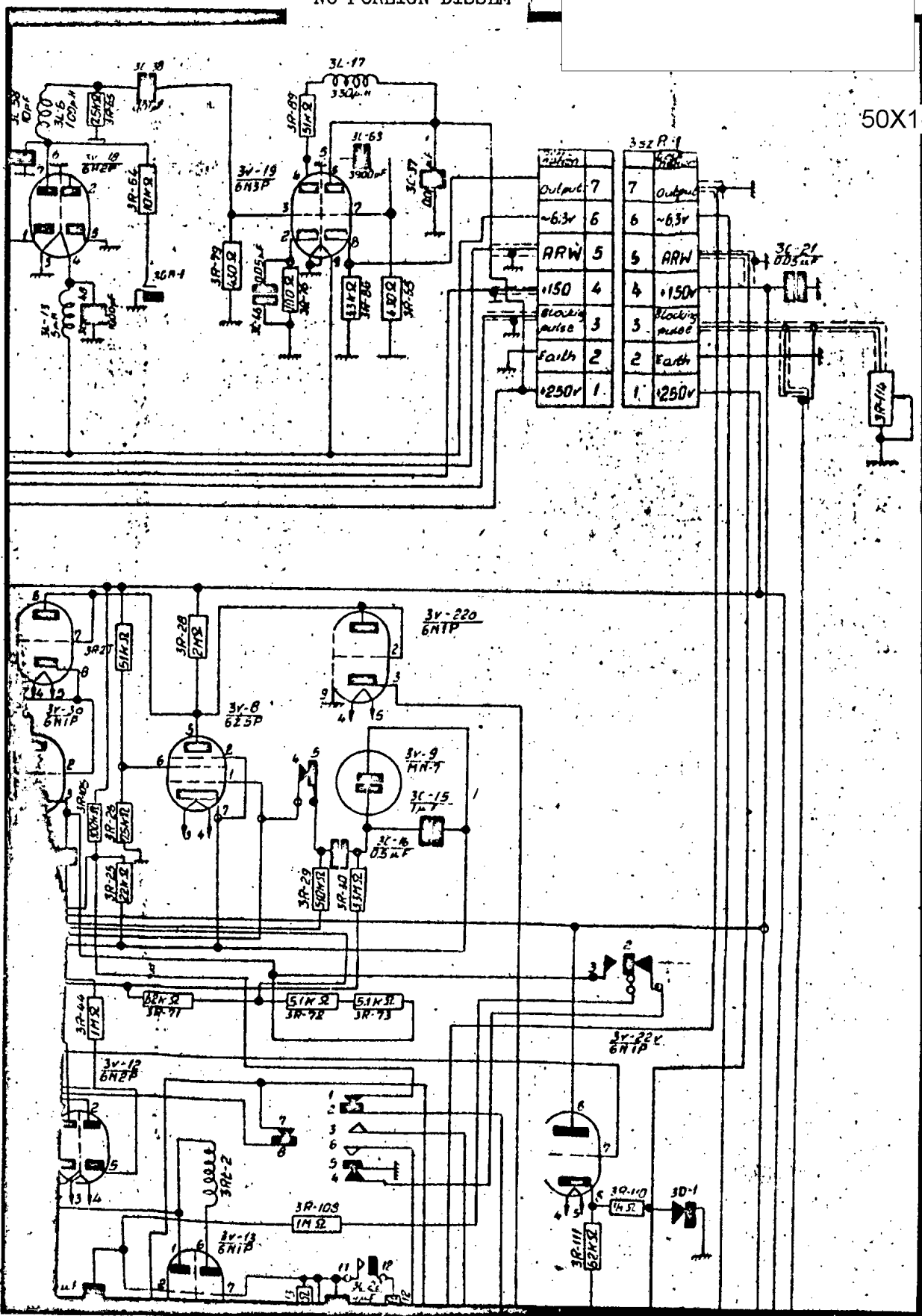

S-E-C-R-E-T

NO FOREIGN DISSEM

NO FOREIGN DISSEM

50X1-HUM

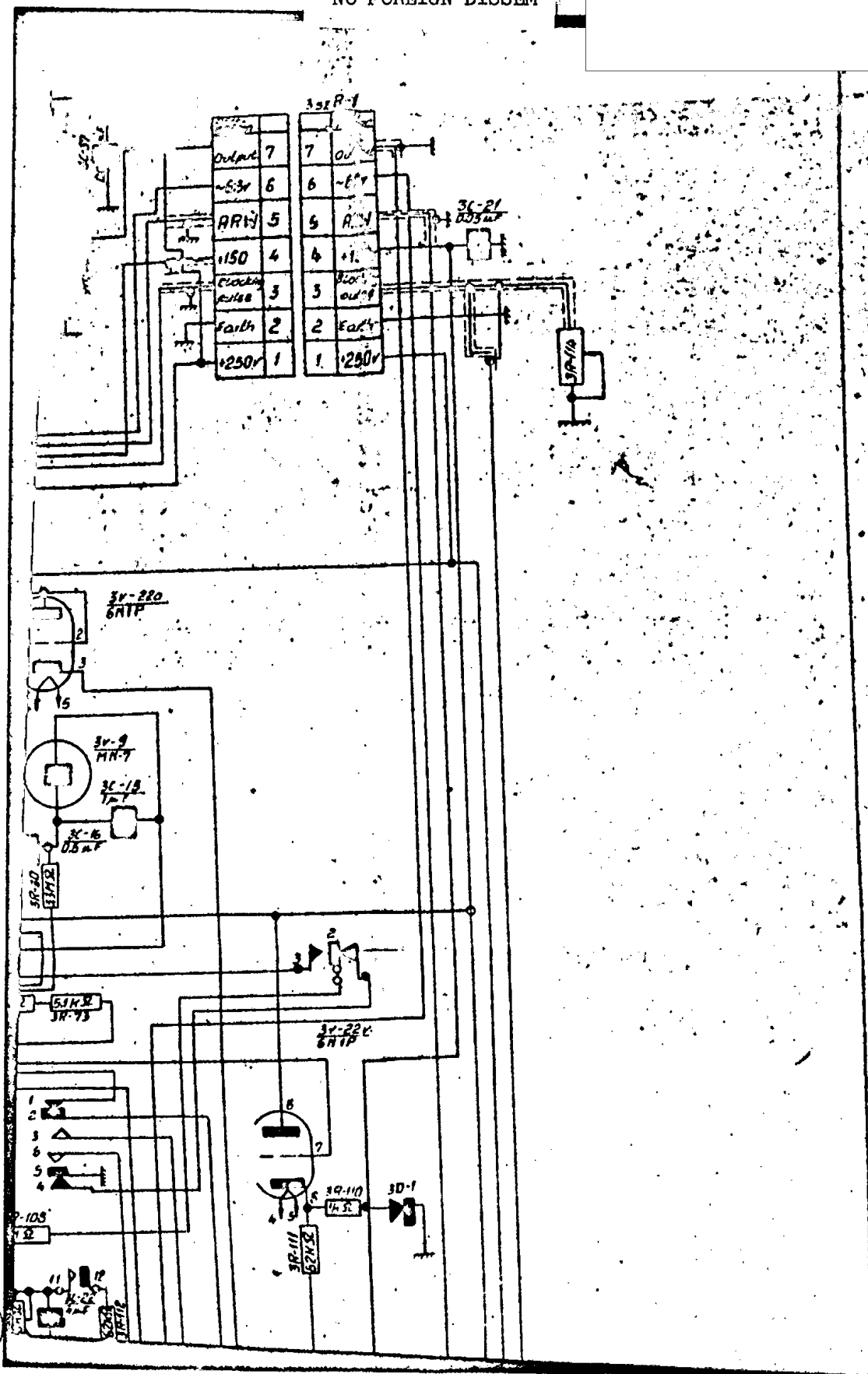

S-E-C-R-E-T
NO FOREIGN DISSEM

NO FOREIGN DISSEM

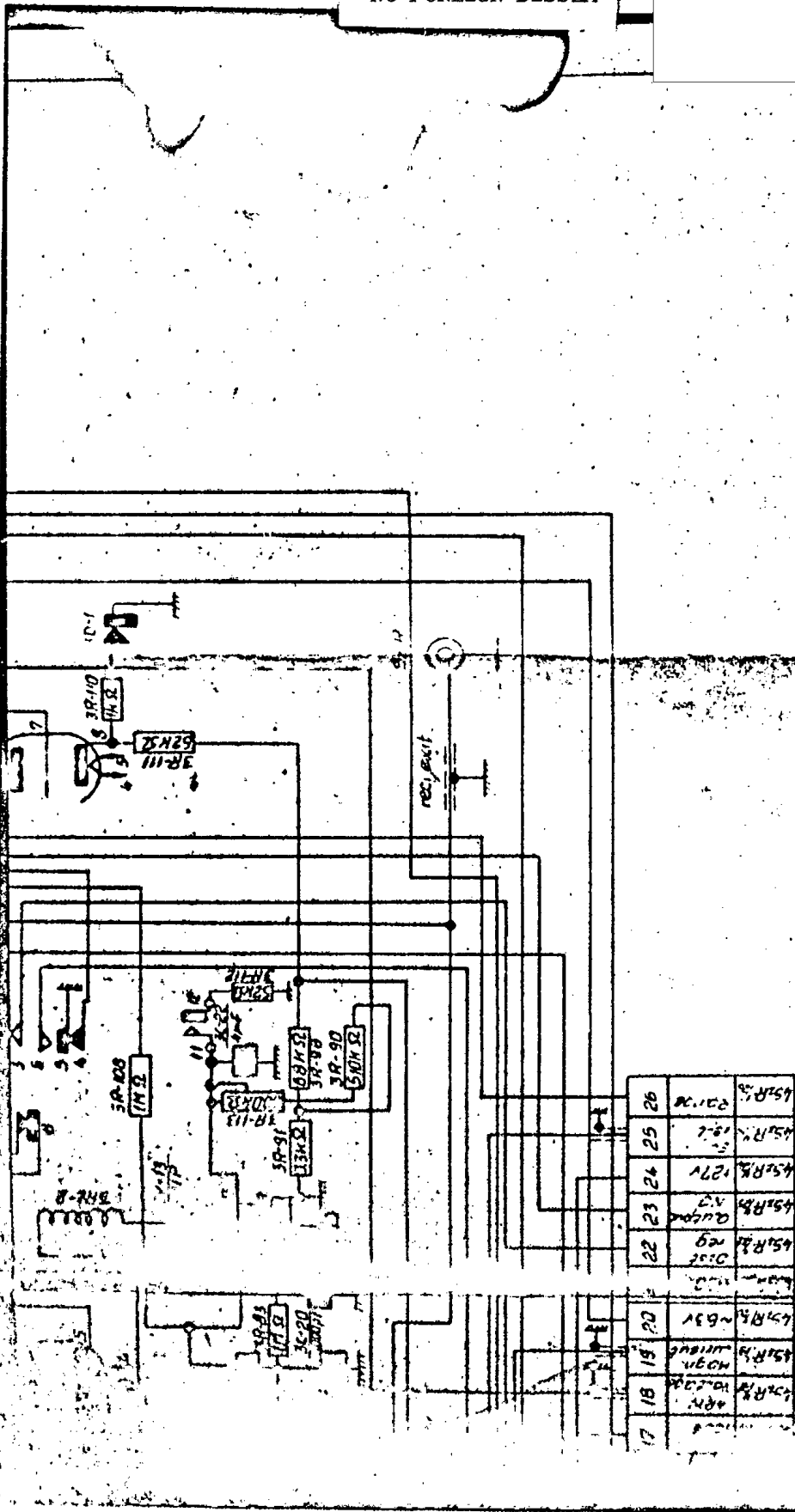

Unit 3
 Circuit diagram of
 distance unit

50X1-HUM

page 26

67a2003.001schels

S-E-C-R-E-T

(NO FOREIGN DISSEM)

NO FOREIGN DISSEM

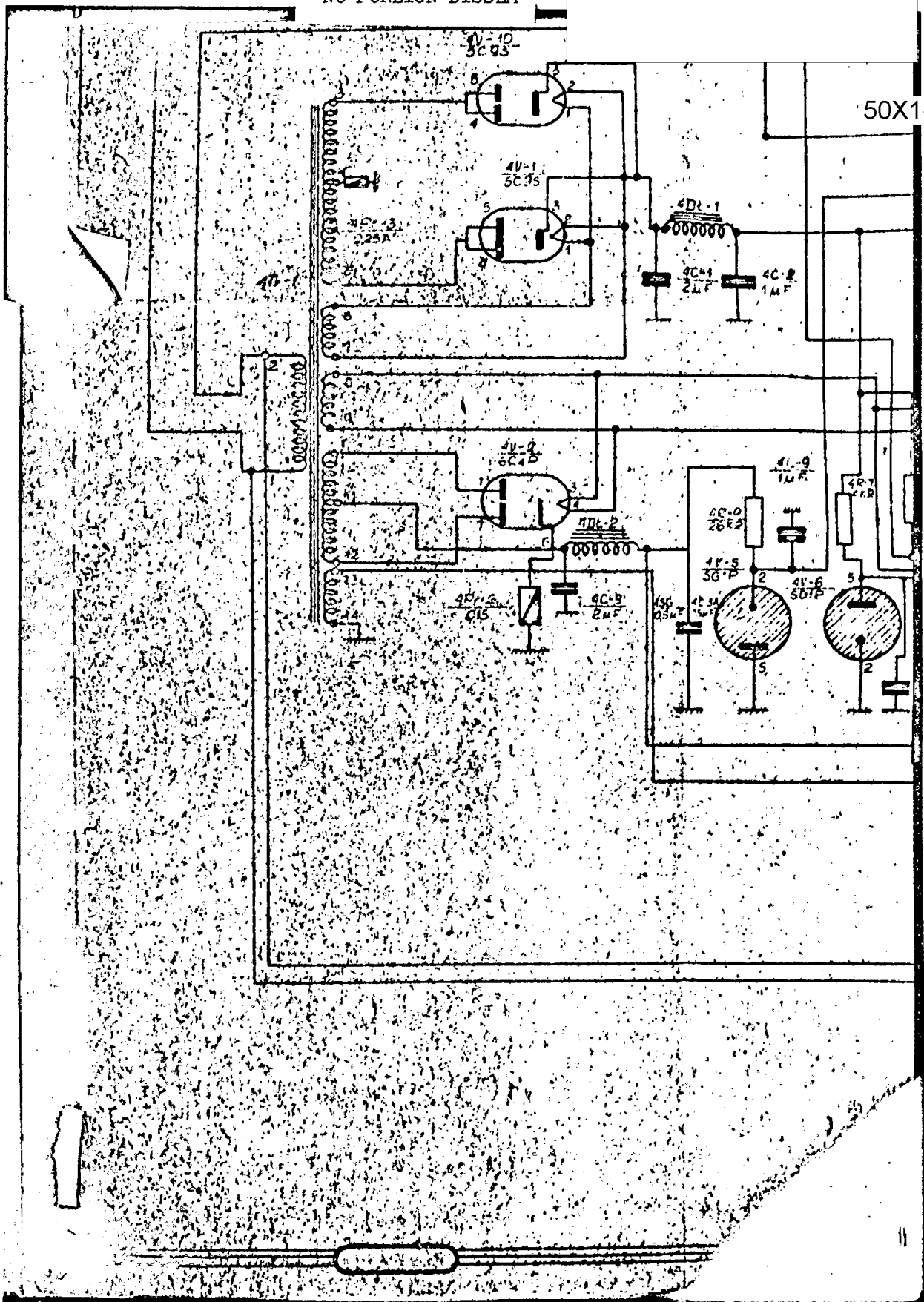

50X1-HUM

S-E-C-R-E-T

NO FOREIGN DISSEM

NO FOREIGN DISSEM

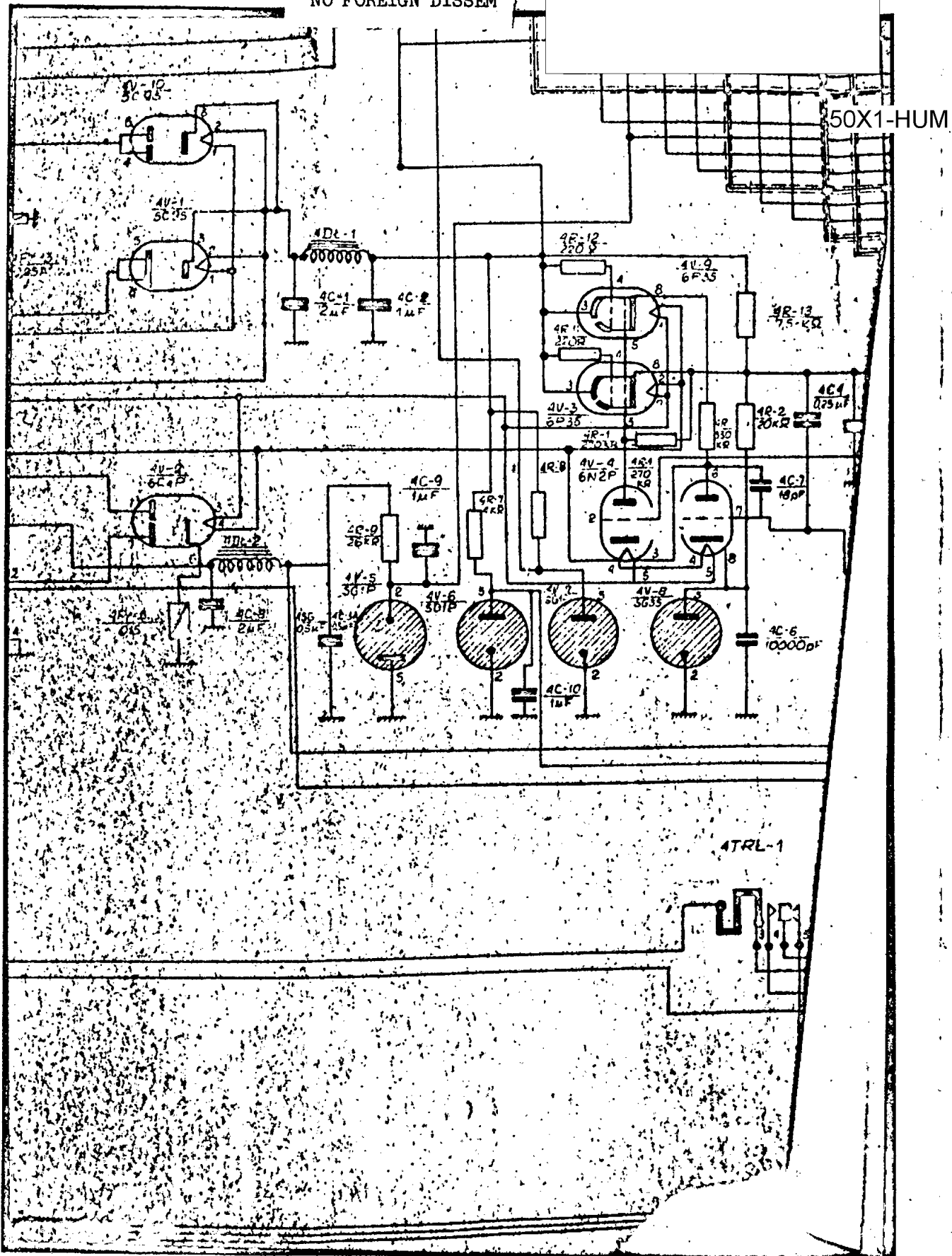

S-E-C-R-E-T

NO FOREIGN DISSEM

50X1-HUM

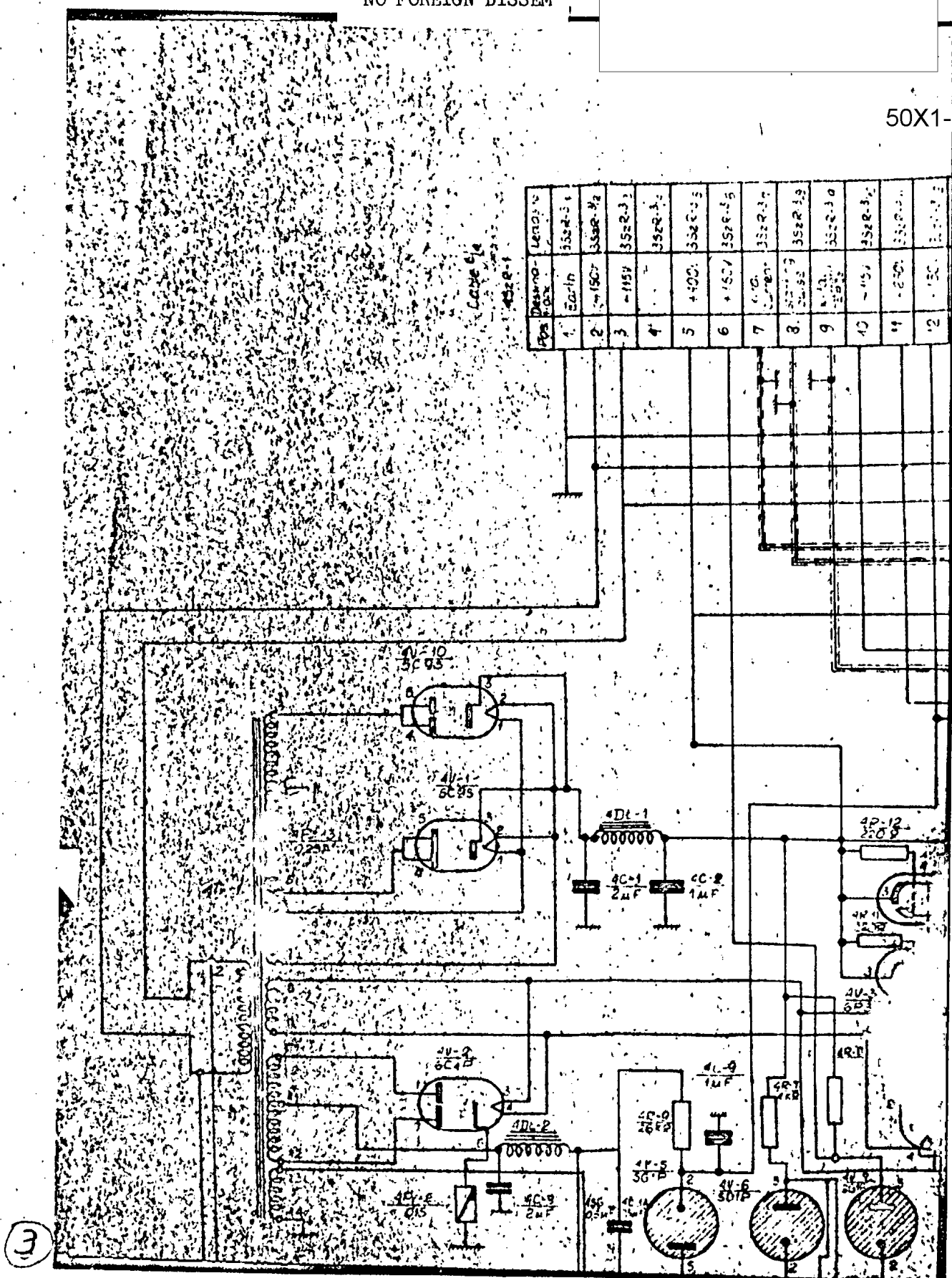

Pos	Designation	Value
1	Earth	352R-31
2	150V	352R-32
3	150V	352R-33
4		352R-34
5	100V	352R-35
6	150V	352R-36
7	100V	352R-37
8	150V	352R-38
9	100V	352R-39
10	150V	352R-40
11	100V	352R-41
12	150V	352R-42

S-E-C-R-E-T

(NO FOREIGN DISSEM)

50X1-HUM

9	4.1a1 Signal 352R-3/9
40	-15V 352R-3/10
11	+250V 352R-3/11
12	150V 352R-3/12
13	Target button 352R-3/13
14	70V ⁺ signal 352R-3/14
15	APC Amplifier 352R-3/15
16	Camera 352R-3/16
17	Signal 352R-3/17
18	12V usage 352R-3/18
19	Maximum current 352R-3/19
20	-43V 352R-3/20
21	APC +150V 352R-3/21
22	Dist +9V 352R-3/22
23	APC +150V 352R-3/23
24	+27V 352R-3/24
25	APC +150V 352R-3/25
26	Search switch 352R-3/26

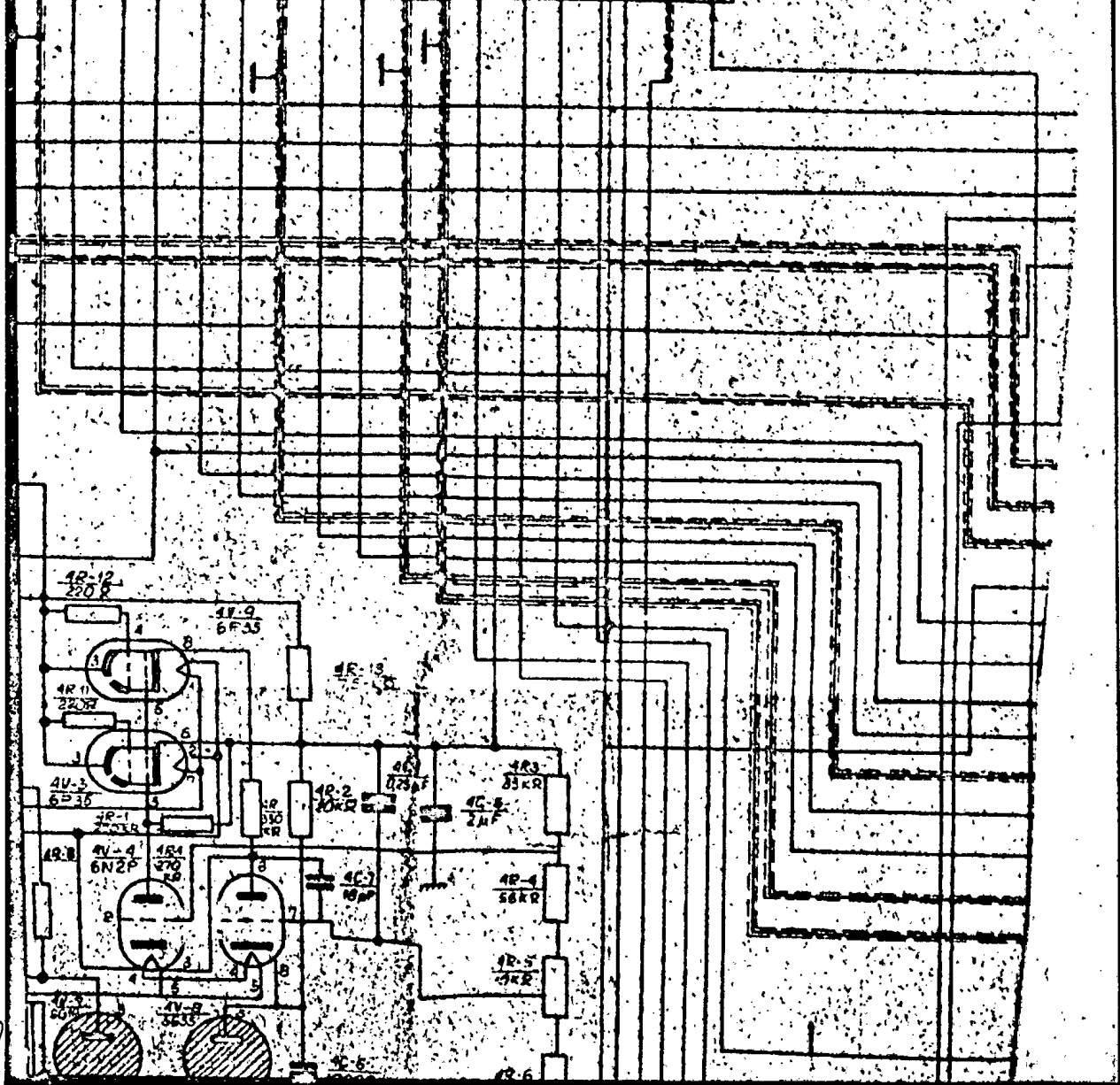

4

S-E-C-R-E-T
(NO FOREIGN DISSEM)

NO FOREIGN DISSEM

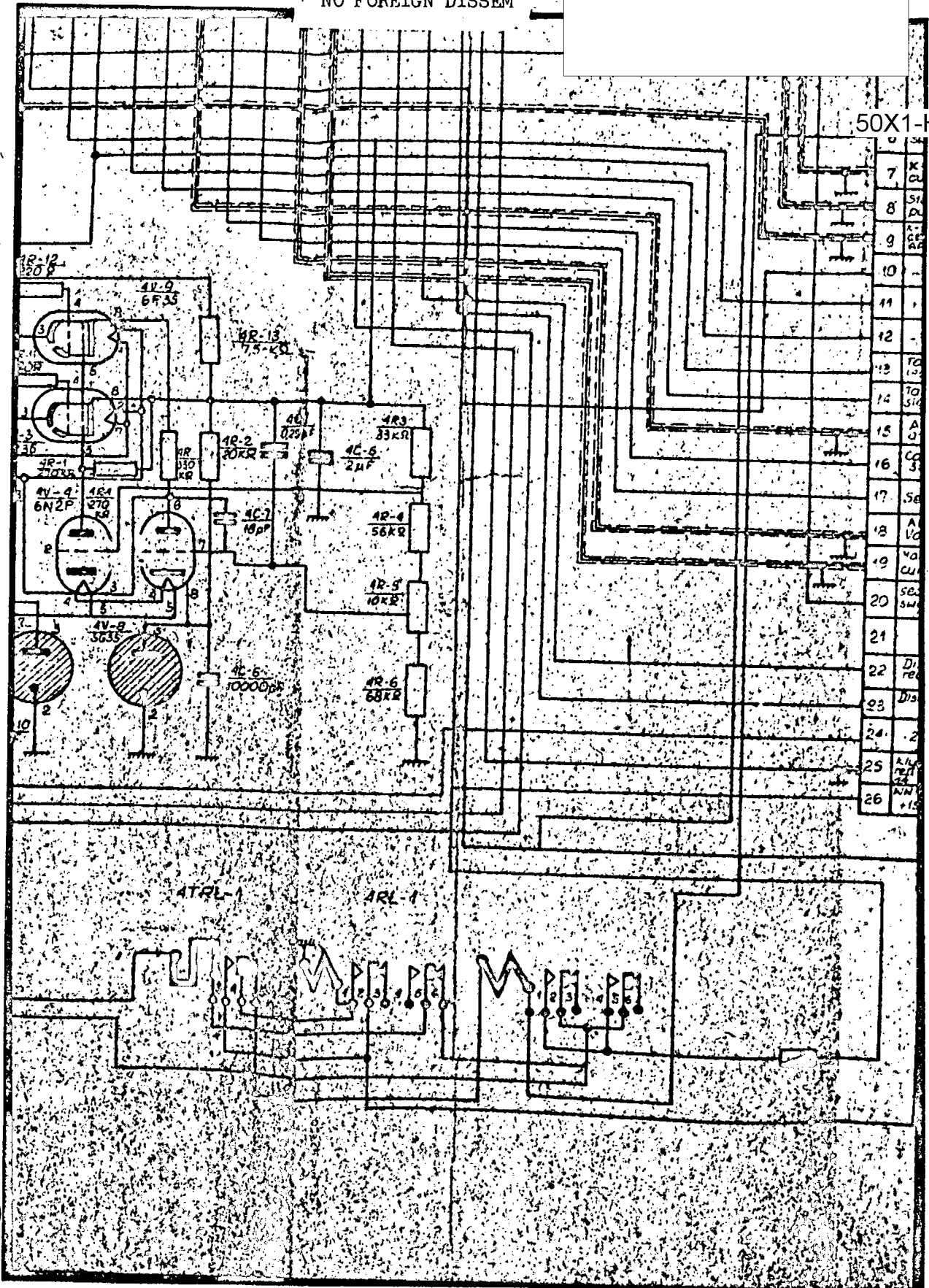

S-E-C-R-E-T

NO FOREIGN DISSEM

50X1-HUM

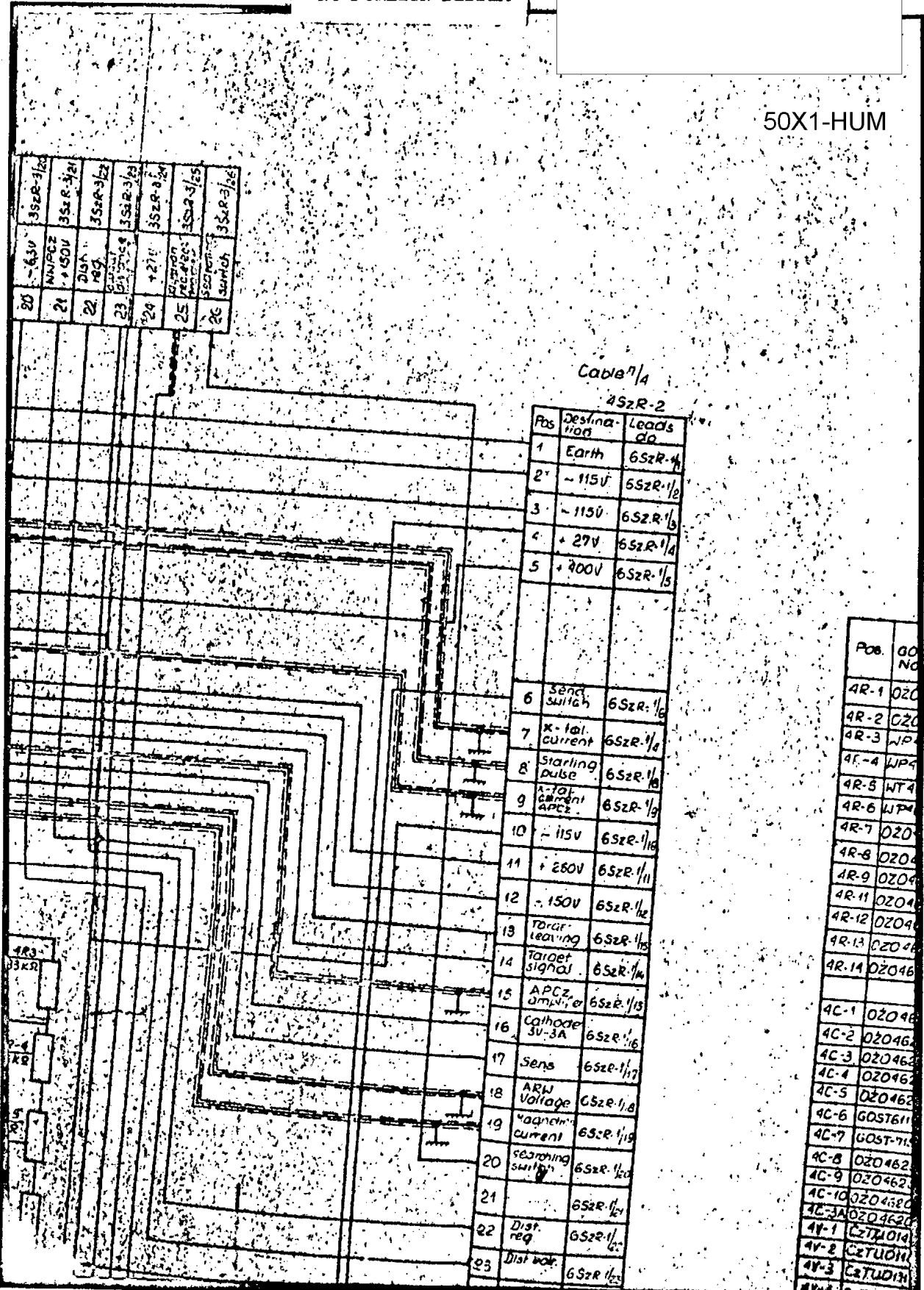

S-E-C-R-E-T

NO FOREIGN DISSEM

NO FOREIGN DISSEM

List of items

Pos.	GOST; WTU, Norm fig.	Name and type	Value	Qty	Remarks	50X1-HUM
4R-1	OZO467003TU	resistance MLT-1-270 kΩ ± II	270kΩ	1		
4R-2	OZO467003TU	resistance MLT-2-27 kΩ ± II	27kΩ	1		
4R-3	WP4675001Sp	resistance PT-1-33 kΩ ± 1%	33kΩ	1		
4R-4	WP4675001Sp	resistance PT-1-56 kΩ ± 1%	56kΩ	1		
4R-5	WT4685006S	resistance PPZ-11-10 kΩ	10kΩ	1		
4R-6	WP4675001Sp	resistance PT-1-68 kΩ ± 1%	68kΩ	1		
4R-7	OZO467011TU	resistance PEW-20-40 kΩ ± II	40kΩ	1		
4R-8	OZO467011TU	resistance PEW-20-7 kΩ ± I	7kΩ	1		
4R-9	OZO467011TU	resistance PEW-10-2.5 kΩ ± II	2.5kΩ	1		
4R-11	OZO467003TU	resistance MLT-0.5-220 Ω ± II	220Ω	1		
4R-12	OZO467003TU	resistance MLT-0.5-220 Ω ± II	220Ω	1		
4R-13	OZO467011TU	resistance PEW-20-7.5 kΩ ± II	7.5kΩ	1		
4R-14	OZO467003TU	resistance MLT-1-330 kΩ ± II	330kΩ	1		
4C-1	OZO462008TU	condenser MBGP-1-600-2-II	2 μF	1		
4C-2	OZO462008TU	condenser MBGP-1-600-1-IIIa	1 μF	1		
4C-3	OZO462008TU	condenser MBGP-2-400-0.5-IIA	0.5 μF	1		
4C-4	OZO462008TU	condenser MBGP-2-400-0.25-IA	0.25 μF	1		
4C-5	OZO462008TU	condenser MBGP-1-400-2-IA	2 μF	1		
4C-6	GOST619-54	condenser KSO-5-250-1-10000-I	10000 pF	1		
4C-7	GOST-7159-54	condenser KLK-1M-18-II	18 pF	1		
4C-8	OZO462008TU	condenser MBGP-1-400-2-I	2 μF	1		
4C-9	OZO462008TU	condenser MBGP-2-200-1-II	1 μF	1		
4C-10	OZO462008TU	condenser MBGP-2-200-1-II	1 μF	1		
4C-3A	OZO462008TU	condenser MBGP-2-400-0.5-IA	0.5 μF	1		
4V-1	CzTU0143752	valve type 5C95		1		
4V-2	CzTU0110953	valve type 6C4P		1		
4V-3	CzTU0111054	valve type 6P35		1		
4V-4	CzTU0110658	valve type 6N2P		1		
4V-5	CzTU0210153	valve type SG1P		1		
4V-6	CzTU0210153	valve type SG1P		1		
4V-7	CzTU0210153	valve type SG1P		1		
4V-8	CzTU0270154	valve type SG3S		1		
4V-9	CzTU011054	valve type 6P35		1		
4V-10	CzTU0143752	valve type 5C95		1		
4Tr-1	3Ja715001sp	transformer		1		
4DL-1	1RM-4-3-000	choke		1		
4DL-2	1RM-4-4-000	choke		1		
4RL-1	GJa4523000sp	relay		1		
4RL-2	GJa45230002sp	relay		1		

S-E-C-R-E-T

NO FOREIGN DISSEM

NO FOREIGN DISSEM

4R-2	OZO467003TU	resistance MLT-1-10 kΩ-II	10 kΩ	1
4R-3	WP4675001Sp	resistance PT-1-33 kΩ ± 1%	33 kΩ	1
4R-4	WP4675001Sp	resistance PT-1-56 kΩ ± 1%	56 kΩ	1
4R-5	WT4685006S	resistance PPZ-11-10 kΩ	10 kΩ	1
4R-6	WP4675001Sp	resistance PT-1-68 kΩ ± 1%	68 kΩ	1
4R-7	OZO467011TU	resistance PEW-20-40 kΩ-II	40 kΩ	1
4R-8	OZO467011TU	resistance PEW-30-7 kΩ-I	7 kΩ	1
4R-9	OZO467011TU	resistance PEW-10-2.5 kΩ-II	2.5 kΩ	1
4R-11	OZO467003TU	resistance MLT-0.5-220 Ω-II	220 Ω	1
4R-12	OZO467003TU	resistance MLT-0.5-220 Ω-II	220 Ω	1
4R-13	OZO467011TU	resistance PEW-20-75 kΩ-II	75 kΩ	1
4R-14	OZO467003TU	resistance MLT-1-330 kΩ-II	330 kΩ	1
4C-1	OZO462008TU	condenser MBGP-1-600-2-II	2 μF	1
4C-2	OZO462008TU	condenser MBGP-1-600-1-IIa	1 μF	1
4C-3	OZO462008TU	condenser MBGP-2-400-0.5-II A	0.5 μF	1
4C-4	OZO462008TU	condenser MBGP-2-400-0.25-II A	0.25 μF	1
4C-5	OZO462008TU	condenser MBGP-1-400-2-II A	2 μF	1
4C-6	GOST7119-54	condenser KSO-5-250-1-10000-II	10000 pF	1
4C-7	GOST7119-54	condenser KLK-1M-18-II	18 pF	1
4C-8	OZO462008TU	condenser MBGP-1-400-2-I	2 μF	1
4C-9	OZO462008TU	condenser MBGP-2-200-1-II	1 μF	1
4C-10	OZO462008TU	condenser MBGP-2-200-1-I	1 μF	1
4C-3A	OZO462008TU	condenser MBGP-2-400-0.5-II A	0.5 μF	1
4V-1	CzTU01103752	valve type 5C95		1
4V-2	CzTU0110953	valve type 6C4P		1
4V-3	CzTU011054	valve type 6P35		1
4V-4	CzTU0110658	valve type 6N2P		1
4V-5	CzTU0210153	valve type SG1P		1
4V-6	CzTU0210153	valve type SG1P		1
4V-7	CzTU0210153	valve type SG1P		1
4V-8	CzTU0270154	valve type SG3S		1
4V-9	CzTU011054	valve type 6P35		1
4V-10	CzTU01103752	valve type 5C95		1
4Tr-1	GJa718001Sp	transformer		1
4DL-1	1RM-4-3-000	choke		1
4DL-2	1RM-4-4-000	choke		1
4RL-1	GJa45230001Sp	relay		1
4RL-2	GJa45230002Sp	relay		1
4RL-1	WP4542002Sp	thermic relay		1
4Pr-1	GOST5010-53	fuse PC-30-1	1A	1
4Pr-2	GOST5010-53	fuse PK-30-0.15	0.15A	1
4Pr-3	GOST5010-53	fuse PK-30-0.25	0.25A	1
4S2R1	TU1021-a ¹¹⁰²⁹⁶ RAD	socket SzR43PK26E Sz2		1
4S2R2	TU1021-a ¹¹⁰²⁹⁶ RAD	plug SzR4226ESz2		1

50X1-HUM

Unit No. 4
Power amplifier
Circuit diagram
GJa2.087.0075ch
page 27 / 15

S-E-C-R-E-T

NO FOREIGN DISSEM

NO FOREIGN DISSEM

452R2	Range	20
452R2/21		21
452R2/22	in distance	22
452R2/23	Distance	23
452R2/24	- 230.	24
452R2/25	Rec. electrode voltage	25
452R2/26	- 150V.	26

50X1-HUM

Rem 43.
 all meters marked ∇ are brought
 forward to the front panel

S-E-C-R-E-T

NO FOREIGN DISSEM

NO FOREIGN DISSEM

50X1-HUM

45zR2/7	APCZ current	7
45zR2/8	starting pulse	8
45zR2/9	APCZ x-lal current	9
45zR2/10	+150V	10
45zR2/11	+250V	11
45zR2/12	-150V	12
45zR2/13	Target abandoning	13
45zR2/14	Target signal	14
45zR2/15	APCZ Amplifier	15
45zR2/16	Cathode 3V-13a	16
45zR2/17	Sensitivity	17
45zR2/18	ARW Voltage	18
45zR2/19	APCZ current	19
45zR2/20	Range	20
45zR2/21		21
45zR2/22	Radio distance 189	22
45zR2/23	Distance unit	23
45zR2/24	-230	24
45zR2/25	Rec. electrode Voltage	25
45zR2/26	+150V	26

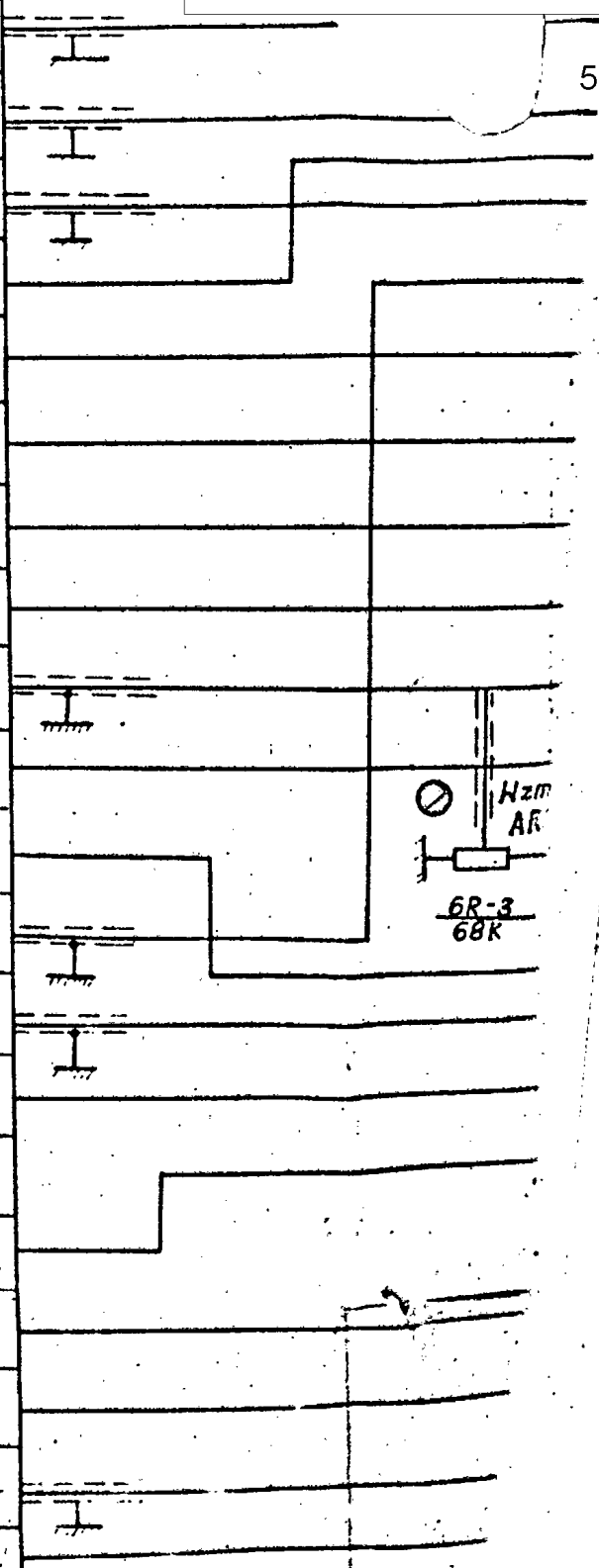

Main x-lal

S-E-C-R-E-T

NO FOREIGN DISSEM

NO FOREIGN DISSEM

50X1-HUM

65z1R-1

kab⁷/₆

Where leads	Destination	POS
45zR2/1	Earth	1
45zR2/2	~ 115V	2
45zR2/3	~ 115V	3
45zR2/4	+ 27V	4
45zR2/5	+ 400V	5
45zR2/6	landing switch	6

6Pr-2
10a

S-E-C-R-E-T

NO FOREIGN DISSEM

50X1-HUM

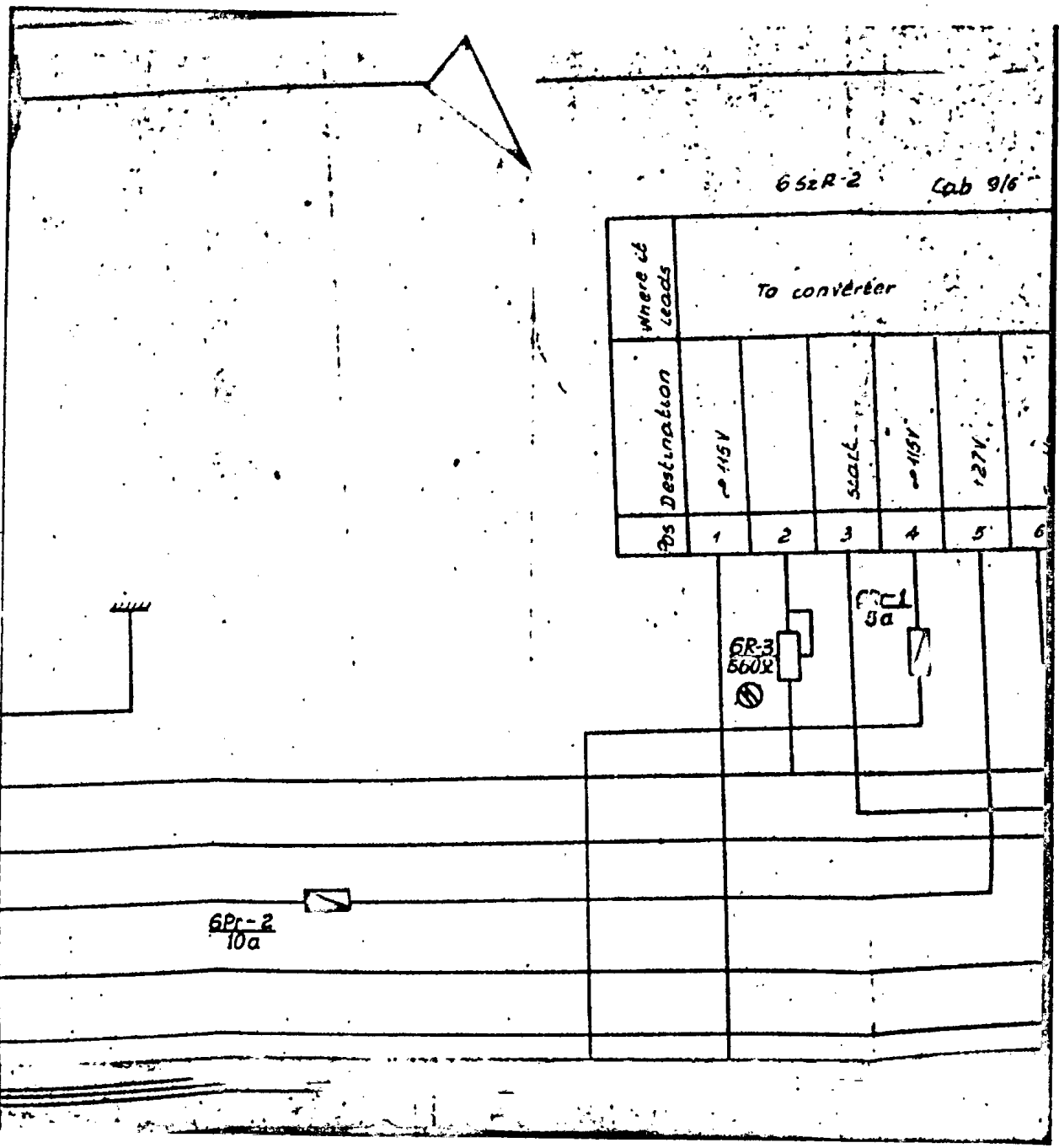

S-E-C-R-E-T
 NO FOREIGN DISSEM

NO FOREIGN DISSEM

50X1-HUM

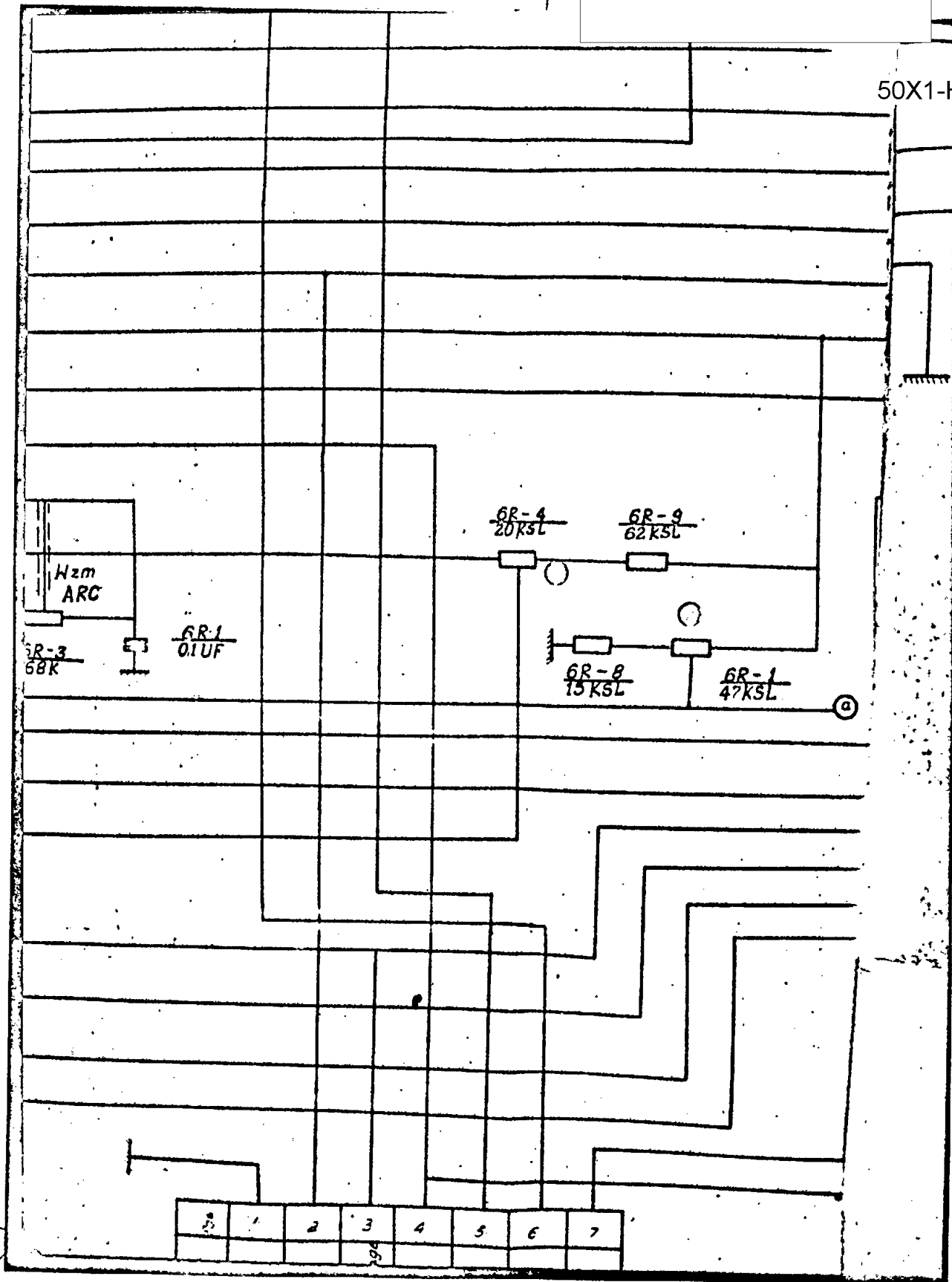

S-E-C-R-E-T

NO FOREIGN DISSEM

NO FOREIGN DISSEM

50X1-HUM

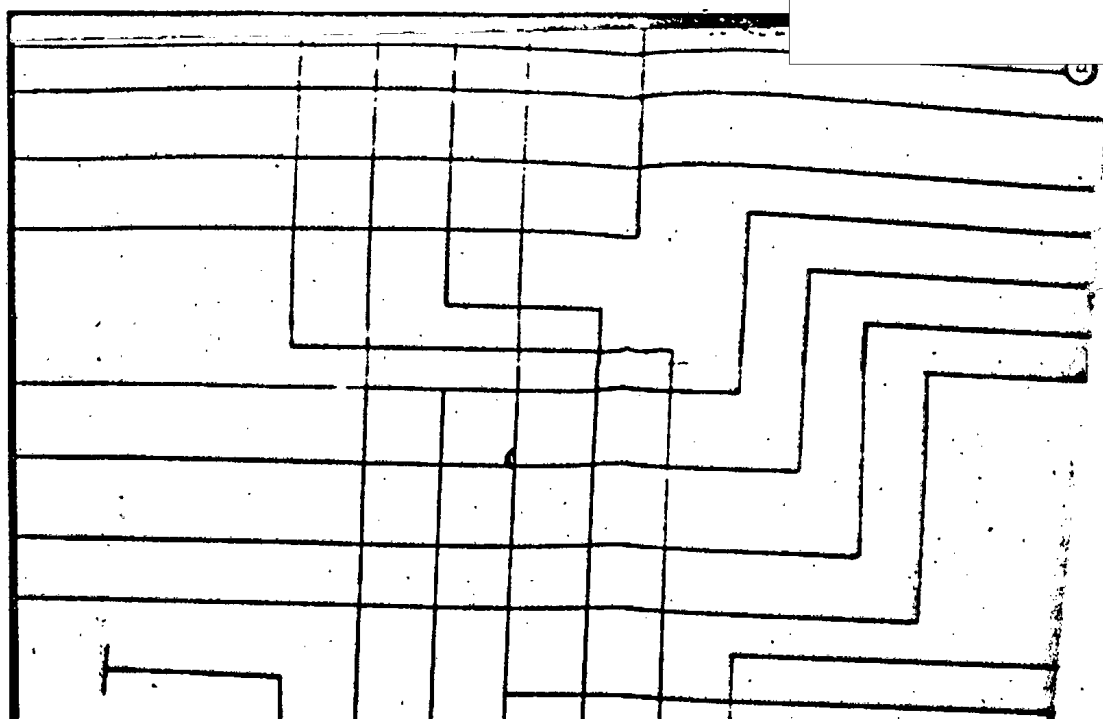

Destination No	1	2	3	4	5	6	7
Destination	Earth	1250F	Distance: 1000000	1000000	1000000	1000000	1000000
Where it lands	To ASD-AN Dropter						

652R-5 cab ASD-1

S-E-C-R-E-T

NO FOREIGN DISSEM

NO FOREIGN DISSEM

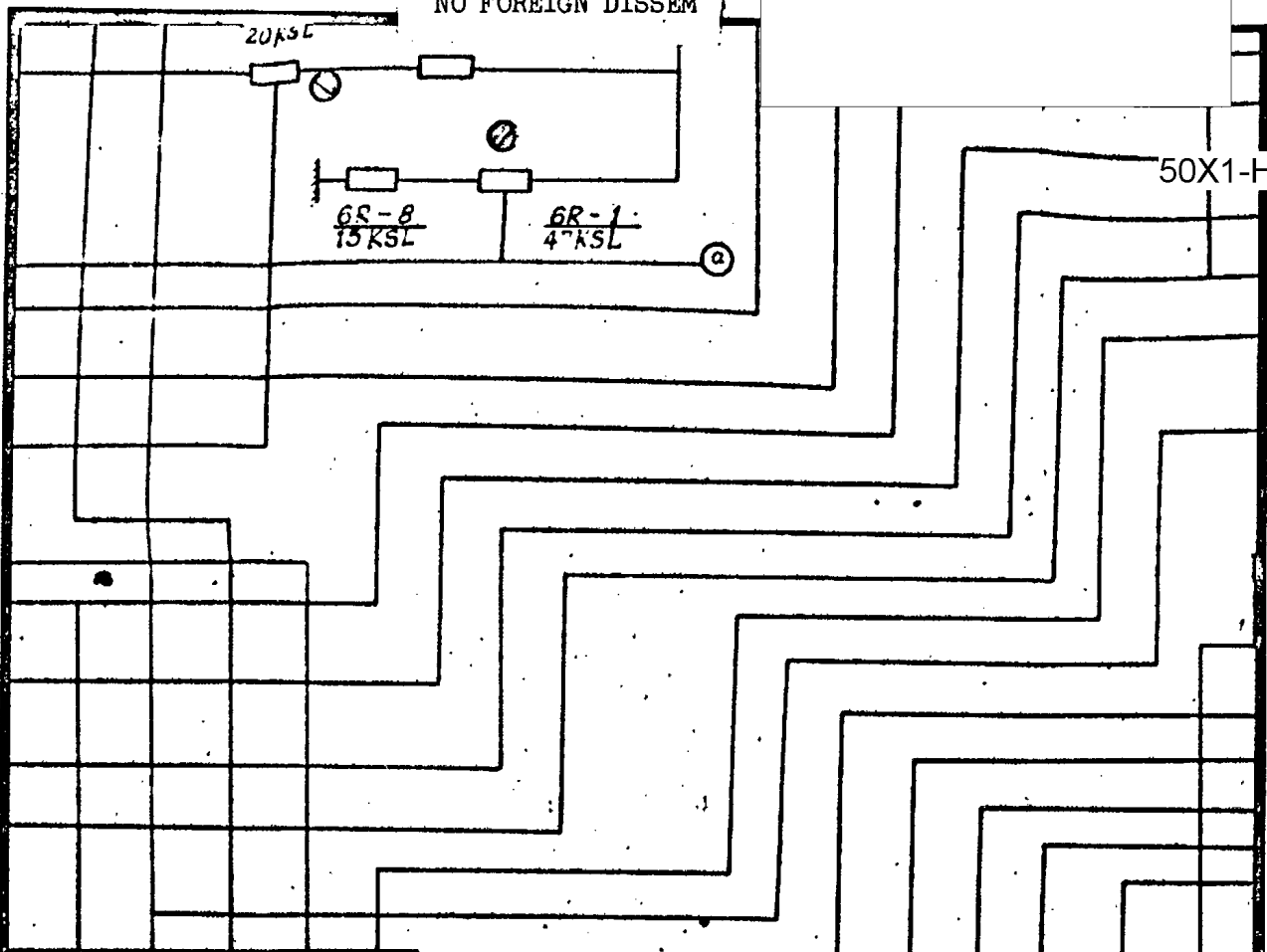

50X1-HUM

	3	4	5	6	7
Customize routing					
Control signal					
ASP-AN Diopleter					

26 ASP-1

Pos	1	2	3	4	5	6
Destination	(6)	(12)	(17)	(18)	(19)	(20)
Where it Leads	TO ASP-AN diopleter					

652R-6 cab ASP-2

7

S-E-C-R-E-T
NO FOREIGN DISSEM

NO FOREIGN DISSEM

50X1-HUM

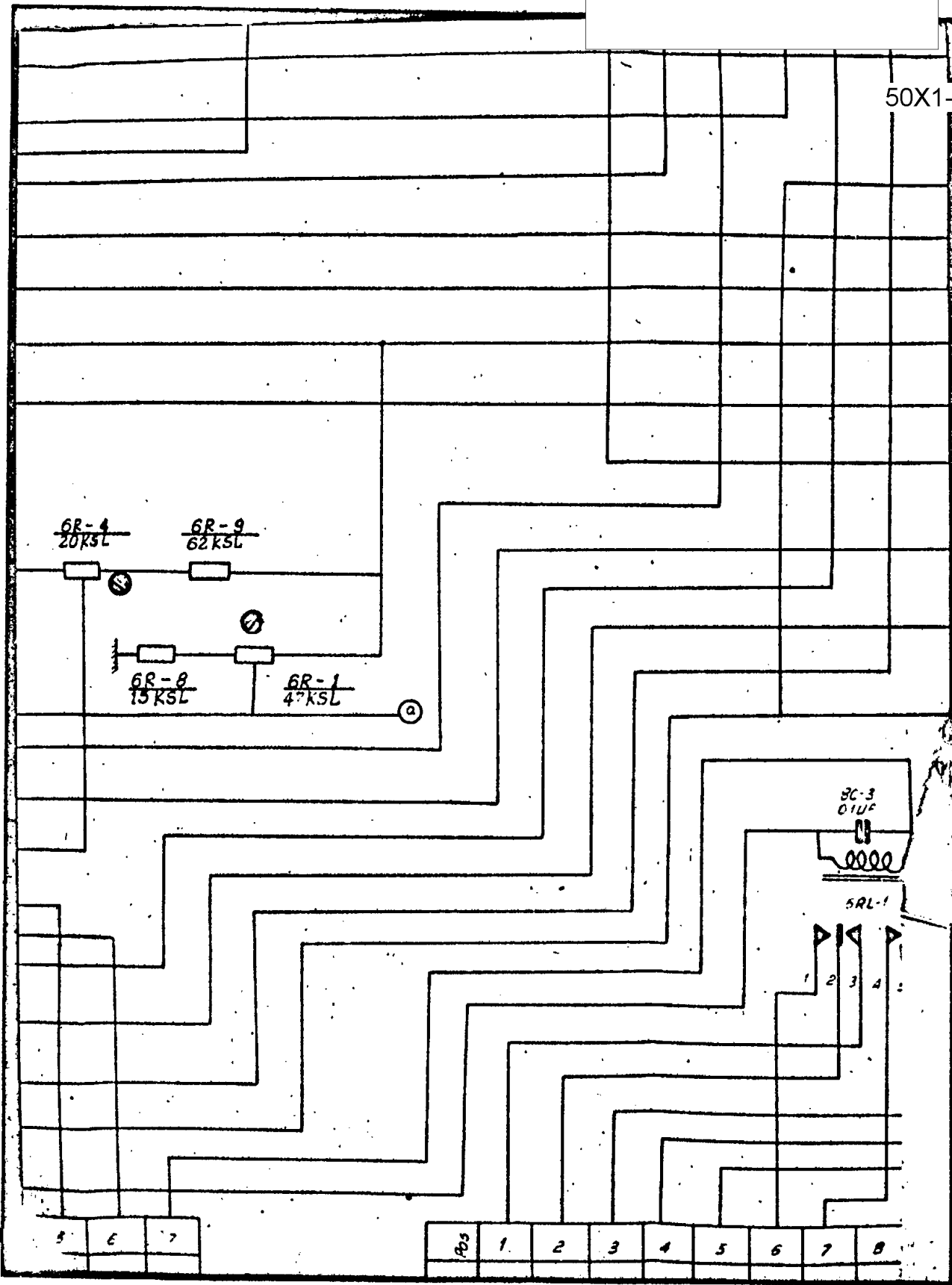

S-E-C-R-E-T

NO FOREIGN DISSEM

NO FOREIGN DISSEM

50X1-HUM

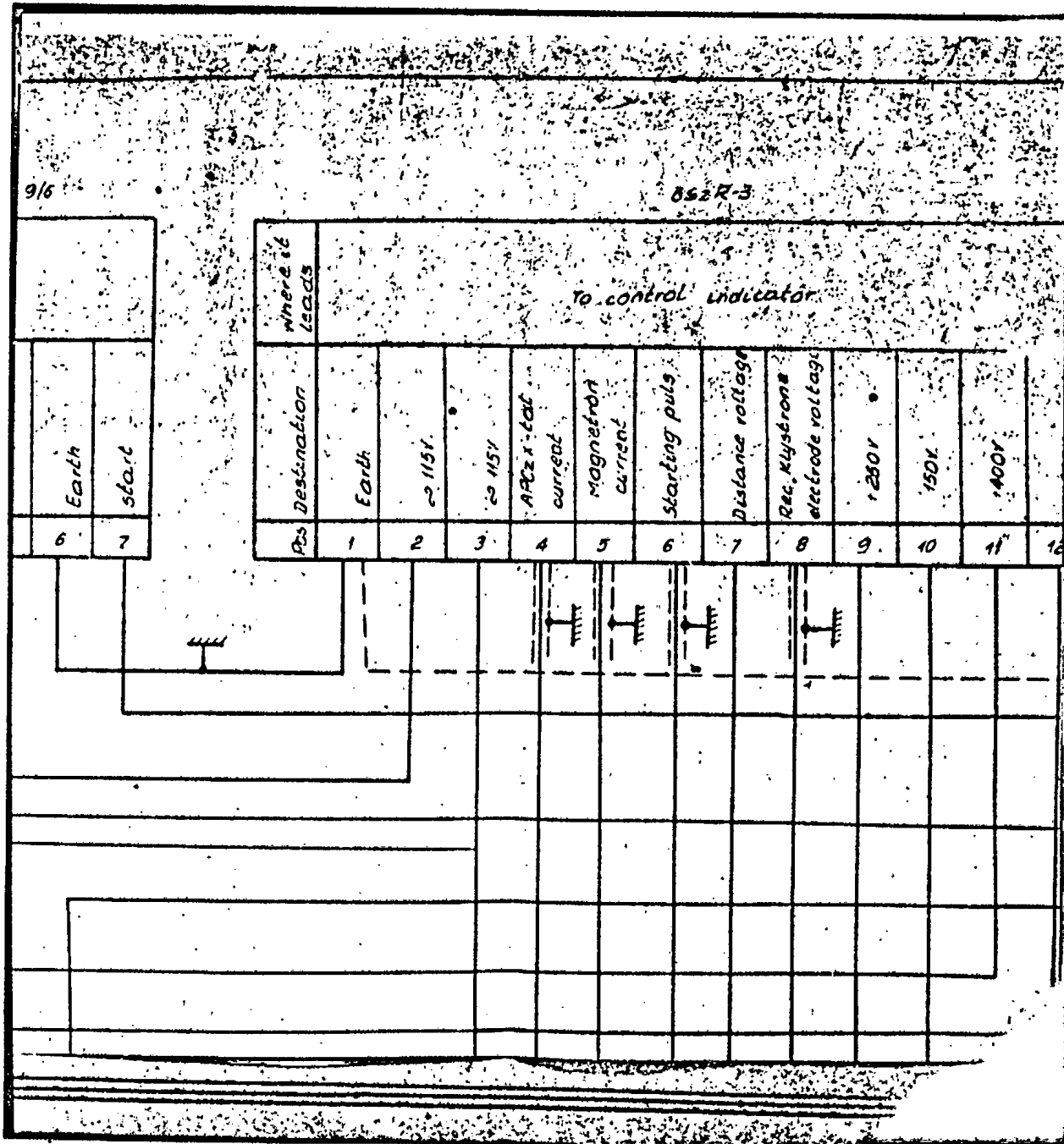

9

S-E-C-R-E-T

NO FOREIGN DISSEM

NO FOREIGN DISSEM

50X1-HUM.

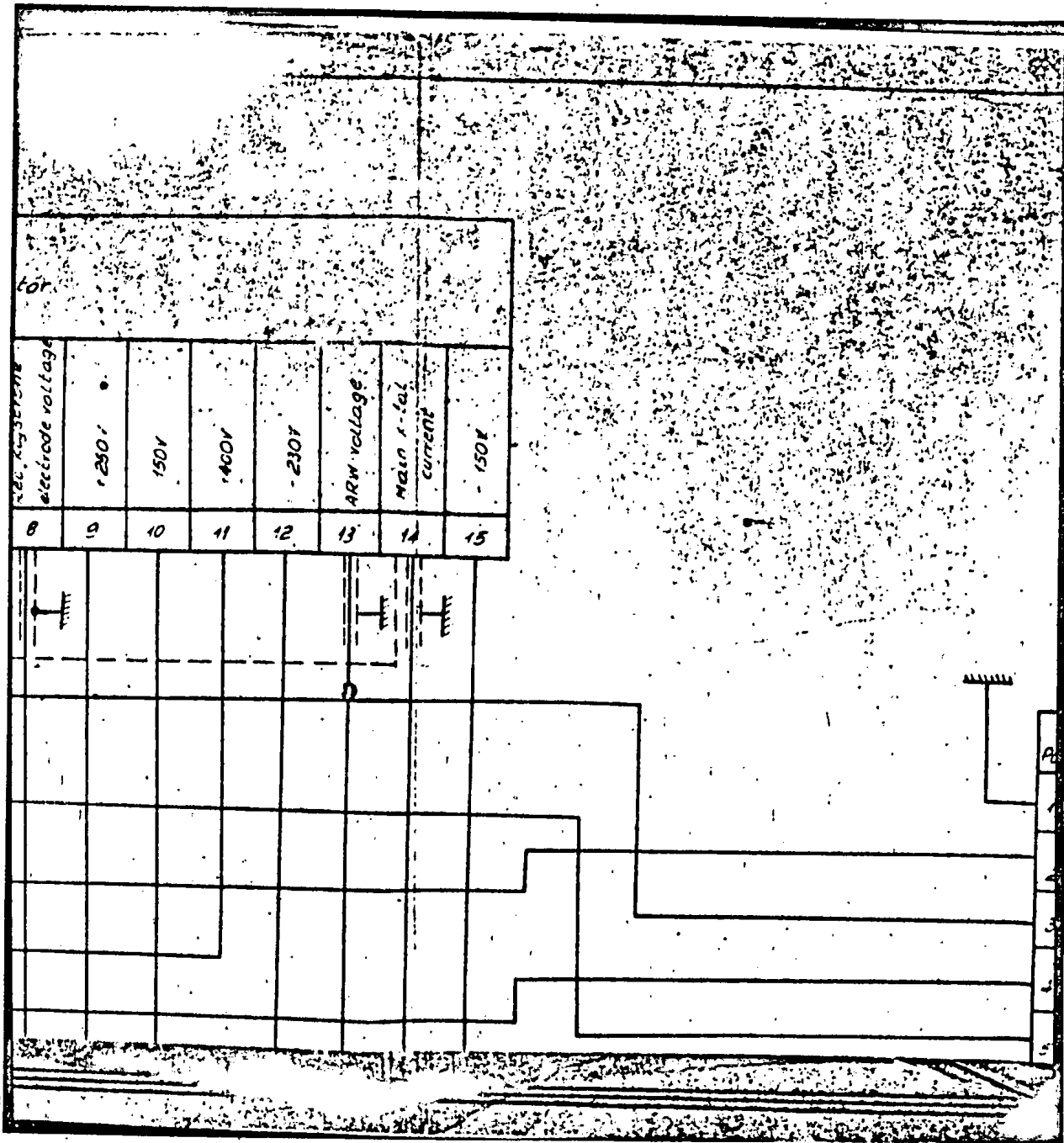

10

S-E-C-R-E-T

NO FOREIGN DISSEM

S-E-C-R-E-T
NO FOREIGN DISSEM

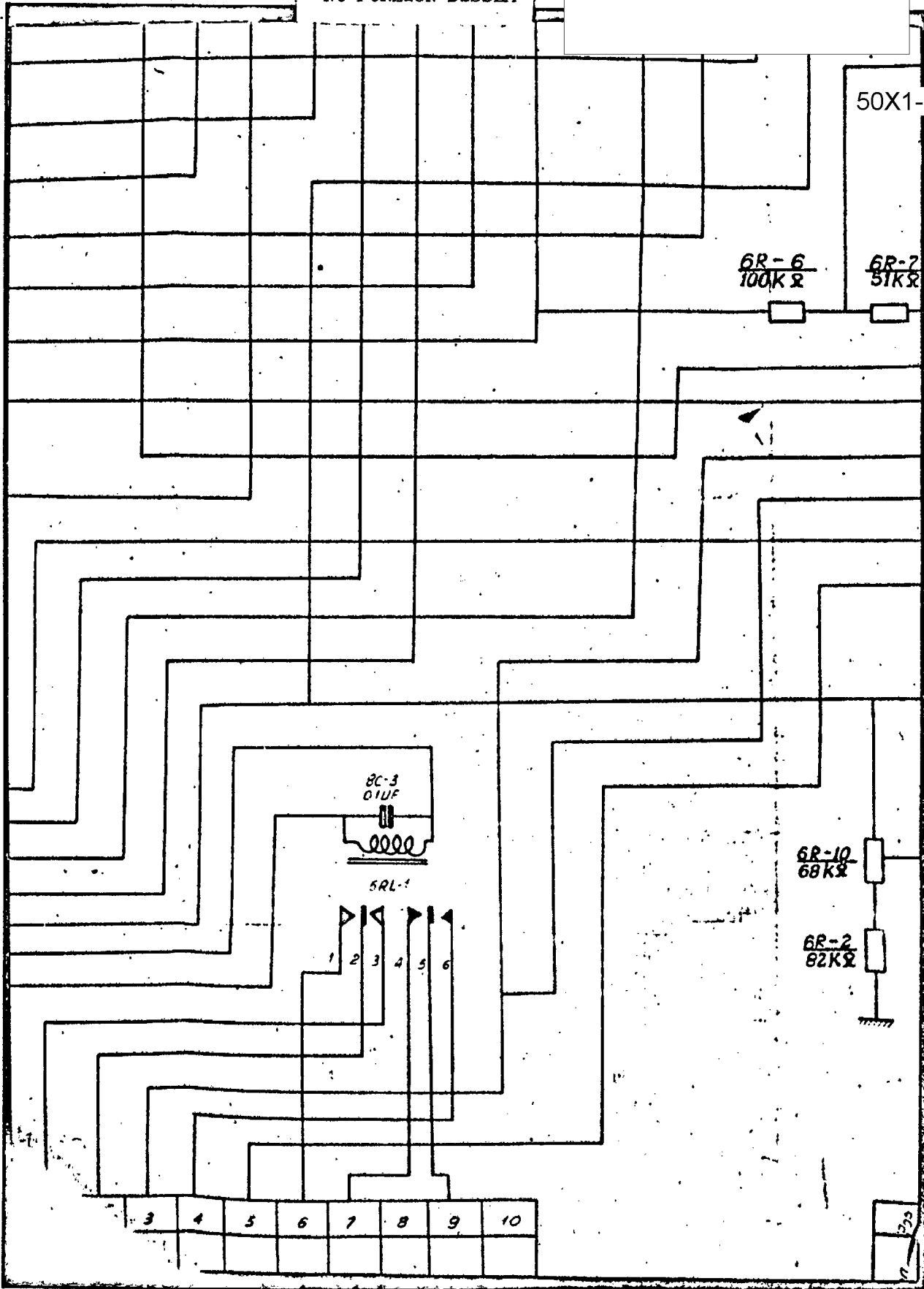

S-E-C-R-E-T
NO FOREIGN DISSEM

NO FOREIGN DISSEM

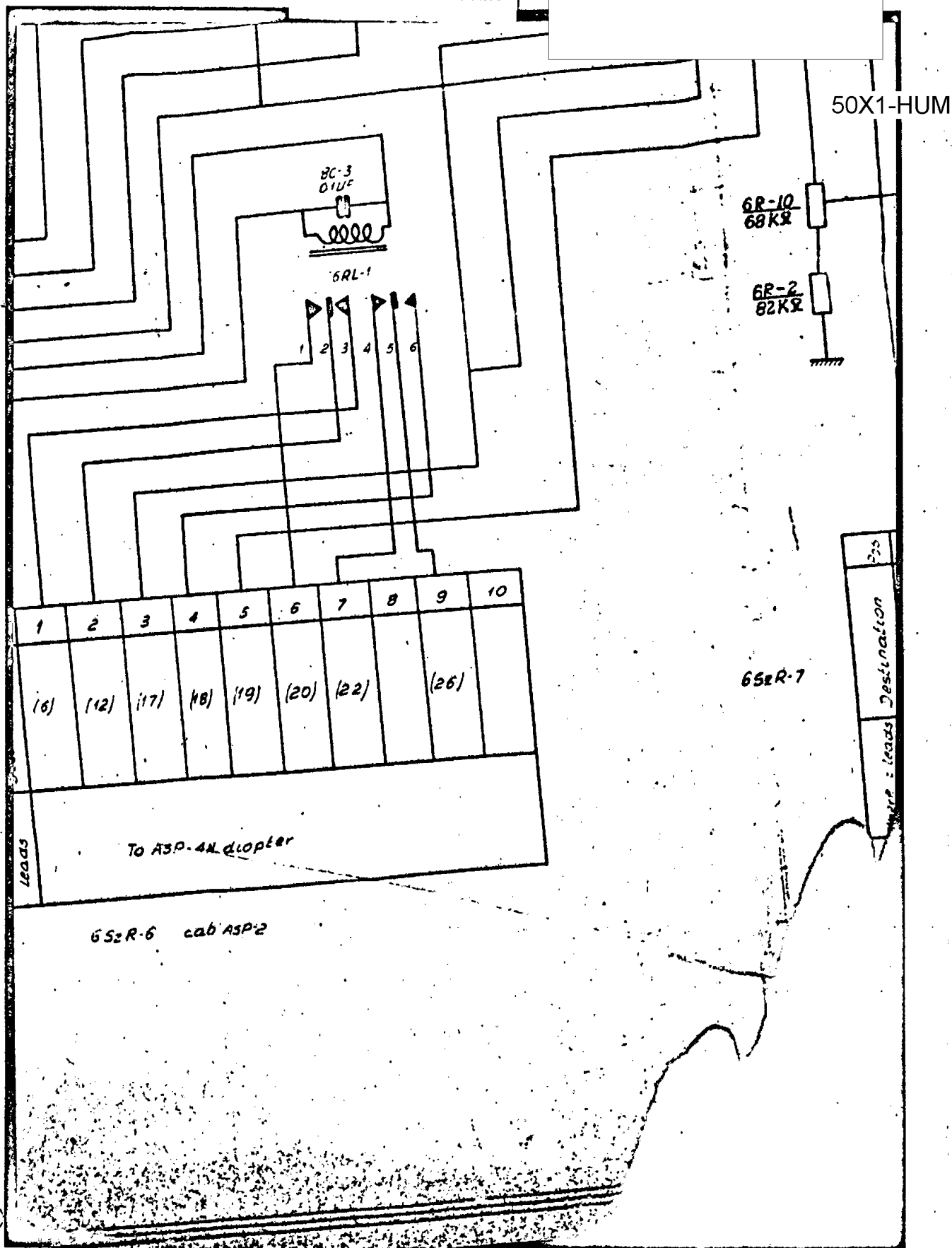

1	2	3	4	5	6	7	8	9	10
(6)	(12)	(17)	(18)	(19)	(20)	(22)		(26)	

To ASP-4M diopler

6S2R-6 cab ASP-2

6S2R-7

Leads : leads Destination

(12)

S-E-C-R-E-T
NO FOREIGN DISSEM

NO FOREIGN DISSEM

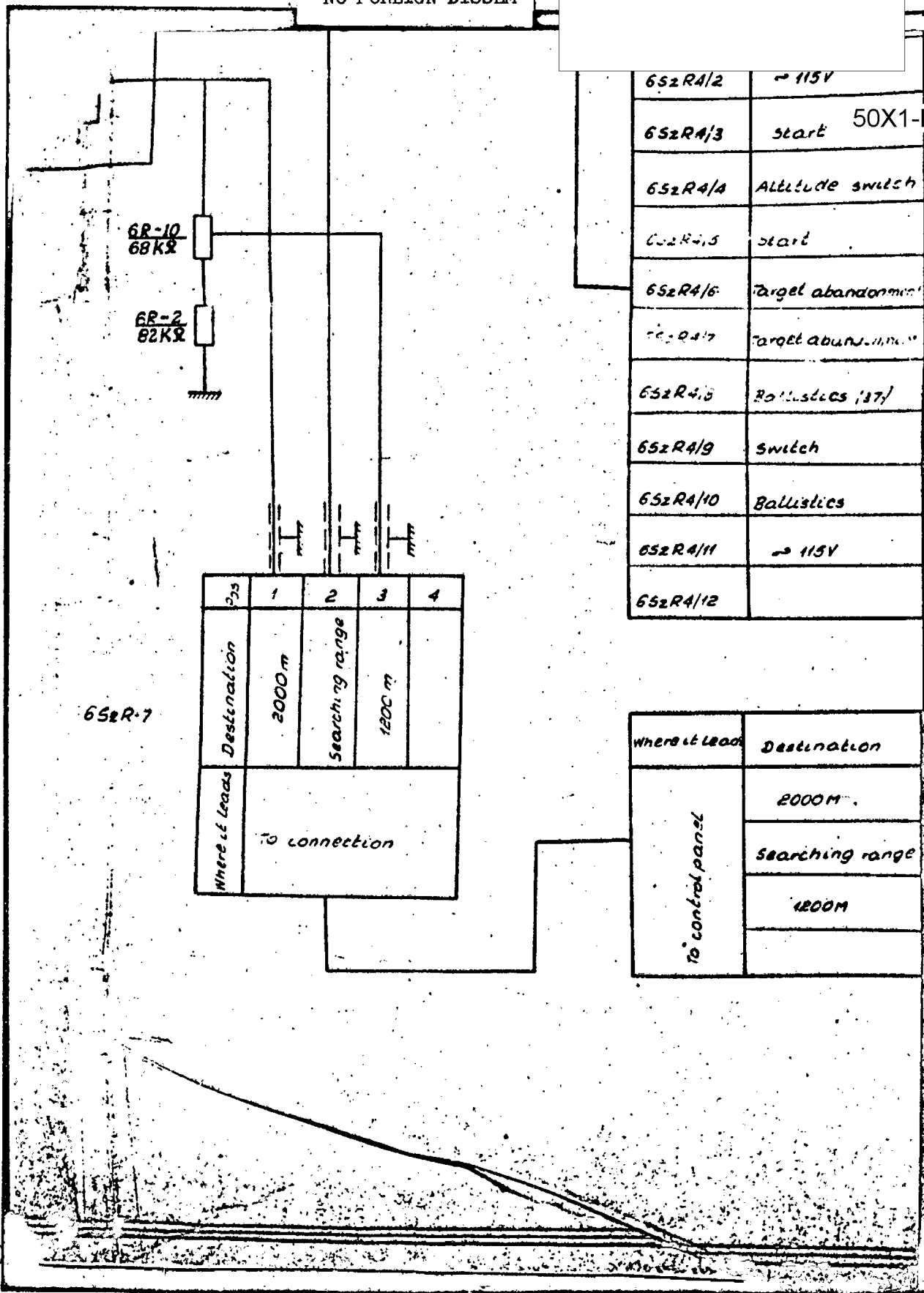

65zR-7

	1	2	3	4
Destination	2000 m	Searching range	1200 m	
Where it leads	To connection			

65zR4/2	~ 115V
65zR4/3	start 50X1-HUM
65zR4/4	Altitude switch
65zR4/5	start
65zR4/6	Target abandonment
65zR4/7	Target abandonment
65zR4/8	Ballistics (37)
65zR4/9	switch
65zR4/10	Ballistics
65zR4/11	~ 115V
65zR4/12	

Where it leads	Destination
To control panel	2000M
	Searching range
	1200M

15

S-E-C-R-E-T
NO FOREIGN DISSEM

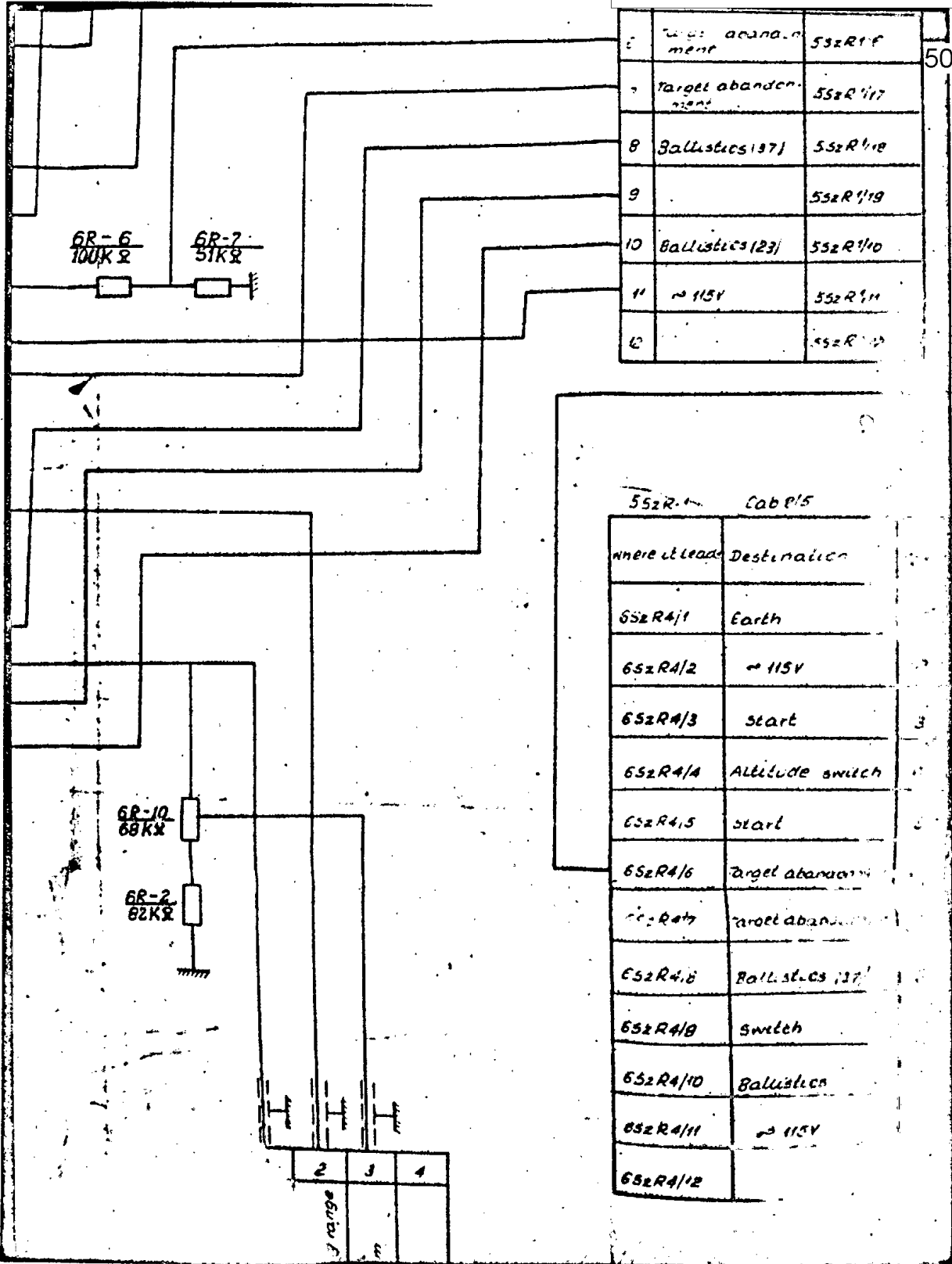

5	Target abandonment	55zR116
6	Target abandonment	55zR117
8	Ballistics (37)	55zR118
9		55zR119
10	Ballistics (23)	55zR110
11	~ 115V	55zR111
12		55zR112

50X1-HUM

55zR	Destination
65zR4/1	Earth
65zR4/2	~ 115V
65zR4/3	Start
65zR4/4	Altitude switch
65zR4/5	Start
65zR4/6	Target abandonment
65zR4/7	Target abandonment
65zR4/8	Ballistics (37)
65zR4/9	Switch
65zR4/10	Ballistics
65zR4/11	~ 115V
65zR4/12	

14

S-E-C-R-E-T
 NO FOREIGN DISSEM

NO FOREIGN DISSEM

50X1-HUM

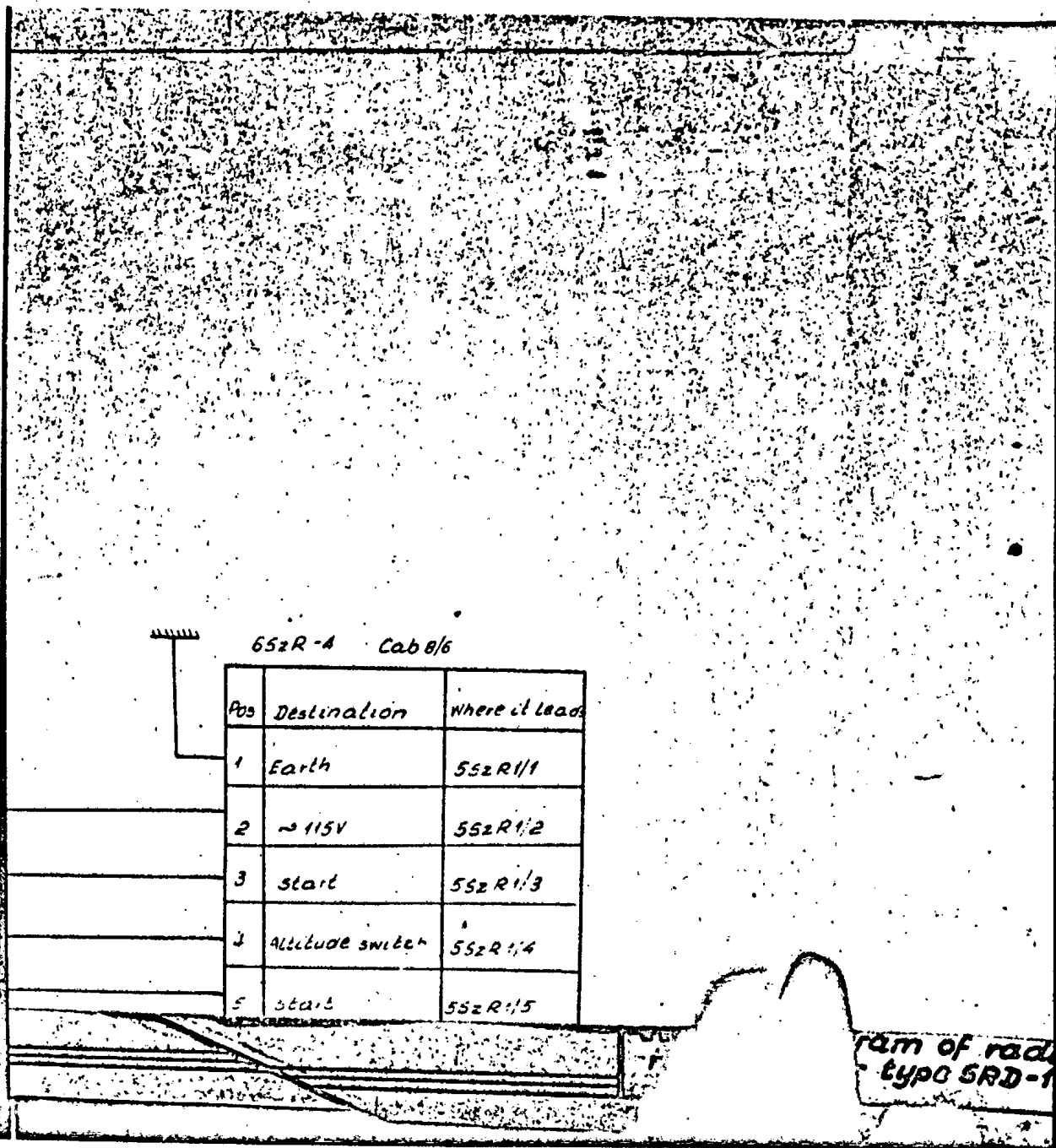

S-E-C-R-E-T

NO FOREIGN DISSEM

NO FOREIGN DISSEM

SR 16
SR 17
SR 18
SR 19
SR 10
SR 11
SR 12

50X1-HUM

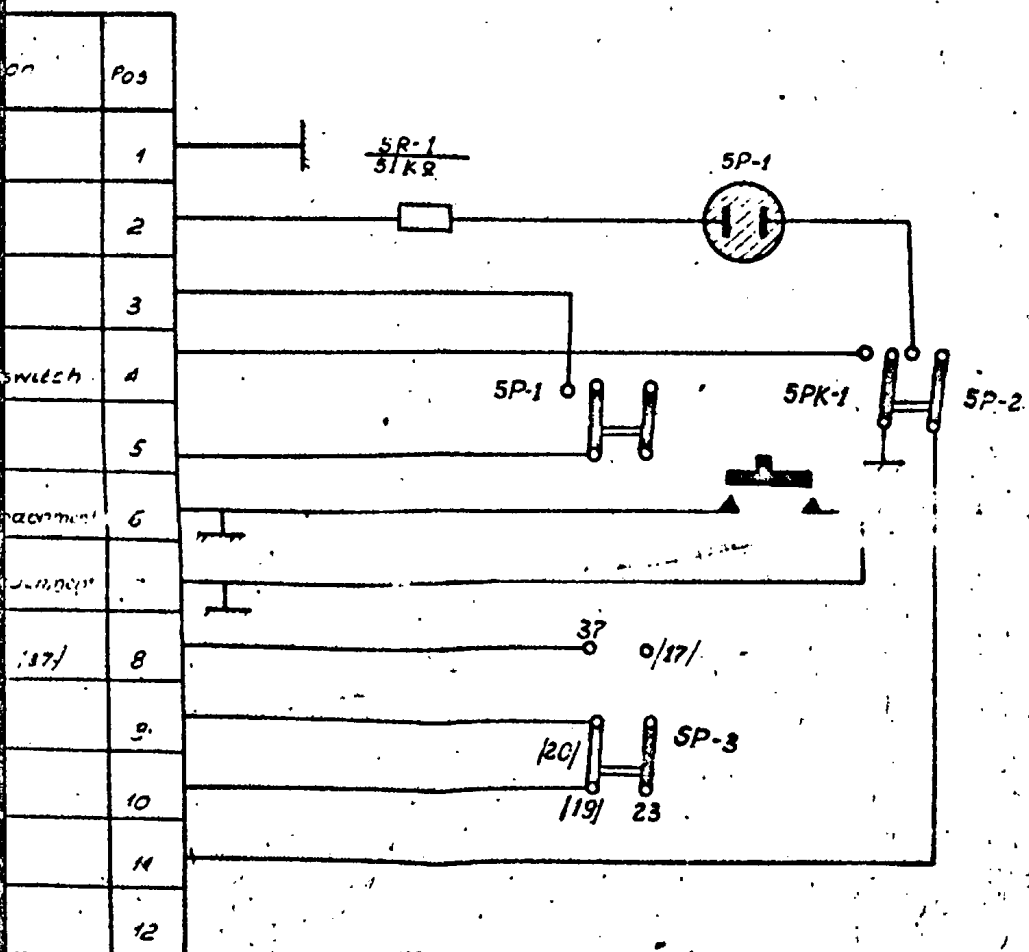

(16)

S-E-C-R-E-T

NO FOREIGN DISSEM

S-E-C-R-E-T
NO FOREIGN DISSEM

50X1-HUM

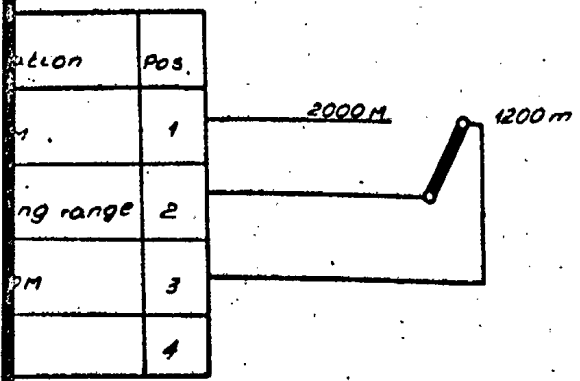
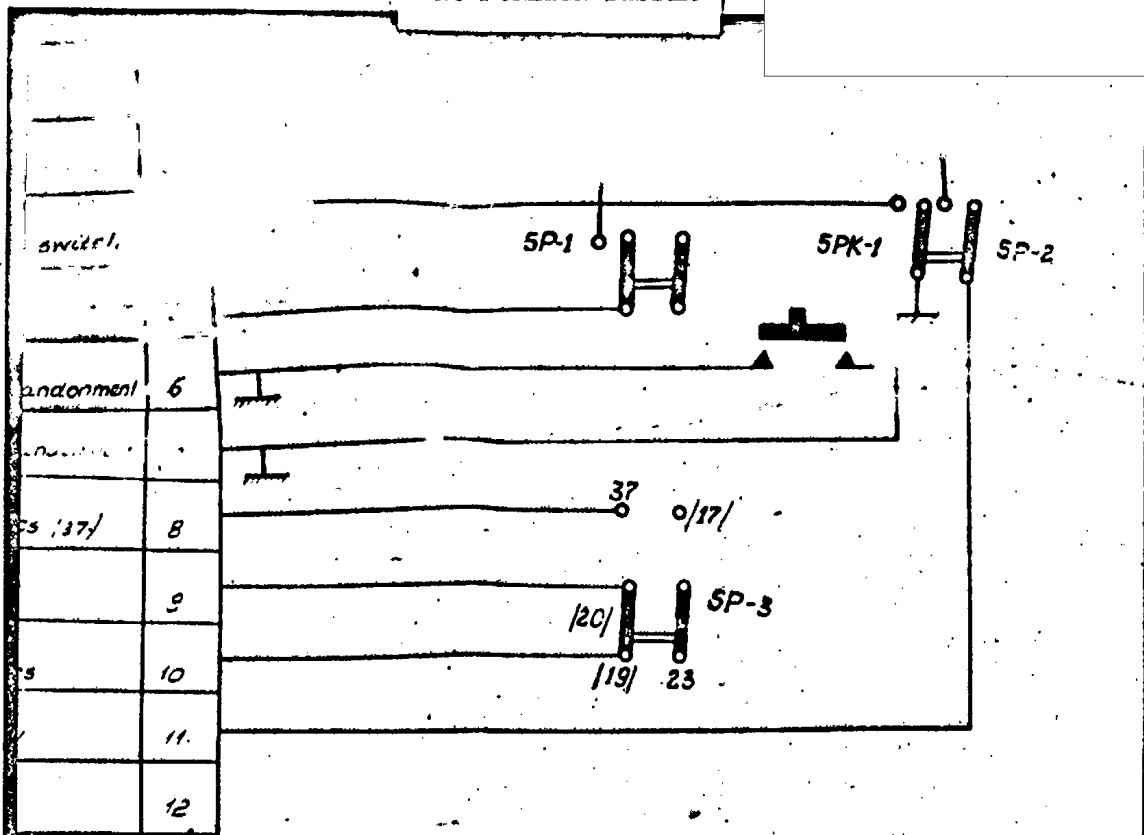

Circuit diagram of radio-range finder type SRD-1M
SERIAL No. 4

5325110058
0092

(17)

S-E-C-R-E-T

NO FOREIGN DISSEM

S-E-C-R-E-T
NO FOREIGN DISSEM

50X1-HUM

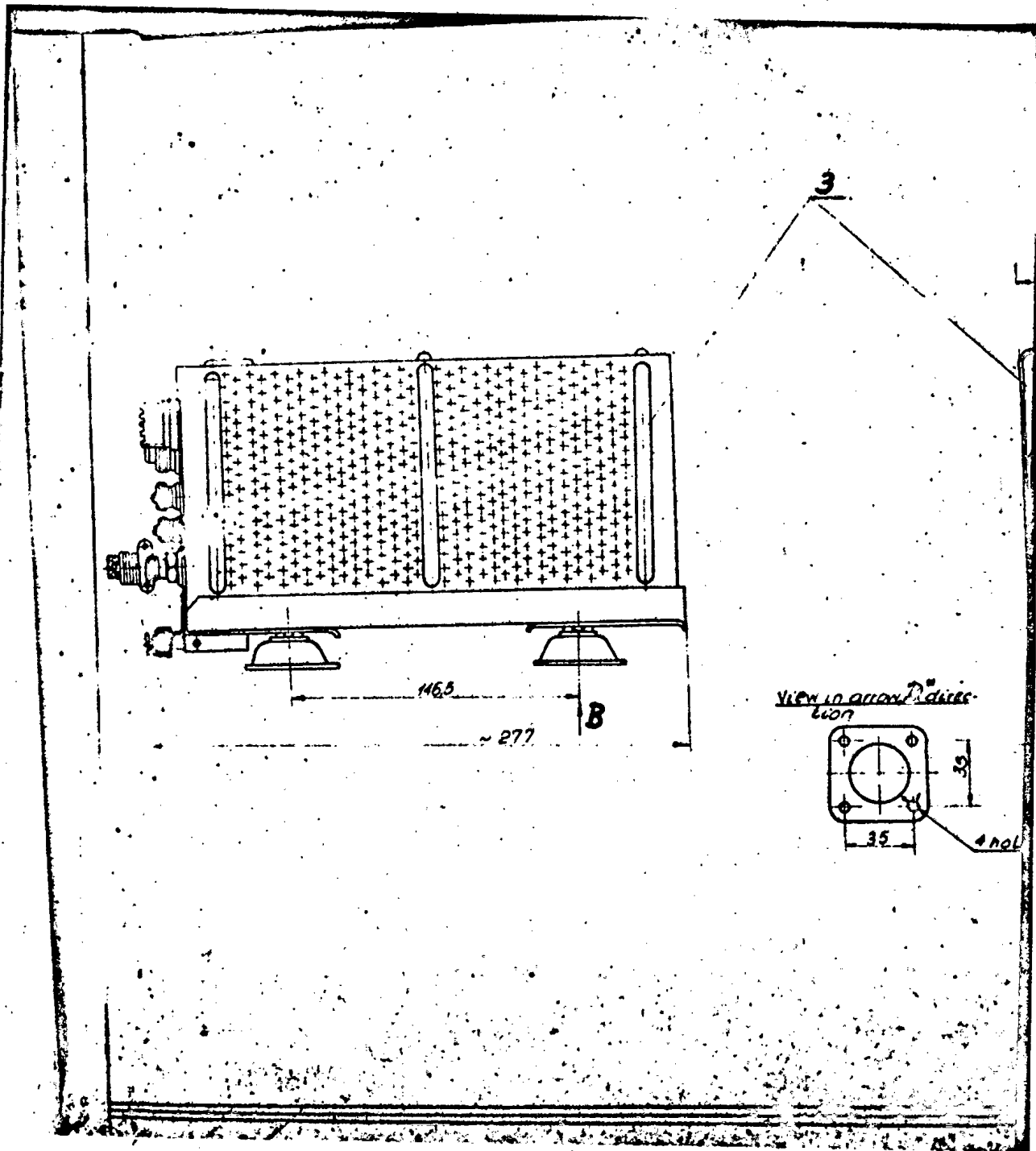

(1)

S-E-C-R-E-T
NO FOREIGN DISSEM

50X1-HUM

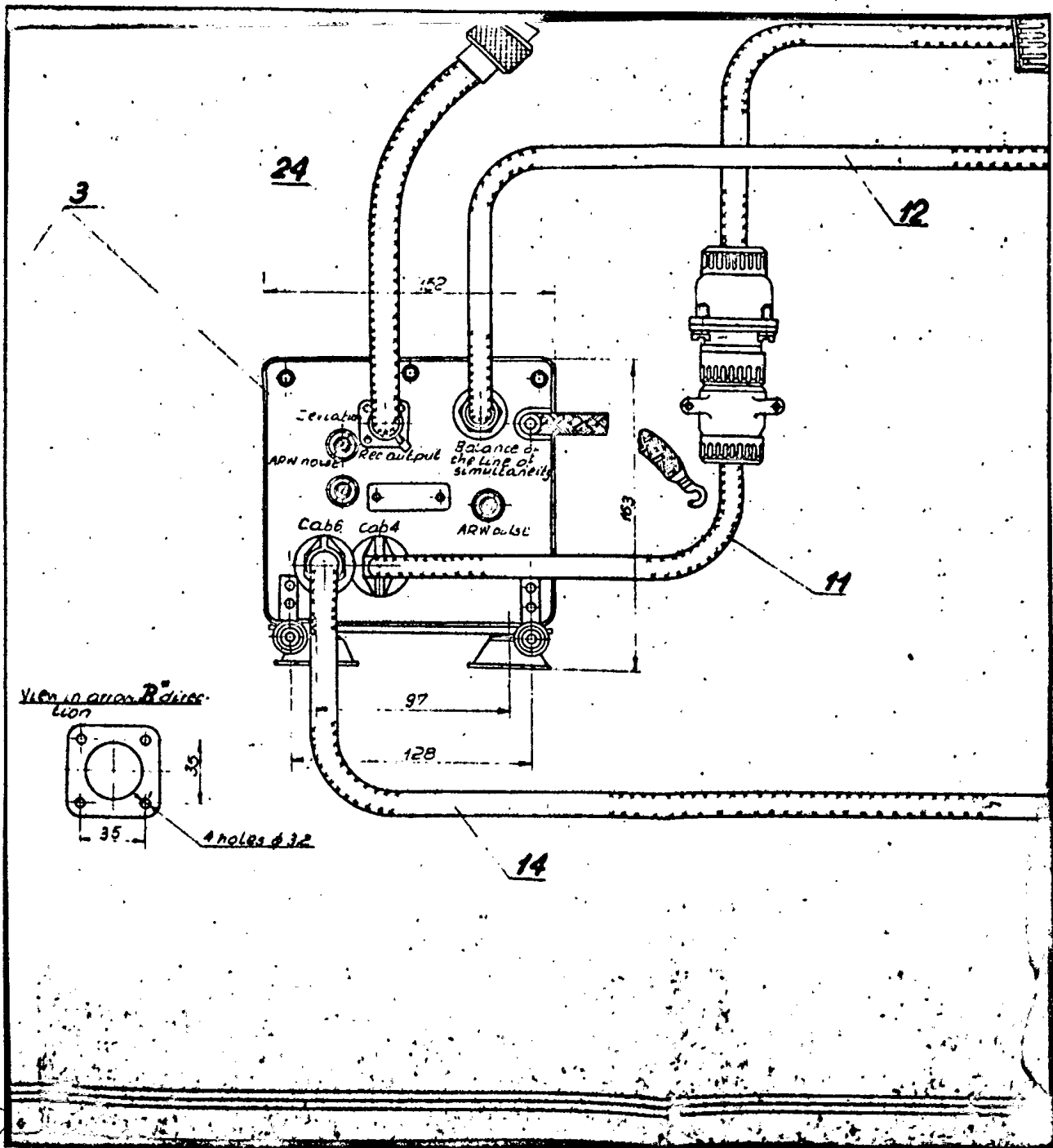

S-E-C-R-E-T
NO FOREIGN DISSEM

50X1-HUM

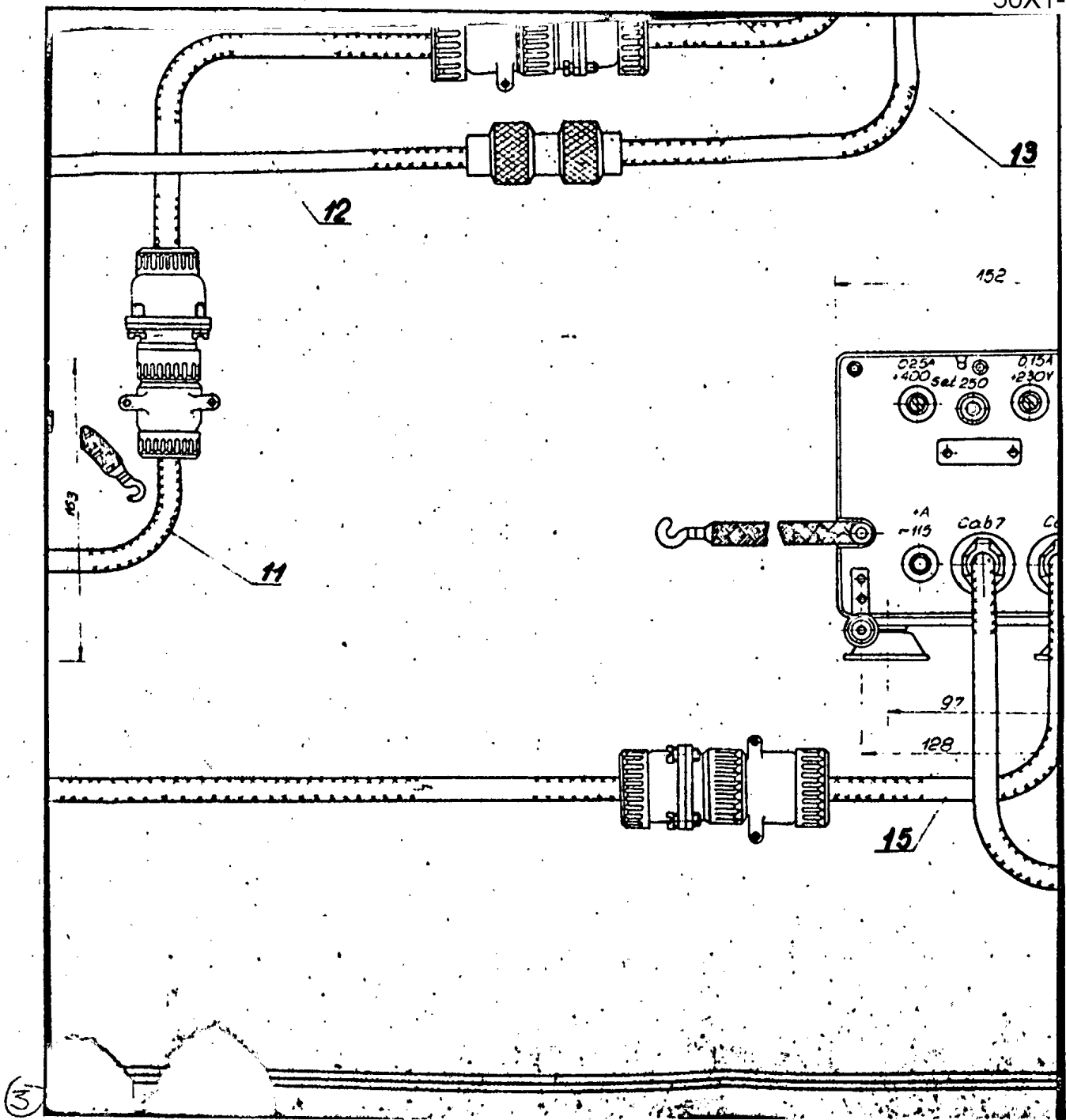

S-E-C-R-E-T
(NO FOREIGN DISSEM)

50X1-HUM

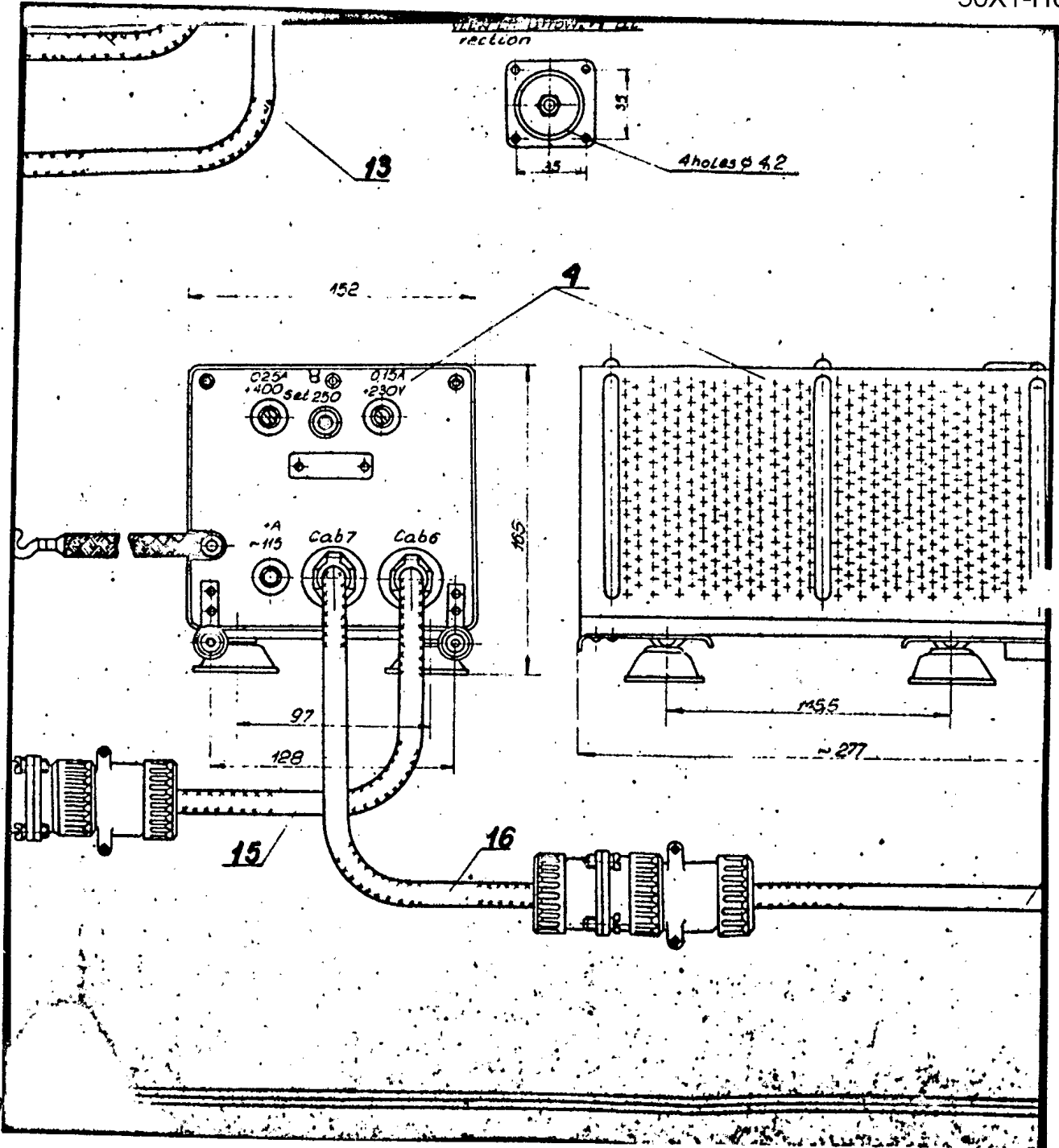

(S-E-C-R-E-T)
NO FOREIGN DISSEM

NO FOREIGN DISSEM

50X1-HUM

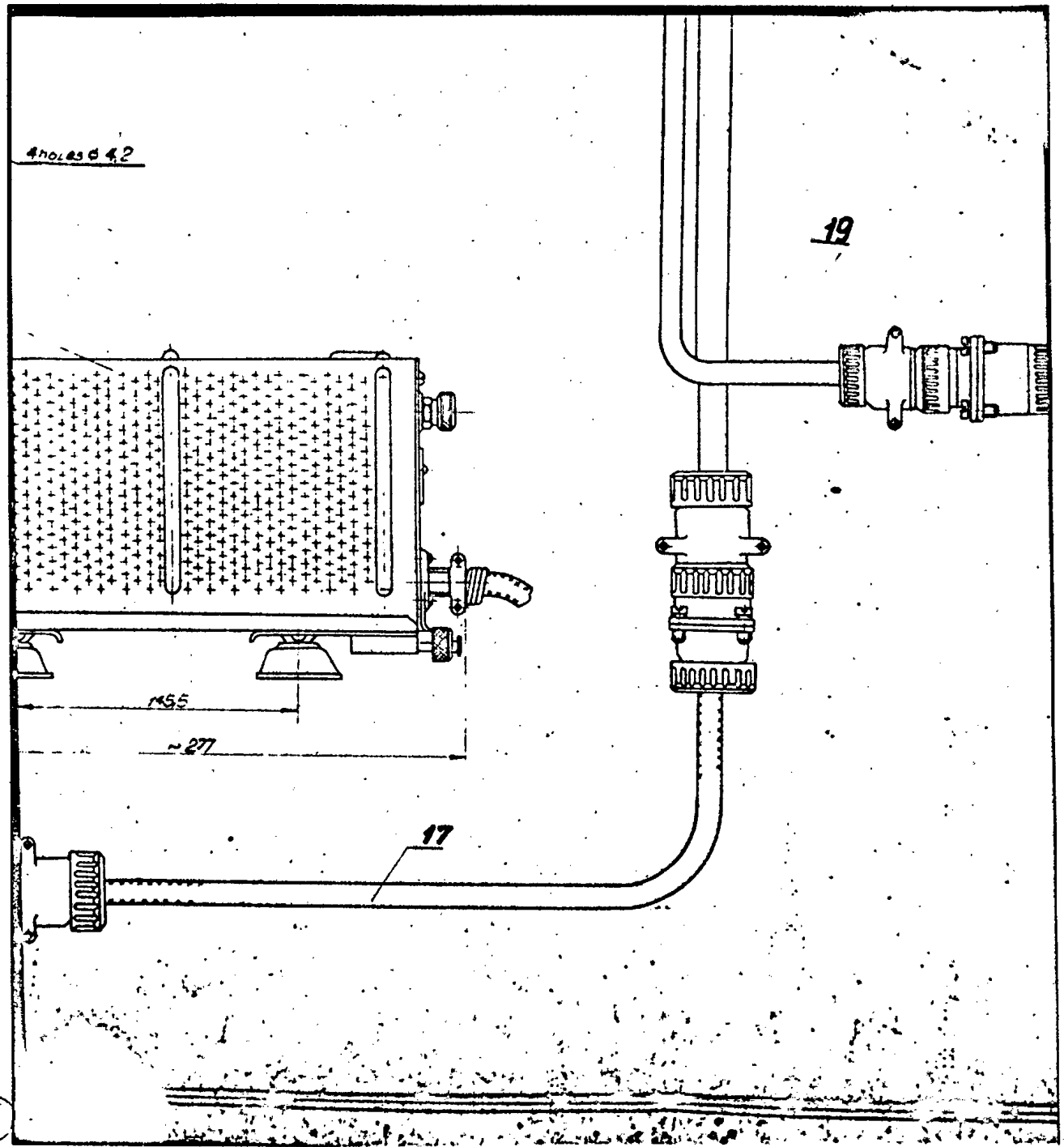

S-E-C-R-E-T
NO FOREIGN DISSEM

NO FOREIGN DISSEM

50X1-HUM

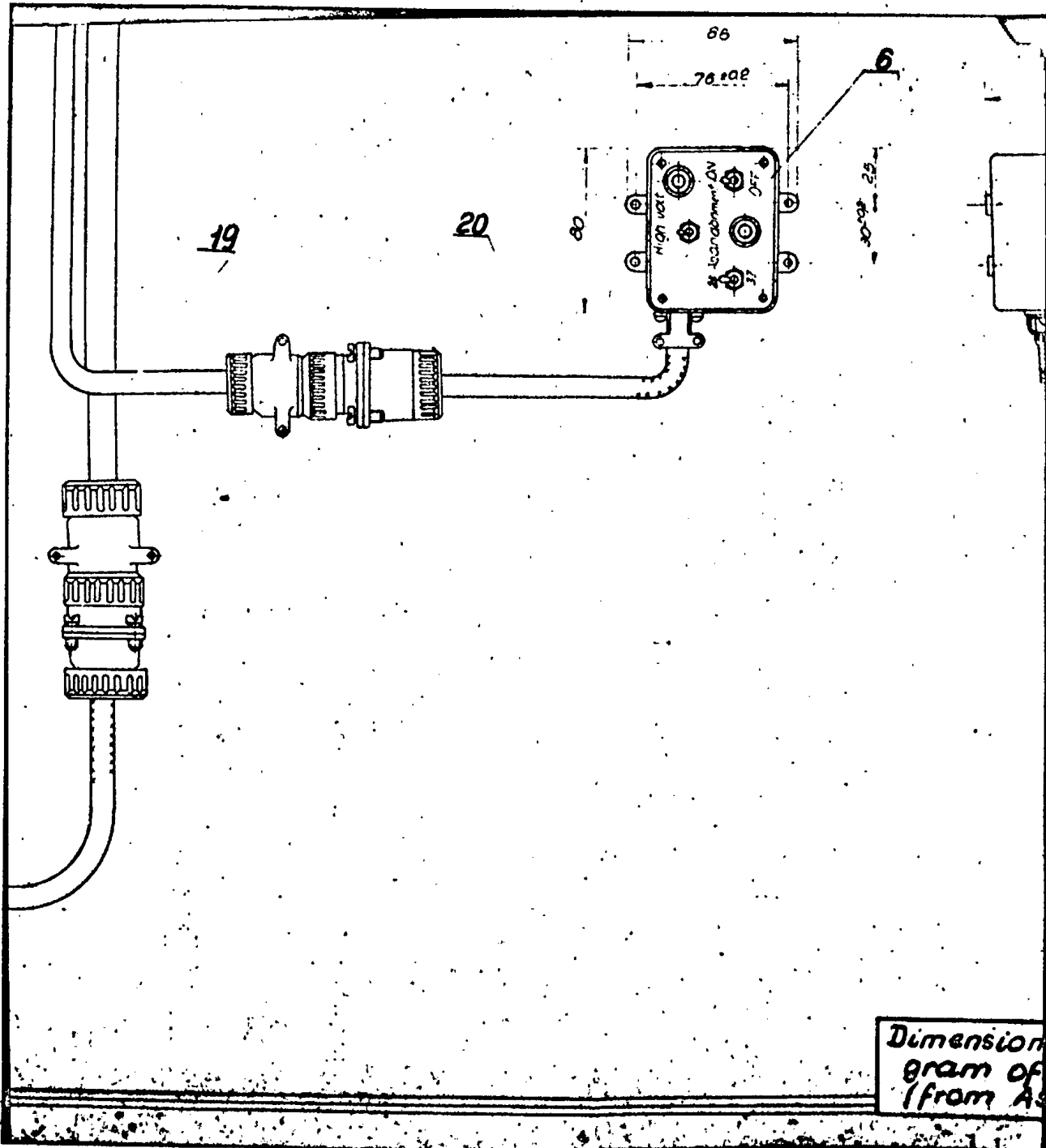

S-E-C-R-E-T

NO FOREIGN DISSEM

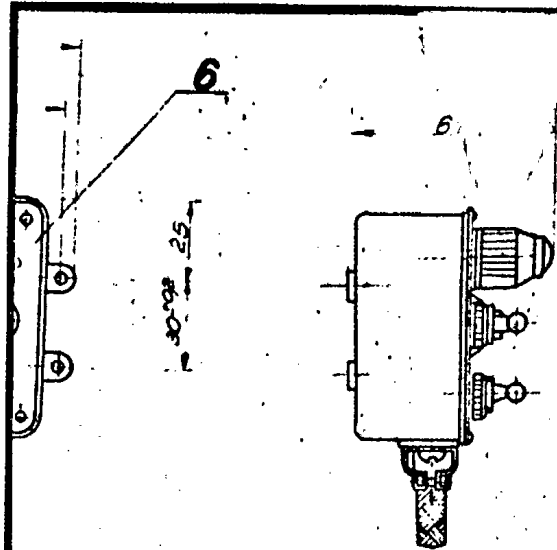
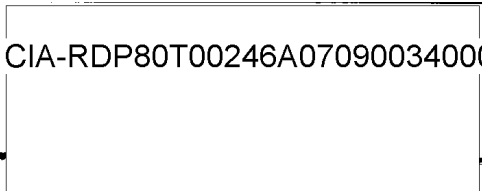

50X1-HUM

26	GJa 4 853 011	Cable Nr ASP-2	1	L=500
25	GJa 4 853 010	Cable Nr ASP-1	1	L=500
24	GJa 4 850 222	Cable Nr "	1	L=500
23	GJa 4 853 015	Cable Nr 9A	1	L=1600
22	GJa 4 853 014	Cable Nr 9	1	L=300
21	GJa 4 853 009	Cable Nr 9/6	1	L=800
20	GJa 4 853 007	Cable Nr 8/5	1	L=300
19	GJa 4 853 008	Cable Nr 8/6	1	L=500
18	GJa 4 853 006	Cable Nr 7/6	1	L=650
17	GJa 4 853 013	Cable Nr 7	1	L=1400
16	GJa 4 853 005	Cable Nr 7,3	1	L=500
15	GJa 4 853 004	Cable Nr 7,4	1	L=400
14	GJa 4 853 003	Cable Nr 6/3	1	L=600
13	IPM-7-3-000	Cable Nr 5	1	L=1300
12	IPM-7-2-000	Cable Nr 5a	1	L=600
11	GJa 4 853 002	Cable Nr 4/3	1	L=200
10	GJa 4 853 024	Cable Nr 4A	1	L=600
9	GJa 4 853 012	Cable Nr 4	1	L=1300
8	GJa 4 850 010	Cable Nr 0	1	L=475
7	TU311-55	Converter MA-500M	1	
6	GJa 2 330 001	Control panel	1	
5	GJa 2 761 001	Control panel	1	
4	GJa 2 087 907	Power unit	1	
3	GJa 2 003 001	Distance unit	1	
2	GJa 2 000 014	Trans-rec unit	1	
1	GJa 2 094 201	Aerial	1	
Pos	Description	Name	Q-ty	Remarks

Dimension and wiring diagram of BRD-1M units (from ASP-4M)

GJa 1311005 sch / 3
 Page 29

S-E-C-R-E-T
 (NO FOREIGN DISSEM)

50X1-HUM

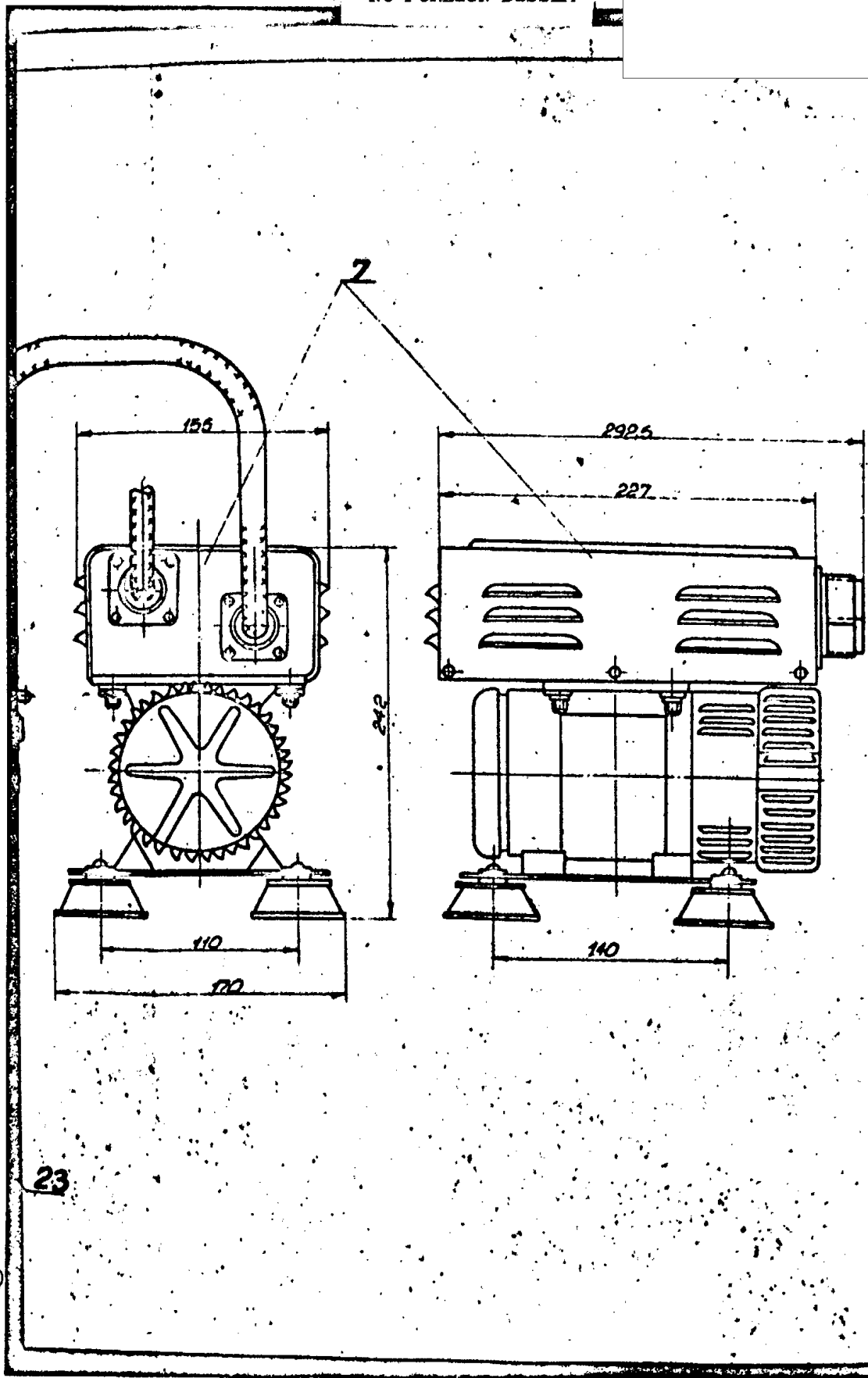

S-E-C-R-E-T
(NO FOREIGN DISSEM)

S-E-C-R-E-T
NO FOREIGN DISSEM

50X1-HUM

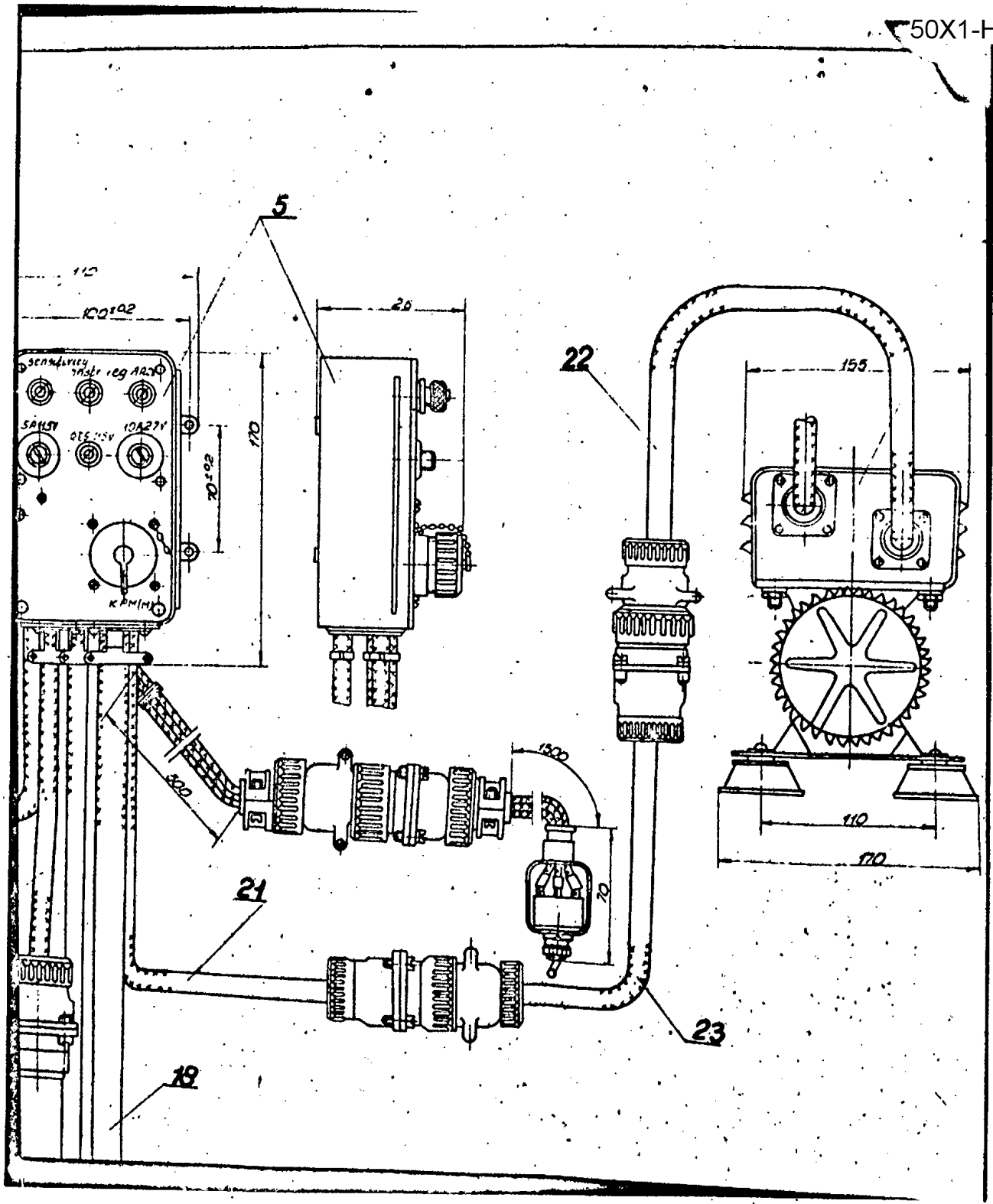

S-E-C-R-E-T
NO FOREIGN DISSEM

50X1-HUM

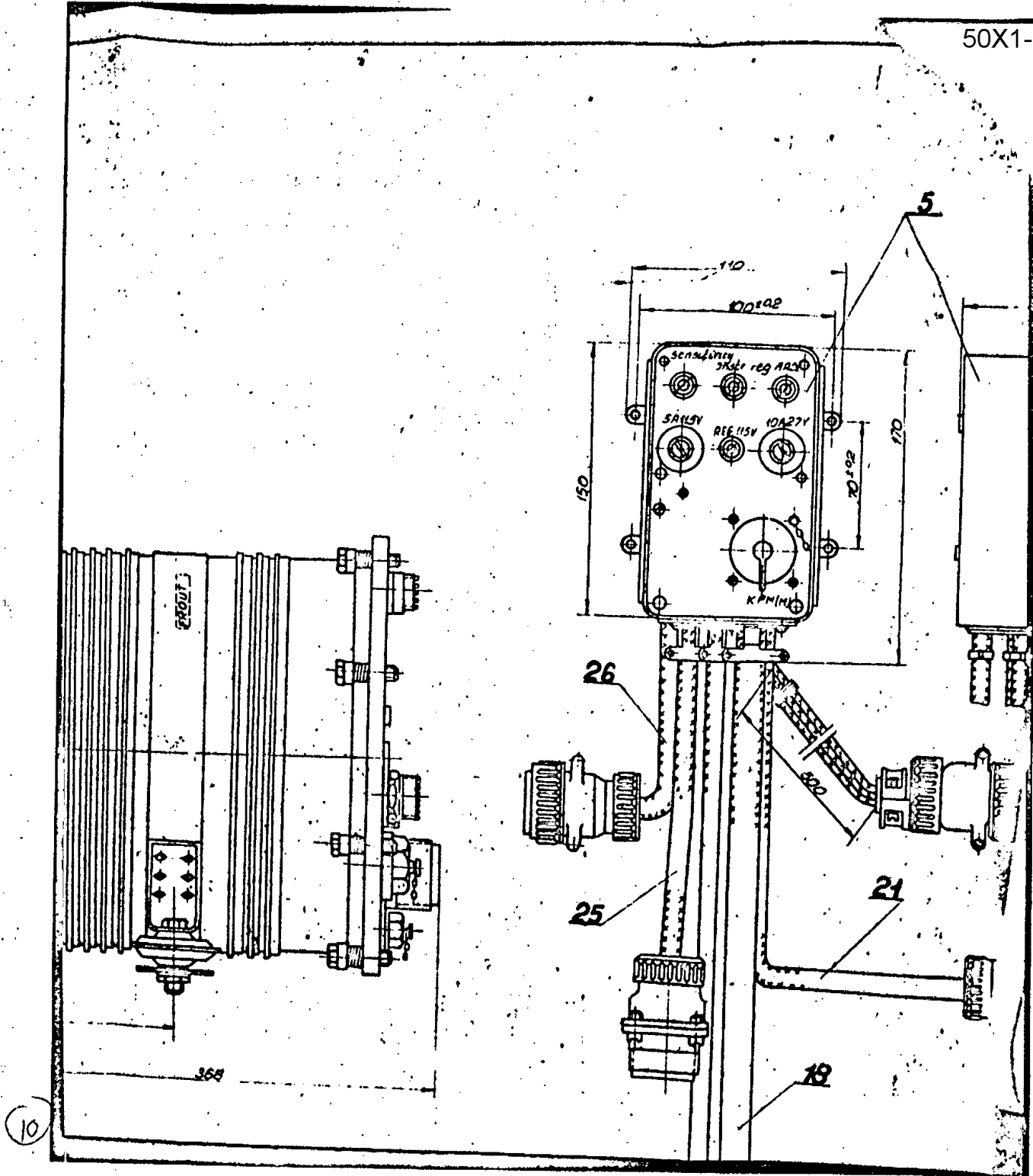

S-E-C-R-E-T
NO FOREIGN DISSEM

NO FOREIGN DISSEM

50X1-HUM

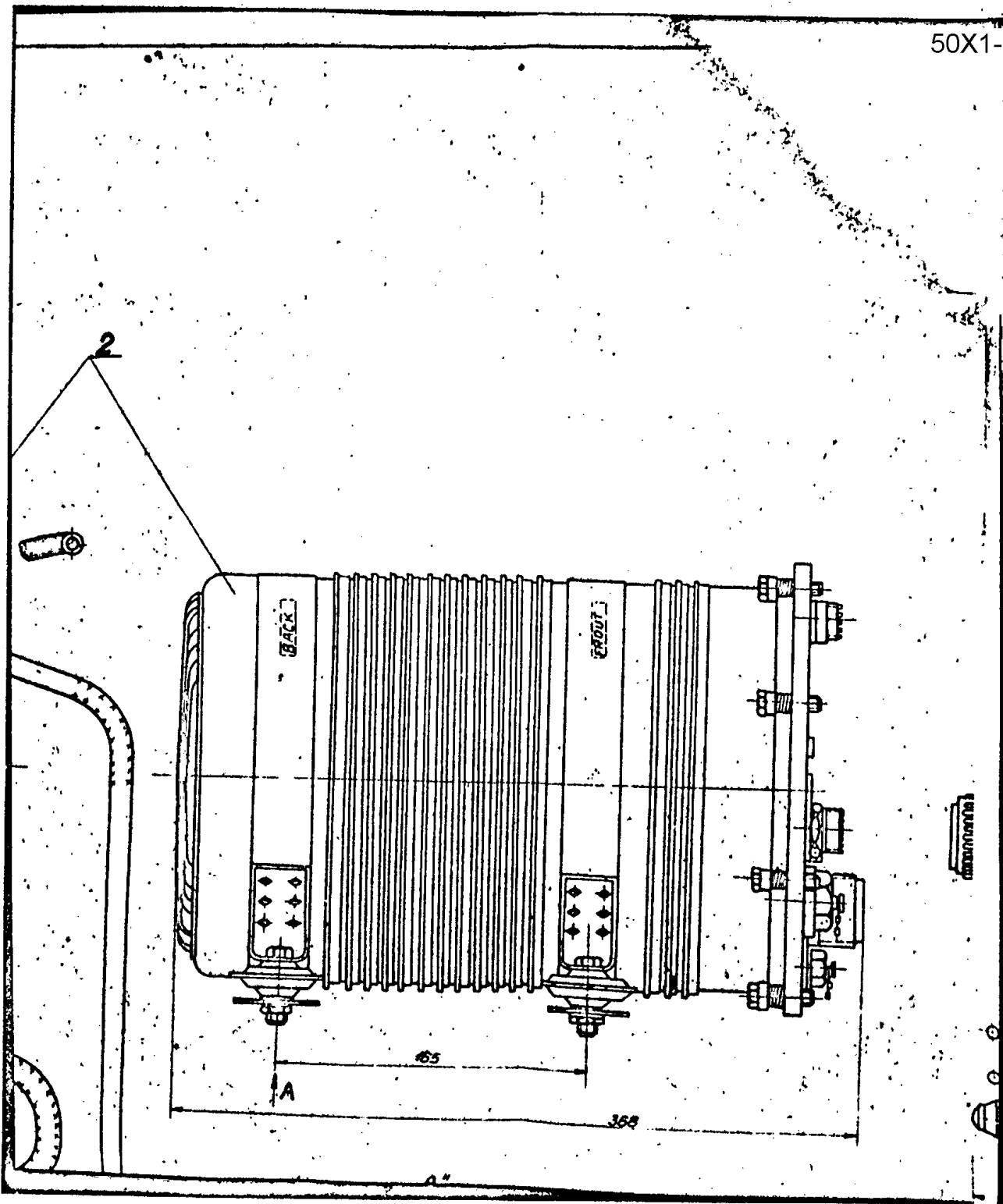

S-E-C-R-E-T

NO FOREIGN DISSEM

NO FOREIGN DISSEM

50X1-HUM

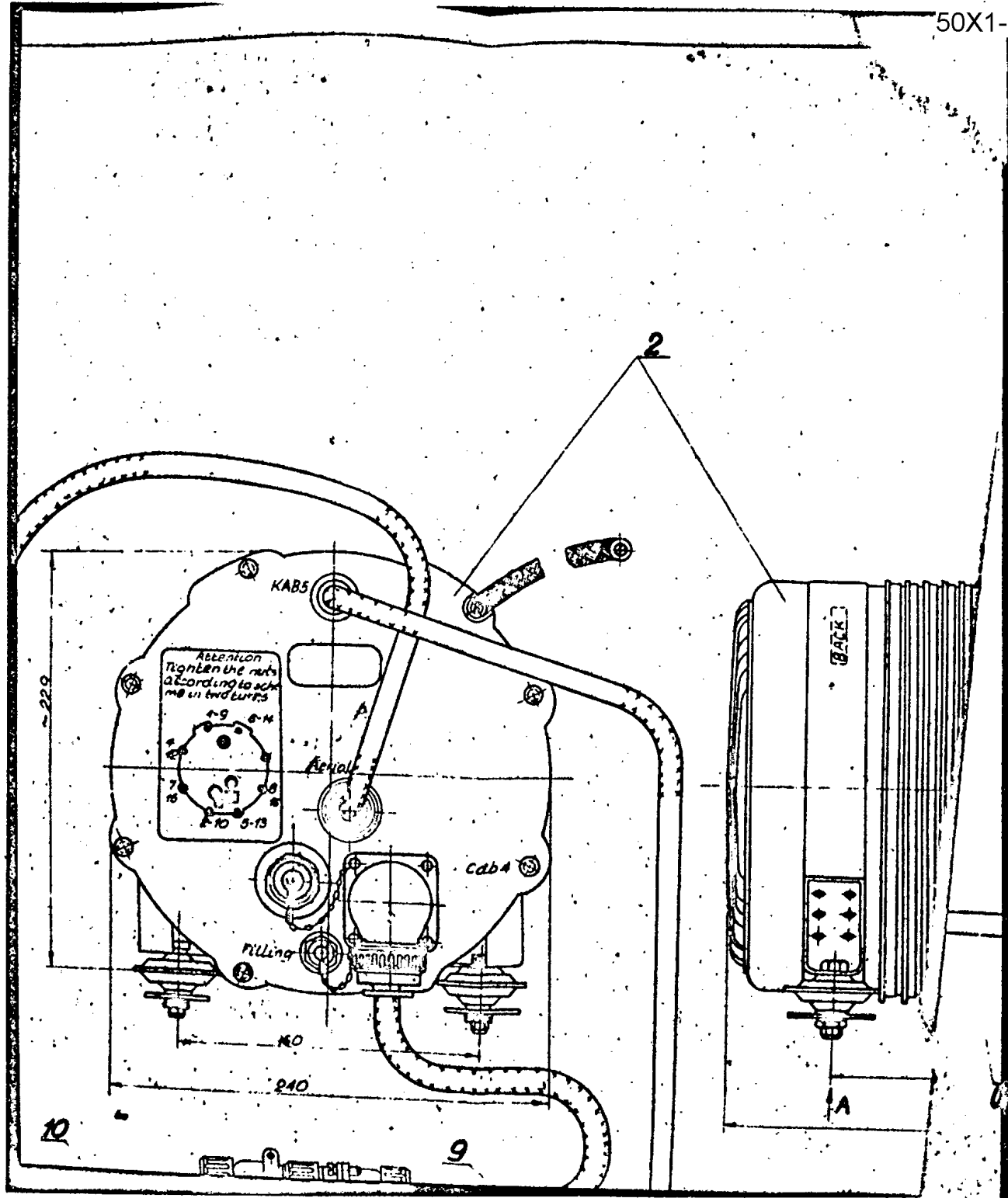

S-E-C-R-E-T

NO FOREIGN DISSEM

50X1-HUM

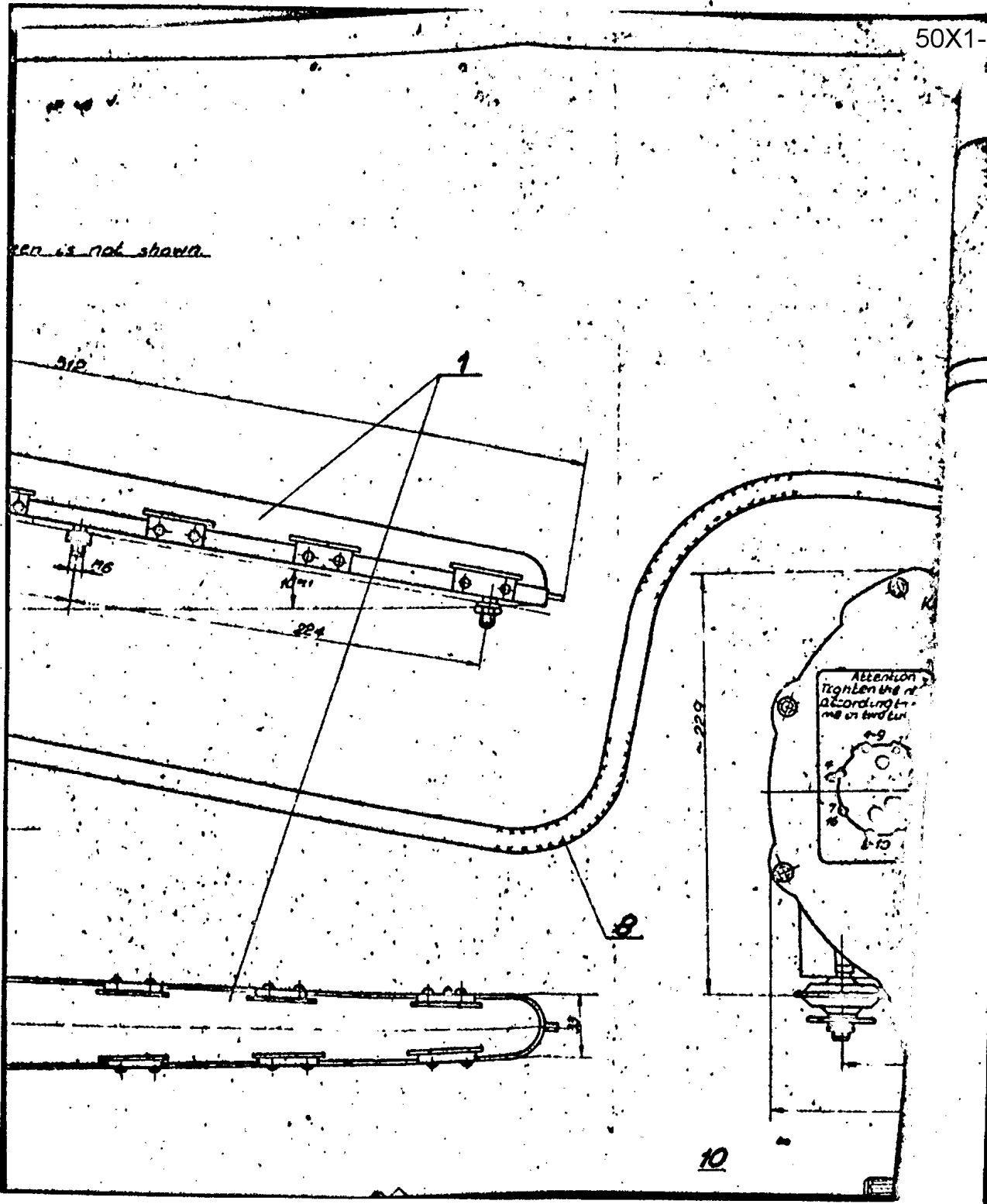

13

10

S-E-C-R-E-T
NO FOREIGN DISSEM

NO FOREIGN DISSEM

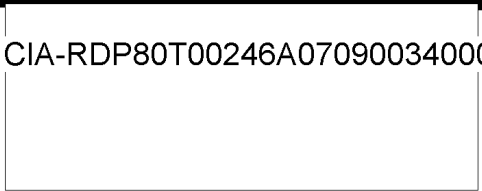

50X1-HUM

aerial screen is not shown

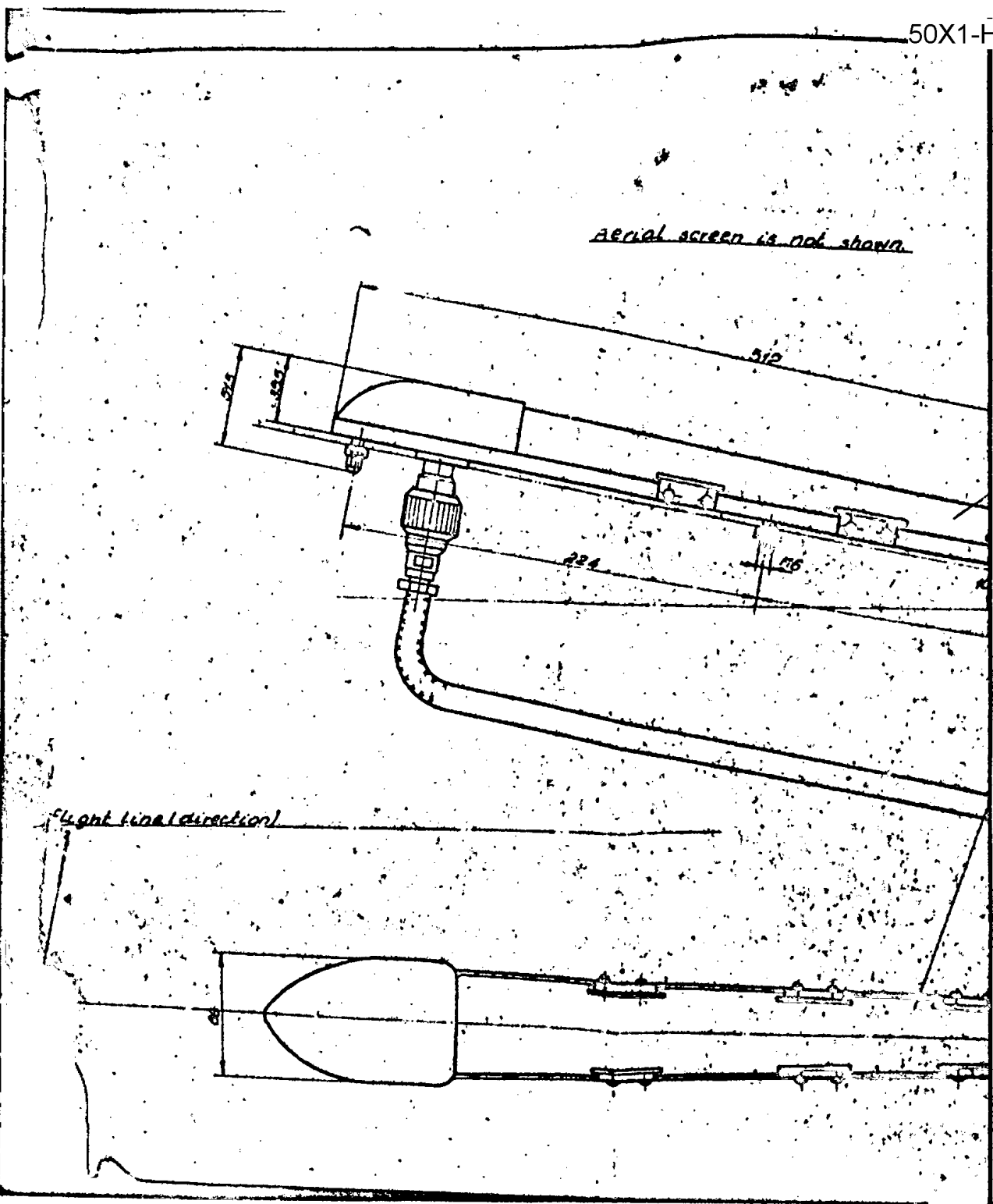

S-E-C-R-E-T
NO FOREIGN DISSEM

NO FOREIGN DISSEM

List of Items

Pos.	GOST, TU fig. Norm.	Name and type	Value	Qty	Remarks
2R-1	OZ0457003TU	Resistor MET-1-33KΩ-II-B	33KΩ	1	
2R-2	GOST5574-50	" SP-II-2b-220A	220KΩ	1	
2R-3	OZ0452003TU	" MET-2-47KΩ-II-B	240KΩ	1	
2R-4	OZ0452003TU	" MET-2-47KΩ-II-B	47KΩ	1	
2R-5	OZ0457003TU	" MET-2-2,2KΩ-II-B	2,2KΩ	1	
2R-6	OZ0457003TU	" MET-2-100Ω-II-B	100Ω	1	
2R-7	OZ0457003TU	" MET-2-52KΩ-II-B	52KΩ	1	
2R-8	GOST5574-50	" SP-II-2b-15A	1,5KΩ	1	
2R-9	OZ0457003TU	" MET-2-100Ω-II-B	100Ω	1	
2R-10	OZ0457003TU	" MET-1-100Ω-II-B	100Ω	1	
2R-11	OZ0457003TU	" MET-2-1KΩ-II-B	1KΩ	1	
2R-12	OZ0457003TU	" MET-2-1MΩ-II-B	1MΩ	1	
2R-13	OZ0457003TU	" MET-2-1MΩ-II-B	1MΩ	1	
2R-14	OZ0457003TU	" MET-2-1MΩ-II-B	1MΩ	1	
2R-15	OZ0457003TU	" MET-2-1MΩ-II-B	1,5MΩ	1	
2R-16	OZ0457003TU	" MET-2-150KΩ-II-B	150KΩ	1	
2R-17	OZ0457003TU	" MET-1-4,3MΩ-II-B	4,3MΩ	1	
2R-18	OZ0457003TU	" MET-1-4,3MΩ-II-B	4,3MΩ	1	
2R-19	OZ0457003TU	" MET-1-4,7KΩ-II-B	4,7MΩ	1	
2R-20	OZ0457003TU	" MET-1-4,7KΩ-II-B	4,7KΩ	1	
2R-21	OZ0457003TU	" MET-1-220Ω-I-B	220Ω	1	
2R-22	OZ0457003TU	" MET-0,5-200Ω-I-A	200Ω	1	
2R-23	OZ0457003TU	" MET-0,5-200Ω-I-A	200Ω	1	
2R-24	OZ0457003TU	" MET-0,5-220Ω-I-A	220Ω	1	
2R-25	OZ0457003TU	" MET-0,5-200Ω-I-A	200Ω	1	
2R-25	OZ0457003TU	" MET-0,5-220Ω-I-A	220Ω	1	
2R-27	OZ0457003TU	" MET-0,5-220Ω-I-A	220Ω	1	

50X1-HUM

S-E-C-R-E-T
NO FOREIGN DISSEM

NO FOREIGN DISSEM

1	2	3	4	5	6
2R-28	OZ0457003TU	Resistor MET-0,5-3K Ω -II-A	3K Ω	1	2.5K Ω when using 24K Ω 5.6K Ω \pm 10%
2R-29	OZ0457003TU	" MET-0,5-3,9K Ω -II-B	3,9K Ω	1	
2R-30	OZ0457003TU	" MET-0,5-300 Ω -II-B	300 Ω	1	
2R-31	OZ0457003TU	" MET-0,5-55K Ω -II-B	56K Ω	1	
2R-32	OZ0467003TU	" MET-0,5-200 Ω -II-B	200 Ω	1	
2R-33	OZ0467003TU	" MET-0,5-1,8K Ω -II-B	1,8K Ω	1	
2R-34	OZ0457003TU	" MET-0,5-1,5K -1,5K Ω -II-B	1,5K	1	
2R-35	OZ0457003TU	" MET-1-100 Ω -II-B	100 Ω	1	
2R-36	OZ0467003TU	" MET-0,5-3,9K Ω -II-B	3,9K Ω	1	
2R-37	OZ0467003TU	" MET-0,5-220K Ω -II-B	220K Ω	1	
2R-38	OZ0457003TU	" MET-0,5-1M Ω -II-B	1M Ω	1	
2R-39	OZ0467003TU	" MET-1,-82K Ω -II-B	82K Ω	1	
2R-40	OZ0467003TU	" MET-0,5-220 Ω -II-B	220 Ω	1	
2R-41	OZ0467003TU	" MET-0,5-12K Ω -II-B	12K Ω	1	
2R-42	OZ0457003TU	" MET-0,5-12K Ω -II-B	12K Ω	1	
2R-43	OZ0467003TU	" MET-0,5-100K Ω -II-B	100K Ω	1	
2R-44	OZ0467003TU	" MET-0,5-100K Ω -II-B	100K Ω	1	
2R-45	OZ0467003TU	" MET-0,5-470K Ω -II-B	470K Ω	1	
2R-46	OZ0467003TU	" MET-0,5-15K Ω -II-B	15K Ω	1	
2R-47	OZ0467003TU	" MET-1-27K Ω -II-B	27K Ω	1	
2R-48	OZ0467003TU	" MET-0,5-30K Ω -II-B	30K Ω	1	
2R-49	OZ0467003TU	" MET-0,5-100K Ω -II-B	100K Ω	1	
2R-50	OZ0467003TU	" MET-0,5-100K Ω -II-B	100K Ω	1	
2R-51	OZ0467003TU	" MET-0,5-100K Ω -II-B	100K Ω	1	
2R-52	OZ0467003TU	" MET-0,5-43K Ω -II-B	43K Ω	1	
2R-53	GOST5574-50	" SP-II-2b-33A	33K Ω	1	
2R-54	OZ0467003TU	" MET-1-33K Ω -II-B	30K Ω	1	

31

S-E-C-R-E-T

NO FOREIGN DISSEM

NO FOREIGN DISSEM

1	2	3	4	5	6
2R-55	OZ0467003TU	Resistor MLT-1-33K Ω -II-B	33K Ω	1	50X1-HUM
2R-56	OZ0467007TU	" MLT-0,5-470K Ω -II-B	470K Ω	1	
2R-57	OZ0467003TU	" MLT-0,5-220K Ω -II-B	220K Ω	1	
2R-58	OZ0467003TU	" MLT-0,5-300 Ω -II-B	300 Ω	1	
2R-59	GJ7714-001	" 50 Ω \pm 10%	50 Ω	1	
2R-60	OZ0467003TU	" MLT-2-300 Ω -II	300 Ω	1	
2R-61	OZ0467003TU	" MLT-1-3,2K Ω -II	3,2K Ω	1	\pm 15K
2R-62	OZ0467003TU	" MLT-0,5-200K Ω -I-B	200K Ω	1	
2R-63	OZ0467003TU	" MLT-0,5-47K Ω -II-B	47K Ω	1	
2R-64	OZ0467003TU	" MLT-0,5-43K Ω -II	43K Ω	1	
2R-65	OZ0467003TU	" MLT-2-100 Ω -II	100 Ω	1	
2C-1	GOST6119-54	Condenser KSC-2-50CG-1000-I	1000pF	1	
2C-2	GOST6118-52	" KBO-J-600-25000	25000pF	1	
2C-3	GOST6119-54	" KSO-8-2-500-B-2000-I	2000pF	1	
2C-4	GOST5629-51	" KBGP-2-20,25-II	0,25 μ F	1	
2C-5	GOST6119-54	" KSO-8-500-B-30000-II	30000pF	1	
2C-6	GOST6119-54	" KSO-8-1500-B-6800-II	6800pF	1	
2C-7	GOST6119-54	" KSO-8-1500-B-6800-II	6800pF	1	
2C-8	GOST6119-54	" KSO-8-1500-B-6800-II	6800pF	1	
2C-9	GOST6119-54	" KSO-5-250-B-10000-II	10000pF	1	
2C-10	GOST6119-54	" KSO-2-500-G-1000-I	1000pF	1	
2C-11	GOST6119-54	" KSO-2-500-G-1000-I	1000pF	1	
2C-12	GOST6119-54	" KSO-2-500-G-1000-I	1000pF	1	
2C-13	GOST6119-54	" KSO-2-500-G-1000-I	1000pF	1	
2C-14	GOST6119-54	" KSO-2-500-G-1000-I	1000pF	1	
2C-15	GOST6119-54	" KSO-2-500-G-1000-I	1000pF	1	
2C-16	GOST6119-54	" KSO-2-500-G-1000-I	1000pF	1	
2C-17	GOST6119-54	" KSO-2-500-G-1000-I	1000pF	1	

32

S-E-C-R-E-T

NO FOREIGN DISSEM

NO FOREIGN DISSEM

50X1-HUM

1	2	3	4	5	6
2C-18	GOST6119-54	Condenser KSO-2-500-G-1000-I	1000pF	1	
2C-19	GOST6119-54	" KSO-2-500-G-1000-I	1000pF	1	
2C-20	GOST6119-54	" KSO-2-500-G-1000-I	1000pF	1	
2C-21	GOST6119-54	" KSO-2-500-G-1000-I	1000pF	1	
2C-22	GOST6119-54	" KSO-2-500-G-1000-I	1000pF	1	
2C-23	GOST6119-54	" KSO-2-500-G-1000-I	1000pF	1	
2C-24	GOST6119-54	" KSO-5-250-B-10000-II	10000pF	1	
2C-25	GOST6119-54	" KSO-1-250-B-1000pF-II	100pF	1	
2C-26	GOST6119-54	" KSO-2-500-B-1000-II	1000pF	1	
2C-27	GOST6119-54	" KSO-2-500-B-1000-II	1000pF	1	
2C-28	GOST6119-54	" KSO-2-500-B-1000-II	1000pF	1	
2C-29	GOST6119-54	" KSO-2-500-B-1000-II	1000pF	1	
2C-30	GOST6119-54	" KSO-2-500-B-1000-II	1000pF	1	
2C-31	GOST6119-54	" KSO-2-500-B-1000-II	1000pF	1	
2C-32	GOST6119-54	" KSO-5-500-B-2200-II	2200pF	1	
2C-33	GOST6119-54	" KSO-1-250-B-100-II	100pF	1	
2C-34	GOST6119-54	" KSO-2-500-B-1000-II	1000pF	1	
2C-35	GOST6119-54	" KSO-2-500-B-1000-II	1000pF	1	
2C-36	GOST6119-54	" KSO-1-250-B-220-II	220pF	1	
2C-37	GOST6119-54	" KSO-2-500-B-1000-II	1000pF	1	
2C-38	GOST7159-54	" KTK-1-N-4-II	4pF	1	
2C-39	GOST7159-54	" KTK-1-M-10-II	10pF	1	
2C-40	OZ0462008TU	" MBGP-1-200-2x0,25-II	0,25pF	1	
2C-41	GOST6119-54	" KSO-1-250-B-100-II	100pF	1	
2C-42	GOST6119-54	" KSO-1-250-B-100-II	100pF	1	
2C-43	GOST6119-54	" KSO-5-250-B-10000-II	10000pF	1	
2C-44	OZ0462008TU	" MBGP-1-200-2x0,25-II	0,25pF	1	
2C-45	GOST6119-54	" KSO-5-500-B-5500-II	5500pF	1	

33

S-E-C-R-E-T

NO FOREIGN DISSEM

NO FOREIGN DISSEM

50X1-HUM

1	2	3	4	5	6
2C-46	GOST7159-54	Condenser KTK-1-K-10-II	10pF	1	
2C-47	GOST5119-54	" KDC-5-500-5100-II	5100pF	1	
2C-48	OZ0452003TU	" MBGP-1-200-2x0,5-II	2x0,5uF	1	
2C-49	OZ0452CC3TU	" MBGP-1-200-2x0,5-II	2x0,5uF	1	
2C-50	GOST6119-54	" KSO-2-500-G-1000-II	1000pF	1	
2C-51	GOST5119-54	" KSO-2-500-W-1000-II	1000pF	1	
2C-52	GOST5119-54	" KSO-5-2500-10000-II	10000pF	1	
		IRM-2-2-z 0,5			
2L-1	TU5/240KB194MAP	Choke 1	150uH	1	
	TU-21359				
2L-2	TUJ-7/41NJJ-17	" D-0,1	10uH	1	
	GJ4778003Sp				
2L-3	TU5/470KB794-MAP	Circuit coil.	1uH	1	
	TU-21359				
2L-4	TU-U7/41NJJ-17	Choke D-0,1	20uH	1	
	TU-21359				
2L-5	GJ4777003Sp	Choke D-1,2-5uH ± 10%	5uH	1	
2L-6	GJ4777003Sp	Choke D-1,2-5uH ± 10%	5uH	1	
2L-7	TU-U7/41NJJ-17	" D-0,1-5uH ± 10%	10uH	1	
	TU-21359				
2L-8	GJ4777003Sp	" D-1,2 - 5 uH ± 10%	5uH	1	
2L-9	TU5/170KB794-MAP	Circuit coil	1,1uH	1	
	TU-21359				
2L-10	GJ4777003Sp	Choke D-1,2-5uH ± 10%	5uH	1	

S-E-C-R-E-T

NO FOREIGN DISSEM

NO FOREIGN DISSEM

1	2	3	4	5	6
2L-11	GJ4778001-p	Circuit coil	3,0 μ H	1	
2L-12	SP13-2-1-212	Coil 1,2 μ	1,2 μ H	1	
2L-13	GJ4778001A	Coil 1,2 μ	2,2 μ H	1	
2L-14	GJ4778002A	Coil 1,2 μ	2,2 μ H	1	
2L-15	GJ4778003A	Coil 1,2 μ	3,5 μ H	1	
	1R1-2-2-212				
2L-16	CzTU-230	Choke D-0,1	2,3 μ H	1	
	TU-21359				
2L-17	TU-U7/4YJJ-17	Choke D-1,2	5 μ H	1	
	1R1-2-2-2-11				
2L-18	CzTU-230	Choke D-0,1	4,8 μ H	1	
2V-1	CzTU01-12054a	Valve 6N3P		1	
2V-2	CzTU1031155	" 6X1-1-35/3		1	
2V-3	CzTU0655554	" 6X1-120		1	
2V-4	CzTU0910252	" K-12		1	
2V-5	CzTU1240152	" 6R-5		1	
2V-6	TE3341000TV	" TH-2		1	
2V-7	CzTU1240252	" 21-0,03/13		1	
2V-8	CzTU0111653	" 6Z3P		1	
2V-9	CzTU0111653	" 6Z3P		1	
2V-10	CzTU0111653	" 6Z3P		1	
2V-11	CzTU0110353	" 6Z1P		1	
2V-12	CzTU0110353	" 6Z1P		1	
2V-13	CzTU0110853	" 6H2P		1	
2V-14	CzTU0110553	" 6H1P		1	

35

S-E-C-R-E-T

NO FOREIGN DISSEM

50X1-HUM

1	2	3	4	5	6
2V-15	CZTUC110553	VALVE 3V2P		1	
2V-15	CZTUC110553	" 6V1P		1	
2Dr-1	GJ4750002Sp	Loading choke	20H±20%	1	2RM-2-4 000
2Dr-3	GJ6139C05	Coil with stand	75μH	1	2RM-2-0 mont.20
2D-4	GI777003Sp	Choke 1,2A-5μH±10%	5μH	1	
2Dr-5	GI777003Sp	" 1,2A-5μH±10%	5μH	1	
2Dr-6	GI777003Sp	" 1,2A-5μH±10%	5μH	1	
2Dr-7	GI777003Sp	" 1,2A-5μH±10%	5μH	1	
2Dr-8	GI777003Sp	" 1,2A-5μH±10%	5μH	1	
2LF-1	GJ2065001Sp	Forming line		1	2RM-2-3 000
2Tr-1	GJ4715002Sp	HT. transformer		1	2RM-2-7 000
2Tr-2	GJ4710001Sp	Filament transformer		1	2RM-2-6 000
2Tr-3	GJ4716001Sp	Ignition transformer		1	2RM-2-5 000
2Tr-4	TI-0779	Pulse transformer		1	
2Tr-5	GJ4720001Sp	" "		1	2RM-2-2 000
2Tr-6	TI-9575 ow.	" "		1	
2PD-1	GJ4851001Sp	Heater		1	
2T-1	1RM-2.21.000	Thermoregulator		1	
2P-1	TI-2765	Plug switch		1	
2K-1	TU-6753	Blocking switch KW-6A		1	
2D-1	CzTU0410952	X-tal detector DG-S2		1	
2D-2	CzTU0410952	" " DG-S2		1	
2SR-1	GJ8505196	7-pin plug			2RM-2-0

S-E-C-R-E-T
 NO FOREIGN DISSEM

NO FOREIGN DISSEM

1	2	3	4	5	6
2SzR-2	LR-5/sb01	7-pin socket		1	
2SzR-3	GJ550519	11-pin plug		1	PRM-2-1 mont.07
2SzR-4	GJ5504101	11-pin socket		1	PRM-2-13 mont.01
2SzR-5	TU119	Plug SzRG40U16ESz2		1	
K2Kab2	GJ4850008Sp	HF Cable No.2		1	PRM-7-10 000
Kab2a.	GJ4850009Sp	HF cable No.2a		1	PRM-7-11 000
Kab3	GJ4850007Sp	HF cable		1	PRM-7-6 000
2M-1	TUZak.2359	Ventilator with motor 2D-7		1	alt rev.
	WTU CzESEP	Magnets MR-394		2	
	OAA585138.57				

50X1-HUM

37

S-E-C-R-E-T

NO FOREIGN DISSEM

50X1-HUM

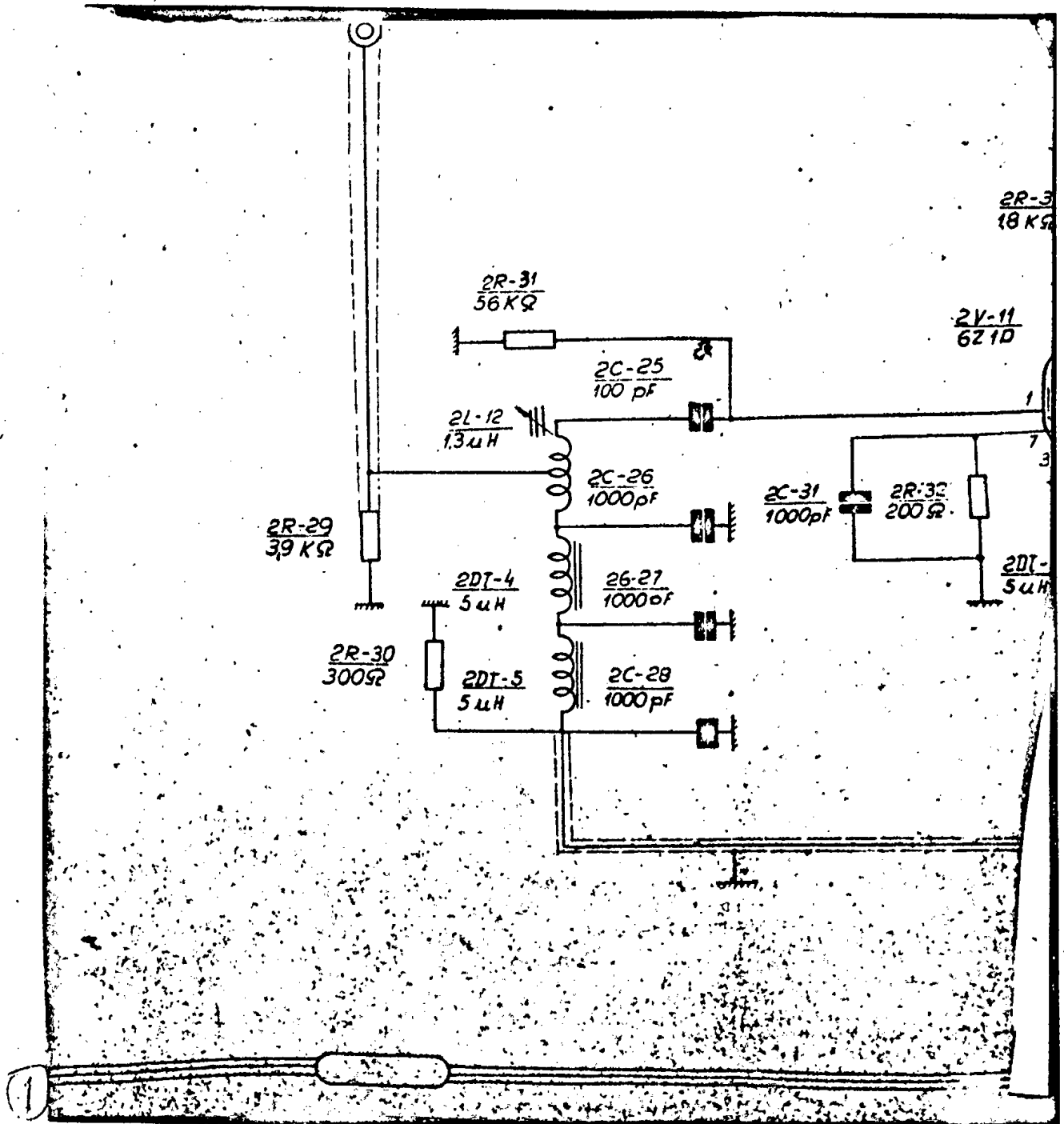

S-E-C-R-E-T
NO FOREIGN DISSEM

NO FOREIGN DISSEM

50X1-HUM

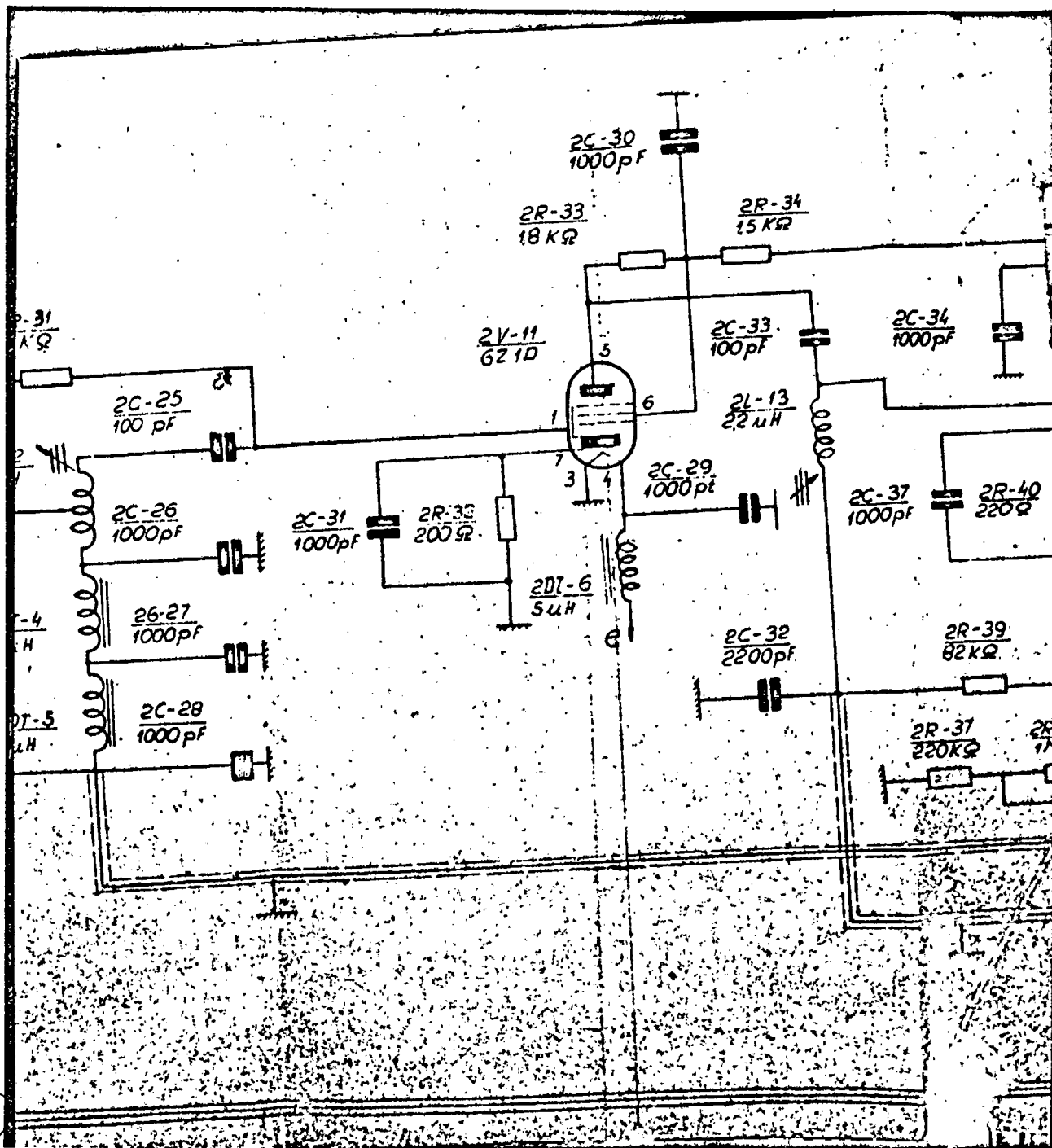

2

S-E-C-R-E-T
NO FOREIGN DISSEM

NO FOREIGN DISSEM

50X1-HUM

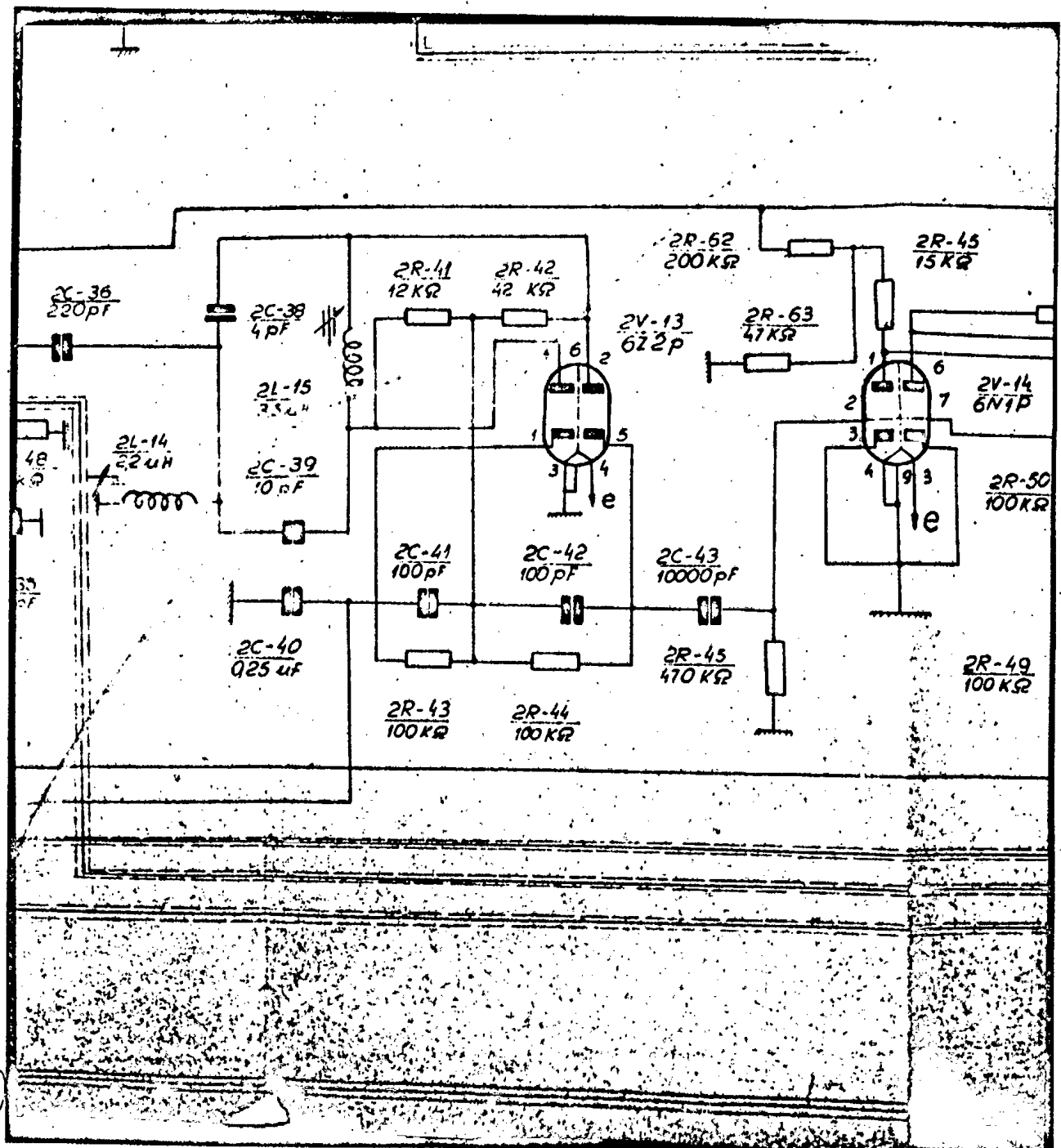

S-E-C-R-E-T

NO FOREIGN DISSEM

NO FOREIGN DISSEM

50X1-HUM

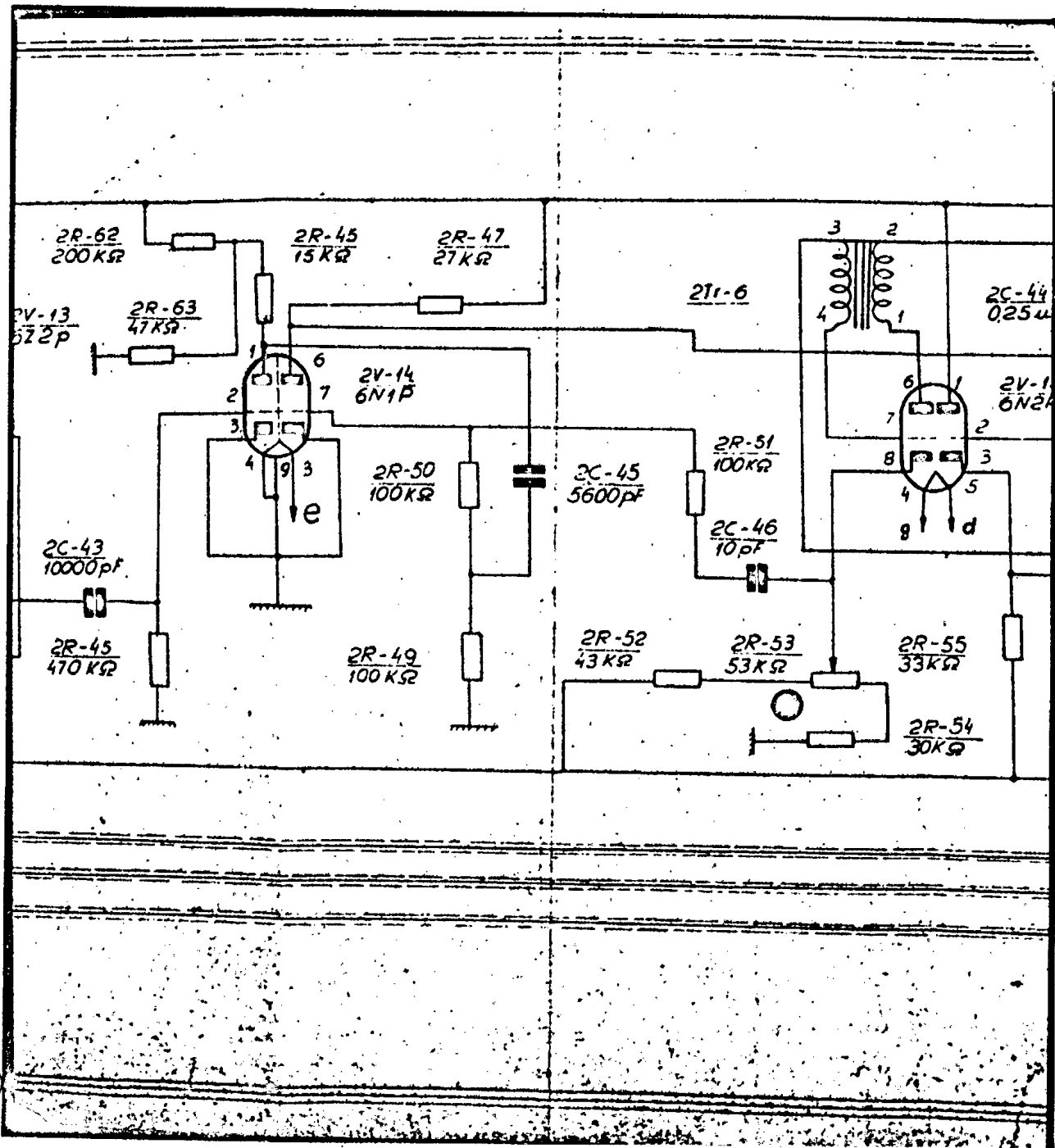

5

S-E-C-R-E-T

NO FOREIGN DISSEM

NO FOREIGN DISSEM

50X1-HUM

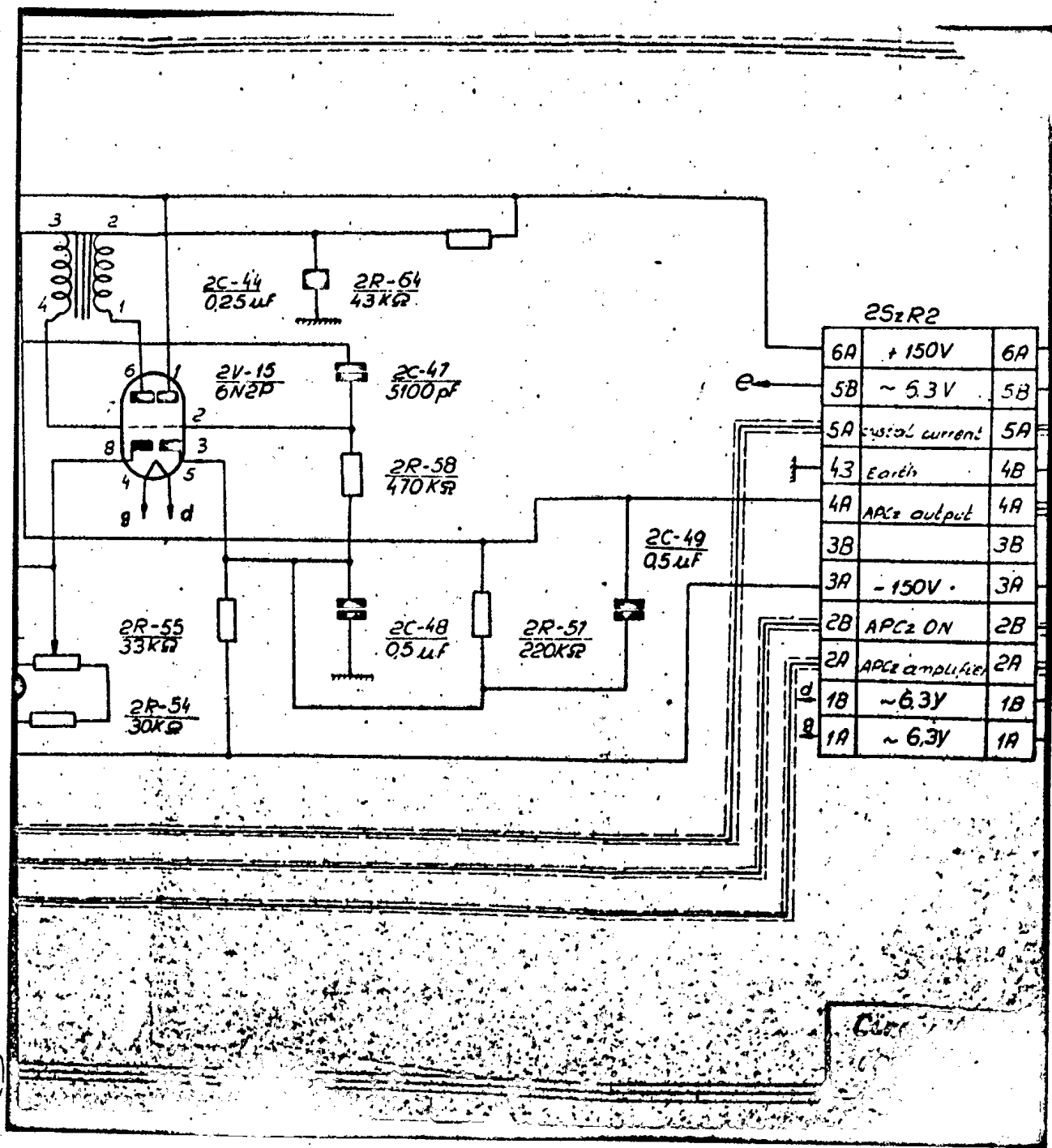

25zR2		
6A	+ 150V	6A
5B	~ 5.3V	5B
5A	control current	5A
4B	Earth	4B
4A	APC2 output	4A
3B		3B
3A	- 150V	3A
2B	APC2 ON	2B
2A	APC2 amplifier	2A
1B	~ 6.3V	1B
1A	~ 6.3V	1A

S-E-C-R-E-T

NO FOREIGN DISSEM

S-E-C-R-E-T
NO FOREIGN DISSEM

50X1-HUM

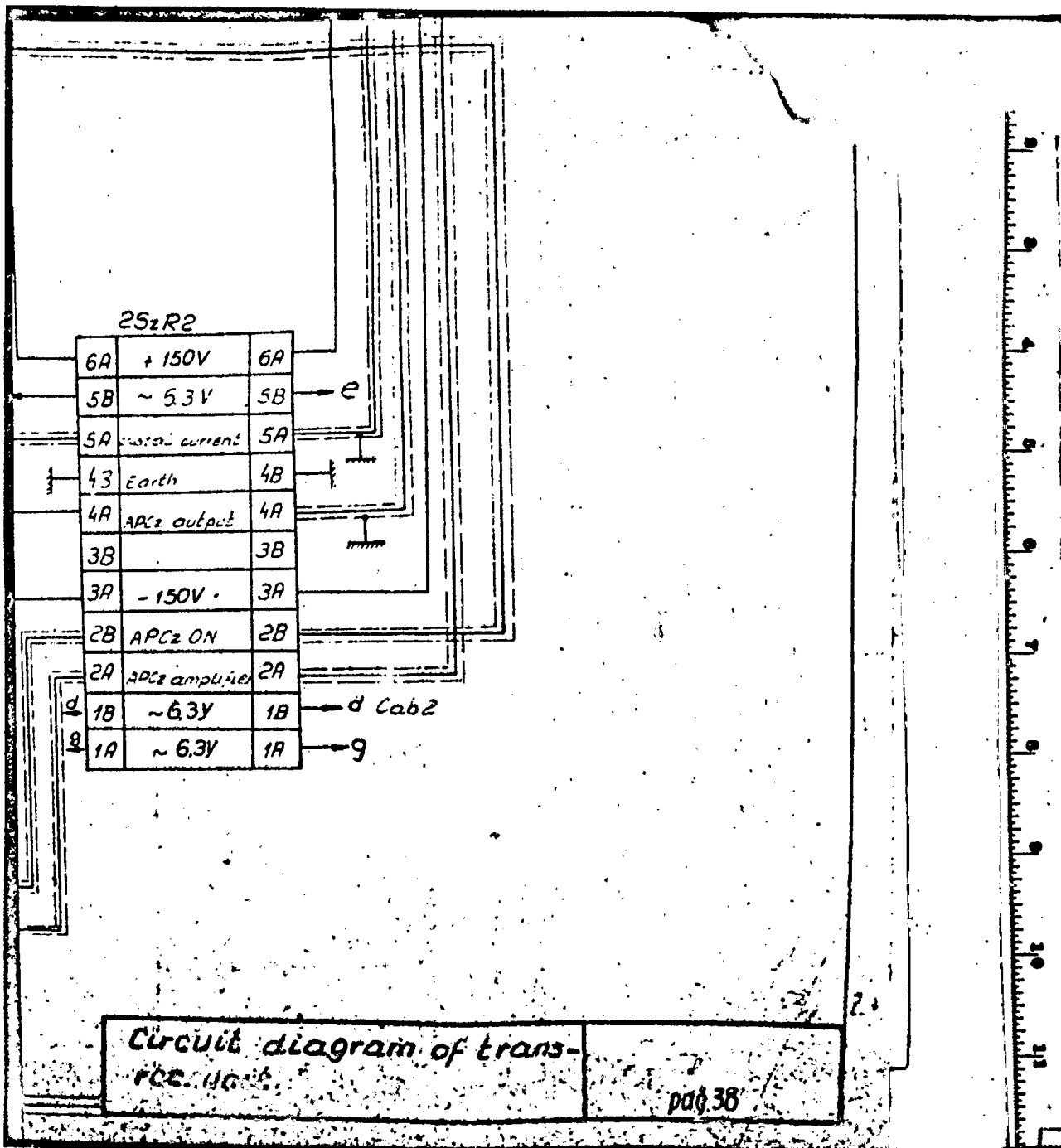

S-E-C-R-E-T
NO FOREIGN DISSEM

NO FOREIGN DISSEM

50X1-HUM

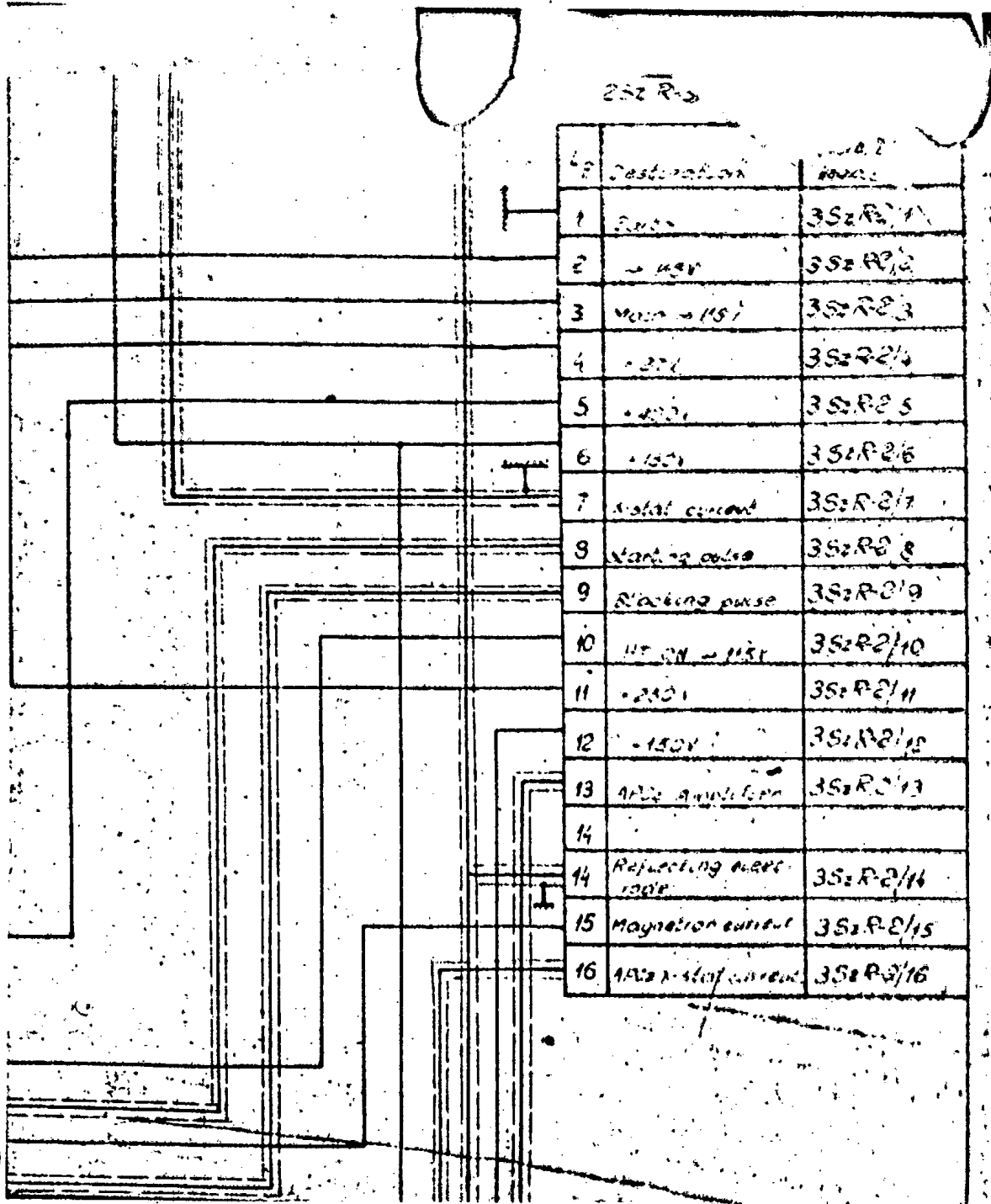

S-E-C-R-E-T

NO FOREIGN DISSEM

50X1-HUM

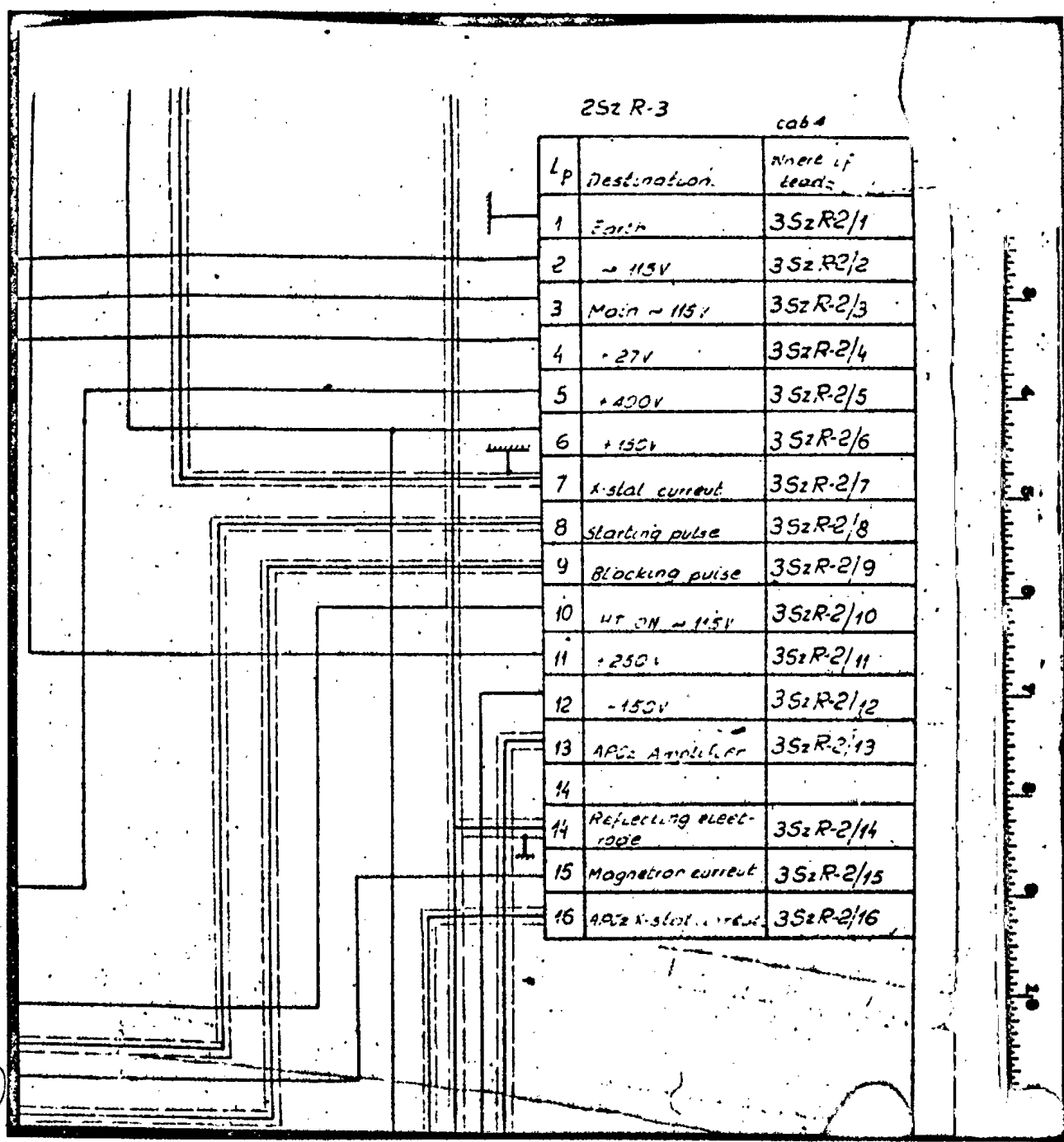

(S-E-C-R-E-T)
 (NO FOREIGN DISSEM)

S-E-C-R-E-T
NO FOREIGN DISSEM

50X1-HUM

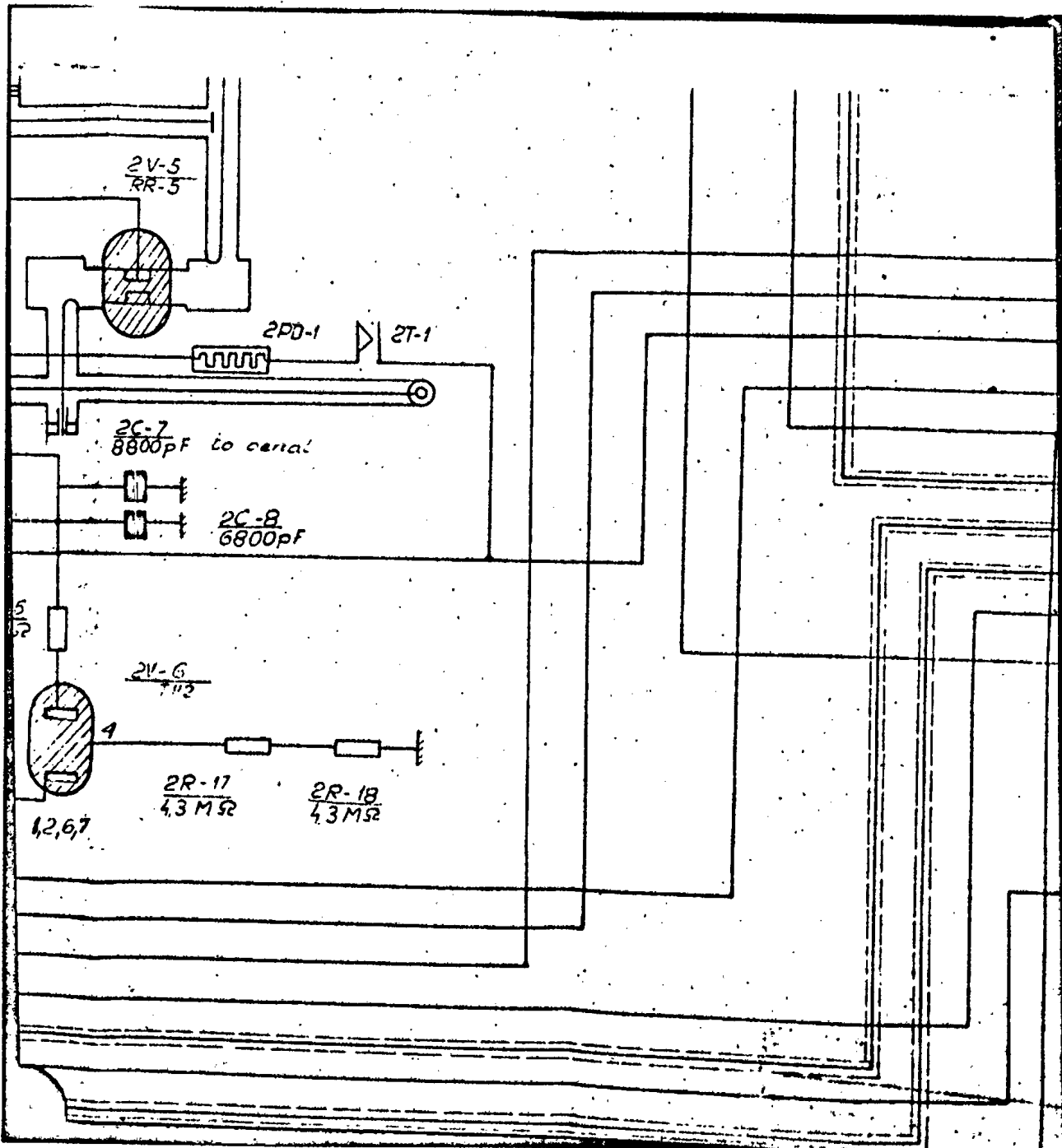

S-E-C-R-E-T
NO FOREIGN DISSEM

NO FOREIGN DISSEM

50X1-HUM

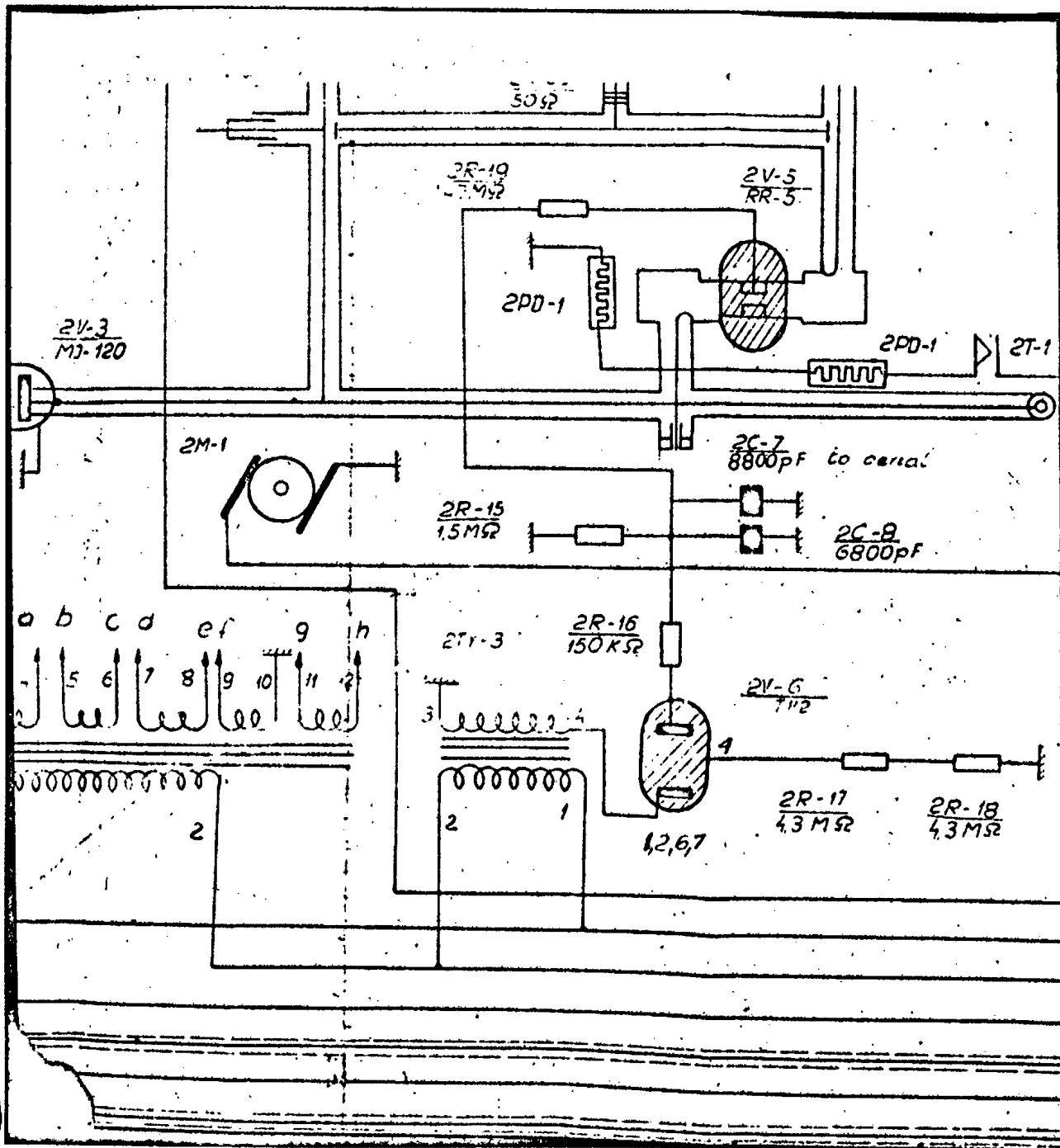

S-E-C-R-E-T

NO FOREIGN DISSEM

50X1-HUM

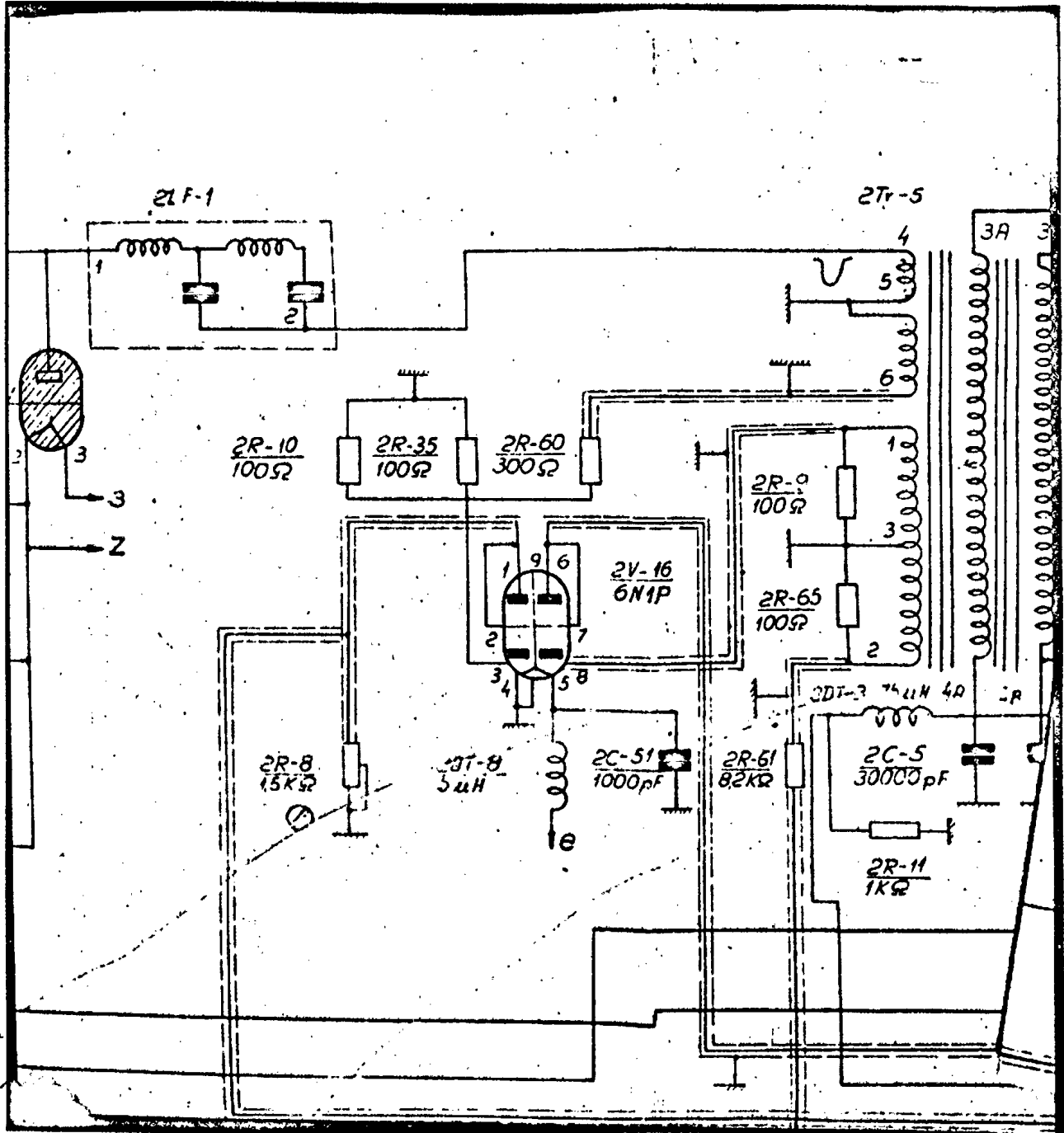

S-E-C-R-E-T
NO FOREIGN DISSEM

50X1-HUM

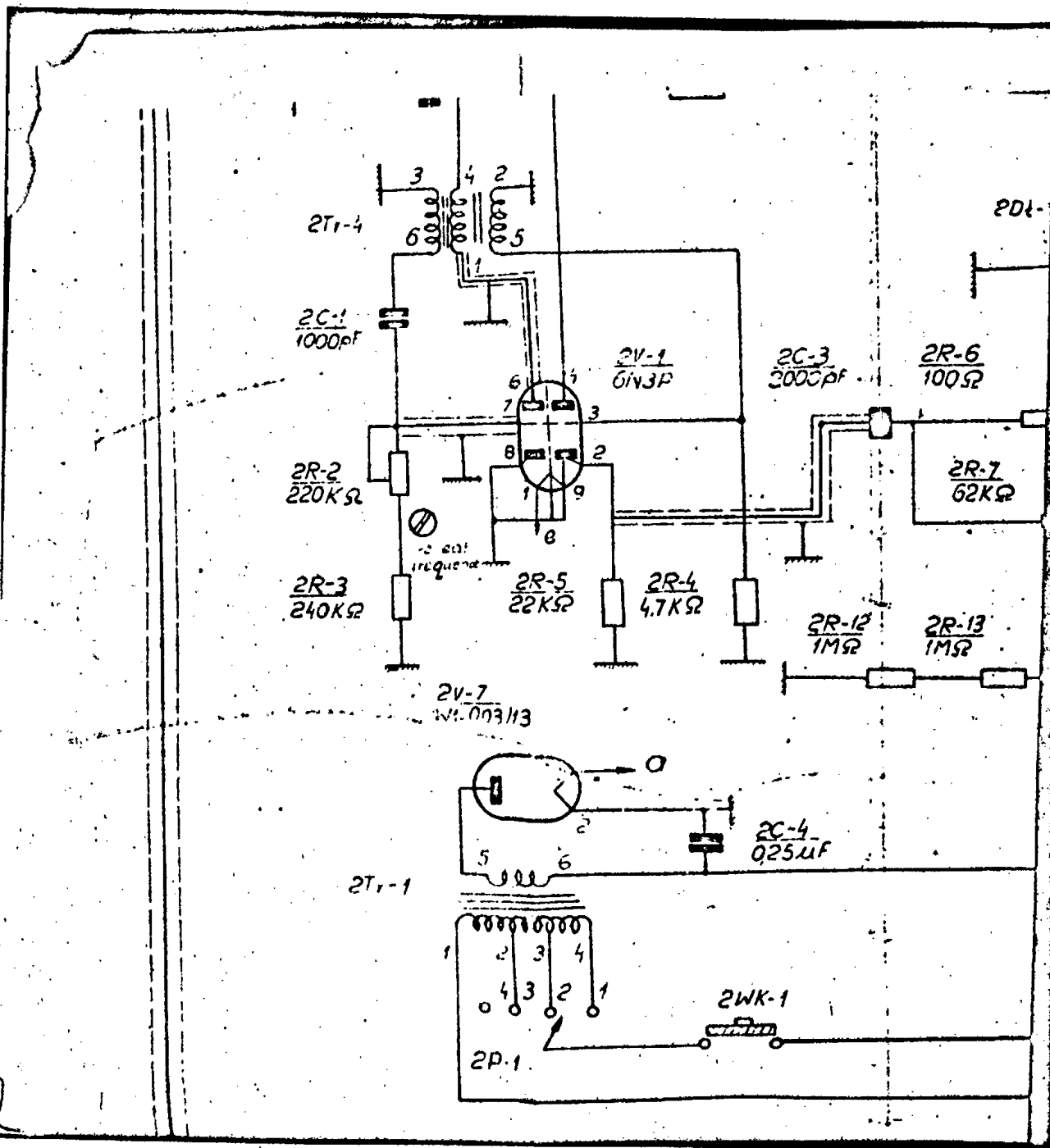

S-E-C-R-E-T
NO FOREIGN DISSEM

50X1-HUM

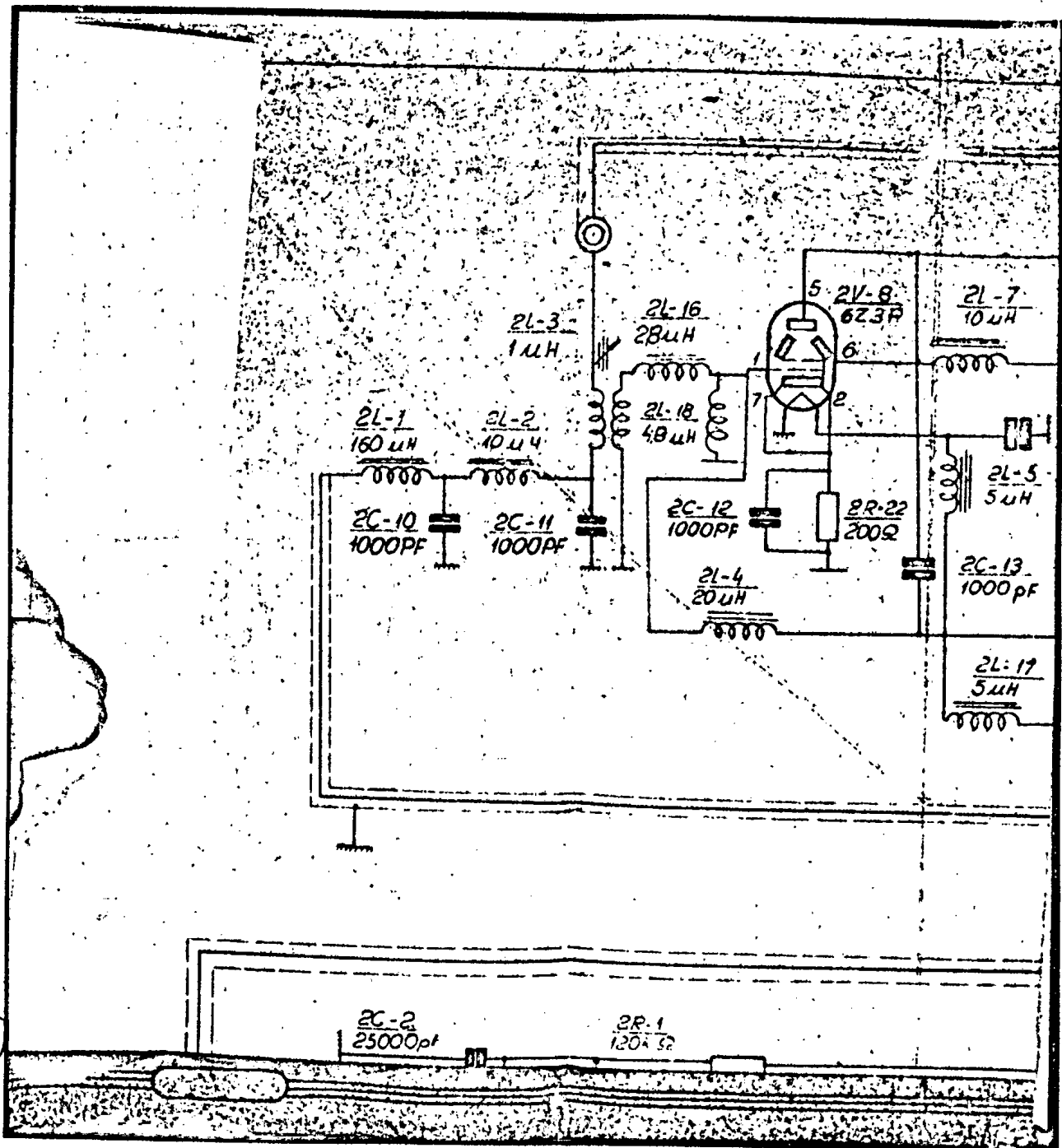

S-E-C-R-E-T
NO FOREIGN DISSEM

50X1-HUM

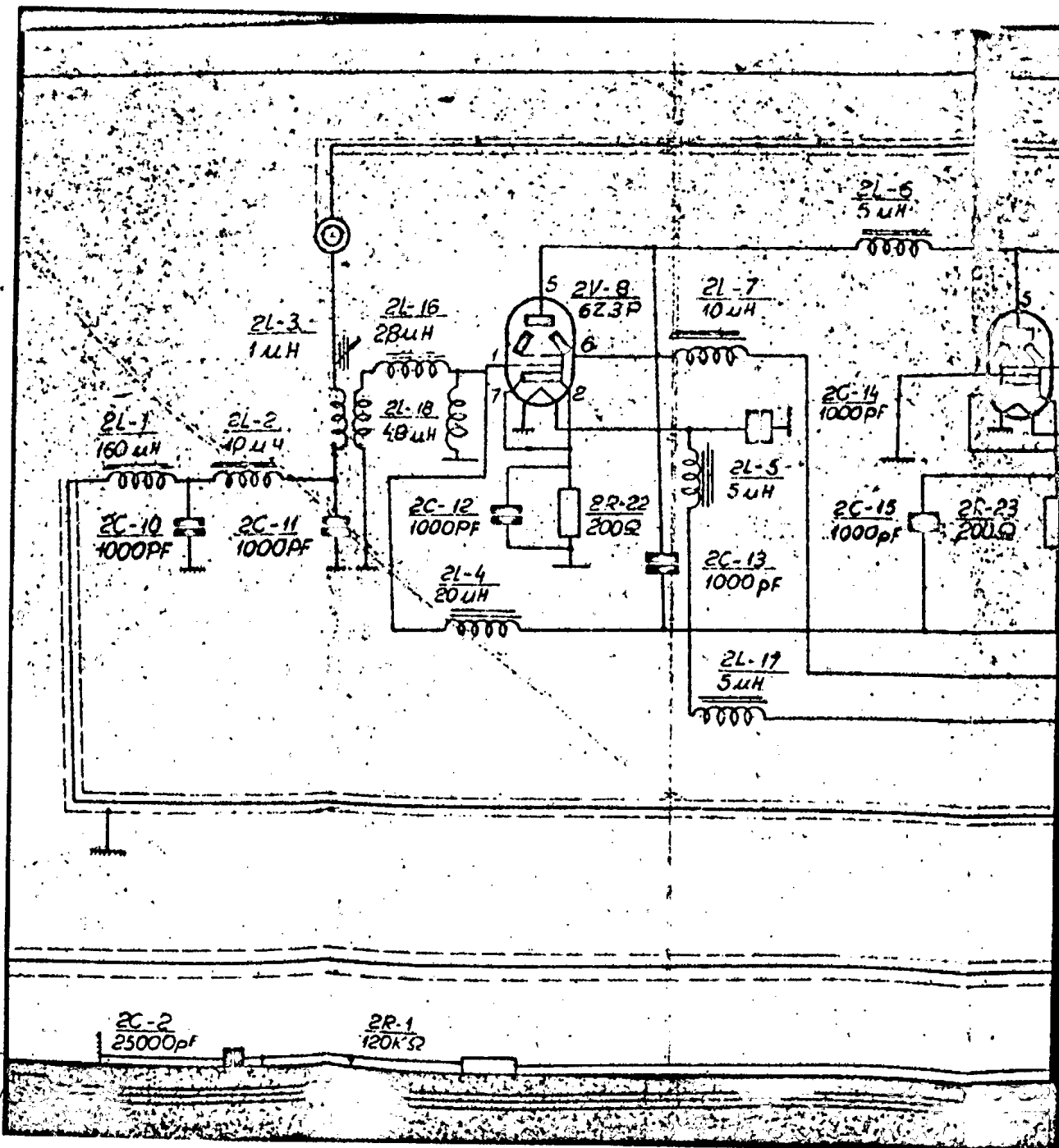

S-E-C-R-E-T
NO FOREIGN DISSEM

NO FOREIGN DISSEM

50X1-HUM

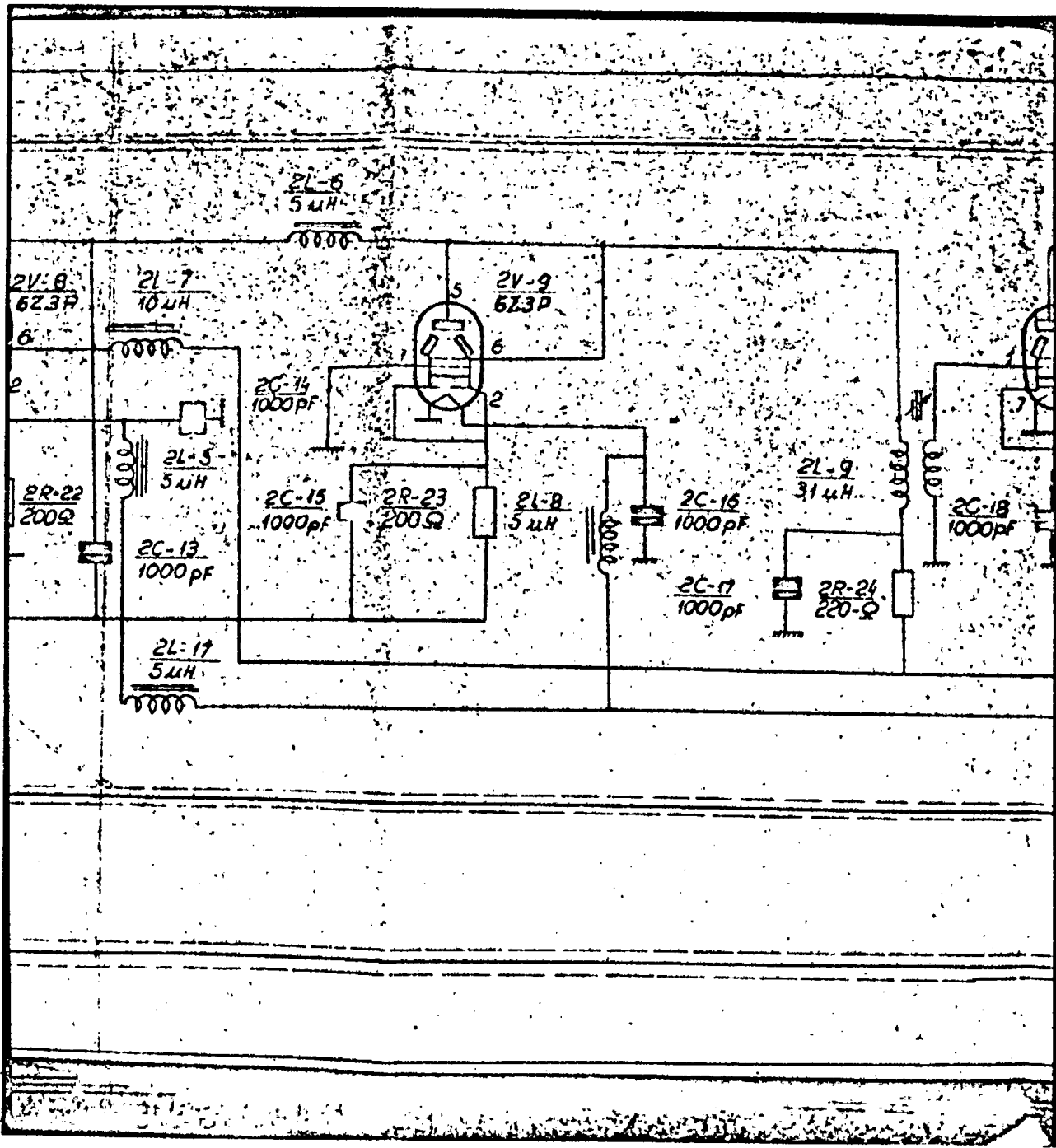

116

S-E-C-R-E-T

NO FOREIGN DISSEM

50X1-HUM

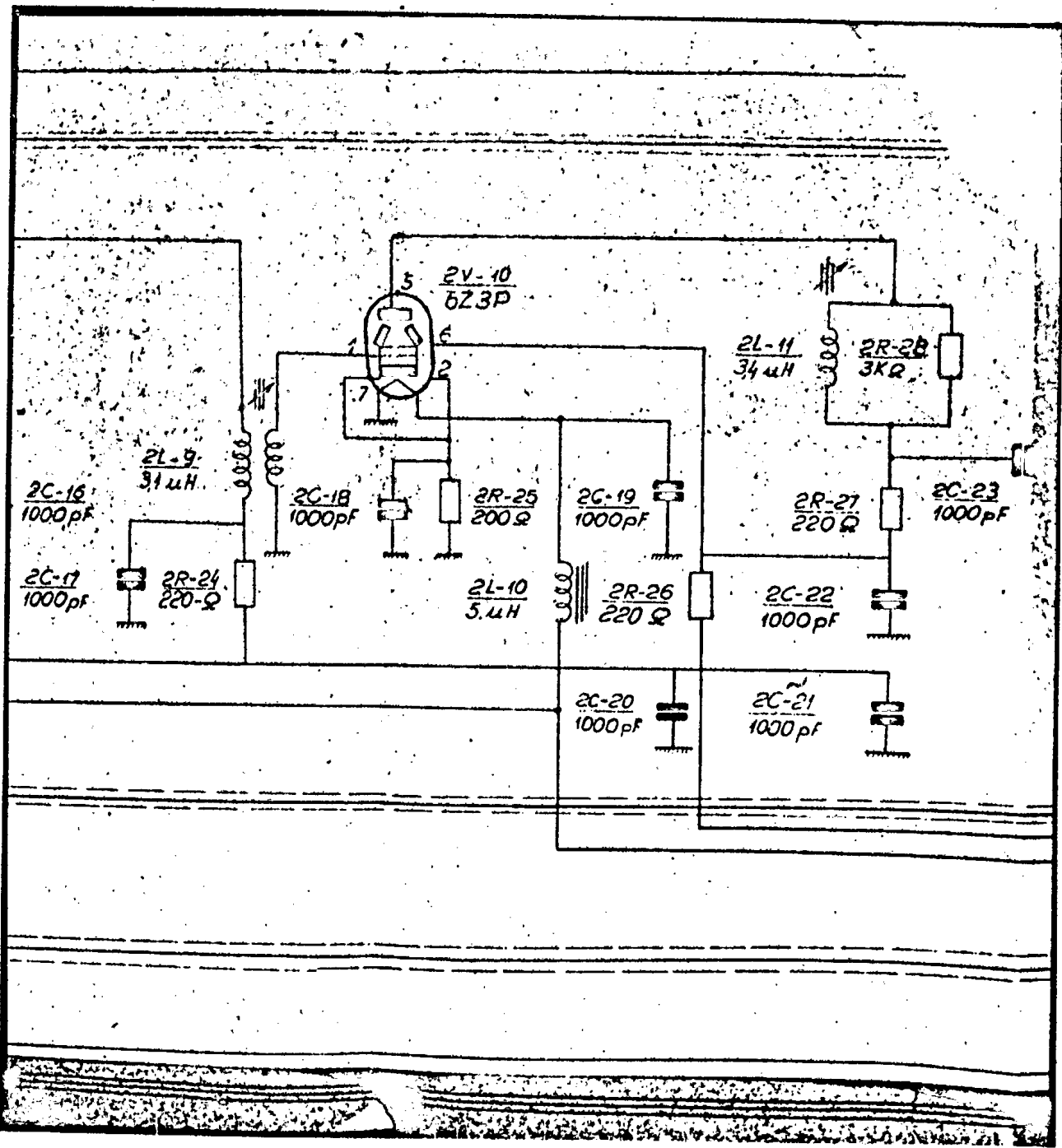

S-E-C-R-E-T
NO FOREIGN DISSEM

NO FOREIGN DISSEM

50X1-HUM

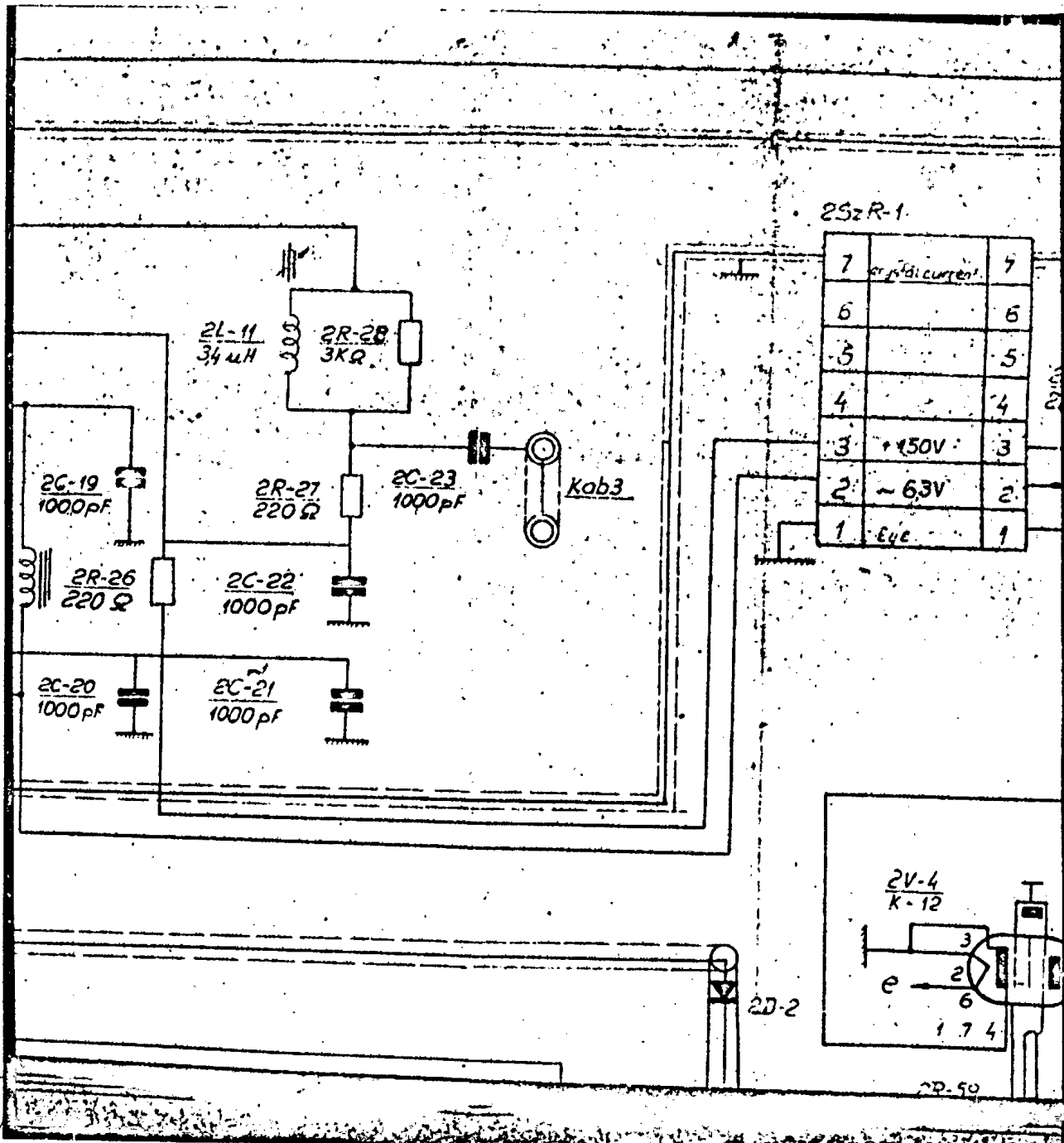

S-E-C-R-E-T

NO FOREIGN DISSEM

NO FOREIGN DISSEM

50X1-HUM

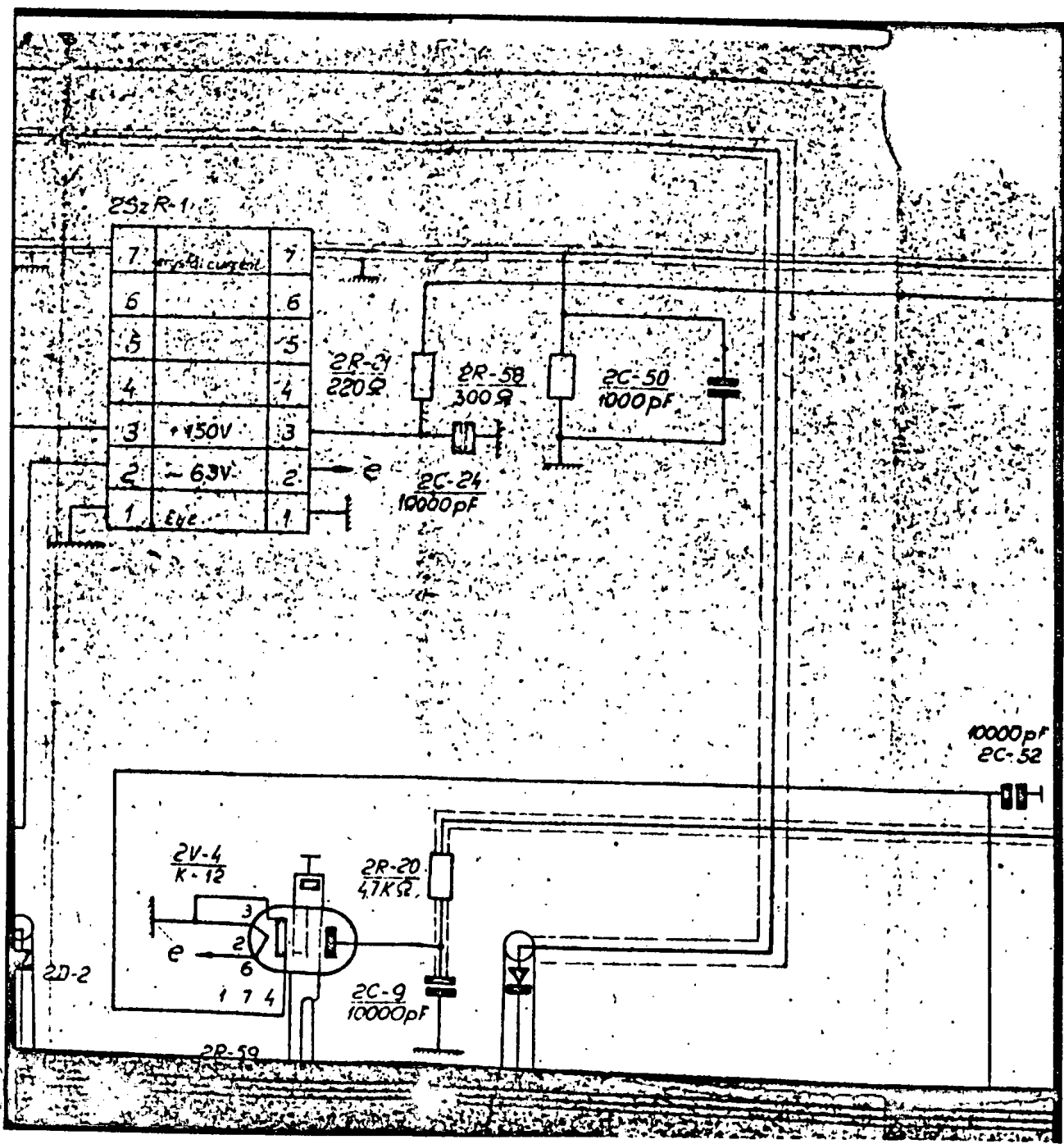

S-E-C-R-E-T
NO FOREIGN DISSEM

50X1-HUM

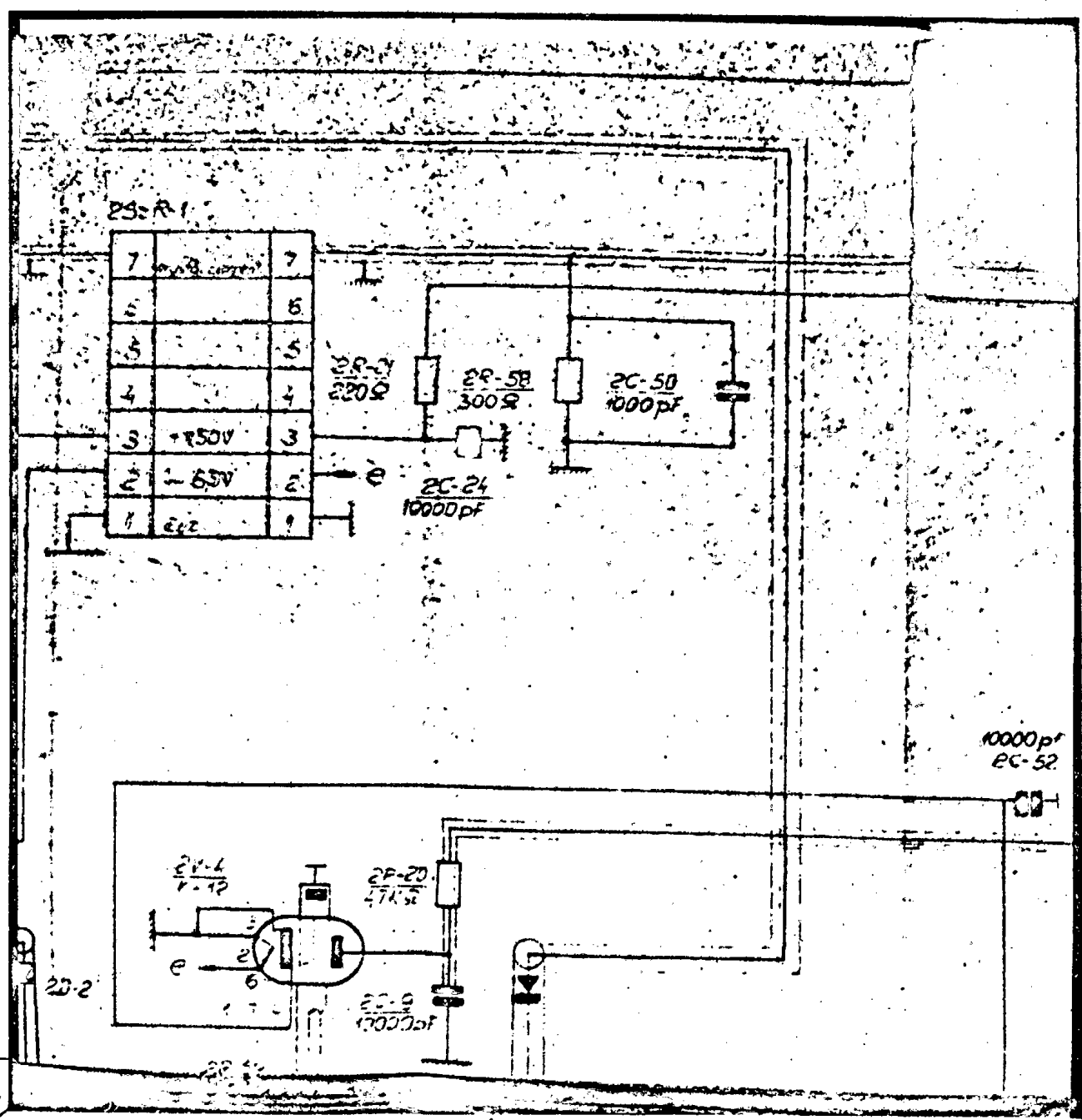

S-E-C-R-E-T
(NO FOREIGN DISSEM)

50X1-HUM

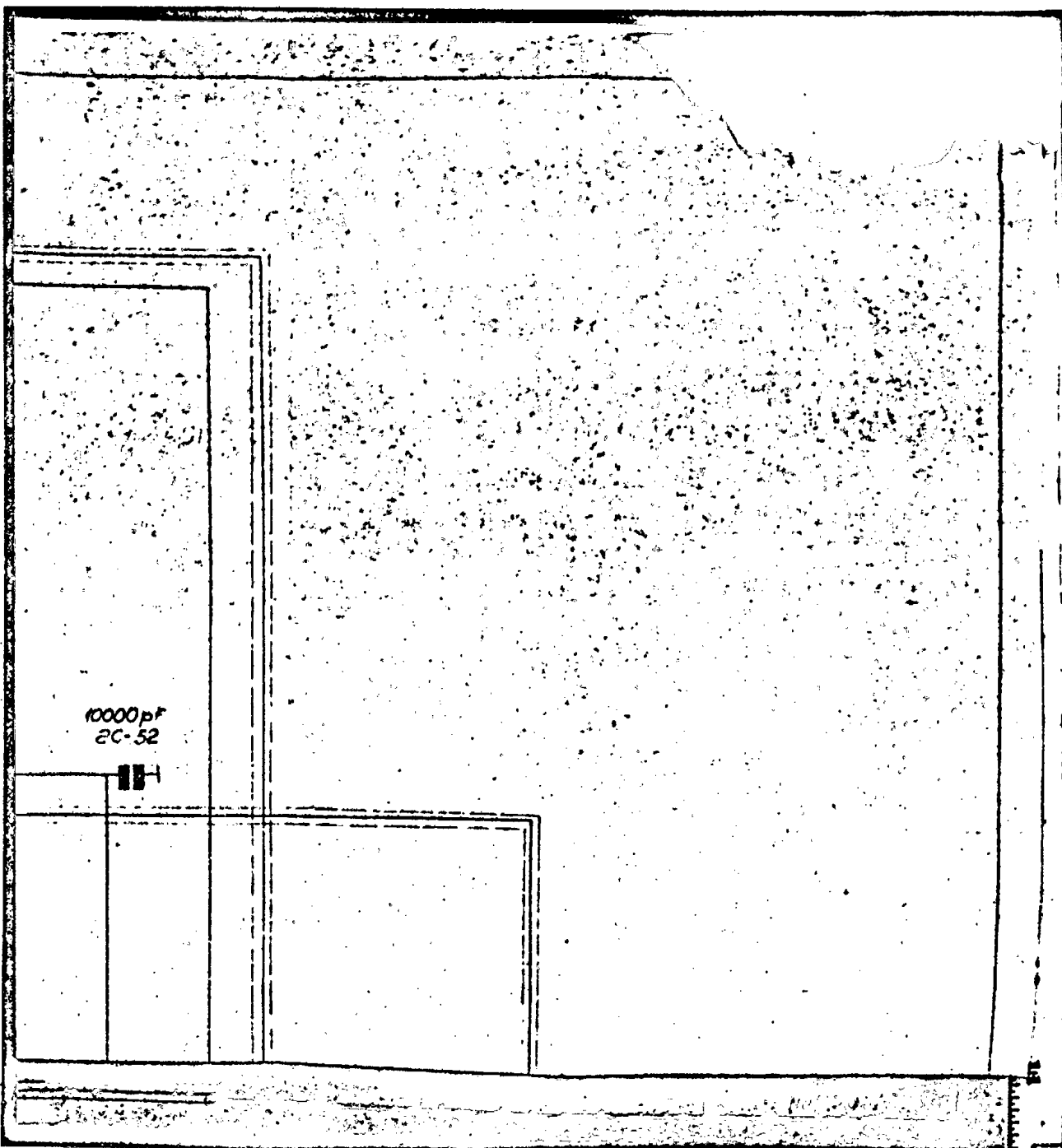

25

S-E-C-R-E-T
NO FOREIGN DISSEM

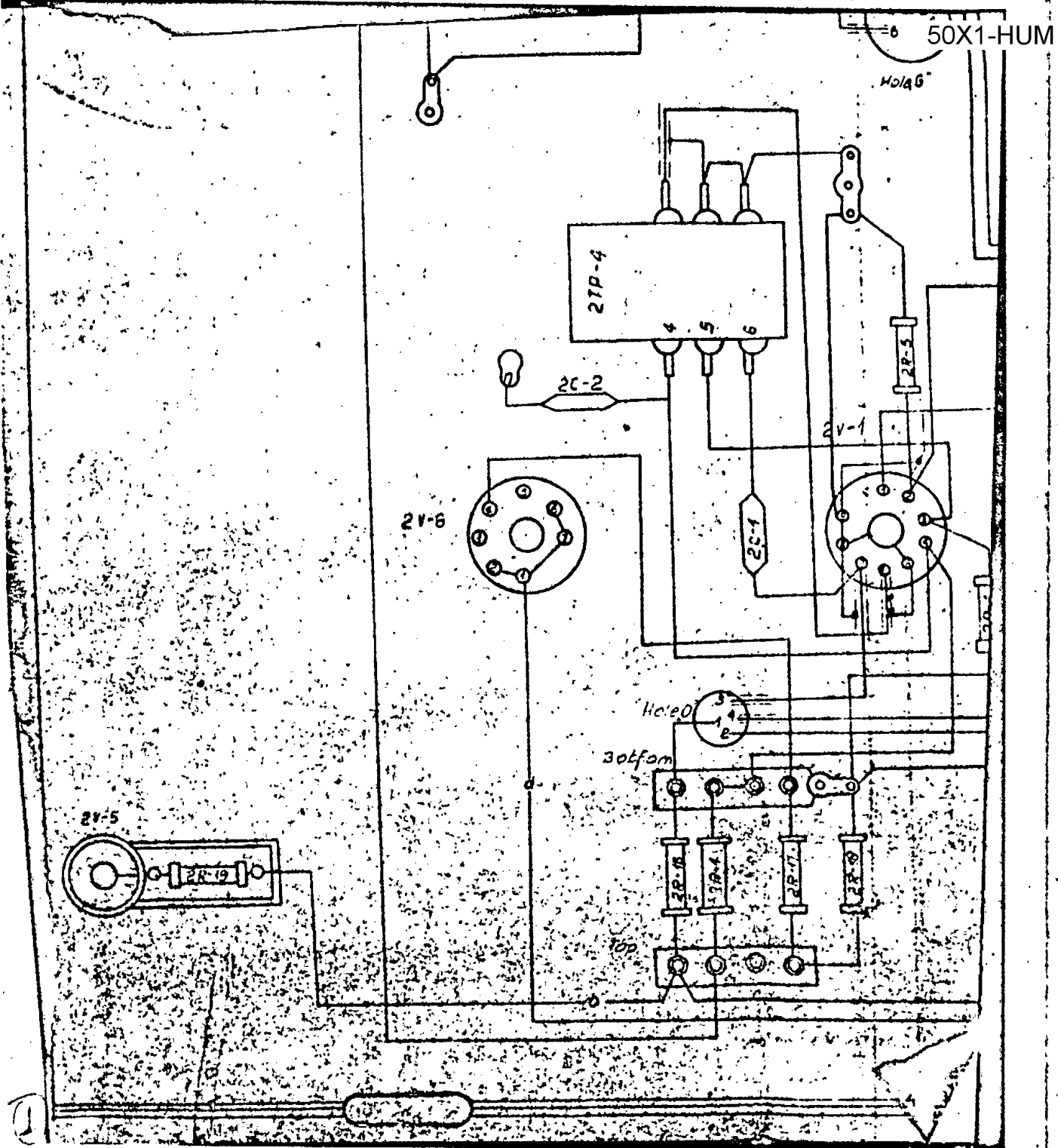

S-E-C-R-E-T
NO FOREIGN DISSEM

S-E-C-R-E-T
NO FOREIGN DISSEM

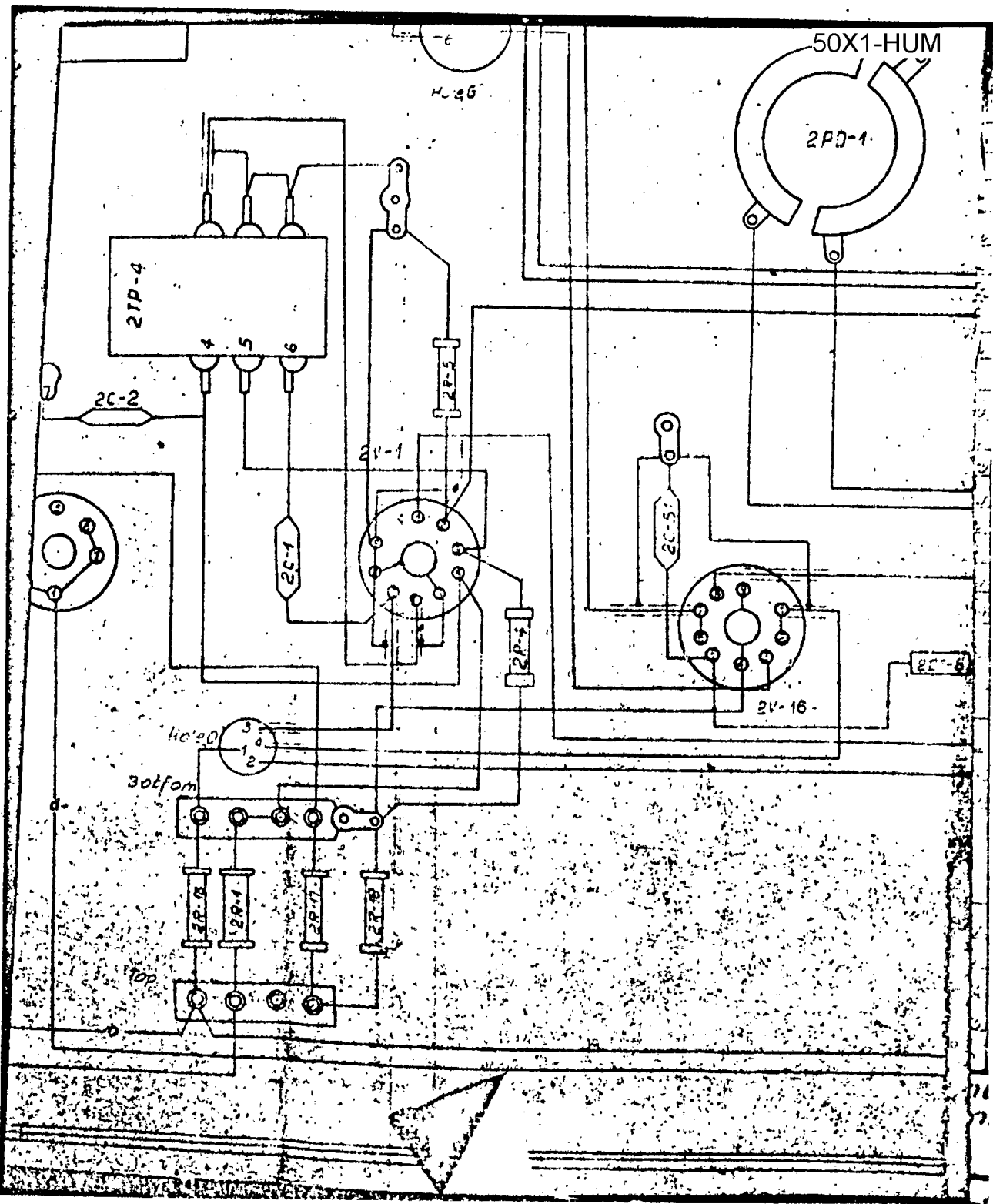

S-E-C-R-E-T
NO FOREIGN DISSEM

~~S-E-C-R-E-T~~
NO FOREIGN DISSEM

50X1-HUM

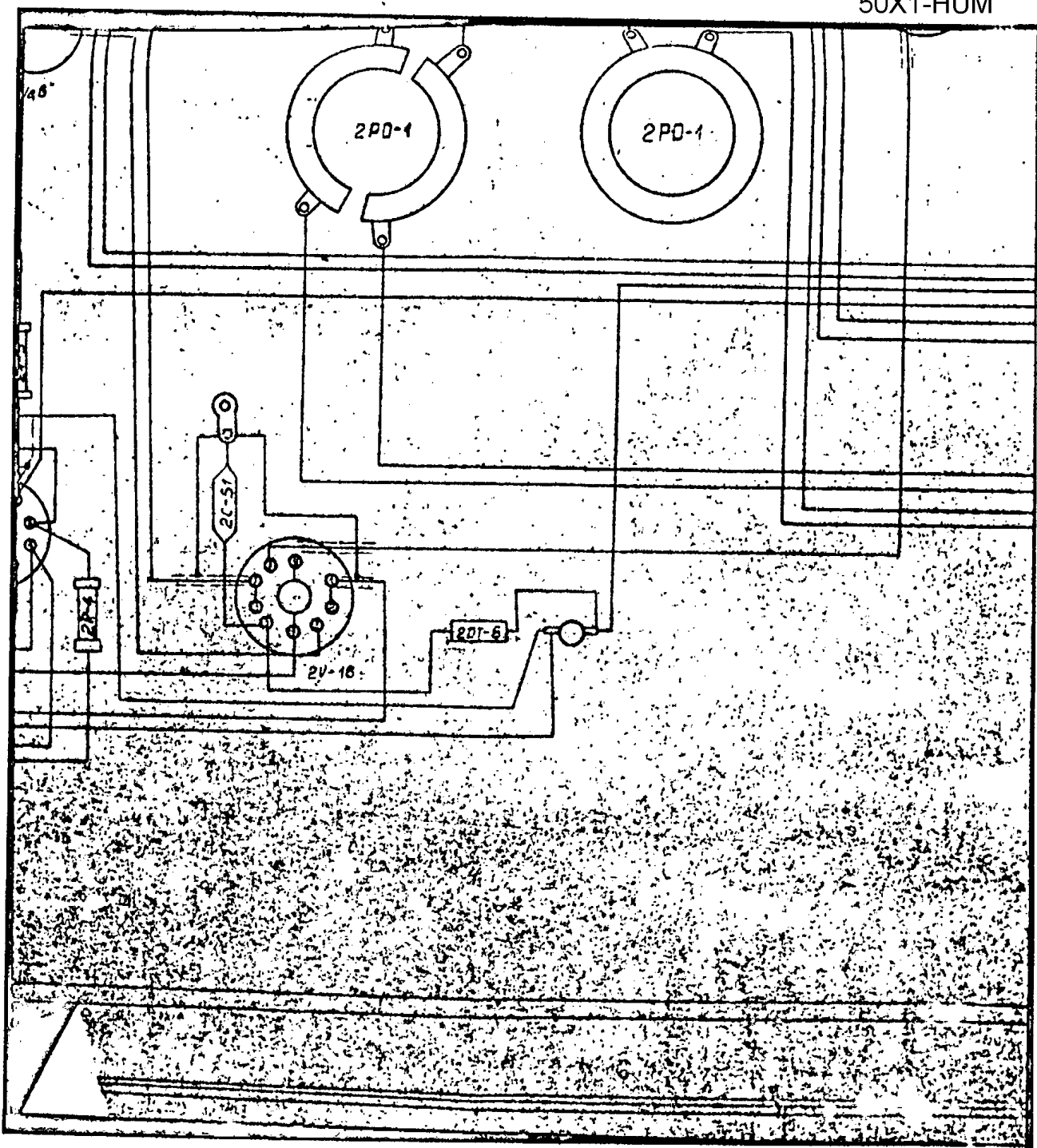

S-E-C-R-E-T
NO FOREIGN DISSEM

NO FOREIGN DISSEM

50X1-HUM

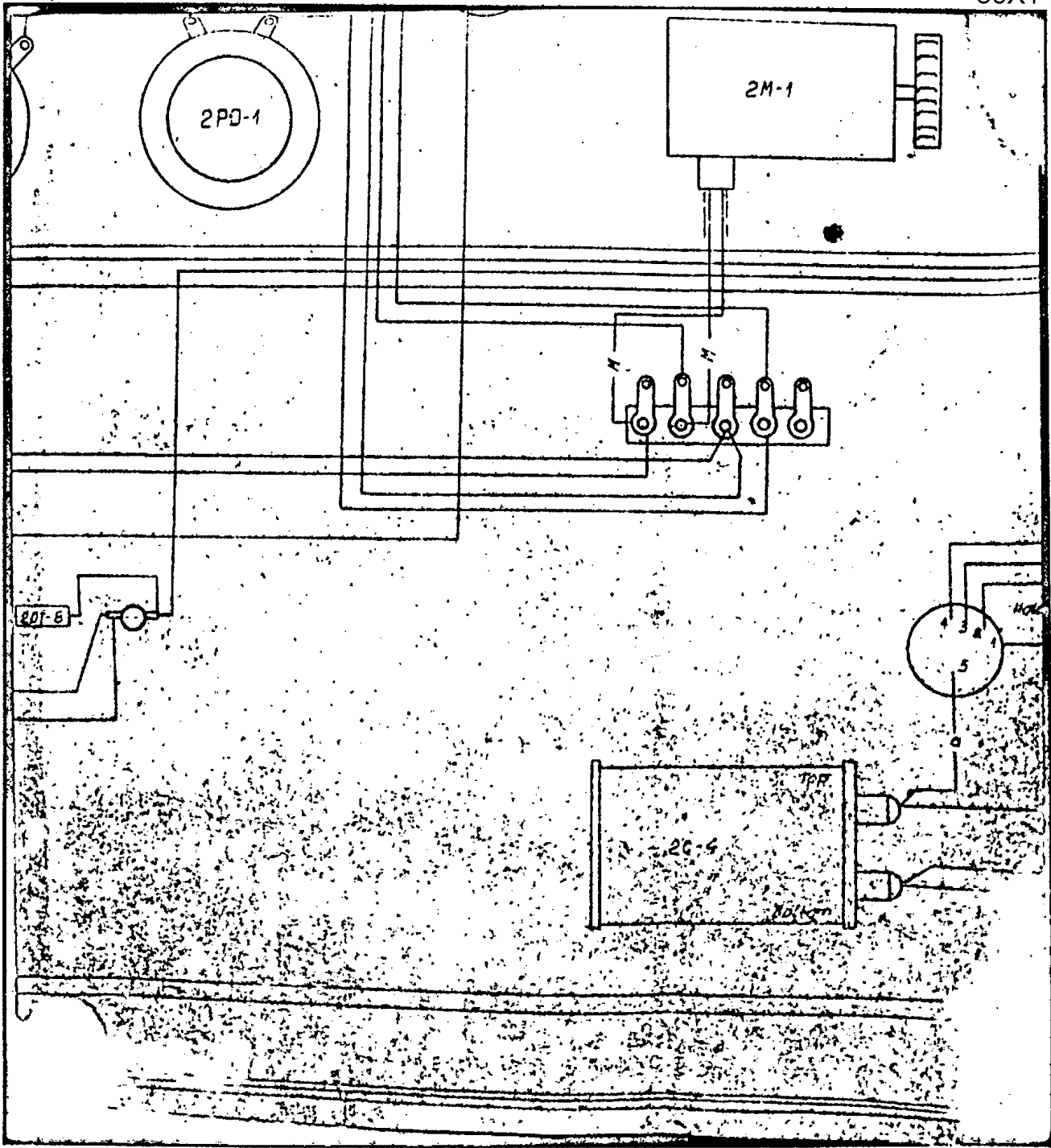

S-E-C-R-E-T

NO FOREIGN DISSEM

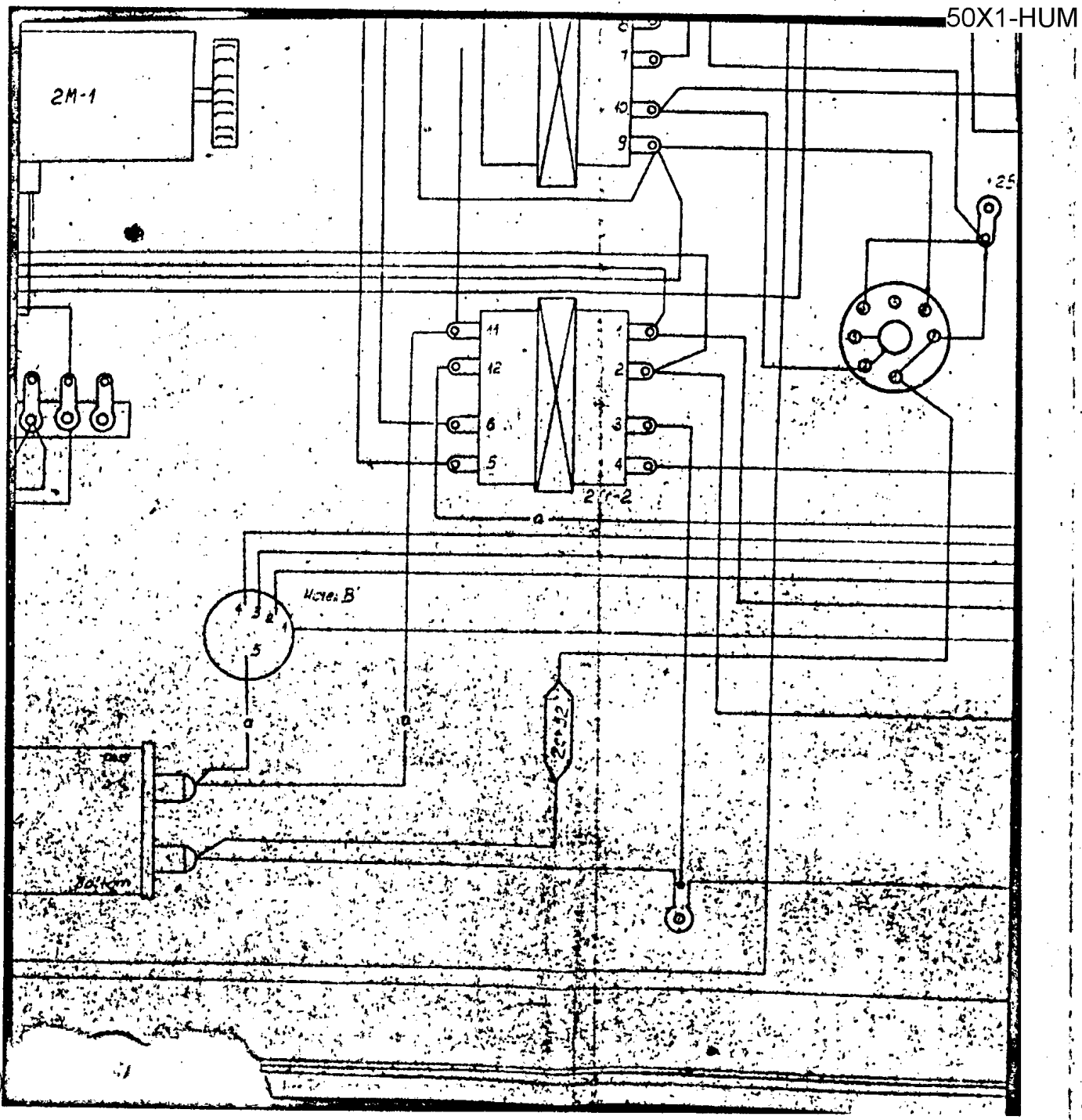

S-E-C-R-E-T
NO FOREIGN DISSEM

NO FOREIGN DISSEM

50X1-HUM

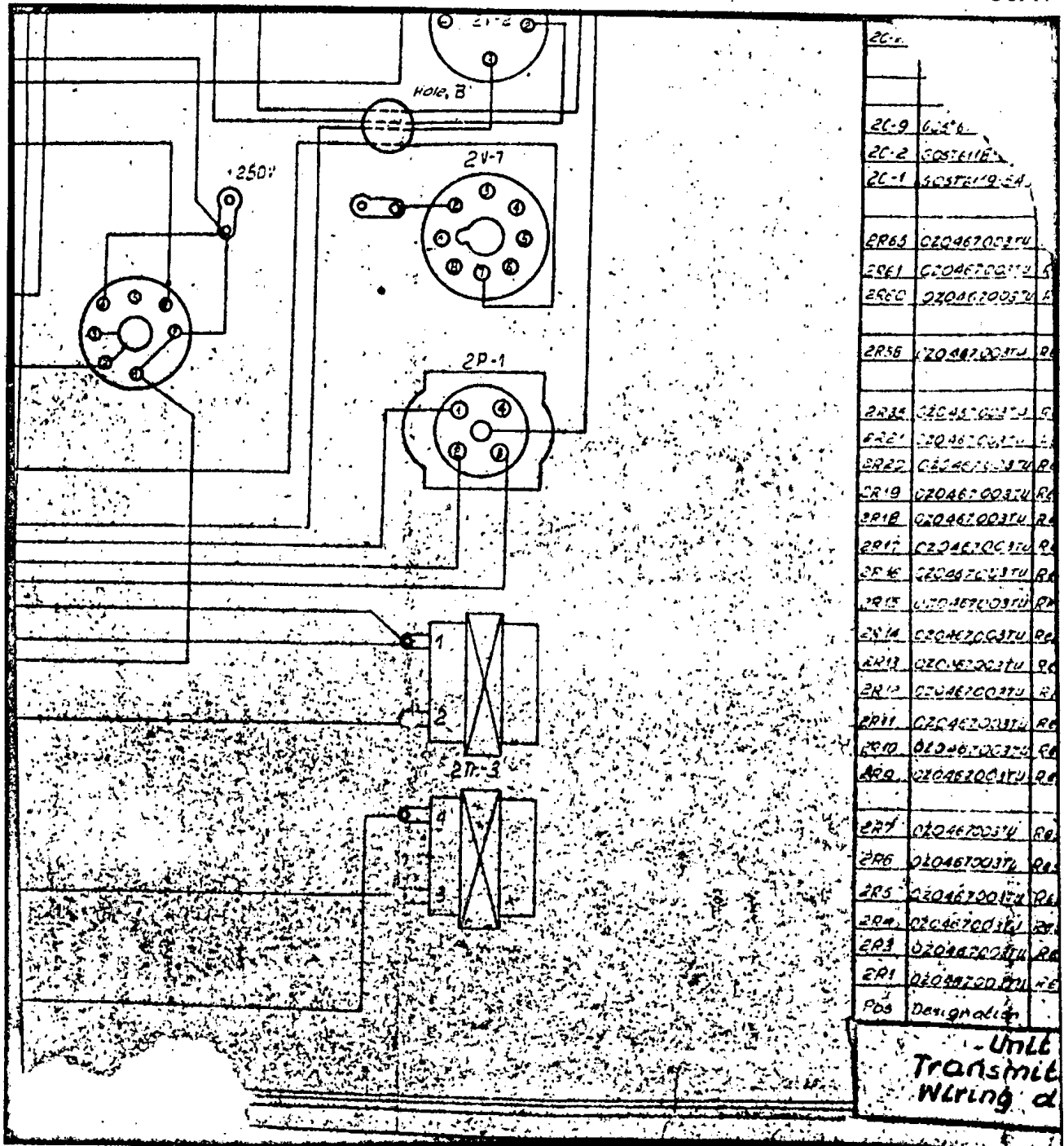

Unit Transmitted Wiring d

6

S-E-C-R-E-T

NO FOREIGN DISSEM

50X1-HUM

Part No.	Value	Remarks	Value	Remarks
2C-24	60276119-5A	Condenser K50-2-500-1000G-T	1000G	1
2C-9	60276119-5A	Condenser K50-2-250-8-10000-T	10000G	1
2C-2	60276119-5B	Condenser K80-2-600-10000	10000G	1
2C-1	60276119-5A	Condenser K50-2-500-1000G-T	1000G	1
2R65	020467003TV	Resistance MET-100R - J-B	100R	1
2R61	020467003TV	Resistance MET-82KR - J-B	82KR	1
2R60	020467003TV	Resistance MET-2-300R - J-B	300R	1
2R58	020467003TV	Resistance MET-0.5-300 - J-B	300R	1
2R35	020467003TV	Resistance MET-1-100R - J-B	100R	1
2R21	020467003TV	Resistance MET-1-220R - J-B	220R	1
2R20	020467003TV	Resistance MET-1-47KR - J-B	47KR	1
2R19	020467003TV	Resistance MET-1-47MR - J-B	47MR	1
2R18	020467003TV	Resistance MET-1-43MR - J-B	43MR	1
2R17	020467003TV	Resistance MET-1-43MR - J-B	43MR	1
2R15	020467003TV	Resistance MET-2-150KR - J-B	150KR	1
2R15	020467003TV	Resistance MET-2-15MR - J-B	15MR	1
2R14	020467003TV	Resistance MET-2-1MR - J-B	1MR	1
2R13	020467003TV	Resistance MET-2-1MS - J-B	1MS	1
2R12	020467003TV	Resistance MET-2-1MR - J-B	1MR	1
2R11	020467003TV	Resistance MET-2-1KR - J-B	1KR	1
2R10	020467003TV	Resistance MET-1-100R - J-B	100R	1
2R9	020467003TV	Resistance MET-2-100R - J-B	100R	1
2R7	020467003TV	Resistance MET-2-66KR - J-B	66KR	1
2R6	020467003TV	Resistance MET-2-1KR - J-B	1KR	1
2R5	020467003TV	Resistance MET-2-10KR - J-B	10KR	1
2R4	020467003TV	Resistance MET-2-47KR - J-B	47KR	1
2R3	020467003TV	Resistance MET-2-240KR - J-B	240KR	1
2R1	020467003TV	Resistance MET-1-150KR - J-B	150KR	1
Pos	Dependent	Name	Value	Remarks

Unit 2
 Transmitter-receiver unit
 Wiring diagram
 370,000,000 sch/s
 page 39

50X1-HUM

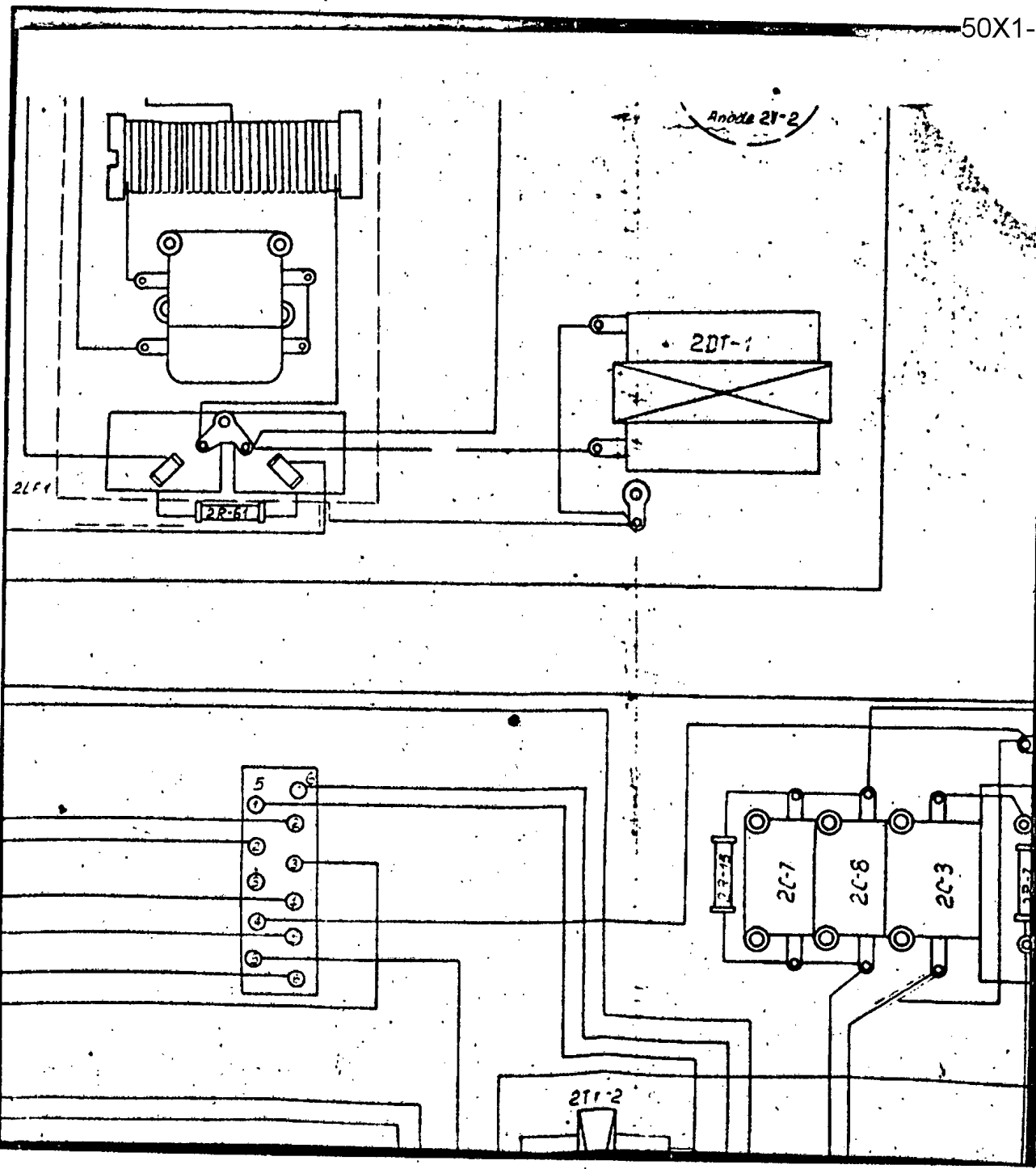

S-E-C-R-E-T
NO FOREIGN DISSEM

NO FOREIGN DISSEM

50X1-HUM

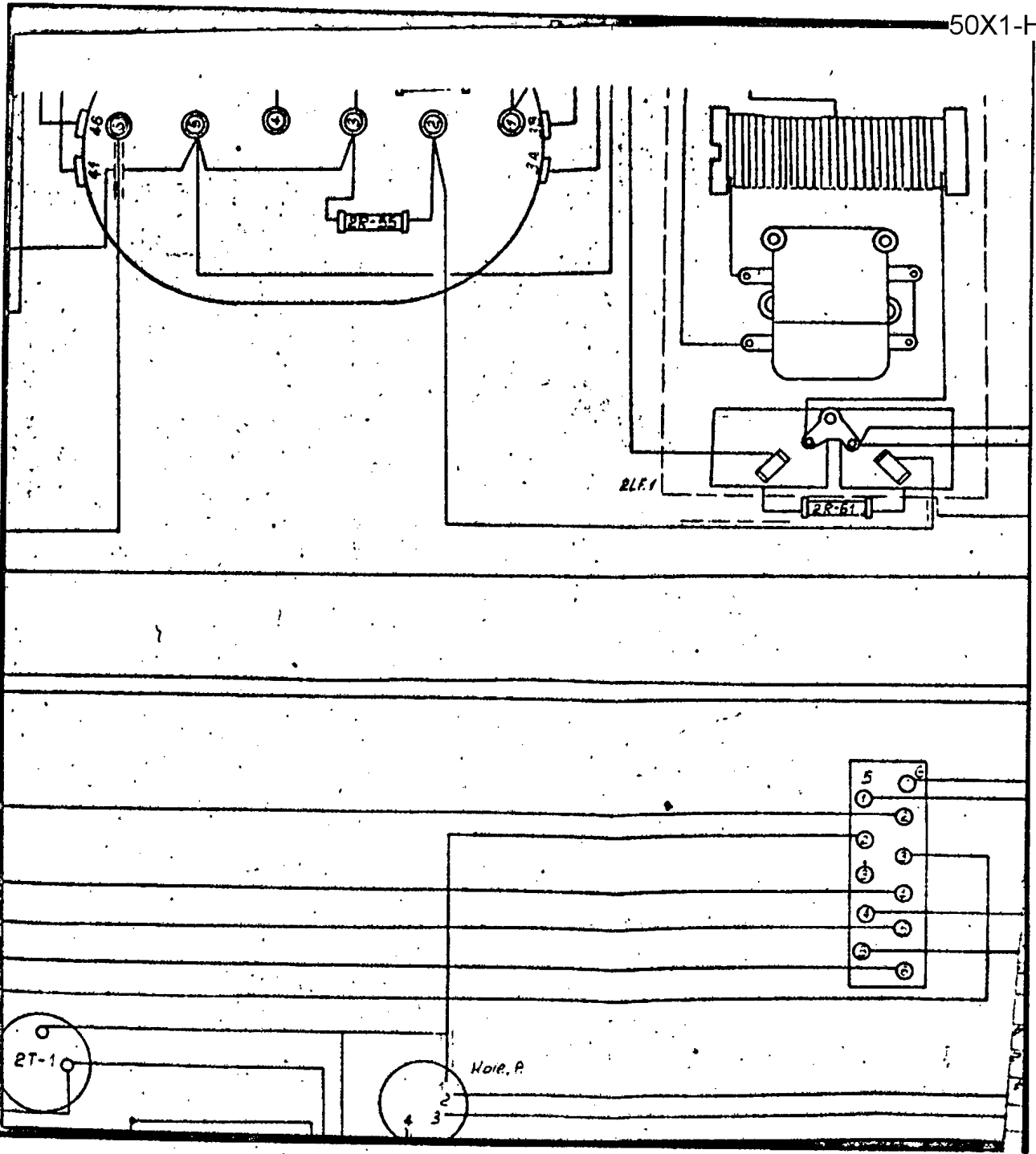

S-E-C-R-E-T
NO FOREIGN DISSEM

S-E-C-R-E-T
NO FOREIGN DISSEM

50X1-HUM

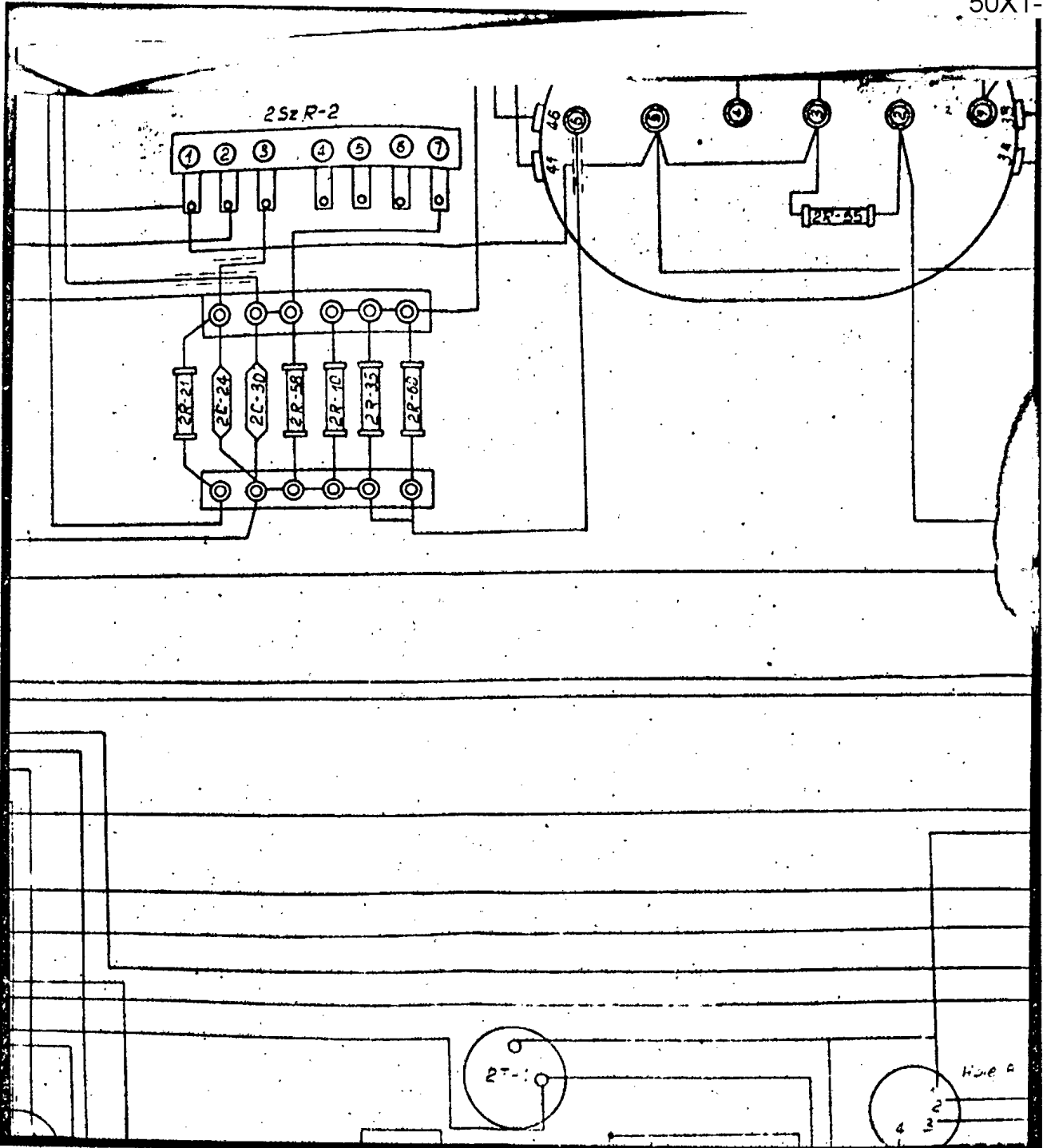

S-E-C-R-E-T
NO FOREIGN DISSEM

S-E-C-R-E-T
NO FOREIGN DISSEM

50X1-HUM

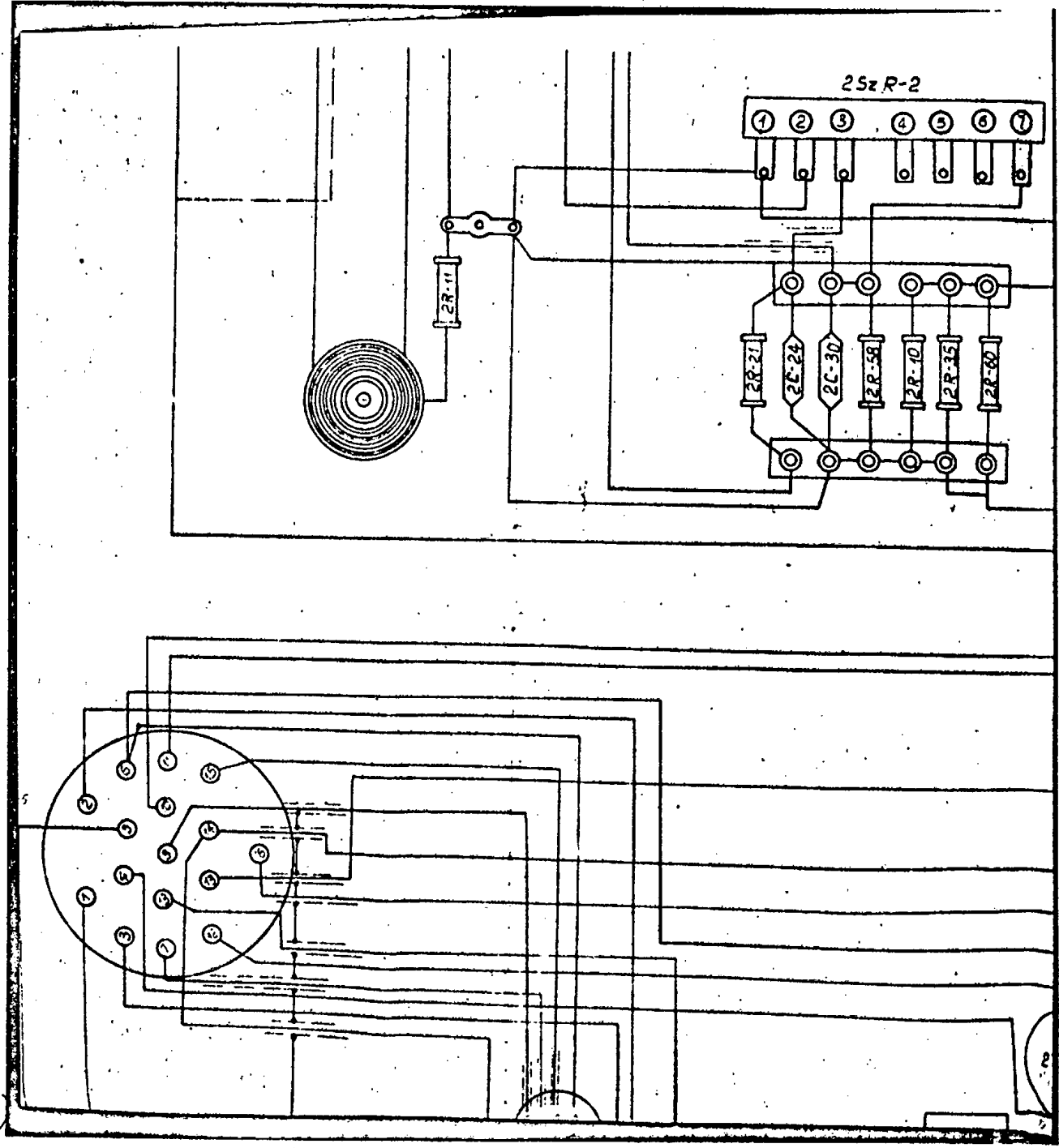

(13)

S-E-C-R-E-T
NO FOREIGN DISSEM

NO FOREIGN DISSEM

50X1-HUM

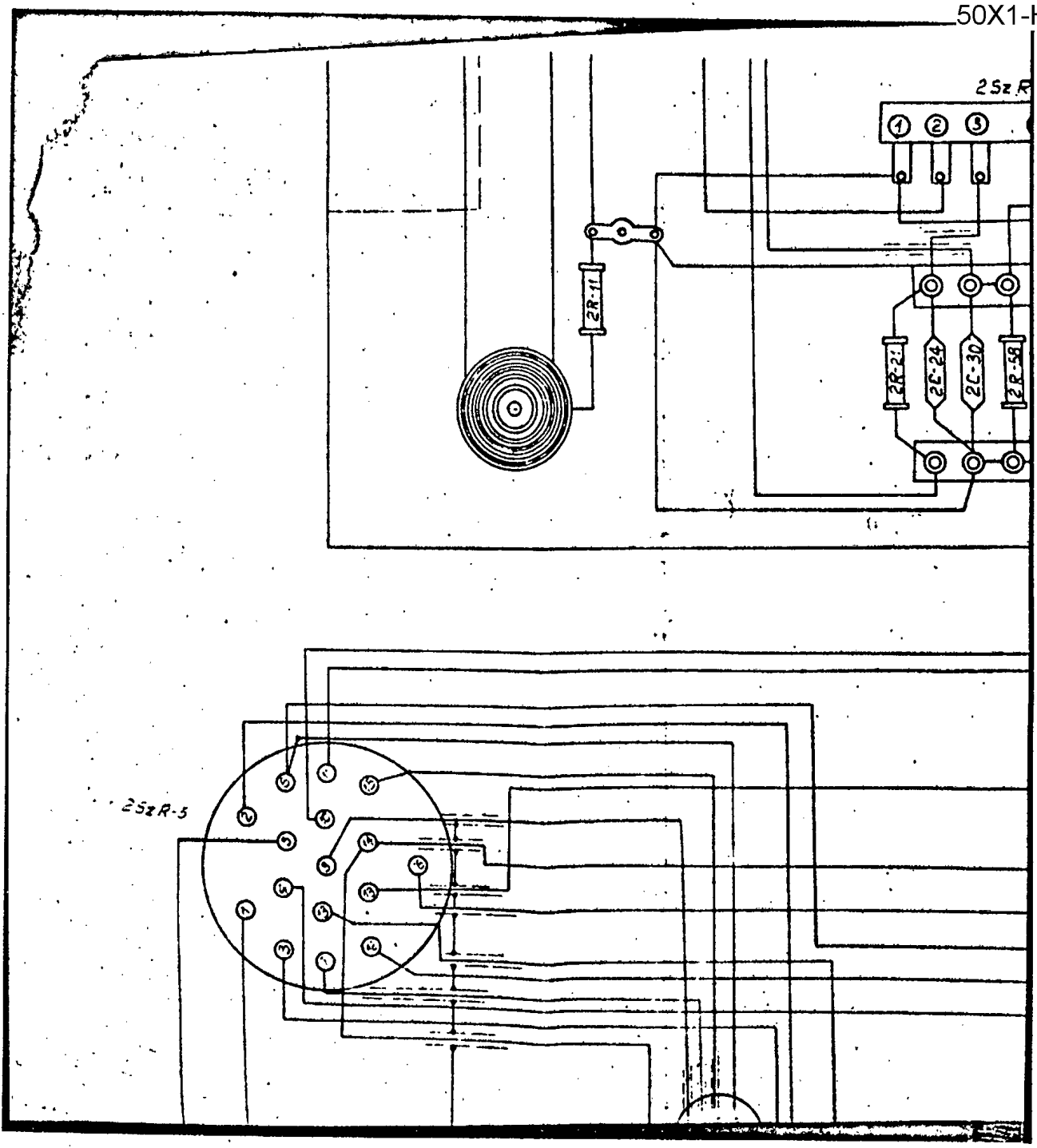

S-E-C-R-E-T
NO FOREIGN DISSEM

NO FOREIGN DISSEM

50X1-HUM

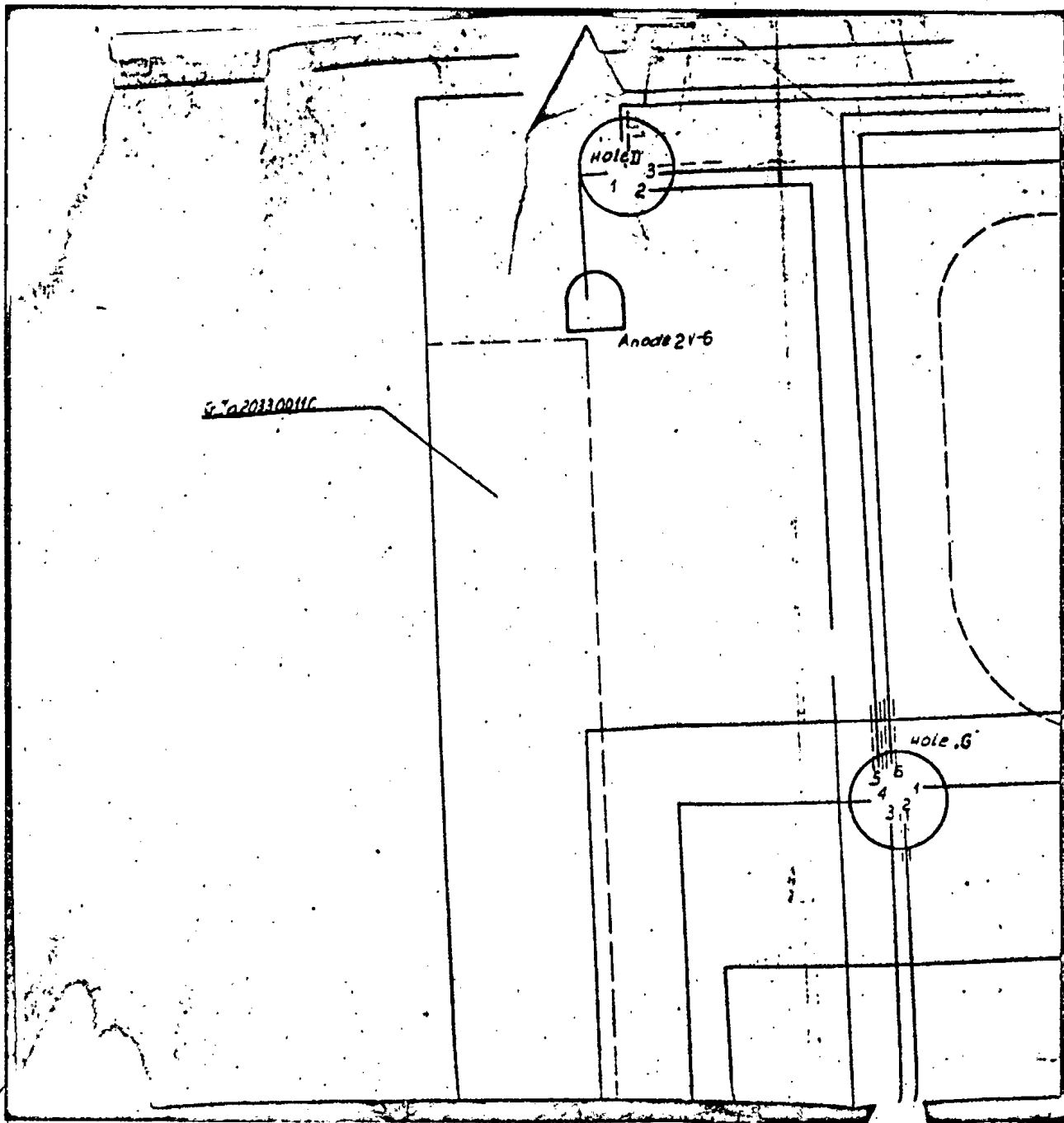

(15)

S-E-C-R-E-T

NO FOREIGN DISSEM

50X1-HUM

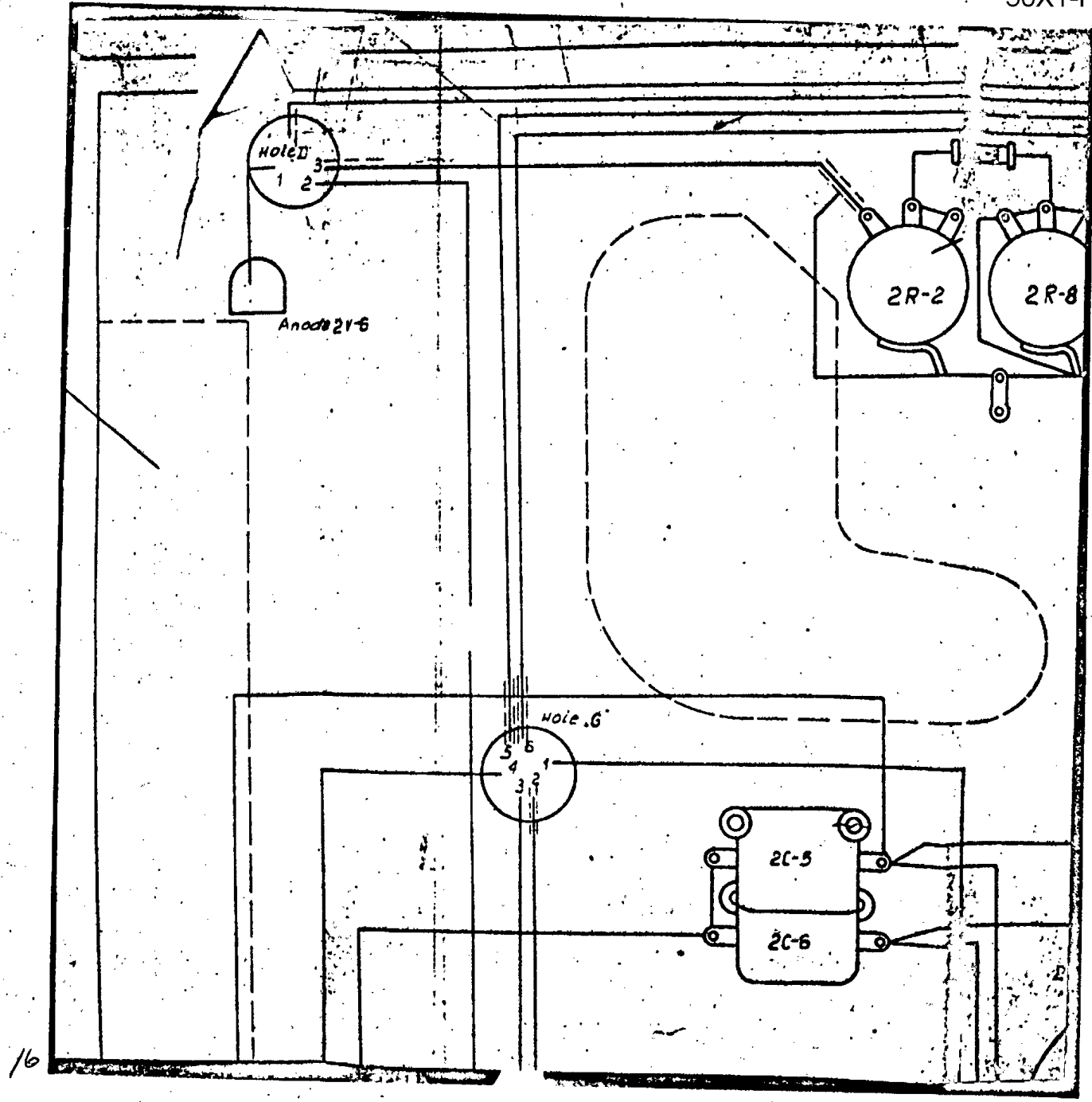

S-E-C-R-E-T
NO FOREIGN DISSEM

NO FOREIGN DISSEM

50X1-HUM

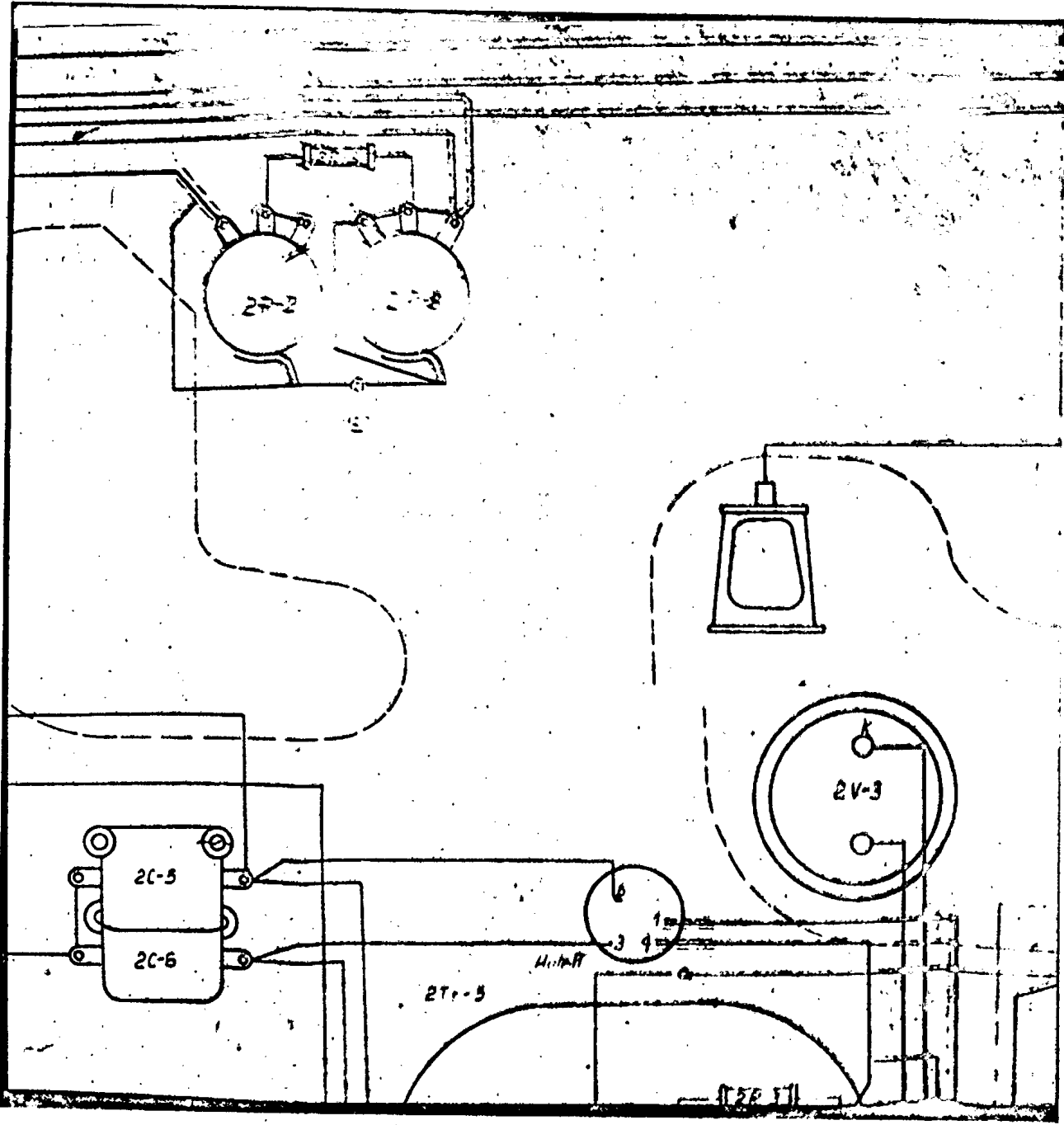

S-E-C-R-E-T
NO FOREIGN DISSEM

NO FOREIGN DISSEM

50X1-HUM

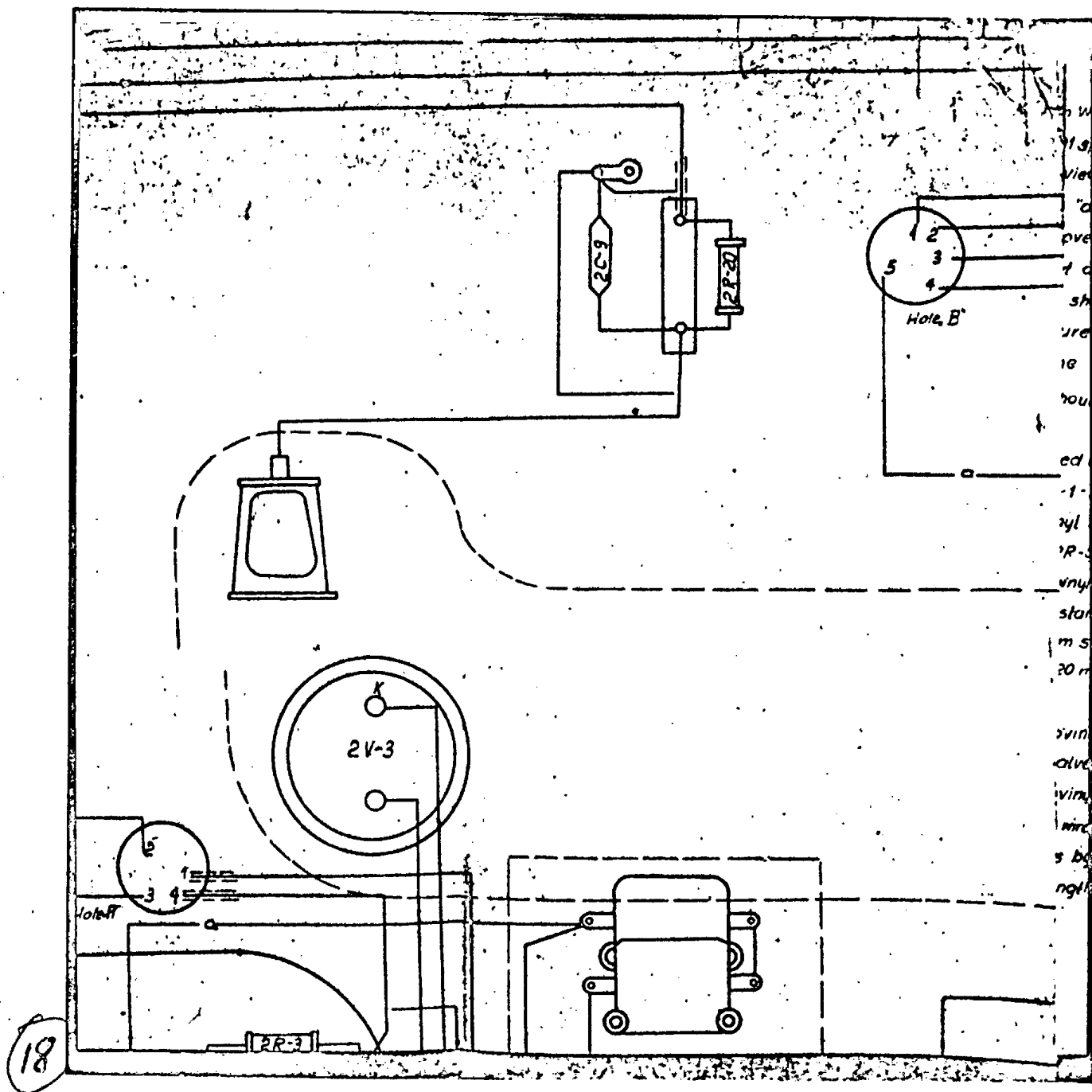

18

S-E-C-R-E-T

NO FOREIGN DISSEM

50X1-HUM

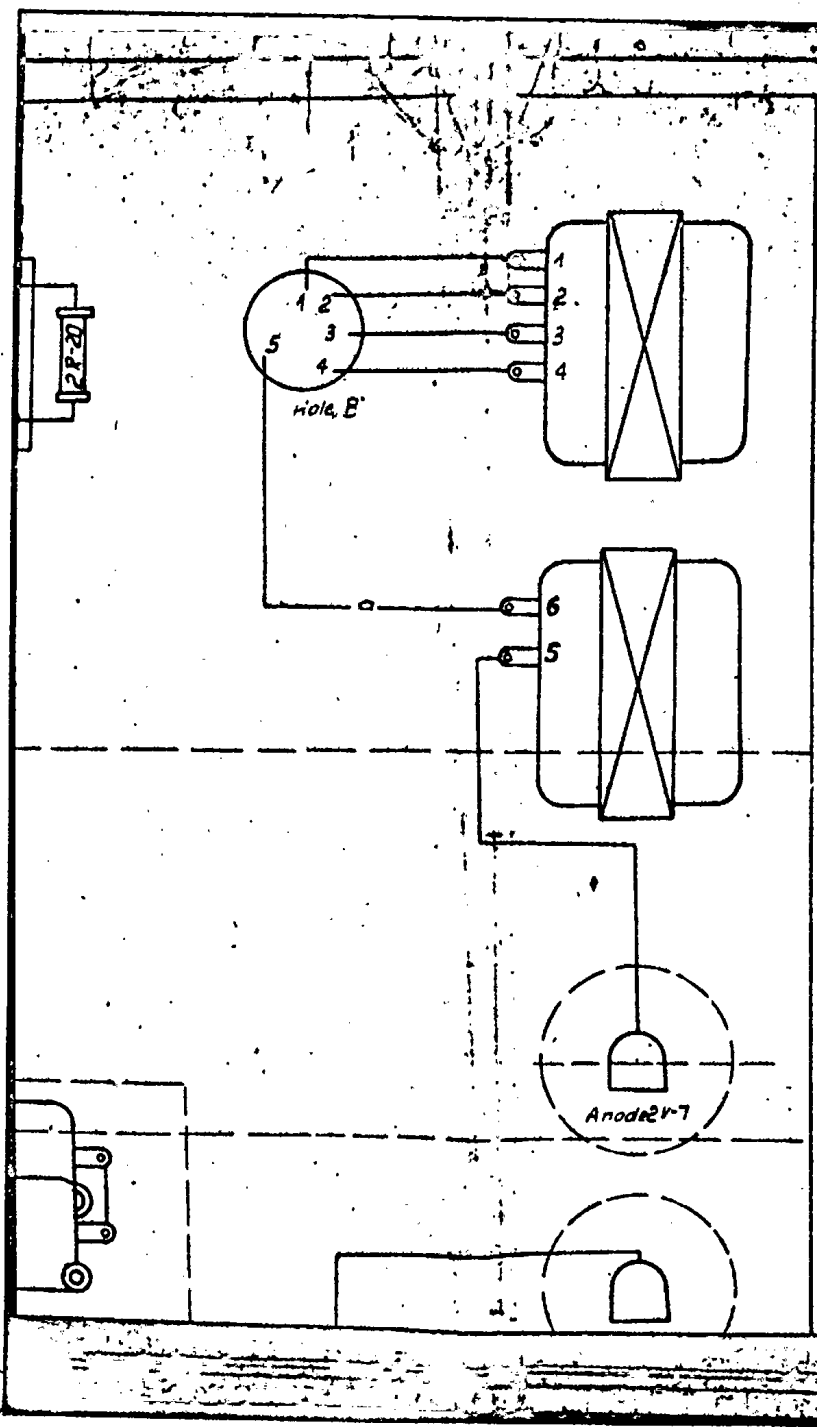

1. All connections
2. Wires marked -d-
3. " " " " -b-B
4. " " " " -w-B
5. " " " " chrome coated
6. Ends connecting earth wire 0.5-0.8 mm² and vinyl sleeve φ 1 mm.
7. Wires 2 SzR-5 2V-4 10 or 12 red with chloro vinyl sleeve should be
8. Wires 2 SzR-2, 2 SzR-
9. To leads 30" and 30" to 10 m 120.001/copper ends 1-switch of wires should be vinyl sleeve φ 0.5 mm.
10. On the leads from ch vinyl sleeve φ 0.35 should be used.
11. On wires put under th vinyl sleeve φ 8 mm, L=20 mm should be used.
12. On screwed wire let vinyl sleeve φ 3.5 L=70 mm should be used.
13. Cables to heating n vinyl sleeve φ 10 mm should be used.
14. All wires should be vinyl sleeve φ 2.7 mm should be used.
15. All details should vinyl sleeve φ 3.0 mm should be used.
16. Resistors MLT sh numbers.

19

10001
diag

S-E-C-R-E-T
 NO FOREIGN DISSEM

NO FOREIGN DISSEM

50X1-HUM

1. All connections should be done by wire BPWt 0.35 mm²
2. Wires marked "a" - BPWt - 0.5 mm²
3. "b" - BPWt - 0.5 mm²
4. "w" - BPWt - 0.5 mm²
5. "c" - chrome coated - BPWtE - 0.35 mm²
6. Ends connecting earth should be done with lined copper wire 0.5-0.8 mm² and if necessary secured with chloro-vinyl sleeve ϕ 1 mm.
7. Wires 2 SzR-5, 2V-4 and valve anode caps should be secured with chloro-vinyl sleeves ϕ 0.35 mm L = 20 mm
8. Wires 2 SzR-2, 2 SzR-4 should be secured with chloro-vinyl sleeves ϕ 2.5 L = 10 mm.
9. To leads "3a" and "3b" of impulse transformer/fig. G70-4, 120.001/copper ends should be soldered and all length of wires should be secured by chloro-vinyl sleeves ϕ 0.5 mm.
10. On the leads from choke Dt-1 to klystron caps chloro-vinyl sleeves ϕ 0.35 should be put on the whole length.
11. On wires put under the transformer 2 Tr-1 the chloro-vinyl sleeve ϕ 8 mm, L = 20 mm should be put on.
12. On screwed wire leading from 2R-18 the chloro-vinyl sleeve ϕ 3.5 L = 70 mm should be put on.
13. Cables to heating motor and valve caps should be so loose that the details can be easily withdrawn.
14. All wires should be bound together with Nr. 100 thread.
15. All details should be marked with black enamel. In accordance to wiring diagram.
16. Resistors M/T should only be marked with the ordinal numbers.
17. 5 1 W/D
G. Ja. 2.070.001 sp s
the general view of
18. Wire marked "d" v
19. The screen covers
should be cut off
"M" the ends should
places secured
20. In the list, the or
21. The fitting should
005010 TU.
22. It was agreed to
heater, 2NK-1 - sv
23. The chloro-vinyl sl
ces 2R-4, 2R-5
24. The chloro-vinyl s
on the resistance
 ϕ 5, L = 20 mm shd
and ϕ 8, L = 20 mm
Lo 2R-7
25. The chloro-vinyl
wires to valve v
26. The chloro-vinyl
screened wires
27. Wire ends by
on the length

20

S-E-C-R-E-T

NO FOREIGN DISSEM

NO FOREIGN DISSEM

50X1-HUM

17. Cables from WWPCz/fig G3o 2.033.001/ and APCz/fig G.3a.2.070.001 sp should be connected according to the general view fig. G3o. 2000.001/3.
18. Wire marked "d" withdrawing detail.
19. The screen covers of cables from ventilator motor, should be cut off for 15-20 mm, to the wires marked "M" the ends should be soldered in, and soldering places secured by chlorovinyl sleeves $\phi 3.5$, L=15 mm
20. In the list, the only items of this circuit are shown.
21. The fitting should be done according to OUt for WPO. CO5010 TU.
22. It was agreed to mark 2LF-forming line; 2PD-1 - heater; 2NK-1 - switch; 2P-1 - switch.
23. The chlorovinyl sleeves $\phi 8$ should be put on the resistances 2R-4, 2R-5 and 2R-7.
24. The chlorovinyl sleeves: $\phi 5$, L=25 mm should be put on the resistances 2R-12, 2R-14, 2R-15 2R-55. $\phi 5$, L=20 mm should be put on resistances 2R-20, 2R-63 and $\phi 8$, L=20 mm should be put on the wire from 2C-3 to 2R-7.
25. The chlorovinyl sleeve $\phi 3.5$ should be put on the screened wires to valve V-1
26. The chlorovinyl sleeve $\phi 3.5$ L=70 mm should be put on the screened wires to 2LF-1
27. Wire ends by 2T-2 should be bound with the tape TSz5-1 on the length of 50 mm
- sleeves
 $\phi 2.5$ L=10 mm
- cor.
- 21

S-E-C-R-E-T

NO FOREIGN DISSEM

NO FOREIGN DISSEM

50X1-HUM

Remarks

1. The connections should be done with:
 - a/ wires marked "G" BPWt - 0,35 mm²
 - b/ "S" BPWL - 0,35 mm²
 - c/ "P" tinned copper wire $\phi 8$
2. Earth connections should be done with tinned copper wire $\phi 0,5$
3. The leads from coil circuits are marked "R"
4. The sleeves $\phi 1$ should be put on all wires marked "P"
5. The mark "X" means that soldering should be done when fitting, but mechanical installation should be done after tuning.
6. The screen of the cable GJa 4,853,017 should be soldered to the sockets.
7. Solder P05-61 should be used for all soldering.
8. The screens of cables GJa 4,850,007 and GJa 4,850,008 should be soldered to the sockets.
9. The valve sockets should be fitted with valves in.
10. Sleeves $\phi 3,5$ L=15 mm should be put on chokes 2L-2, 2L-4 and 2L-17.
11. Radio details should be marked with black or white enamel according to the wiring diagram.
12. The distance from the chassis to the radio details should not exceed 24 mm.

①

S-E-C-R-E-T

NO FOREIGN DISSEM

NO FOREIGN DISSEM

50X1-HUM

Part No.	QTY	Remarks	POS NO	Designation	Name	QTY	Remarks
2520-54			2L-8	TJ-21359			2C-19 G
250-54				TU-U ^{741N37-17}	Choke D-1.2 5UH	1	2C-18 G
254			2L-9	TJ-21359			2C-17 G
	GOAM			TU-U ^{741N37-17}	Choke D-0.1 10UH	1	2C-16 G
	IM		2L-6	TU-21359			2C-15 G
WNS278-43	GBM			TU-U ^{741N37-17}	Choke D-1.2 5UH	1	2C-14 G
WNS298-43	GBM		2L-5	TU-21359			2C-13 G
ME0677-47	IM			TU-U ^{741N37-17}	Choke D-1.2 5UH	1	2C-12 G
2677-47			2L-4	TU-21359			2C-11 G
				TU-U ^{741N37-17}	Choke D-0.1 20UH	1	2C-10 G
			2L-2	TU-21359			
	1			TU-U ^{741N37-17}	Choke D-0.1 10UH	1	2R-21 OZ
	1						2R-20 OZ
	1						2R-19 OZ
	1						2R-18 OZ
	1						2R-17 OZ
	1						2R-16 OZ
	1						2R-15 OZ
	1						2R-14 OZ
	1						2R-13 OZ
	1						2R-12 OZ
	1						2R-11 OZ
	1						2R-10 OZ
	1						2R-9 OZ
	1						2R-8 OZ
	1						2R-7 OZ
	1						2R-6 OZ
	1						2R-5 OZ
	1						2R-4 OZ
	1						2R-3 OZ
	1						2R-2 OZ
	1						2R-1 OZ
	1						2R-0 OZ
	1						2R-25 OZ
	1						2R-24 OZ
	1						2R-23 OZ
	1						2R-22 OZ
	1						2R-21 OZ
	1						2R-20 OZ
	1						2R-19 OZ
	1						2R-18 OZ
	1						2R-17 OZ
	1						2R-16 OZ
	1						2R-15 OZ
	1						2R-14 OZ
	1						2R-13 OZ
	1						2R-12 OZ
	1						2R-11 OZ
	1						2R-10 OZ
	1						2R-9 OZ
	1						2R-8 OZ
	1						2R-7 OZ
	1						2R-6 OZ
	1						2R-5 OZ
	1						2R-4 OZ
	1						2R-3 OZ
	1						2R-2 OZ
	1						2R-1 OZ
	1						2R-0 OZ
	1						2R-25 OZ
	1						2R-24 OZ
	1						2R-23 OZ
	1						2R-22 OZ
	1						2R-21 OZ
	1						2R-20 OZ
	1						2R-19 OZ
	1						2R-18 OZ
	1						2R-17 OZ
	1						2R-16 OZ
	1						2R-15 OZ
	1						2R-14 OZ
	1						2R-13 OZ
	1						2R-12 OZ
	1						2R-11 OZ
	1						2R-10 OZ
	1						2R-9 OZ
	1						2R-8 OZ
	1						2R-7 OZ
	1						2R-6 OZ
	1						2R-5 OZ
	1						2R-4 OZ
	1						2R-3 OZ
	1						2R-2 OZ
	1						2R-1 OZ
	1						2R-0 OZ
	1						2R-25 OZ
	1						2R-24 OZ
	1						2R-23 OZ
	1						2R-22 OZ
	1						2R-21 OZ
	1						2R-20 OZ
	1						2R-19 OZ
	1						2R-18 OZ
	1						2R-17 OZ
	1						2R-16 OZ
	1						2R-15 OZ
	1						2R-14 OZ
	1						2R-13 OZ
	1						2R-12 OZ
	1						2R-11 OZ
	1						2R-10 OZ
	1						2R-9 OZ
	1						2R-8 OZ
	1						2R-7 OZ
	1						2R-6 OZ
	1						2R-5 OZ
	1						2R-4 OZ
	1						2R-3 OZ
	1						2R-2 OZ
	1						2R-1 OZ
	1						2R-0 OZ
	1						2R-25 OZ
	1						2R-24 OZ
	1						2R-23 OZ
	1						2R-22 OZ
	1						2R-21 OZ
	1						2R-20 OZ
	1						2R-19 OZ
	1						2R-18 OZ
	1						2R-17 OZ
	1						2R-16 OZ
	1						2R-15 OZ
	1						2R-14 OZ
	1						2R-13 OZ
	1						2R-12 OZ
	1						2R-11 OZ
	1						2R-10 OZ
	1						2R-9 OZ
	1						2R-8 OZ
	1						2R-7 OZ
	1						2R-6 OZ
	1						2R-5 OZ
	1						2R-4 OZ
	1						2R-3 OZ
	1						2R-2 OZ
	1						2R-1 OZ
	1						2R-0 OZ
	1						2R-25 OZ
	1						2R-24 OZ
	1						2R-23 OZ
	1						2R-22 OZ
	1						2R-21 OZ
	1						2R-20 OZ
	1						2R-19 OZ
	1						2R-18 OZ
	1						2R-17 OZ
	1						2R-16 OZ
	1						2R-15 OZ
	1						2R-14 OZ
	1						2R-13 OZ
	1						2R-12 OZ
	1						2R-11 OZ
	1						2R-10 OZ
	1						2R-9 OZ
	1						2R-8 OZ
	1						2R-7 OZ
	1						2R-6 OZ
	1						2R-5 OZ
	1						2R-4 OZ
	1						2R-3 OZ
	1						2R-2 OZ
	1						2R-1 OZ
	1						2R-0 OZ
	1						2R-25 OZ
	1						2R-24 OZ
	1						2R-23 OZ
	1						2R-22 OZ
	1						2R-21 OZ
	1						2R-20 OZ
	1						2R-19 OZ
	1						2R-18 OZ
	1						2R-17 OZ
	1						2R-16 OZ
	1						2R-15 OZ
	1						2R-14 OZ
	1						2R-13 OZ
	1						2R-12 OZ
	1						2R-11 OZ
	1						2R-10 OZ
	1						2R-9 OZ
	1						2R-8 OZ
	1						2R-7 OZ
	1						2R-6 OZ
	1						2R-5 OZ
	1						2R-4 OZ
	1						2R-3 OZ
	1						2R-2 OZ
	1						2R-1 OZ
	1						2R-0 OZ
	1						2R-25 OZ
	1						2R-24 OZ
	1						2R-23 OZ
	1						2R-22 OZ
	1						2R-21 OZ
	1						2R-20 OZ
	1						2R-19 OZ
	1						2R-18 OZ
	1						2R-17 OZ
	1						2R-16 OZ
	1						2R-15 OZ
	1						2R-14 OZ
	1						2R-13 OZ
	1						2R-12 OZ
	1						2R-11 OZ
	1						2R-10 OZ
	1						2R-9 OZ
	1						2R-8 OZ
	1						

NO FOREIGN DISSEM

50X1-HUM

		2C-19	GOST 6119-54	Condenser K50-2-500-G-1000-I	1	
1		2C-18	GOST 6119-54	Condenser K50-2-500-G-1000-I	1	
		2C-17	GOST 6119-54	Condenser K50-2-500-G-1000-I	1	
1		2C-16	GOST 6119-54	Condenser K50-2-500-G-1000-I	1	
		2C-15	GOST 6119-54	Condenser K50-2-500-G-1000-I	1	
1		2C-14	GOST 6119-54	Condenser K50-2-500-G-1000-I	1	
		2C-13	GOST 6119-54	Condenser K50-2-500-G-1000-I	1	
1		2C-12	GOST 6119-54	Condenser K50-2-500-G-1000-I	1	
		2C-11	GOST 6119-54	Condenser K50-2-500-G-1000-I	1	
1		2C-10	GOST 6119-54	Condenser K50-2-500-G-1000-I	1	
		2R-28	020467003TU	Resistance MLT-0.5-3WR-II-A	1	checked - per letter 24 FEB 54 - 1542
1		2R-27	020467003TU	Resistance MLT-0.5-220R-I-A	1	
		2R-26	020467003TU	Resistance MLT-0.5-220R-I-A	1	
		2R-25	020467003TU	Resistance MLT-0.5-200R-I-A	1	
		2R-24	020467003TU	Resistance MLT-0.5-220R-I-A	1	
		2R-23	020467003TU	Resistance MLT-0.5-220R-I-A	1	
1		2R-22	020467003TU	Resistance MLT-0.5-200R-I-A	1	
1		Pos No	Designation	Name	a-ty	Remark
1						
a-ty	Remark	Preliminary WPCz Wiring diagram			GJa2.033.001sch/s page 40	

5

S-E-C-R-E-T
NO FOREIGN DISSEM

50X1-HUM

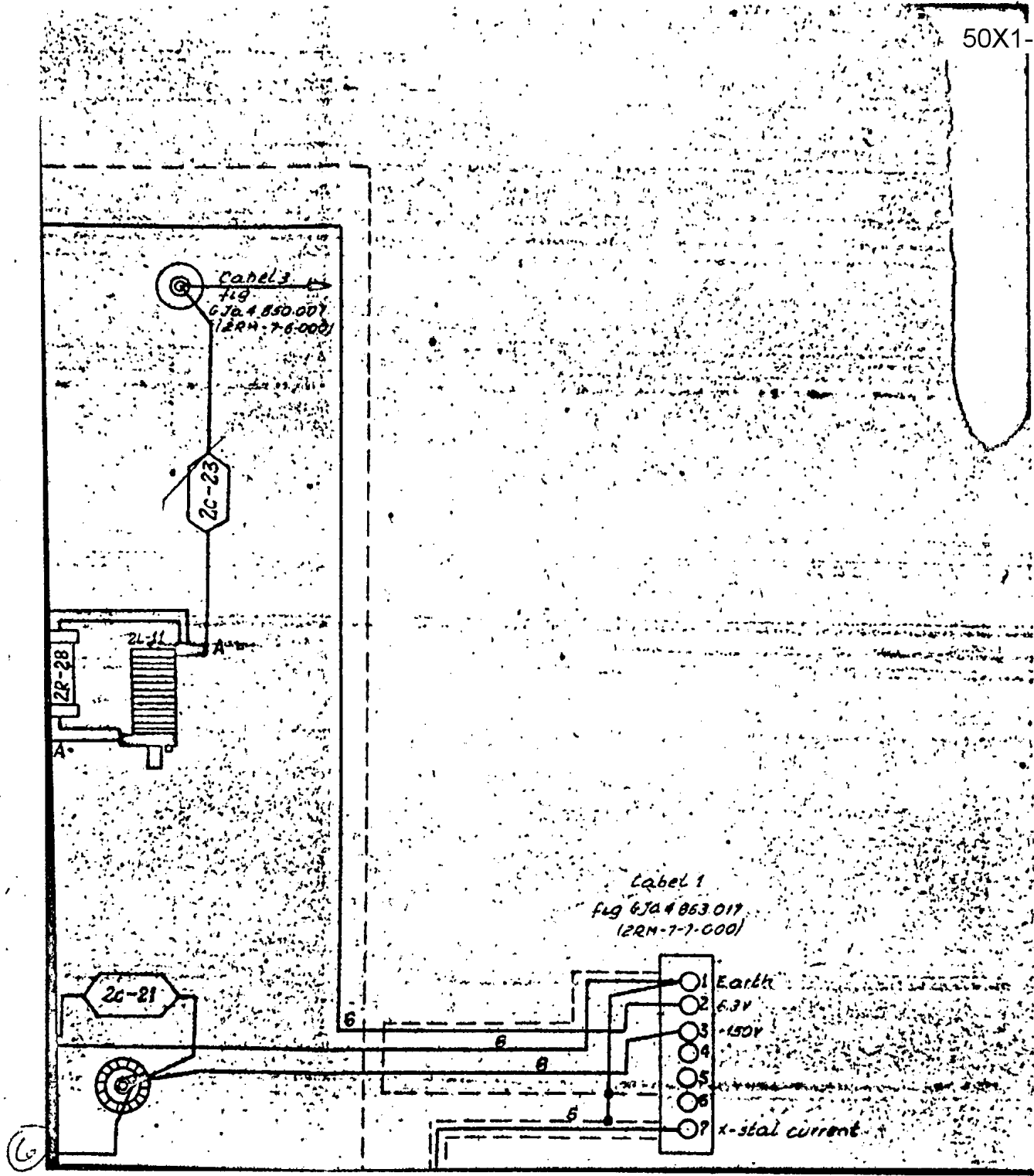

(S-E-C-R-E-T)
NO FOREIGN DISSEM

S-E-C-R-E-T
NO FOREIGN DISSEM

50X1-HUM

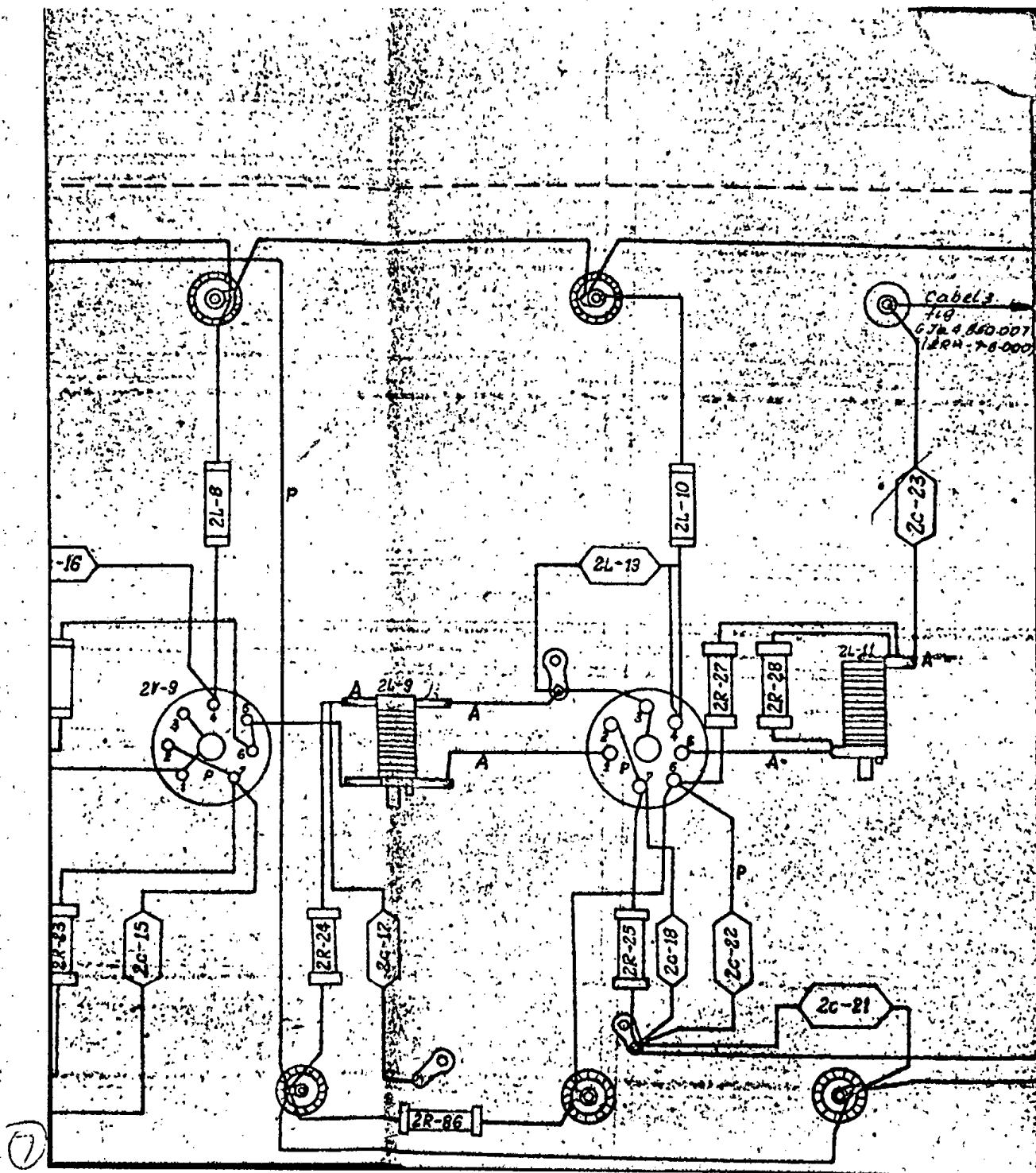

S-E-C-R-E-T
NO FOREIGN DISSEM

U-S-C-A-E-I
NO FOREIGN DISSEM

50X1-HUM.

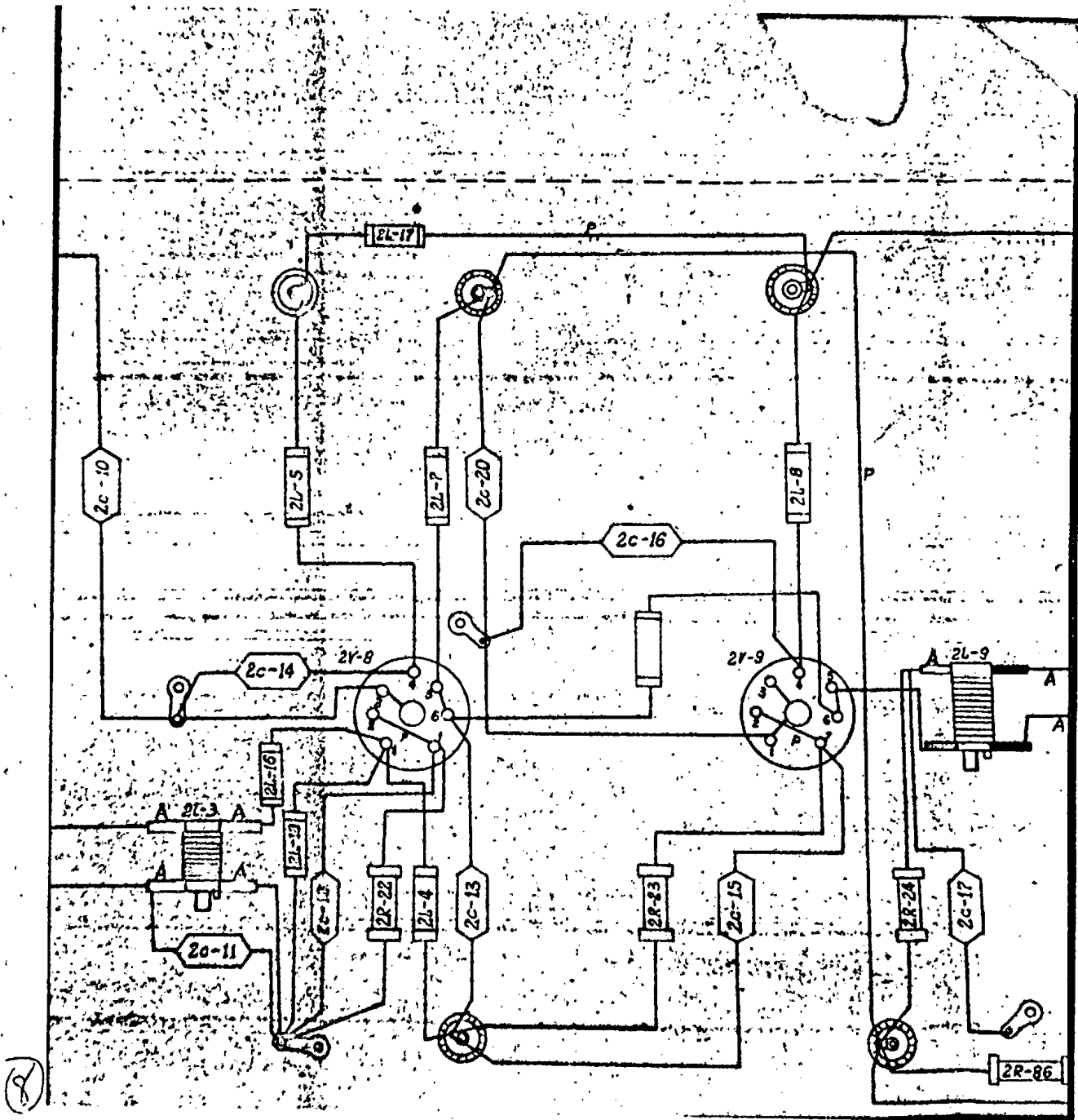

S-E-C-R-E-T
NO FOREIGN DISSEM

NO FOREIGN DISSEM

s/v 50X1-HUM

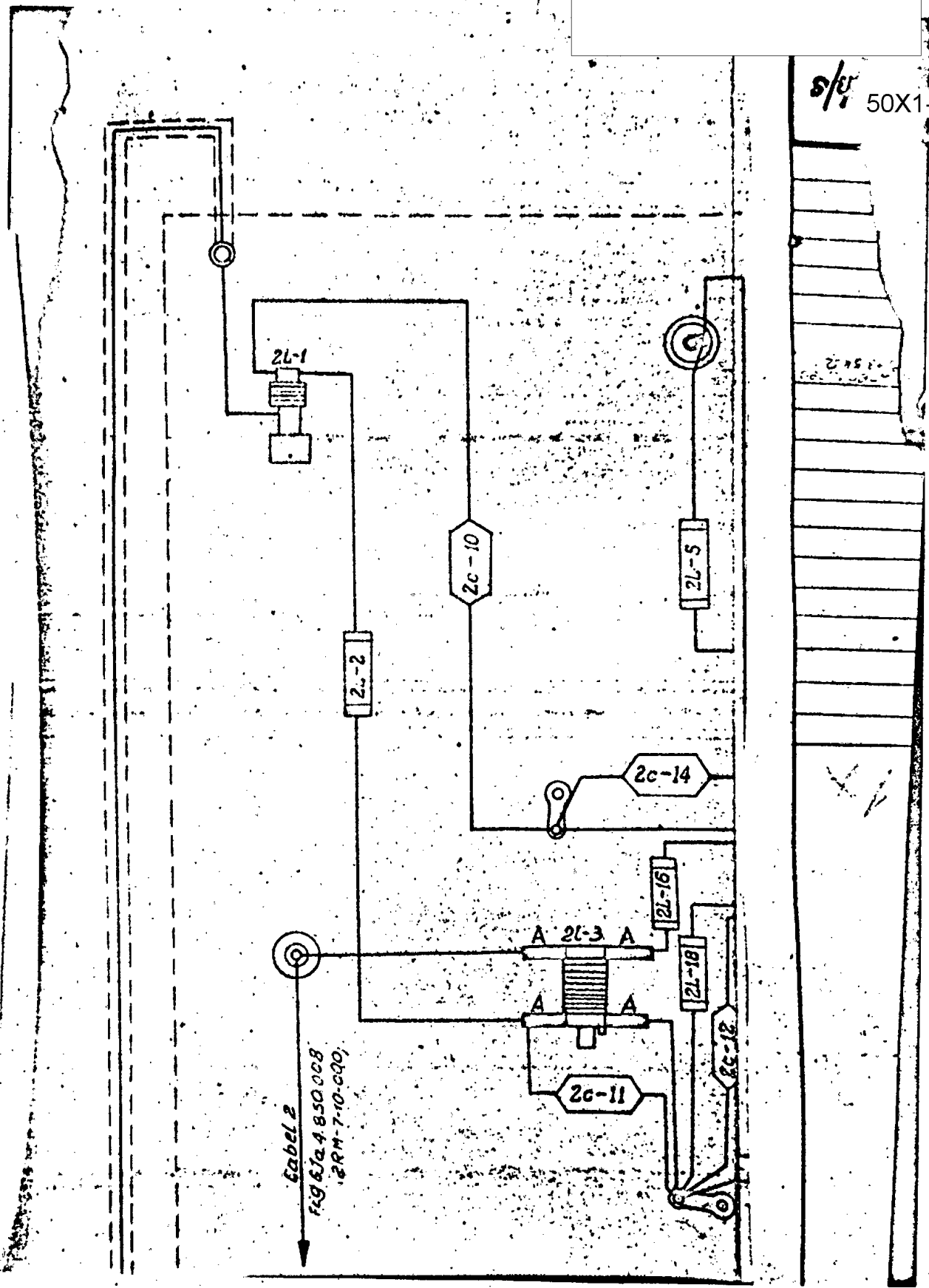

Cable 2
FIG 6Ja 4 850 008
ARM-7-10-000

9

S-E-C-R-E-T

NO FOREIGN DISSEM

NO FOREIGN DISSEM

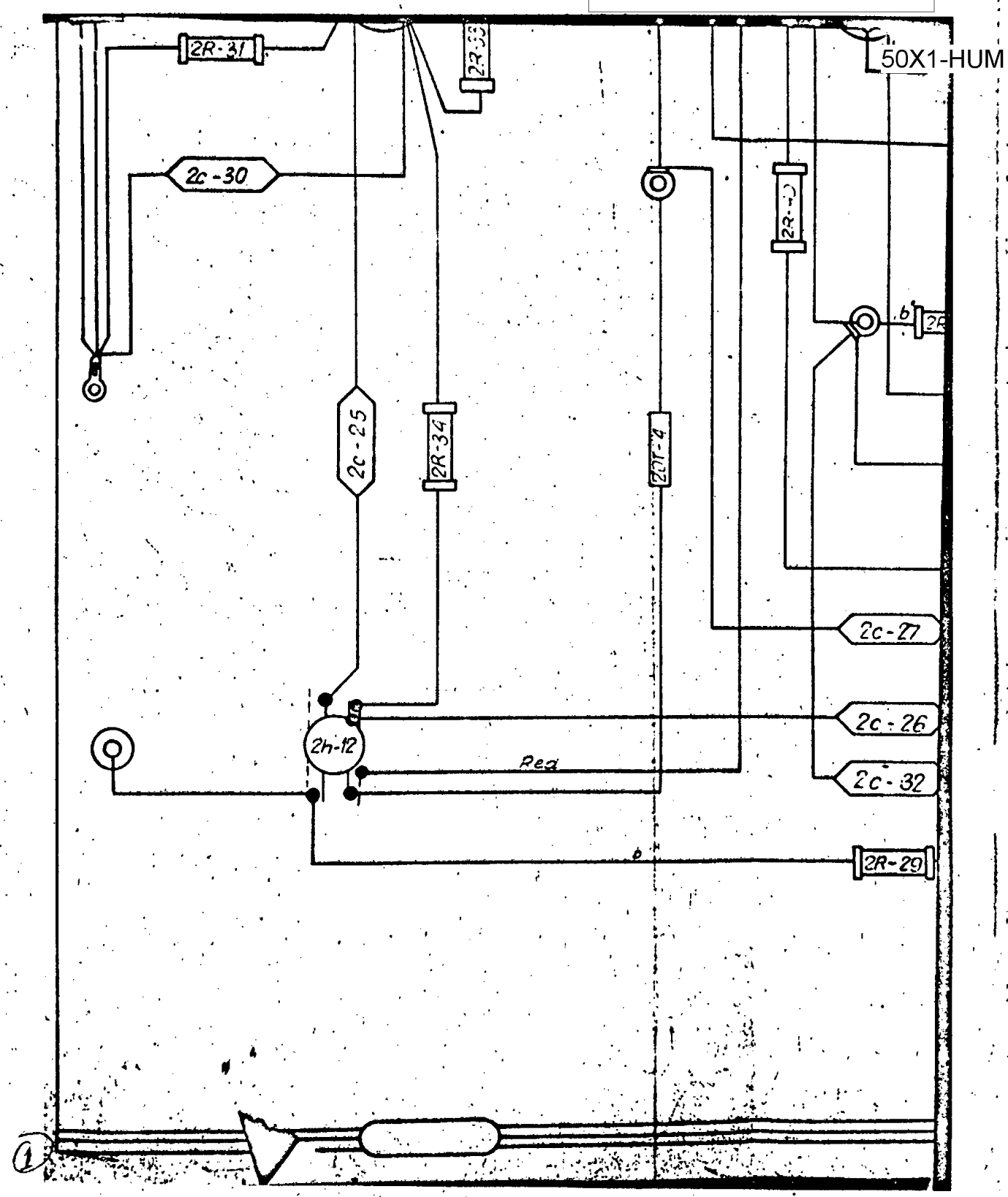

S-E-C-R-E-T
NO FOREIGN DISSEM

S-E-C-R-E-T
NO FOREIGN DISSEM

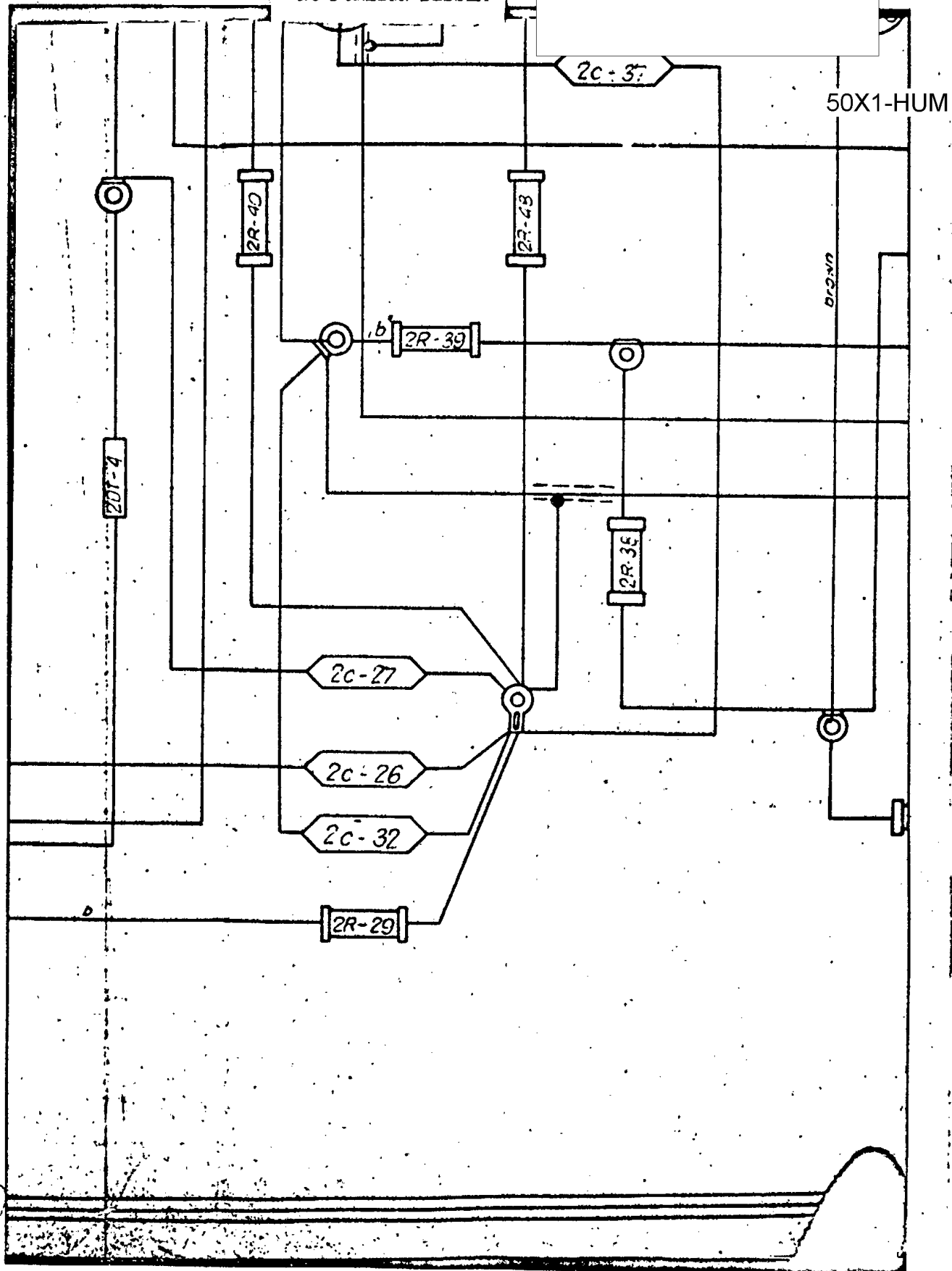

S-E-C-R-E-T
NO FOREIGN DISSEM

NO FOREIGN DISSEM

50X1-HUM

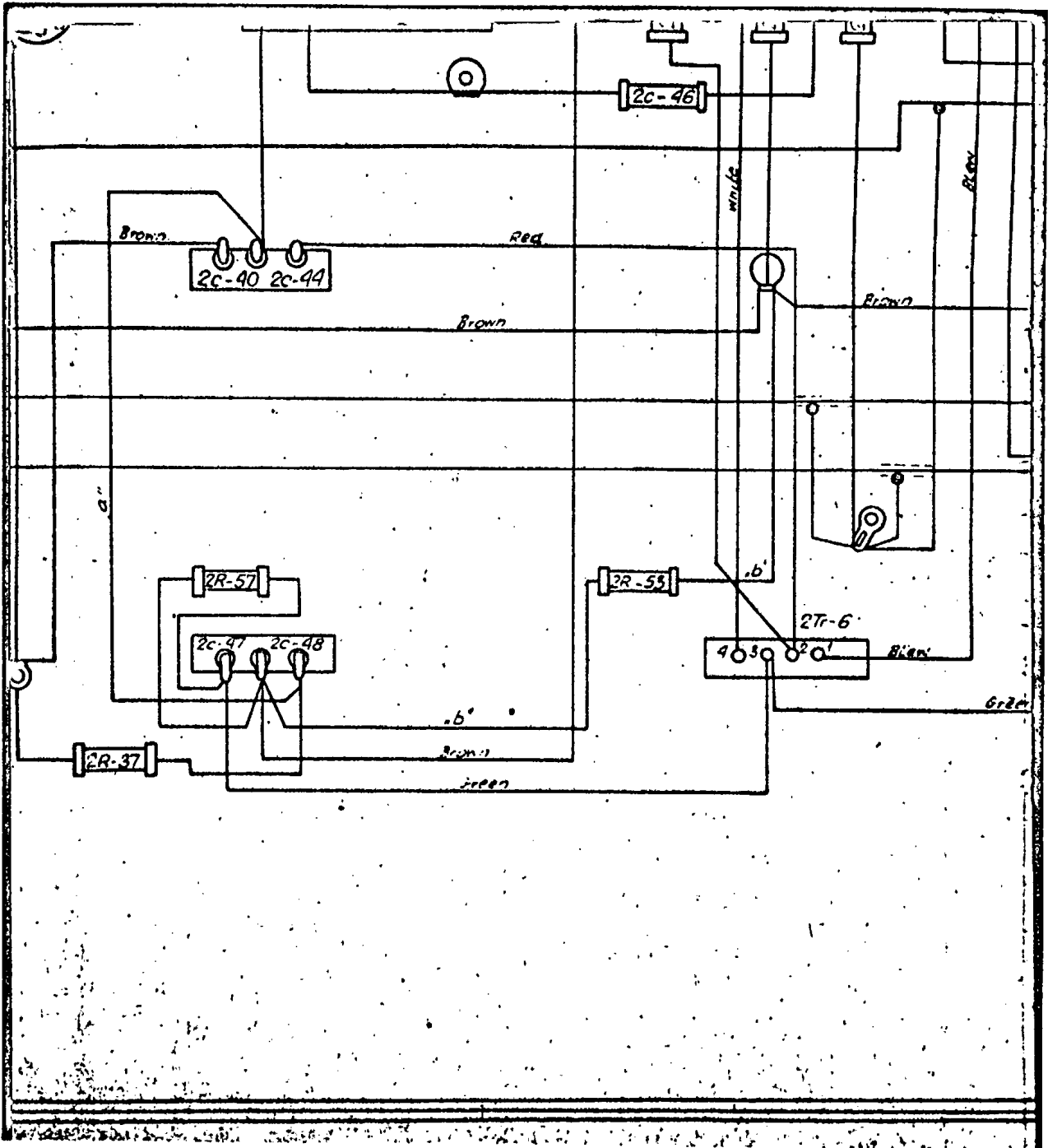

S-E-C-R-E-T

NO FOREIGN DISSEM

NO FOREIGN DISSEM

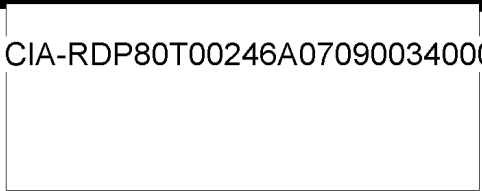

- 8. sleeves 0.25 ± 0.20 mm TUMHO-375-47
- 8. ends of 2R-53 should be soldered to earth connection.
- 9. Connections should be soldered with solder P05-61.
- 10. Details should be marked by numbers and letters with black enamel according to the norm. 0057 003.
- 11. Resistances MET and chokes, the only numbers should be printed, but on the list of details the full designation should be printed according to the wiring diagram 2RM-2-0-000 Sche/S, G7o 2.000.00 Sche/S.
- 12. Radio details should be filled 27.5 mm over the chassis surface.
- 13. Bottom leads of coils are shown with interrupted line.

2R-51	G0576119-54	50X1-HUM
2R-50	G0576119-54	Con
2R-49	G0576119-54	Cono.
2R-48	G0576113-54	Condu
2R-47	G0576119-54	Condu
2R-46	G0576119-54	Conde
2R-45	G0576119-54	Conde
2R-44	D20467003TU	Resista
2R-43	D20467003TU	Resista
2R-42	D20467003TU	Resista
2R-41	D20467003TU	Resista
2R-40	D20467003TU	Resista
2R-39	D20467003TU	Resista
2R-38	D20467003TU	Resista
2R-37	D20467003TU	Resista
2R-36	D20467003TU	Resista
2R-35	D20467003TU	Resista
2R-34	D20467003TU	Resista
2R-33	D20467003TU	Resista
2R-32	D20467003TU	Resista
2R-31	D20467003TU	Resista
2R-30	D20467003TU	Resista
2R-29	D20467003TU	Resista
P05 No	Designation	

ARCz
Wiring dia

(5)

S-E-C-R-E-T

NO FOREIGN DISSEM

NO FOREIGN DISSEM

50X1-HUM

	NTUMEP660-47	Wire 1614-0.35 mm ²	2m
	NTUMEP662-47	Wire 1614-0.5 mm ²	2.6m
	NTUMEP673-47	Wire 82NE50.35 mm ²	0.5m
	SINE 278-43	Wire 0.5 mm ²	0.5m
	NTUMEP673-47	Chloroform sleeve 4.25 mm	0.5m
	TU Rospramco 751	Linkosyl	0.4m
	TU Rospramco 751	Linkosyl	0.2m
	TU Rospramco 751	Linkosyl	0.2m
	TU Rospramco 751	Chloroform sleeve 4.25 mm	0.3m
	2D1-7 TJ-2135909	choke 12a	1
	2D1-6 TJ-2135909	choke 12a	1
35 and heater	2D1-5 TJ-2135909	choke 12a	1
80-47	2D1-4 TJ-2135909	choke 12a	1
le length	2C-47 GOST 6119-54	Condenser K50-5-500-B-1000-1	1
73-47	2C-46 GOST 6119-54	Condenser KTK-1-M-10-1	1
per wire	2C-45 GOST 6119-54	Condenser K50-5-500-B-5600-1	1
on wires marked	2C-43 GOST 6119-54	Condenser K50-5-250-B-1000-1	1
	2C-42 GOST 6119-54	Condenser K50-5-250-B-100-1	1
incow-7:51	2C-39 GOST 6119-54	Condenser KTK-1-M-10-1	1
	2C-38 GOST 6119-54	Condenser KTK-1-M-10-1	1
	2C-37 GOST 6119-54	Condenser K50-2-500-1000-1	1
	2C-36 GOST 6119-54	Condenser K50-1-250-B-220-1	1
	2C-35 GOST 6119-54	Condenser K50-2-500-B-1000-1	1
	2C-34 GOST 6119-54	Condenser K50-2-500-B-1000-1	1
	2C-33 GOST 6119-54	Condenser K50-1-250-B-100-1	1
	2C-32 GOST 6119-54	Condenser K50-1-250-B-100-1	1

7 details

S-E-C-R-E-T

NO FOREIGN DISSEM

50X1-HUM

Remarks:

1. Montage should be made according to WT.
2. Connections should be done with wire MGW-035 and heater circuits with MGW-0.5 mm² (yellow) WTU-MEP 680-47.
3. Chlorovinyl sleeves $\phi 3.3$ should be put on whole length of screened wires BPWLE-035 mm² WTU-MEP 673-47.
4. Connections "a" should be done with tinned copper wire $\phi 0.5$ mm WNE278-43 and sleeves should be put on wires marked 32-48.
5. On leads b" from details $\phi 1$ sleeves TU Rospromcow-7-51 should be put on.
6. $\phi 3.1$ mm sleeves should be put on details 2R-38, 48, 49, 51, 45, 36, 62, 63.
 $\phi 6.1$ mm chlorovinyl sleeves should be put on details 2R-39, 47, 55.

⑧

WTU-MEP 680-47	Wire 350
WTU-MEP 680-37	Wire 400
WTU-MEP 680-47	Wire 350
WNE 278-43	Wire 600
WTU-MEP 673-47	Wire 350
TU Rospromcow-7-51	Wire 400
TU Rospromcow-7-51	Wire 400
TU Rospromcow-7-51	Wire 400
TU Rospromcow-7-51	Wire 400
2R-37 2135909	Choke 120
2R-38 2135909	Choke 120
2R-39 2135909	Choke 120
2R-40 2135909	Choke 120
2R-41 2135909	Choke 120
2R-42 2135909	Choke 120
2R-43 2135909	Choke 120
2R-44 2135909	Choke 120
2R-45 2135909	Choke 120
2R-46 2135909	Choke 120
2R-47 2135909	Choke 120
2R-48 2135909	Choke 120
2R-49 2135909	Choke 120
2R-50 2135909	Choke 120
2R-51 2135909	Choke 120
2R-52 2135909	Choke 120
2R-53 2135909	Choke 120
2R-54 2135909	Choke 120
2R-55 2135909	Choke 120
2R-56 2135909	Choke 120
2R-57 2135909	Choke 120
2R-58 2135909	Choke 120
2R-59 2135909	Choke 120
2R-60 2135909	Choke 120
2R-61 2135909	Choke 120
2R-62 2135909	Choke 120
2R-63 2135909	Choke 120
2R-64 2135909	Choke 120
2R-65 2135909	Choke 120
2R-66 2135909	Choke 120
2R-67 2135909	Choke 120
2R-68 2135909	Choke 120
2R-69 2135909	Choke 120
2R-70 2135909	Choke 120

S-E-C-R-E-T
 NO FOREIGN DISSEM

NO FOREIGN DISSEM

50X1-HUM

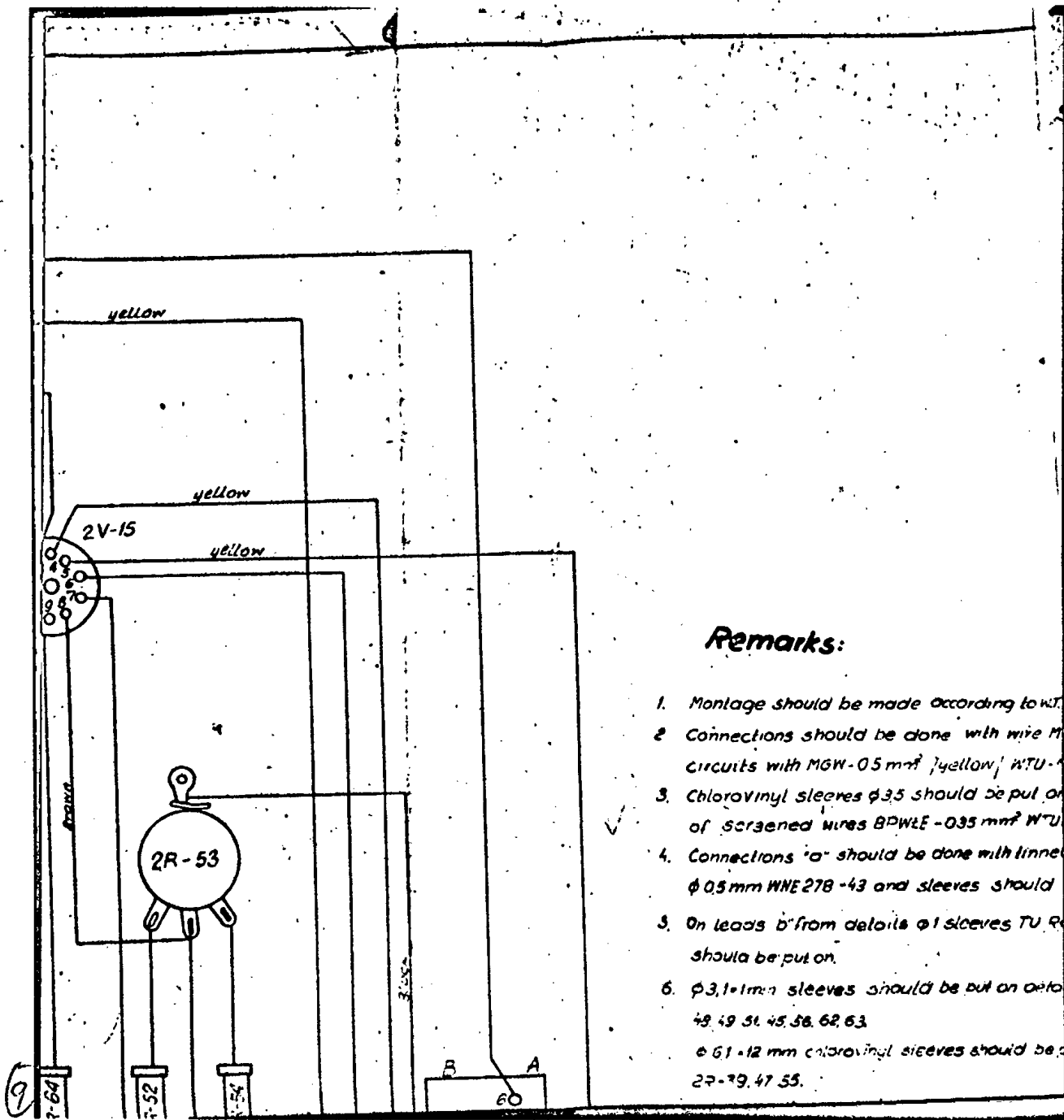

Remarks:

1. Montage should be made according to WT.
2. Connections should be done with wire M circuits with MGW-05 mm² yellow WTU-4.
3. Chloro-vinyl sleeves $\phi 3.5$ should be put on of screened wires BPWE-035 mm² WTU.
4. Connections "a" should be done with linner $\phi 0.5$ mm WNE 278-43 and sleeves should
5. On leads b from details $\phi 1$ sleeves TU R should be put on.
6. $\phi 3.1$ mm sleeves should be put on onto 49, 49, 51, 45, 58, 62, 63. $\phi 6.1$ mm chloro-vinyl sleeves should be 27-79, 47, 55.

S-E-C-R-E-T

NO FOREIGN DISSEM

NO FOREIGN DISSEM

50X1-HUM

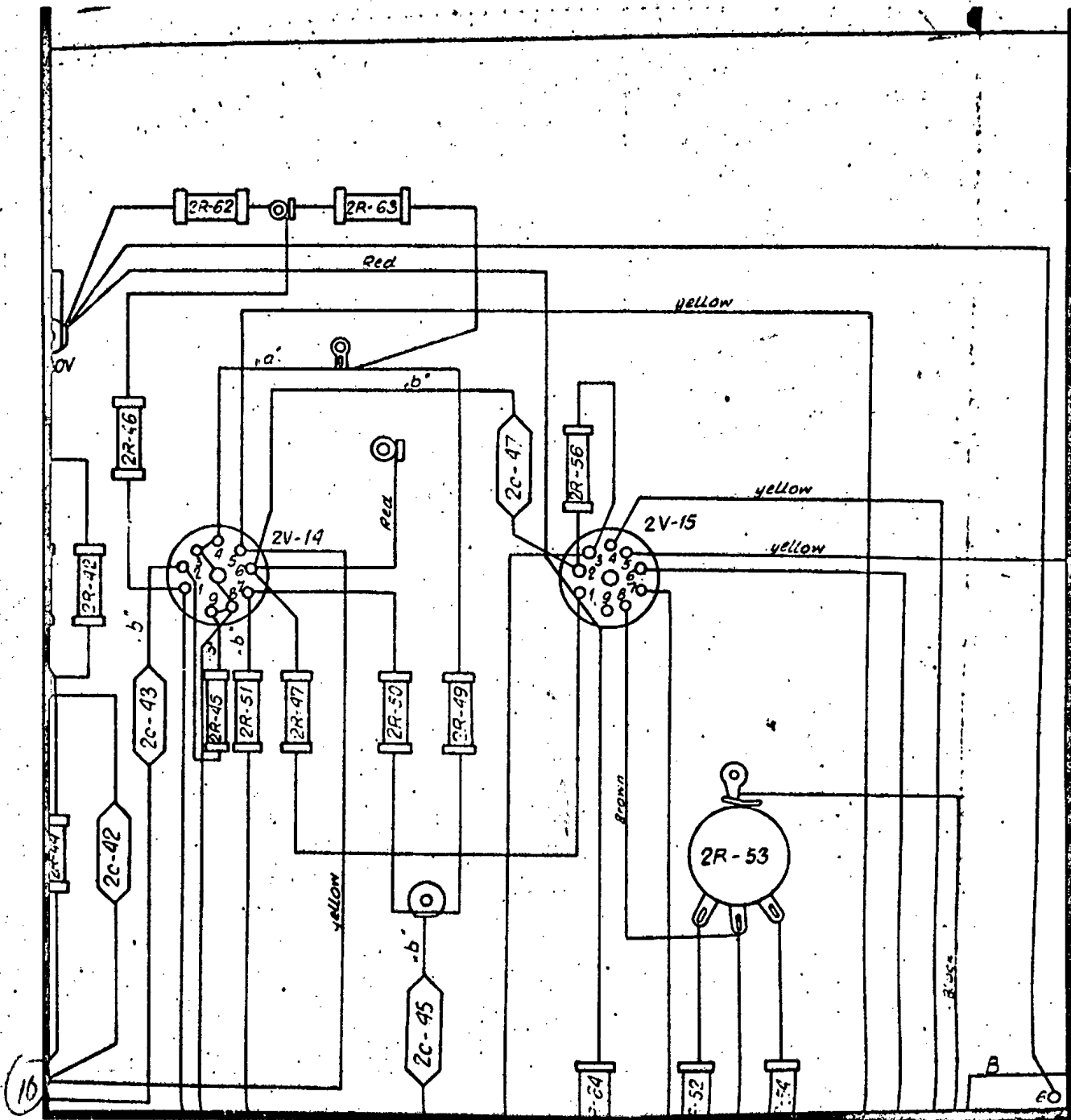

S-E-C-R-E-T

NO FOREIGN DISSEM

50X1-HUM

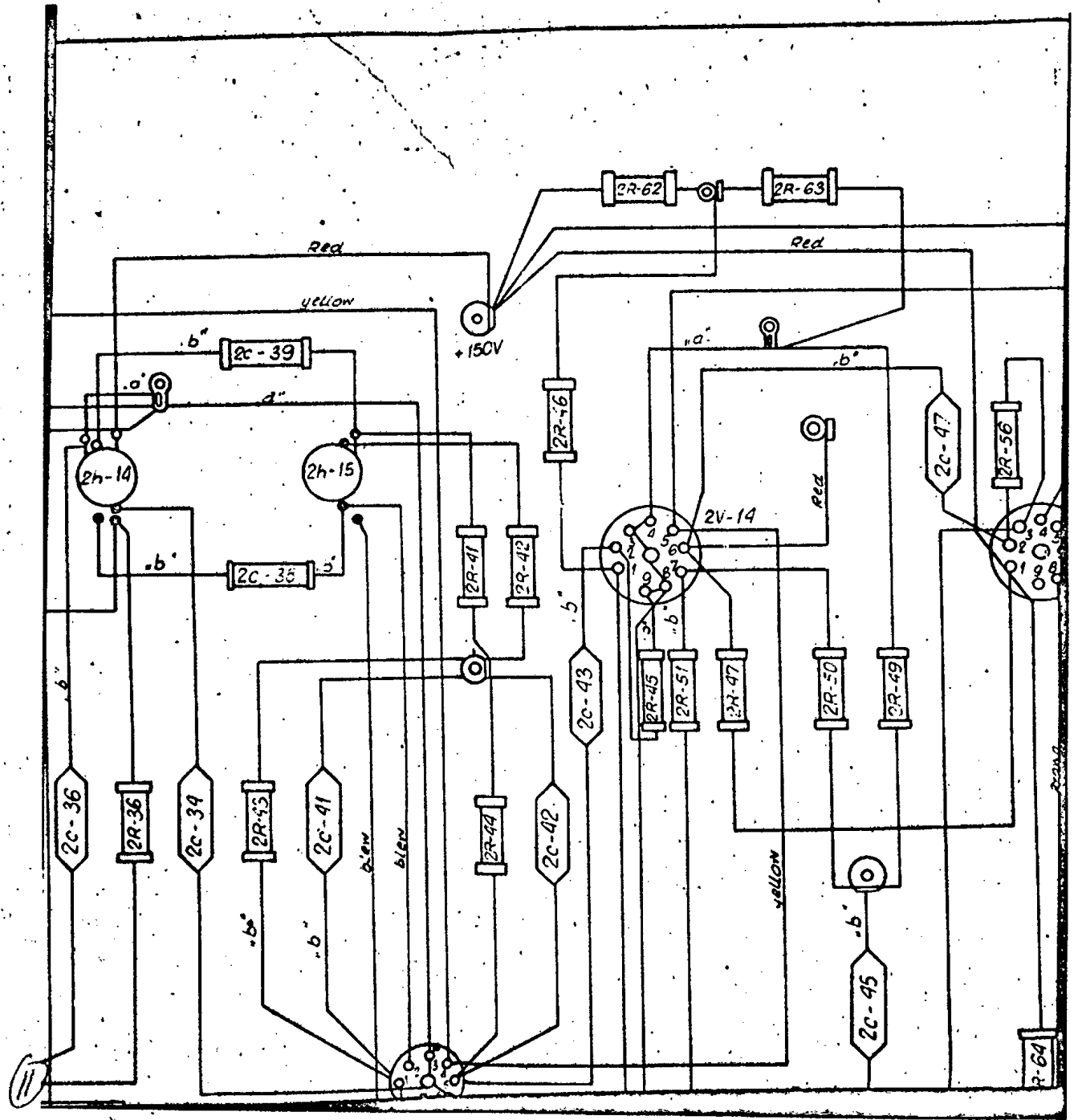

S-E-C-R-E-T
NO FOREIGN DISSEM

NO FOREIGN DISSEM



50X1-HUM

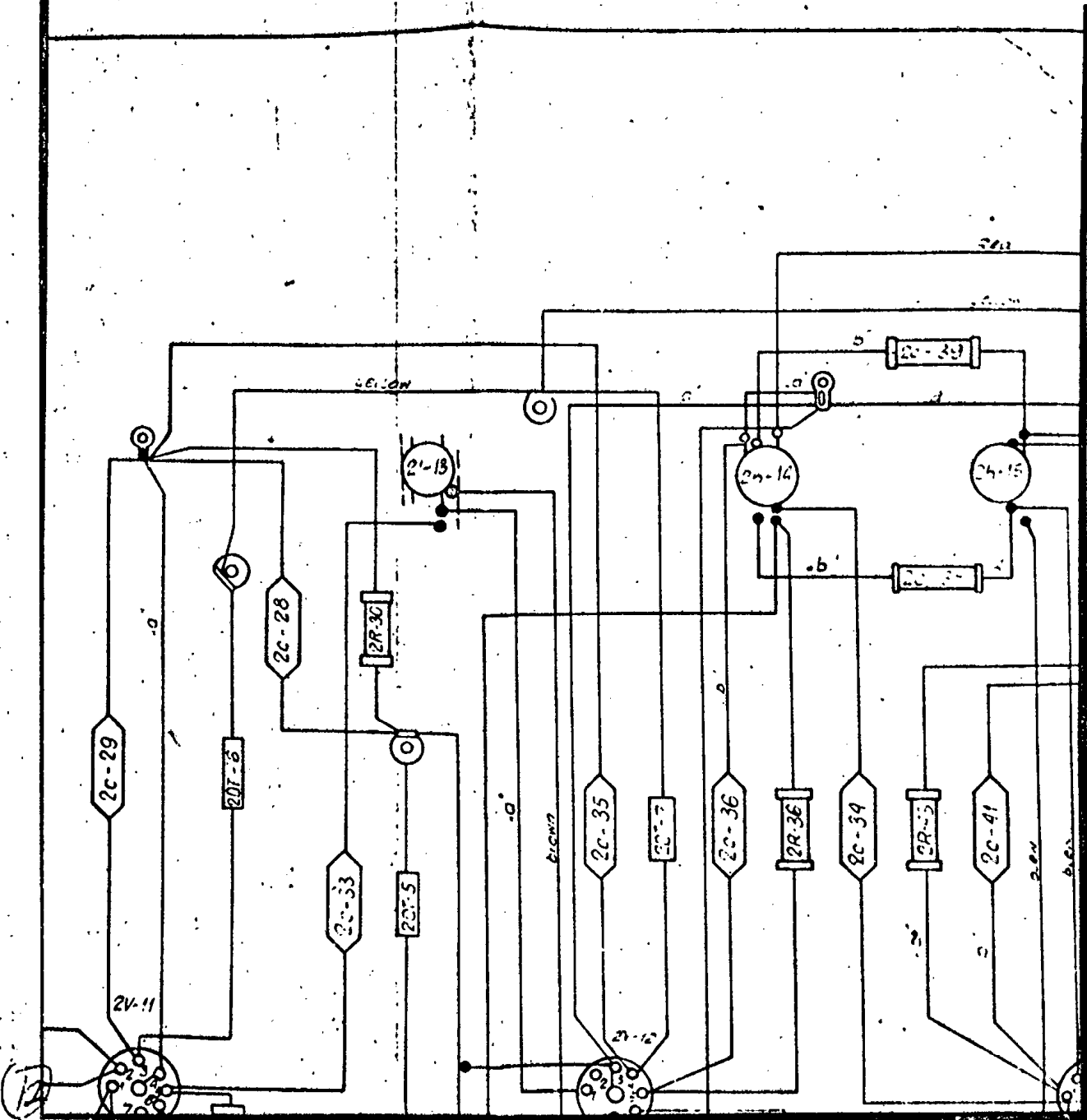

S-E-C-R-E-T
NO FOREIGN DISSEM

50X1-HUM

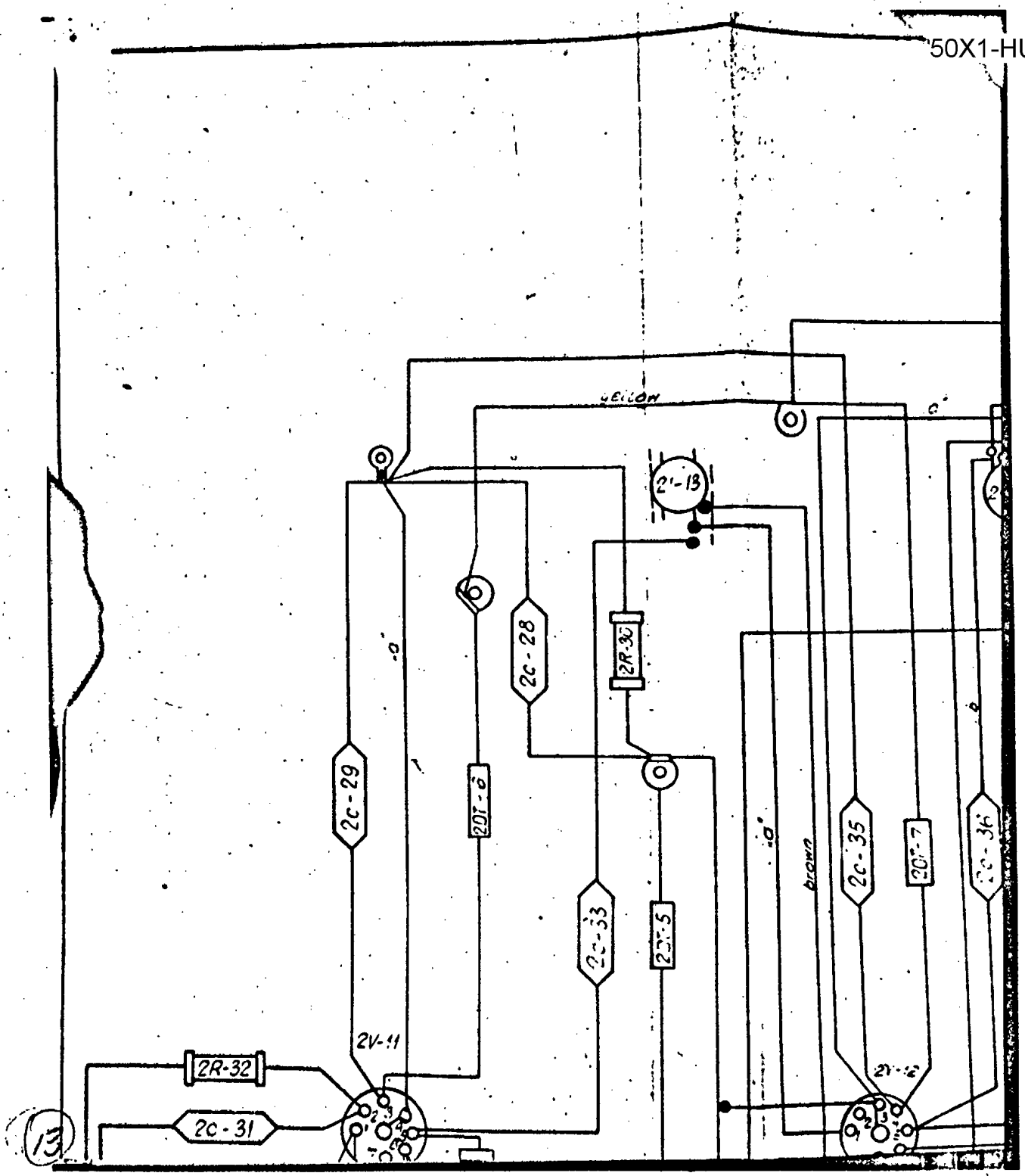

S-E-C-R-E-T
NO FOREIGN DISSEM

NO FOREIGN DISSEM

50X1-HUM

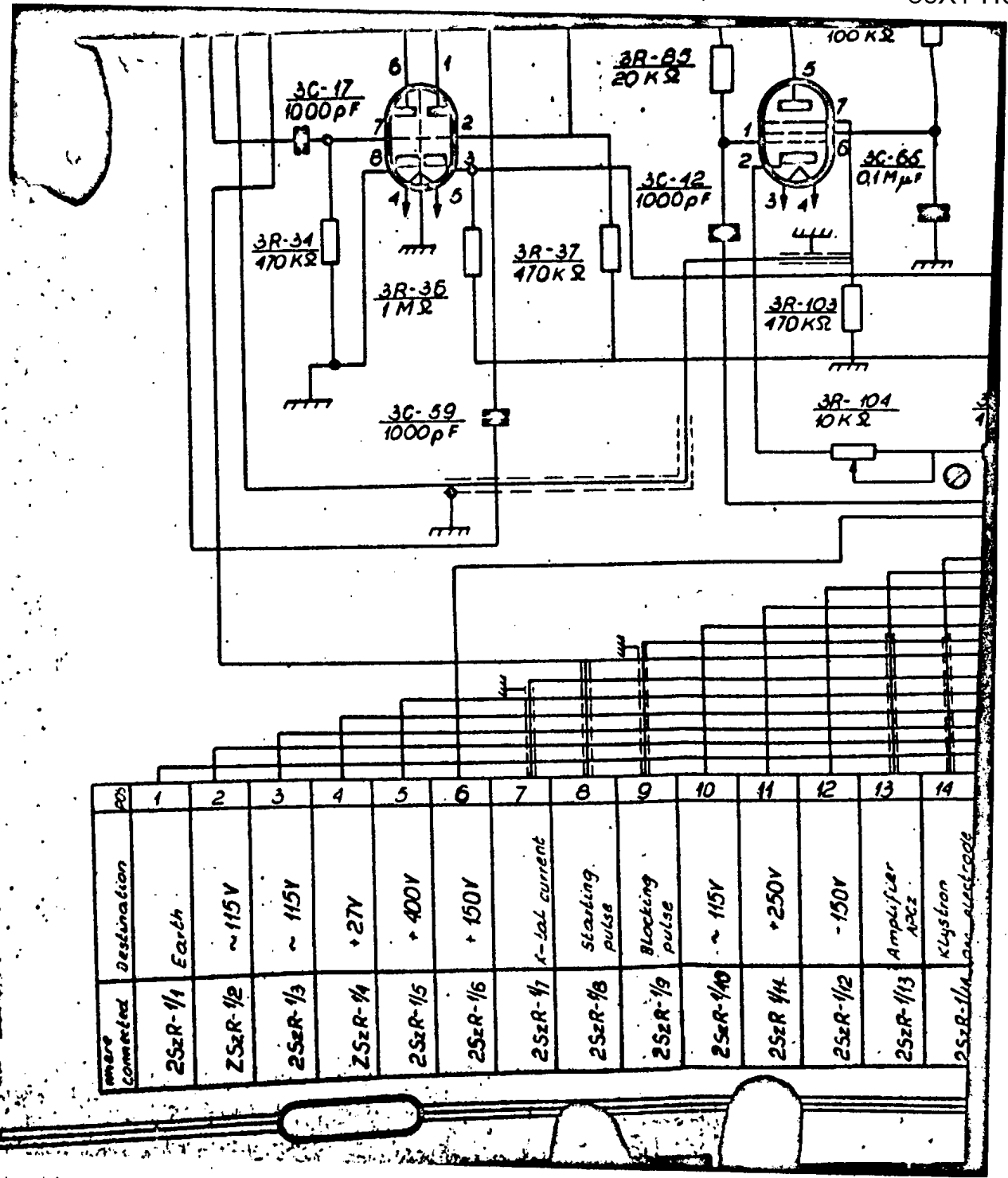

S-E-C-R-E-T

NO FOREIGN DISSEM

NO FOREIGN DISSEM

50X1-HUM

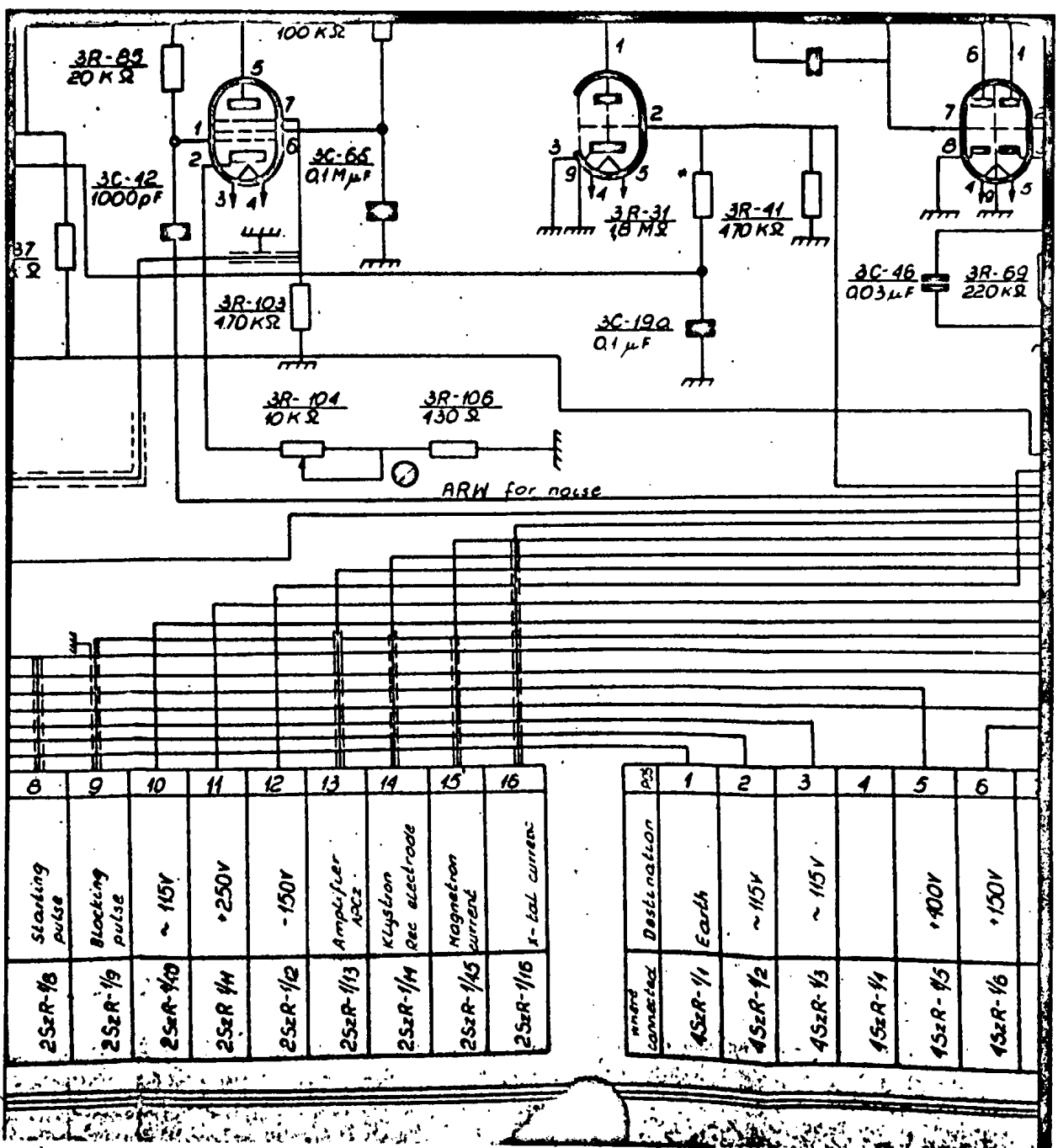

S-E-C-R-E-T

NO FOREIGN DISSEM

NO FOREIGN DISSEM

50X1-HUM

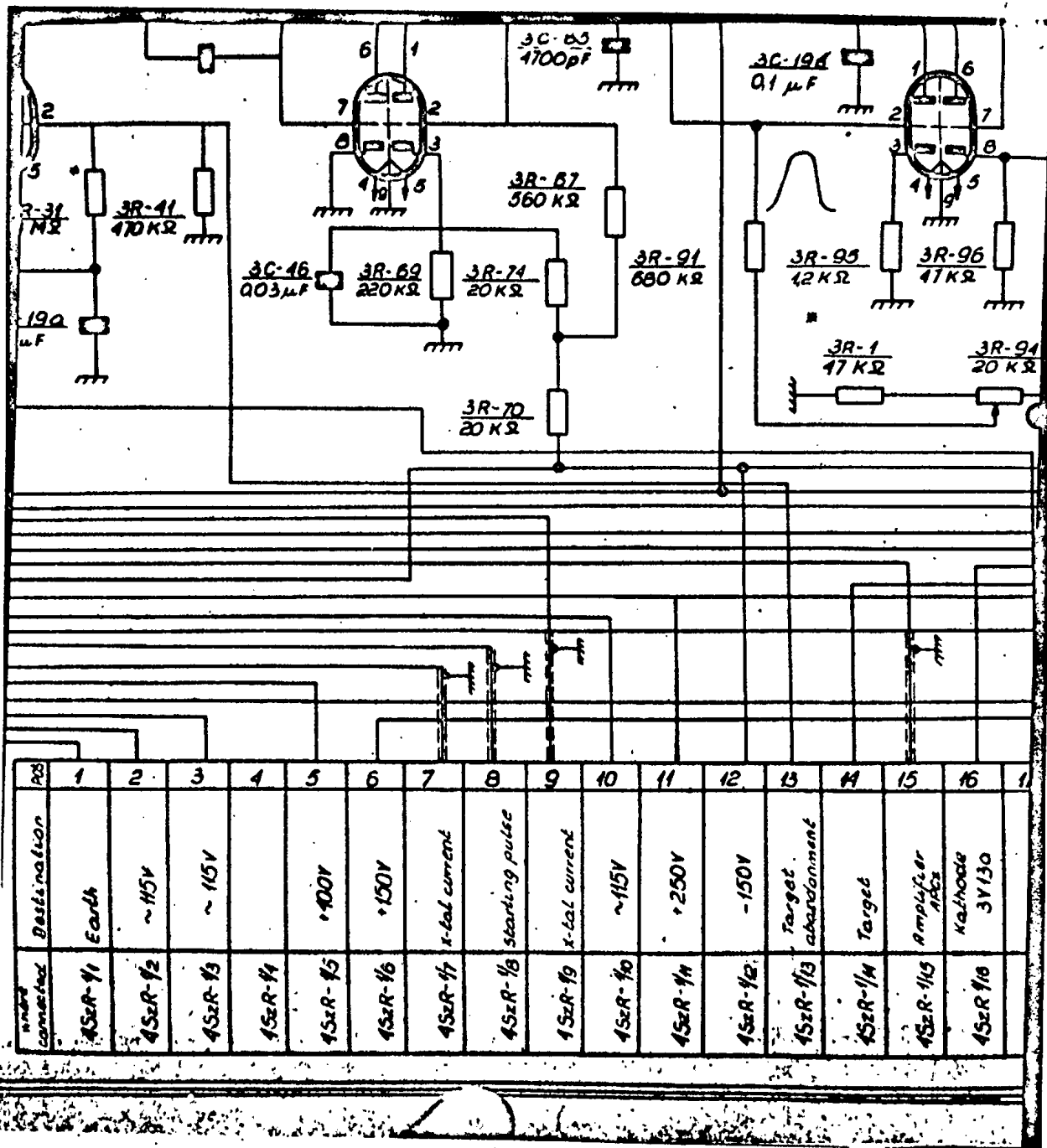

S-E-C-R-E-T

NO FOREIGN DISSEM

50X1-HUM

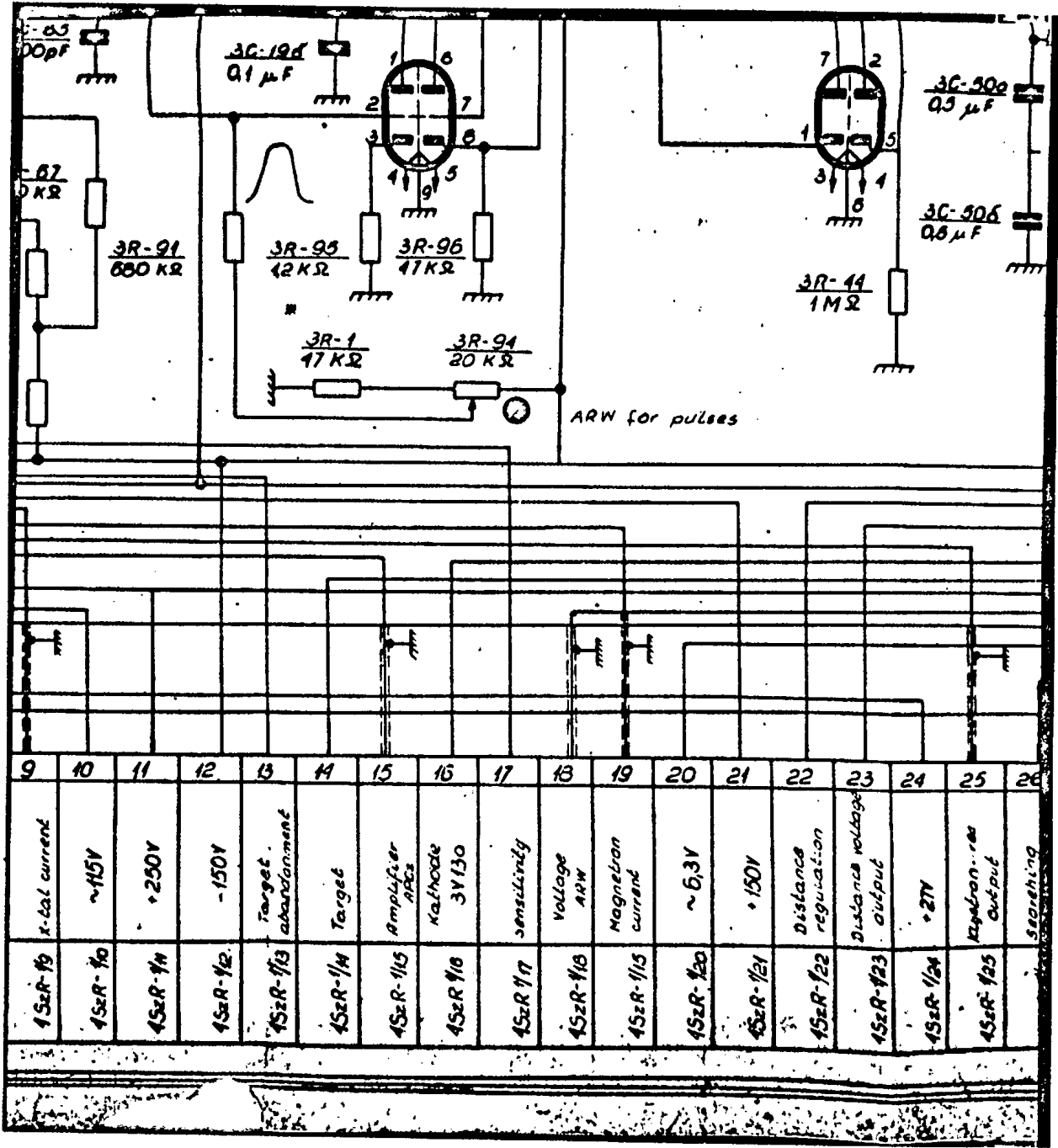

S-E-C-R-E-T
 NO FOREIGN DISSEM

NO FOREIGN DISSEM

50X1-HUM

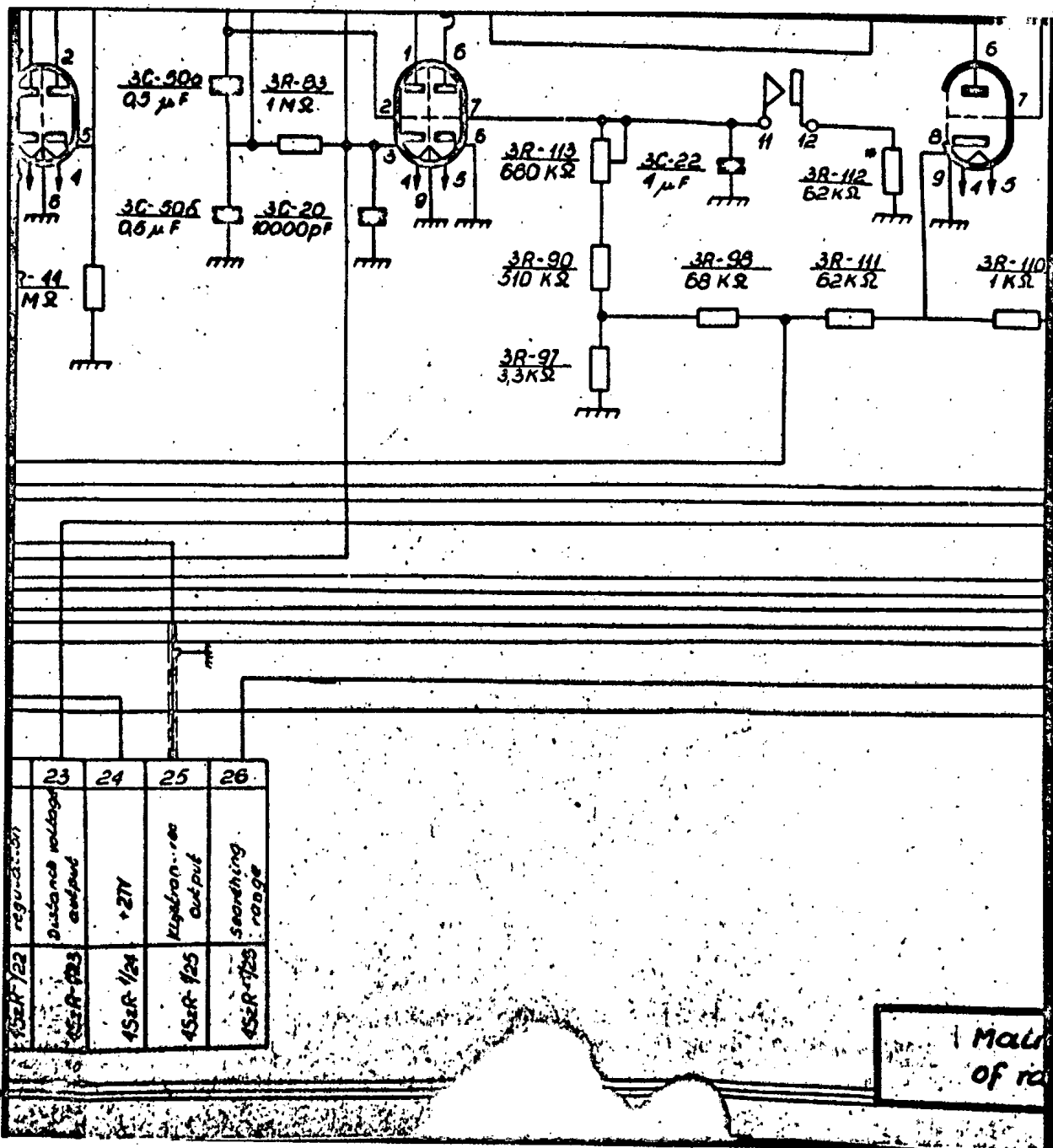

S-E-C-R-E-T

NO FOREIGN DISSEM

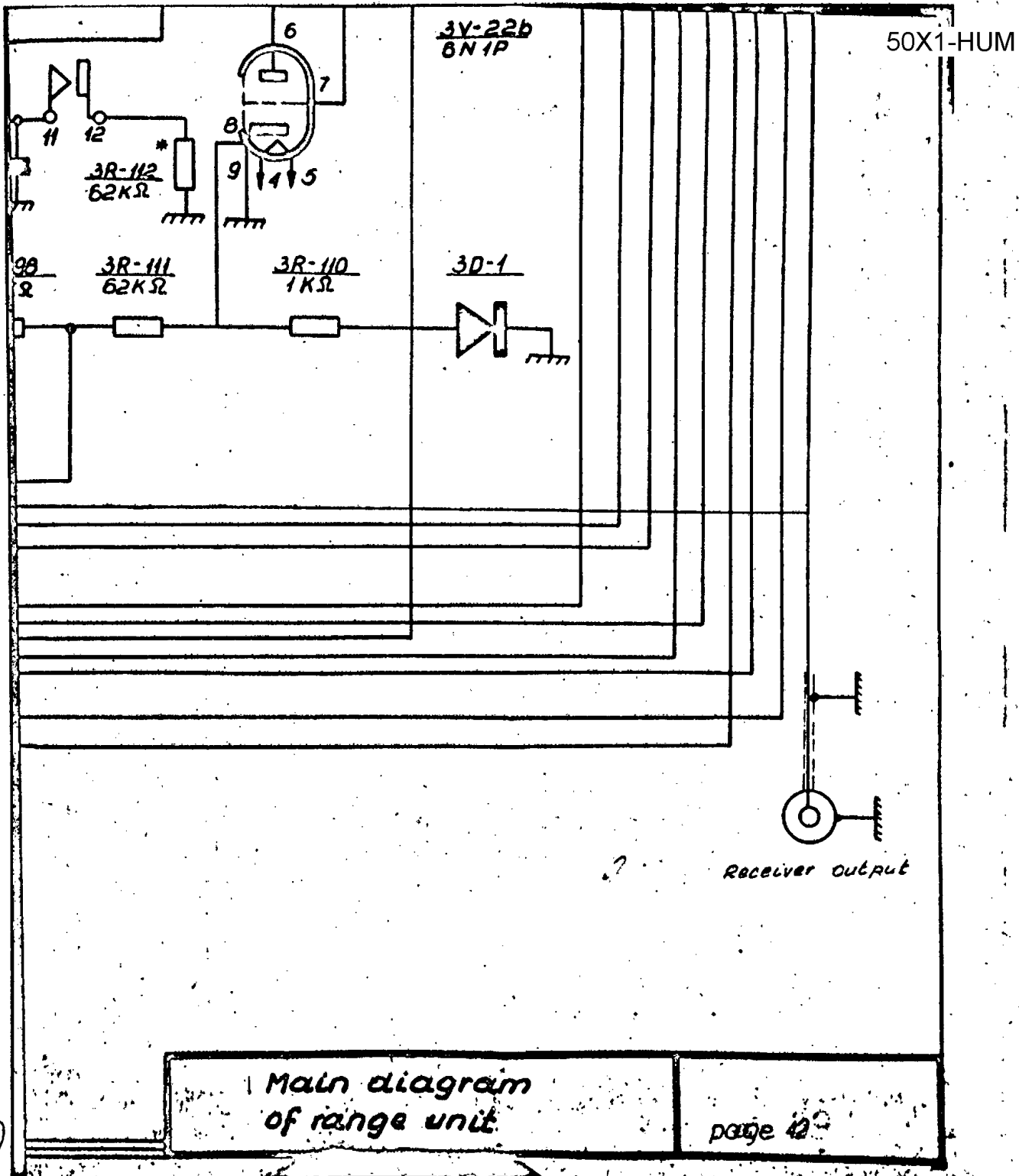

Main diagram of range unit

S-E-C-R-E-T
NO FOREIGN DISSEM

NO FOREIGN DISSEM

50X1-HUM

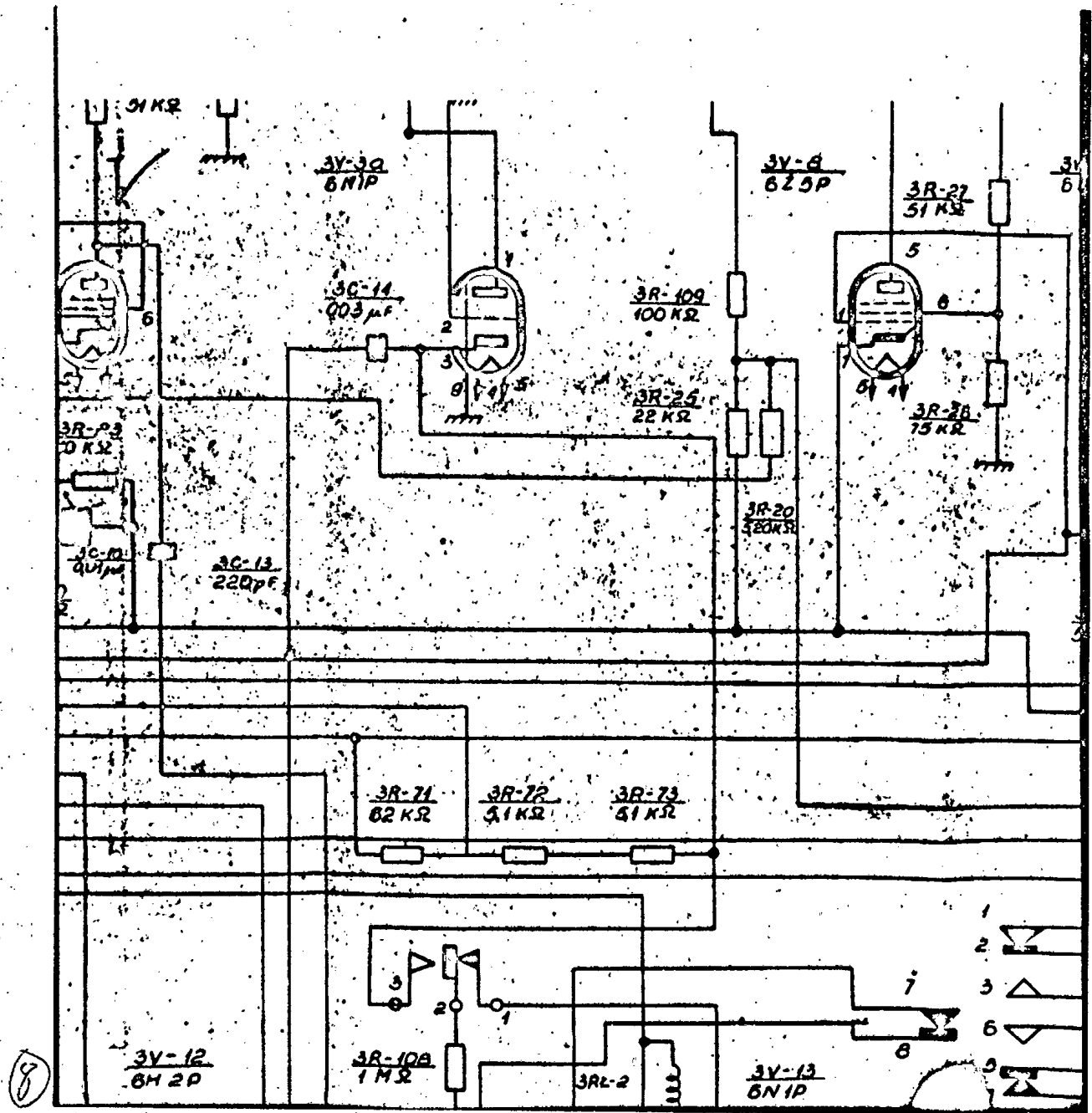

S-E-C-R-E-T

NO FOREIGN DISSEM

NO FOREIGN DISSEM

50X1-HUM

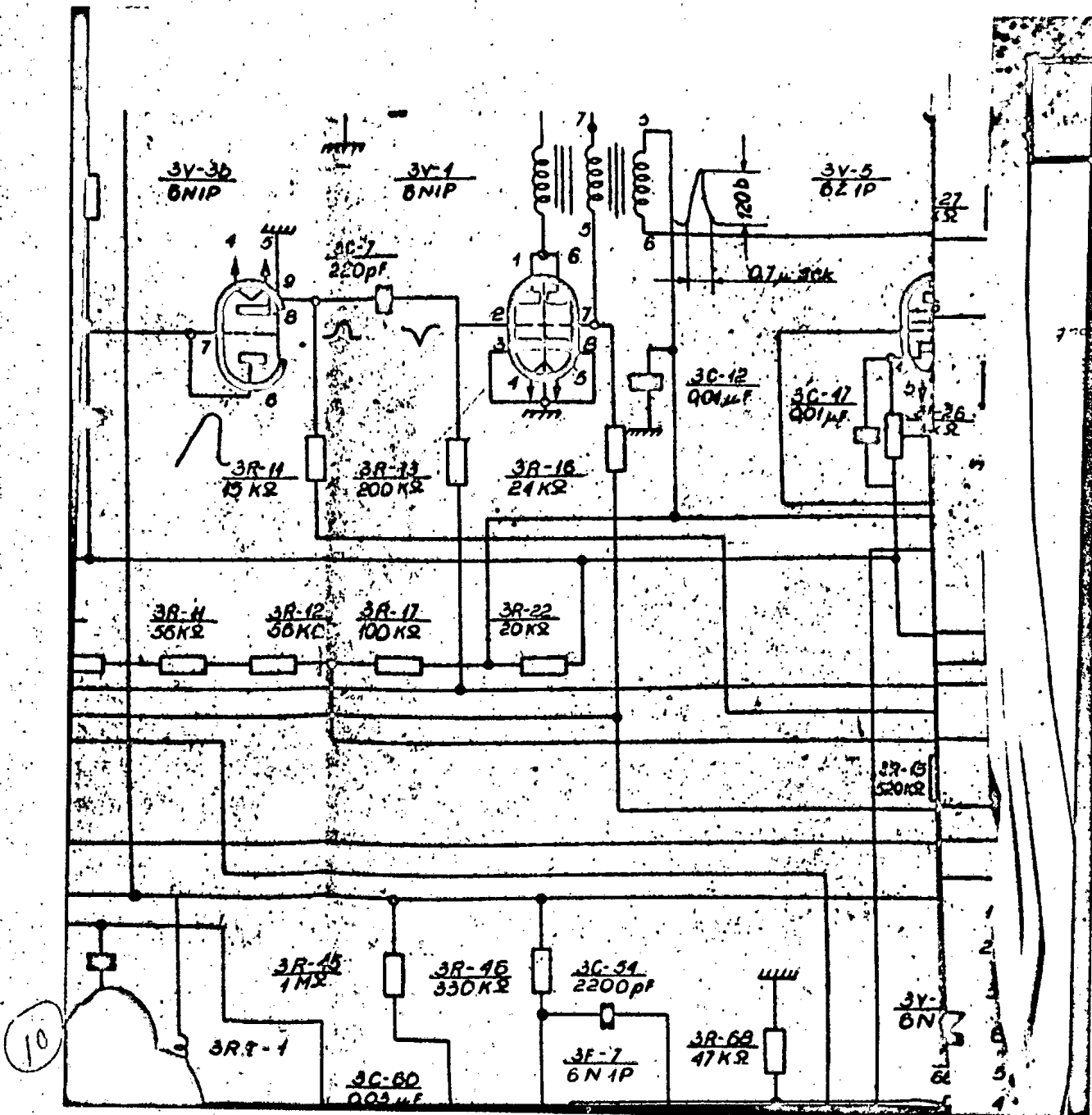

S-E-C-R-E-T

NO FOREIGN DISSEM

50X1-HUM

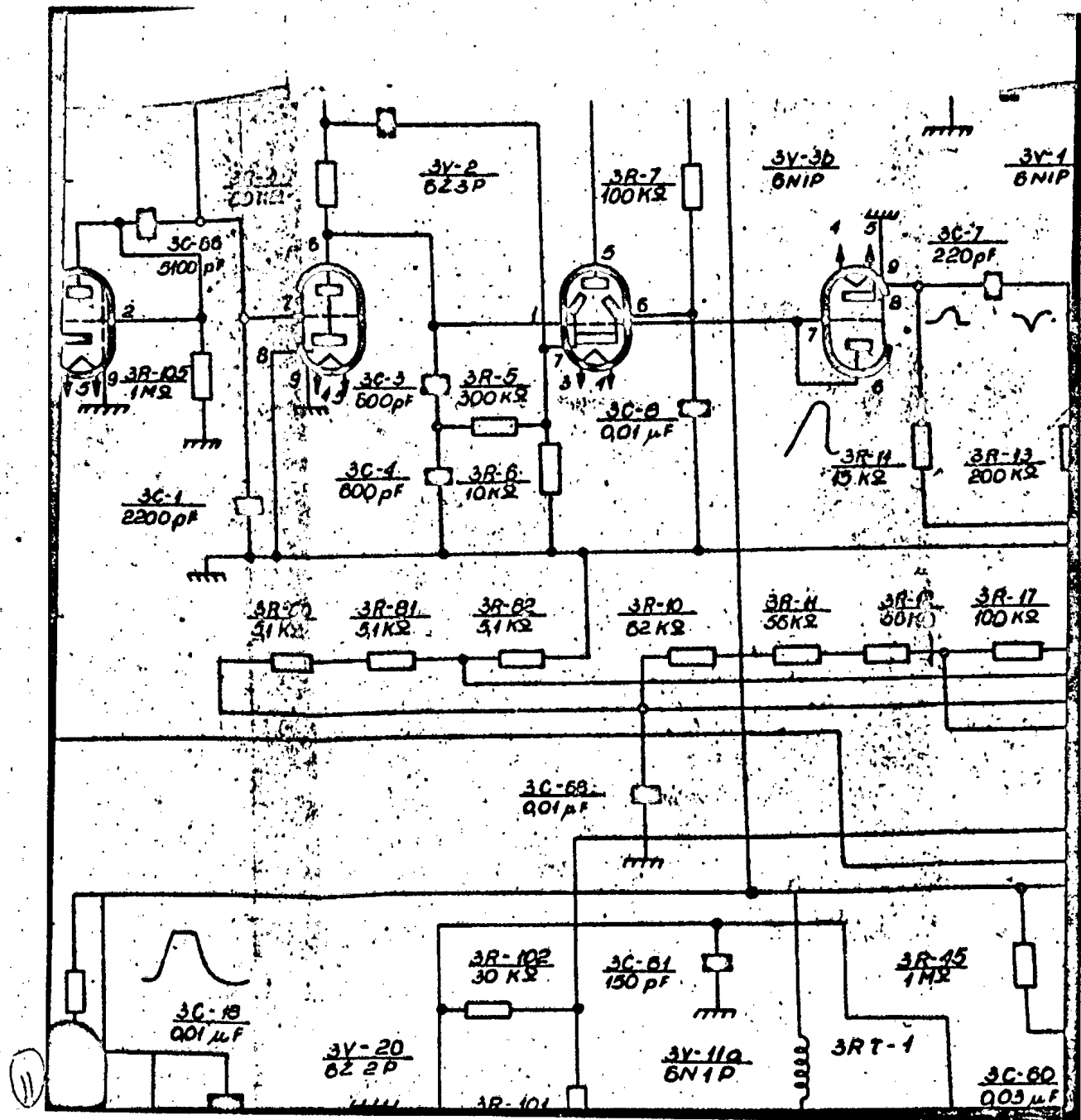

S-E-C-R-E-T
NO FOREIGN DISSEM

NO FOREIGN DISSEM

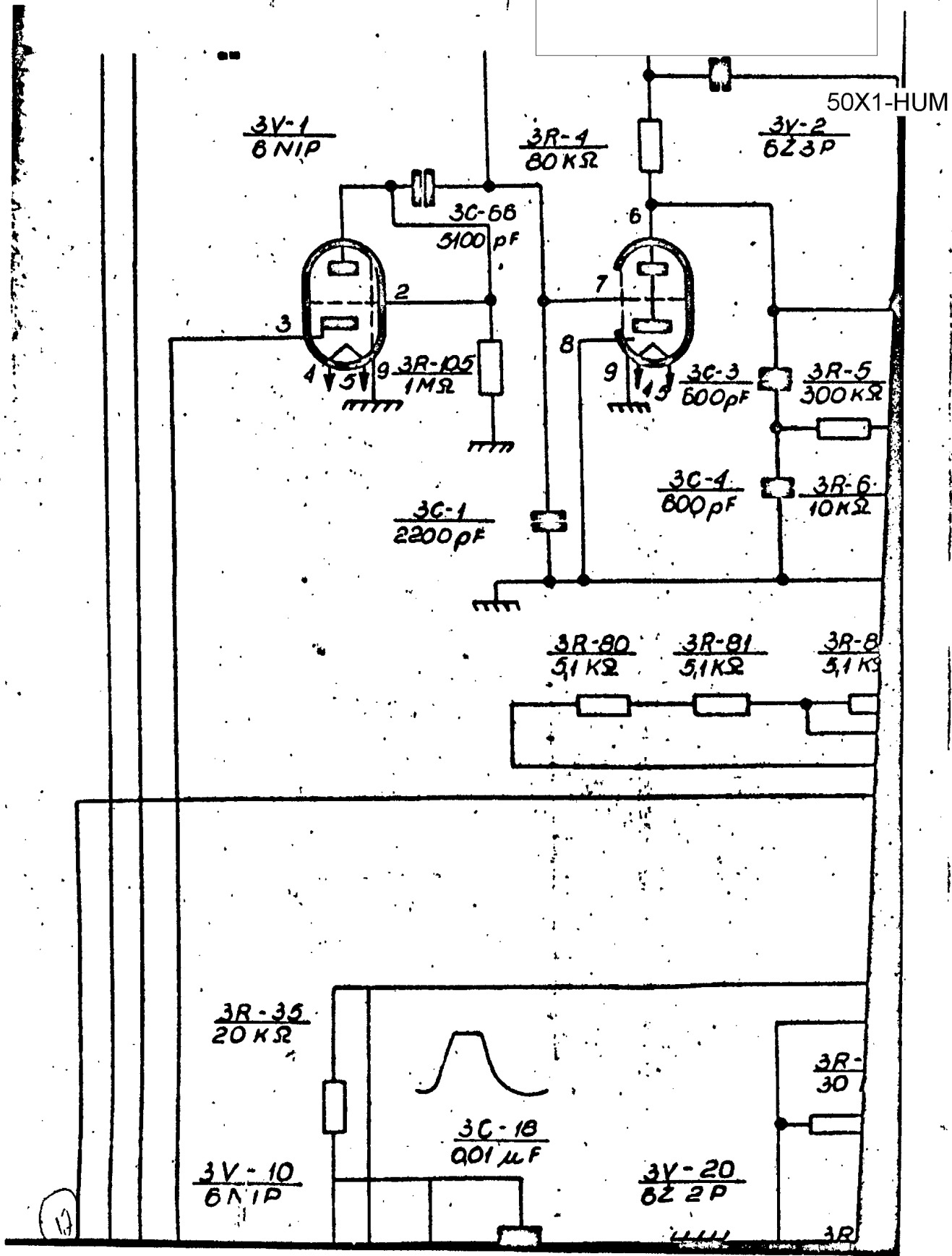

S-E-C-R-E-T

NO FOREIGN DISSEM

50X1-HUM

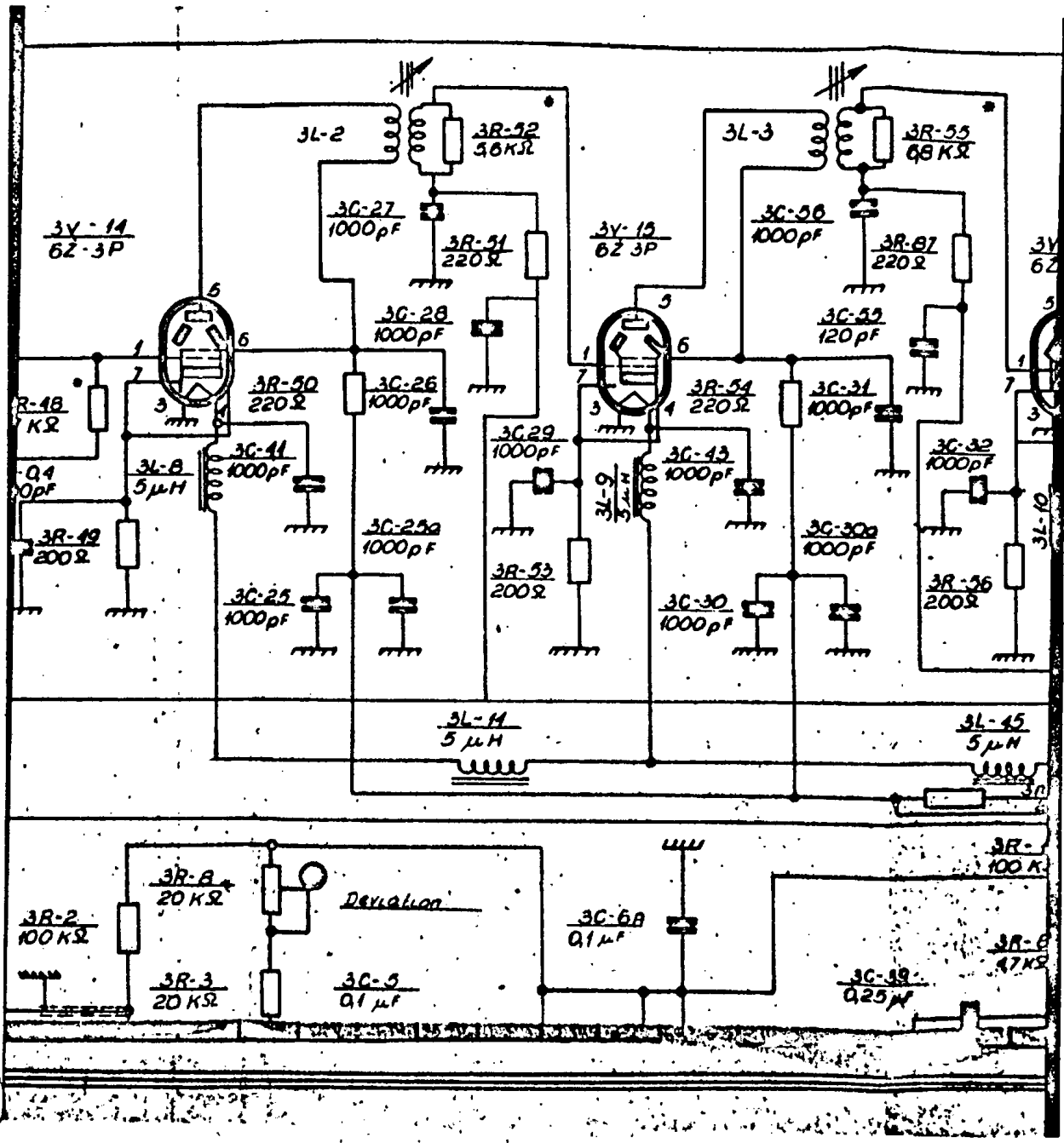

114

S-E-C-R-E-T
NO FOREIGN DISSEM

S-E-C-R-E-T
NO FOREIGN DISSEM

50X1-HUM

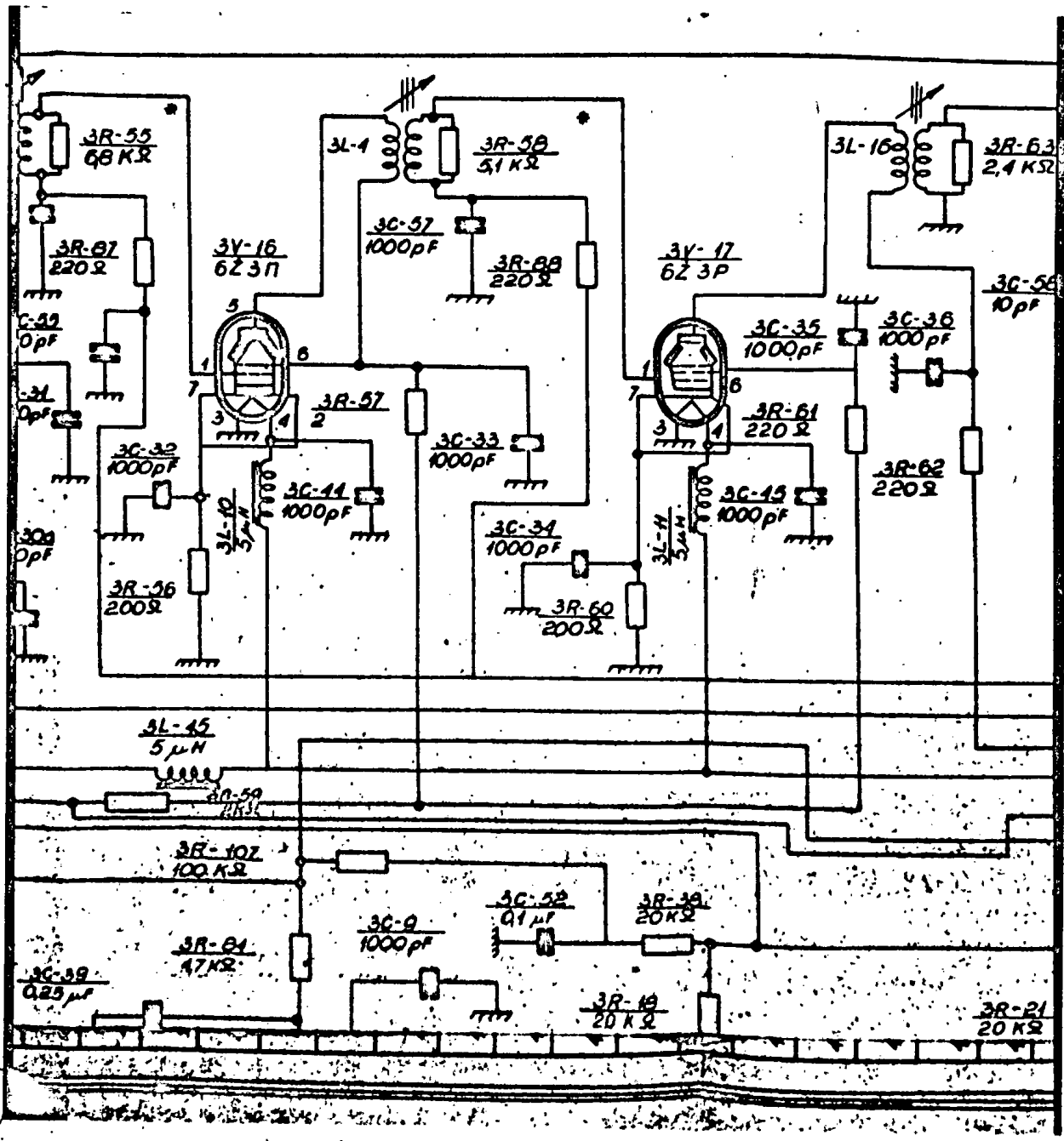

S-E-C-R-E-T
NO FOREIGN DISSEM

50X1-HUM

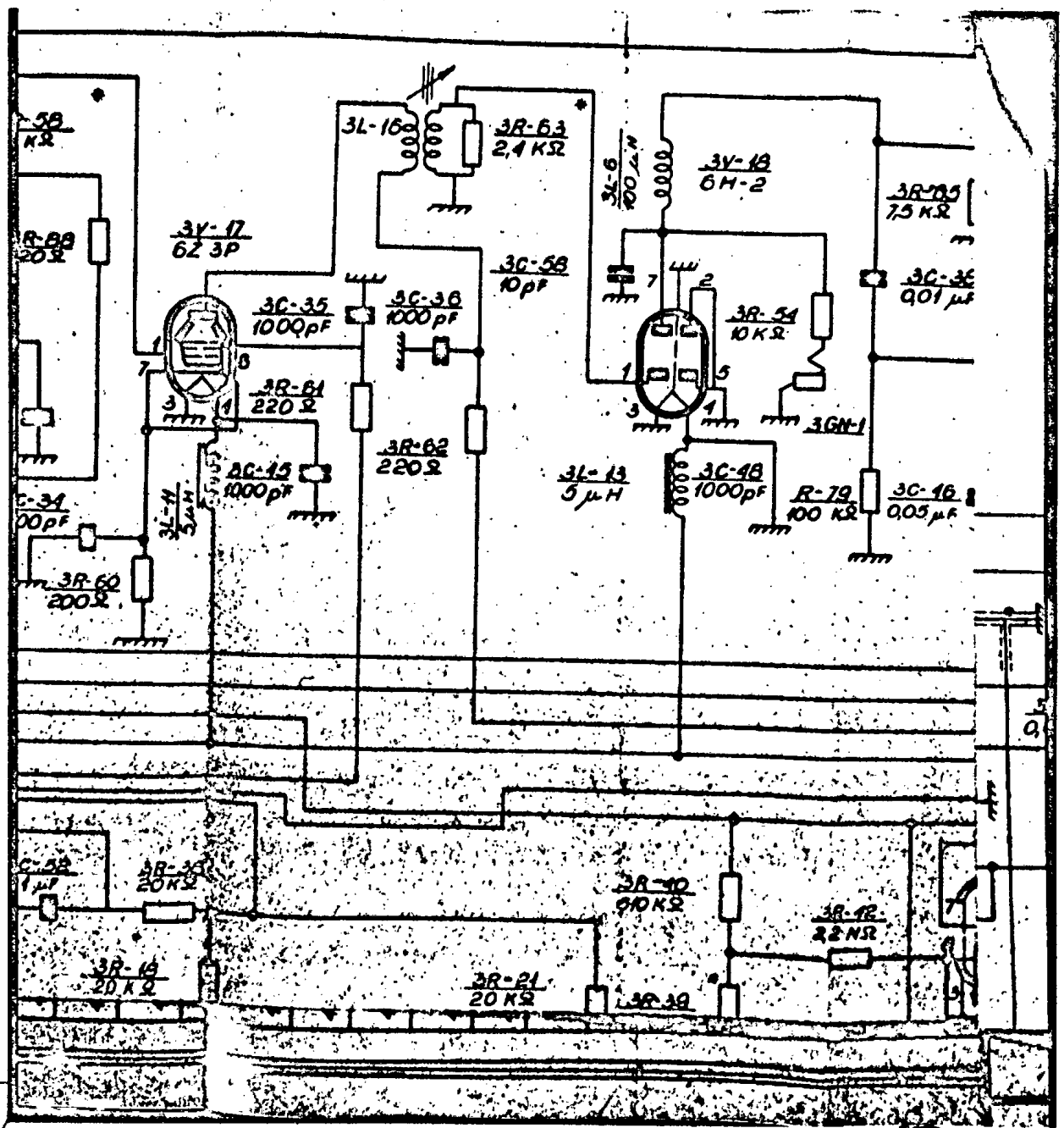

16

S-E-C-R-E-T
NO FOREIGN DISSEM

NO FOREIGN DISSEM

50X1-HUM

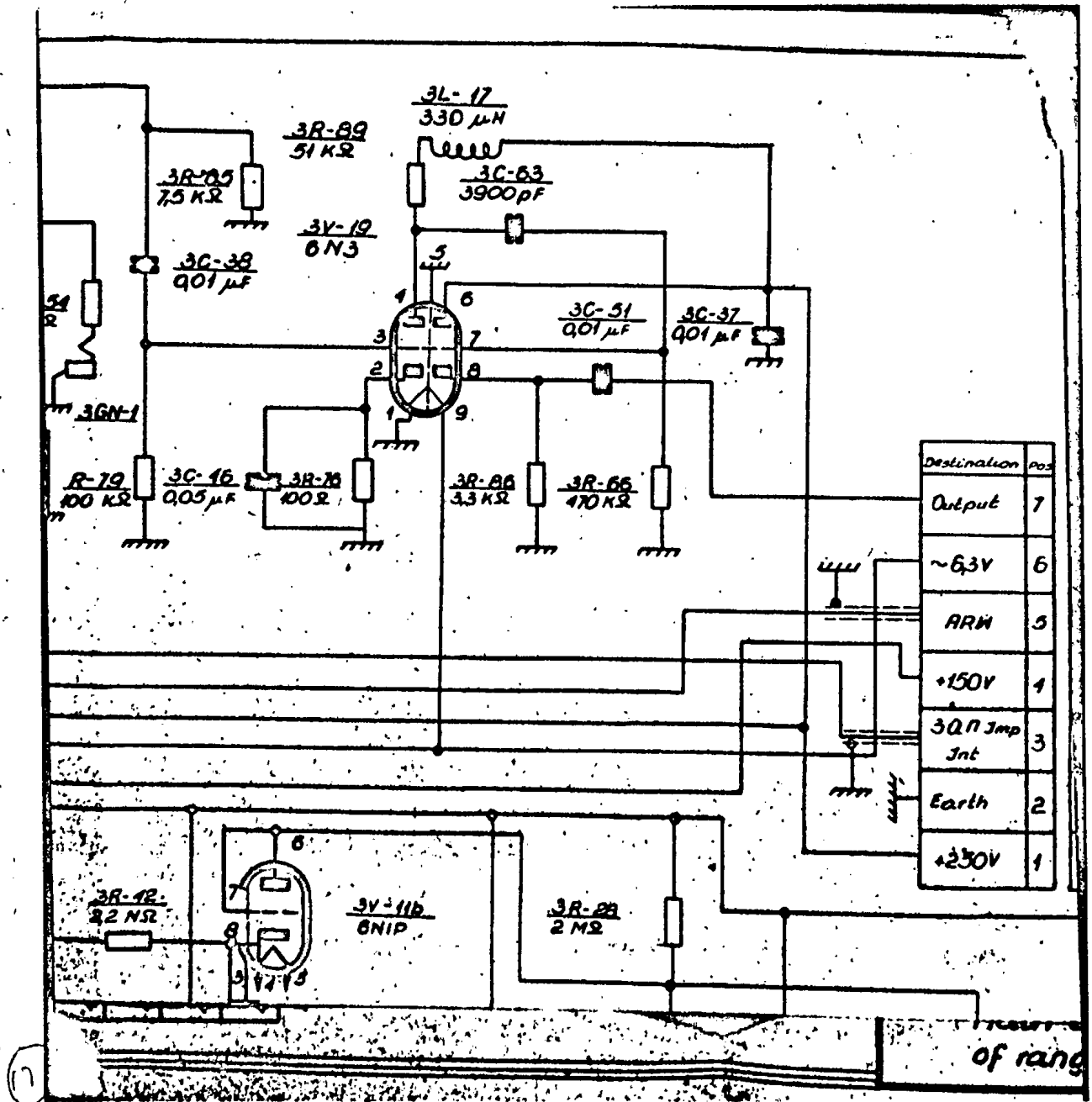

S-E-C-R-E-T

NO FOREIGN DISSEM

NO FOREIGN DISSEM

50X1-HUM

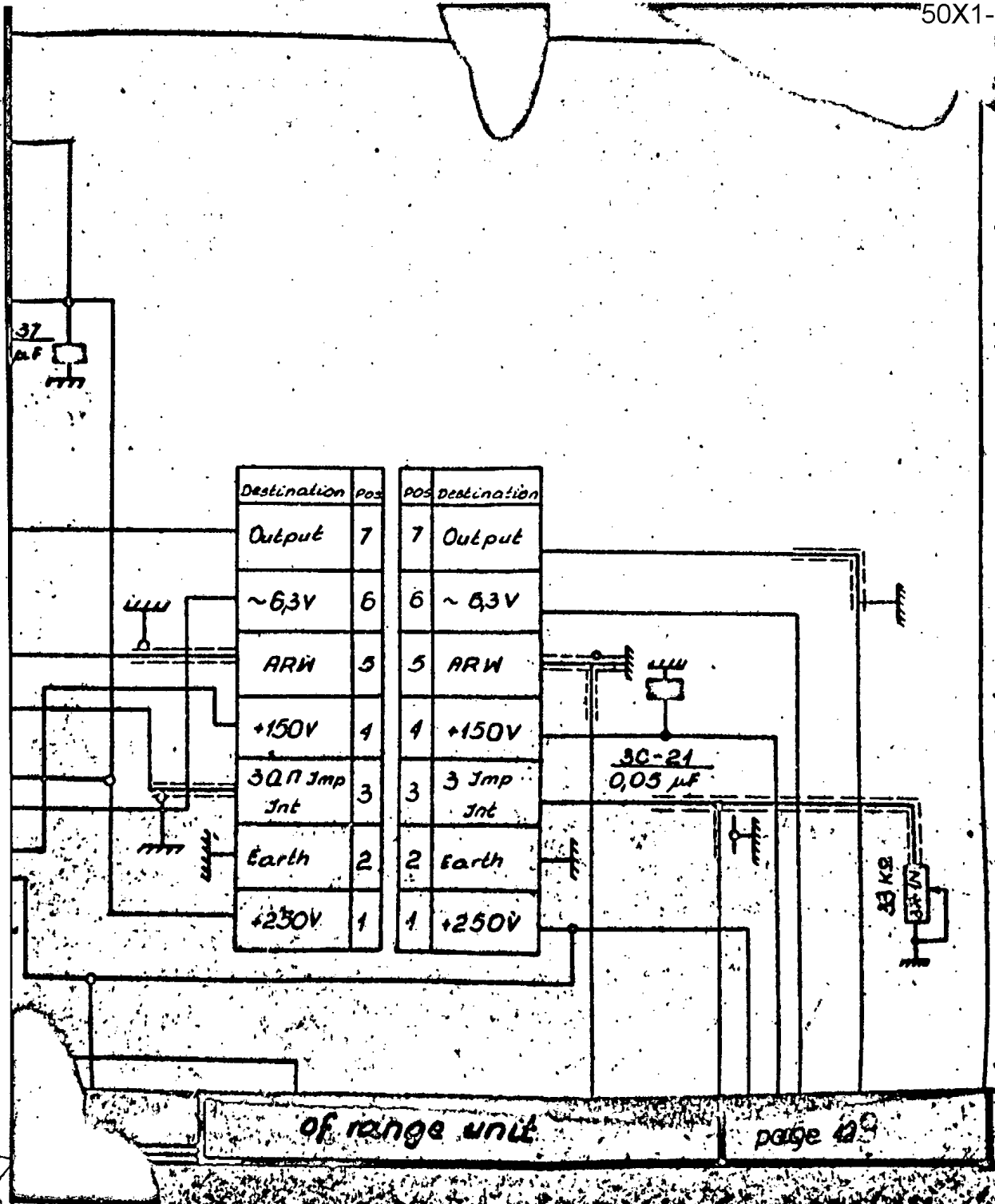

S-E-C-R-E-T

NO FOREIGN DISSEM

NO FOREIGN DISSEM

List of items

Pos	COLT, WTU, file form.	Name and type	Value	Qty	Remarks
PR-1	OZ0457003TU	Resistor MIT-1-47K Ω -II	47K Ω	1	6
PR-2	OZ0457003TU	" MIT-1-100K Ω -II	100K Ω	1	
PR-3					
PR-4					
PR-5	OZ0457003TU	" MIT-1-300K Ω -II	300K Ω	1	
PR-6	OZ0457003TU	" MIT-2-10K Ω -II	10K Ω	1	
PR-7	OZ0457003TU	" MIT-1-100K Ω -II	100K Ω	1	
PR-8	WT4585006	" PP3-11-20-II	20K Ω	1	
PR-10	WP4-575-001	" PT-1 \pm 1%	62K Ω	1	
PR-11	WP4-575-001	" PT-1 \pm 1%	56K Ω	1	
PR-12	WP4-575-001	" PT-1 \pm 1%	56K Ω	1	
PR-13	OZ0457003TU	" MIT-1-200K Ω -II	200K Ω	1	
PR-14	OZ0457003TU	" MIT-1-15K Ω -II	15K Ω	1	
PR-15	OZ0457003TU	" MIT-1-620K Ω -II	620K Ω	1	
PR-16	OZ0457003TU	" MIT-1-24K Ω -II	24K Ω	1	
PR-17	OZ0457003TU	" MIT-1-100K Ω -II	100K Ω	1	
PR-18	OZ0457003TU	" MIT-1-3,3K Ω -II	3,3K Ω	1	
PR-19	OZ0457003TU	" MIT-1-3,5K Ω -II	3,5K Ω	1	
PR-20	OZ0457003TU	" MIT-1-620K Ω -II	620K Ω	1	
PR-21	OZ0457003TU	" MIT-1-20K Ω -II	20K Ω	1	
PR-22	OZ0457003TU	" MIT-1-20K Ω -II	20K Ω	1	
PR-23	OZ0457003TU	" MIT-1-10K Ω -II	10K Ω	1	
PR-24	OZ0457003TU	" MIT-1-1K Ω -II	1K Ω	1	
PR-25	OZ0457003TU	" MIT-1-22K Ω -II	22K Ω	1	
PR-26	OZ0457003TU	" MIT-1-75K Ω -II	75K Ω	1	
PR-27	OZ0457003TU	" MIT-1-51K Ω -II	51K Ω	1	

43

S-E-C-R-E-T

NO FOREIGN DISSEM

NO FOREIGN DISSEM

50X1-HUM

1	2	3	4	5	6
3R-28	OZC457003TU	Resistor MET-1-2M Ω -II	2M Ω	1	
3R-29	OZC457003TU	" MET-1-510K Ω -II	510K Ω	1	
3R-30	OZC457003TU	" MET-1-3,3M Ω -II	3,3M Ω	1	
3R-31	OZC457003TU	" MET-1-1,8M Ω -II*	1,8M Ω	1	Checked after burning 1,8M Ω 5% 10%
3R-32	" T4.585.0062p	" MET-1-10K Ω -II	10K Ω	1	
3R-34	OZC457003TU	" MET-1-470K Ω -II	470K Ω	1	
3R-35	OZC457003TU	" MET-2-20K Ω -II	20K Ω	1	
3R-36	OZC457003TU	" MET-1-1M Ω -II	1M Ω	1	
3R-37	OZC457003TU	" MET-1-470K Ω -II	470K Ω	1	
3R-38	OZC457003TU	" MET-1-20K Ω -II	20K Ω	1	
3R-39	OZC457003TU	" MET-1-51K Ω -II *	51K Ω	1	33K Ω 10% 110K Ω 10%
3R-40	OZC457003TU	" MET-1-510K Ω -II	510K Ω	1	
3R-41	OZC457003TU	" MET-1-470K Ω -II	470K Ω	1	
3R-42	OZC457003TU	" MET-1-27M Ω -II	2,7M Ω	1	
3R-43	OZC457003TU	" MET-1-1M Ω -II	1M Ω	1	
3R-44	OZC457003TU	" MET-1-1M Ω -II	1M Ω	1	
3R-45	OZC457003TU	" MET-1-1M Ω -II	1M Ω	1	
3R-46	OZC457003TU	" MET-1-330K Ω -II	330K Ω	1	
3R-47	OZC457003TU	" MET-0,5-200 Ω -I	200 Ω	1	
3R-48	OZC457003TU	" MET-0,5-4700 Ω -II*	4700 Ω	1	2K Ω 10% 51K Ω 10%
3R-49	OZC457003TU	" MET-0,5-200 Ω -I	200 Ω	1	
3R-50	OZC457003TU	" MET-0,5-200 Ω -I	200 Ω	1	
3R-51	OZC457003TU	" MET-0,5-220 Ω -I	220 Ω	1	
3R-52	OZC457003TU	" MET-0,5-5500 Ω -II *	5500 Ω	1	2,5K Ω 10% 5,6K Ω 10%
3R-53	OZC457003TU	" MET-0,5-200 Ω -I	200 Ω	1	
3R-54	OZC457003TU	" MET-0,5-220 Ω -I	220 Ω	1	
3R-55	OZC457003TU	" MET-0,5-6800 Ω -II *	6800 Ω	1	4,7K Ω 10% 10K Ω 10%
3R-56	OZC457003TU	" MET-0,5-200 Ω -I	200 Ω	1	

S-E-C-R-E-T
NO FOREIGN DISSEM

NO FOREIGN DISSEM

50X1-HUM

1	2	3	4	5
3R-57	OZ0467003TU	Resistor MNT-0,5-220Ω-I	220Ω	1
3R-58	OZ0467003TU	" MNT-0,5-5100Ω-II*	5100Ω	1 <small>4,7KΩ ± 10% 5,1KΩ ± 10%</small>
3R-59	OZ0467003TU	" MNT-1-2000Ω-I	2000Ω	1
3R-60	OZ0467003TU	" MNT-0,5-220Ω-I	220Ω	1
3R-61	OZ0467003TU	" MNT-0,5-220Ω-I	220Ω	1
3R-62	OZ0467003TU	" MNT-0,5-220Ω-I	220Ω	1
3R-63	OZ0467003TU	" MNT-0,5-2,4KΩ-II*	2,4KΩ	1 <small>4,7KΩ ± 10% 6,2KΩ ± 10%</small>
3R-64	OZ0467003TU	" MNT-0,5-10000Ω-I	10000Ω	1
3R-65	OZ0467003TU	" MNT-0,5-7,5KΩ-I	7,5KΩ	1
3R-66	OZ0467003TU	" MNT-0,5-430KΩ-II	430KΩ	1
3R-67	OZ0467003TU	" MET-1-560KΩ-II	560KΩ	1
3R-68	OZ0467003TU	" MNT-1-47KΩ-II	47KΩ	1
3R-69	OZ0467003TU	" MNT-1-220KΩ-II	220KΩ	1
3R-70	OZ0467003TU	" MNT-1-20KΩ-II	20KΩ	1
3R-71	WP4.675.001	" PT-1 ± 1%	62KΩ	1
3R-72	WP4.675.004	" PT-0,5 ± 1%	5,1KΩ	1
3R-73	WP4.675.004	" PT-0,5 ± 1%	5,1KΩ	1
3R-74	OZ0467003TU	" MNT-1-20KΩ-II	20KΩ	1
3R-75	OZ0467003TU	" MNT-1-100Ω-II	100Ω	1
3R-79	OZ0467003TU	" MNT-0,5-430KΩ-II	430KΩ	1
3R-80	WP4.675.004	" PT-0,5 ± 1%	5,1KΩ	1
3R-81	WP4.675.004	" PT-0,5 ± 1%	5,1KΩ	1
3R-82	WP4.675.004	" PT-0,5 ± 1%	5,1KΩ	1
3R-83	OZ0467003TU	" MNT-1-12Ω-II	12Ω	1
3R-84	OZ0467003TU	" MNT-1-4,7KΩ-II	4,7KΩ	1
3R-85	OZ0467003TU	" MNT-1-20KΩ-II	20KΩ	1

S-E-C-R-E-T
NO FOREIGN DISSEM

NO FOREIGN DISSEM

50X1-HUM

1	2	3	4	5
3R-85	OZ0457003TU	Resistor MET-1-3, 3K Ω -II	3, 3K Ω	1
3R-87	OZ0457003TU	" MET-0,5-220 Ω -I	220 Ω	1
3R-88	OZ0457003TU	" MET-0,5-220 Ω -I	220 Ω	1
3R-89	OZ0457003TU	" MET-2-51K Ω -II	51K Ω	1
3R-90	OZ0457003TU	" MET-1-510K Ω -II	510K Ω	1
3R-91	OZ0457003TU	" MET-1-680K Ω -II	680K Ω	1
3R-93	OZ0457003TU	" MET-1-150K Ω -II	150K Ω	1
3R-94	WT4.695.0068p	" PP3-11-20K Ω -II	20K Ω	1
3R-95	OZ0457003TU	" MET-1-1,2K Ω -II	1,2K Ω	1
3R-95	OZ0457003TU	" MET-1-47K Ω -II	47K Ω	1
3R-97	OZ0457003TU	" MET-1,3, 3K Ω -II	3, 3K Ω	1
3R-98	OZ0457003TU	" MET-1-58K Ω -II	58K Ω	1
3R-99	OZ0457003TU	" MET-1-680K Ω -II	680K Ω	1
3R-101	OZ0457003TU	" MET-1-100K Ω -II	100K Ω	1
3R-102	OZ0457003TU	" MET-1-30K Ω -II	30K Ω	1
3R-103	OZ0457003TU	" MET-1-470K Ω -II	470K Ω	1
3R-104	WT4.695.0068p	" PP311-10K Ω -II	10K Ω	1
3R-105	OZ0457003TU	" MET-1-1M Ω -II	1M Ω	1
3R-106	OZ0457003TU	" MET-1-430 Ω -II	430 Ω	1
3R-107	OZ0457003TU	" MET-1-100K Ω -I	100K Ω	1
3R-108	OZ0457003TU	" MET-1-1M Ω -II	1M Ω	1
3R-109	OZ0457003TU	" MET-1-100K Ω -II	100K Ω	1
3R-110	OZ0457003TU	" MET-1-1K Ω -II	1K Ω	1
3R-111	OZ0457003TU	" MET-1-52K Ω -I	52K Ω	1
3R-112	OZ0457003TU	" MET-1-52K Ω -II	52K Ω	1
3R-113	GOST574-50	" II-2b-580-13A	580K Ω	1
3R-114	GOST574-50	" 3P-II-2b-3, 3A	3, 3K Ω	1

S-E-C-R-E-T
NO FOREIGN DISSEM

50X1-HUM

1	2	3	4	5	6
3C-1	GOST5119-54	Condenser K50-5-500G-2200-II	2200pF	1	
3C-2	OZ0452008TU	" MBGP-2-400-2x0,1-II	2x0,1μF	1	
3C-3					**
3C-4					**
3C-5	OZ0462008TU	" MBGP-2400-2x0,1-II	2x0,1μF	1	
	OZ0452008TU	" MBGP-2-400-2x0,1-II	2x0,1μF	1	
3R-7	GOST6119-54	" K50-2-500-8-220-II	220pF	1	
3R-8	OZ0452011TU	" BGM-2-400-001-II	0,01μF	1	
3R-9	GOST5119-54	" K50-5-500-W-1000-II	1000pF	1	
3R-10	OZ0452011TU	" BGM-2-400-0,01-II	0,01μF	1	
3R-11	GOST5119-54	" K50-2-500-W-220-II	220pF	1	
3R-12	OZ0462011TU	" BGM-2-400-0,01-II	0,01μF	1	
3R-13	GOST6119-54	" K50-2-500-W-220-II	220pF	1	
3R-14	OZ0462011TU	" BGM-2-400-0,033-II	0,033μF	1	
3R-15	OZ0462008TU	" MBGP-2-200-1-II	1,0μF	1	
3R-16	OZ0462008TU	" MBGP-2-200-0,5-II	0,5μF	1	
3R-17	GOST6119-54	" K50-2-500-W-1000-II	1000 pF	1	
3R-18	OZ0462011TU	" BPI-2-400-0,01-II	0,01μF	1	
3R-19	OZ0462008TU	" MBGP-2-400-2x0,1-II	2x0,1μF	1	
3R-20	OZ0462011TU	" BGM-2-400-0,01-II	0,01μF	1	
3R-21	OZ0462011TU	" BGM-2-400-0,05-III	0,05μF	1	
3R-22	OZ0462008TU	" MBGP-4x-200-4,0-II	4μF	1	
3R-23	GOST5119-54	" K50-2-500-G-1000-I	1000pF	1	
3R-24	GOST5119-54	" K50-2-500-G-1000-I	1000pF	1	
3R-25	GOST6119-54	" K50-2-500-G-1000-I	1000pF	1	
3R-26	GOST6119-54	" K50-2-500-G-1000-I	1000pF	1	
3R-27	GOST6119-54	" K50-2-500-G-1000-I	1000pF	1	

S-E-C-R-E-T
 NO FOREIGN DISSEM

NO FOREIGN DISSEM

1	2	3	4	5	6
3R-28	GOST5119-54	Condenser KSO-2-500-G-1000-I	1000pF	1	6 50X1-HUM
3R-29	GOST5119-54	" KSO-2-500-G-1000-I	1000pF	1	
3R-30	GOST5119-54	" KSO-2-500-G-1000-I	1000pF	1	
3R-31	GOST5119-54	" KSO-2-500-G-1000-I	1000pF	1	
3R-32	GOST5119-54	" KSO-2-500-G-1000-I	1000pF	1	
3R-33	GOST5119-54	" KSO-2-500-G-1000-I	1000pF	1	
3C-34	GOST5119-54	" KSO-2-500-G-1000-I	1000pF	1	
3C-35	GOST5119-54	" KSO-2-500-G-1000-I	1000pF	1	
3C-36	GOST5119-54	" KSO-2-500-G-1000-I	1000pF	1	
3C-37	OZ0462011TU	" BGM-2400-0,01-II	0,01μF	1	
3C-38	OZ0462011TU	" BGM-2-400-0,01-II	0,01μF	1	
3C-39	OZ0452008TU	" MBGP-2-400-C,25-II	0,25μF	1	
3C-41	GOST5119-54	" KSO-2-500-G-1000-I	1000pF	1	
3C-42	GOST5119-54	" KSO-2-500-G-1000-I	1000pF	1	
3C-43	GOST5119-54	" KSO-2-500-G-1000-I	1000pF	1	
3C-44	GOST5119-54	" KSO-2-500-G-1000-I	1000pF	1	
3C-45	GOST5119-54	" KSO-2-500-G-1000-I	1000pF	1	
3C-47	OZ0452011TU	" BGM-2-400-0,01-II	0,01μF	1	
3C-25a	GOST5119-54	" KSO-2-500-G-1000-I	1000pF	1	
3C-26	GOST5119-54	" KSO-2-500-G-1000-I	1000pF	1	
3C-30a	GOST5119-54	" KSO-2-500-G-1000-I	1000pF	1	
3C-50	OZ0462008TU	" MBGP-2-200-2x0,5-II	2x0,5μF	1	
3C-51	OZ0462011TU	" BGM-2-400-C,01-II	0,01μF	1	
3C-52	OZ0462011TU	" BGM-2-400-C,01-II	0,01μF	1	
3C-46	OZ0462011TU	" BGM-2-400-0,05-II	0,05μF	1	
3C-54	GOST5119-54	" KSO-5-500-7-2200-II	2200pF	1	

48

S-E-C-R-E-T

NO FOREIGN DISSEM

NO FOREIGN DISSEM

1	2	3	4	5	6
7C-55	GOST6119-54	Condenser KSC-2-500-G-120-I	120pF	1	50X1-HUM
7C-56	GOST6119-54	" KSC-2-500-G-1000-I	1000pF	1	
7C-57	GOST5119-54	" KSC-2-500-G-1000-I	1000pF	1	
7C-58	GOST7159-54	" KTK-1-B-10-II	10pF	1	
7C-59	GOST5119-54	" KSC-2-500-W-1000-II	1000pF	1	
7C-60	GOST5118-52	" KSGI-200-0,3-II	0,03pF	1	
7C-61	GOST5119-54	" KSC-2-500-W-150-II	150pF	1	
7C-62	GOST6119-54	" KSC-2-500-W-1000-II	1000pF	1	
7C-63	GOST6119-54	" KSC-5-500-W-300-II	300pF	1	
7C-64	GOST5118-52	" KSGI-200-0,03-II	0,03pF	1	
7C-65	GOST5119-54	" KSC-5-500-W-4700-II	4700pF	1	
7C-66	GOST5119-54	" KSC-5-500-W-5100-II	5100pF	1	
7C-68	OZ0452011TU	" BGM-2-400-0,01-II	0,01pF	1	

49

S-E-C-R-E-T

NO FOREIGN DISSEM

S-E-C-R-E-T
NO FOREIGN DISSEM

50X1-HUM

1	2	3	4	5	6
2L-1	1RM-3-2-20,4	Circuit coil			1
2L-2	1RM-3-2-20,4	"			1
2L-3	1RM-3-2-20,4	"			1
2L-4	1RM-3-2-20,4	"			1
2L-15	GJ4778002	"			1
2L-5	TJ 2770045n	Choke D-0,1-100μH ± 5%	100μH		1
2L-8	GJ4777003Sp	" D-1,2 ± 10%	5μH		1
2L-9	GJ4777003Sp	" D-1,2 ± 10%	5μH		1
2L-10	GJ4777003Sp	" D 1,2 ± 10%	5μH		1
2L-11	GJ4777003Sp	" D 1,2 ± 10%	5μH		1
2L-13	GJ4777003Sp	" D-1,2 ± 10%	5μH		1
2L-14	GJ4777003Sp	" D-1,2 ± 10%	5μH		1
2L-15	GJ4777003Sp	" D-1,2 ± 10%	5μH		1
2L-17	TJ-22320	" D-0,33μH	330μH		
3V-1	CzTUN0110553	Valve type 5V1P			1
3V-2	CzTUN0110553	" " 5Z3P			1
3V-3	CzTUN0110553	" " 5V1P			1
3V-4	CzTUN0110553	" " 5V1P			1
3V-5	CzTUN0110553	" " 5Z1P			1
3V-6	CzTUN0110553	" " 5V1P			1
3V-7	CzTUN0110553	" " 5V1P			1
3V-8	CzTUN0110553	" " 5Z.P			1

S-E-C-R-E-T
NO FOREIGN DISSEM

S-E-C-R-E-T
NO FOREIGN DISSEM

50X1-HUM

1	2	3	4	5	6
TV-10	CzTUN0110553	Valve type 6N1P		1	
TV-11	CzTUN0110553	" " 6N1P		1	
TV-12	CzTUN0110853	" " 6N1P		1	
TV-13	CzTUN0110553	" " 6N1P		1	
TV-14	CzTUN0111653	" " 6Z3P		1	
TV-15	CzTUN0111653	" " 6Z3P		1	
TV-15	CzTUN0111653	" " 6Z3P		1	
TV-17	CzTUN0111653	" " 6Z3P		1	
TV-18	CzTUN0111653	" " 6H2P		1	
TV-19	CzTUC112053	" " 6N3P		1	
TV-20	CzTUN0110453	" " 6Z2P		1	
TV-21	CzTUN0110353	" " 6Z1P		1	
TV-22	CzTUN0110353	" " 6N1P		1	
TV-9	TU1-3-19	Noon lamp MN-7		1	
TV-1		Detector DCC-4		1	
3Tp-1	SzJ-0779	Pulse transformer		1	
	GJ4510001Sp	Relay		2	
TV-1	GJ2065002Sp	Delaying line 0,5 μsec.	1000 ± 10%	1	
SzR-1	IRM-3-2-20,2	Socket		1	
SzR-2	Fabr. TU102P/J104	" SzRC40PK16ES22		1	
SzR-3	Fabr. TU102P/J104	Plug SzR43PK26ES22		1	

Attention!

Items marked "x" should be chosen
when tuning."xx" are fitted in thermo-
relay unit.

51

S-E-C-R-E-T

NO FOREIGN DISSEM

50X1-HUM

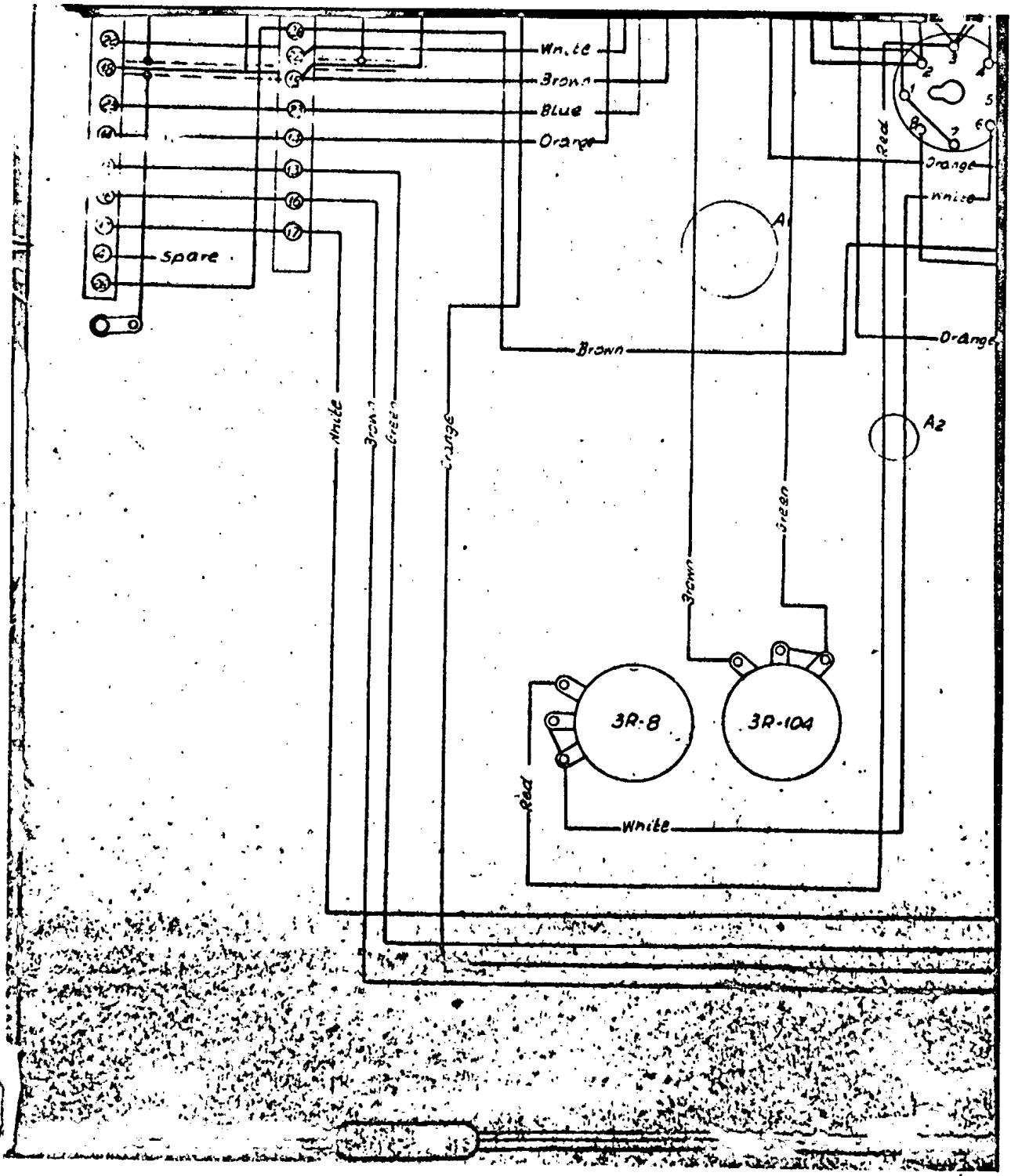

S-E-C-R-E-T
NO FOREIGN DISSEM

NO FOREIGN DISSEM

50X1-HUM

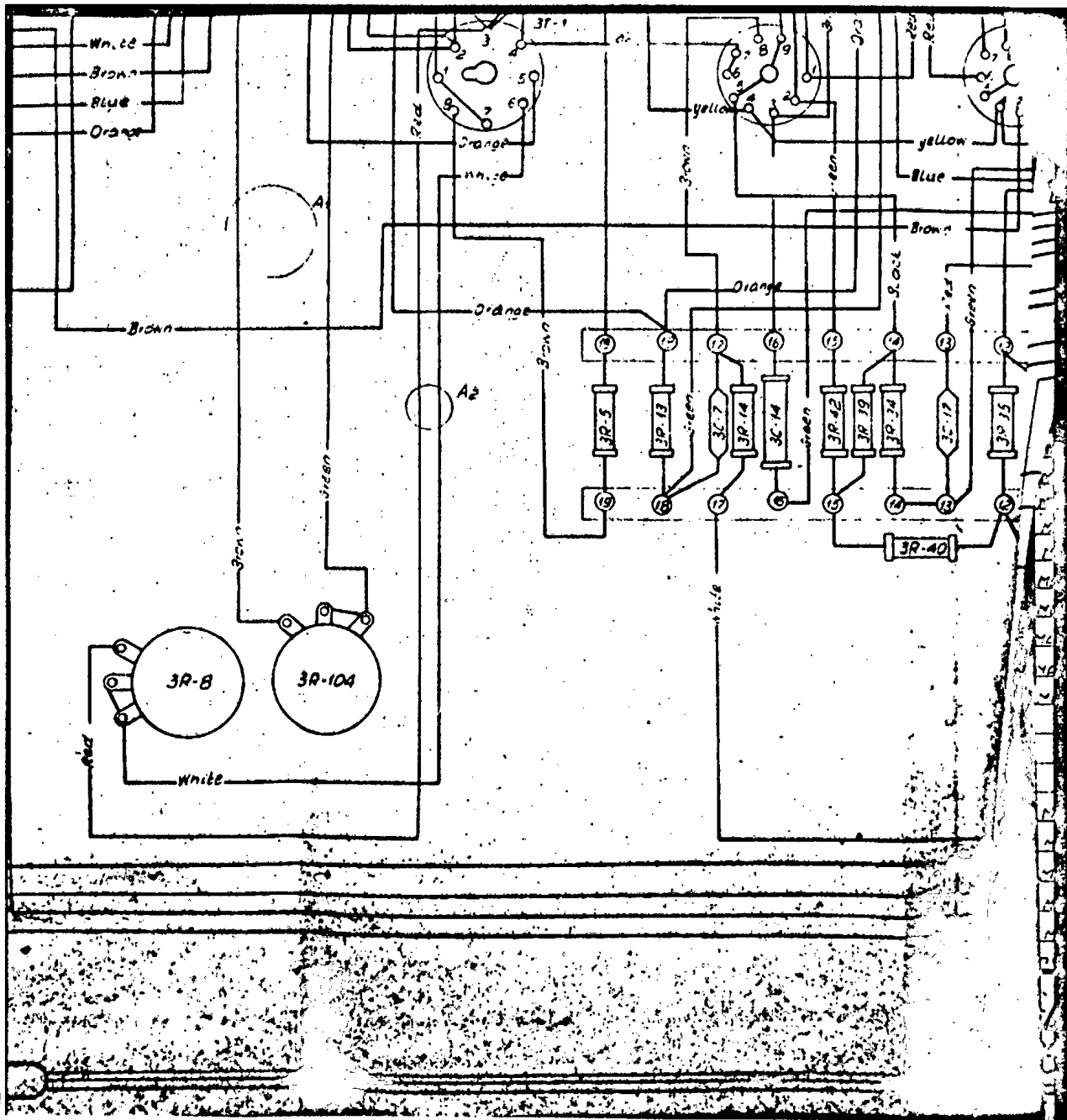

S-E-C-R-E-T

NO FOREIGN DISSEM

50X1-HUM

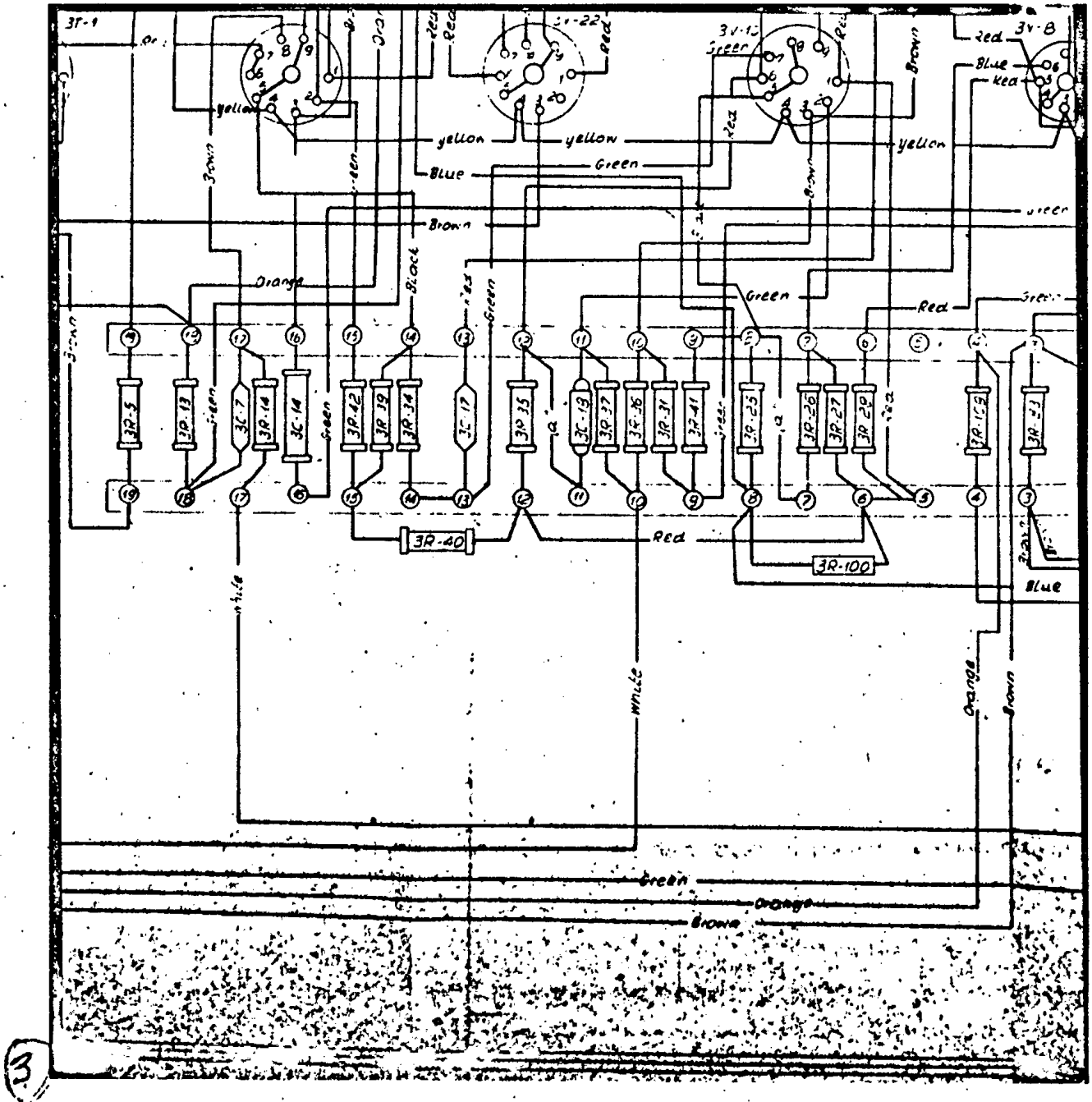

S-E-C-R-E-T
NO FOREIGN DISSEM

U-S-E-C-R-E-T
NO FOREIGN DISSEM

50X1-HUM

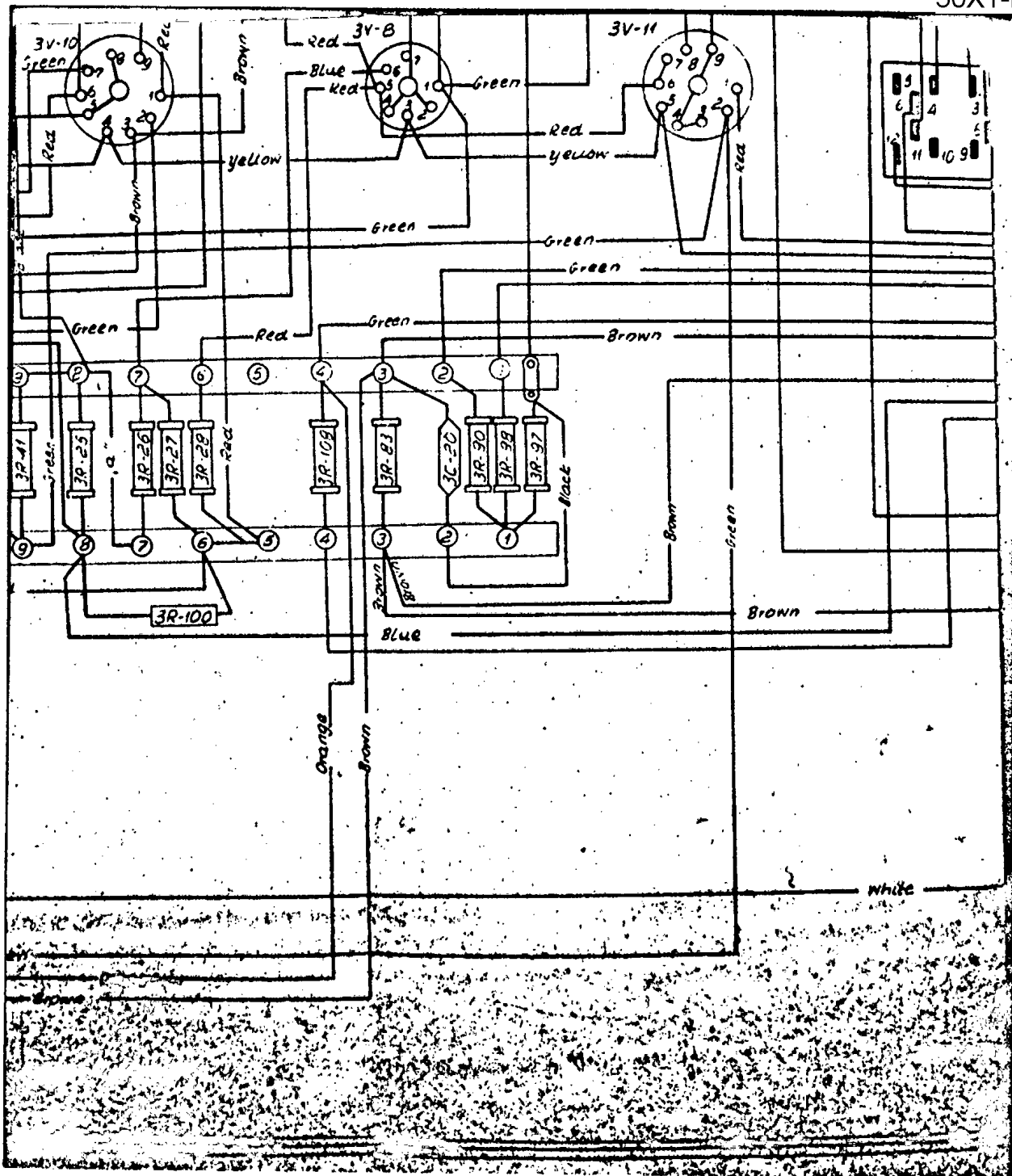

S-E-C-R-E-T
NO FOREIGN DISSEM

NO FOREIGN DISSEM

50X1-HUM

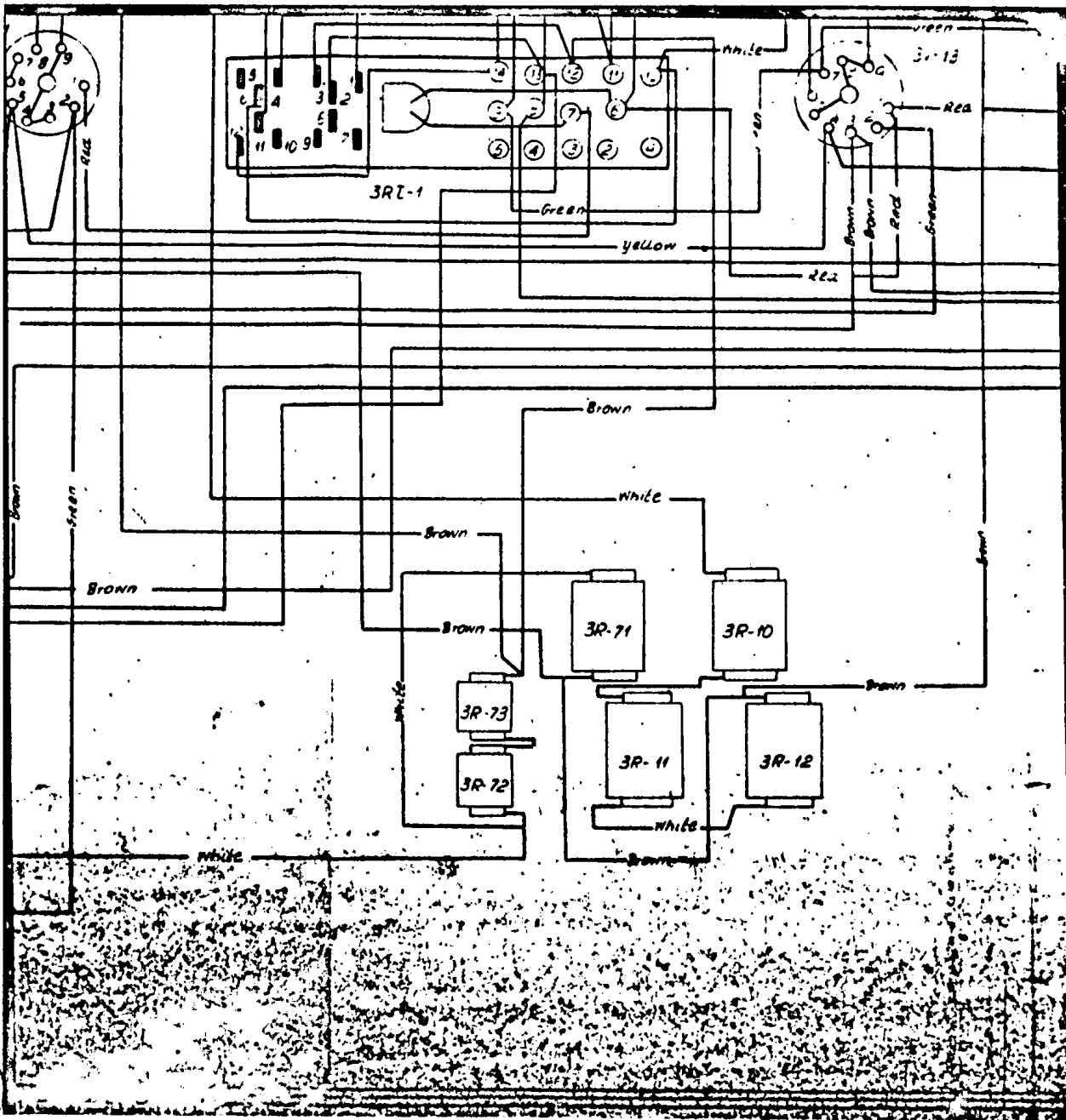

S-E-C-R-E-T

NO FOREIGN DISSEM

50X1-HUM

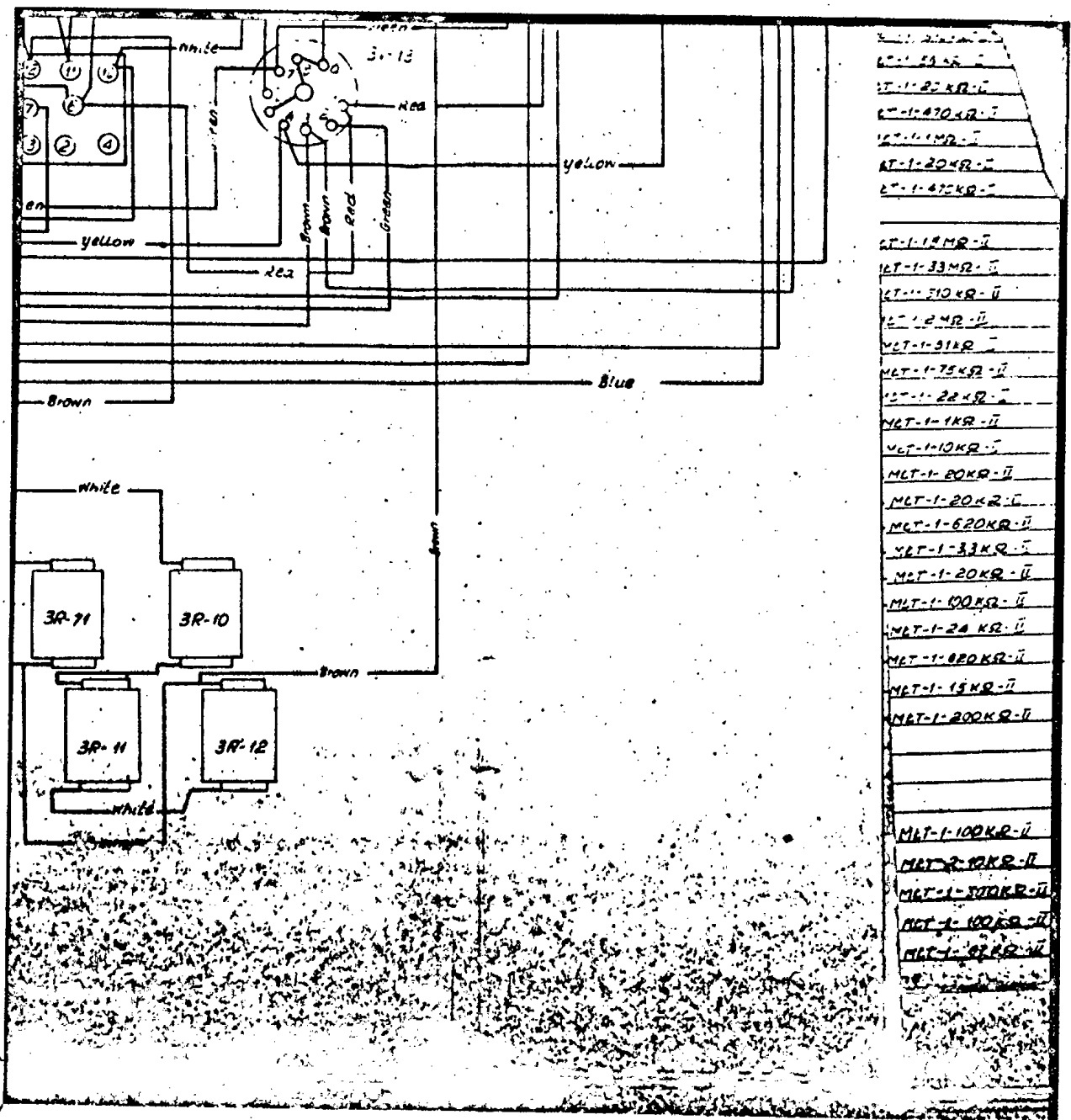

S-E-C-R-E-T
NO FOREIGN DISSEM

S-E-C-R-E-T
NO FOREIGN DISSEM

50X1-HUM
3R-39 OZ
3R-37 OZ
3R-35 OZ
3R-35 OZ
3R-34 OZ

16	Spider POS-6100ST 1499-54	3R-31 OZ
15	Enamel 2 1/2 black	3R-30 OZ
	TUM-19 522-54	3R-29 OZ
14	Thread 1000	3R-28 OZ
	POST 6329-52	3R-27 OZ
13	CHLOROVINYL SLEEVE # 6	3R-26 OZ
	TUM-19 375-47	3R-25 OZ
12	CHLOROVINYL SLEEVE # 6	3R-24 OZ
	TUMHP 1375-47	3R-23 OZ
11	CHLOROVINYL SLEEVE # 3.5	3R-22 OZ
	TUMHP 1375-47	3R-21 OZ
10	CHLOROVINYL SLEEVE # 2.5	3R-20 OZ
	TUMHP 1375-47	3R-19 OZ
9	CHLOROVINYL SLEEVE # 1	3R-18 OZ
	TUMHP 1375-47	3R-17 OZ
8	Wicker-work 214	3R-16 OZ
	NTU 124-54	3R-15 OZ
7	Tinned copper wire # 1.5	3R-14 OZ
	WNE 278-43	3R-13 OZ
6	Tinned copper wire # 0.9	
	WNE 278-43	
5	Wire BONE 1mm ²	
	NTUMEP 673-47	3R-7 OZ
4	Wire BONE 0.35mm ²	3R-6 OZ
	NTUMEP 672-47	3R-5 OZ
3	Wire BONE 0.35mm ²	3R-4 OZ
	NTU MRP 673-47	3R-3 OZ
2	Wire BONE 0.35mm ²	
	NTU MRP 672-47	
1	Wire BONE 0.35mm ²	
	NTU MRP 671-47	

S-E-C-R-E-T

NO FOREIGN DISSEM

S-E-C-R-E-T
NO FOREIGN DISSEM

3R-39	020467003TU	Resistance MET-1-51 KR-II	1	33 - 112 KR
3R-39	020467003TU	Resistance MET-1-20 KR-II	1	50X1-HUM
3R-37	020467003TU	Resistance MET-1-470 KR-II	1	
3R-35	020467003TU	Resistance MET-1-1 MR-II	1	
3R-35	020467003TU	Resistance MET-1-20 KR-II	1	
3R-34	020467003TU	Resistance MET-1-470 KR-II	1	
3R-31	020467003TU	Resistance MET-1-19 MR-II	1	19 - 39 MR
3R-35	020467003TU	Resistance MET-1-33 MR-II	1	
3R-29	020467003TU	Resistance MET-1-510 KR-II	1	
3R-28	020467003TU	Resistance MET-1-2 MR-II	1	
3R-27	020467003TU	Resistance MET-1-51 KR-II	1	
3R-26	020467003TU	Resistance MET-1-75 KR-II	1	
3R-25	020467003TU	Resistance MET-1-22 KR-II	1	
3R-24	020467003TU	Resistance MET-1-1 KR-II	1	
3R-23	020467003TU	Resistance MET-1-10 KR-II	1	
3R-22	020467003TU	Resistance MET-1-20 KR-II	1	
3R-21	020467003TU	Resistance MET-1-20 KR-II	1	
3R-20	020467003TU	Resistance MET-1-620 KR-II	1	
3R-19	020467003TU	Resistance MET-1-33 KR-II	1	
3R-18	020467003TU	Resistance MET-1-20 KR-II	1	
3R-17	020467003TU	Resistance MET-1-100 KR-II	1	
3R-16	020467003TU	Resistance MET-1-24 KR-II	1	
3R-15	020467003TU	Resistance MET-1-620 KR-II	1	
3R-14	020467003TU	Resistance MET-1-15 KR-II	1	
3R-13	020467003TU	Resistance MET-1-200 KR-II	1	
3R-7	020467003TU	Resistance MET-1-100 KR-II	1	
3R-6	020467003TU	Resistance MET-2-10 KR-II	1	
3R-5	020467003TU	Resistance MET-1-300 KR-II	1	
3R-2	020467003TU	Resistance MET-1-100 KR-II	1	
3R-1	020467003TU	Resistance MET-1-33 KR-II	1	

Unit Nr 3
Distance unit
Wiring diagram

S-E-C-R-E-T
NO FOREIGN DISSEM

D-E-C-R-E-T
NO FOREIGN DISSEM

50X1-HUM

connections 52K.	3R-112	020467003TU	Resistance MET-1-62KR-II	1	200KR
of wires SrR with	3R-111	020467003TU	Resistance MET-1-62KR-II	1	
chromyl sleeves	3R-110	020467003TU	Resistance MET-1-1KR-II	1	
	3R-109	020467003TU	Resistance MET-1-100KR-II	1	
es on resistances	3R-108	020467003TU	Resistance MET-1-1KR-II	1	
and on condensers	3R-107	020467003TU	Resistance MET-1-100KR-II	1	
	3R-106	020467003TU	Resistance MET-1-430KR-II	1	
wires to 3RT-2.	3R-105	020467003TU	Resistance MET-1-1MR-II	1	
should enable easy	3R-103	020467003TU	Resistance MET-1-470KR-II	1	
	3R-102	020467003TU	Resistance MET-1-30KR-II	1	
ed after tuning.	3R-101	020467003TU	Resistance MET-1-100KR-II	1	
enamel according	3R-99	020467003TU	Resistance MET-1-580KR-II	1	
	3R-98	020467003TU	Resistance MET-1-88KR-II	1	
inal numbers.	3R-97	020467003TU	Resistance MET-1-33KR-II	1	
with No 100 cotton	3R-96	020467003TU	Resistance MET-1-47KR-II	1	
	3R-95	020467003TU	Resistance MET-1-12KR-II	1	
	3R-93	020467003TU	Resistance MET-1-180KR-II	1	
ing diagram, etc	3R-91	020467003TU	Resistance MET-1-580KR-II	1	
	3R-90	020467003TU	Resistance MET-1-510KR-II	1	
	3R-85	020467003TU	Resistance MET-1-20KR-II	1	
	3R-84	020467003TU	Resistance MET-1-47KR-II	1	
	3R-83	020467003TU	Resistance MET-1-1MR-II	1	
	3R-74	020467003TU	Resistance MET-1-80KR-II	1	
	3R-70	020467003TU	Resistance MET-1-20KR-II	1	
	3R-69	020467003TU	Resistance MET-1-220KR-II	1	
	3R-68	020467003TU	Resistance MET-1-47KR-II	1	
	3R-67	020467003TU	Resistance MET-1-550-II	1	
	3R-46	020467003TU	Resistance MET-1-330KR-II	1	
	3R-45	020467003TU	Resistance MET-1-1MR-II	1	
	3R-44	020467003TU	Resistance MET-1-1MR-II	1	
	3R-43	020467003TU	Resistance MET-1-1MR-II	1	
	3R-42	020467003TU	Resistance MET-1-27MR-II	1	
	3R-41	020467003TU	Resistance MET-1-430KR-II	1	

(9)

S-E-C-R-E-T
NO FOREIGN DISSEM

50X1-HUM

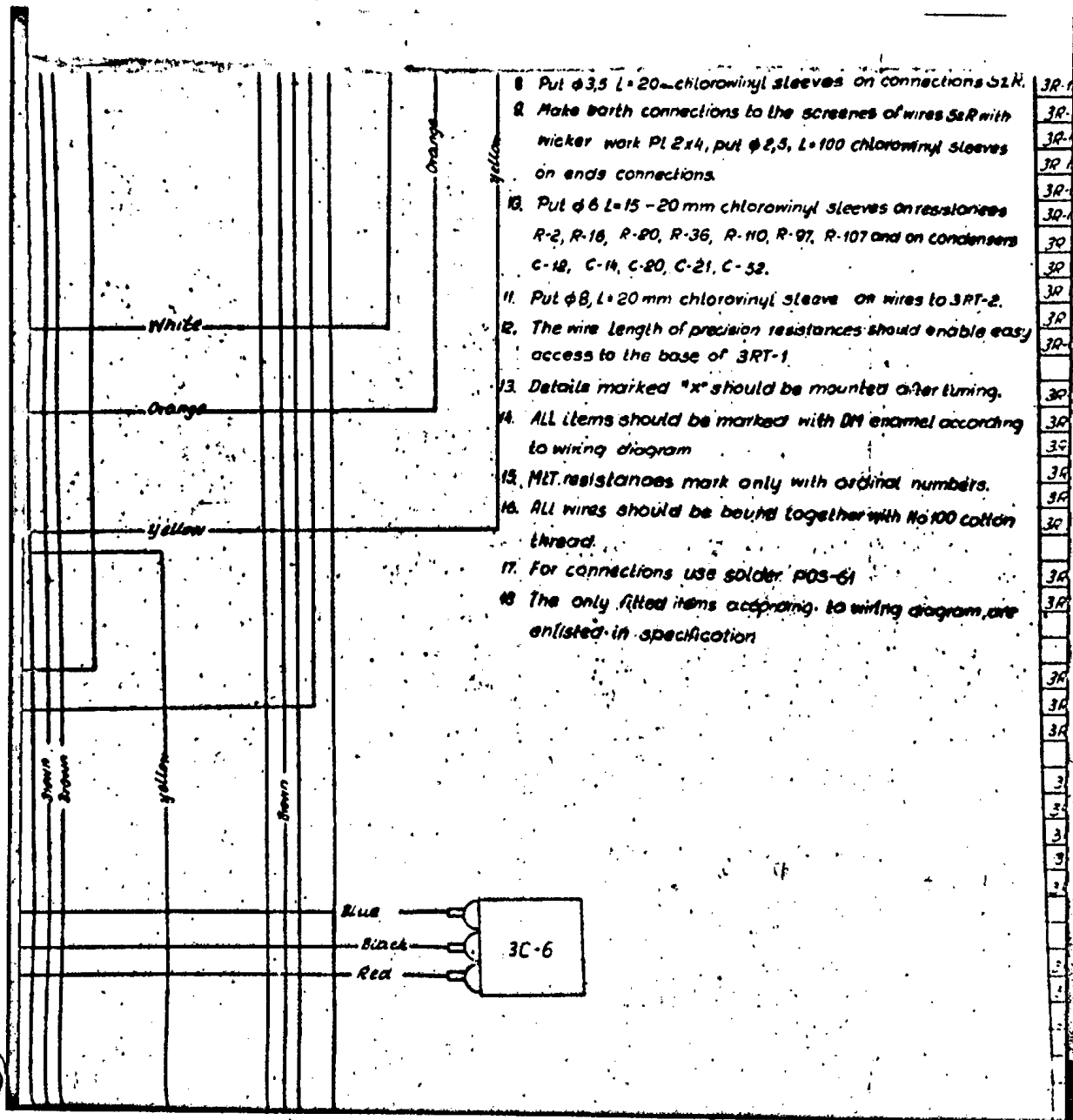

S-E-C-R-E-T
 NO FOREIGN DISSEM

NO FOREIGN DISSEM

50X1-HUM

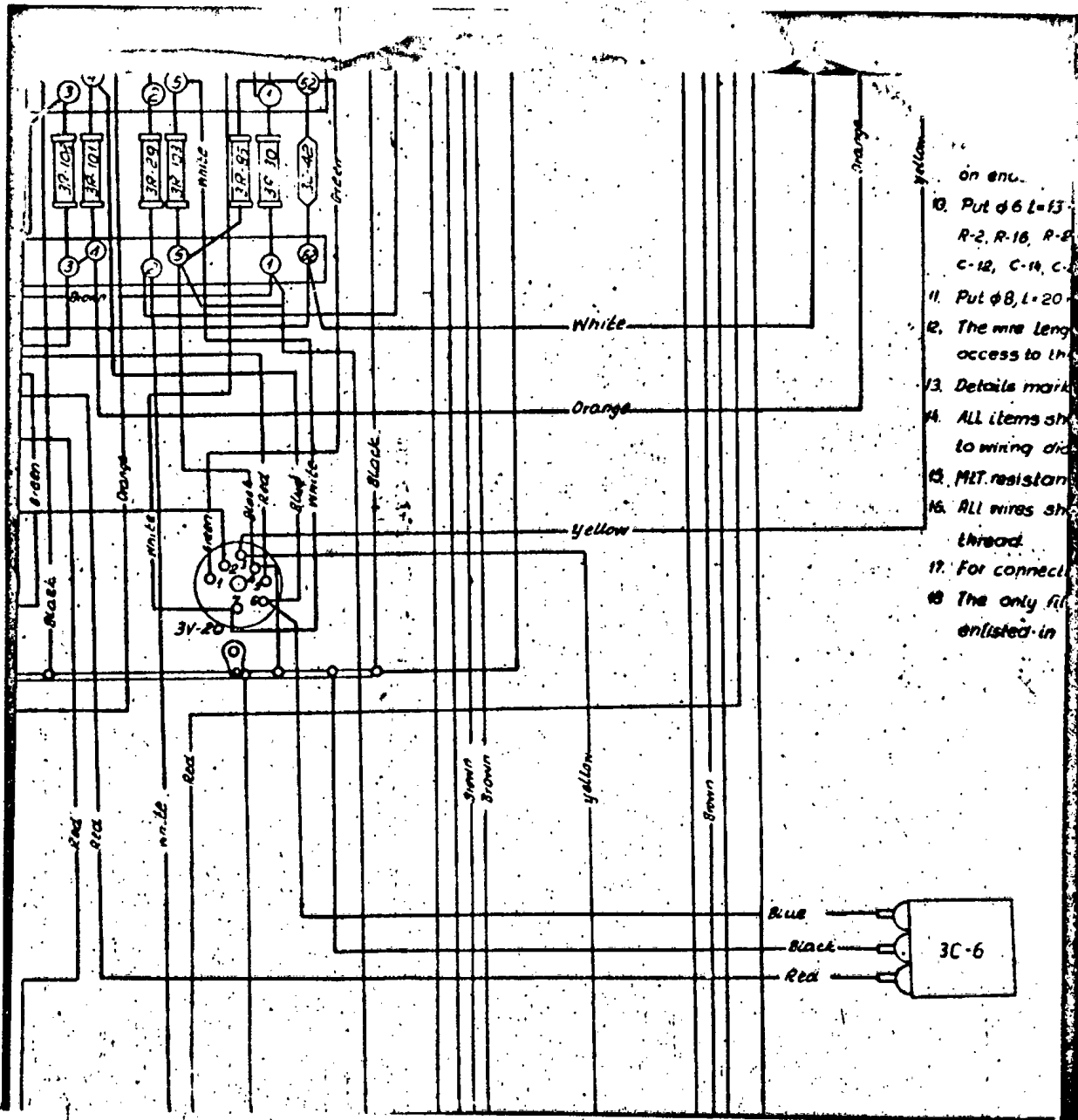

- on enc.
10. Put $\phi 6 L=13$
R-2, R-16, R-8
C-12, C-14, C-1
 11. Put $\phi 8, L=20$
 12. The wire length
access to the
 13. Details mark
 14. ALL items sh
to wiring dia
 15. M.T. resistan
 16. All wires sh
thread
 17. For connect
 18. The only fil
enlisted in

S-E-C-R-E-T

NO FOREIGN DISSEM

NO FOREIGN DISSEM

50X1-HUM

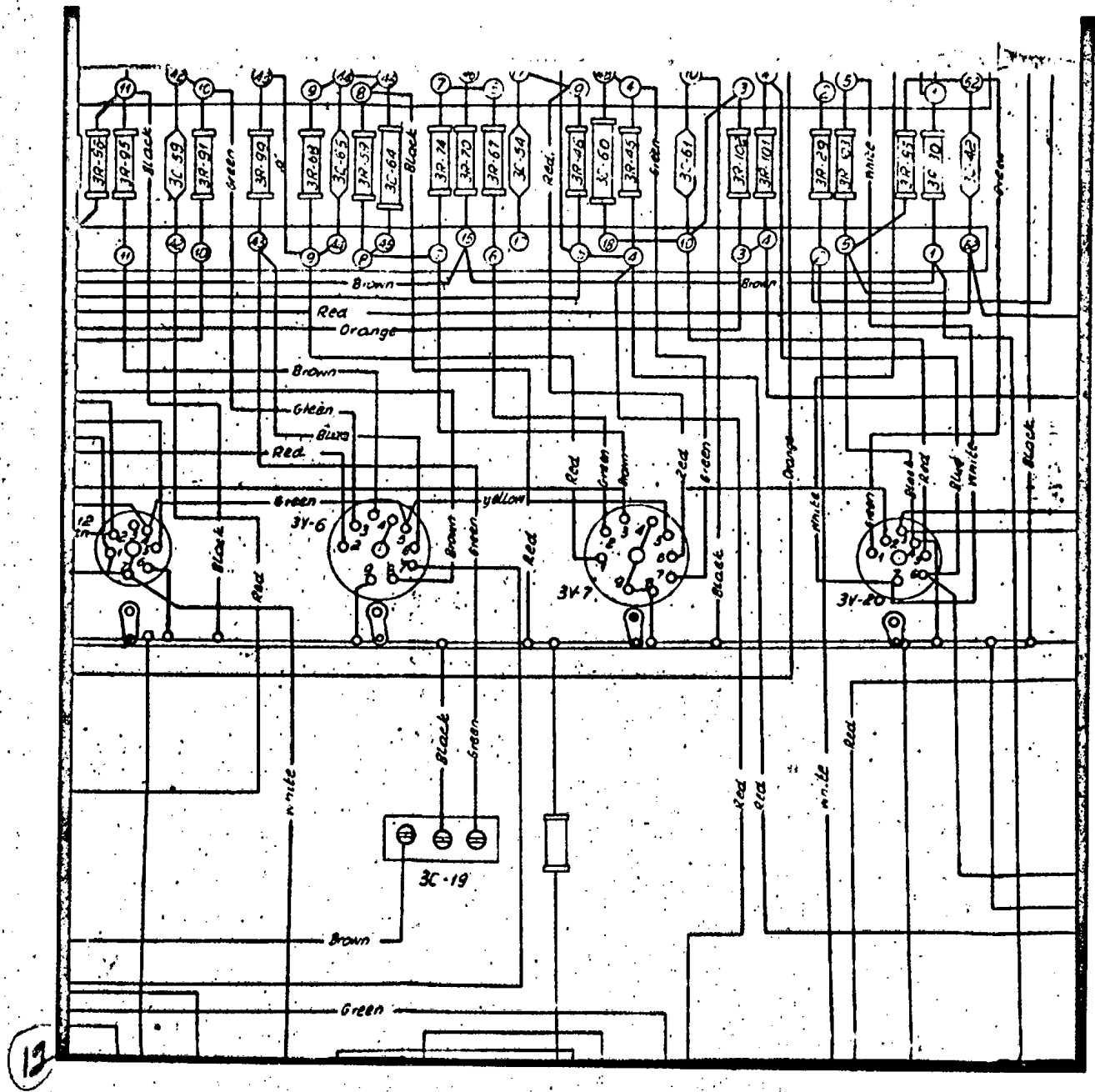

12

S-E-C-R-E-T
NO FOREIGN DISSEM

NO FOREIGN DISSEM

50X1-HUM

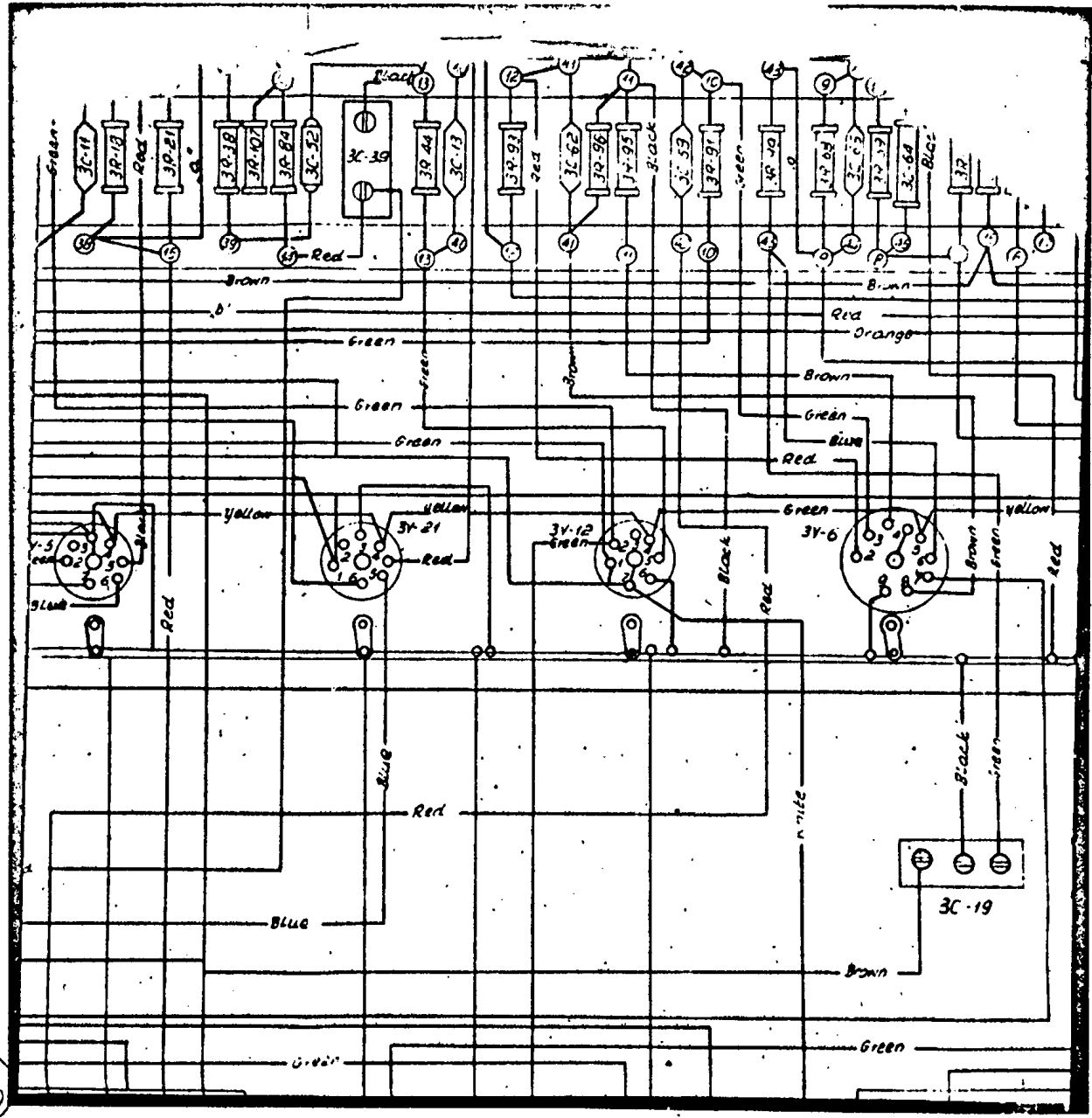

113

S-E-C-R-E-T

NO FOREIGN DISSEM

NO FOREIGN DISSEM

50X1-HUM

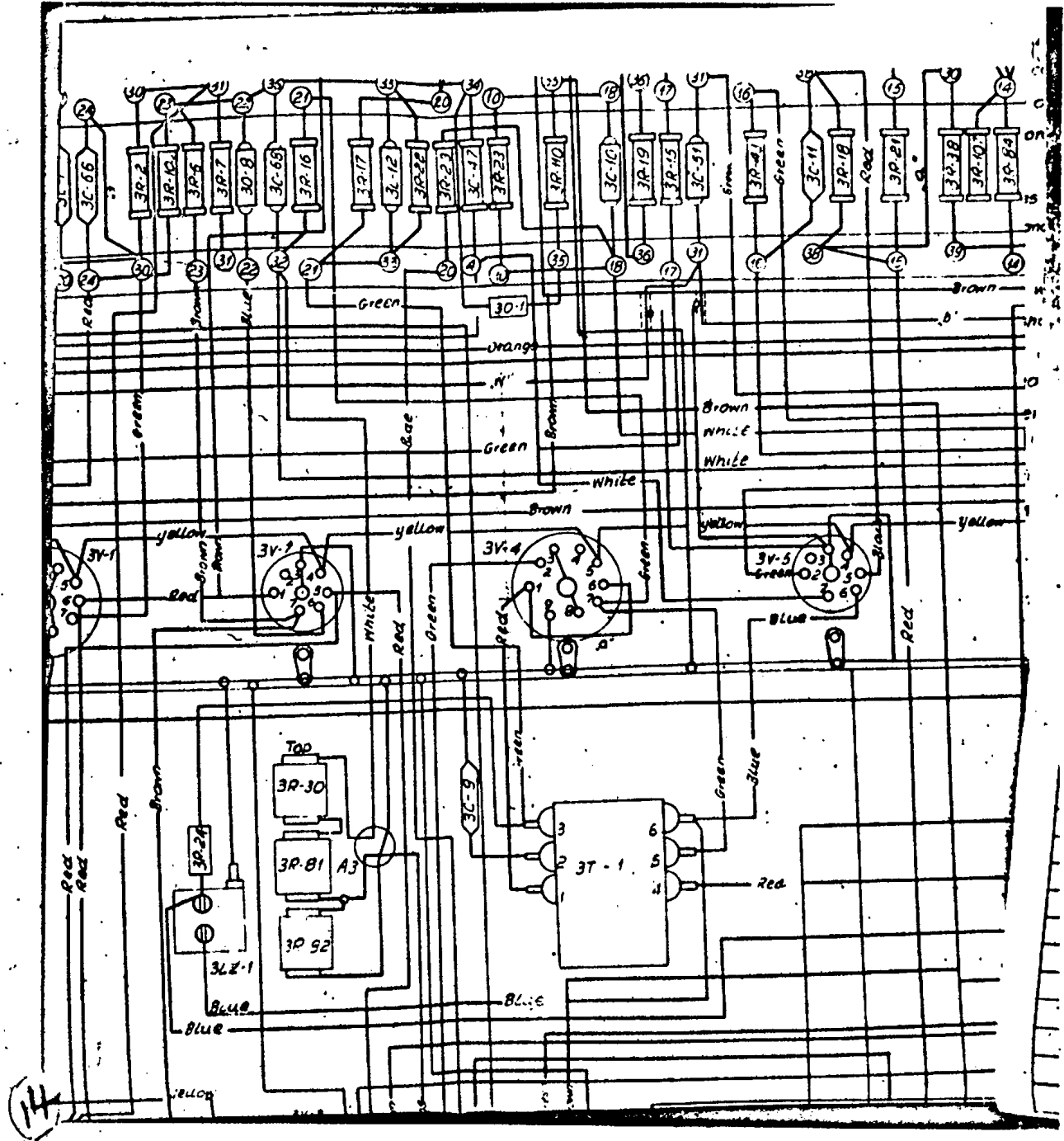

S-E-C-R-E-T

NO FOREIGN DISSEM

NO FOREIGN DISSEM

50X1-HUM

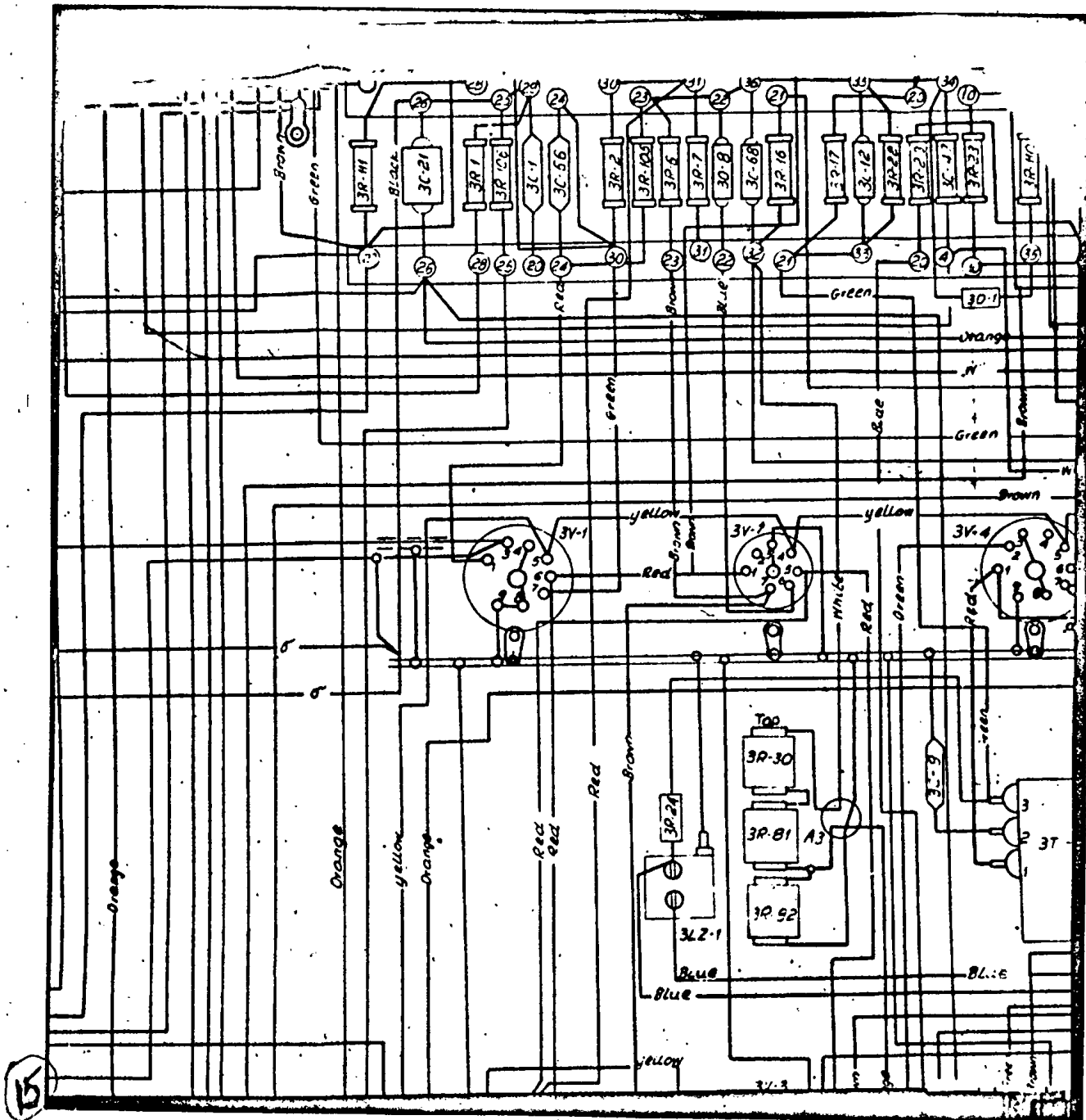

S-E-C-R-E-T

NO FOREIGN DISSEM

U-E-C-R-E-T
NO FOREIGN DISSEM

50X1-HUM

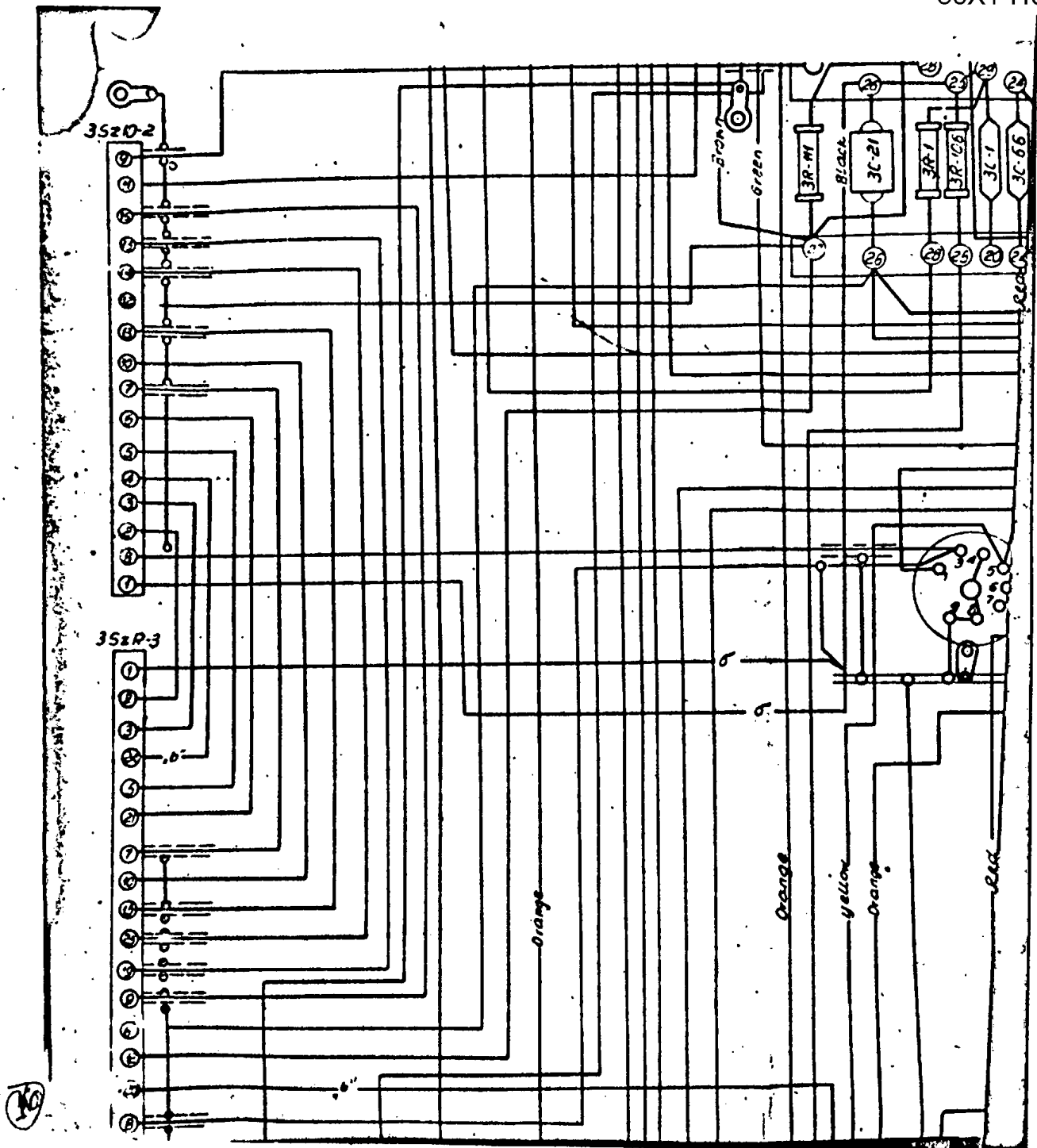

S-E-C-R-E-T
NO FOREIGN DISSEM

50X1-HUM

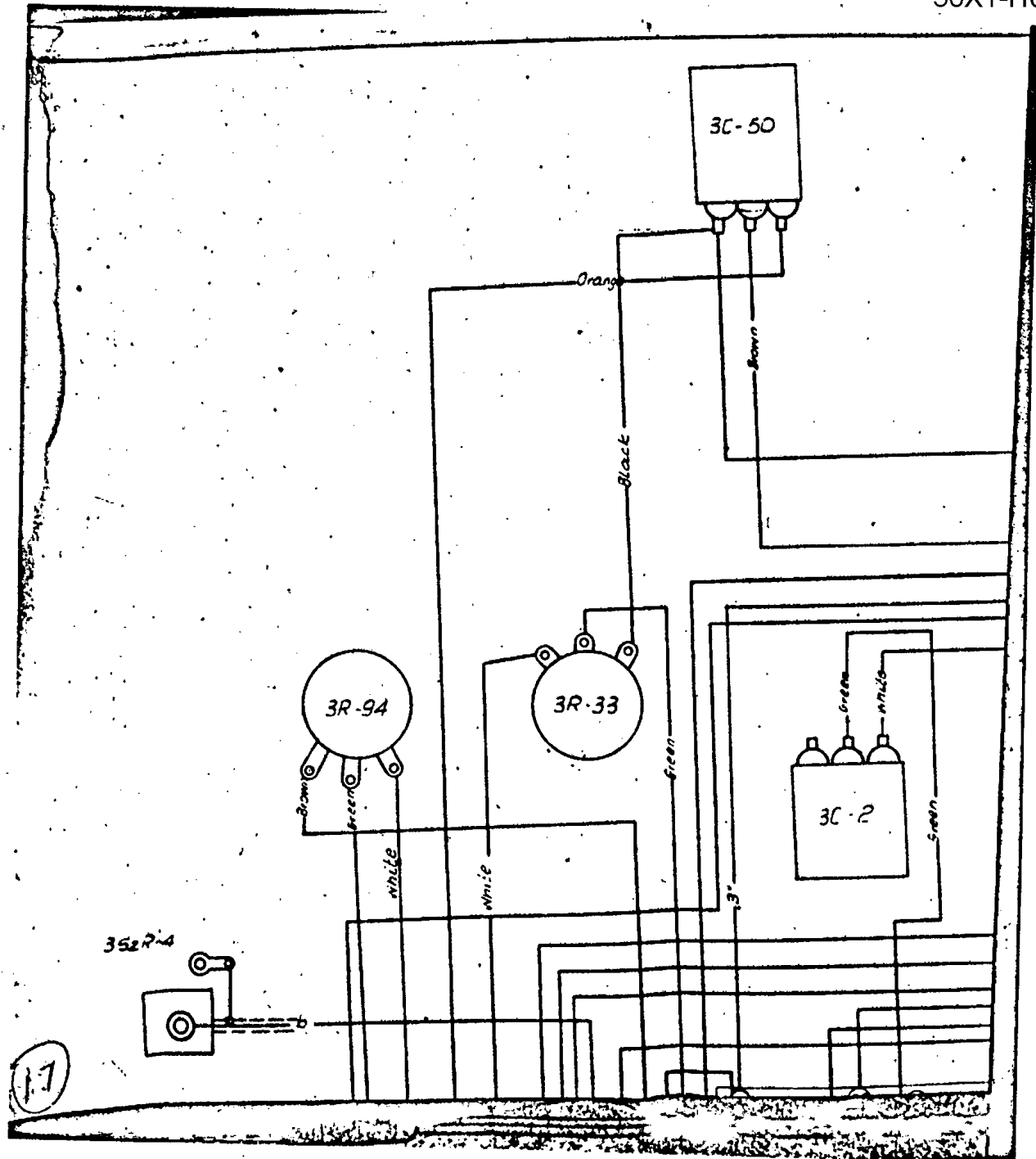

S-E-C-R-E-T
NO FOREIGN DISSEM

NO FOREIGN DISSEM

50X1-HUM

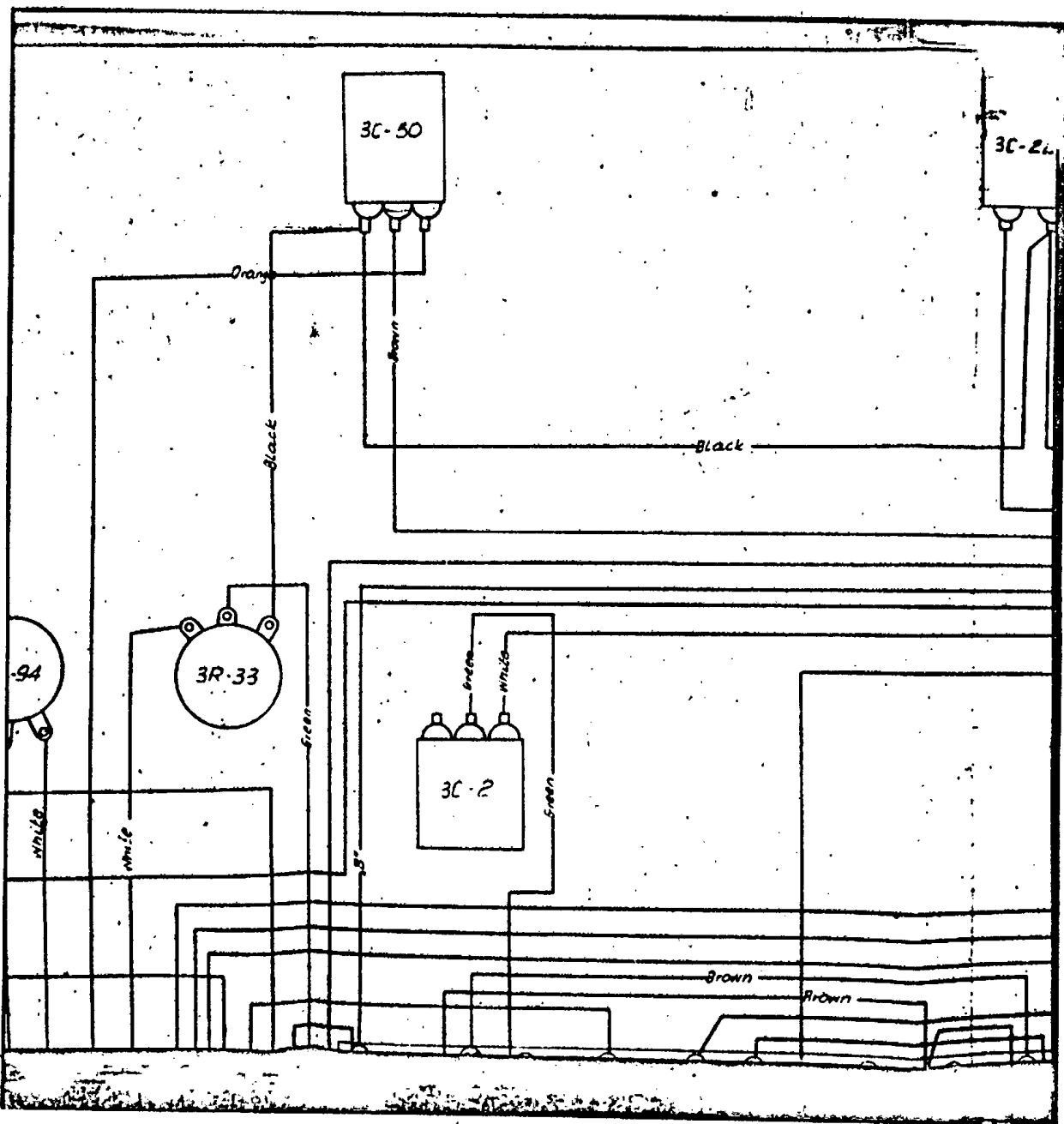

S-E-C-R-E-T
NO FOREIGN DISSEM

NO FOREIGN DISSEM

50X1-HUM

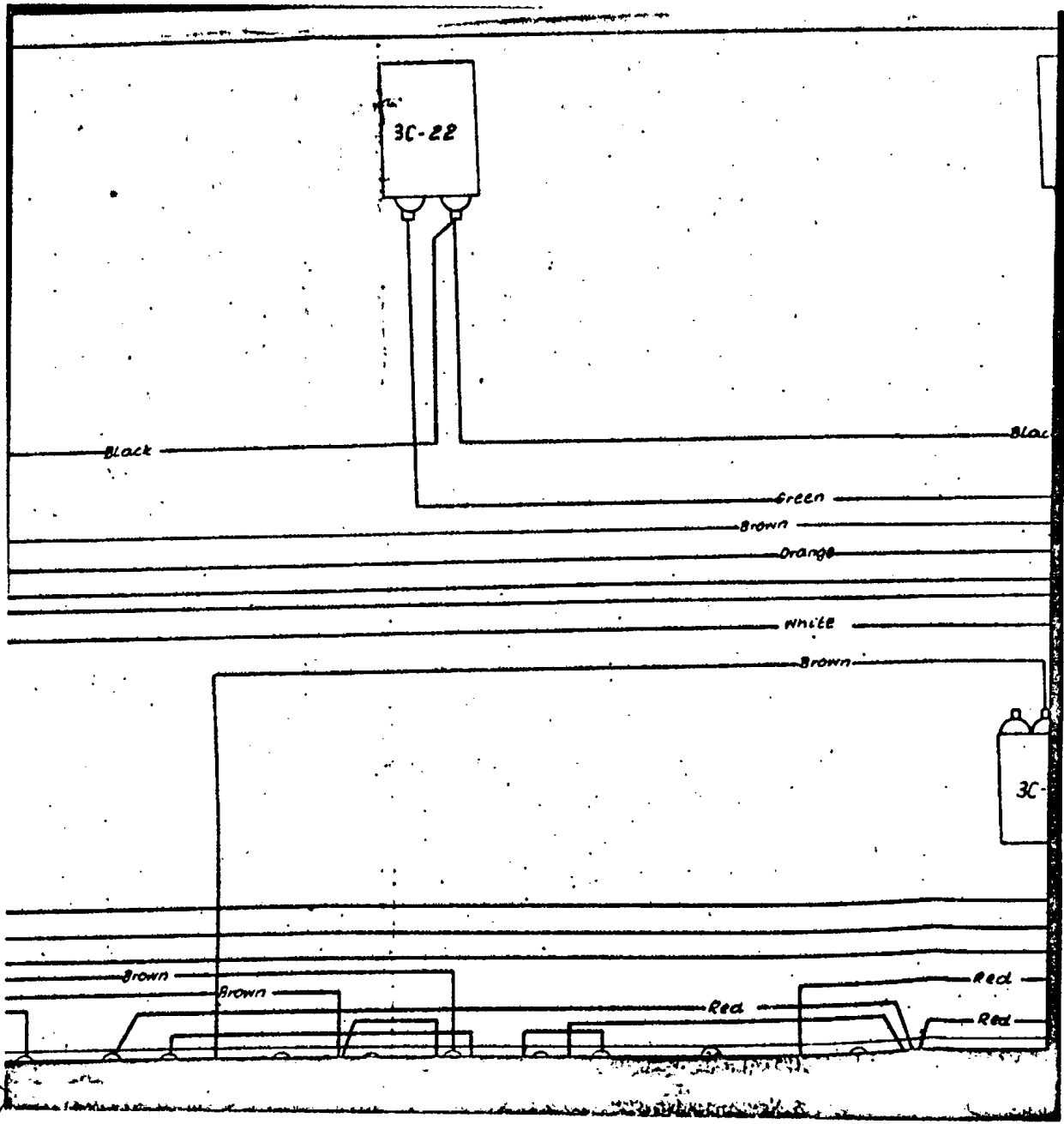

S-E-C-R-E-T
NO FOREIGN DISSEM

NO FOREIGN DISSEM

50X1-HUM

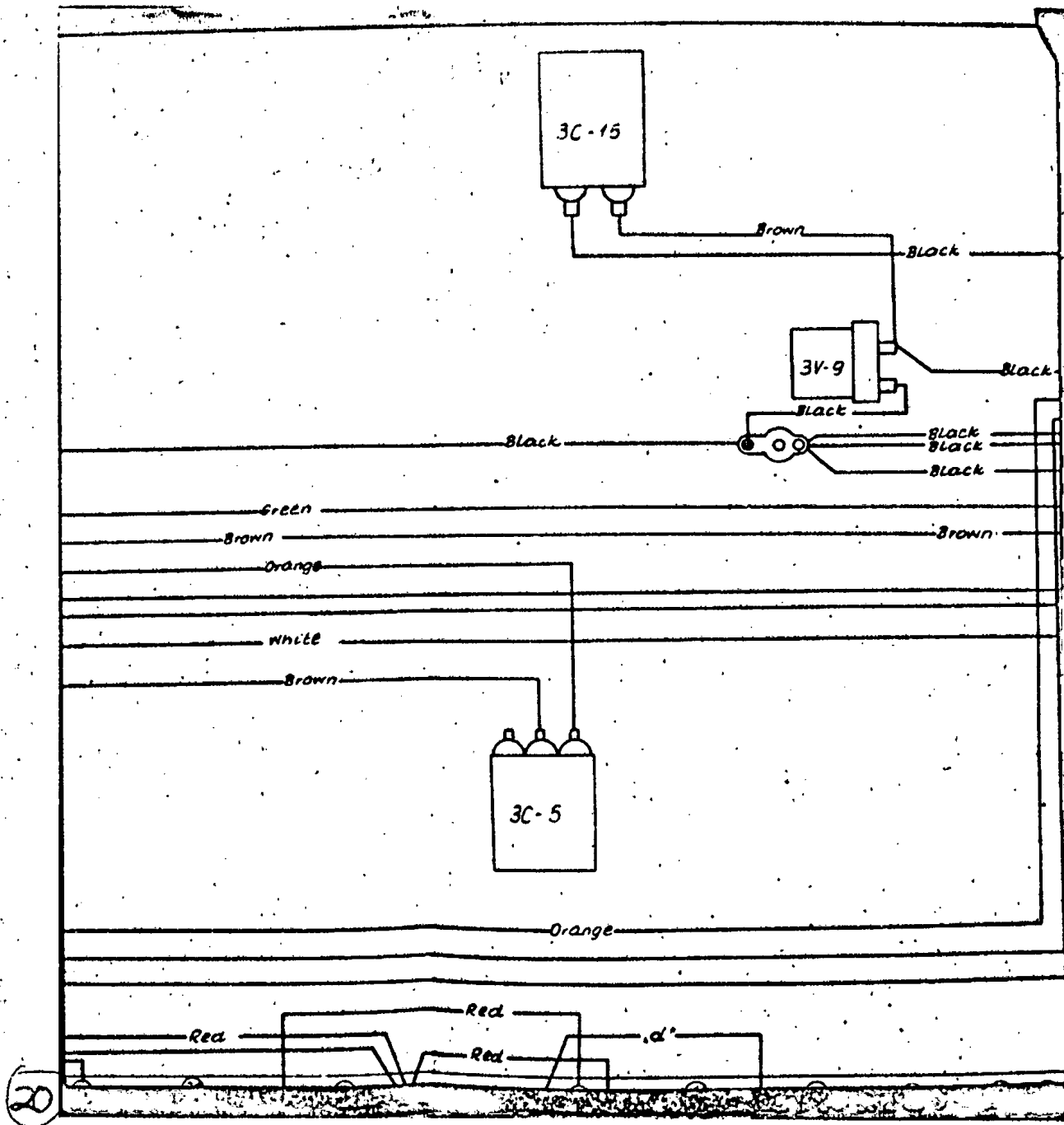

S-E-C-R-E-T

NO FOREIGN DISSEM

50X1-HUM

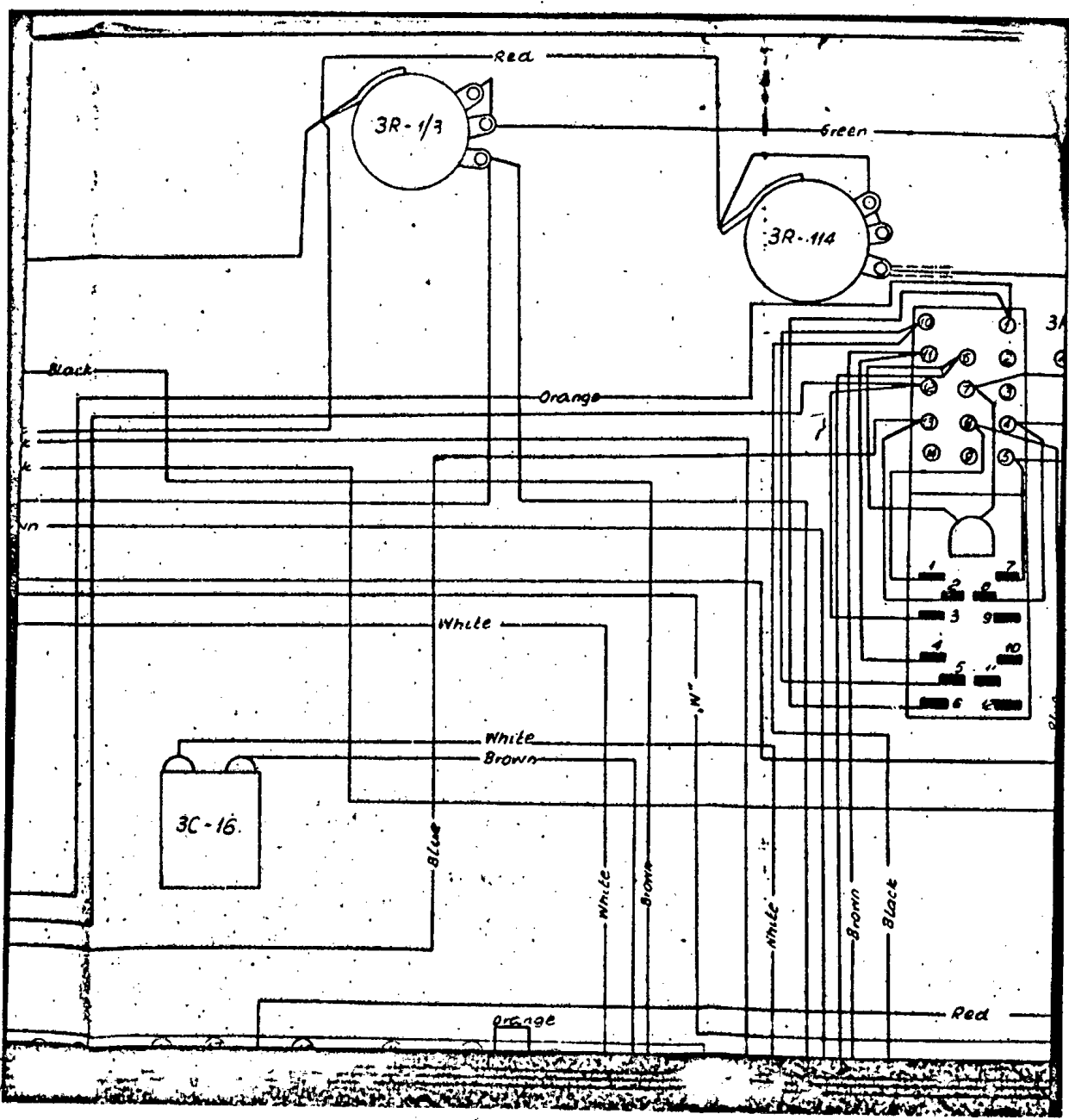

S-E-C-R-E-T
NO FOREIGN DISSEM

NO FOREIGN DISSEM

50X1-HUM

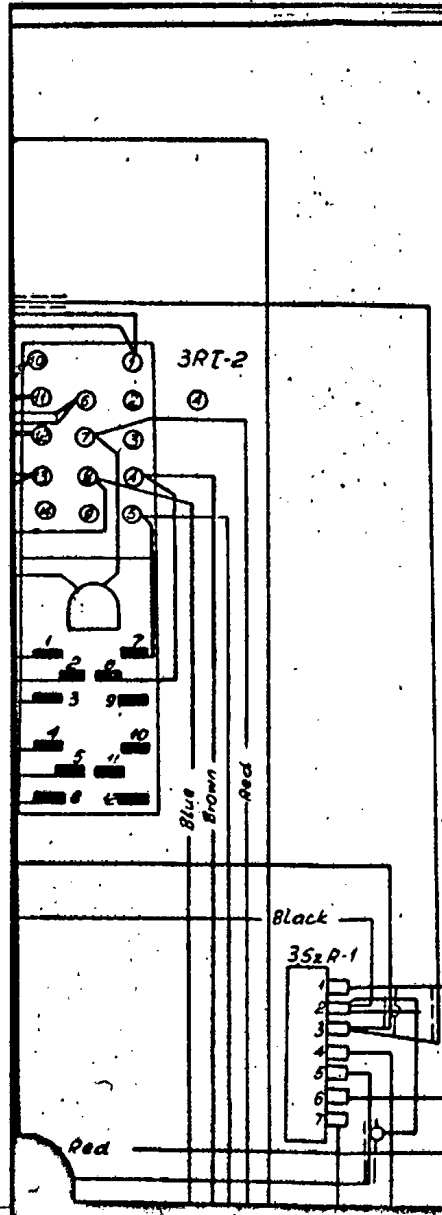

Remarks:

1. Montage should be done according to DTU for assembling and fitting of fabric WPO 005-010 TU.
2. All inside connections should be done with MGR-0.35mm² wire coloured according to the diagram.
3. Heaters circuits (yellow) should be done with MGR-0.5mm² wire.
4. For connections marked: "b" use BPWT-1mm² wire
"m" use BPWE-0.35mm². On whole length, the chlorovinyl sleeves should be put on and the screen should be earthed with ϕ 0.5 mm tinned copper wire.
5. Valve socket connection make with ϕ 0.5 tinned copper wire but on connections marked "a" put ϕ 1mm chloro-vinyl sleeves.
6. Make earthing bar of ϕ 1.5 mm tinned copper wire.
7. Connections on front panel make with BPWT-1mm² wire marked "b".

CD-1	
C-68	OZQ46
C-66	GOSL 61
3C-65	GOSL 61
3C-64	GOSL 61
3C-62	GOSL 61
3C-61	GOSL 61
3C-60	GOSL 61
3C-59	GOSL 61
3C-54	GOSL 61
3C-52	OZQ46
3C-47	OZQ46
3C-42	GOSL 61
3C-31	OZQ46
3C-21	OZQ46
3C-20	OZQ46
3C-18	OZQ46
3C-17	OZQ46
3C-14	OZQ46
3C-13	GOSL 61
3C-12	OZQ46
3C-11	GOSL 61
3C-10	OZQ46
3C-9	GOSL 61
3C-8	OZQ46
3C-7	GOSL 61
3C-1	GOSL 61
3P-113	GOSL 61
3P-113	GOSL 61

22

S-E-C-R-E-T

NO FOREIGN DISSEM

NO FOREIGN DISSEM

50X1-HUM

	CD-1		Cristal 2G-C4	1
	C-68	DZO46201TK	Condenser BEM-2-400-0.01-1-U	1
	C-66	Gost 6119-54	Condenser KSP-5-500-B-3100-U	1
	3C-65	Gost 6119-54	Condenser KSO-5-500-W-4700-U	1
	3C-64	Gost 6118-52	Condenser KRGZ-200-0.03-U	1
	3C-62	Gost 6119-54	Condenser KSO-2-500-W-1000-U	1
	3C-61	Gost 6119-54	Condenser KSO-2-500-W-150-U	1
	3C-60	Gost 6118-52	Condenser KRGZ-200-0.03-U	1
	3C-59	Gost 6119-54	Condenser KSO-2-500-W-1000-U	1
	3C-54	Gost 6119-54	Condenser KSO-5-500-W-2200-U	1
	3C-52	OZO46201TU	Condenser BEM-2-400-0.01-U	1
	3C-47	OZO46201TU	Condenser BEM-2-400-0.01-U	1
	3C-42	Gost 6119-54	Condenser KSO-2-500-W-1000-U	1
	3C-51	OZO46201TU	Condenser BEM-2-400-0.01-U	1
	3C-21	OZO46201TU	Condenser BEM-2-400-0.03-U	1
	3C-20	OZO46201TU	Condenser BEM-2-400-0.01-U	1
	3C-18	OZO46201TU	Condenser BEM-2-400-0.01-U	1
	3C-17	OZO46201TU	Condenser KSO-2-500-W-1000-U	1
	3C-14	OZO46201TU	Condenser BEM-2-400-0.033-U	1
	3C-13	Gost 6119-54	Condenser KSO-2-500-W-220-U	1
	3C-12	OZO46201TU	Condenser BEM-2-400-0.01-U	1
	3C-11	Gost 6119-54	Condenser KSO-2-500-W-220-U	1
	3C-10	OZO46201TU	Condenser BEM-2-400-0.001-U	1
	3C-9	Gost 6119-54	Condenser KSO-5-500-W-1000-U	1
	3C-8	OZO46201TU	Condenser BEM-2-400-0.01-U	1
	3C-7	Gost 6119-54	Condenser KSO-2-500-W-220-U	1
	3C-1	Gost 6119-54	Condenser KSO-5-500-W-2200-U	1
	3R-114	Gost 5574-50	Resistance sp-U-20-23A	1
	3R-113	Gost 5574-50	Resistance sp-U-2A-680-13A	1

OTU for assem-
TU.

with MSR-0.35mm²

with MSR-0.5mm²

-1mm²

-0.35mm². On whole

put on and the
lined copper

as lined copper
put φ 1mm chloro

pper wire.

BPWL-1mm² wire

23

S-E-C-R-E-T

NO FOREIGN DISSEM

50X1-HUM

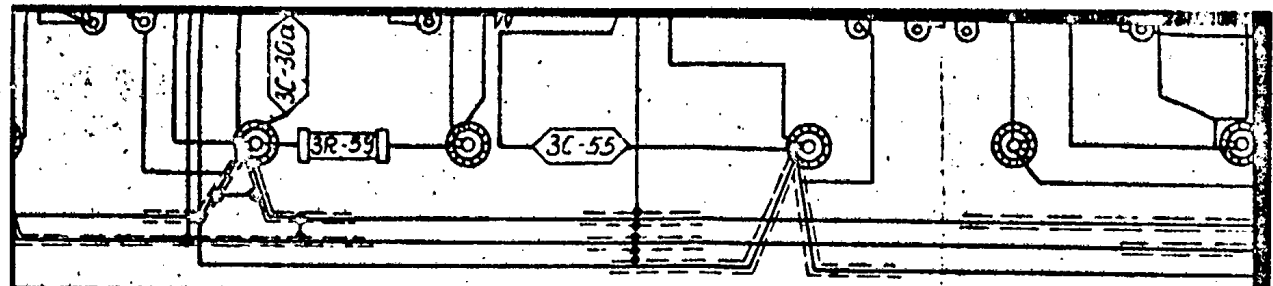

Pos No	Part No	Name	Qty	Remarks	Pos No	Design
		chloromyl sleeve 8 STUMPER 1325-47	0.03M		3C-46	O204
		chloromyl sleeve 10 STUMPER 1325-47	0.03M		3C-45	GOST
		chloromyl sleeve 8 STUMPER 1325-47	0.1M		3C-44	GOST
		wire BPWLE 0.35 mm WTUMPER 623-47	1M		3C-43	GOST
		wire BPWLE 0.35 mm WTUMPER 623-47	1M		3C-41	GOST
		tinned copper wire 1.53 mm WTUMPER 623-47	1M		3C-38	O20
		tinned copper wire 1.53 mm WTUMPER 623-47	1M		3C-37	O20
		sleeve 8 174 Sapprom 2016ku 7-51	1M		3C-36	GOST
		sleeve 8 174 Sapprom 2016ku 7-51	0.002		3C-35	GOST
		solder POS-61 GOST 1450-54	1		3C-34	GOST
3L-17	U-228200B	choke 2.0 6.33 mH	1		3C-33	GOST
3L-15	G7-7770035P	choke 2.12 5uH ±10%	1		3C-32	GOST
3L-14	G7-7770035P	choke 2.12 5uH ±10%	1		3C-31	GOST
3L-13	G7-7770035P	choke 2.12 5uH ±10%	1		3C-30a	GOST
3L-11	G7-7770035P	choke 2.12 5uH ±10%	1		3C-30	GOST
3L-10	G7-7770035P	choke 2.12 5uH ±10%	1		3C-29	GOST
3L-9	G7-7770035P	choke 2.12 5uH ±10%	1		3C-28	GOST
3L-8	G7-7770035P	choke 2.12 5uH ±10%	1		3C-27	GOST
3L-6	G7-7770035P	choke 2.01 10uH ±5%	1		3C-26	GOST
3C-63	GOST-6119-54	condenser K50-2-500-5-1000-7	1		3C-26	GOST
3C-59			1		3C-25a	GOST
3C-58	GOST-7159-54	condenser K50-2-500-5-1000-7	1		3C-24	GOST
3C-57	GOST-6119-54	condenser K50-2-500-5-1000-7	1		3C-23	GOST
3C-56	GOST-6119-54	condenser K50-2-500-5-1000-7	1		3R-89	O204
3C-53	GOST-6119-54	condenser K50-2-500-5-1000-7	1		3R-88	O204
3C-48	GOST-6119-54	condenser K50-2-500-5-1000-7	1		3R-87	O204

S-E-C-R-E-T
 NO FOREIGN DISSEM

S-E-C-R-E-T
NO FOREIGN DISSEM

50X1-HUM

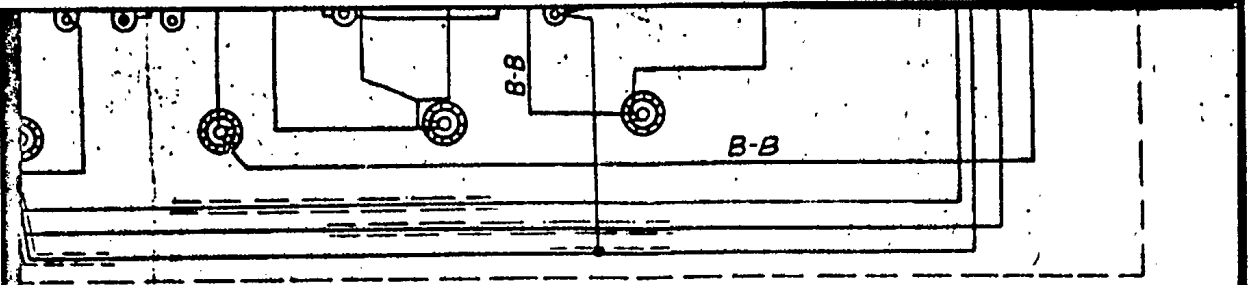

Qty	Remarks	Pos No	Designation	Name	Qty	Remarks
1		3C-46	OZO4620MTU	Condenser 85-2-400-3-1000-I	1	3R-86
1		3C-45	GOST 6119-54	Condenser K50-2-500-6-1000-I	1	3R-79
1		3C-44	GOST 6119-54	Condenser K50-2-500-6-1000-I	1	3R-76
1		3C-43	GOST 6119-54	Condenser K50-2-500-6-1000-I	1	3R-61
1		3C-41	GOST 6119-54	Condenser K50-2-500-6-1000-I	1	3R-65
1		3C-38	OZO 4620MTU	Condenser BEM-2-400-3-1000-I	1	3R-64
1		3C-37	OZO4620MTU	Condenser BEM-2-400-3-1000-I	1	3R-63
1		3C-36	GOST 6119-54	Condenser K50-2-500-6-1000-I	1	3R-62
1		3C-35	GOST 6119-54	Condenser K50-2-500-6-1000-I	1	3R-61
1		3C-34	GOST 6119-54	Condenser K50-2-500-6-1000-I	1	3R-60
1		3C-33	GOST 6119-54	Condenser K50-2-500-6-1000-I	1	3R-59
1		3C-32	GOST 6119-54	Condenser K50-2-500-6-1000-I	1	3R-58
1		3C-31	GOST 6119-54	Condenser K50-2-500-6-1000-I	1	3R-57
1		3C-30a	GOST 6119-54	Condenser K50-2-500-6-1000-I	1	3R-56
1		3C-30	GOST 6119-54	Condenser K50-2-500-6-1000-I	1	3R-55
1		3C-29	GOST 6119-54	Condenser K50-2-500-6-1000-I	1	3R-54
1		3C-28	GOST 6119-54	Condenser K50-2-500-6-1000-I	1	3R-53
1		3C-27	GOST 6119-54	Condenser K50-2-500-6-1000-I	1	3R-52
1		3C-26	GOST 6119-54	Condenser K50-2-500-6-1000-I	1	3R-51
1		3C-26	GOST 6119-54	Condenser K50-2-500-6-1000-I	1	3R-50
1		3C-25a	GOST 6119-54	Condenser K50-2-500-6-1000-I	1	3R-49
1		3C-24	GOST 6119-54	Condenser K50-2-500-6-1000-I	1	3R-48
1		3C-23	GOST 6119-54	Condenser K50-2-500-6-1000-I	1	3R-47
1		3R-89	OZO467003TU	Resistance MT-2-51K5-I	1	Pos No
1		3R-88	OZO467003TU	Resistance MT-05-220R-I	1	
1		3R-87	OZO467003TU	Resistance MT-05-220R-I	1	

15

S-E-C-R-E-T

NO FOREIGN DISSEM

S-E-C-R-E-T
NO FOREIGN DISSEM

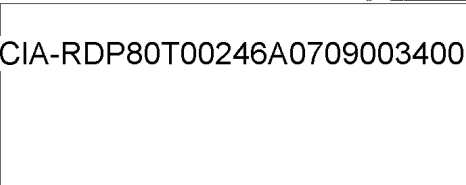

50X1-HUM

3R-86	OZO467003TU	Resistance Net - 13.2K-1	1	
3R-79	OZO467003TU	Resistance Net - 13.2K-1	1	
3R-76	OZO467003TU	Resistance Net - 13.2K-1	1	
3R-66	OZO467003TU	Resistance Net - 0.5-430K-1	1	
3R-65	OZO467003TU	Resistance Net - 0.5-75K-1	1	
3R-64	OZO467003TU	Resistance Net - 0.5-1000K-1	1	
3R-63	OZO467003TU	Resistance Net - 0.5-2.4K-1	1	Should be selected when tuning
3R-62	OZO467003TU	Resistance Net - 0.5-220K-1	1	
3R-61	OZO467003TU	Resistance Net - 0.5-200K-1	1	
3R-60	OZO467003TU	Resistance Net - 0.5-220K-1	1	
3R-59	OZO467003TU	Resistance Net - 0.5-200K-1	1	
3R-58	OZO467003TU	Resistance Net - 0.5-200K-1	1	Should be selected when tuning
3R-57	OZO467003TU	Resistance Net - 0.5-220K-1	1	
3R-56	OZO467003TU	Resistance Net - 0.5-220K-1	1	
3R-55	OZO457003TU	Resistance Net - 0.5-200K-1	1	Should be selected when tuning
3R-54	OZO467003TU	Resistance Net - 0.5-220K-1	1	
3R-53	OZO467003TU	Resistance Net - 0.5-220K-1	1	
3R-52	OZO467003TU	Resistance Net - 0.5-220K-1	1	Should be selected when tuning
3R-51	OZO467003TU	Resistance Net - 0.5-220K-1	1	
3R-50	OZO467003TU	Resistance Net - 0.5-220K-1	1	
3R-49	OZO467003TU	Resistance Net - 0.5-200K-1	1	
3R-48	OZO467003TU	Resistance Net - 0.5-220K-1	1	Should be selected when tuning
3R-47	OZO467003TU	Resistance Net - 0.5-220K-1	1	
POS	Resistor	Value	Qty	Remarks

Intermediate Frequency
amplifier
Wiring diagram

GJa 2.031001/sch/s
page 53

④ Remarks

S-E-C-R-E-T
NO FOREIGN DISSEM

NO FOREIGN DISSEM

50X1-HUM

Remarks:

1. For connections marked "e" use wire BPWLE 0,35 mm².
- "B-B" use wire BPWt 0,35 mm².
- "P" use $\phi 0,8$ tinned copper wire.
2. All earthing connections made of $\phi 0,5$ tinned copper wire.
3. Screen cover BPWLE solder straight to earthing bar.
4. Wires marked "A" are coil circuit leads.
5. On the wires marked "W" and "P" put chlorovinyl sleeve $\phi 1$.
6. Radio details fit over chassis in the distance no more than 3 mm.
7. Resistances marked "x x" should be selected when tuning, soldering made when fitting and fixing after tuning.
8. Valve sockets fit with valves in.
9. After screens soldering is done, ensure yourself, by the TT-1 tester if there is no short circuit to the earth.
10. Do the soldering with solder POS-61.
11. Put the $\phi 3,5$, L= 15 mm sleeves on resistances 3R-87, 3R-60 and on chokes 3L-14, 3L-15.
12. The point marked "xxx" should be soldered when fitting but fixing should be done after tuning.
13. Radio details should be marked with DM enamel, black or white. The M7-05 resistances print only the ordinal numbers.
14. Put $\phi 6$, L= 15 mm chlorovinyl sleeve on 3R-39 resistance.
15. Put $\phi 10$, L= 20 mm chlorovinyl sleeve on 3C-38, 3C-37, 3C-31 and $\phi 10$, L= 15 mm on 3C-45.
16. Put $\phi 1$, L= 15 mm chlorovinyl sleeve on the wire 3C-46 from second lead of valve 3K-19.

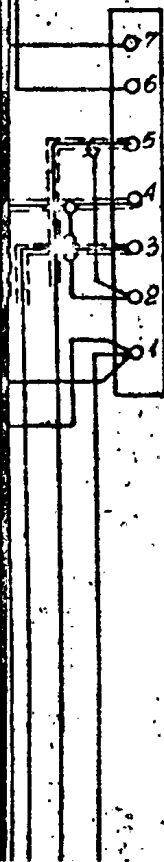

(6)

S-E-C-R-E-T

NO FOREIGN DISSEM

NO FOREIGN DISSEM

50X1-HUM

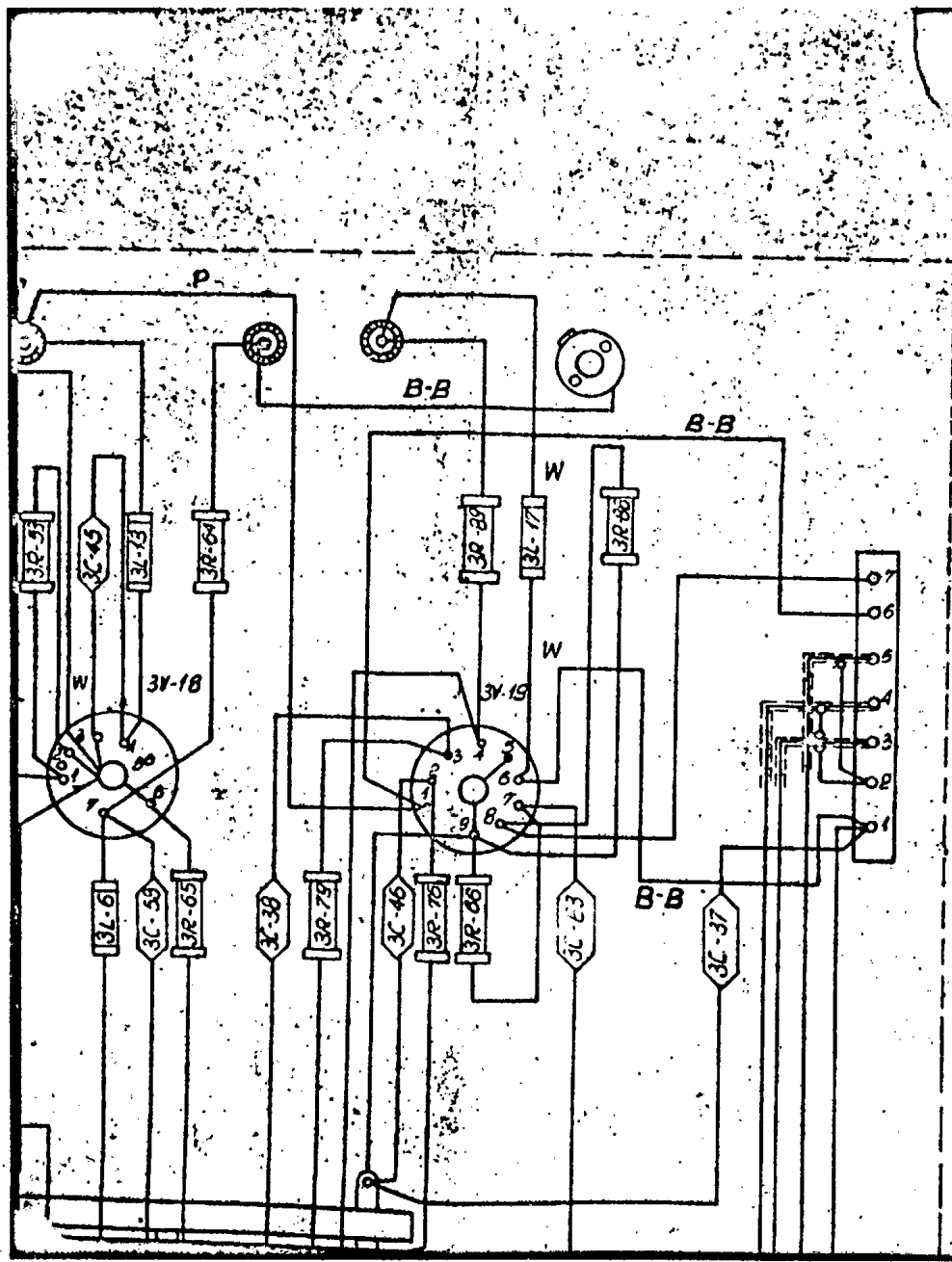

Remarks

1. For connections...
2. All earthing con...
3. Screen cap or BPWL...
4. Wires marked 'A' or...
5. On the wires marked...
6. Radio details in c...
7. Resistances mark...
8. soldering made wh...
9. Valve socket fit v...
10. After sections sold...
11. the TT-1 tester if i...
12. Do the soldering...
13. Put the $\phi 3.5$ L: 15...
14. 3R-60 and on cho...
15. The point marked...
16. but firing should...
17. Radio detais sh...
18. the MIT-05 resis...
19. Put $\phi 6$, L: 15 mm...
20. Put $\phi 10$ L: 20 mm...
21. 3C-51 and $\phi 10$...
22. Put $\phi 1$ L: 15 mm...
23. from secora: esp...

S-E-C-R-E-T

NO FOREIGN DISSEM

S-E-C-R-E-T
NO FOREIGN DISSEM

50X1-HUM

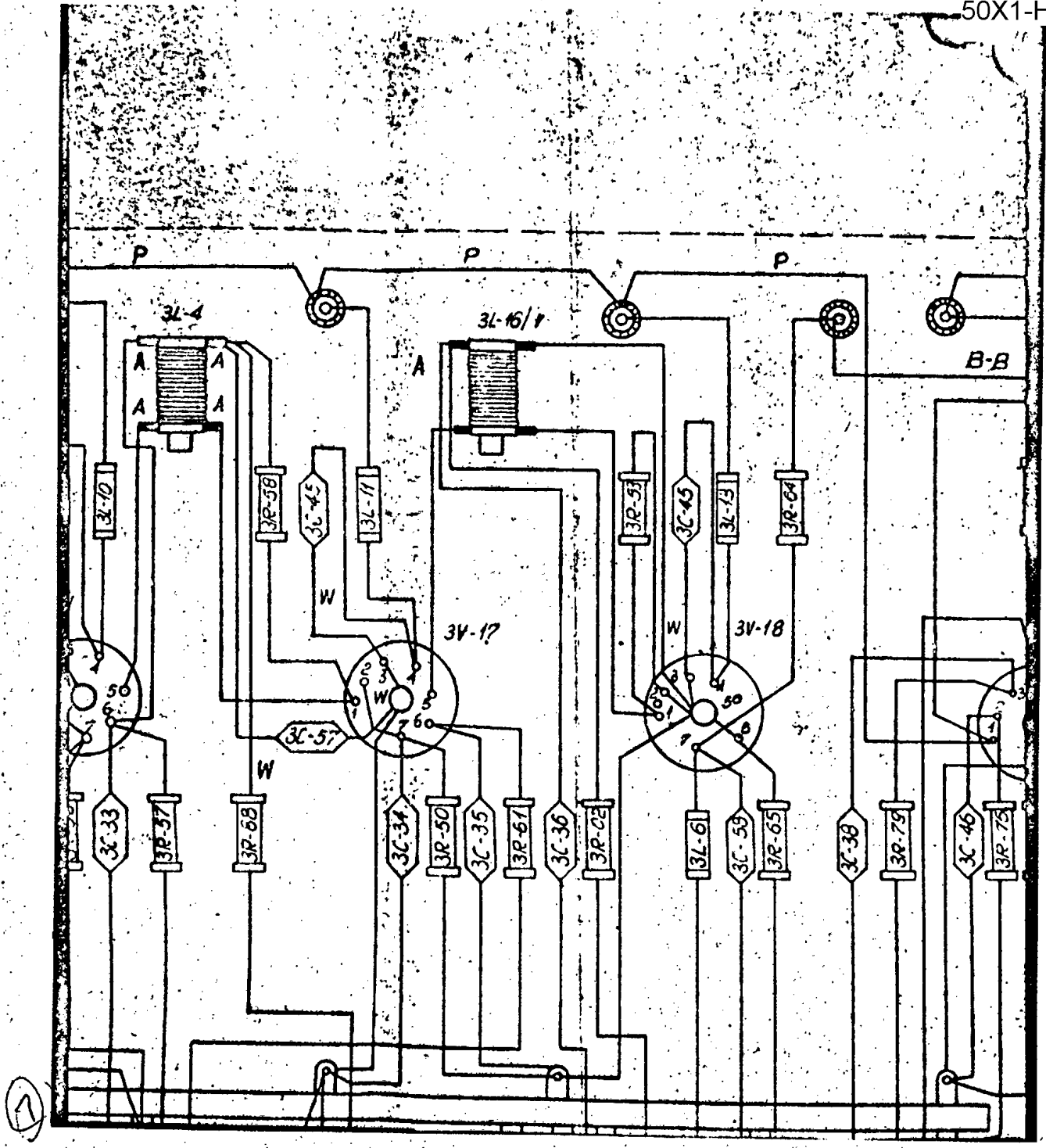

S-E-C-R-E-T
NO FOREIGN DISSEM

50X1-HUM

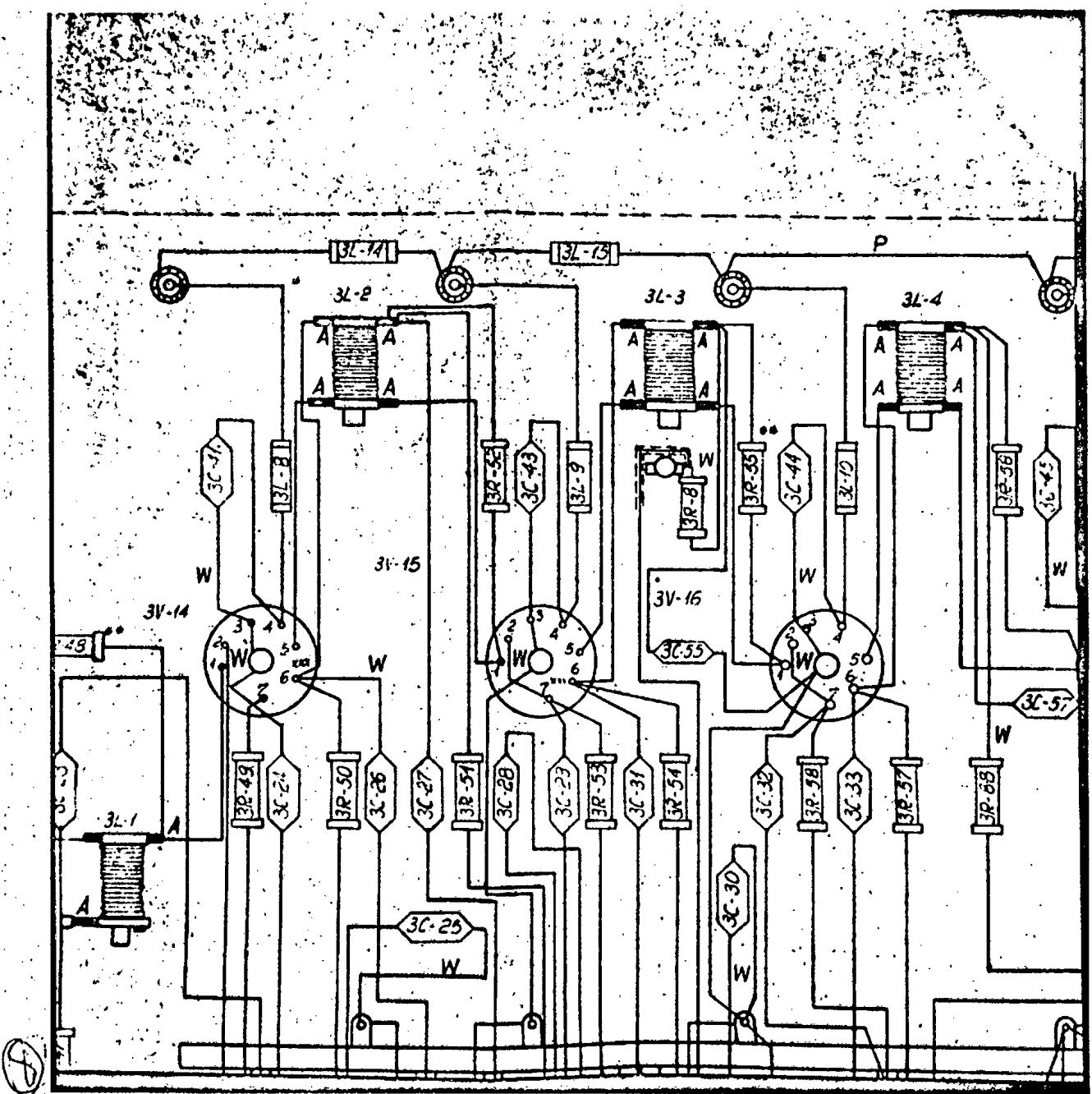

S-E-C-R-E-T
NO FOREIGN DISSEM

NO FOREIGN DISSEM

50X1-HUM

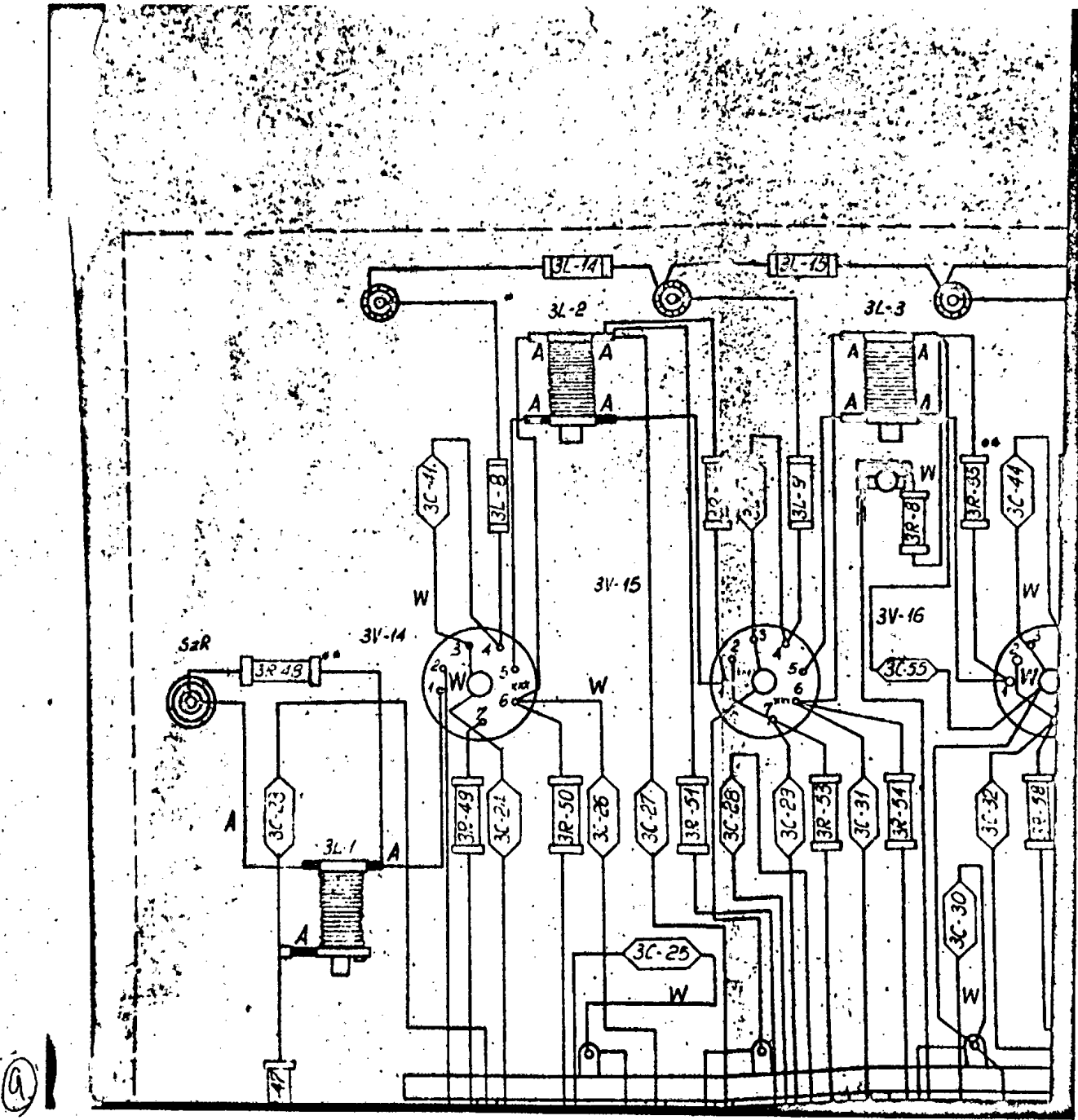

(9)

S-E-C-R-E-T
NO FOREIGN DISSEM

NO FOREIGN DISSEM

50X1-HUM

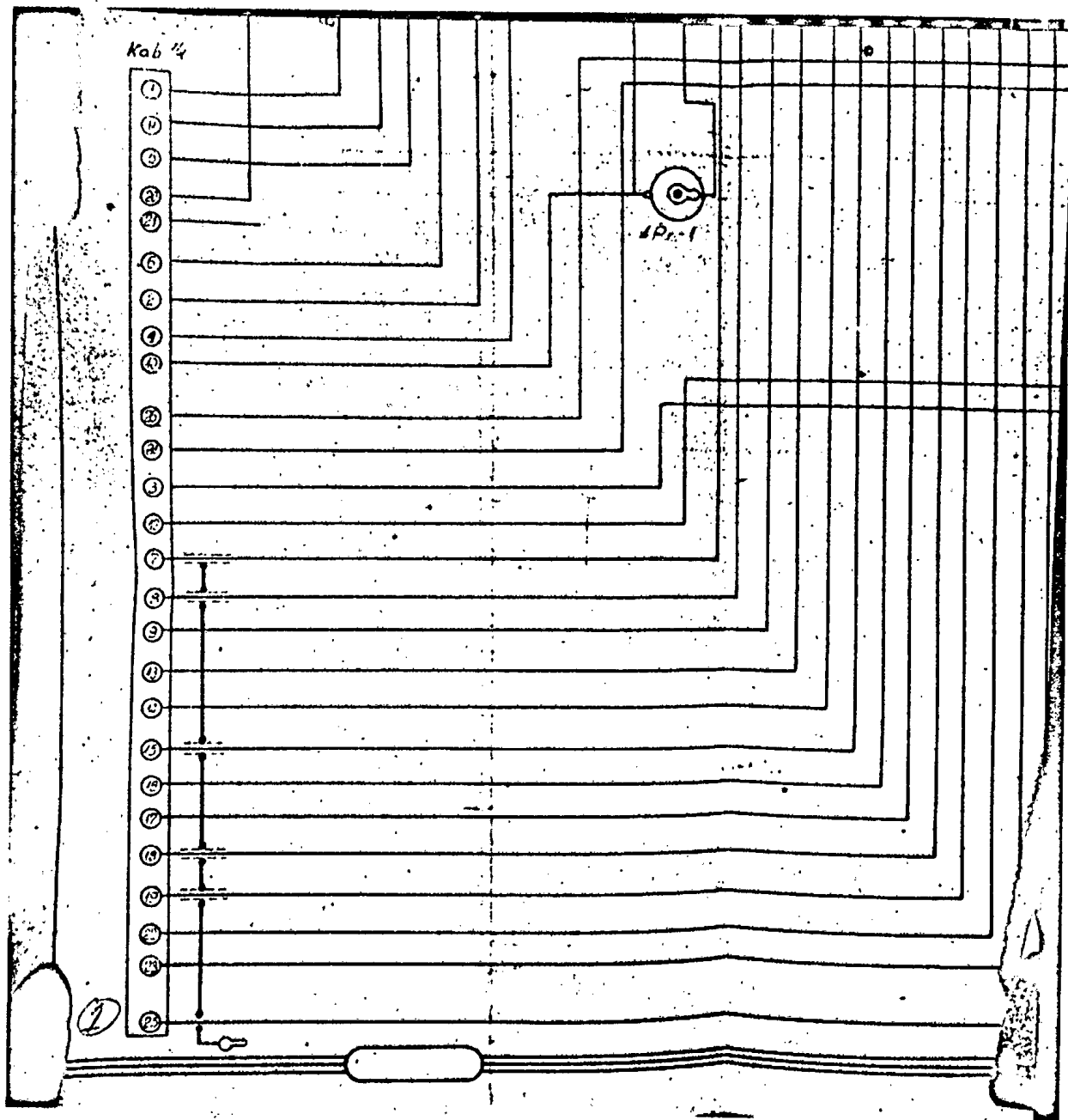

S-E-C-R-E-T

NO FOREIGN DISSEM

50X1-HUM

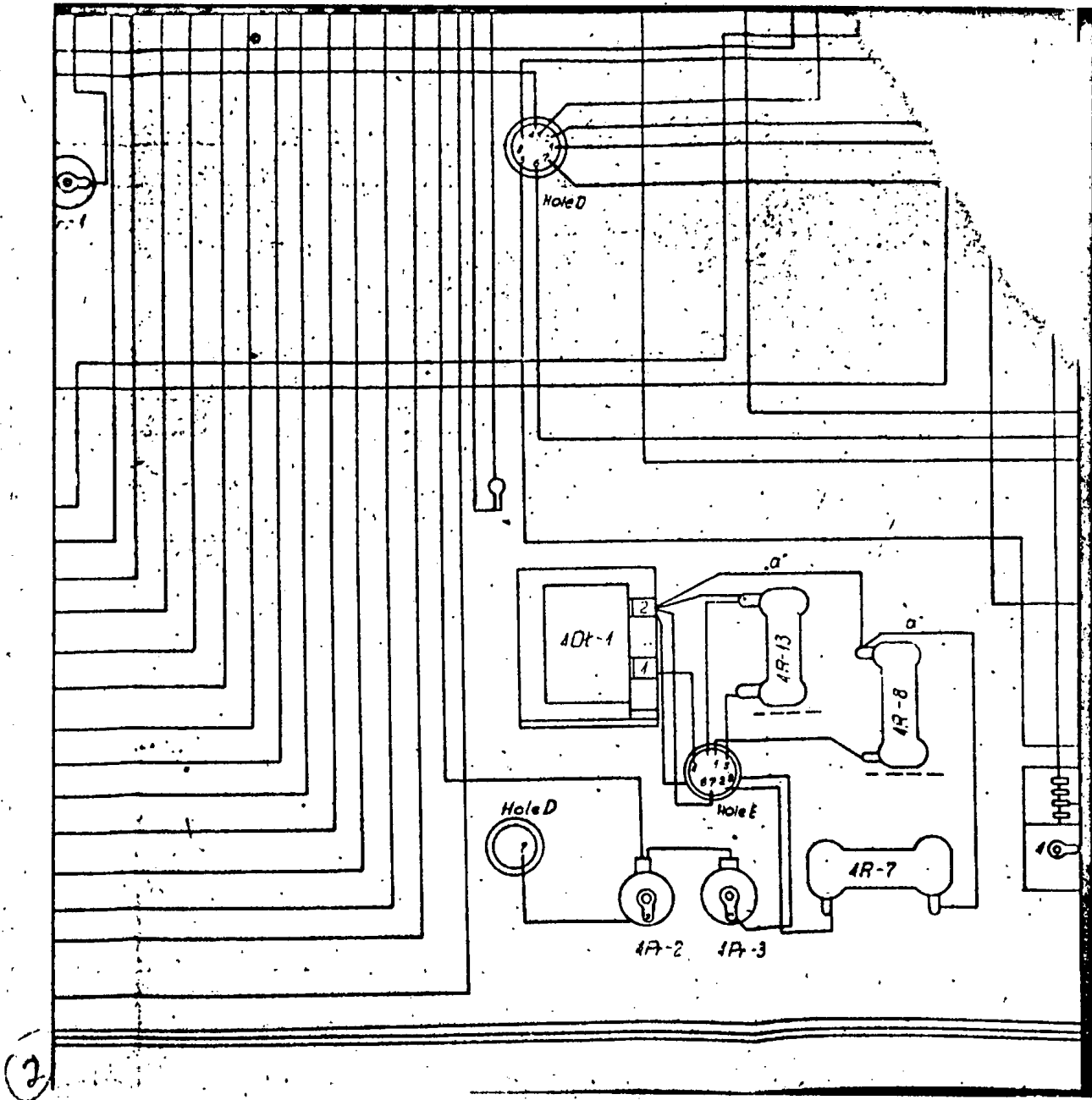

S-E-C-R-E-T
NO FOREIGN DISSEM

50X1-HUM

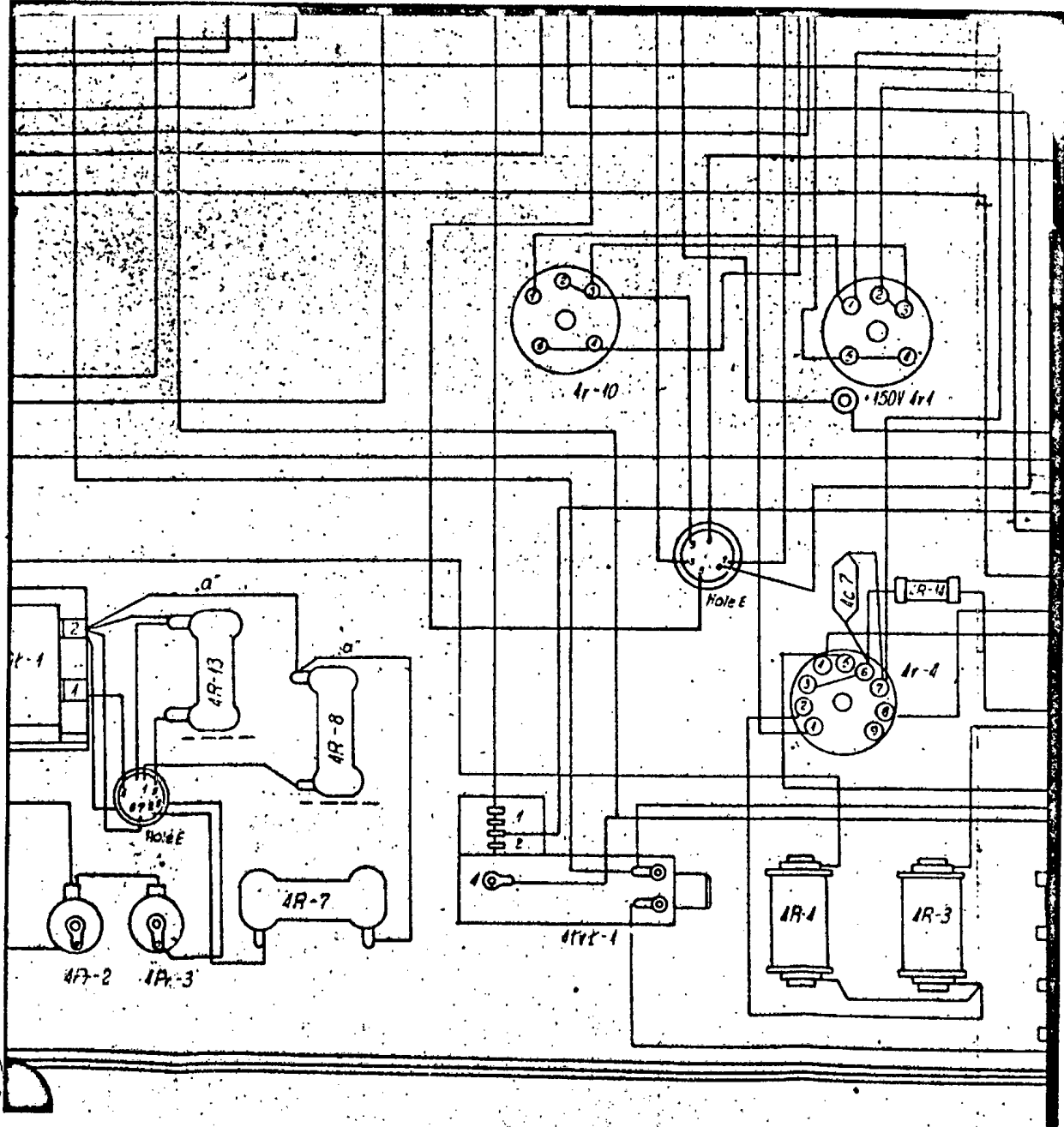

4

S-E-C-R-E-T
NO FOREIGN DISSEM

50X1-HUM

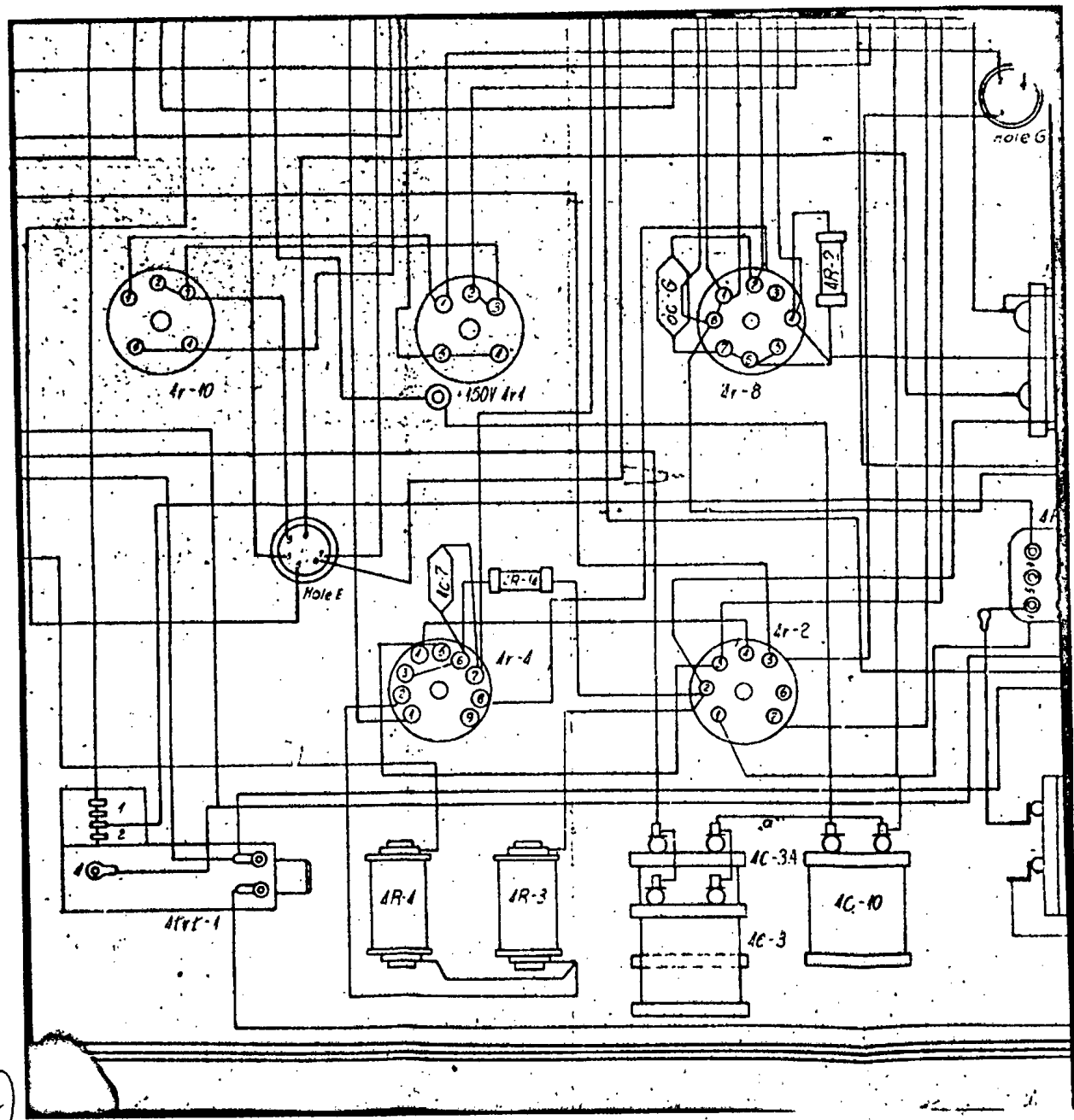

4

S-E-C-R-E-T
NO FOREIGN DISSEM

NO FOREIGN DISSEM

50X1-HUM

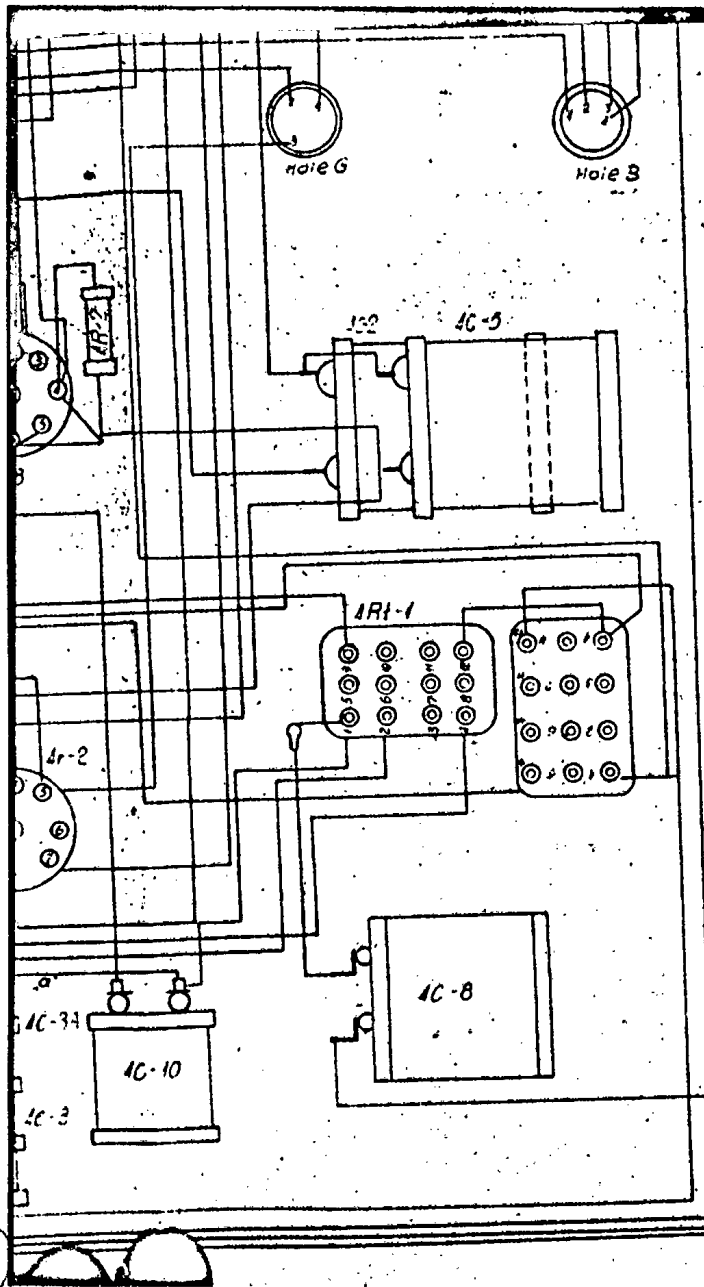

1. Wire P24 to the lead connectio.
2. Make all soldering with solder 20S
3. All wires should be bound together
4. Wire No. 4 of cable 5/4 and wire No. 2 of cable 1/1 should be about 1.5 times longer than the length it is bound.
5. All items should be marked according to the drawing. Resistances type MTT should be marked with 'a'.
6. Put the 4mm chlorovinyl sleeves on wires 4V-3, 4V-4, 4V-5 and 4V-8
7. Connections marked 'a' should be made with copper wire
8. Specification consists of items of group 1 through 12.
 - a/4V-9/5 18 pin/104V-4/18 pin/
 - b/4R-5 to 4C-4
 - c/4C-4 to 4V-4/18 pin/
 - d/4R-5 to 4R-4
 - e/4R-5
 - f/4V-2
 - g/4V-9

No.	Designation	Name
		Chlorovinyl sleeve
		Tinned copper
		Solder 20S-51
		Wicker work Pk
		Tinned copper
		Tinned copper
		Wire BPWLE-5
		Wire BPWLE-14
		Wire BPWLE-2
4C-7	GOST 7159-54	Condenser K1
4C-8	GOST 6119-54	Condenser K2
4R-14	OZO 4670037U	Resistance M
4R-12	OZO 4670037U	Resistance M
4R-14	OZO 4670037U	Resistance M
4R-2	OZO 4670037U	Resistance M
4R-1	OZO 4670037U	Resistance M

Unit 4
Power unit. Wiring diagram

S-E-C-R-E-T

NO FOREIGN DISSEM

S-E-C-R-E-T
NO FOREIGN DISSEM

50X1-HUM

- wire P2x4 to the lead connection.
5. Make all soldering with solder POS-61
 6. All wires should be bound together with No 100 cotton thread.
 7. Wire No 4 of cable 6/4 and wire No 21 of cable 7/4 should be about 1.5 times longer than the whole bunch in which it is bound.
 8. All items should be marked according to the wiring diagram. Resistances type MIT should be marked with ordinal numbers only
 9. Put the 0.1mm chlorovinyl sleeves in connections of valves 4V-3, 4V-4, 4V-5 and 4V-9.
 10. Connections marked "a" should be made of 0.8 mm tinned copper wire
 11. Special wire end finish should be done for following points.
 - a) 4V-9 / 5th pin / to 4V-4 / 1st pin
 - b) 4R-5 to 4C-4
 - c) 4C-4 to 4V-4 / 1st pin
 - d) 4R-5 to 4R-4
 - e) 4R-5 to 46-6
 - f) 4V-2 / 3rd pin
 - g) 4V-9 / 5th pin / to 4V-3 / 5th pin
 12. Specification consists items of given diagram.

		Chlorovinyl sleeve 0.1mm TUMEP-375-47	0.5M	
		Tinned copper wire 0.05mm WNE-278-43	1M	
		Solder POS-61, GOST 1499-54		
		Wicker work PM2x4 WTU 124-54		
		Tinned copper wire 1.5mm	1M	
		Tinned copper wire 0.05mm WNE-278-43	1M	
		Wire BPWLE-0.35mm ² WTUMEP-673-47	1.5M	
		Wire BPWLE-1mm ² WTUMEP-673-47	1.5M	
		Wire BPWLE-0.35mm ² WTUMEP-673-47	10M	
4C-7	GOST 7159-54	Condenser KTK-1M-18-II		
4C-6	GOST 6119-54	Condenser K50-S-250-O-10000-II	1	
4R-14	OZO 467.003TU	Resistance Mit-1-330 KΩ-II	1	
4R-12	OZO 467.003TU	Resistance Mit-0.5-220KΩ-II	1	
4R-14	OZO 467.003TU	Resistance Mit-0.5-220 KΩ-II	1	
4R-2	OZO 467.003TU	Resistance MIT-2-20 KΩ-II	1	
4R-1	OZO 467.003TU	Resistance MIT-1-270KΩ	1	
No. POS	Designation	Name	Q-ty	Remarks

Unit 4
Power unit. Wiring diagram

GJa 2.087.007sch/s
page 54

S-E-C-R-E-T

NO FOREIGN DISSEM

NO FOREIGN DISSEM

50X1-HUM

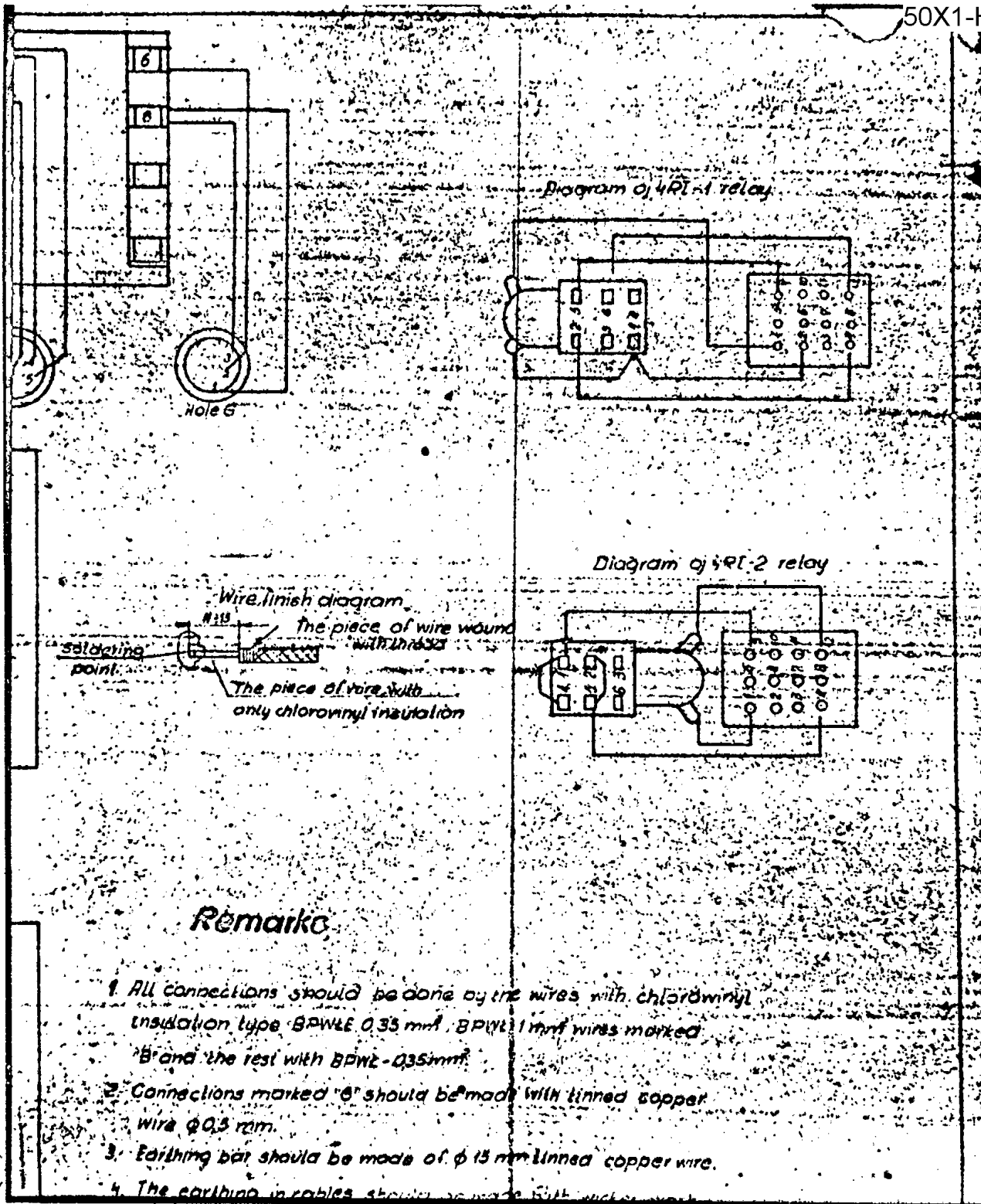

Remarks

1. All connections should be done by the wires with chloro-vinyl insulation type BPWLE 0.35 mm, BPWT 1 mm wires marked "B" and the rest with BPWT-0.35 mm.
2. Connections marked "B" should be made with tinned copper wire $\phi 0.5$ mm.
3. Earthing bar should be made of $\phi 15$ mm tinned copper wire.
4. The earthing cables should be made with nickel wire.

S-E-C-R-E-T

NO FOREIGN DISSEM

SECRET
NO FOREIGN DISSEM

50X1-HUM

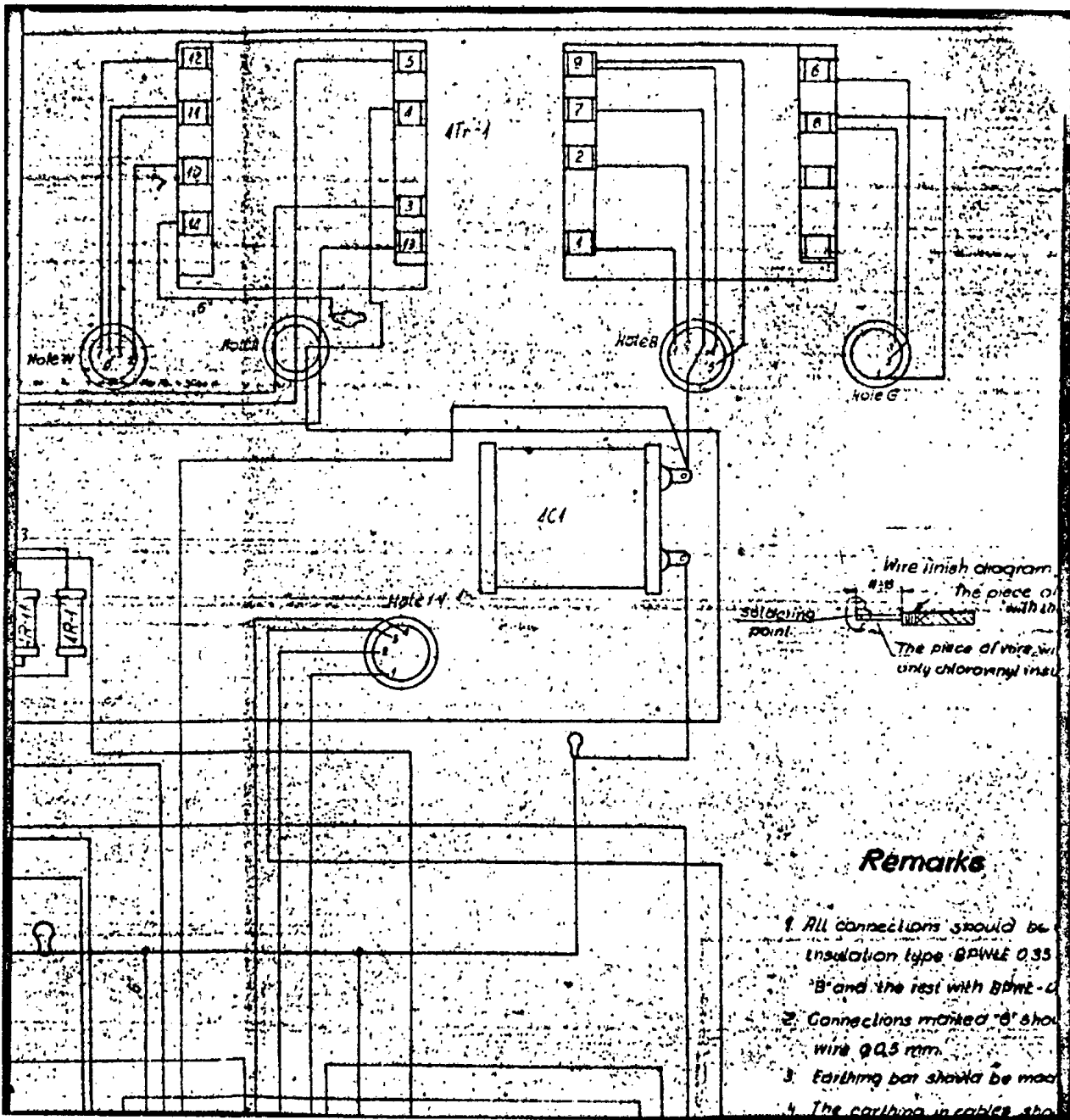

SECRET
NO FOREIGN DISSEM

NO FOREIGN DISSEM

50X1-HUM

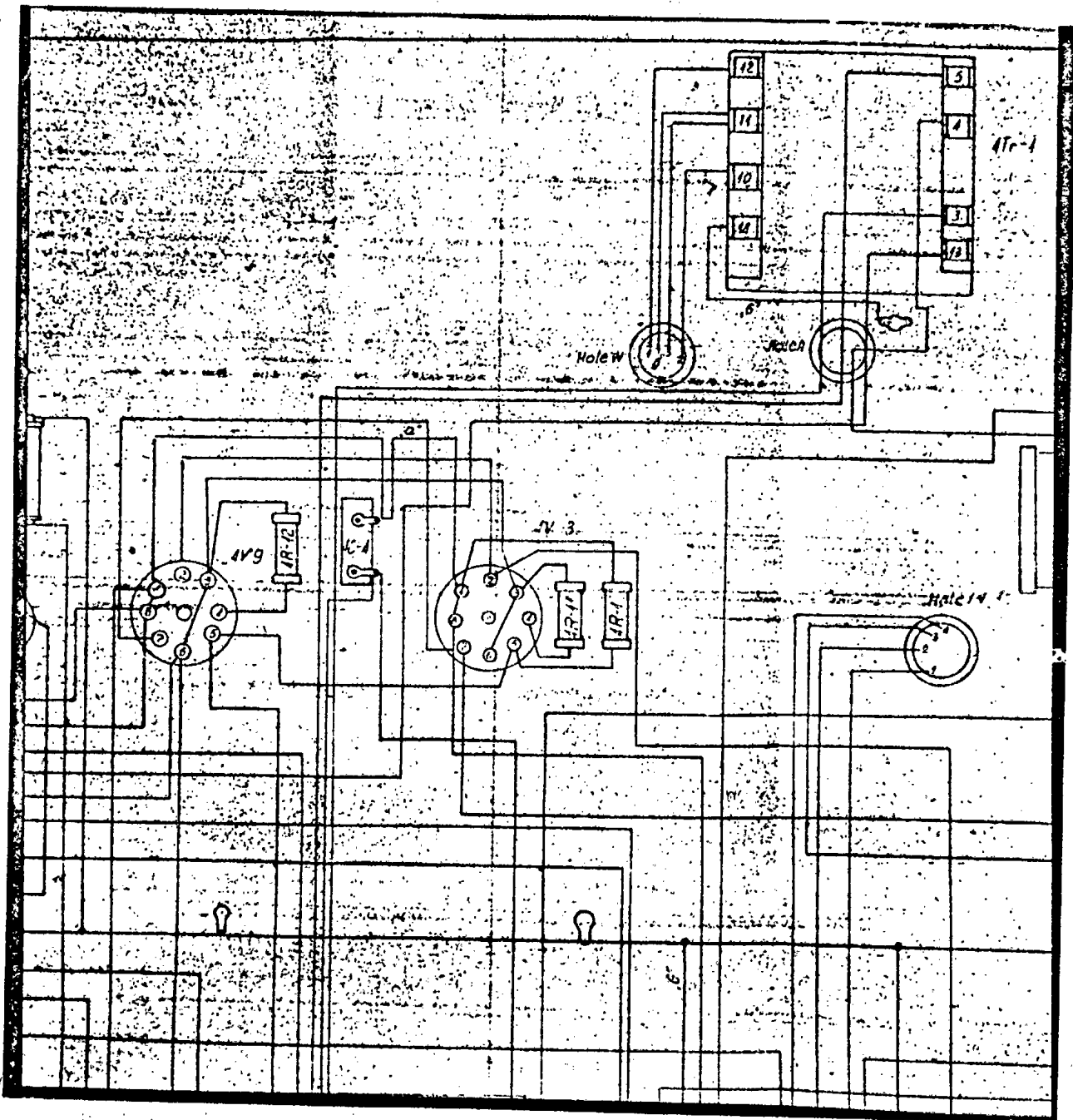

S-E-C-R-E-T

NO FOREIGN DISSEM

NO FOREIGN DISSEM

50X1-HUM

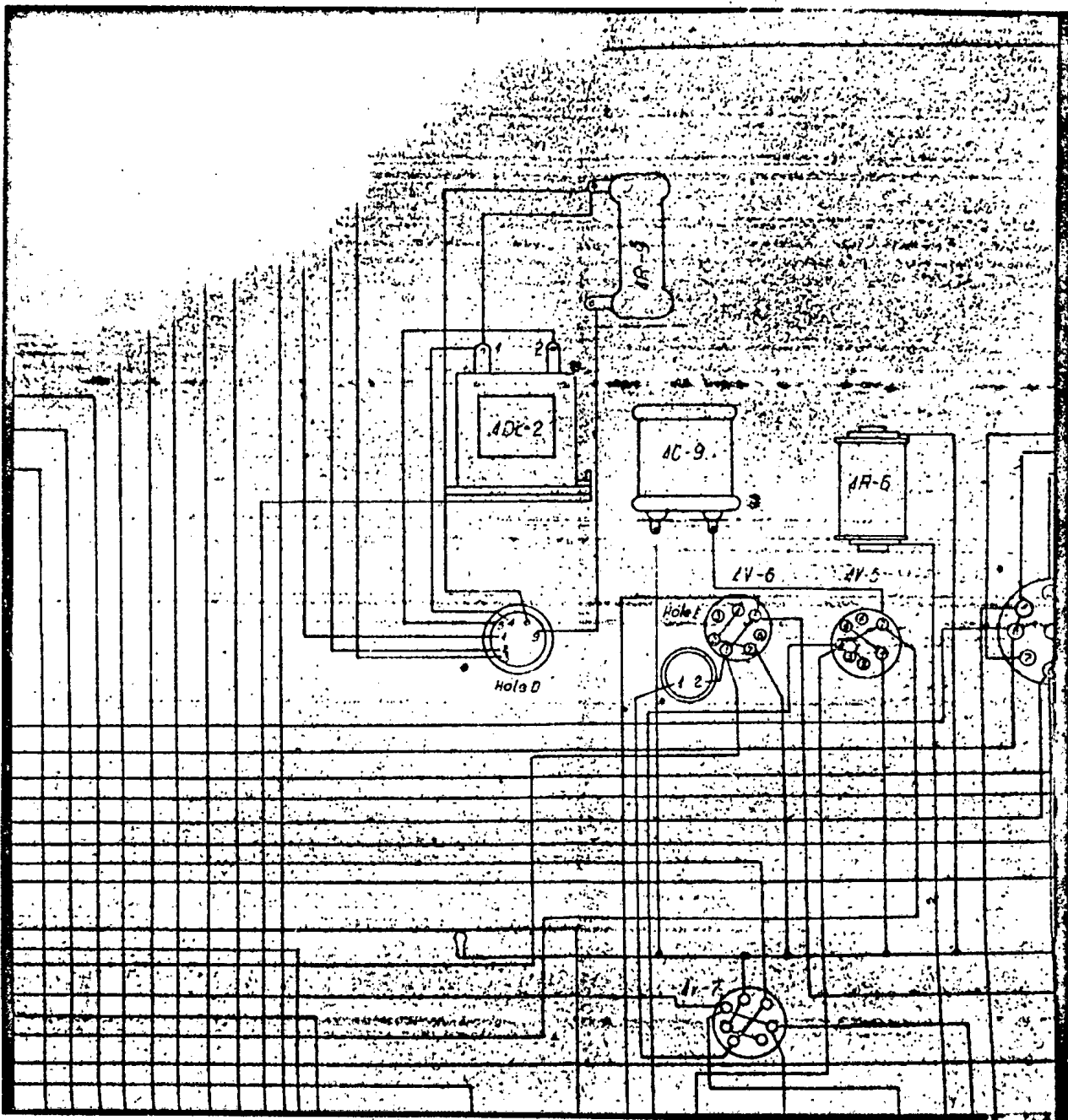

S-E-C-R-E-T

NO FOREIGN DISSEM

S-E-C-R-E-T
NO FOREIGN DISSEM

50X1-HUM

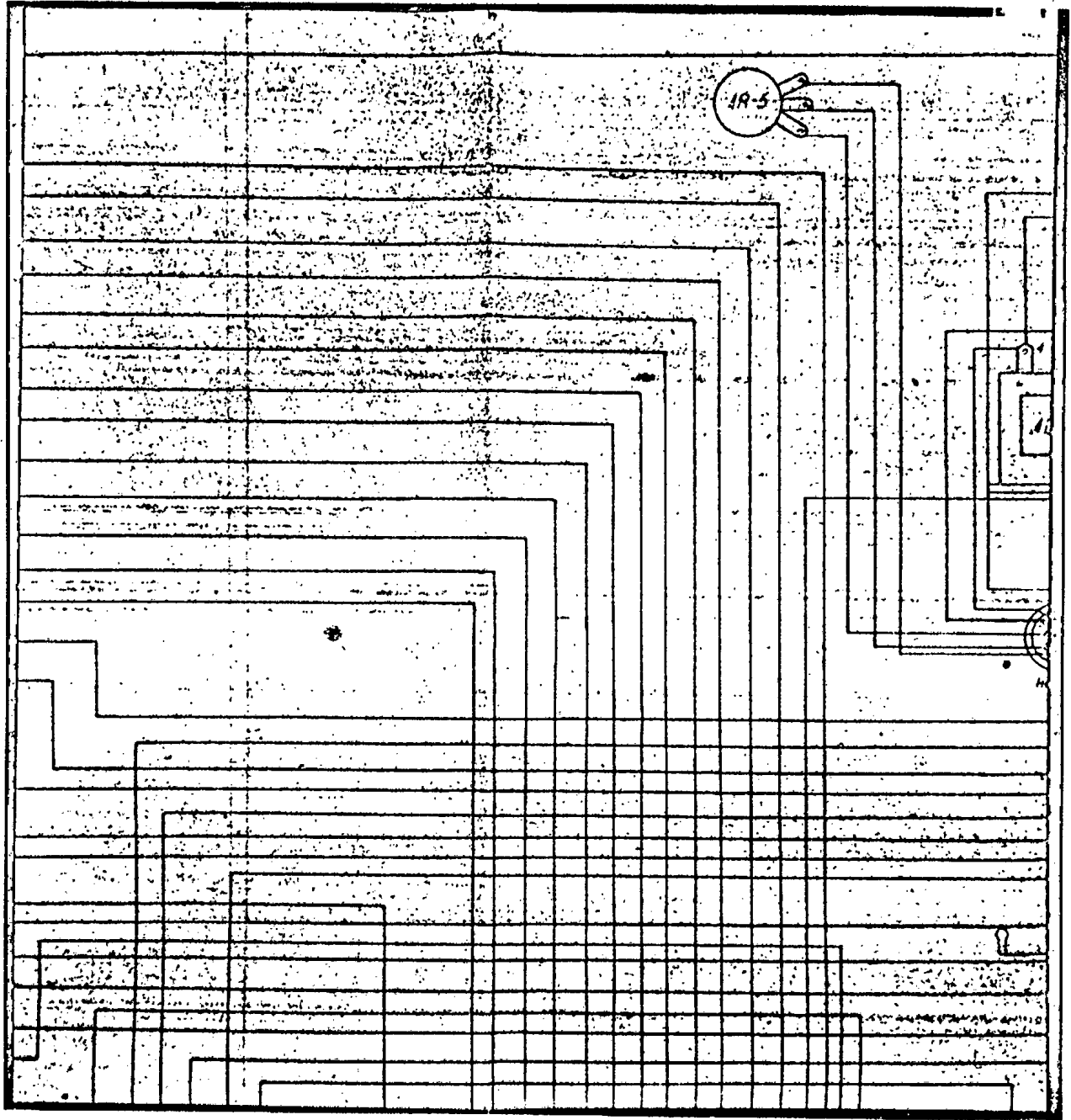

S-E-C-R-E-T
NO FOREIGN DISSEM

NO FOREIGN DISSEM

50X1-HUM

8700754/s
998 54

Remarks

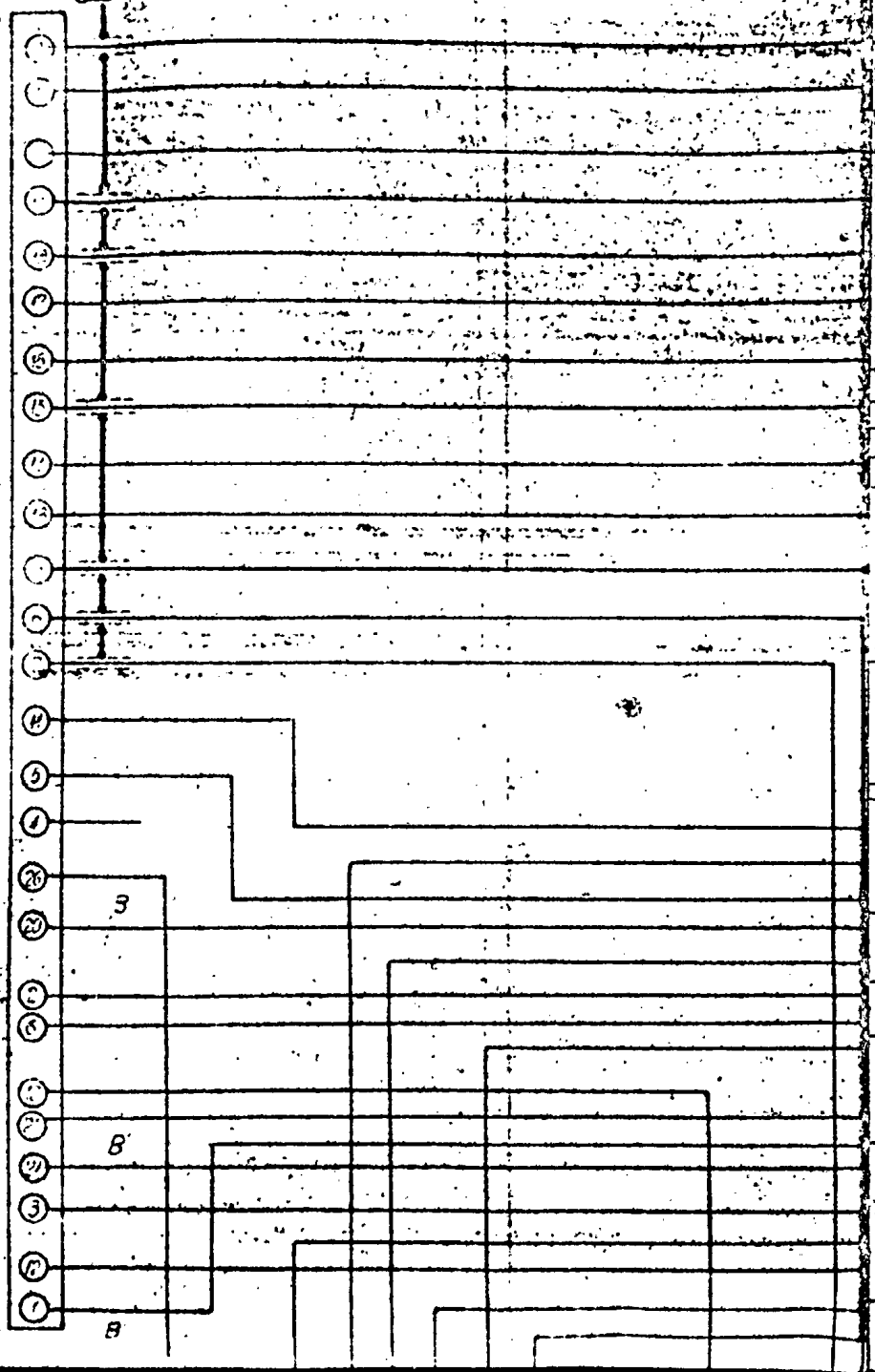

S-E-C-R-E-T

NO FOREIGN DISSEM

NO FOREIGN DISSEM

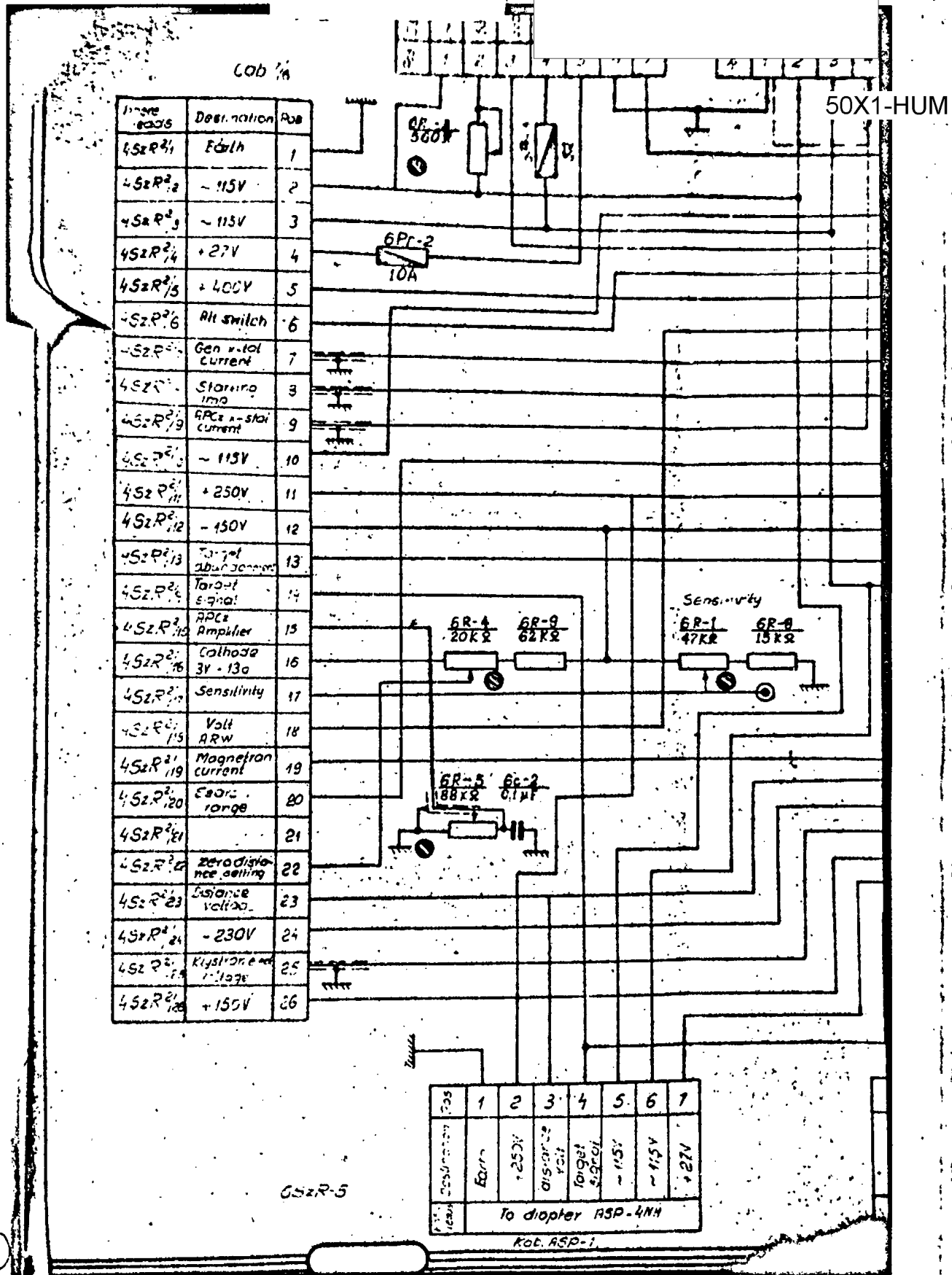

S-E-C-R-E-T

NO FOREIGN DISSEM

S-E-C-R-E-T
NO FOREIGN DISSEM

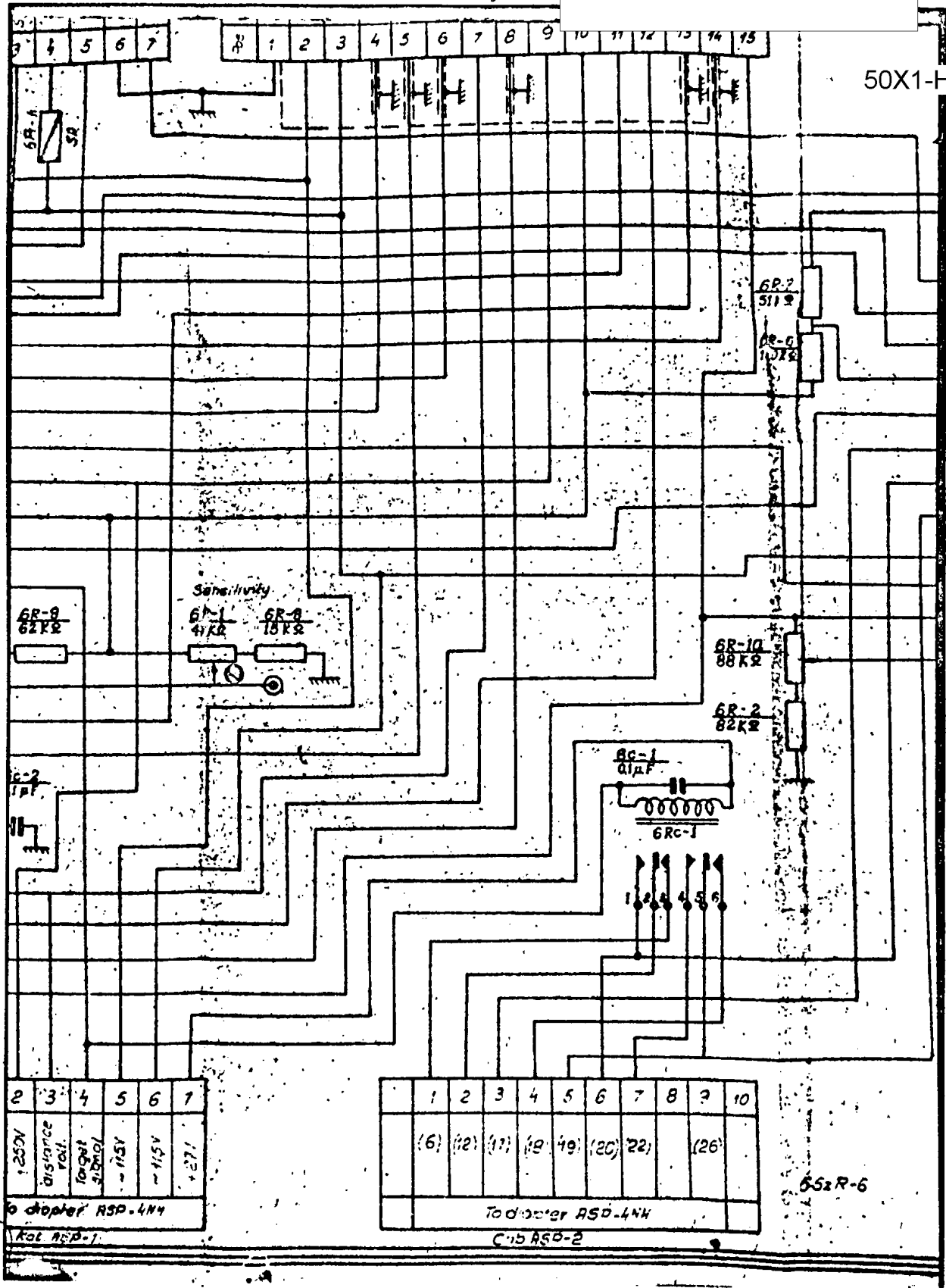

2	3	4	5	6	7
+25V	distance	target	-115V	-115V	+27V
to chapter ASD-4NH					
Vol ASD-1					

1	2	3	4	5	6	7	8	9	10
(6)	(12)	(17)	(19)	(19)	(20)	(22)		(26)	
to chapter ASD-4NH									
Cub ASD-2									

S-E-C-R-E-T
NO FOREIGN DISSEM

NO FOREIGN DISSEM

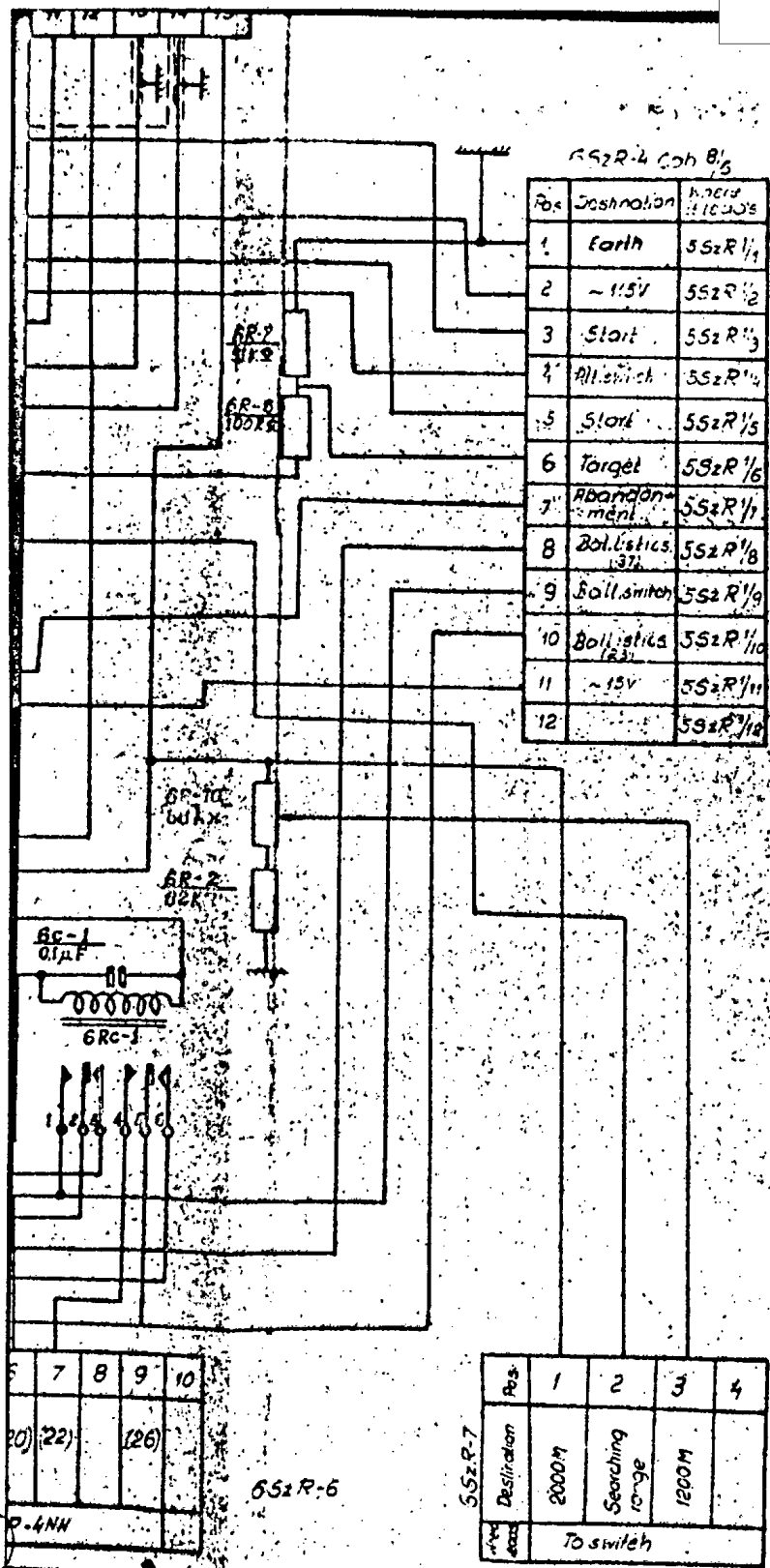

Pos	GOST WTU Norm. Fig.	Description
6R-1	GOST 5574-50	Resistance
6R-2	JZ0467.003TU	Resistance
6R-3	WTU 685.00652	Resistance
6R-4	WTU 685.00652	Resistance
6R-5	GOST 5574-50	Resistance
6R-6	OZ0467.003TU	Resistance
6R-7	OZ0467.003TU	Resistance
6R-8	OZ0467.003TU	Resistance
6R-9	WP6750043P	Resistance
6R-10	GOST 5574-50	Resistance
6C-1	GOST 6118-52	Condenser K
6C-2	GOST 6113-52	Condenser K
6S2R-1	TU102 P/Jo296	Socket Sz
6S2R-2	TU102 P/Jo296	Plug Sz
6S2R-3	TU102 P/Jo296	Socket Sz
6S2R-4	TU102 P/Jo296	Socket Sz
6S2R-5	TU102 P/Jo296	Socket Sz
6S2R-6	TU102 P/Jo296	Plug Sz, P3
6S2R-7	TU102 P/Jo296	Socket Sz
6F-1	TU102 P/Jo296	Fuse P
6F-2	GOST 5010-53	Fuse SP
6F-3	4-A 600 539053-34	
6RL-1	TU-15015	Relay

150X1-HUM

S-E-C-R-E-T

NO FOREIGN DISSEM

S-E-C-R-E-T
NO FOREIGN DISSEM

Part No	Name and type	Value	Qty	Remarks	Qty
ST 5574-50	Resistance SP-120-47A-13	47KR	1		
D467003TU	Resistance MIT-1-82KR-1A	82KR	1		
5850065P	Resistance PP3-11-560R ±10%	560R	1		
U6B50065P	Resistance PP3-11-20KR ±10%	20KR	1		
5T5574-50	Resistance SP-1-2a-68R-13	68KR	1		
10457003TU	Resistance MIT-1-100KR-1A	100KR	1		
10467003TU	Resistance MIT-1-51KR-1A	51KR	1		
10457003TU	Resistance MIT-1-15KR-1A	15KR	1		
673C-15P	Resistance PI-05-62KR ±1%	62KR	1		
5T5574-50	Resistance SP-1-2A-68R-13	68KR	1		
5T56118-52	Condenser KBGJ-200-0111	0.1MF	1		
5T56113-32	Condenser KBGJ-200-0111	0.1MF	1		
102P/10296	Socket SzR48PK26E5z2		1		
102P/10296	Plug SzR28PK7E5z9		1		
102P/10296	Socket SzR35PK15E6z4		1		
102P/10296	Socket SzR32PK12E5z1		1		
102P/10296	Socket SzR28PK7E5z9		1		
102P/10296	Plug SzR32PK10E5z2		1		
102P/10296	Socket SzR20PK4NGB		1		
102P/10296	Fuse PC-30-5	5A	1		
5T5010-53	Fuse SP-10A	10A	1		
1009 533-34 31P					
15015	Relay		1		

50X1-HUM

4

Unit Nr 6
Control p
Circuit

GJa2761.00/SchE/s
page 55

S-E-C-R-E-T

NO FOREIGN DISSEM

NO FOREIGN DISSEM

50X1-HUM

List of items

Pos design	GOST WTU Norm. Fig.	Name and type	Value	Qty	Remarks	Qty
6R-1	GOST 5574-50	Resistance SP-120-47A-13	41kΩ	1		
6R-2	OZD 467.003TU	Resistance MIT-1-82kΩ-1A	82kΩ	1		
6R-3	WTU 685.0065P	Resistance PP3-II-560Ω ± 10%	560Ω	1		
6R-4	WTU 685.0065P	Resistance PP3-II-20kΩ ± 10%	20kΩ	1		
6R-5	GOST 5574-50	Resistance SP-1-2a-68A-13	68kΩ	1		
6R-6	OZD 467.003TU	Resistance MIT-1-100kΩ-1A	100kΩ	1		
6R-7	OZD 467.003TU	Resistance MIT-1-51kΩ-1A	51kΩ	1		
6R-8	OZD 467.003TU	Resistance MIT-1-15kΩ-1A	15kΩ	1		
6R-9	WP 67.013P	Resistance PT-05-62kΩ ± 4%	62kΩ	1		
6R-10	GOST 5574-50	Resistance SP-1-2A-68A-13	68kΩ	1		
6C-1	GOST 610-52	Condenser KBJ-200-0111	01μF	1		
6C-2	GOST 610-52	Condenser KBJ-200-0111	01μF	1		
6S2R1	TU102P/10296	Socket SzR48PK26E5z2		1		
6S2R2	TU102P/10296	Plug SzR28PK1E5z9		1		
6S2R3	TU102P/10296	Socket SzR35PK1E5z4		1		
6S2R4	TU102P/10296	Socket SzR32PK1E5z1		1		
6S2R5	TU102P/10296	Socket SzR28PK1E5z9		1		
6S2R6	TU102P/10296	Plug SzR32PK10E5z2		1		
6S2R7	TU102P/10296	Socket SzR20PK4NGB		1		
6A-1	TU102P/10296	Fuse PC-30-5	5A	1		
6A-2	GOST 5010-53	Fuse SP-10A	10A	1		
	U.A. 000 439033-34 M.312					
RL-1	TU 13015	Relay		1		

S-E-C-R-E-T

NO FOREIGN DISSEM

NO FOREIGN DISSEM

50X1-HUM

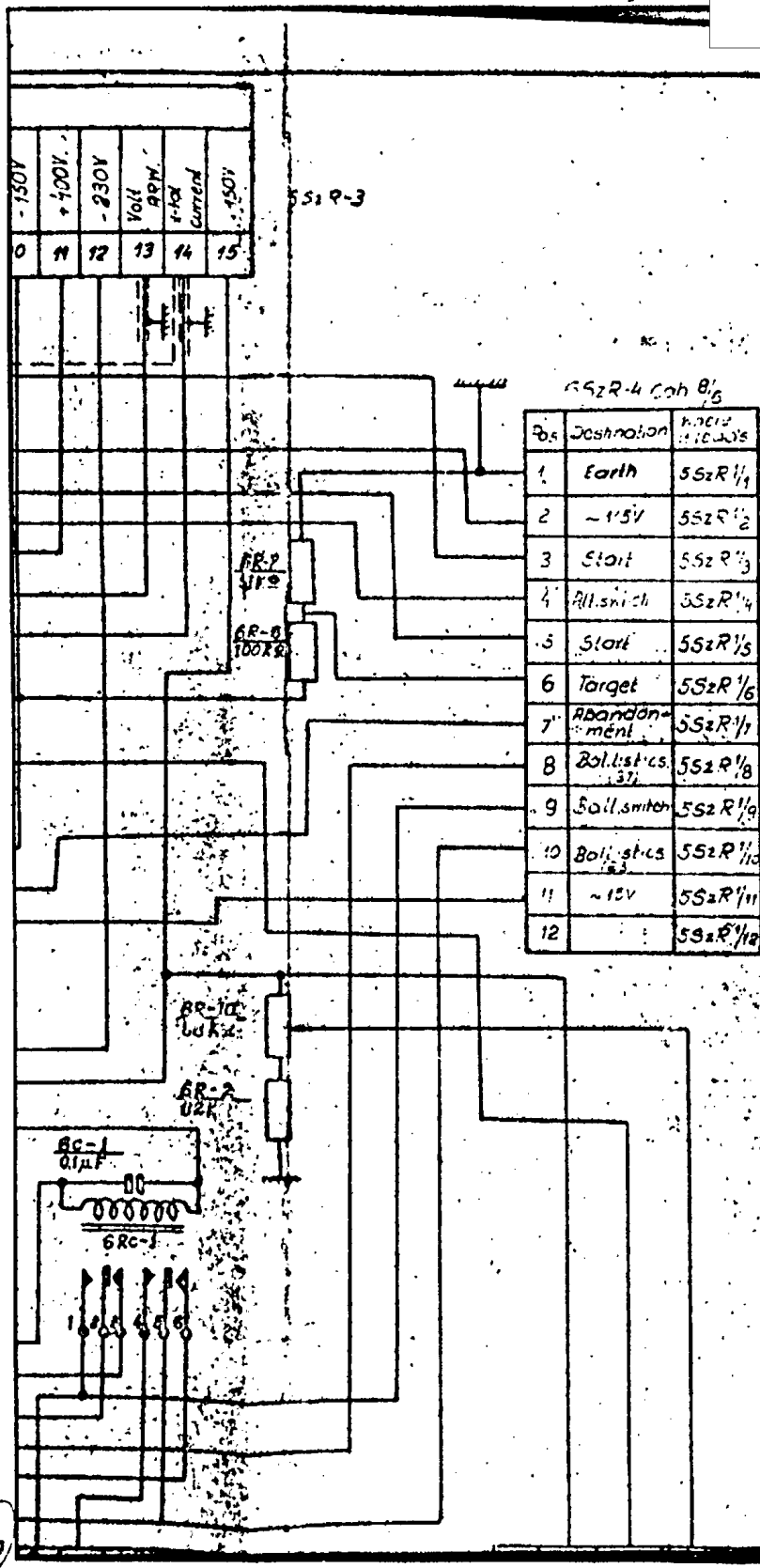

List of items

Pos	GOST WTU Norm. fig.	Name of
6R-1	GOST 5574-50	Resistor
6R-2	OZ0467003TU	Resistor
6R-3	WTU 6850065	Resistor
6R-4	WTU 6850065	Resistor
6R-5	GOST 5574-50	Resistor
6R-6	OZ0467003TU	Resistor
6R-7	OZ0467003TU	Resistor
6R-8	OZ0467003TU	Resistor
6R-9	WP675004SP	Resistor
6R-10	GOST 5574-50	Resistor
6C-1	GOST 6118-32	Condenser
6C-2	GOST 6113-32	Condenser
6S-1	TU102 P/10296	Socket
6S-2	TU102 P/10296	Plug
6S-3	TU102 P/10296	Socket
6S-4	TU102 P/10296	Socket
6S-5	TU102 P/10296	Socket
6S-6	TU102 P/10296	Plug Sckt
6S-7	TU102 P/10296	Socket
6F-1	TU102 P/10296	Fuse
6F-2	GOST 5010-53	Fuse
	U-R CLO 639053-34	
RL-1	TU-15015	Tr-lou

6

S-E-C-R-E-T
(NO FOREIGN DISSEM)

U-S-E-C-R-E-T
NO FOREIGN DISSEM

50X1-HUM

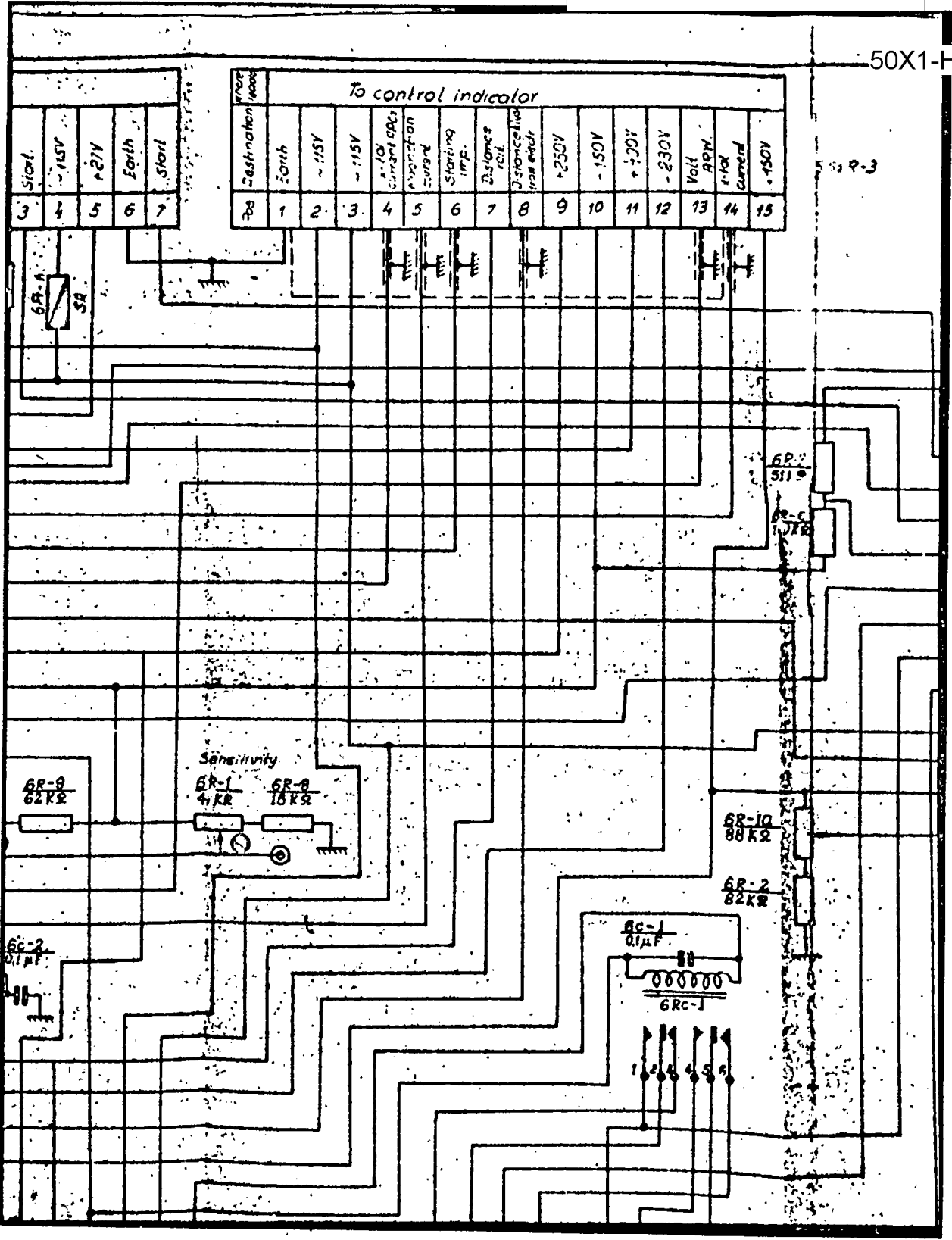

7

S-E-C-R-E-T
NO FOREIGN DISSEM

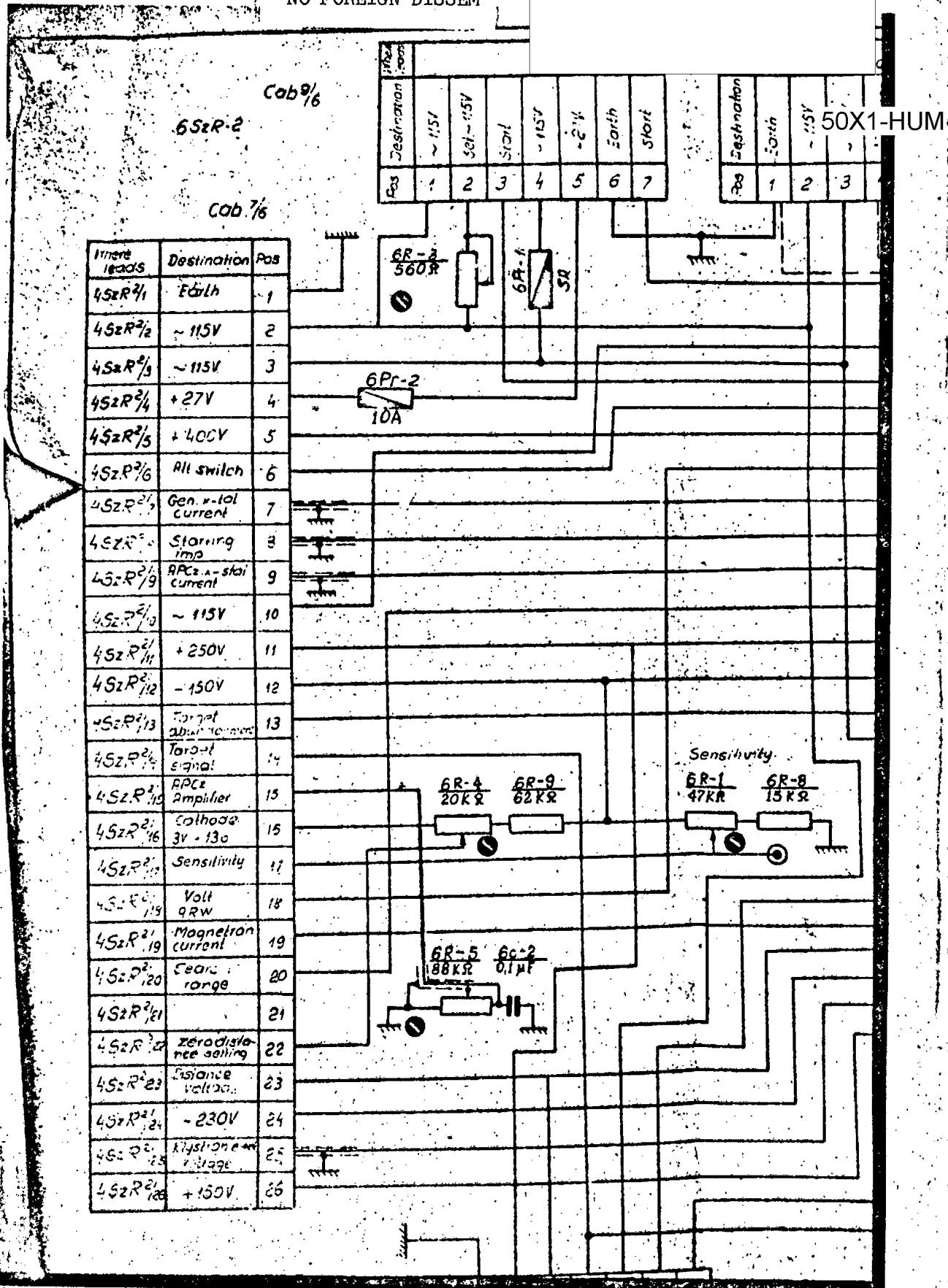

S-E-C-R-E-T
 NO FOREIGN DISSEM

NO FOREIGN DISSEM

50X1-HUM

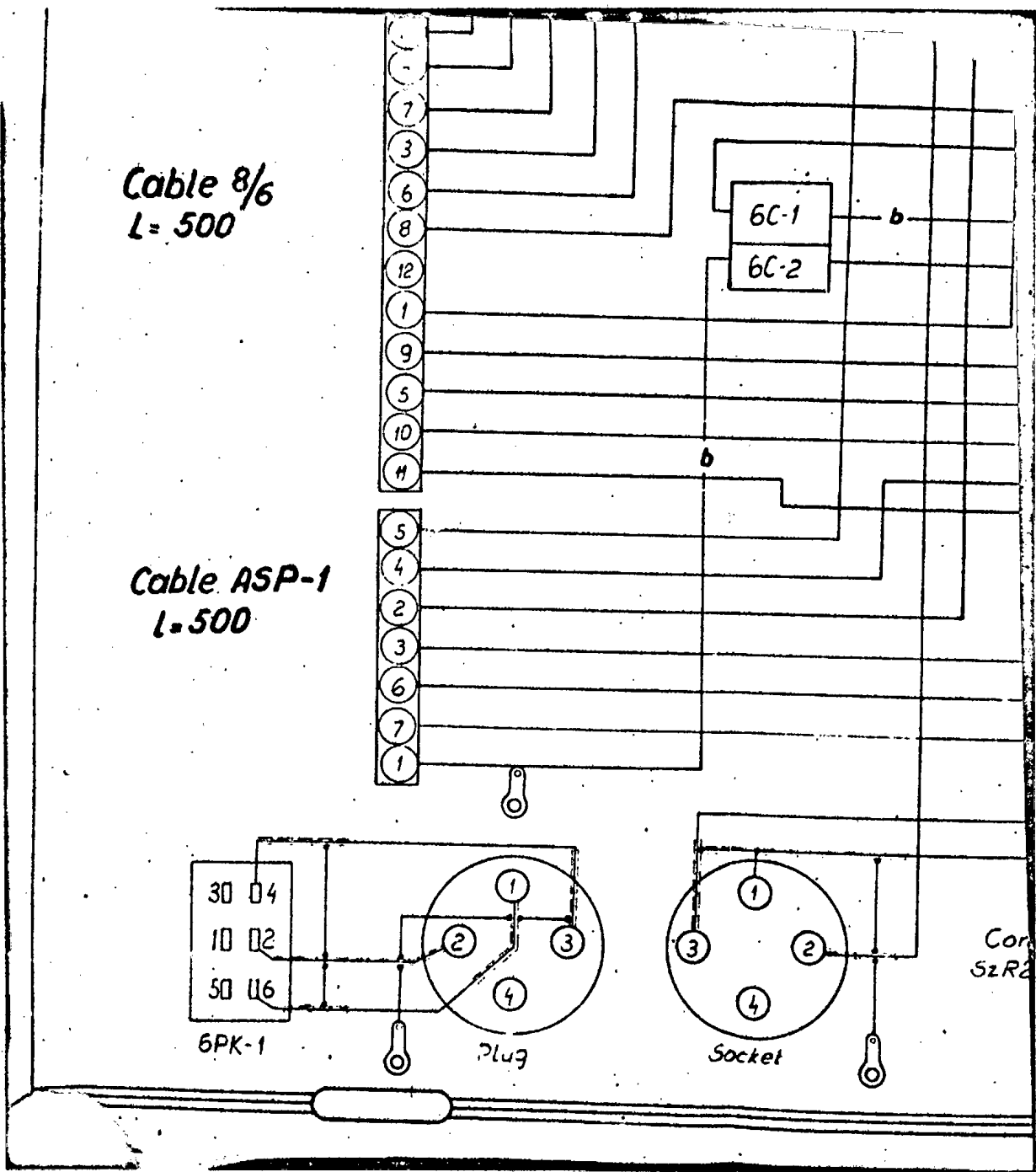

S-E-C-R-E-T

NO FOREIGN DISSEM

NO FOREIGN DISSEM

50X1-HUM

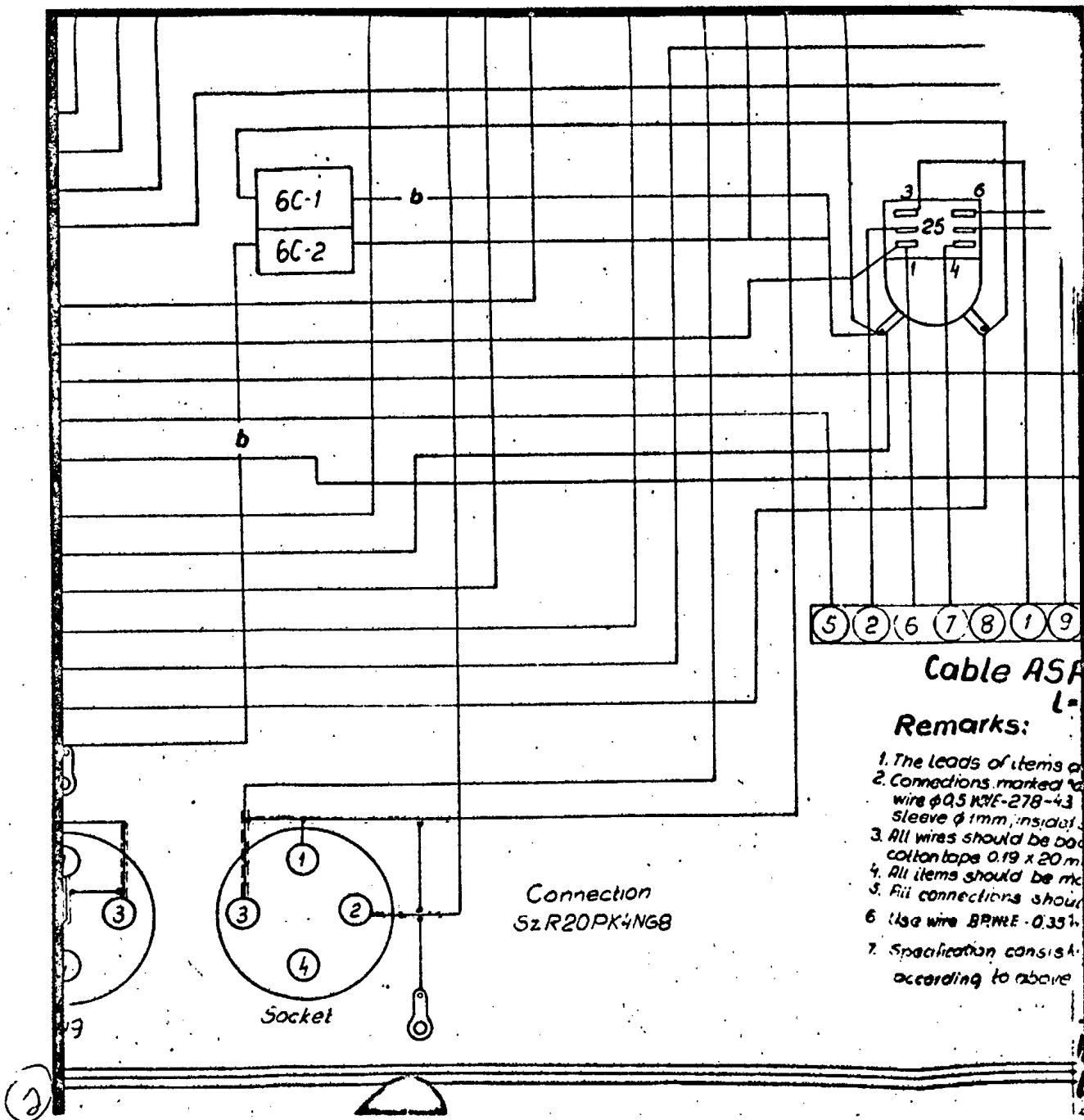

5 2 6 7 8 1 9

Cable ASF
L-

Remarks:

- 1. The leads of items a
- 2. Connections marked 'a'
- wire $\phi 0.5$ KXF-278-43
Sleeve $\phi 1$ mm, insulat.
- 3. All wires should be pac
- cotton tape 0.19 x 20 m
- 4. All items should be ma
- 5. All connections shou
- 6. Use wire BRWE - 0.35
- 7. Specification consist
- according to above

S-E-C-R-E-T

NO FOREIGN DISSEM

NO FOREIGN DISSEM

50X1-HUM

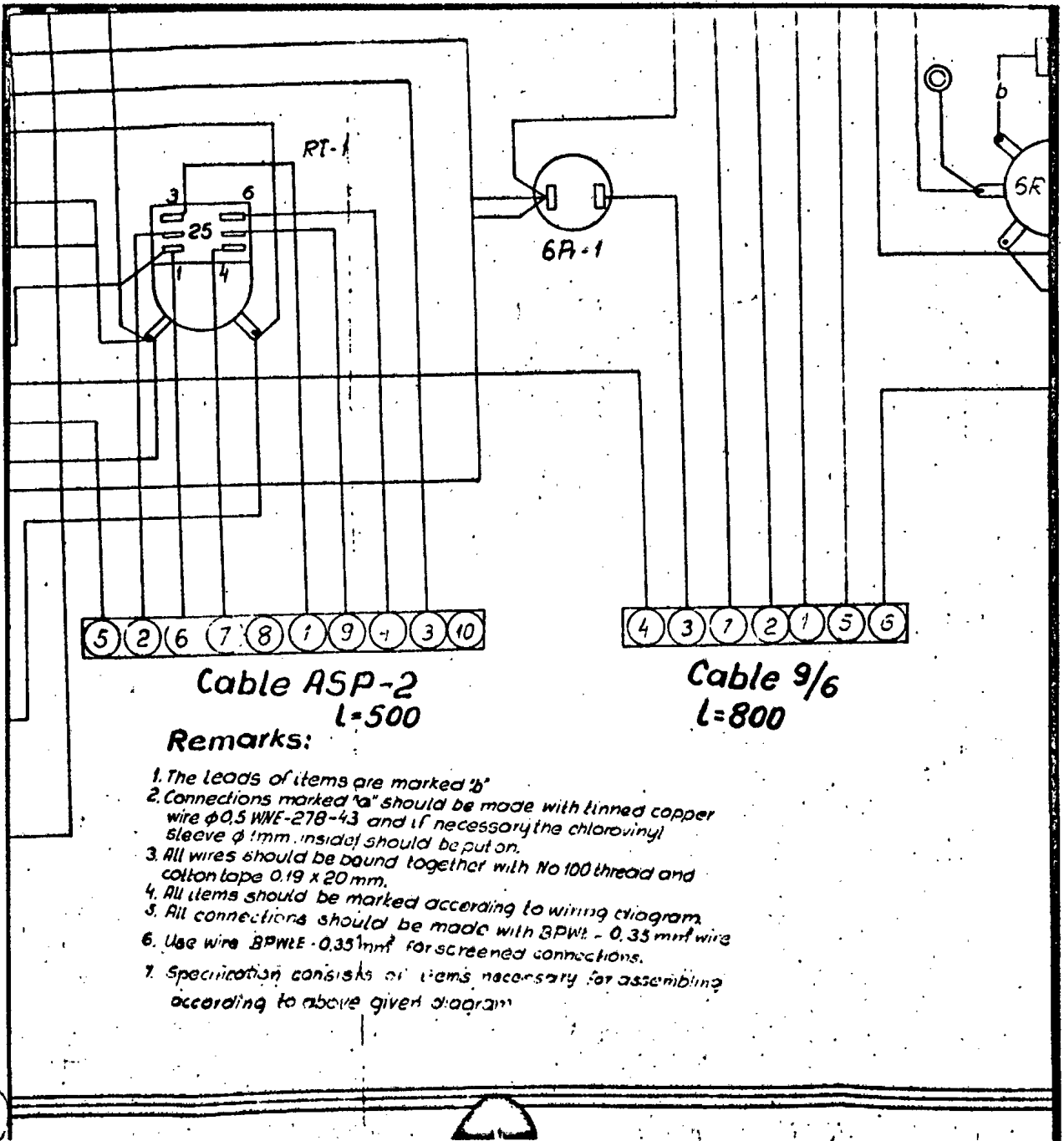

Remarks:

1. The leads of items are marked 'b'
2. Connections marked 'a' should be made with tinned copper wire $\phi 0.5$ WNE-278-43 and if necessary the chlorovinyl sleeve $\phi 1$ mm inside should be put on.
3. All wires should be bound together with No 100 thread and cotton tape 0.19 x 20 mm.
4. All items should be marked according to wiring diagram.
5. All connections should be made with BPWT - 0.35 mm² wire.
6. Use wire BPWLE - 0.35 mm² for screened connections.
7. Specification consists of items necessary for assembling according to above given diagram.

S-E-C-R-E-T
NO FOREIGN DISSEM

NO FOREIGN DISSEM

50X1-HUM

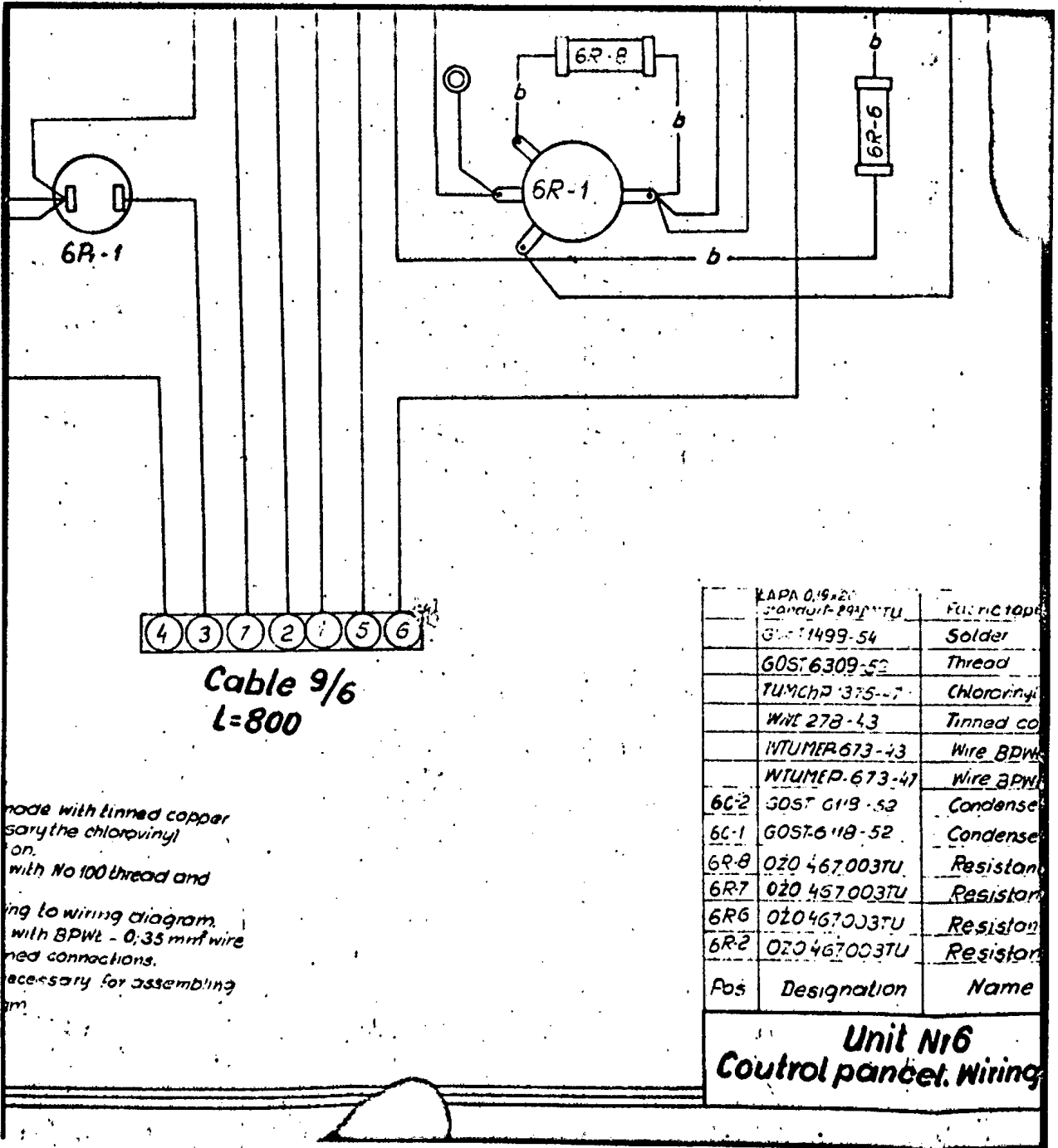

made with tinned copper
 necessary the chloro-vinyl
 on.
 with No 100 thread and
 ing to wiring diagram
 with BPWL - 0.35 mm wire
 need connections.
 necessary for assembling
 am

Pos	Designation	Name
	KAPA 0.19x20	Fabric tape
	Standard P41PMTU	
	GU 1499-54	Solder
	GOST 6309-52	Thread
	TUMChP 375-7	Chloro-vinyl
	WNL 278-43	Tinned co
	WTUMER 673-43	Wire BPWL
	WTUMER 673-47	Wire BPWL
6C-2	GOST 6119-52	Condense
6C-1	GOST 6118-52	Condense
6R-8	OZO 467.003TU	Resistor
6R-7	OZO 467.003TU	Resistor
6R-6	OZO 467.003TU	Resistor
6R-2	OZO 467.003TU	Resistor

Unit No 6
Control panel. Wiring

S-E-C-R-E-T

NO FOREIGN DISSEM

NO FOREIGN DISSEM

50X1-HUM

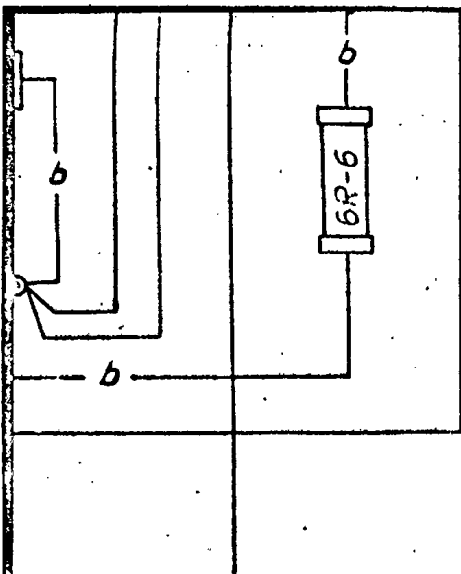

	KAPA 0,19x20 ГОСТ 1499-54	Fabric tape		
	ГОСТ 6309-52	Solder		
	ГОСТ 6309-52	Thread	2m	
	TUMCHP 375-47	Chlorovinyi sleeve	1m	
	WIRE 278-43	Tinned copper wire	3m	
	WTUMEP-673-43	Wire BPWkE-0.35 mm ²	8m	
	WTUMEP-673-47	Wire 3PWk-0.35 mm ²	2m	
6C-2	ГОСТ 6118-52	Condenser KB61-200-01-II	1	
6C-1	ГОСТ 6118-52	Condenser KB61-200-01-II	1	
6R-8	OZO 467003TU	Resistance MCT-1-15kΩ-TA	1	
6R-7	OZO 467003TU	Resistance MCT-1-51kΩ-TA	1	
6R-6	OZO 467003TU	Resistance MCT-1-100kΩ-TA	1	
6R-2	OZO 467003TU	Resistance MCT-1-82kΩ-TA	1	
Pos	Designation	Name and type	Q-ty	Remarks

Unit Nr 6
Control panel. Wiring diagram

GJa 2.761.001 sch/s
page 56

S-E-C-R-E-T

NO FOREIGN DISSEM

NO FOREIGN DISSEM

50X1-HUM

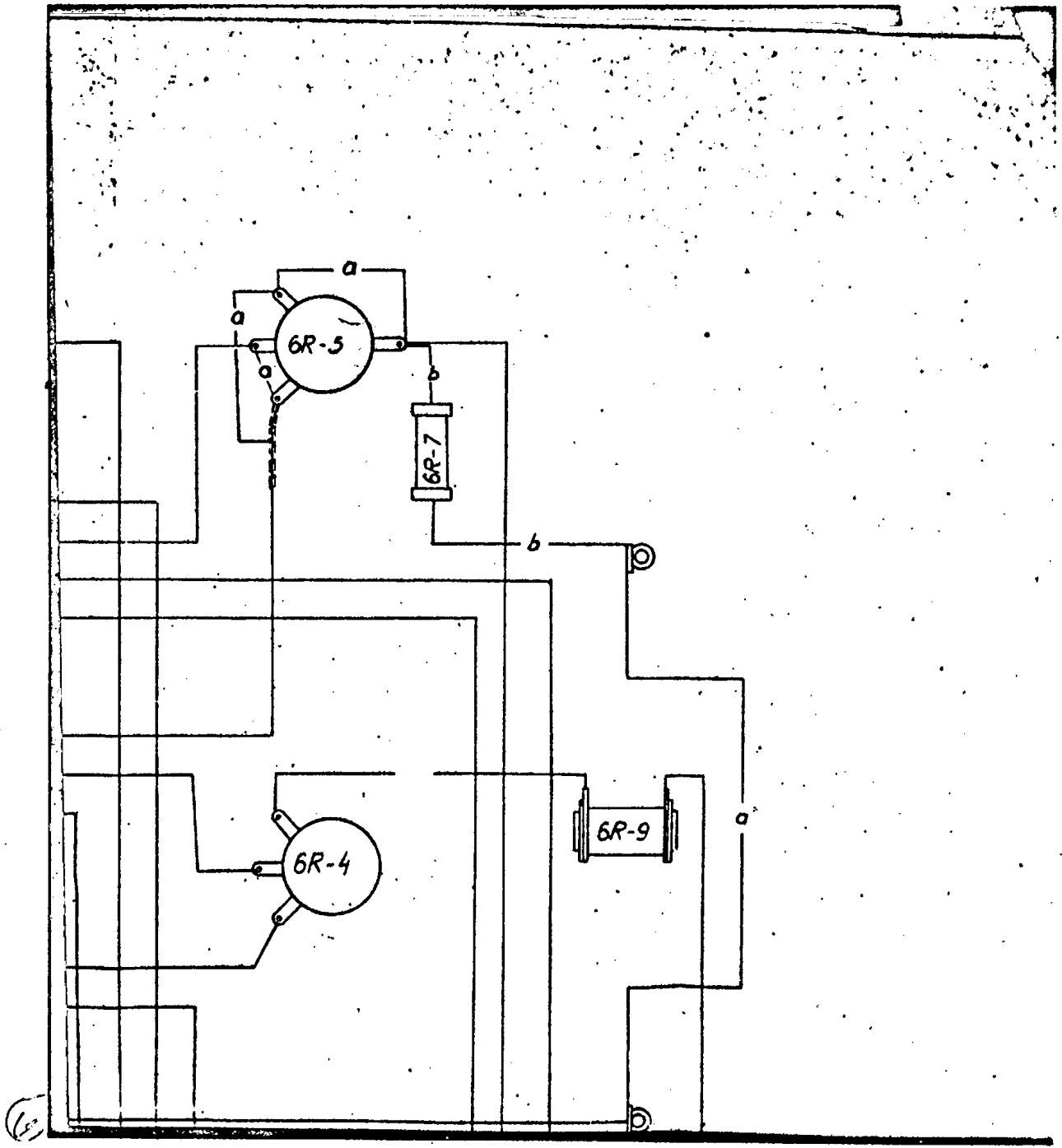

S-E-C-R-E-T

NO FOREIGN DISSEM

S-E-C-R-E-T
NO FOREIGN DISSEM

50X1-HUM

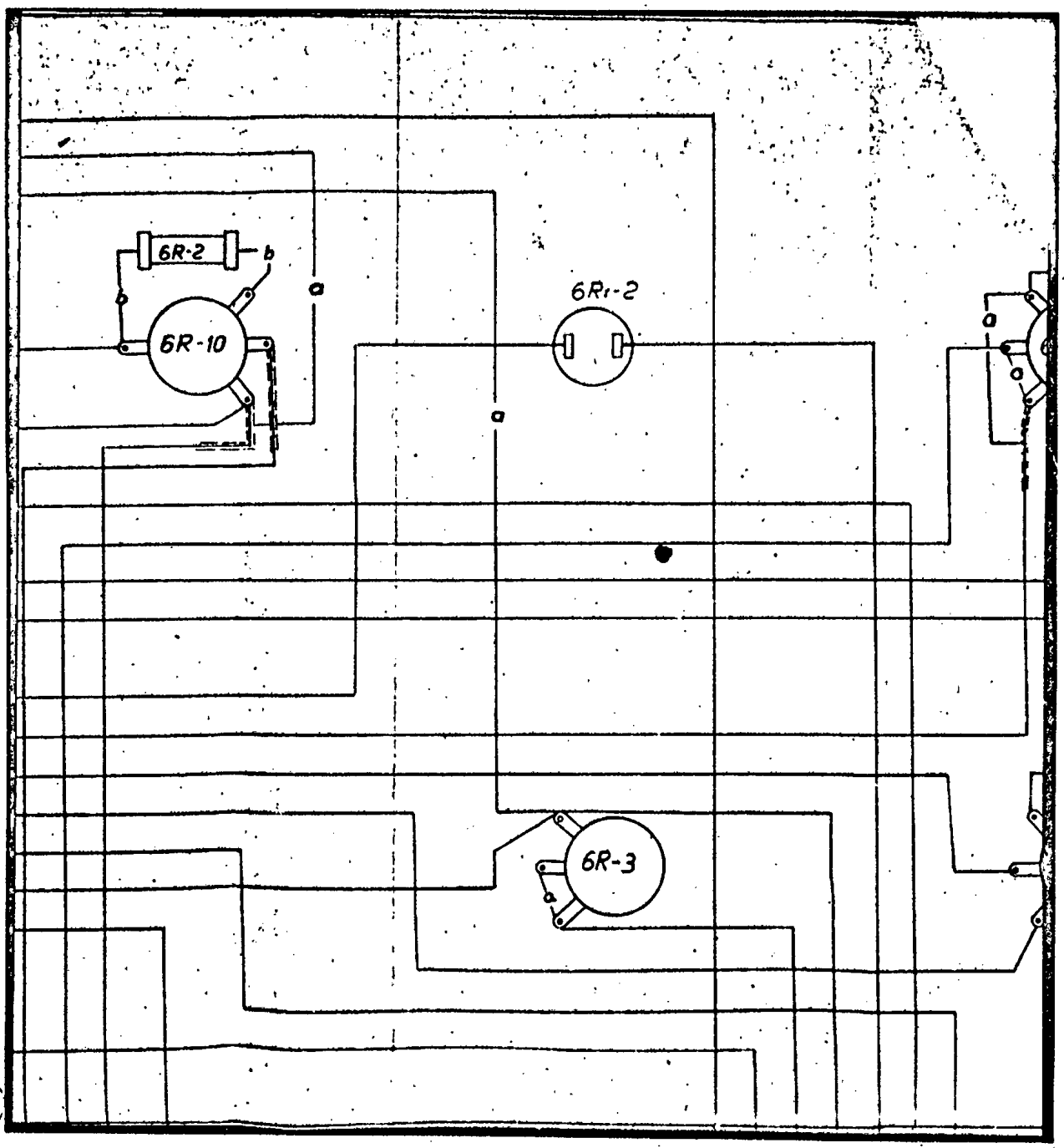

S-E-C-R-E-T
NO FOREIGN DISSEM

50X1-HUM

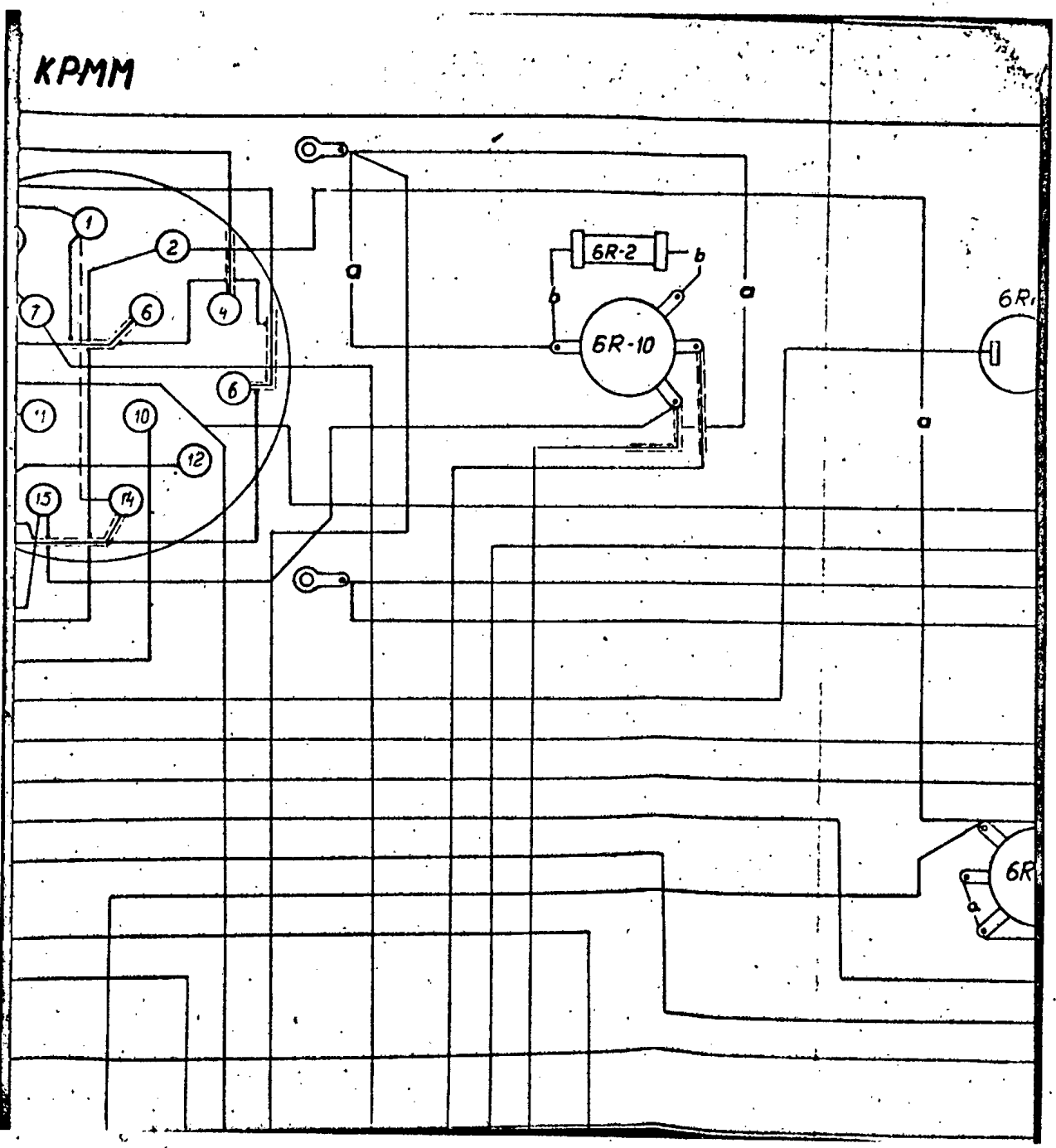

8

S-E-C-R-E-T
NO FOREIGN DISSEM

NO FOREIGN DISSEM

50X1-HUM

KPMM

Cable 7/6
L - 650

(9)

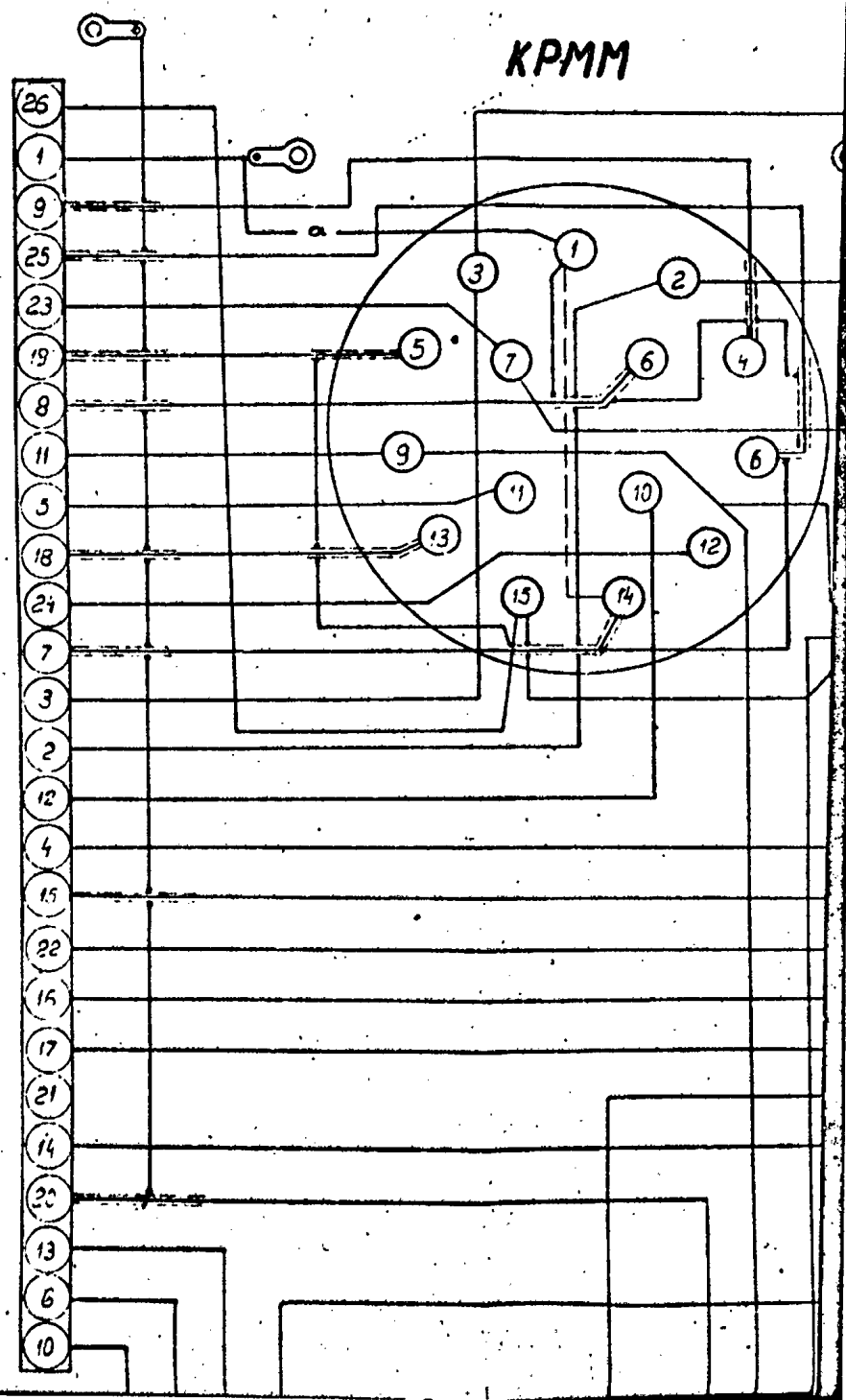

S-E-C-R-E-T

NO FOREIGN DISSEM

SECRET
NO FOREIGN DISSEM

SECRET
NO FOREIGN DISSEM