

# INFORMATION REPORT INFORMATION REPORT

## CENTRAL INTELLIGENCE AGENCY

This material contains information affecting the National Defense of the United States within the meaning of the Espionage Laws, Title 18, U.S.C. Secs. 793 and 794, the transmission or revelation of which in any manner to an unauthorized person is prohibited by law.

C-O-N-F-I-D-E-N-T-I-A-L

25X1

<b>COUNTRY</b>	China	<b>REPORT</b>	
<b>SUBJECT</b>	Catalogs of Chinese Communist Exports	<b>DATE DISTR.</b>	18 February 1957
		<b>NO. PAGES</b>	2
		<b>REQUIREMENT NO.</b>	RD
		<b>REFERENCES</b>	

ENCLOSURE ATTACHED

DATE OF INFO. [ ]

PLACE & DATE ACQ. [ ]

25X1

SOURCE EVALUATIONS ARE DEFINITIVE. APPRAISAL OF CONTENT IS TENTATIVE.

- catalogs of exports from Communist China
- "Mouse" Tubular paper condenser, exported by the China National Instruments Import Corporation (CNIIC). (In English; folder)
  - Bestone Radio Coil Mfg. Catalog, exported by CNIIC, Shanghai. (as above)
  - China Resources Co. Export Catalog (Machinery, Scientific Instrument, Chemical, and Pharmaceutical Divisions. This is a loose-leaf catalog containing, in addition to a series of pictures and descriptions of machines of various types, lists of items exported by the following corporations:
    - China National Import and Export Corporation - Chinese proprietary medicines, industrial and fine chemicals.
    - China National Foodstuffs Export Corporation - Chinese proprietary medicines.
    - China National Native Produce Export Corporation - fine chemicals and Chinese proprietary medicines.
    - China National Machinery Import Corporation - general machinery, machine tools, mining machinery, power equipment, electrical machinery, ball and roller bearings.
    - China National Transport Machinery Import Corporation - textile machinery, knitting machines, industrial sewing machines, wood-working machinery, printing press machinery, foodstuff industry machinery, and others.
    - China National Instruments Import Corporation - electrical instruments, telephone sets, radios and accessories, cinematographic and photographic equipment, engineering instruments, laboratory instruments and apparatus, and others.

Attachments are [ ] unclassified when detached from this report.

25X1  
25X1

C-O-N-F-I-D-E-N-T-I-A-L

STATE	X	ARMY	X	NAVY	X	AIR	X	FBI	X	AEC		BFC	X	Treas	X
-------	---	------	---	------	---	-----	---	-----	---	-----	--	-----	---	-------	---

(Note: Washington distribution indicated by "X"; Field distribution by "#".)

25X1

**Page Denied**

Sanitized Copy Approved for Release 2010/02/02 : CIA-RDP80T00246A032700710001-0

# 出口商品目錄

(機械·儀器·化工·藥品)

CHINA RESOURCES CO.  
EXPORT CATALOGUE

MACHINERY, SCIENTIFIC INSTRUMENT,  
CHEMICAL AND PHARMACEUTICAL DIVISIONS.

地址:香港德輔道中 中國銀行大廈  
ADDRESS: BANK OF CHINA BUILDING 2A DES VOEUX ROAD CENTRAL  
CABLE ADDRESS: "CIRECO" HONGKONG

Sanitized Copy Approved for Release 2010/02/02 : CIA-RDP80T00246A032700710001-0

華潤公司代理之中國各國營專業公司名址  
FULL NAMES AND ADDRESSES OF CHINA NATIONAL CORPORATIONS  
FOR WHOM CHINA RESOURCES COMPANY ACT AS TRADE AGENTS  
IN HONG KONG

中國技術進口公司

北京 東長安街，對外貿易大廈

**China National Technical Import Corporation,**

Foreign Trade Building,  
Tung Chang An Street, Peking, China.  
Cable Address: 'Techimport' Peking.

中國進出口公司

北京 台基廠頭條六號

**China National Import and Export Corporation,**

6, Tou Tiao Hutung, Tai Chi Chang,  
Tung Chiao Min Hsiang, Peking, China.  
Cable Address: 'CNIEC' Peking.

中國五金進口公司

北京 東長安街，對外貿易大廈

**China National Metals Import Corporation,**

Foreign Trade Building,  
Tung Chang An Street, Peking, China.  
Cable Address: 'Chimetals' Peking.

中國機械進口公司

北京 西直門外三里溝

**China National Machinery Import Corporation,**

Erh Li Kou, Outside Hsi Chih Men,  
Peking, China.  
Cable Address: 'Machimport' Peking.

中國運輸機械進口公司

北京 西直門外三里溝

**China National Transport Machinery Import Corporation,**

Erh Li Kou, Outside Hsi Chih Men,  
Peking, China.  
Cable Address: 'Transmach' Peking.

中國儀器進口公司

北京 西直門外三里溝

**China National Instruments Import Corporation,**

Erh Li Kou, Outside Hsi Chih Men,  
Peking, China.  
Cable Address: 'Instrimport' Peking.

中國雜品出口公司

北京 東四牌樓九條胡同(甲)三十二號

**China National Sundries Export Corporation,**

32A, Chiu Tiao Hutung, East City,  
Peking, China.  
Cable Address: 'Sundry' Peking.

中國絲綢公司

北京 南池子二十九號

**China National Silk Corporation,**

29, Nan Chih Tze, Peking, China.  
Cable Address: 'Chisicorp' Peking.

中國茶葉出口公司

北京 禮士胡同五十七號

**China National Tea Export Corporation,**

57, Li Shih Hutung, Tung Szu Pai-lou,  
Peking, China.  
Cable Address: 'Nationtea' Peking.



**中國礦產公司**  
北京 寶禪寺街三號

**中國畜產出口公司**  
北京 汪家胡同四號

**中國糧穀油脂出口公司**  
北京 豬市大街五十七號

**中國食品出口公司**  
北京 廣安門大街教子胡同三十八號

**中國土產出口公司**  
北京 虎坊橋大街四十六號

**China National Minerals Corporation,**  
3, Pao Chan Sze Street, Peking, China.  
Cable Address: 'Chimincorp' Peking.

**China National Animal By-Products Export Corporation,**  
4, Wangchia Hutung, East City, Peking, China.  
Cable Address: 'Byproducts' Peking.

**China National Cereals, Oils and Fats Export Corporation,**  
57, Chu Shih Ta Chieh Peking, China.  
Cable Address: 'Nationoil' Peking.

**China National Foodstuffs Export Corporation,**  
38, Chiao Tze Hutung, Kuang An Men Street, Peking, China.  
Cable Address: 'Foodstuffs' Peking.

**China National Native Produce Export Corporation,**  
46, Hu Fang Chiao Street, Peking, China.  
Cable Address: 'Prochina' Peking.

## 中國進出口公司經營

**EXPORTER: CHINA NATIONAL IMPORT & EXPORT CORPORATION**

### 中國成藥

#### CHINESE PROPRIETARY MEDICINES

艾羅補腦汁	大瓶	Phostose (Brain Tonic) Each bottle contains 168 cc (big bottles). 12 doz. per wooden case.
艾羅補腦汁	小瓶	Phostose (Brain Tonic) Each bottle contains 84 cc (small bottles). 24 doz. per wooden case.
五洲人造自來血	大瓶	Blood Tonic "CHI LAI" Each bottle contains 400 gms. (big bottles). 5 doz. per wooden case.
五洲人造自來血	小瓶	Blood Tonic "CHI LAI" Each bottle contains 240 gms. (small bottles). 10 doz. per wooden case.
集成痲子粉 鐵罐裝	小童用	Prickly Heat Powder "CHIH-CHEN" For children. Each tin contains 100 gms. 200 tins per wooden case.
集成痲子粉 紙罐裝	小童用	Prickly Heat Powder "CHIH-CHEN" For children. Each paper tin contains 100 gms. 200 tins per wooden case.
集成痲子粉 鐵罐裝	成年人用	Prickly Heat Powder "CHIH-CHEN" For adults. Each tin contains 100 gms. 200 tins per wooden case.
集成痲子粉 紙罐裝	成年人用	Prickly Heat Powder "CHIH-CHEN" For adults. Each paper tin contains 100 gms. 200 tins per wooden case.
艾羅咳嗽藥	大瓶	Thirocobin "YALES" (Cough Syrup) Each bottle contains 225 cc (big bottles). 10 doz. per wooden case.
艾羅咳嗽藥	小瓶	Thirocobin "YALES" (Cough Syrup) Each bottle contains 120 cc (small bottles). 20 doz. per wooden case.
阿墨林藥水(癬藥水)	大瓶	Lotion "AMOLIN" (for skin disease) Each bottle contains 54 cc (large bottles). 50 doz. per wooden case.
阿墨林藥水(癬藥水)	小瓶	Lotion "AMOLIN" (for skin disease) Each bottle contains 13 cc (small bottles). 100 doz. per wooden case.

沃古林眼水		Occulin Eye Drops, 15 c.c. "Kofa" 100 dozen per wooden case.
複方杏仁露	大瓶	Almond Cough Syrup Compound, 150cc (Large bottles).
複方杏仁露	小瓶	Almond Cough Syrup Compound, 65cc (Small bottles).
維丁膠性鈣		Colloidal Calcium with Vitamin D, 20 c.c. bottles Each c.c. contain 0.5 mg Colloidal Calcium & 5000-U Vitamin D.
五洲十滴水		Anti Cholera Drops. "GLOBE BRAND." Each bottle contains 5 cc., 1000 bottles per box, 4 boxes per wooden case.
信寧咳水	大瓶	Cough Syrup "SINECO" Each bottle contains 360 cc (Large bottles). 60 bottles per wooden case.
信寧咳水	小瓶	Cough Syrup "SINECO" Each bottle contains 180 cc (small bottles). 120 bottles per wooden case.
食母生片(乾釀母片)		Zymasun Tablet (Dried Yeast) Each bottle contains 300 tab. of 0.20 gm., 120 bottles per wooden case.
力勃隆丸		Liberon Capsules (Liver Extract & B-Complex) Each bottle contains 60 capsules. 240 bottles per wooden case.
九一四藥膏	小盒	914 Ointment Each box contains 10 gms. (small box). 100 dozen boxes per wooden case.
維血平丸	小瓶	Visculbine Tablet (for high blood pressure) Each tube contains 50 tab., 100 doz. tubes per wooden case.
維血平丸	大瓶	Visculbine Tablet (for high blood pressure) Each bottle contains 500 tab., 5 doz. bottles per wooden case.
維血平液		Visculbine Liquid (for high blood pressure) Each bottle contains 100 cc., 20 doz. bottles per wooden case.
好力生濃丸		Halisun Capsules, Strong Each capsule contains Vit. A: 10,000 I.U., Vit. D: 1,000 I.U. Each bottle contains 100 capsules. 240 bottles per wooden case.

龍虎人丹 小包	Zung Tan In packet of 60's. 5000 packets per cardboard box.
龍虎人丹 大包	Zung Tan In packet of 200's. 1000 packets per cardboard box.
龍虎人丹 瓶庄	Zung Tan In bottle of 400's. 600 bottles per cardboard box.
麻黃素片 二十粒庄	Ephedrin HCl. Tablet Each bottle contains 20 tablets of 0.025 gm. 2000 bottles per wooden case.
麻黃素片 一百粒庄	Ephedrin HCl. Tablet Each bottle contains 100 tablets of 0.025 gm. 200 bottles per wooden case.
麻黃素片 一千粒庄	Ephedrin HCl. Tablet Each bottle contains 1000 tablets of 0.025 gm. 50 bottles per wooden case.
鐘鷹牌菓子鹽 大瓶	"A.C.D." Fruit Saline Each bottle contains 150 grms (big bottles).
鐘鷹牌菓子鹽 小瓶	"A.C.D." Fruit Saline Each bottle contains 30 grms (small bottles).
優散痛止痛片	Eusedon Tablets (Pain Killer) Each tube contains 10 tablets.
一輕鬆通便丸 十粒庄	Tablets Isatin (Laxative) Each tube contains 10 tablets; 1000 tubes per wooden case.
一輕鬆通便丸 六十粒庄	Tablets Isatin (Laxative) Each bottle contains 60 tablets.
羊腸線	Surgical Sutures, plain and chromic.
注射器	Glass Syringes, all sizes.
針頭	Hypodermic Needles, all sizes.
血壓表	Sphygmomenometer (Blood Pressure Meter).
三用聽診器	Stethoscopes, triple change.
嬰孩秤	Baby Scales.
磅人秤	Body Scales.
脫脂紗布	Absorbent Gauze, Hospital Quality 34" x 9 yds, 1-lb p'kt.
脫脂藥棉	Absorbent Cotton, Hospital Quality, 1-lb p'kt.

香港代理處：華潤公司

Hongkong Agency: **CHINA RESOURCES CO.**

# 中國食品出口公司經售

EXPORTER: CHINA NATIONAL FOODSTUFFS EXPORT CORPORATION

## 中國成藥

### CHINESE PROPRIETARY MEDICINES

清魚肝油 瓶庄	Cod Liver Oil Pure B. P. Each bottle contains 500 gm; each gram contains Vitamin A 850-U, D 85-U 20 bottles per wooden case
高單位魚肝油精滴劑 大瓶	Cod Liver Oil Conc. High Potency with Dropper Each bottle contains 50 c.c.; each c.c. contains Vitamin A 50,000-U, D 5,000-U, 200 bots. per wooden case
高單位魚肝油精滴劑 小瓶	Cod Liver Oil Conc. High Potency with Dropper Each bottle contains 10 c.c.; each c.c. contains Vitamin A 50,000-U, D 5,000-U, 400 bots. per wooden case
魚肝油精滴劑	Cod Liver Oil Conc. with Dropper Each bottle contains 50 c.c.; each c.c. contains Vitamin A 5,000-U, D 500-U, 200 bots. per wooden case
乳白魚肝油 大瓶	Cod Liver Oil Emulsion Each bottle contains 500 gm; 50 bots. per wooden case
乳白魚肝油 小瓶	Cod Liver Oil Emulsion Each bottle contains 250 gm; 50 bots. per wooden case
麥精魚肝油	Cod Liver Oil with Malt Extract Each bottle contains 500 gm; 50 bots. per wooden case
高單位魚肝油精丸	Cod Liver Oil Conc. High Potency, Capsules Each bottle contains 100 Capsules; each Capsule contains Vitamin A 10,000-U D 1,000-U, 200 bots. per wooden case
魚肝油精丸 瓶庄	Cod Liver Oil Conc. Capsules Each bottle contains 100 Capsules; each Capsule contains Vitamin A 3,000-U D 1,000-U, 200 bots. per wooden case
魚肝油精丸 罐庄	Cod Liver Oil Conc. Capsules Each tin contains 10,000 Capsules; each Capsule contains Vitamin A 3,000-U D 1,000-U, 10 tins per wooden case

香港代理處：華潤公司

Hongkong Agency: CHINA RESOURCES CO.

中國土產出口公司經售

EXPORTER: CHINA NATIONAL NATIVE PRODUCE EXPORT CORPORATION

西藥原料及中國成藥

FINE CHEMICALS & CHINESE PROPRIETARY MEDICINES

葡萄酸銻鈉  
中國藥典標準

Sodium Stibogluconate, Chinese Pharmacopoeia,  
1. 10-kg. tins, 4 tins to a wooden case.  
2.  $\frac{1}{2}$ -kg. bottles, 20 bottles to a wooden case.

葡萄酸銻鈉針

Sodium Stibogluconate Ampoules  
100 mg pentavalent Antimony per cc. Each ampoule  
contains 6 cc., 6 ampoules in one box, 250 boxes per  
case.

硫脲氮

T.B.1/698 (P-Acetylamino benzaldehyde  
Thiosemicarbazone),  
1. 10-kg. tins, 4 tins to a wooden case.  
2.  $\frac{1}{2}$ -kg. bottles, 20 bottles to a wooden case.

香港代理處：華潤公司

Hongkong Agency: CHINA RESOURCES CO.

## 中國進出口公司經售

EXPORTER: CHINA NATIONAL IMPORT &amp; EXPORT CORPORATION

## 化工與西藥原料

## INDUSTRIAL &amp; FINE CHEMICALS

活性炭	Activated Carbon, Decolourizing—0.1 gm dry sample can decolourize 10.8 cc of 0.15% Methylene Blue solution in 5 minutes. Packed in 20-kg. iron drums.
酒精及變性酒精	Alcohol & Denatured Alcohol.
氯化銨 純度：99%以上	Ammonium Chloride, $\text{NH}_4\text{Cl}$ , Purity—99% up. Packed in 25-kg. cloth bags, lined with 2-ply kraftpaper bags.
安尼林油 純度：99%以上	Aniline Oil, $\text{C}_6\text{H}_5\text{NH}_2$ , Aniline content (dry base) 99% up. Packed in 200-kg. iron drums.
氯化鈣 純度：98%以上	Barium Chloride, $\text{BaCl}_2 \cdot 2\text{H}_2\text{O}$ , Purity—98% up. Packed in 50-kg. wooden cases.
純 苯 比重：0.882 至 0.886	Benzene, $\text{C}_6\text{H}_6$ , Specific Gravity—0.882 to 0.886, Distillation Range—79 to 80.6°C. Packed in 160-kg. iron drums.
碳化鈣 (俗名電石)	Calcium Carbide, $\text{CaC}_2$ , Acetylene producing power per 1-kg., not less than 280 litres. Packed in 100 or 200-kg. iron drums.
輕質碳酸鈣 純度：98%以上	Calcium Carbonate, Light, $\text{CaCO}_3$ , Purity—98% up. Packed in 50-kg. cloth bags.
膠質碳酸鈣 純度：98%以上	Calcium Carbonate, Colloidal, $\text{CaCO}_3$ , Purity—98% up. Packed in 50-kg. cloth bags.
氯化鈣 純度：70%	Calcium Chloride, $\text{CaCl}_2$ , Purity—70% up. Packed in 100-kg. iron drums.
燒碱 (即苛性碱) 純度：96%以上 及 98%以上，固體狀	Caustic Soda, $\text{NaOH}$ , $\text{NaOH}$ content not less than 96% (or 98%) (Solid & Fused). Packed in 100, 200 or 230-kg. iron drums.
二硝基氯化苯 純度：98½%以上	Dinitrochlorobenzene, $\text{C}_6\text{H}_3(\text{NO}_2)_2\text{Cl}$ , Purity (Dry Base) not less than 98½%, Solidifying point (Dry base) not lower than 47.3°C. Packed in 300-kg. iron drums.
甘油松香	Ester Gum 138.
硫化油膠	Factice, (Vegetable Oil Vulcanization). Packed in 200-kg. iron drums.
糠醛 純度：98%以上	Furfural, $\text{C}_3\text{H}_3\text{OCHO}$ . Purity—98% up. Specific Gravity—1.159 @ 20/4°C. Packed in 220-kg Iron Drums

乾酪素	Lactic Casein.
立德粉 含硫化鋅 28-30%	Lithopone, Purity—28-30% ZnS. Packed in 50 kg. 4-ply paper bags, outside with gunny bags.
一氯化苯 比重：1.112-1.114 ( $D_{15}^{15}$ 度)	Monochlorobenzene, $C_6H_5Cl$ , Benzene content (dry base) not more than 0.3%, Sp. Gr. $D_{15}^{15}$ 1.112-1.114. Packed in 200-kg. iron drums.
精萘 純度：99%以上	Naphthalene, Refined, $C_{10}H_8$ , Purity—99% up, Melting point—79°C. Packed in 25/50-kg. 5-ply paper bags.
萘丸 (即臭丸) 直徑：5/8 及 3/4 吋	Naphthalene Ball, Diameter—5/8" and 3/4". Packed in 50-kg. wooden cases.
各種油漆：	Paints, Various types of Quick-drying enamels, Ready mixed paints & Paste paints.
快乾磁漆	Quick-drying enamels: Packed in 1, 1/2, 1/4-lb. & 1 gallon tins.
調合漆 厚漆	Ready mixed paints: Packed in 1, 1/2, 1/4-gallon tins. Paste Paints: Packed in 28 lb. buckets.
氯酸鉀 純度：99.8%以上	Potassium Chlorate, $KClO_3$ , Purity—99.8% up. Packed in 50 kg. wooden cases lined with 2-ply kraft-paper.
赤磷 純度：95/96%及98%以上	Red Phosphorus, Amorphous, P, Purity—95/96% and 98% up. Packed in 5 or 10-kg. tins or iron buckets, outside with wooden cases.
酸洗抗蝕劑	Rodine, Available ingredient not less than 25%. Packed in 20-kg. iron drums.
純鹼 純度：98%以上	Soda Ash, Total alkalinity, as $Na_2CO_3$ , not less than 98% (dry base). Packed in 80-kg. cloth bags, outside with gunny bags.
醋酸鈉	Sodium Acetate, $NaC_2H_3O_2 \cdot 3H_2O$ .
小蘇打 工業用，純度：99%以上	Sodium Bicarbonate, $NaHCO_3$ , Industrial use, Purity—99% up. Packed in 50-kg. cloth bags, outside with gunny bags.
亞硝酸鈉 純度：98%	Sodium Nitrite $NaNO_2$ , Purity—98% up.



矽酸鈉 (又名水玻璃) 波美 : 40 及 56 度	Sodium Silicate, Baume Degrees—40° and 56°.
氟矽化鈉 純度 : 98% 以上	Sodium Silicofluoride, Na <sub>2</sub> SiF <sub>6</sub> , Purity—98% up. Packed in 50-kg. gunny bags.
無水硫酸鈉 純度 : 99½% 以上	Sodium Sulphate, Anhydrous, Na <sub>2</sub> SO <sub>4</sub> , Purity—99½%. Packed in 125-kg. double gunny bags.
硫化鈉 (即硫化碱) 純度 : 60-62% 及 63.5% 以上 固體及片狀。	Sodium Sulphide, Na <sub>2</sub> S, Na <sub>2</sub> S contents 60-62%, also 63.5% up, Solid fused, and also Flakes. Packed in 50, 100 or 160-kg. iron drums.
硬脂酸 雙壓 燭點 : 攝氏 52 度	Stearic Acid, Double pressed. Melting point: 52°C. Packed in 40-kg. wooden cases.
磺化煤	Sulfonated Coal, Softening value ton degree/cubic meter not less than 900. Packed in 50-kg. wooden cases, lined with 2-ply kraftpaper.
氧化鋅 純度 : 99½% 以上	Zinc Oxide, ZnO, Purity—99½%. Packed in 50 or 100-kg. canvas bags lined with 2-ply paper bags.
氫氧化鋁 英國副藥典 1949 版	Aluminium Hydroxide, B.P.C. 1949, 1. 1-lb. bottles. 2. 20-kg. plywood drums.
次碳酸銻 英國藥典 1953 年版	Bismuth Subcarbonate, B.P. 1953. 1. 1-lb. carton. 2. 5-kg. tins. 3. 28-lb. tins.
次沒食子酸銻 英國藥典 1953 年版	Bismuth Subgallate, B.P. 1953. 1. 1-lb. carton. 2. 5-kg. tins. 3. 28-lb. tins.
次硝酸銻 英國副藥典 1949 年版	Bismuth Subnitrate, B.P.C. 1949. 1. 1-lb. carton. 2. 5-kg. tins. 3. 28-lb. tins.
葡萄糖鈣 口服及注射用	Calcium Gluconate, oral and injectable, Packed in 50-kg. wooden barrels.
乳酸鈣 粉狀及顆粒狀, 英國藥 典 1953 年版。	Calcium Lactate, B.P. 1953, Powder and Granulars, 1. 25-kg. cloth bags, 2 bags to a wooden case. 2. 50-kg. plywood kegs. 3. 1-lb. cartons, 112 cartons to a wooden case.
蓖麻油 英國藥典 1953 年版	Castor Oil, B.P. 1953, 1. 180-kg. iron drums. 2. 20-kg. tins.

鹽酸麻黃素  
英國藥典 1953 年版

Ephedrine Hydrochloride, B.P. 1953.

1. Powder 80 mesh.
2. Crystals.

Packed in:—

1. 1-lb. bottles, 30 bottles to a wooden case.
2. 1-kg. tins, 30 tins to a wooden case.
3. 2½-kg. tins, 12 tins to a wooden case.
4. 5-kg. tins, 6 tins to a wooden case.
5. 1-oz. bottle packing & bulk packing in tins of 28, 56, 112 lbs. and 50 kgs. also available.

蕈茄膏  
粉狀，英國藥典 1953 年版

Extract Belladonnae, B.P. 1953, Powder form.

1. 10-kg. tins, 4 tins to a wooden case.
2. ½-kg. bottles, 20 bottles to a wooden case.

硫桐脂  
英國藥典 1953 年版

Ichthammol, B.P. 1953, Synthesized from Vegetable Oil,

1. 1-lb. bottles, 28-30 bottles to a wooden case.
2. ½-kg. bottles, 25 bottles to a wooden case.
3. 50-kg. jars.

胰酶素  
英國藥典 1953 年版

Pancreatin, B.P. 1953,

Packed in 1-lb. bottles, 20 bottles to a wooden case.

胃蛋白酶  
英國藥典 1953 年版

Pepsin 1:2500, B.P. 1953,

Packed in 1-lb. bottles, 20 bottles to a wooden case.

路丁粉

Rutin, packed in 1-kg. bags.

香港代理處：華潤公司

Hongkong Agency: CHINA RESOURCES CO.

**中國機械進口公司經營**  
**EXPORTER: CHINA NATIONAL MACHINERY IMPORT CORP.**

**機 械**  
**MACHINERY**

**I. 通用機械 General Machinery**

油壓千斤頂	Centrifugal Pump	齒輪油泵	Gear Oil Pump
離心水泵	Hydraulic Jack	水泵	Water Pump

**2. 工具機床 Machine Tools**

**A. 金屬切削機床類**

**Metal Cutting Machines**

六角車床	Turret Lathe
普通車床	All General Lathe
單柱立式車床	Vertical Boring & Turning Machine
多刀半自動車床	Multi-tool Semi-automatic Lathe
立式鉗床	Upright Drilling Machine
萬能立式鉗床	Universal Vertical Drilling Machine
移動式搖臂鉗床	Portable Swing Drilling Machine
旋臂鉗床	Radial Drilling Machine
臥式搪床	Horizontal Boring Machine
插齒機	Gear Shaping Machine
滾齒機	Gear Hobbing Machine
外圓磨床	Cylindrical Grinding Machine
平面磨床	Surface Grinding Machine
刀具磨床	Tools Cutter Grinding Machine
砂輪機	Grinder
萬能銑床	Universal Milling Machine
臥式銑床	Horizontal Milling Machine
龍門鉋床	Double-Housing Planer
牛頭鉋床	Shaping Machine
弓鏟床	Hacksaw Machine

**B. 鍛壓設備**

**Forging & Pressing Machine**

雙柱封閉式單曲軸壓機	Double Column Crank Press
磨擦壓力機	Friction Screw Press

**C. 金屬切削工具**

**Metal Cutting Tool**

鉗頭	Drill
絲錐	Stock
板牙	Die
銑刀	Milling Cutter
銜刀	Reamer
齒輪滾刀	Involute Gear Hobs
齒輪銑刀	Involute Gear Cutter

**D. 研磨工具**

**Grinding Tools**

砂輪	Grinding Wheel
油石	Oil Stone
金鋼砂	Emery

**E. 機床附件**

**Lathe Accessories**

三爪卡盤	Universal Chuck
四爪卡盤	Independent Chuck
平口鉗	Vise

**F. 量具**

**Measuring Tool**

塞規	Plug Gauge
卡板	Shap Gauge
卡尺	Caliper
鋼尺	Steel Rule

**3. 礦山機械 Mining Machinery**

單筒卷揚機	Single Drum Winch	氣動裝岩機	Pneumatic Hammer Drill
卷揚機	Winch	顎式破碎機	Jaw Crusher
利板運輸機	Scraper Chain Conveyer	鍛釵機	Drilling Head Forging Machine
蒸空兩用錘	Pneumatic and Steam Hammer	圓盤粉碎機 (實驗室用)	Laboratory Disc Crusher
鱷魚剪床	Steering Machine		

輓式破碎機 (實驗室用)	Laboratory Roller Crusher	皮帶運輸機	Belt Conveyer
球磨機(實驗室用)	Laboratory Ball Mill	電動橋式起重機	Electric Travelling Crane
		手搖卷揚機	Hand-Power Winch

#### 4. 動力機械 Power Equipments

鑿岩機	Pneumatic Drill	固定空壓機	Stationary Type Air Compressor
風鎬	Pneumatic Pick	柴油機	Diesel Engine
風砂輪	Pneumatic Grinder		
風動搗固機	Pneumatic Crusher		

#### 5. 電氣產品 Electrical Machinery

感應電動機	Induction Motor	絕緣漆布	Yellow Insulated Varnish Cloth
電動變壓器	Power Transformer	絕緣漆網	Yellow Insulated Varnish Silk
電流電壓互感器	Current and Voltage Inductor	黑雲母帶	Black Mica Tape
交通弧焊機	A.C. Arc Welder	雲母板	Mica Sheets
鉛包橡皮絕緣電力纜	Lead Cover Rubber Insulated Cables	壓合雲母片	Pressed Mica Board
橡皮綫	Rubber Insulated Wires		

#### 6. 軸承 Ball & Roller Bearing

單列向心球軸承	Single Row Angular-Contact Ball Bearing	雙列球面滾子軸承	Double Row Spherical Roller Bearing
雙列調心球軸承	Double Row Angular-Contact Ball Bearing	單列推力球軸承	Single Thrust Ball Bearing
單列圓錐滾軸承	Single Row Taper Roller Bearing		

香港代理處：華潤公司

Hongkong Agency: CHINA RESOURCES CO.

## 中國運輸機械公司經售

EXPORTER: CHINA NATIONAL TRANSPORT MACHINERY IMPORT CORP.

機器  
MACHINERY

## I. 紡織機器 Textile Machinery

## A. 棉紡織機器

混棉給棉機  
回花給棉機  
高速給棉簾  
子  
豪豬式開棉  
機  
高速塵籠  
立式開棉機  
配棉器  
單程清棉機  
粗紗頭機  
皮軛花機  
開棉機  
梳棉機  
併條機  
單程二道粗  
紗機  
單程三道粗  
紗機  
經紗機  
緯紗機  
搖紗機  
絡紗機  
擦線機  
漕筒式絡  
筒機  
小包機  
大包機  
漿紗機  
自動織布機  
刷布機  
烘布機  
摺布機  
驗布機

Cotton Spinning &  
Weaving Machinery

Blending Hopper Feeder  
Waste Hopper Feeder  
High Speed Lattice Feeder  
Porcupine Opener  
High Speed Pneumatic Cage  
Condenser  
Single Crighton Opener  
Rake Distributor  
Single Process Scutcher  
Roving Waste Machine  
Clearer Machine  
Willow Machine  
Cotton Card  
Drawing Frame  
"Simplex" Intermediate  
Frame  
"Simplex" Roving Frame  
Warp Spinning Frame  
Weft Spinning Frame  
Reeling Machine  
Winding Machine  
Twisting Machine  
Rotary Traverse Cone  
Winder  
Bundling Machine  
Bale Machine  
Sizing Machine  
Automatic Loom  
Brushing Machine  
Drying Machine  
Folding Machine  
Inspecting Machine

## B. 印染設備

汽體燒毛機  
高壓熨布機  
細狀氣布機  
烘布機

Calico Finishing  
Machinery

Gas Singeing Machine  
High Pressure Kier  
Rope Washer  
Drying Machine with  
Scutcher and Water Mangle

變軛絲光機  
平洗烘燥機  
染缸  
烘燥機  
六色印花機  
蒸化機  
打底機  
平洗烘燥機

調漿鍋

調色鍋  
上花筒機  
雕刻設備

熱風拉幅機  
拉幅機  
三軛軋光機  
碼布機

## C. 麻袋機

軟蕪機  
頭道梳蕪機  
二道梳蕪機  
頭道併條機  
二道併條機  
三道併條機  
精紡機  
擦線機  
垃圾機  
回絲梳蕪機  
精紡機  
(緯紗)

絡經機  
絡緯機  
整經機  
織機  
量布機  
潤布機  
軋光機  
切布機

Chainless Mercerizing Range  
Open Washing Machine  
Jigger  
Drying Machine with Mangle  
Color Printing Machine  
Rapid Ager  
Padding Machine  
Open Soaper with Steaming  
and Drying Attachment  
Starch Pan with Stirring  
Device  
Color Pan  
Forcing Machine  
Engraving Machinery includ-  
ing Enlarging Camera, Pan-  
tograph, Varnishing Ma-  
chine, Polishing Machine,  
Turning Machine, Milling  
Machine and Ruling Table  
Hot Flue Stenter  
Stenter  
Three-bowl Calender  
Folding Machine

## Gunny Bag Machinery

Softening Machine  
Breaker Card  
Finisher Card  
Drawing Frame  
Intermediate Frame  
Roving Frame  
Warp Spinning Frame  
Twisting Machine  
Waste Recovering Machine  
Waste Carding Machine  
Weft Spinning Frame  
Winding Machine (Warp)  
Winding Machine (Weft)  
Warp Dressing Machine  
Jute Loom  
Measuring Machine  
Damping Machine  
Calendering Machine  
Cutting Table

縫口機	Sewing Machine	打包機	Baling Machine
縫邊機	Hemming Machine	打包機油泵	Baling Oil Pump

## 2. 針織機 Knitting Machine

汗布機	Plain Fabric Knitting Machine (Daiman)	縫襪頭機	Lockatitch Looper
棉毛織機	Interlock Fabric Knitting Machine	蒸汽壓襪機	Steam Press for Hosiery
複式汗絨針織機	Spring Needle Knitting Machine	蒸汽燙襪架	Steam Drying Board & Frame for Hosiery
高筒提花織襪機	Automatic Fancy Hosiery Knitting Machine (With High Needle Cylinder)	拉毛機	Raising Machine
電動織襪機	Automatic Hosiery Knitting Machine	離心力脫水機	Contrifugal Hydro-extractor
電動襪口羅紋機	Automatic Rib Top Knitting Machine	紗線絲光機	Yarn Mercerizing Machine
電動領口羅紋機	Automatic Rib Neck Knitting Machine	蒸汽軋光機	Steam Calendering Machine
電動袖口羅紋機	Automatic Rib Cuff Knitting Machine	紅木錠搖紗機	Bottle Bobbin Winding Machine
		寶塔錠倒線機	Conic Tube Traverse Winder Machine
		轆線機	Bamboo Hexagon Traverse Machine
		針織計量表	Knitting Fabric Counter

## 3. 工業縫紉機 Industrial Sewing Machine

高速工業用縫紉機	High Speed Industrial Sewing Machine	縫蓆袋用縫紉機	Gunny-bag Cap Sewing Machine
縫麵粉袋用縫紉機	Flour-bag Cap Sewing Machine	三線鎖口機	Three-thread Overlock Machine
毛毡縫邊用縫紉機	Woollen Blanket Overading Sewing Machine		

## 4. 木工機械 Wood-Working Machine

圓鋸機	Universal Circular Saw Machine	方押式電動刨板機	Hand-planing Machine
帶鋸	Universal Band Saw Machine	木工車床	Wood-turning Lathe
木工排鋸機	Wood-Working Gang Saw Machine	擺鋸	Hanging Oscillating Circular Saw
萬能鋸木機	Universal Radial Arm Power Saw Machine	多面鉋木機	Multi-side Planing Machine

## 5. 印刷及文化用機械 Printing Press Machinery

32吋單捲筒八板輪轉印報機	Uni-reel 8-page Newspaper Rotary Press (Model RP 1-32)	500噸壓綫板機	Hydraulic Matrix Moulding Press
64吋單捲筒十六板輪轉印報機	Uni-reel 16-page Newspaper Rotary Press Model RP 1-64)	全張自動切紙機	Automatic Paper Cutting Machine, Model PC-50
刮鉛版機	Automatic Boring Machine (Autoshaver) (Model RF-14)	對開切紙機	Paper Cutting Machine, Model PC-36
澆鉛版機	Stereo-Plate Casting Machine, Model RD-14	三面切紙機	Three-knife Book Trimming Machine, (Model BT)
溶鉛爐連泵浦	Melting Oven with Pump, Model RN-14	訂書機	Wire Stitching Machine, Model WSP
		鑄字機	Type Casting Machine, Model TCL

雙週轉緩衝式凸板機  
方箱印刷機  
大二號元盤機  
三色凸板機  
四開鉛印機

Two-Revolution Press, Model TRP  
Platen Press, Model PP-14  
Platen Press, Model PP-10 (for Treadle Drive)  
Platen Press, Model PP-16  
Cylinder Job Press, Model CJQ

對開膠板機 (鏈式)  
拖紙機  
全張膠版打樣機  
全張磨鋅字機  
鑄字盤

Single Colour Offset Machine, Model-OHC  
Lifting Truck, Model LT  
Offset Proof and Transfer Press, Model OPH and OPF.  
Zinc Plate Grinding Machine  
Type Casting Case

## 6. 食品工業用機械 Food-Stuff Industry Machinery

### A. 餅乾機

混麵機  
皮子機  
印模機  
烘爐

**Biscuit Bakery Equipment**  
Biscuit Dough Mixer  
Biscuit Meal Sheeter  
Biscuit Moulding Press  
Circulated Turbo-fan Oven.

烘熱機

Tobacco Drying and Cooling Machine

廢料機

Tobacco Recovering Machine for Waste Cigarette.

煙葉潤濕機  
煙葉烘乾機  
加香料機

Leaf Moistening Machine  
Leaf Drying Machine  
Flavour Mixing Machine

### B. 銨壓縮機

冷藏機

銨壓縮機

**Ammonia Compressor**  
Ammonia Self-contained Refrigerating Machine  
Ammonia Compressor

### E. 麵粉織器

#### (i) 淨麥部份

頭道麥篩  
二道麥篩  
三道麥篩  
打麥篩  
刷麥機  
蕎子機

### Flour Mill Machinery

#### (i) Wheat Cleaning Department:

Receiving Separator No. 2  
Milling Separator No. 2  
Separator No. 2  
Scourer No. 4  
Horizontal Brush Machine  
Cockle Machine, 9 cylinders

### C. 榨油機

篩籽機  
六角篩  
吸壓篩  
滾筒打篩機  
剝殼磨料機

**Oil Expelling Machine**  
Seed Sieving Machine  
Hexagonal Sieve  
Suction Sieve  
Roller Sieving Machine  
Unshelling and Grinding Machine

#### (ii) 磨粉部份

複式磨子機

#### (ii) Flour Mill Department:

Double Roller Mills 9" x 30"

Double Roller Mills 9" x 36"

Plane Sifter No. 250

Differential Reels

Purifier 40" x 76"

Bran Duster

Wheat Scale

滾筒軟料機  
螺旋式榨油機

Roller Softener  
Screw Type Oil Expellor

濾油機

Oil Filter

碎餅機

Cake Breaker

油泵

Oil Pump

### D. 製捲煙機械

高速自動捲煙機

切煙機

折胚煙機

紙盒機

自動包裝機

磨刀機

### Cigarette Making Machine

High Speed Cigarette Making Machine

Tobacco Cutting Machine

Stalk Crusher (or Stem Flatening Machine)

Cigarette Carton Machine

Automatic Wrapping Machine

Knife Grinder

#### (iii) 打包部份

麵粉打包機

麸皮打包機

吸粉機

鐵風箱

縫袋口機

#### (iii) Packing Department:

Flour Packer

Bran Packer

Duster Collector

Steel Plate Exhauster No. 35

Bag Sealing Machine

## 7. 日用品製造機械 Industrial Machinery for Making Various Dairy Commodities

### A. 製牙膏機

鎔鉛鍋

鉛板車

軋板車

落片機

### Tooth Paste Making Machine

Lead-melting Furnace

Lead Sheet Mold

Lead Sheet Rolling Mill

Lead Sheet Stamping Machine

衝管機

軟管螺絲機

底子印刷機

三色印刷機

夾層拌膠機

Tube Punching Machine

Tube Screwing Machine

Tube Printing Machine

Three-colour Tube Printing Machine

Paste Storage Tank

混合池	Mixing Tank	鎔碱池	Soda Dissolving Tank
貯膏池	Grinding Tank	離心泵	Centrifugal Pump
機		煮皂鍋	Soap Heater
齒輪泵	Gear Pump	肥皂泵	Soap Pump
牙膏泵	Paste Pump	存皂池	Soap Storage Tank
裝管機	Paste Filling Machine	夾層拌皂鍋	Soap Mixer
<b>B. 製皂機械</b>	<b>Machinery for Soap Making Industry</b>	肥皂冷却機	Soap Cooling Machine
鎔油池	Fats Dissolving Tank	切皂機	Soap Cutting Machine
		打印機	Trade Mark Stamper

### 8. 其他機械 Miscellaneous

<b>A. 製紙盒機械</b>	<b>Cardboard Box Making Equipment:</b>	<b>D. 製造揷鈕機械</b>	<b>Stud Making Machinery</b>
瓦楞機	Board Corrugating Machine	雄片落料翻邊車	For Male Part of Stud, Punch Press for Cutting.
裱紙機	Board Lining Machine	雄片冲條車	For Male Part of Stud, Press
胖線機 (壓線機)	Groove Press	雌片冲條車	For Female Part of Stud, Press
分紙機	Paper Cutter	雌片落料翻邊車	For Female Part of Stud, Punch Press
四聯刀鋸紙機	4-knife Paper Cutter	揷鈕鋼絲彈簧車	Wire Spring Making Machine
鉛絲釘盒機	Paper Box Stitching Machine	立式空氣壓縮機	Vertical Air Compressor
割綫機	Line Press	揷鈕機冲模	Dies
切格擋紙機	Row Cutter		
木台側刀	Wood Platform Trimmer	<b>E. 輪胎機械</b>	<b>Rubber Tyre Industry Machinery</b>
<b>B. 搪瓷機器</b>	<b>Complete Equipment for Manufacturing Enamel-ware.</b>	輪胎翻修機	Rubber Tyre Reconditioned Equipment
冲床	Punch	橡膠混合機	Rubber Mixer
雙壓軋床	Drawing Press	電木原料混合機	Filler Mixer
切片機	Shear	油泵漲胎機	Oil Pump
呀光機	Spinning Machine	胎面壓出機	Surface Press
台上切捲車	Bench Roller	局部活動型補胎機	Portable Local Repairer
郎粉車	Grinder for Grinding Enamel Powder	自行車胎壓出機	Bicycle Tyre Repairer
磨石粉車	Stone Grinder with Sieves for Grinding Granite.		
郎鎊機	Crusher for Crushing Antimony	<b>F. 裝釘機</b>	<b>Nail Making Machinery</b>
調合機	Mixer	拉絲機	Wire Drawing Machine
滾綫捲邊車	Folding Machine	各種釘車	Nail Making Machine
<b>C. 製安全別針機器</b>	<b>Safety-pin Making Machinery</b>	滾壳車	Nail Tumbler Machine
保險別針拔直磨尖車	Wire Straightening Cutting & Sharpening Machine.	<b>G. 製木牙螺絲機</b>	<b>Wood Screw Making Machine</b>
保險別針冲頭車	Lock Making Press	<b>H. 水泥包壓機</b>	<b>Cement Packing Machine</b>
保險別針撈絲車	Wire Coiling Machine	<b>I. 真空製磚機</b>	<b>Vaccum Brick Making Machine</b>
保險別針捲邊車	Lock Gripping Press	<b>J. 製大頭針機</b>	<b>Paper Pin Making Machine</b>



K. 製玻璃杯及 瓶機械	<b>Glass Making Machine</b>	M. 鞋釘機	<b>Blue Cut Tack Making Machinery</b>
自動壓杯機	Automatic Mould for Making Drinking Glass	N. 鋼筆刻名機	<b>Pen Engraving Instrument</b>
半自動壓杯 機	Semi-automatic Mould for Making Drinking Glass	O. 噴花槍	<b>Spraying Gun</b>
三鐵碗吹瓶 機	Bottle Blowing Machine with 3 moulds	P. 蓄電池	<b>Storage Battery</b>
L. 木螺絲機	<b>Wood Screw Making Machinery</b>	Q. 壓蔗機	<b>Sugar Cane Press</b>

香港代理處：華潤公司

Hongkong Agency: **CHINA RESOURCES CO.**

## 中國儀器進口公司經售

EXPORTER: CHINA NATIONAL INSTRUMENTS IMPORT CORPORATION

### 電工儀器

精密交直流電流表，電壓表，三相電力表，單相功率因數表，週波積算器，高電阻計，線路試驗器，接地電阻測試器，校正用電位差計，十進式電容箱，十進式高週波電阻箱等。

### 電話機

自動式及共電式。

### 無線電用品

收音機，電子管，管座，各種線圈，各種儲電器，扳動開關，耳機，揚聲器，擴音機，電烙鐵，繞線車，及各種其他無線電用品，無線電參攷書籍；普通電唱機，自動落片電唱機，唱頭芯子，長命唱針等。

### 電影器材及照相用品

16公厘有聲電影放映機，幻燈機，炭精棒，照相紙，鏡箱等。

### 實驗室用儀器

實驗室用玻璃器皿，瓷器皿，扭力天平，顯微鏡，濕度計，比重計，溫度計，寒暑表，及其他儀器。

### 各類示教儀器

各種物理儀器，化學儀器，數學模型；生物模型，標本，切片；生物器械；人體生理，病理模型，解剖學切片，地質地理模型；礦物標本；金屬與合金標本等。

### Electrical Instruments

Precision AC/DC ammeters, voltmeters, Three-phase wattmeters, Single-phase power factor meters, Cycle counter, High resistance tester, Fault location test sets, Earth tester, Potentiometer for calibration, Decade capacitance box, Decade high frequency resistance box, etc.

### Telephone Sets

Automatic type and common battery type.

### Radio & Accessories

Radio receiver, Radio tubes, Tube sockets, Coils, Condensers, Toggle switches, Earphone, Loudspeaker, Amplifier, Soldering iron, Coil winder, and other various radio accessories; Radio reference books, Record player, Automatic record changer, Magnet pick-up, Long life needle, etc.

### Cinematographic & Photographic Equipments

16 mm Sound film projector, Still projector, Carbon rods (arc-light), Photographic papers, camera outfit, etc.

### Laboratory Instruments & Apparatus

Glassware, Porcelainware, Torsion balance, Microscopes, Psychrometers, Hydrometers, Pyrometers, Thermometers, and other instruments.

### Educational Instruments

Physical laboratory apparatus, Chemical laboratory apparatus, Mathematical models; Biological models, specimens and slides; Biological apparatus; Physiological, Pathological models and slides; Geological and geographical models; Rock and mineral collections; Metals and metal alloy models, etc.

**繪圖儀器，計算機，打字機等**

套裝精密繪圖儀器，三用圖規，三稜尺，雲形規，三角板，量角規，及各種其他繪圖儀器：求積儀，計算機，中文打字機及中文打字機用油等。

**工程儀器**

各種流量計，各種紡織工業儀器，二氧化碳分析器等。

**Drawing Instruments, Calculator, Typewriter, Etc.**

Precision drawing instruments in sets, Combination compasses, Triangular scales, French curves, Set squares, Protractors, and other various drawing instruments; Planimeter, Calculator, Chinese typewriters and Inks for Chinese typewriters, etc.

**Engineering Instruments**

Flowmeters, Textile industry instruments, Carbon dioxide analyzer, etc.

香港代理處：華潤公司

Hongkong Agency: **CHINA RESOURCES CO.**

表內未能詳盡列入之項目，請洽詢我公司當即詳告。

*Should there be any requirement for items other than is mentioned in this list, please contact us for further information.*

CODE : 6EM - 1003

普通車床  
ALL GEARED LATHE

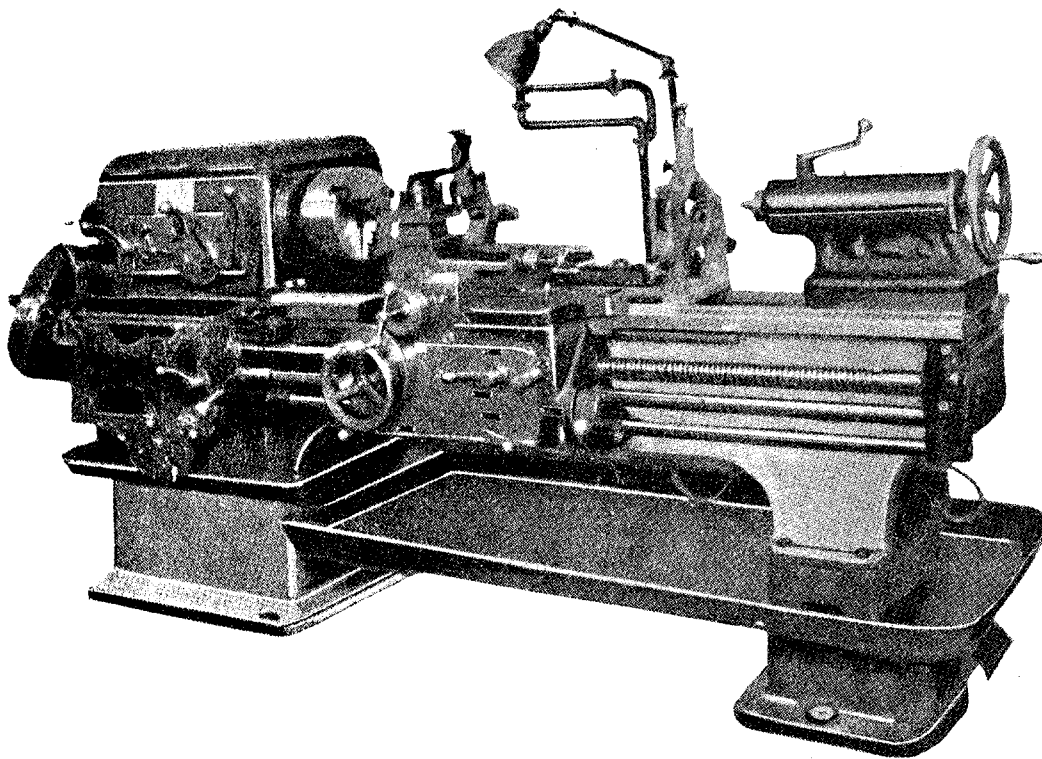

中國機械進口公司經售

Exported by CHINA NATIONAL MACHINERY IMPORT CORPORATION

香港代理處：華潤公司

Hong Kong Agency: CHINA RESOURCES CO.

BANK OF CHINA BUILDING  
HONG KONG  
CABLE ADDRESS: "CIRECO."

**Capacity**

Height of centers, mm ... ..	200
Maximum distance between centers, mm ... ..	750; 1000; 1500; 2000
Bar capacity, mm ... ..	37
Maximum swing over cross slide, mm ... ..	210
Maximum swing over bed ways, mm ... ..	400
Maximum length of turning (according to distance between centers), mm ... ..	650; 900; 1400; 1900
Threads that can be cut:	
Metric, pitch in mm ... ..	1—192
English, threads per inch ... ..	24—2
Module ... ..	0.5—48
Diametral pitch ... ..	96—1

**Carriage**

Maximum travel (power or manual feed), mm:	
longitudinal (according to distance between centers) ... ..	650; 900; 1400; 1900
cross ... ..	280
Distance from tool bottom to center line, mm ... ..	25
Maximum swivel of top slide, deg ... ..	± 45

**Spindle**

Diameter of hole in spindle, mm ... ..	38
Taper hole in spindle ... ..	Morse No. 5

**Tailstock**

Taper hole in spindle ... ..	Morse No. 4
Maximum travel of spindle, mm ... ..	150
Setover on side, mm ... ..	± 15

**Speeds and Feeds**

Number of spindle speeds:	
forward ... ..	21
reverse ... ..	12
Range of spindle speeds, r. p. m.:	
forward ... ..	11.5—1200
reverse ... ..	18—1520
Number of longitudinal and cross feeds ... ..	
Range of feeds, mm per revolution of spindle:	
longitudinal ... ..	0.08—1.59
cross ... ..	0.027—0.52

**Drive**

220/380 volt, 3 phase, 50 cycle A. C. motors:	
Main drive:	
power, kw ... ..	7
speed, r. p. m. ... ..	1440
Coolant pump:	
power, kw ... ..	0.125
speed, r. p. m. ... ..	2850

**Space Occupied**

Overall length (according to distance between centers), mm ... ..	2400; 2650; 3180; 3680
Overall width, mm ... ..	1580
Height of machine, mm ... ..	1210

**Weight**

Net weight (according to distance between centers), kg ... approx.	1930; 2010; 2100; 2280
--	------------------------

*N.B.—For improvement of the machine, we reserve the right to alter either the design or the specification.*

CODE: 6EM - 1011

六角車床  
TURRET LATHE

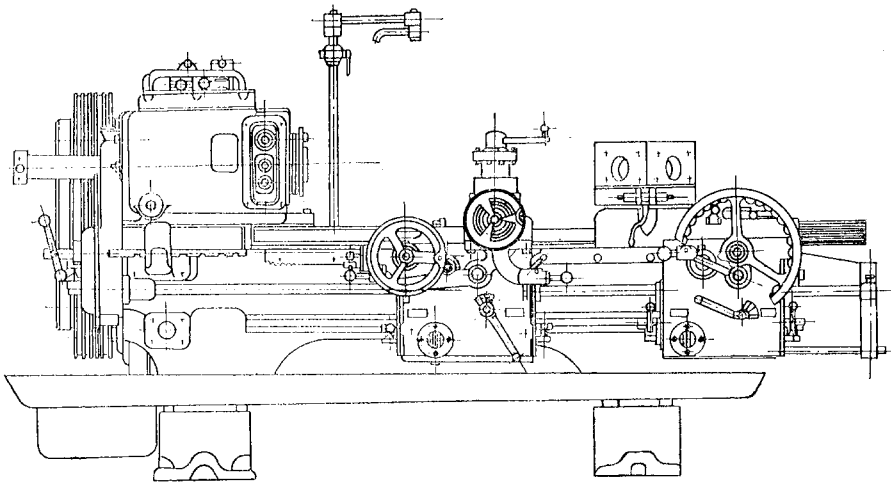

中國機械進口公司經售

Exported by CHINA NATIONAL MACHINERY IMPORT CORPORATION

香港代理處：華潤公司

Hong Kong Agency: CHINA RESOURCES CO

BANK OF CHINA BUILDING  
HONG KONG

CABLE ADDRESS: "CIRECO."

<b>Capacity</b>	
Height of centers, mm ... ..	210
Distance, end of spindle to turret face, mm:	
minimum ... ..	260
maximum ... ..	1177
Maximum swing, mm:	
over carriage ... ..	420
over cross slide ... ..	350
over bed ways ... ..	440

<b>Hexagon Turret</b>	
Total longitudinal travel (by power and manually), mm ... ..	917

<b>Carriage and Cross Slide</b>	
Total longitudinal travel of carriage (by power and manually), mm ... ..	1012
Total cross travel of slide, mm ... ..	259

<b>Speeds and Feeds</b>	
Number of spindle speeds ... ..	12
Range of spindle speeds, r. p. m.:	
forward... ..	44—1000
reverse ... ..	48—1094
Number of turret, carriage and cross slide feeds ... ..	16
Range of turret and carriage longitudinal feeds, mm per revolution of spindle	0.07—2.29
Range of cross slide feeds, mm per revolution of spindle... ..	0.03—1.00

<b>Drive</b>	
220/380 volt, 3 phase, 50 cycle A. C. motor:	
power, kw ... ..	10
speed, r. p. m. ... ..	1500

<b>Space Occupied</b>	
Floor space, mm ... ..	3200 x 1780
Height of machine, mm ... ..	1450

<b>Weight</b>	
Net weight, kg... ..	...approx. 2980

*N.B.—For improvement of the machine, we reserve the right to alter either the design or the specification.*

CODE : 6EM - 1012

六角車床  
TURRET LATHE

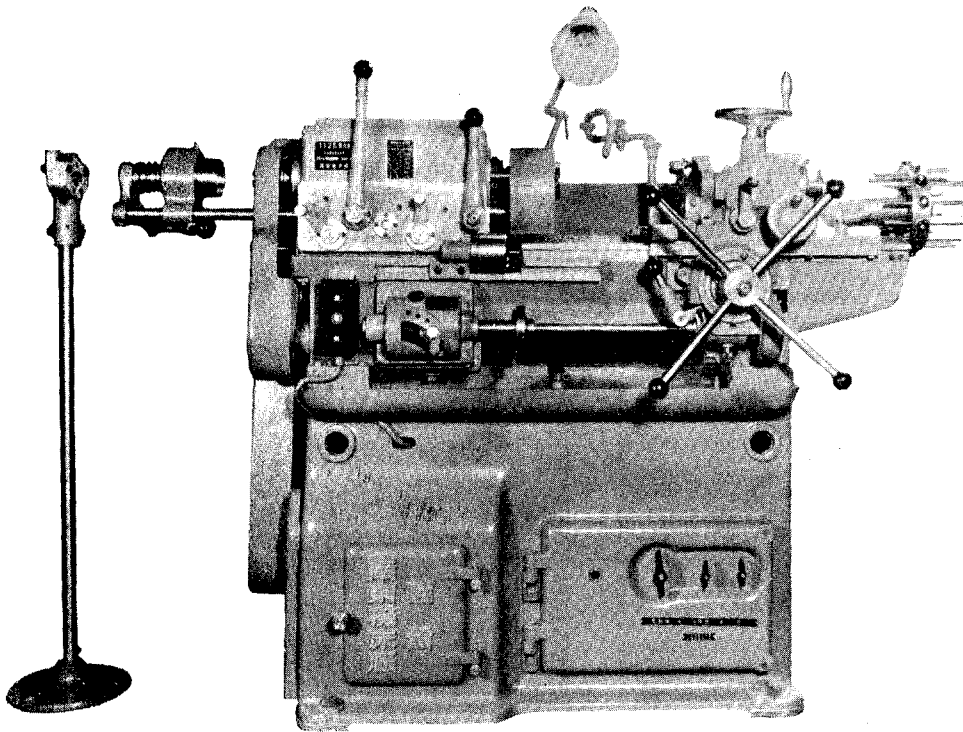

中國機械進口公司經售

Exported by CHINA NATIONAL MACHINERY IMPORT CORPORATION

香港代理處：華潤公司

Hong Kong Agency: CHINA RESOURCES CO.

BANK OF CHINA BUILDING

HONG KONG

CABLE ADDRESS: "CIRECO."

Small, faint text at the bottom of the page, likely a reference or contact number.



Centre height ... ..	115 mm
Distance, spindle nose to turret ... ..	90-400 mm
Spindle hole, diameter ... ..	26 mm.
Maximum size of bar to be turned:	
Circular diameter ... ..	25 mm
Square... ..	18 mm
Hexagonal ... ..	21 mm
Maximum length to be turned ... ..	150 mm
Maximum chucking diameter	
Swing over carriage ... ..	250 mm
Swing over bed ... ..	300 mm
Maximum longitudinal traverse of turret ... ..	330 mm
No. of spindle speeds ... ..	6
Range of spindle speeds ... ..	140-1380 rpm.
No. of longitudinal feeds of turret ... ..	4
Range of longitudinal feeds of turret per revolution of spindle ... ..	0.06-0.25 mm.
Space required (L x W x H) ... ..	1815 x 740 x 1290
Nett weight approximately ... ..	900 kg.
Electric drive motor, A. C. 3 $\phi$ , 50 c. 2.2 kw. 1450 rpm and 220/380 volts supply.	

*N.B.—For improvement of the machine, we reserve the right to alter either the design or the specification.*

CODE: 6EM-1013

牛頭鉋床  
CRANK SHAPER

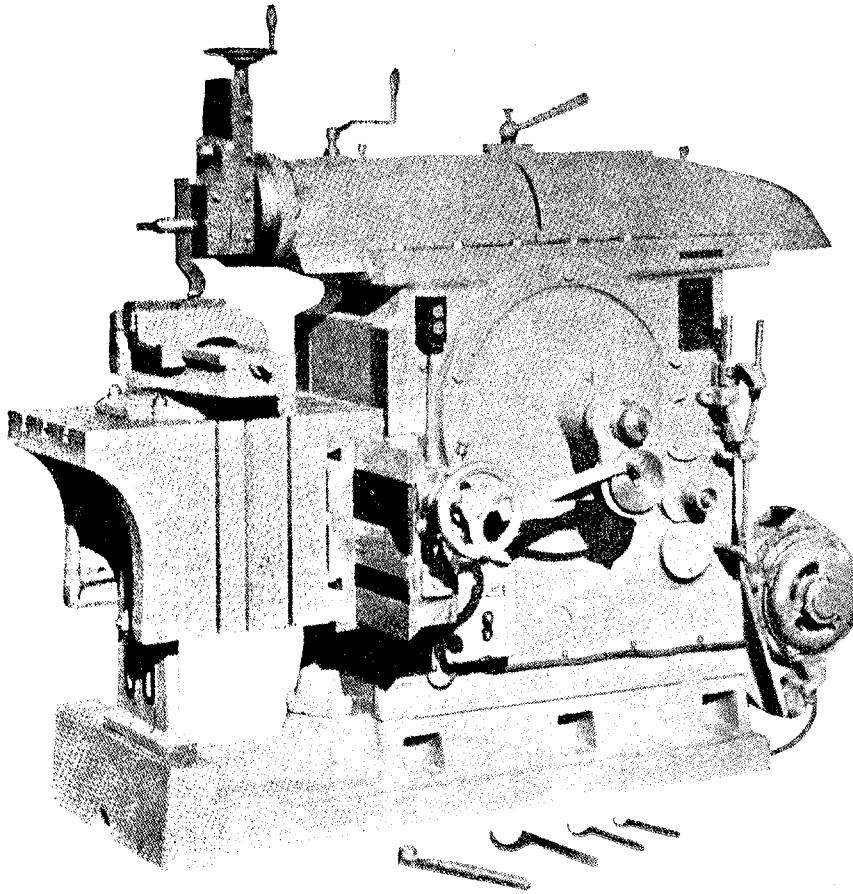

中國機械進口公司經售

Exported by CHINA NATIONAL MACHINERY IMPORT CORPORATION

香港代理處：華潤公司

Hong Kong Agency: CHINA RESOURCES CO.

BANK OF CHINA BUILDING  
HONG KONG

CABLE ADDRESS: "CIRECO."

**Capacity**

Length of ram stroke, mm:	
Minimum ... ..	95
Maximum ... ..	650
Distance from lower edge of ram to table, mm:	
Minimum ... ..	65
Maximum ... ..	370
Maximum distance from tool bottom to bed, mm ... ..	700

**Table**

Working surface of table, mm:	
Top ... ..	550 × 450
Side ... ..	450 × 400
Saddle of table ... ..	450 × 400
Maximum table traverse, mm:	
Horizontal (power and hand) ... ..	600
Vertical (by hand) ... ..	300

**Ram and Tool Head**

Maximum adjustment of ram (each side of center), mm ... ..	± 250
Maximum swivel of tool holder (each side of center) ... ..	± 20°
Maximum size of tool shank, mm ... ..	20 × 30
Maximum vertical travel of tool slide (by hand), mm ... ..	175
Maximum swivel of tool head (each side of center) ... ..	± 60°
Note: ± 60° swivel is allowed when clearance between tool head and bed guides is not less than 10 mm. In all other cases swivel of ± 20° is allowed.	

**Speeds and Feeds**

Number of ram double strokes per minute ... ..	12.5; 17.9; 25; 36.5; 52.5; 73
Table horizontal feeds, mm per double stroke of ram:	
Minimum (per 1 tooth of ratchet) ... ..	0.33
Maximum (per 10 teeth of ratchet) ... ..	3.33

**Drive**

220/380 volt, 3 phase, 50 cycle A. C. motor:	
Power, kw ... ..	3.5
Speed, r. p. m. ... ..	960

**Space Occupied**

Floor space, mm ... ..	2500 × 1450
Height of machine, mm ... ..	1750

**Weight**

Net weight, kg ... ..	approx. 1850
-----------------------	--------------

*N.B.—For improvement of the machine, we reserve the right to alter either the design or the specification.*

CODE: 6EM - 1014

龍 門 鉋 床  
DOUBLE HOUSING PLANER

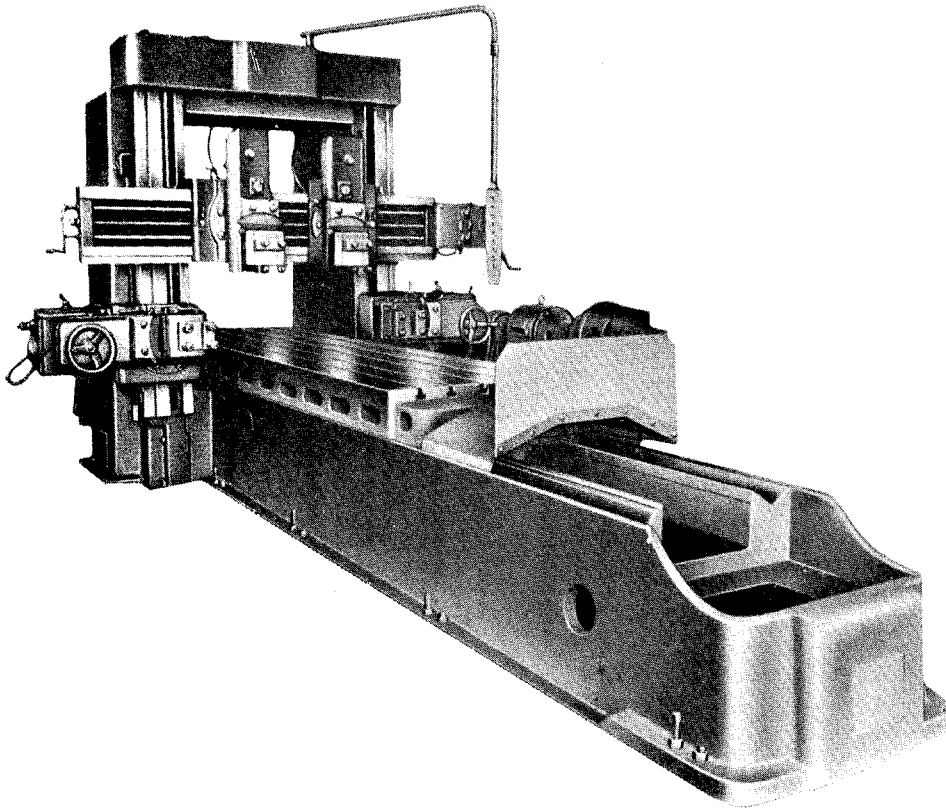

中國機械進口公司經售

*Imported by* CHINA NATIONAL MACHINERY IMPORT CORPORATION

香港代理處：華潤公司

*Hong Kong Agency:* CHINA RESOURCES CO.

BANK OF CHINA BUILDING  
HONG KONG  
CABLE ADDRESS: "CIRECO."

**Capacity**

Distance from table to vertical tool head, mm:	
Minimum	0
Maximum	890
Distance between axes of vertical tool heads, mm:	
Minimum	290
Maximum	1470
Maximum extension of side and vertical tool heads, mm	265
Maximum width planned, mm	1000
Maximum height planned, mm	850
Maximum length planned, mm	3000
Maximum weight of work piece admitted, kg	5000

**Table**

Working surface of table, mm	3000 x 900
Number of T-slots	5
Width of T-slots, mm	28
Distance between slots, mm	150

**Speeds and Feeds**

Range of table cutting speeds, m/min.	5—75
Range of table return speeds, m/min.	15—75
Range of feeds of vertical tool heads per double stroke, mm:	
Vertical	0.125—6.2
Horizontal	0.5—25
Range of vertical feeds of side tool heads per double stroke, mm	0.25—11.5
Speed of rapid power traverse, m/min:	
Vertical heads:	
horizontal/vertical	2.33/0.585
Side heads: Vertical	1.07
Power travel of cross rail, m/min	0.5

**Drive**

Number of electrical units	13
Motor-generator unit:	
Power of asynchronous motor, kw	40
Speed, r. p. m.	1460
Head feed motors: (3 pcs)	
Power, kw	1.7
Speed, r. p. m.	1430
Cross rail elevating motor:	
Power, kw	1.7
Speed, r. p. m.	1430
Cross rail clamping motor:	
Power, kw	0.6
Speed, r. p. m.	1410

**Space Occupied**

Floor space, mm	7200 x 3650
Height of machine, mm	2680

**Weight**

Net weight, kg	...approx. 20500
----------------	------------------

*N.B.—For improvement of the machine, we reserve the right to alter either the design or the specification.*

CODE: 6EM - 1019

普通車床  
ALL GEARED LATHE

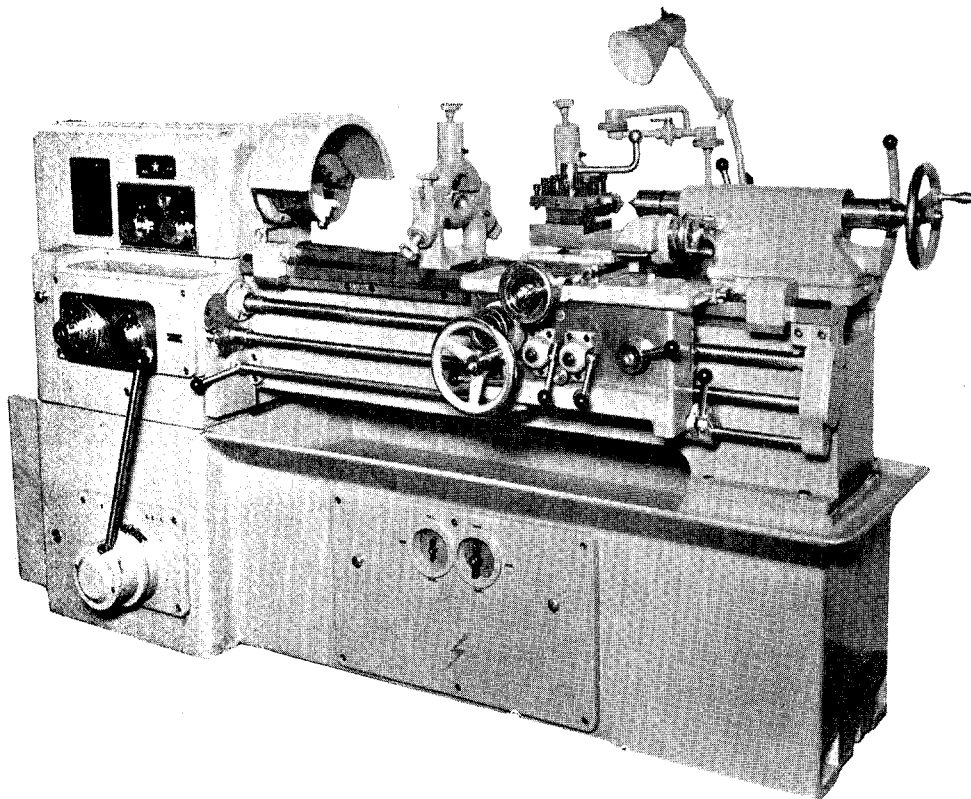

中國機械進口公司經售

*Exported by* CHINA NATIONAL MACHINERY IMPORT CORPORATION

香港代理處：華潤公司

*Hong Kong Agency:* CHINA RESOURCES CO.

BANK OF CHINA BUILDING  
HONG KONG  
CABLE ADDRESS: "CIRECO."

<b>Capacity</b>	
Height of centers, mm ... ..	160
Maximum distance between centers, mm ... ..	750
Bar capacity, mm ... ..	29
Swing over cross slide, mm ... ..	175
Swing over bed ways, mm ... ..	320
Threads that can be cut:	
Metric, pitch in mm ... ..	0.5—9
English, threads per inch ... ..	38—2
Module ... ..	0.5—9
<b>Carriage</b>	
Maximum travel (power or manual feed), mm:	
longitudinal ... ..	850
cross ... ..	210
Distance from tool bottom to center line, mm ... ..	20
Maximum distance from center line to the face of tool holder, mm ... ..	185
Maximum size of tool, mm ... ..	20 × 20
<b>Spindle</b>	
Diameter of hole in spindle, mm ... ..	30
Taper hole in spindle ... ..	Morse No. 5
<b>Tailstock</b>	
Taper hole in spindle ... ..	Morse No. 4
Maximum travel of spindle, mm ... ..	95
Setover on side, mm ... ..	± 10
<b>Speeds and Feeds</b>	
Number of spindle speeds (forward and reverse) ... ..	12
Range of spindle speeds, r. p. m. ... ..	44—1980
No. of feeds of slide, longitudinal and cross ... ..	140
Range of feeds of slide mm per revolution of spindle:	
longitudinal ... ..	0.06—3.34
cross ... ..	0.044—2.47
<b>Drive</b>	
220/380 volt, 3 phase, 50 cycle A. C. motors:	
Main drive:	
power, kw ... ..	4.5
speed, r. p. m. ... ..	1440
Coolant pump:	
power, kw ... ..	0.125
speed, r. p. m. ... ..	2850
Lubricating pump:	
power, kw ... ..	0.125
speed, r. p. m. ... ..	2850
<b>Space Occupied</b>	
Floor space, mm ... ..	2355 × 852
Height of machine, mm ... ..	1255
<b>Weight</b>	
Net weight, kg ... ..	approx. 1950

*N.B.—For improvement of the machine, we reserve the right to alter either the design or the specification.*

CODE: 6EM - 1021

普 通 車 床

ALL GEARED LATHE

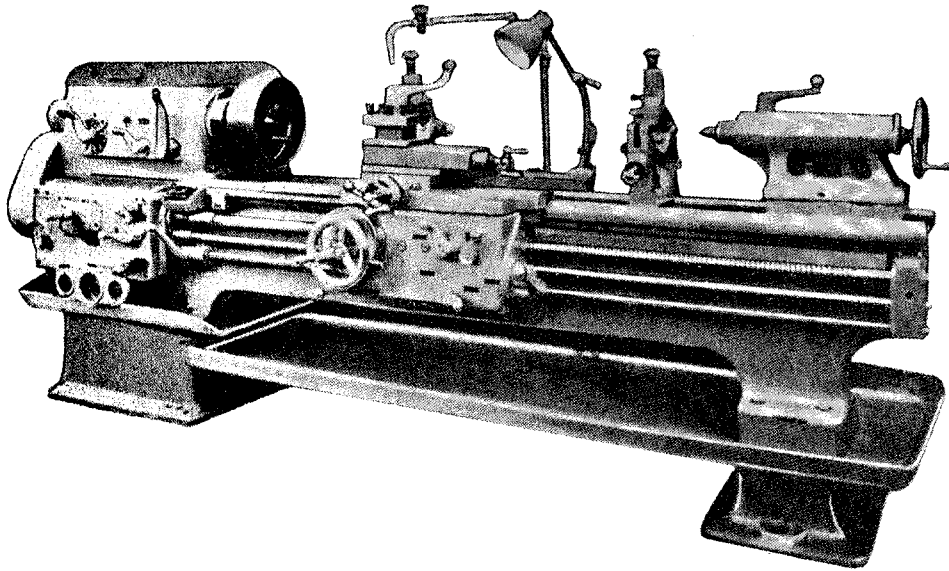

中國機械進口公司經售

Reported by CHINA NATIONAL MACHINERY IMPORT CORPORATION

香港代理處：華潤公司

Hong Kong Agency: CHINA RESOURCES CO.

BANK OF CHINA BUILDING  
HONG KONG  
CABLE ADDRESS: "CIRECO."



Height of center ... ..	200 mm
Distance between centers ... ..	1000 mm
Maximum turning diameter:	
round rod ... ..	37 mm
swing over carriage ... ..	210 mm
swing over bed ... ..	410 mm
Maximum turning length ... ..	900 mm
Thread cutting:	
metric threads, pitch ... ..	1—192 mm
whitworth threads, t.p.i. ... ..	24—2
module threads, M ... ..	0.25—48
UP threads, DP ... ..	96—1
Maximum traverse of carriage (mechanically or manually):	
longitudinal ... ..	900 mm
cross ... ..	280 mm
Height between tool supporting surface to center line ... ..	23 mm
Maximum traverse of tool post ... ..	100 mm
Maximum swivel of tool post ... ..	45°
Diameter of spindle bore ... ..	38 mm
Taper of spindle bore ... ..	Morse No. 5
Taper of center sleeve ... ..	Morse No. 4
Maximum traverse of center sleeve ... ..	150 mm
Maximum cross traverse of tailstock ... ..	15
No. of spindle speeds (normal/reverse) ... ..	18/9
Range of spindle speeds:	
Normal ... ..	12—600 rpm.
reverse ... ..	18—760 rpm.
No. of longitudinal and cross feeds of carriage ... ..	35
Range of feed of carriage per revolution of spindle:	
longitudinal ... ..	0.082-1.59mm
cross ... ..	0.27-0.522mm
Electric motor (3 phase A.C.) power/speed ... ..	4.5/1500 kw/rpm.
Overall dimensions (L x W x H) ... ..	2650x1580 x 1220
Nett weight approx. ... ..	2240 kg.
Electric drive equipments includes:	
1 main drive motor of 4.5 kw and 1500 rpm., AC 3 $\phi$ , 50 cycle, 220/380 v.	

*N.B.—For improvement of the machine, we reserve the right to alter either the design or the specification.*

CODE: 6EM - 1025

半自動多刀車床  
MULTI - TOOL SEMIAUTOMATIC LATHE

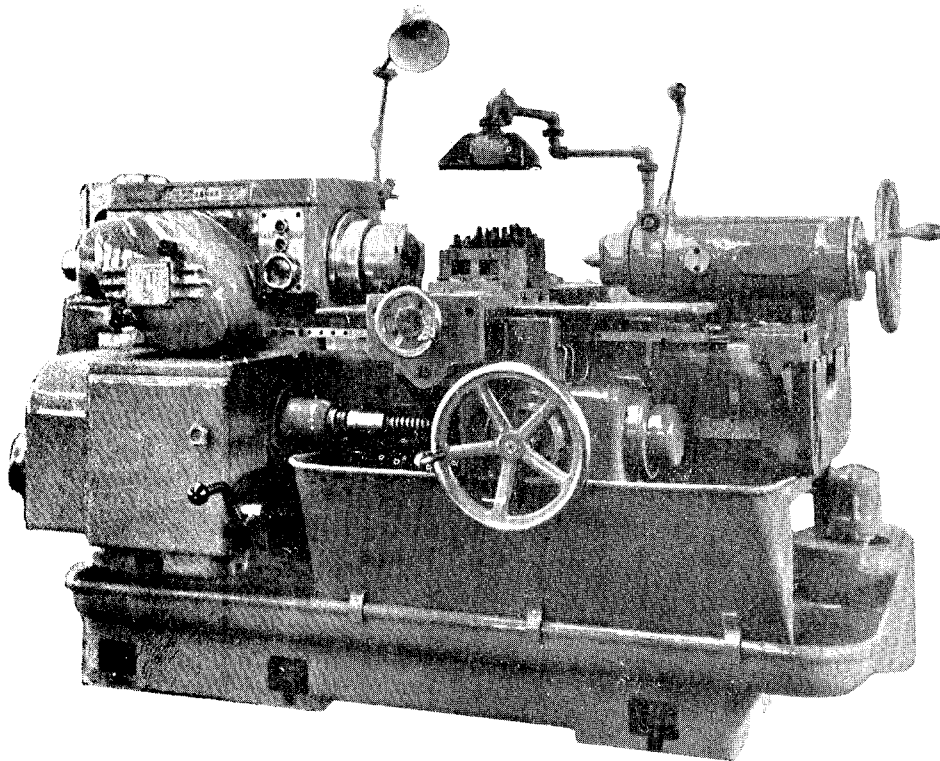

中國機械進口公司經售

Exported by CHINA NATIONAL MACHINERY IMPORT CORPORATION

香港代理處：華潤公司

Hong Kong Agency: CHINA RESOURCES CO.

BANK OF CHINA BUILDING  
HONG KONG  
CABLE ADDRESS: "CIRECO."

Center height...	200 mm
Distance between centers (min./max.)...	200/500 mm
Maximum distance from spindle nose to center of tailstock ...	580 mm
Maximum turning diameter:	
for bar ...	48 mm
swing over bed ...	410 mm
swing over carriage ...	300 mm
Maximum turning length (two cutters)...	460 mm
Maximum longitudinal traverse of carriage:	
mechanically (turning) ...	250 mm
manually (adjusting) ...	325 mm
Maximum cross traverse of rear tool post:	
mechanically (turning)/manually (adjusting) ...	235/225 mm
Maximum traverse of center socket ...	165 mm
Spindle speeds: ...	40, 52, 65, 84, 107, 129, 155, 187, 240, 310, 388, 500. rpm.
Longitudinal feed of carriage per 1 revolution of spindle:	
	0.12, 0.17, 0.23, 0.34, 0.49, 0.71, 0.97, 0.38. mm.
No. of cross feeds per each longitudinal feed. ...	12
Range of cross feeds of rear tool post per 1 revolution of spindle: ...	0.16—2.37 mm.
3 phase A. C. Motors:	
for main driving: power/speed ...	10/1455 kw/rpm.
for rapid adjustment at carriage: power/speed ...	1/1425 kw/rpm.
for coolant pump: power/speed ...	0.15/2800 kw/rpm.
Overall dimensions (L x W x H) ...	2200 x 1700 x 1240 mm.
Net weight ...	apprcx. 3000 kg.

*N.B.—For improvement of the machine, we reserve the right to alter either the design or the specification.*

CODE: 6EM-1026

單柱立式車床  
VERTICAL BORING MILL

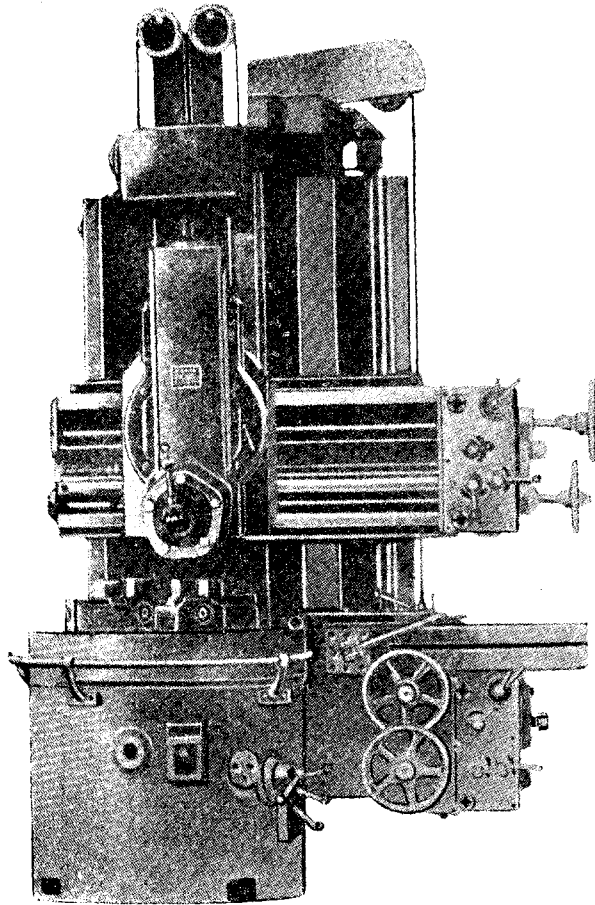

中國機械進口公司經售

*Exported by* CHINA NATIONAL MACHINERY IMPORT CORPORATION

香港代理處：華潤公司

*Hong Kong Agency:* CHINA RESOURCES CO.

BANK OF CHINA BUILDING  
HONG KONG  
CABLE ADDRESS: "CIRECO."

Diameter of table ... ..	1030 mm.
Distance between center of table and surface of column ... ..	625 mm.
Maximum turning diameter:	
with vertical head ... ..	1250 mm.
with side tool head ... ..	1120 mm.
Boring diameter (by rotary tool post or vertical tool head) minimum/maximum	120/1250 mm.
Maximum height of workpiece ... ..	1000 mm.
Maximum weight of workpiece... ..	2000 mm.
Turning length by side tool head:	
on working table ... ..	730 mm.
outside working table ... ..	960 mm.
Diameter of workpiece to be clamped,	
minimum/maximum ... ..	70/900 mm.
Maximum traverse of vertical tool head (mechanically or manually),	
horizontal/vertical. ... ..	750/700 mm.
Maximum swivel of vertical tool head ... ..	45°
Maximum traverse of side tool head (mechanically or manually),	
horizontal/vertical. ... ..	600/960 mm.
Spindle bore of table ... ..	150 mm.
No. of table speeds ... ..	12
Range of table speeds ... ..	7.5 - 150 rpm.
No. of feeds of vertical tool head and side tool head ... ..	8
Feed per revolution of table... ..	0.23 - 8.4 mm.
Rapid traverse of vertical tool head & side tool head ... ..	2 m/min.
Rapid elevating speed of rail ... ..	0.5 m/min.
3 $\phi$ A. C. motor:	
for main drive: output/speed ... ..	22/1460 kw/rpm.
for rapid adjustment output/speed ... ..	1.7/930 kw/rpm.
Overall dimensions (L x W x H) ... ..	2350 x 2185 x 3815 mm
Net weight approx. ... ..	10000 kg.

*N.B.—For improvement of the machine, we reserve the right to alter either the design or the specification.*

CODE: 6EM - 1031

插 齒 機  
G E A R S H A P E R

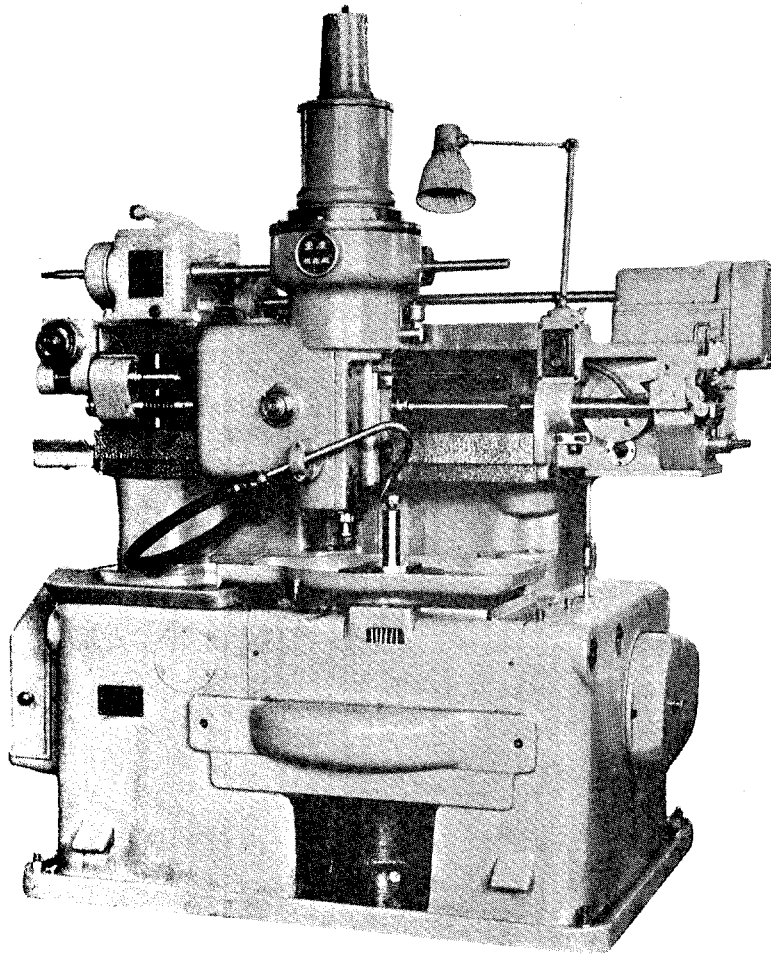

中國機械進口公司經售

*Exported by* CHINA NATIONAL MACHINERY IMPORT CORPORATION

香港代理處：華潤公司

*Hong Kong Agency:* CHINA RESOURCES CO

BANK OF CHINA BUILDING

HONG KONG

CABLE ADDRESS: "CIRECO."

**Capacity**

Distance between work spindle face and cutter shoulder at maximum eccentricity of crank pin, mm:	
maximum	160
minimum	35
Module that can be cut, mm	2—6
External diameter of spur and helical gears, mm:	
maximum	462
minimum	20
Maximum external diameter of work when cutting internal teeth, mm	550
Maximum face width that can be cut, mm...	105
Maximum helix angle for helical gears...	23°

**Cutter Saddle**

Maximum length of cutter spindle stroke, mm	125
Maximum longitudinal cutter saddle traverse, mm	510

**Work Spindle Apron**

Maximum relieving movement of apron, mm	0.5
Diameter of work spindle flange, mm	240
Maximum distance between centers of work and cutter, mm	350

**Speeds and Feeds**

Number of cutter strokes per minute	125; 179; 253; 359
Rotary feeds, mm per stroke of cutter...	0.17; 0.21; 0.24; 0.30; 0.35; 0.44

**Drive**

220/380 volt, 3 phase, 50 cycle A. C. motors:

Main drive:	
power, kw	2.8
speed, r. p. m.	1437
Rapid rotation of work spindle:	
power, kw	0.6
speed, r. p. m.	1440
Coolant pump:	
power, kw	0.25
speed, r. p. m.	2820

**Space Occupied**

Floor space, mm	1750 x 1270
Height of machine, mm...	2060

**Weight**

Net weight, kg	approx. 3530
----------------	--------------

*N.B.—For improvement of the machine, we reserve the right to alter either the design or the specification.*

CODE: 6EM - 1034

萬 能 銑 床  
UNIVERSAL MILLING MACHINE

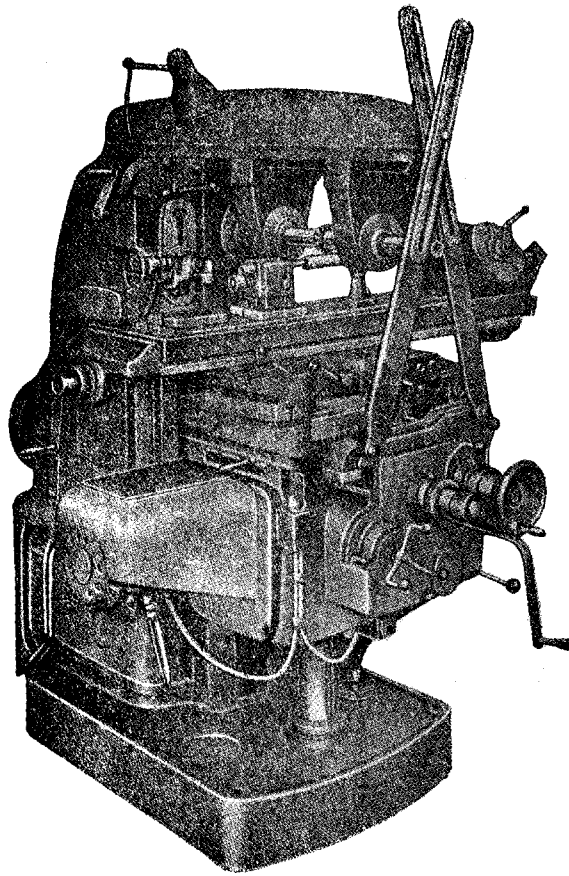

中國機械進口公司經售

*Exported by* CHINA NATIONAL MACHINERY IMPORT CORPORATION

香港代理處：華潤公司

*Hong Kong Agency:* CHINA RESOURCES CO.

BANK OF CHINA BUILDING  
HONG KONG  
CABLE ADDRESS: "CIRECO."



**Capacity**

Working surface of table, mm	1000 x 250
Distance, center line of spindle to top of table, mm:	
Minimum	30
Maximum	350
Distance, face of column to center line of table, mm:	
Minimum	170
Maximum	370
Distance, center line of spindle to overarm, mm	150
Maximum table traverse, mm:	
Longitudinal	650
Cross	200
Vertical	350
Maximum table swivel	$\pm 45^\circ$

**Speeds and Feeds**

Number of spindle speeds	16
Range of spindle speeds, r. p. m.	65—1800
Number of table feeds	16
Range of table feeds, mm/min.:	
Longitudinal	35—980
Cross	25—765
Vertical	12—380

**Drive**

220/380 volt, 3 phase, 50 cycle A. C. motors:

Main drive:

Power, kw	4.5
Speed, r. p. m.	1450

Feed drive:

Power, kw	1.7
Speed, r. p. m.	1430

Coolant pump:

Power, kw	0.1
Speed, r. p. m.	2800

**Space Occupied**

Floor space, mm	1800 x 1470
Height of machine, mm	1590

**Weight**

Net weight, kg	approx. 2100
----------------	--------------

*N. B.—For improvement of the machine, we reserve the right to alter either the design or the specification.*

CODE: RM - 2001

**B-3 型 橡 口 織 襪 機**  
**AUTOMATIC HOSIERY MACHINE,**  
FOR COLOUR STRIPED SOCKS WITH  
ELASTIC TOP  
**MODEL B-3**

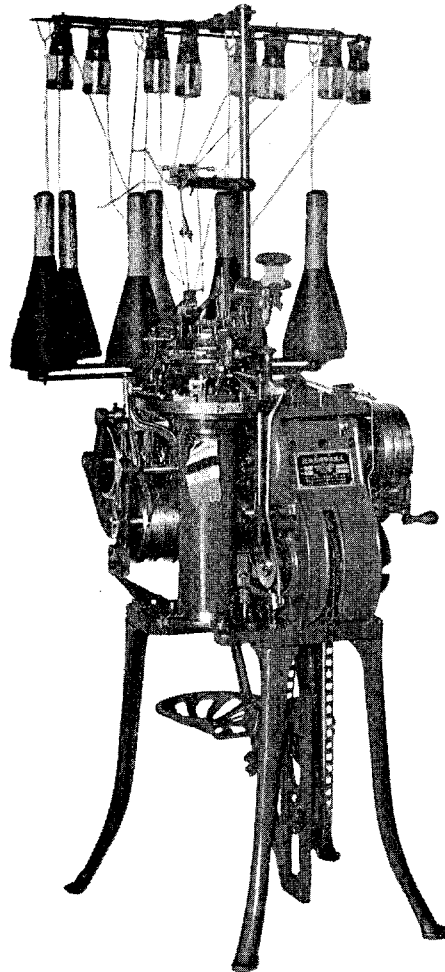

中國運輸機械進口公司經售

*Exported by* CHINA NATIONAL TRANSPORT MACHINERY IMPORT CORPORATION

香港代理處：華潤公司

*Hong Kong Agency:* CHINA RESOURCES CO.

BANK OF CHINA BUILDING  
HONG KONG  
CABLE ADDRESS: "CIRECO."

Model B-3 differs from Model B-1 in such a way that it is provided with attachments for making colour striped hose with elastic top.

The colour stripe pattern is accomplished by means of a colour pattern drum and yarn changing fingers, it enables the knitting of a large variety of horizontal striped pattern. The colour pattern drum is mounted above the main pattern drum, latter being common to all Model B machines. For cutting the pattern yarns, an automatic cutter is fitted to the colour pattern drum.

The machine is arranged with six yarn changing fingers for patterns in horizontal stripes of five different colours.

An elastic lay-in attachment is provided for insertion of rubber yarns in elastic tops. These elastic tops insure comfort in wear and will fit snugly to the leg.

Model B-3 embodies our latest improvements and designs and is worthy of recommendation. Besides, it produces colour striped hose which is well in demand in various countries of the world.

#### Specifications :

##### *Number of Needles :*

Available in cylinder diameters and number of needles as follows:—

3 $\frac{1}{4}$ " with 160, 176 and 188 needles.

3 $\frac{1}{2}$ " with 160, 176, 188 and 200 needles.

*Power Required :* 1/4 H. P.

*Cylinder Speed :* 200 - 220 rpm.

*Drive Pulley :* 7" dia. 3/4" width. Speed: 138 - 150 rpm.

*Floor Space :* Installation floor space 1' - 6" x 2' - 6"

Working space 2' - 6" x 5' - 0"

*Production :* Based on 8 working hours about 70 pairs of cotton socks.

*Packing :* In wooden case.

##### *Shipping Specification:*

Net weight 385 lbs. Gross weight 500 lbs. Measurement: 27" x 30" x 34".

*N.B.—For improvement of the machine, we reserve the right to alter either the design or the specification.*

CODE: RT-2002

棉毛織機 (又名雙面機)  
INTERLOCK KNITTING MACHINE

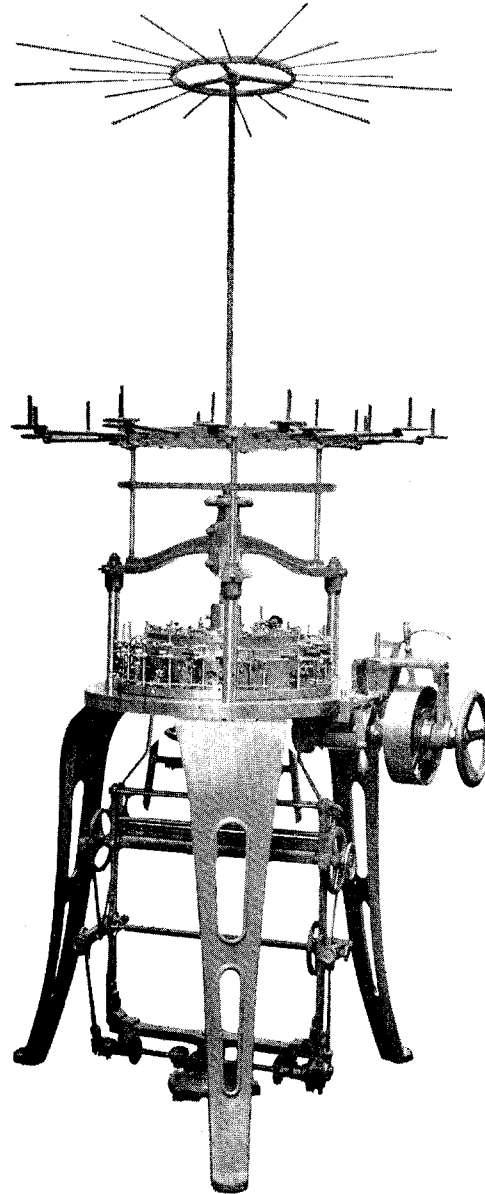

中國運輸機械進口公司經售

Exported by CHINA NATIONAL TRANSPORT MACHINERY IMPORT CORPORATION

香港代理處：華潤公司

Hong Kong Agency: CHINA RESOURCES CO.

BANK OF CHINA BUILDING

HONG KONG

CABLE ADDRESS: "CIRECO."

This machine is a multiple-feed, circular, latch-needle interlock stitch knitting machine of non-sinker type, designed for producing interlock fabrics in either plain colours or a wide range of horizontal stripes. With modification of its parts, it can produce towel fabrics.

The planned body size comes right off the machine, eliminating the slitting and sewing of side seams.

Outstanding advantages of the machine are:—

### SIMPLIFIED MAINTENANCE - ECONOMY IN SPACE

**Construction:-** The machine features tripod construction; positive clutch; brass cut cylinder and dial; hardened needle cams for cylinder and dial; stationary bobbin stand; revolving take-up and cloth roll-up; fabric stop motion.

**Number of Feeds:-** The machine is built in different cylinder diameters with corresponding number of feeds as follows:-  
14" - 14 feeds; 15" - 16 feeds; 16" - 16 feeds;  
17" - 18 feeds; 18" - 18 feeds; 19" - 20 feeds;  
20" - 20 feeds; 21" - 22 feeds.

**Gauge:-** The cylinder and dial can be supplied in different gauges (number of needles per inch) to suit the counts of cotton yarn handled. For example, when using 20/1 cotton yarn, we recommend 17 needles per inch for fine quality fabrics and 13-14 needles per inch for second quality.

**Speed:-** For 18" diameter machine, the cylinder speed is 18 revolutions per minute.

**Power required:-** 3/4 HP in case of individual drive.  
3 HP for 6 machines in case of group drive.

**Output:-** The output increases or decreases depending on the skill of the operator, gauge and diameter, count of yarn, etc. Average 280 - 440 ounces in 8 hours.

**Width of Fabric:-** The width of fabric depends on the diameter of the machine, kind of material, count of yarn, etc. When using cotton of medium counts, we recommend diameter of machine as follows:-

For Underwear:-

Diameter of machine	17"	18"	19"	20"	21"
Open width of fabric	32"	34"	36"	38"	40"

For slitting trousers:-

Diameter of machine	19"	20"	21"	22"
Size of trousers	32"	34"	36"	38"

**Data for 18" Diameter machine:-**

Installation floor space	3' 8" X 4' 4"
Working space required	5' 6" X 6' 6"
Net weight - 880 lbs.	

*N.B.—For improvement of the machine, we reserve the right to alter either the design or the specification.*

CODE: RT - 2003

複式汗絨針織機 (湯姆金機)  
SPRING NEEDLE KNITTING MACHINE

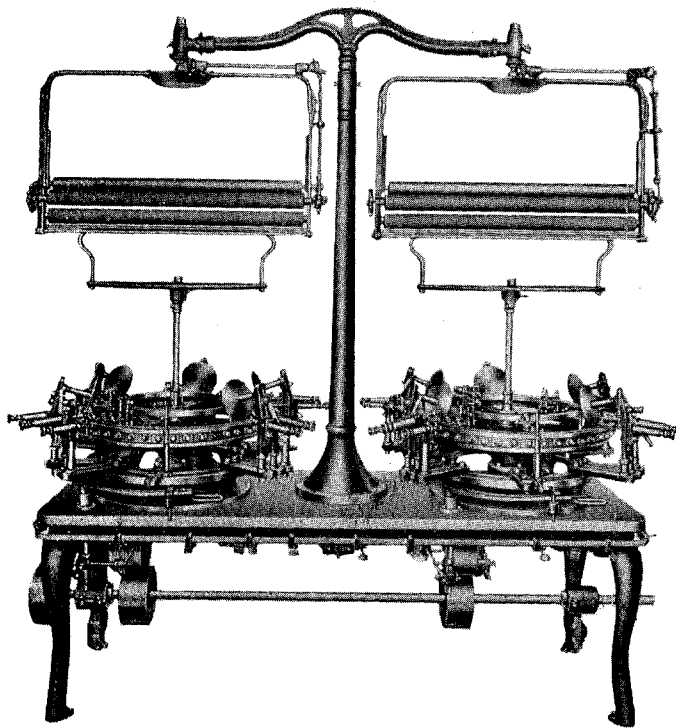

中國運輸機械進口公司經售

*Exported by* CHINA NATIONAL TRANSPORT MACHINERY IMPORT CORPORATION

香港代理處：華潤公司

*Hong Kong Agency:* CHINA RESOURCES CO.

BANK OF CHINA BUILDING  
HONG KONG  
CABLE ADDRESS: "CIRECO."

This machine is a multi-feed, circular spring needle knitting machine designed for producing cambric fabrics, common tissue or different weight of cotton flannel, and also plain colour imitation of camel hair fabrics. Equipped with additional pattern attachment, the machine can produce many different kinds of fancy knitted cloth. The machine is equipped with automatic take-up and rolling up of fabric as knit. Take up is suspended on ball bearing over the center of the cylinder and is constructed for variable production of fabric. Fabric stop motion is applied to each cylinder.

The machine can be arranged for individual or group drive. A positive clutch is provided on each cylinder facilitating starting of the machine.

Machines are built in two table sizes, A and B respectively, with two cylinders installed on the same table. Cylinders are available in two ranges, viz., for table size, A-16" to 20"; B-24" to 30". According to the cylinder diameters, 3 to 5 feeds are applied to each cylinder.

The gauge of the machine should be adapted to the kind of products.

We recommend cylinder gauges as follows:

PRODUCT	Cylinder Diameter Recommended	Cylinder Gauge	No. of Feeds Each Cylinder	Cotton Yarn Used
Tissue cloth	16" - 20"	32, 34, 36, 40	4 or 5	6 <sup>s</sup> x1 - 40 <sup>s</sup> x1
Cotton flannel	24" - 30"	20, 22, 24, 28	3	32 <sup>s</sup> x1 - 100 <sup>s</sup> / 2x1

Outstanding advantage of the machine is its capability of producing a large variety of fabrics with finest quality as is not possible with ordinary knitting machines.

The output depends on the skill of the operator, gauge and diameter, counts or yarns, etc., and average is:

For tissue cloth-500 to 700 ounces in 8 hours;

For cotton flannel-2,000 to 2,800 ounces in 8 hours.

#### DATA OF SPRING NEEDLE MACHINE

Table Size	A	B
Cylinder Diameter	16" to 20"	24" to 30"
Working Space Required	4'0" x 8'6"	5'0" x 9'0"
Horse Power Required	1½ HP	2 HP
Cylinder Speed	70-80 RPM	60-65 RPM
Net Weight	2,240 lbs.	2,700 lbs.

*N.B.—For improvement of the machine, we reserve the right to alter either the design or the specification.*

COOE: RT - 2004

電 動 領 口 羅 紋 機  
AUTOMATIC RIB NECK KNITTING MACHINE

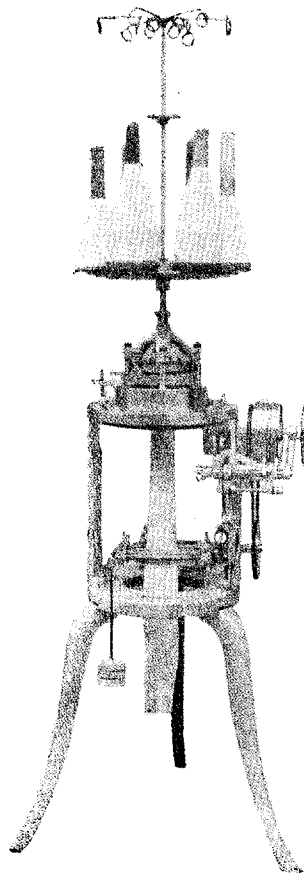

中 國 運 輸 機 械 進 口 公 司 經 售

Exported by CHINA NATIONAL TRANSPORT MACHINERY IMPORT CORPORATION

香港代理處：華 潤 公 司

Hong Kong Agency: CHINA RESOURCES CO.

BANK OF CHINA BUILDING  
HONG KONG

CABLE ADDRESS: "CIRECO."



This machine is used for knitting rib necks of underwears, stockinetes or sweaters.

*Specification:-* Available in different cylinder diameters with number of needles as follows:-

6", 3 Shuttles, 320-540 needles

6½", 3 Shuttles, 320-540 needles

7", 4 Shuttles, 320-540 needles

*Power Required:-* ½ HP for single machine, 1 HP for 3 machines in group drive

*Cylinder Speed:-* 75-80 rpm.

*Weight:-* Nett: 110 kgs. approx.

Gross: 150 kgs. approx.

*Floor Space:-* Space occupied 26" x 26"

Working space required 4' x 5'

*Attendance:-* One person can operate 5-6 machines

*Production:-* Based on 10 working hours, 400-500 shi-liangs (12½-15¾ kgs.) for 20s/2 yarn, and 300-500 shi-liangs for 42s/2 yarn.

*N.B.—For improvement of the machine, we reserve the right to alter either the design or the specification.*

CODE : RT - 2005

紅 木 錠 搖 紗 機  
BOTTLE BOBBIN WINDING MACHINE

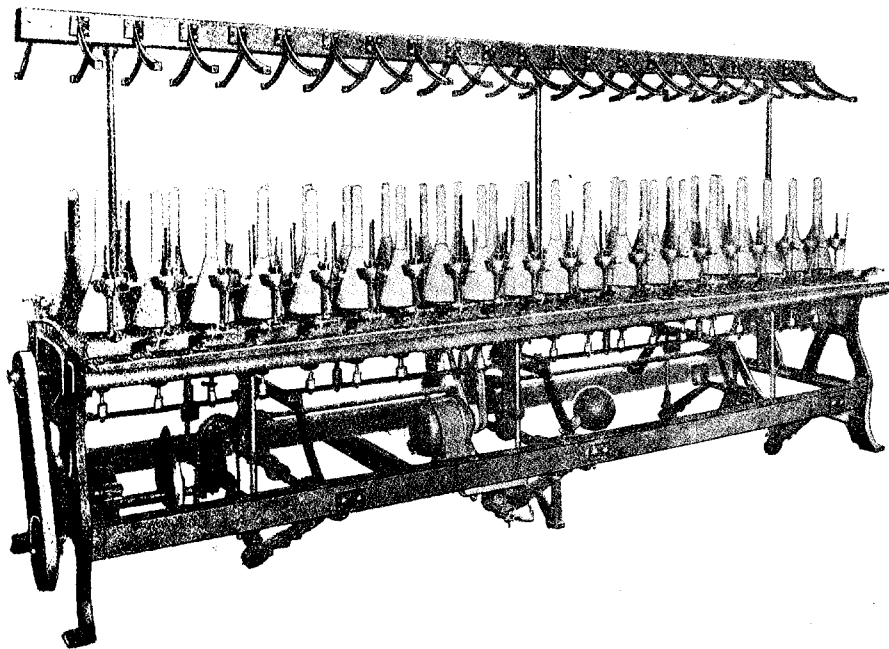

中國運輸機械進口公司經售

Exported by CHINA NATIONAL TRANSPORT MACHINERY IMPORT CORPORATION

香港代理處：華潤公司

Hong Kong Agency: CHINA RESOURCES CO.

BANK OF CHINA BUILDING  
HONG KONG  
CABLE ADDRESS: "CIRECO."

This machine is used for winding yarns in skeins or rewinding yarns in bamboo reels into bottle bobbin.

**Specification:-** 36 spindles, 40 spindles

**Power Required:-** 1 HP. for 36 spindles machine,  $1\frac{1}{2}$  HP. for 40 spindles machine; driven by an electric motor with a speed of 960 r. p. m.

**Speed:-** Spindles speed: 800-1000 rpm  
Driven pulley: 12" - 12.3/8" diam.  
280-300 rpm  
Slow speed for winding from skeins and fast speed for rewinding from reels.

**Nett Weight:-** 800 kgs. for 36 spindles machine, 850 kgs. for 40 spindles machine.

**Floor Space:-** Space occupied:  
36 spindles machine 13' x 4'  
40 spindles machine 14' x 4'

Working space required:  
36 spindles machine 14' x 8'  
40 spindles machine 16' x 8'

**Production:-** In package of 3.75 kgs. per 10 working hours a day with 40 spindles, (for skein winding and rewinding)

Single yarn:  
50-60 for 6s., 8s.; 32-40 for 10s.  
20-30 for 20s; 12-14 for 32s;  
8-10 for 40s.

Twist yarn:  
30-40 for 32s; 24-34 for 42s;  
14-16 for 60s; 10-12 for 84s;  
8-9 for 100s.

**Advantages:-** 1) Direct winding from skein to the bobbin  
2) Suitable for 2 wide range of yarn 6s.-100s.  
3) High production and low power consumption  
4) Non stop bobbin changing.

*N.B.—For improvement of the machine, we reserve the right to alter either the design or the specification.*

CODE: RT - 2006

汗 布 機 (又名台木魯)  
BODY SIZE KNITTING MACHINE

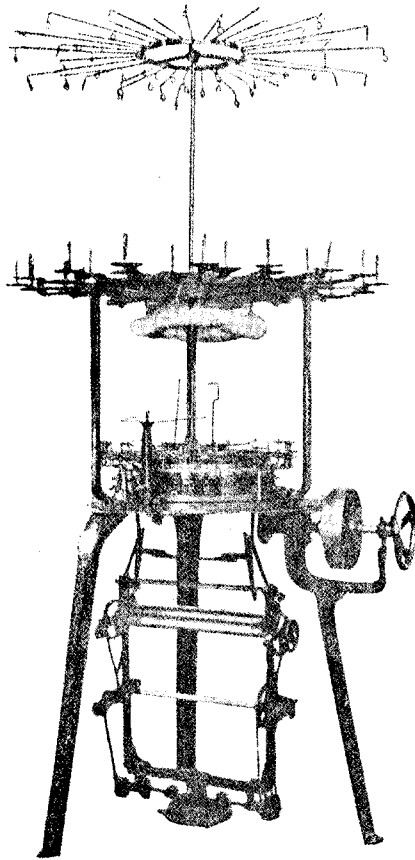

中國運輸機械進口公司經售

Exported by CHINA NATIONAL TRANSPORT MACHINERY IMPORT CORPORATION

香港代理處：華潤公司

Hong Kong Agency: CHINA RESOURCES CO.

BANK OF CHINA BUILDING

HONG KONG

CABLE ADDRESS: "CIRECO."

This machine is a multiple feed, circular, latch-needle knitting machine of non-sinker type, designed for production of plain fabrics in either plain colours or a wide range of horizontal stripes. With modification of its parts, it can produce net fabrics.

The planned body size of the underwear comes right off the machine, eliminating the slitting and sewing of side seams.

Outstanding advantages of the machine are:-

### SIMPLIFIED MAINTENANCE---INCREASED PRODUCTION

*Main Features:-* The machine features tripod construction; positive clutch; brass cut cylinder; hardened needle cams; stationary bobbin stand; revolving take up and cloth roll up; fabric stop motion.

*Number of Feeds:-* The machine is available in different cylinder diameters with corresponding number of feeds as follows:-  
13" - 26 feeds; 14" - 28 feeds; 15" - 30 feeds;  
16" - 32 feeds; 17" - 34 feeds; 18" - 36 feeds;  
19" - 38 feeds; 20" - 40 feeds;

*Gauge:-* The cylinder can be supplied in different gauges (number of needles per inch) to suit the counts of cotton yarn handled. For common plain fabrics, 19-20 needles per inch is recommended.

*Speed:-* For 18" diameter machine, the cylinder speed is 22 revolutions per minute.

*Power required:-* 3/4 HP in case of individual drive.  
3 HP for six machines in case of group drive.

*Output:-* The output depends upon the skill of the operator, gauge and diameter, count of yarn, etc.

*Average:-*

When using 32/1 and 40/1 cotton yarns, 320-480 oz. in 8 hrs.

When using 16/1 and 20/1 cotton yarns, 480-640 oz. in 8 hrs.

*Width of Fabric:-* The width of fabric depends on the diameter of the machine, kind of material, count of yarn, etc. When using cotton of medium counts, we recommend diameter of machine as follows:-

For Underwear:-

Diameter of machine:- 16" 17" 18" 19" 20"

Open width of fabric:- 32" 34" 36" 38" 40"

*Data for 18" Diameter Machine:-*

Installation floor space 3' 8" x 4' 4"

Working space required 5' 6" x 6' 6"

Net weight 660 lbs.

*N.B.—For improvement of the machine, we reserve the right to alter either the design or the specification.*

CODE: RT - 2007

縫襪頭機 (又名套口機)

LOCKSTITCH LOOPER

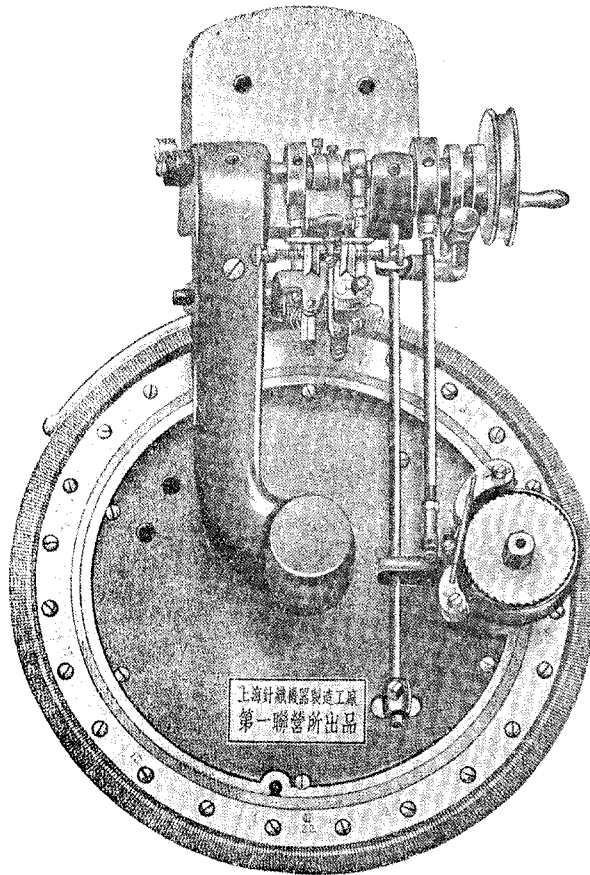

中國運輸機械進口公司經售

Exported by CHINA NATIONAL TRANSPORT MACHINERY IMPORT CORPORATION

香港代理處：華潤公司

Hong Kong Agency: CHINA RESOURCES CO.

BANK OF CHINA BUILDING  
HONG KONG  
CABLE ADDRESS: "CIRECO."

This machine is used for looping toe-top hosiery or sleeves to knitted underwears.

*Specification:-* for toe-looping, looping points: 12, 14, 16, 18, 20, 22, 24, 26, 28, 30.

*Power Required:-* 1 HP for 12 machines

*Machine Speed:-* driving pulley 250-300 RPM

*Nett Weight:-* 80 kgs. approx

*Floor Space:-* Space occupied - 2' x 3'  
Working space required - 3' x 6'

*Attendance:-* 1 to 3 operators for each machine

*Production:-* for toe-looping, 1 worker can loop 40 doz. pairs heavy hosiery or 20 doz. pairs light hosiery; for sleeve looping 15 doz. underwears, production being based on 10 working hours.

*Advantages:-* Occupies little space, low power consumption, little labour required, high production capacity.  
Number of needles can be altered to suit fine or coarse knitted fabrics.  
Guaranteed free from yarn breakage or other defects with production of high quality.  
Can be arranged for treadle drive in case electric power is not available.

*N.B.—For improvement of the machine, we reserve the right to alter either the design or the specification.*

CODE: RT - 2008

# 高筒提花織襪機

AUTOMATIC FANCY HOSIERY KNITTING MACHINE  
WITH HIGH NEEDLE CYLINDER

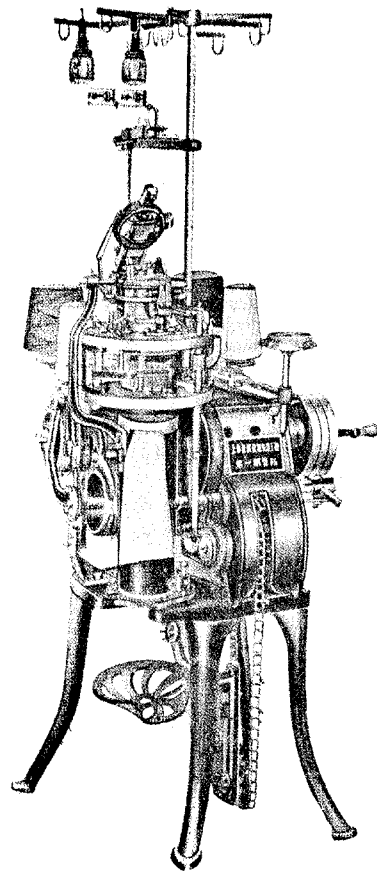

中國運輸機械進口公司經售

Exported by CHINA NATIONAL TRANSPORT MACHINERY IMPORT CORPORATION

香港代理處：華潤公司

Hong Kong Agency: CHINA RESOURCES CO.

BANK OF CHINA BUILDING

HONG KONG

CABLE ADDRESS: "CIRECO."



This machine is adapted for knitting all kinds of new fancy socks. There are five yarn-fingers for inter-knitting yarns of 5 colours. The latch ring opens automatically subsequent to the completion of sock.

*Specification:-* Available in cylinder diameter of 3-1/2" with 160, 176, 188 and 200 needles.

*Power Required:-* 1 HP for each machine

*Cylinder Speed:-* 200-220 RPM

*Weight:-* Nett 170 kgs. for each machine

*Floor Space:-* Space occupied - 1'-6" x 2'-6"  
Working space required 2'-6" x 5'-0"

*Attendance:-* One operator can handle 2-3 machines

*Production:-* Based on every 10 working hours about 6 doz. pairs of socks

*Advantages:-* Low power consumption, high production capacity

Suitable for knitting socks of mercerized cotton yarn or artificial silk.

Welt can be knitted with any desired elasticity sole size and heel height can be adjusted by the chain.

A wide range of patterns possible by simply adjusting the pattern wheel and jacks.

*N.B.—For improvement of the machine, we reserve the right to alter either the design or the specification.*

CODE: RT-2009

開式電力織襪機  
AUTOMATIC HOSIERY KNITTING MACHINE  
MODEL K

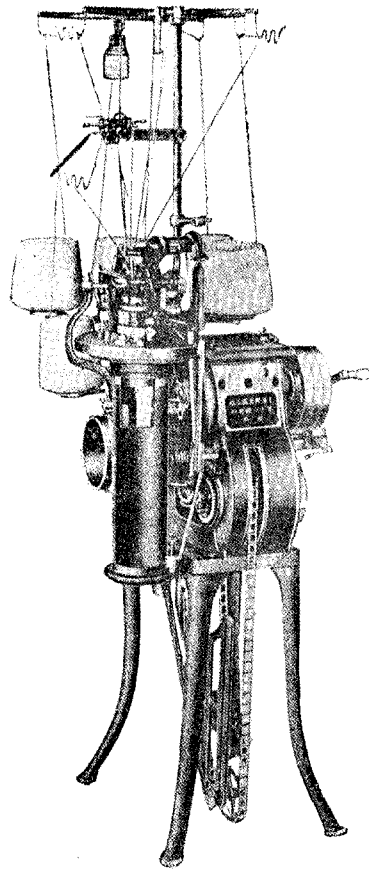

中國運輸機械進口公司經售

Exported by CHINA NATIONAL TRANSPORT MACHINERY IMPORT CORPORATION

香港代理處：華潤公司

Hong Kong Agency: CHINA RESOURCES CO.

BANK OF CHINA BUILDING  
HONG KONG

CABLE ADDRESS: "CIRECO."

This machine is specially manufactured for knitting fashionable seamless stockings. The welt transfer and hosiery fashion are knitted automatically.

*Specification:-* The machine is available in different cylinder diameters and number of needles as follows:-

3" Diam. 96, 120, 140 needles for 6s and 20s counts yarn.

3 $\frac{1}{4}$ " Diam. 160, 176, 188, 200 needles for 32s/2 and 42s/2 counts yarn.

3 $\frac{1}{2}$ " Diam. 220, 240, 260, 280 needles for 60s/2 and 84s/2 counts thread.

*Power Required:-*  $\frac{1}{2}$  HP for single machine, 5 HP for 12 machines in case of group drive.

*Cylinder Speed:-* 240-260 RPM

*Weight:-* Nett 160 kgs., gross 180 kgs.

*Floor Space:-* Space occupied: 1' 6" x 2' 6"  
Working space required: 2' 6" x 5' 0"

*Attendance:-* One operator can handle 6-12 machines.

*Production:-* Based on 10 working hours:  
3" Cylinder diam. machine: 5-8 doz. pairs of socks.  
3 $\frac{1}{4}$ " " " " : 4-5 doz. pairs of socks.  
3 $\frac{1}{2}$ " " " " : 2-4 doz. pairs of socks.

*Advantages:-* Automatically knits welt, simple operation, low power consumption, high production capacity, smooth and first class products possible.

Handles mercerized cotton yarn, cotton threads etc.

Welt can be knitted with any desired elasticity, sole size and heel height can be adjusted by the chain.

Stop motion in case of needle breakage by signal bell.

*N.B.—For improvement of the machine, we reserve the right to alter either the design or the specification.*

CODE: RT - 2010

皮式電力織襪機

AUTOMATIC HOSIERY KNITTING MACHINE  
MODEL B

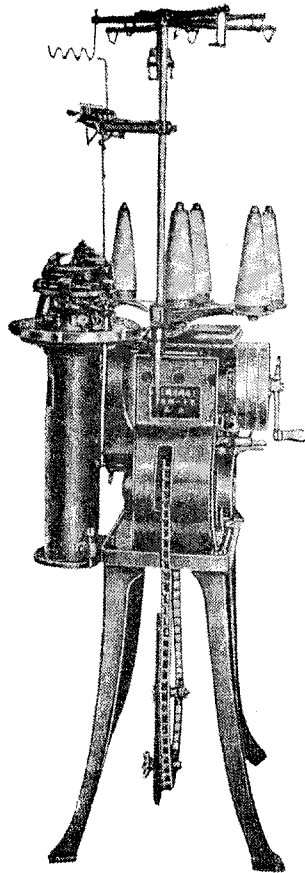

中國運輸機械進口公司經售

Exported by CHINA NATIONAL TRANSPORT MACHINERY IMPORT CORPORATION

香港代理處：華潤公司

Hong Kong Agency: CHINA RESOURCES CO.

BANK OF CHINA BUILDING  
HONG KONG

CABLE ADDRESS: "CIRECO."

This machine is specially manufactured for knitting socks after the rib top is completed. It is to be fixed on the cylinder provided with equal number of needles to complete knitting of the rib top sock.

*Specification:-* Available in different cylinder diameters with number of needles as follows:-

3" Cylinder diam. 96, 120, 140 needles for 6s and 20s counts yarn.

3 $\frac{1}{4}$ " Cylinder diam. 160, 176, 188, 200 needles for 32s/2 and 42s/2 counts thread.

3 $\frac{1}{2}$ " Cylinder diam. 200, 220, 260, 280 needles for 60s/2 and 84s/2 counts thread.

*Power Required:-*  $\frac{1}{2}$  HP for single machine, 5 HP for 12 machines in case of group drive.

*Cylinder Speed:-* 260-285 RPM.

*Weight:-* Nett 150 kgs., gross 170 kgs.

*Floor Space:-* Space occupied ... .. 1'-6" x 2'-6"  
Working space required ... .. 2'-6" x 5'-0"

*Attendance:-* One operator can handle 2-3 machines

*Production:-* Based on 10 working hours.

3" Cylinder diameter machine: 7-9 doz. pairs

3 $\frac{1}{4}$ " " " " : 7-8 " "

3 $\frac{1}{2}$ " " " " : 5-6 $\frac{1}{2}$ " "

*Advantages:-* Low power consumption, high production capacity.

Handles mercerized cotton yarn, cotton threads. etc.

Welt can be knitted with any desired elasticity, sole size and heel height can be adjusted by the chain.

Stop motion in case of needle breakage by signal bell.

*N.B.—For improvement of the machine, we reserve the right to alter either the design or the specification.*

CODE: RT - 5001

四開鉛印機 (又名六度印刷機)

CYLINDER JOB PRESS,  
WITH FLYER DELIVERY  
MODE CJQ

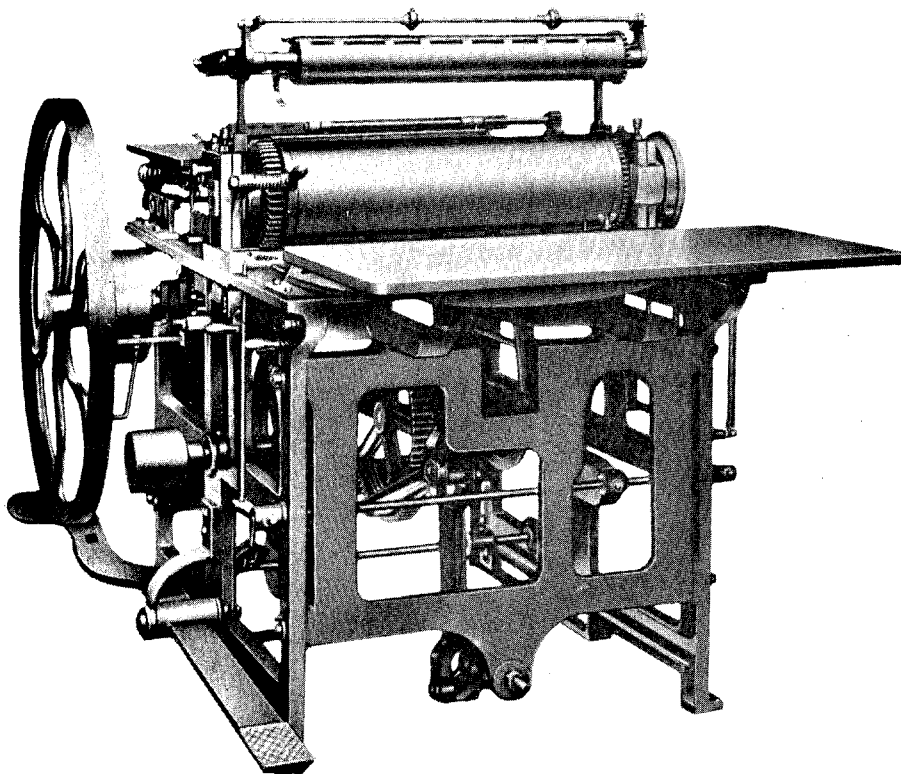

中國運輸機械進口公司經售

Exported by CHINA NATIONAL TRANSPORT MACHINERY IMPORT CORPORATION

香港代理處：華潤公司

Hong Kong Agency: CHINA RESOURCES CO.

BANK OF CHINA BUILDING  
HONG KONG  
CABLE ADDRESS: "CIRECO."

Model CJQ is a stop-cylinder letter-press for ordinary job work. Constructional features include: carriage drive by rod motion with 2 roller tracks; cylinder inking unit with 3 inking rollers; ink box with duct blade. Delivery cylinder is of the clear off type and the rotation of the impression cylinder is stopped by a handle.

Paper is fed by hand and delivered to the pile board by flyer system. The press is arranged for motor drive but at the same time it can be driven by foot treadle.

Models:	CJQ
Sheet Size:	457 x 610 mm (18" x 24")
Type Bed:	483 x 635 mm (19" x 25")
Chase, inside measurement:	445 x 597 mm (17½" x 23½")
Type Matter Locked in Chase:	457 x 610 mm (18" x 24")
Impressions per Hour:	1500
Flywheel Revolutions per Impression:	
Installation Floor Space:	1800 x 1250 (72" x 50")
Pulley Diameter x Width:	300 x 50 mm (12" x 2")
Weight:	Net: 1100 kgs. approx. Gross: 1500 kgs. approx.
Shipping Space:	3 cubic meters approx

*N.B.—For improvement of the machine, we reserve the right to alter either the design or the specification.*

CODE: RT - 5002

對開切紙機  
PAPER CUTTING MACHINE,  
MODEL PC - 36

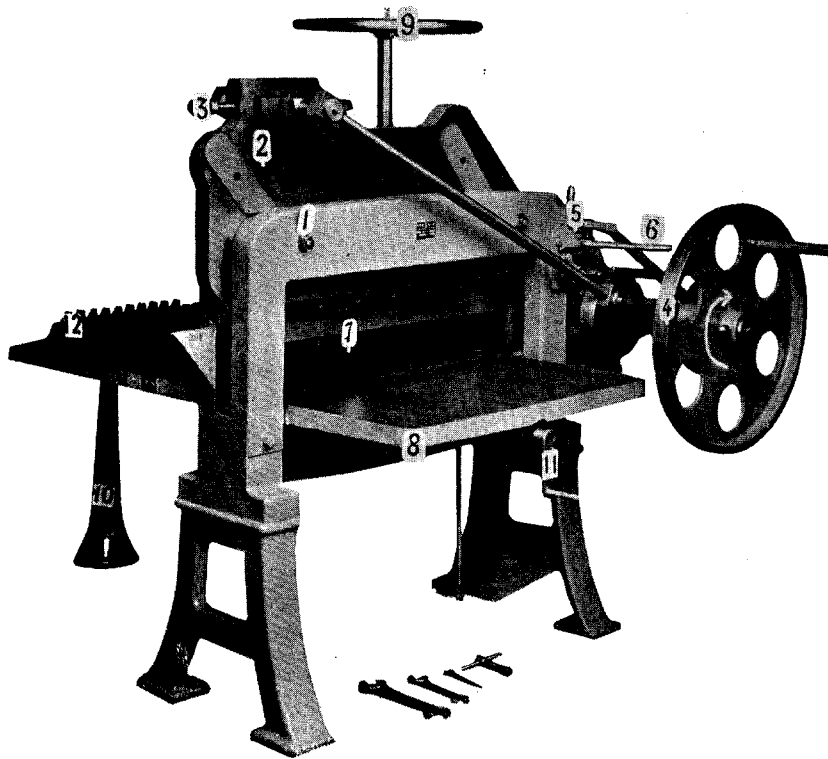

中國運輸機械進口公司經售

Exported by CHINA NATIONAL TRANSPORT MACHINERY IMPORT CORPORATION

香港代理處：華潤公司

Hong Kong Agency: CHINA RESOURCES CO.

BANK OF CHINA BUILDING  
HONG KONG

CABLE ADDRESS: "CIRECO."



This machine is so arranged that it can be driven either by hand or by power. It is of sturdy construction and has a high production capacity. The knife is automatically disengaged at its highest position. The knife holder is provided with double side connecting rods for diagonal cutting. The height of the table can be adjusted to avoid under or over cutting. The back gauge is adjusted by means of spindle and crank. The pressing beam is operated by a hand wheel. For power drive, an electric motor of  $1\frac{1}{2}$  H. P. is required. Starting and stopping of the machine are effected by a coupling clutch operated by a hand lever. This model is constructed for small enterprise, but can be utilized as a good auxiliary machine in large printing establishments.

Model:	PC-36
Length of Cut:	915 mm (36")
Height of Stack:	130 mm ( $5 - \frac{1}{4}$ " )
Table Surface:	1070 x 915 mm ( $42\frac{1}{2}$ " x $36\frac{1}{2}$ " )
Installation Floor Space:	2060 x 2400 mm (82" x 96")
Weight:	Net: 1100 kg. approx. Gross: 1400 kg. approx.
Shipping Space:	2.5 cu. m. approx.

*N.B.—For improvement of the machine, we reserve the right to alter either the design or the specification.*

全張磨鋅皮機  
ZINC PLATE GRAINING MACHINE, MODEL GM

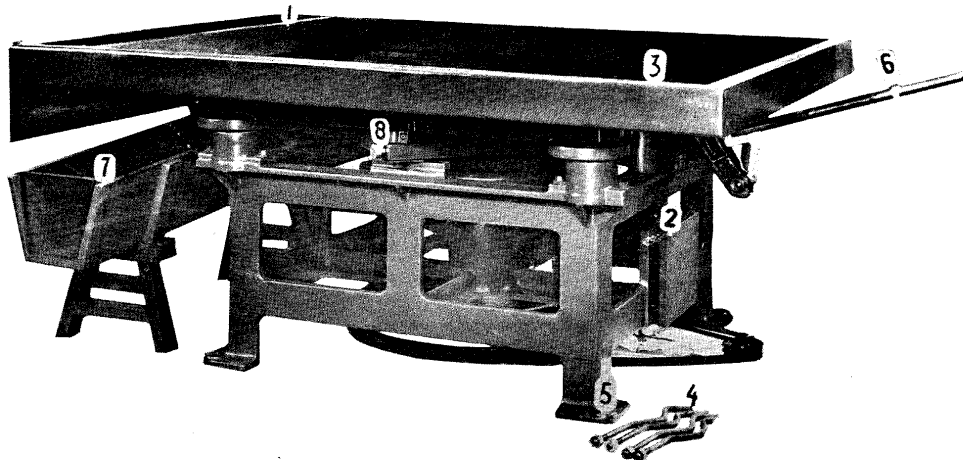

中國運輸機械進口公司經售  
Exported by CHINA NATIONAL TRANSPORT MACHINERY IMPORT CORPORATION  
香港代理處：華潤公司  
Hong Kong Agency: CHINA RESOURCES CO.  
BANK OF CHINA BUILDING  
HONG KONG  
CABLE ADDRESS: "CIRECO."

THIS MACHINE is for cleaning and graining zinc plates for offset works.  
Glass, ceramic or steel marbles with sand are used, which may be supplied, if required.  
It is directly driven by motor through vee belting.

Model:	GM
Inside Measurement of Box:	1730 x 1270 mm (68" x 50")
Speed:	120 rpm
Installation Floor Space	2000 x 1450 mm (80" x 58")
Motor:	1½ H. P.
Net Weight:	1150 kgs. approx.
Gross Weight:	1400 kgs. approx.
Shipping Space:	3.6 cu. m. approx.

*N.B.--For improvement of the machine, we reserve the right to alter either the design or the specification.*

CODE: RT - 5004

# 全張自動切紙機

AUTOMATIC PAPER CUTTING MACHINE,  
MODEL PC - 50

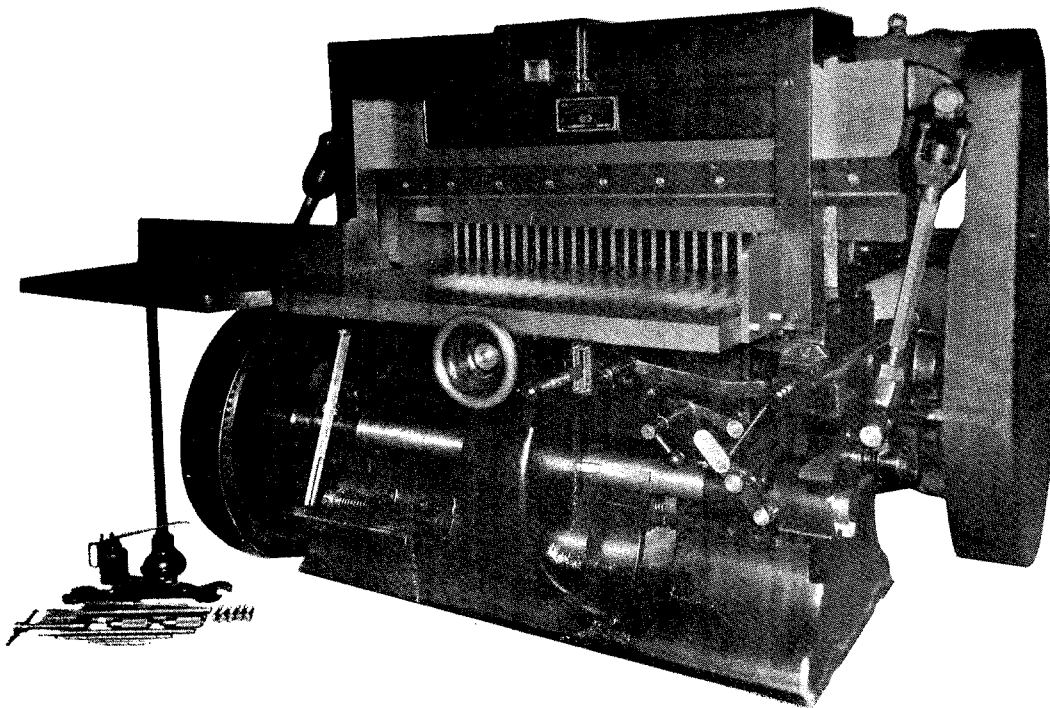

中國運輸機械進口公司經售

Exported by CHINA NATIONAL TRANSPORT MACHINERY IMPORT CORPORATION

香港代理處：華潤公司

Hong Kong Agency: CHINA RESOURCES CO.

BANK OF CHINA BUILDING

HONG KONG

CABLE ADDRESS: "CIRECO."

This machine is especially suitable for large factories desirous of having a modern machine of high output. Clamping of the material, cutting and raising of the knife take place automatically. The automatic clamping device acts immediately after the machine has been started; it transmits pressure upon the full depth of the pile. Mechanical forward and backward movement of the back gauge are controlled by a lever. The exact distance between the knife and the back gauge is indicated by a cutting space indicator which, in conjunction with the side gauge on the front table, facilitates feeding and ensures perfect square cut. The main shaft is equipped with a multi-disc clutch, by means of which the cutting pressure can be regulated. The machine is driven by an electric motor, all driving belts being effectively guarded.

Model:	PC - 50
Length of Cut:	1270 mm (50")
Height of Cut:	130 mm (5-1/8")
Time per Cut:	4 seconds
Installation Floor Space:	2450 x 2600 mm (98" x 104")
Motor:	5 H. P.
Weight:	Net: 3600 kgs. approx. Gross: 4300 kgs. approx.
Shipping Space:	11 cu. m. approx.

*N.B.—For improvement of the machine, we reserve the right to alter either the design or the specification.*

CODE: RT - 5005

# 三面切紙機

THREE KNIFE BOOK TRIMMING MACHINE, MODEL BT

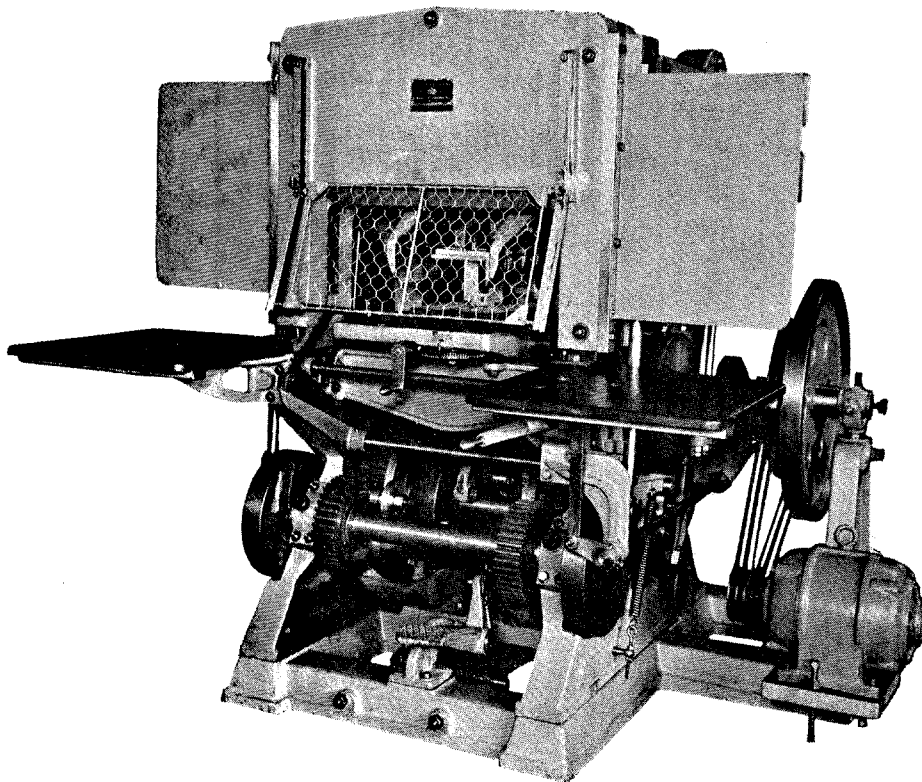

中國運輸機械進口公司經售

Exported by CHINA NATIONAL TRANSPORT MACHINERY IMPORT CORPORATION

香港代理處：華潤公司

Hong Kong Agency: CHINA RESOURCES CO.

BANK OF CHINA BUILDING  
HONG KONG  
CABLE ADDRESS: "CIRECO."

This machine is very popular to book-binding factories. It simultaneously trims stacks of paper, books, etc. on three sides. The automatic clamping device acts before the cutting operation; it transmits pressure on the entire top surface of the pile. The adjustment of the side-knives and of the back gauge, which becomes necessary for trimming a pile of another size, can be made in the most simple manner. Form plates of different sizes can be supplied at buyers' option.

The cutting zone is protected with guard screen so that the machine is accident proof.

Model:	BT
Number of Cutting Knives:	3
Time of each Cutting:	10 seconds
Minimum Size to be Cut:	51 x 78 mm (2" x 3-1/8")
Maximum Size to be Cut:	254 x 406 mm (10" x 16")
Height of Stack:	57-132 mm (2 1/4" - 5 1/4")
Installation Floor Space:	2200 x 2100 mm (88" x 84")
Motor:	3 H. P.
Weight:	Not: 3600 kg. approx. Gross: 3800 kg. approx.
Shipping Space:	9.2 cu. m.

*N.B.—For improvement of the machine, we reserve the right to alter either the design or the specification.*

CODE: RT - 5006

電 動 訂 書 機

WIRE STITCHING MACHINE, MODEL WSP

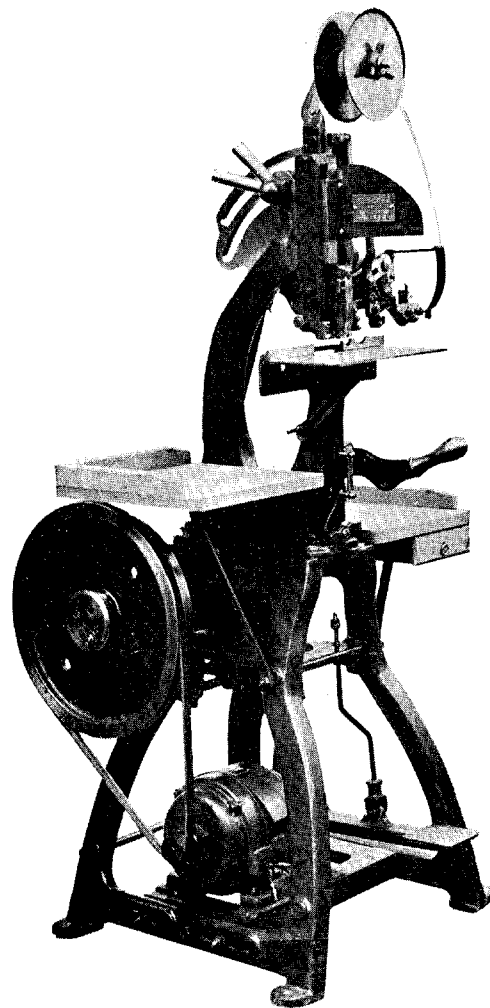

中國運輸機械進口公司經售

Exported by CHINA NATIONAL TRANSPORT MACHINERY IMPORT CORPORATION

香港代理處：華潤公司

Hong Kong Agency: CHINA RESOURCES CO.

BANK OF CHINA BUILDING  
HONG KONG  
CABLE ADDRESS: "CIRECO."



This machine is specially made for book binding work. It is driven either by electric motor or by treadle. For book binding, round shaped wire is used, the staple is struck from underneath and is bent forward.

Model:	WSP
Thickness:	15 mm (5/8")
Staple Length:	12.7 mm (1/2")
Maximum Capacity:	120 staples per minute
Installation Floor Space:	686 x 711 mm (27" x 28")
Motor:	1 H. P.
Weight:	Net: 160 kg. approx. Gross: 230 kg. approx.
Shipping Space:	1 cu. m. approx.

*N.B.—For improvement of the machine, we reserve the right to alter either the design or the specification.*

CODE: RT - 5007

拖 紙 機  
LIFTING TRUCK MODEL LT

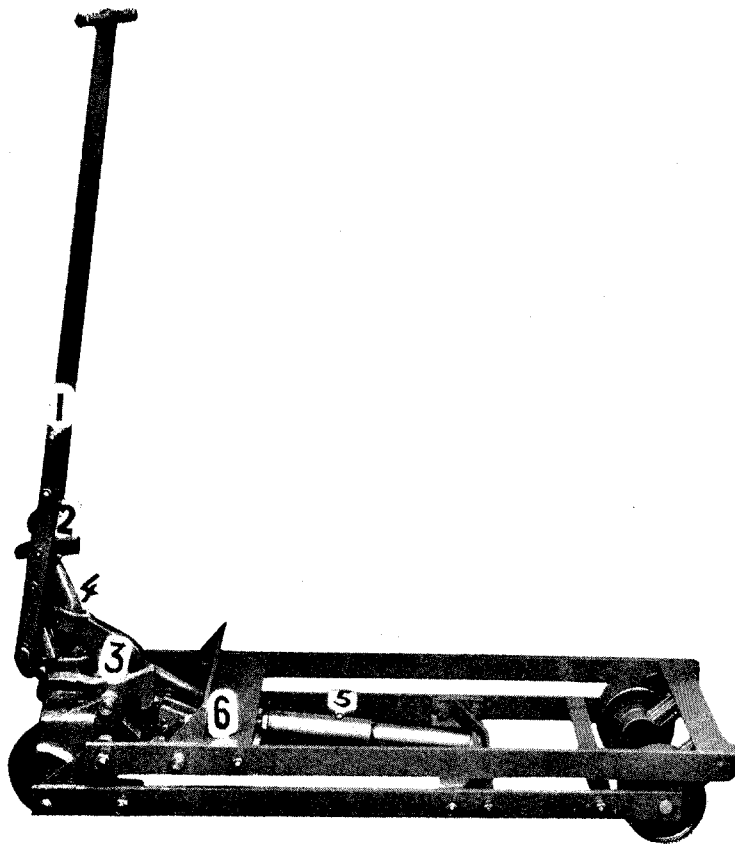

中國運輸機械進口公司經售

Exported by CHINA NATIONAL TRANSPORT MACHINERY IMPORT CORPORATION

香港代理處：華潤公司

Hong Kong Agency: CHINA RESOURCES CO.

BANK OF CHINA BUILDING  
HONG KONG  
CABLE ADDRESS: "CIRECO."

One of the important operations in any printing establishments is to handle materials efficiently. This hand lifting truck facilitates material handling, thereby reducing production cost.

Model:	LT
Maximum Load:	750 kg.
Lifting Height:	660 mm (26")
Size:	960 x 470 x 160 mm (38" x 18½" x 6½")
Weight:	Net: 118 kg. approx. Gross: 140 kg. approx.
Shipping Space:	0.256 cu. m. approx.

*N.B.—For improvement of the machine, we reserve the right to alter either the design or the specification.*

CODE: R T- 5008

500 噸 液 力 壓 紙 版 機

HYDRAULIC MATRIX MOULDING PRESS  
500 TONS CAPACITY

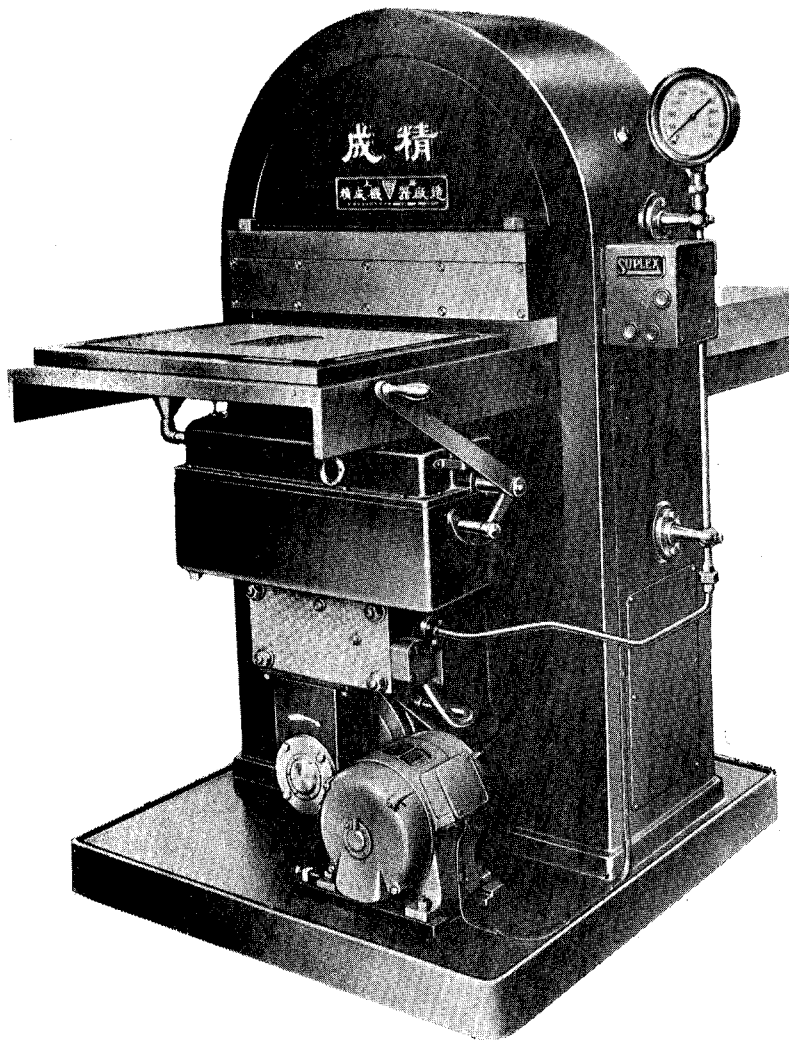

中國運輸機械進口公司經售

Exported by CHINA NATIONAL TRANSPORT MACHINERY IMPORT CORPORATION

香港代理處：華潤公司

Hong Kong Agency: CHINA RESOURCES CO.

BANK OF CHINA BUILDING  
HONG KONG  
CABLE ADDRESS: "CIRECO."

Speed of Matrix Moulding:	20 sec. per matrix
Maximum Pressure:	500 tons
Effective Pressure for Moulding Newspaper Matrix:	260 - 320 tons
Maximum Size of Matrix:	540 x 700 mm
Maximum Width of Working Table:	720 mm.
Power Required:	1½ H. P.
Overall Dimension:	Length 1.64 x width 1 x height 1.6 meter
Net Weight:	3.800 kg. approx.
Gross Weight:	4.050 kg. approx.
Shipping Space:	2.66 cu. meter approx.

*N.B.—For improvement of the machine, we reserve the  
right to alter either the design or the specification.*

CODE: RT - 5009

全張雙迴轉印刷機  
TWO REVOLUTION MACHINE  
MODEL 51 (FULL SIZE)

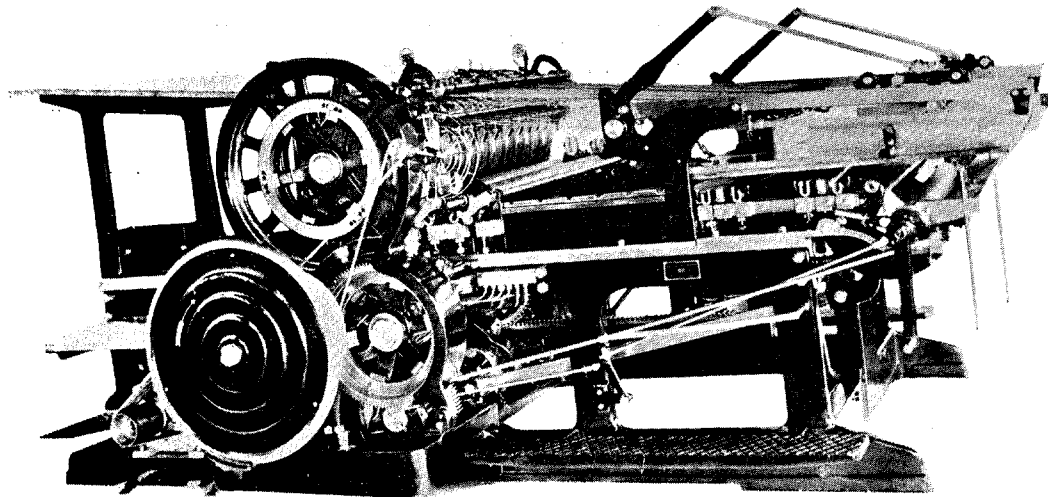

中國運輸機械進口公司經售

Exported by CHINA NATIONAL TRANSPORT MACHINERY IMPORT CORPORATION

香港代理處：華潤公司

Hong Kong Agency: CHINA RESOURCES CO.

BANK OF CHINA BUILDING

HONG KONG

CABLE ADDRESS: "CIRECO."

1. Specifications:-

Press Table Dimension	... ..	1274 x 981 mm
Size of Roller (diameter x length)	... ..	∅ 533.4 x 1168 mm
Roller Rail (Height)	... ..	23.44 mm
Size of Ink Duct (Width x length)	... ..	1150 x 905 mm
Maximum Size of Sheet	... ..	1100 x 800 mm

2. Mechanical Features:-

Type	... ..	Single Printing Roller with increasing pressure
Impressing Pressure	... ..	5 Kg/cm <sup>2</sup>
Speed of Printing Roller	... ..	36 - 62 rpm.
Impressions per minute	... ..	18 - 31
Track of Distribution Rollers	... ..	(1) 40 mm (2) 38 mm

Power: A. C. motor, 3 phase, 50 cycle, 220/380 volts, 5.5 KW, 1450 rpm.

Dimensions: 4200 x 2700 x 1700 mm

Weight: approx. 9800 kg.

*N.B.—For improvement of the machine, we reserve the right to alter either the design or the specification.*

CODE: RT-5010

鑄 字 機

TYPE CASTING MACHINE,  
MODEL TCL

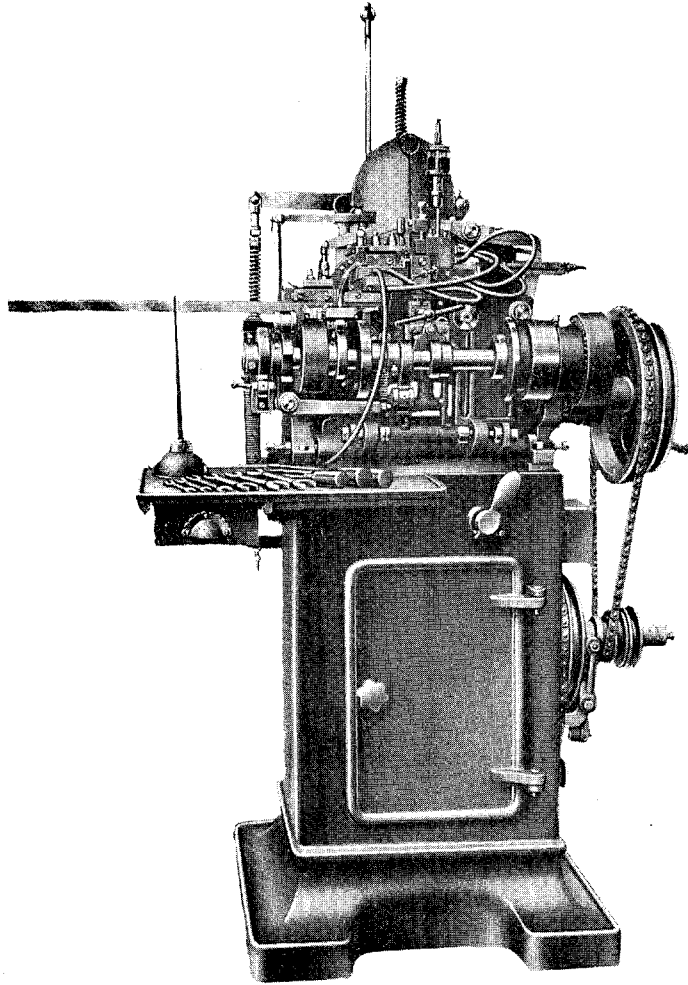

中國運輸機械進口公司經售

Exported by CHINA NATIONAL TRANSPORT MACHINERY IMPORT CORPORATION

香港代理處：華潤公司

Hong Kong Agency: CHINA RESOURCES CO.

BANK OF CHINA BUILDING  
HONG KONG  
CABLE ADDRESS: "CIRECO."



This machine is developed for high speed casting of sharp and clean types. The essential parts are made of high grade carbon steel, those which are subject to wear as well as the shafts are hardened and heat treated. The most important part of this machine, the matrix case, is made of special chromium alloy steel and precision ground ensuring production of sharp metal types. It is arranged for heating by electric current, consuming about 3 KW. The machine is equipped with a  $\frac{1}{2}$  H. P. electric motor and a type casting case, the size of which is at buyer's option.

Model:	TCL
Casting Range:	6 points to 28 points
Production per Minute:	For 6 points, 130-150 castings
Installation Floor Space:	850 x 650 mm (34" x 26")
Weight:	Net: 420 kg. approx. Gross: 485 kg. approx.
Shipping Space:	1.1 cu. m. approx.

*N.B.—For improvement of the machine, we reserve the right to alter either the design or the specification.*

CODE: RT - 5011

鑄 字 盒

TYPE - CASTING CASE,  
MODEL TCC

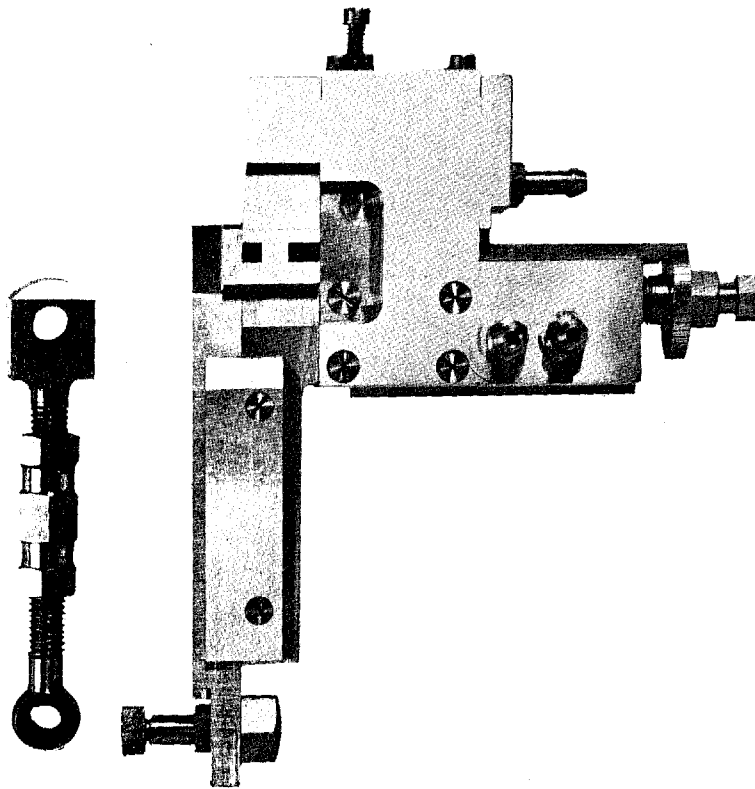

中國運輸機械進口公司經售

*Exported by* CHINA NATIONAL TRANSPORT MACHINERY IMPORT CORPORATION

香港代理處：華潤公司

*Hong Kong Agency:* CHINA RESOURCES CO.

BANK OF CHINA BUILDING  
HONG KONG

CABLE ADDRESS: "CIRECO."

These Casting Cases are made of special chromium alloy steel, precision ground and heat treated ensuring production of clear and sharp metal types. They are available in three models:

TCC-A: Fixed model used for casting assigned sizes of types.

TCC-B: Adjustable model used for casting various sizes of types of uniform height.

TCC-C: Universal quotation casting box for casting hollow types from No. 2 to No. 6.

Each type-casting case is provided with 3 sets of steel moulds, specification of which is at buyer's option.

Dimension: 230 × 180 × 90 mm (9" × 7" × 3½")

Weight: 4 kgs. approx.

*N.B.—For improvement of the machine, we reserve the right to alter either the design or the specification.*

Sanitized Copy Approved for Release 2010/02/02 : CIA-RDP80T00246A032700710001-0

CODE: RT-5012

熔鉛爐連泵浦  
MELTING OVEN WITH PUMP, MODEL RN-14

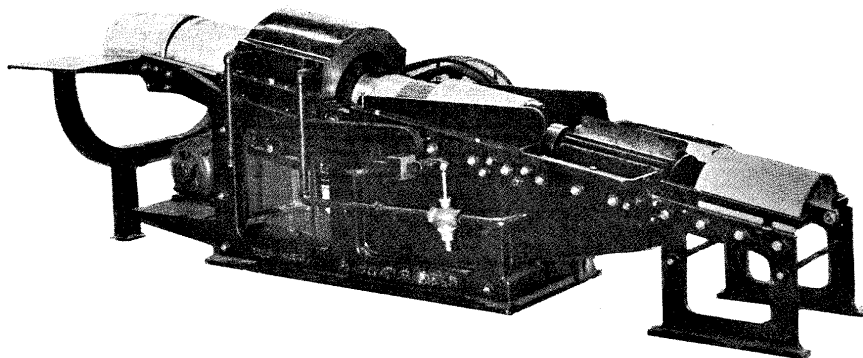

中國運輸機械進口公司經售  
*Exported by* CHINA NATIONAL TRANSPORT MACHINERY IMPORT CORPORATION

香港代理處：華潤公司

*Hong Kong Agency:* CHINA RESOURCES CO.

BANK OF CHINA BUILDING  
HONG KONG  
CABLE ADDRESS: "CIRECO."

This oven is characterised by its simplicity and efficiency. It can be installed at any place to cast stereo-plates for Model RP 1-64 and RP 4-64 large size Rotary Presses. Metal is pumped through a charge pipe and forced into the casting box by pushing its hand-lever. A single stroke of the lever will deliver a quantity of metal sufficient to form one plate.

Specifications:

Capacity of Pot:	2,600 kg. of lead alloy
Displacement of Pump:	8,600 cm <sup>3</sup>
Surface of Oven Grate:	3,726 cm <sup>2</sup>
Fuel Used:	Bituminous Coal
Net Weight:	2,500 kg. approx.
Gross weight:	2,800 kg. approx.
Shipping Space:	5.5 cu. meter approx.

Attached Equipments:

1 pc.	Thermo-couple Pyrometer
1 set	Chimney 7 m x 200 mm $\phi$

*N.B.—For improvement of the machine, we reserve the right to alter either the design or the specification.*

CODE: RT - 5013

方箱印刷機

PLATEN PRESS, MODEL PP-14

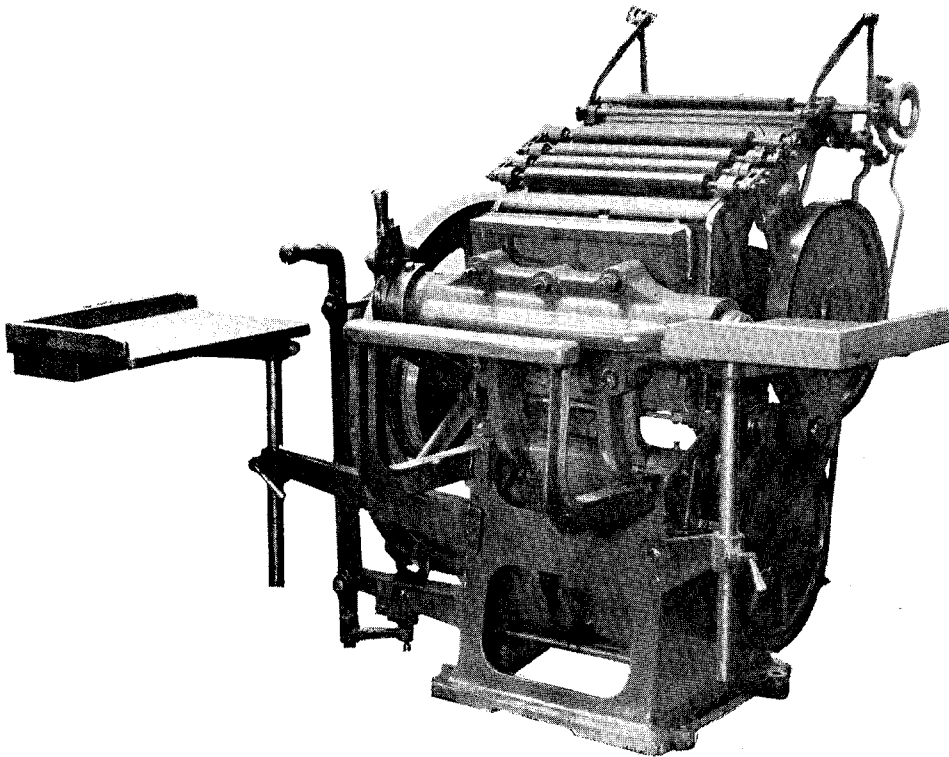

中國運輸機械進口公司經售

Exported by CHINA NATIONAL TRANSPORT MACHINERY IMPORT CORPORATION

香港代理處：華潤公司

Hong Kong Agency: CHINA RESOURCES CO.

BANK OF CHINA BUILDING

HONG KONG

CABLE ADDRESS: "CIRECO."

This is a fine art platen press suitable for general job printing and also for half-tone and zinc block works. It is built with sturdy bed and frame, a single disc and self-inking apparatus, friction clutch and brake. It is capable of a wide range of printing, requiring minimum power and space.

Model:	PP - 14
Chase, inside measurement:	330 x 432 mm (13" x 17")
Size of Platen:	355 x 508 mm (14" x 20")
Impressions per Hour:	1260
Installation Floor Space:	1270 x 1880 mm (50½" x 74")
Motor:	1 H. P.
Weight:	Net: 1,200 kg. approx. Gross: 1,500 kg. approx.
Shipping Space:	3 cu. m. approx.

*N.B.—For improvement of the machine, we reserve the right to alter either the design or the specification.*

CODE: RT - 5014

元 盤 印 刷 機  
PLATEN PRESS, MODEL PP - 10  
FOR TREADLE DRIVE.

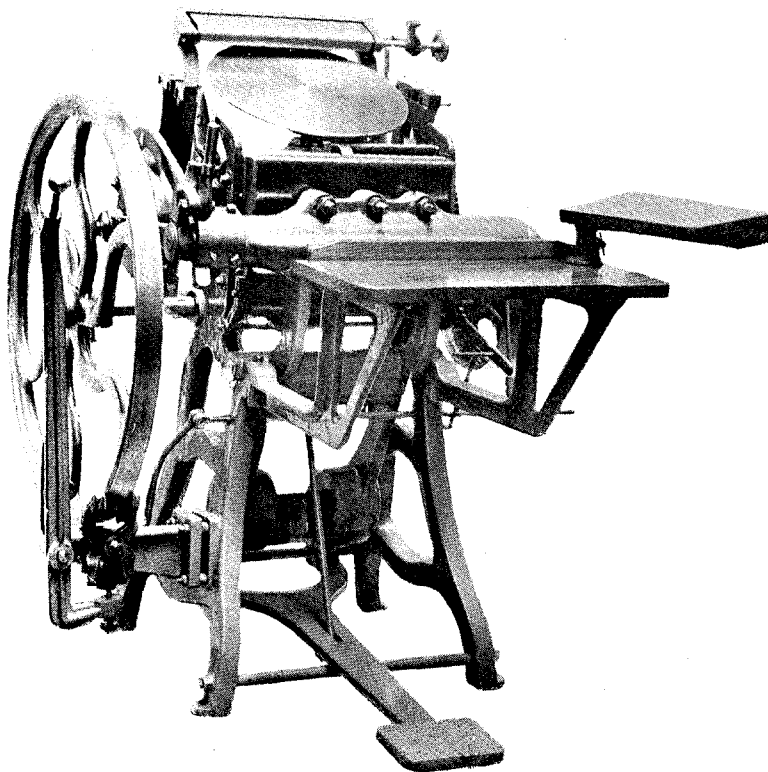

中國運輸機械進口公司經售

Exported by CHINA NATIONAL TRANSPORT MACHINERY IMPORT CORPORATION

香港代理處：華潤公司

Hong Kong Agency: CHINA RESOURCES CO.

BANK OF CHINA BUILDING  
HONG KONG  
CABLE ADDRESS: "CIRECO."



This model has a strongly built vertical bed, a single disc and self-inking apparatus for Perfect inking distribution. It is equipped with a device for regulating and throwing off impressions in any position of the platen.

Model:	PP-10
Chase, inside measurement:	254 x 381 mm (10" x 15")
Size of Platen:	279 x 406 mm (11" x 16")
Impressions per Hour:	1200 to 1800
Installation Floor Space:	1422 x 1219 mm (56" x 48")
Weight:	Net: 530 kg. approx. Gross: 650 kg. approx.
Shipping Space:	1.7 cu. m. approx.

*N.B.—For improvement of the machine, we reserve the right to alter either the design or the specification.*

Sanitized Copy Approved for Release 2010/02/02 : CIA-RDP80T00246A032700710001-0

CODE: RT-5015

單捲筒十六版輪轉印報機

UNI-REEL 16-PAGE NEWSPAPER ROTARY PRESS  
MODEL RP 1-64

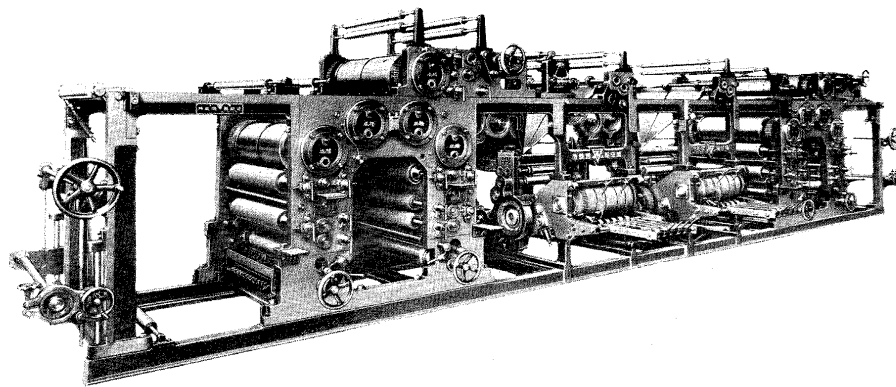

中國運輸機械進口公司經售

Exported by CHINA NATIONAL TRANSPORT MACHINERY IMPORT CORPORATION

香港代理處：華潤公司

Hong Kong Agency: CHINA RESOURCES CO.

BANK OF CHINA BUILDING  
HONG KONG

CABLE ADDRESS: "CIRECO."

This rotary press is capable of printing newspaper with a daily circulation from 50,000 to 100,000 copies. The construction has been carefully designed with due consideration of the large dimension of the cylinder of 4-plate width. It is both easy to install and to dismantle. Every part is so designed as to simplify the operation.

This Rotary Press is composed of two printing units and a second colour unit which is fixed on the top. The oil ring lubricated bearings of the cylinder are completely enclosed and fitted with an eccentric mechanism for adjusting the center of the shaft to ensure printing accuracy and correct pressure. Its main drive comprises of a 35 h. p. A. C. commutator motor with push button control for speed regulation. To stop the rotary press, an electromagnetic brake is provided.

This Rotary Press is equipped with a tapeless double folder and one of 45° turning bars.

This press handles paper reels of 64" width, but those of 63" are also adaptable

For feeding the paper there is a 5 H. P. motor but a hand feeding lever is also provided.

#### Technical Data:

Maximum Printing Surface	...	...	...	...	...	...	...	...	14 $\frac{3}{4}$ " x 21"
Size of 4-page paper (with 64" width reel)	...	...	...	...	...	...	...	...	22" x 32"
Printing Diameter	...	...	...	...	...	...	...	...	14"
Number of Plates	...	...	...	...	...	...	...	...	16 pcs.
Number of Plates for Second Colour	...	...	...	...	...	...	...	...	8 pcs.
Thickness of Plates	...	...	...	...	...	...	...	...	14 mm.
Thickness of Blanket	...	...	...	...	...	...	...	...	5 mm.
Standard Speed	...	...	...	...	...	...	...	...	12,500 cyl r/h
Maximum Speed	...	...	...	...	...	...	...	...	13,000 cyl r/h

#### Output:

<u>No. of Sheets per copy</u>	<u>No. of Pages</u>	<u>Copies/Hour</u>	<u>No. of Pages with Colour</u>	<u>Width of Reel</u>
$\frac{1}{2}$	2	100,000	1	64"
1	4	50,000	2	64"
$1\frac{1}{2}$	6	25,000	3	48"
2	8	25,000	4	64"
$1\frac{1}{2}$ double	12	12,500	6	48"
4	16	12,500	8	64"
Power Required	...	...	...	35 H. P.
Overall Dimension	...	...	...	length 5.3 m. width 4.5 m. height 2.65 m.
Net Weight (including electrical equipment)	...	...	...	29,500 kg. approx.
Gross Weight (including electrical equipment)	...	...	...	32,500 kg. approx.
Shipping Space	...	...	...	46.5 cu. m. approx.

#### Standard Equipment:

- 1-Stereo-plate Casting Machine Model RD-14
- 1-Automatic Boring Machine (Autoshaver) Model RF-14
- 1-Melting Oven with Pump Model RN-14
- 1-Hydraulic Matrix Moulding Pump 500 Tons Capacity, Model PH-2

*N.B.—For improvement of the machine, we reserve the right to alter either the design or the specification.*

CODE: RT - 5016

單捲筒八版輪轉印報機

UNI-REEL 8 - PAGE NEWSPAER ROTARY PRESS  
MODEL PR 1-32

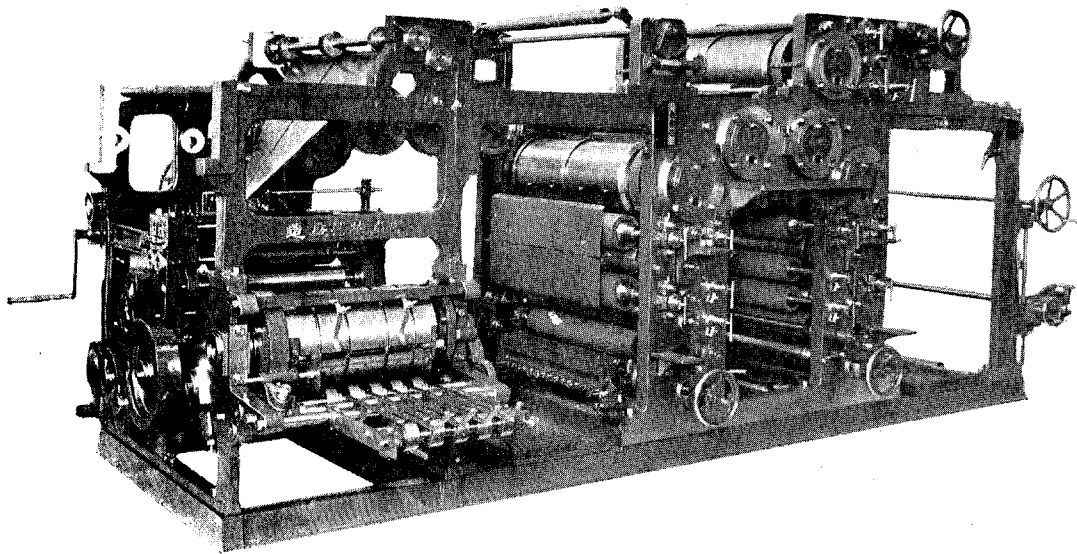

中國運輸機械進口公司經售

Reported by CHINA NATIONAL TRANSPORT MACHINERY IMPORT CORPORATION

香港代理處：華潤公司

Hong Kong Agency: CHINA RESOURCES CO.

BANK OF CHINA BUILDING  
HONG KONG  
CABLE ADDRESS: "CIRECO."

This Rotary Press is designed for printing 10,000 to 50,000 copies of newspapers daily. It is also adaptable to book and job printings. Rigidity in construction and simplicity in operation are its essential features. Its main frame is of the arch type which provides ample working space, and its parts are arranged within convenient reaches of the worker.

This press is composed of 2 printing units and a second colour unit which is fixed on the top. The oil ring lubricated bearings of the cylinder are completely enclosed. An eccentric mechanism is provided for adjusting the center of the shaft to ensure printing accuracy and correct pressure. The length of the cylinder is equal to the width of two plates.

The press is complete with one tapeless folder. Each complete issue of the newspaper will be automatically folded into two plaits by means of the folding triangles and cylinders and sent out of the rotary press in consecutive order through its tape delivery. A counter with recording marks for every 25 copies or 50 copies of newspapers delivered, is attached to the press for purpose of computation.

The press takes a single paper reel of 32" width, but reels from 31" up to 34" are also adaptable. Lifting device for paper reel is provided to save work and time. Another convenient feature is that two such presses can be connected together to convert into a two-reel 16 page press.

The electric drive consists of a variable speed A. C. commutator motor with remote control of speed by push buttons.

In case of emergency an electro-magnetic brake automatically stops the machine.

**Technical Data:**

Maximum Printing Surface ... ..	14 <sup>3</sup> / <sub>4</sub> " x 21"
Size of 4-page Copy (with 32" width reel) ... ..	22" x 32"
Standard Width of Paper Reel ... ..	32"
Printing Diameter ... ..	14"
Number of Plates ... ..	8 pcs.
Number of Plates for Second Colour ... ..	4 pcs.
Thickness of Plates ... ..	14 mm.
Thickness of Blanket ... ..	5 mm.
Standard Speed ... ..	12,500 cyl r/h

Output: Average as follows:

No. of Sheets per copy	No. of Page	Copies/Hour	No. of Pages with Colour	Width of Reel
$\frac{1}{2}$	2	50,000	1	32"
1	4	25,000	2	32"
2	8	12,500	4	32"

Power Required ... .. 20 H. P.  
 Overall Dimension... .. length 5 x width 3.5 x height 2 meters

Standard Equipment includes one each of:

- |                                 |                              |
|---------------------------------|------------------------------|
| 1-Matrix Moulding Press         | 1-Router with Electric Drive |
| 1-Oscillating Cup Casting Plant | 1-Shaver for Curved Stereocs |
| 1-Melting Pot.                  | 1-Trimming Apparatus         |

Total Weight (including stereotyping set and electric equipment): 12,650 kg. (approx.)  
 Gross Weight 12,250 kg. approx.  
 Shipping Space 22.65 cu. m. approx.

*N.B.—For improvement of the machine, we reserve the right to alter either the design or the specification.*

CODE: RT - 5017

三色凸版機

PLATEN PRESS MODEL PP-16

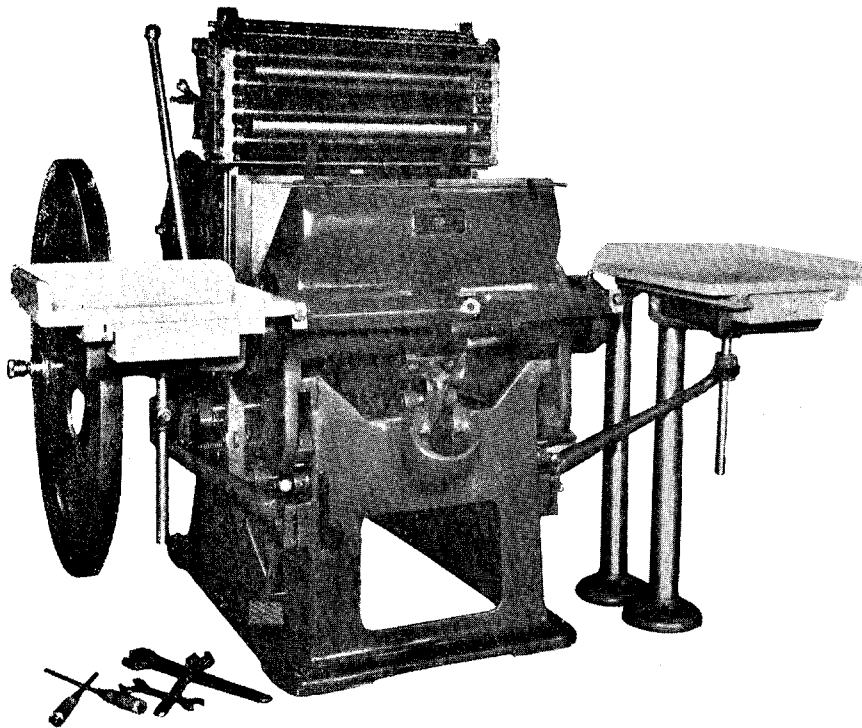

中國運輸機械進口公司經售

Exported by CHINA NATIONAL TRANSPORT MACHINERY IMPORT CORPORATION

香港代理處：華潤公司

Hong Kong Agency: CHINA RESOURCES CO.

BANK OF CHINA BUILDING

HONG KONG

CABLE ADDRESS: "CIRECO."

In introducing this platen press we provide a machine which produces finest tint work as well as ordinary job work at highest speed. Bed and frame are cast in one piece. The machine is furnished with two tension rods, cylindrical inking with four inking rollers, friction clutch and brake. Operation of this machine requires minimum power and space.

Model:	PP16
Chase, inside measurement:	394 x 560 mm (15½" x 22")
Size of Platen:	420 x 585 mm (16½" x 23")
Impressions per Hour:	1500
Installation Floor Space:	2032 x 1321 mm (80" x 52")
Pulley, diameter x width:	330 x 75 mm (13" x 3")
Motor:	2 H. P.
Weight:	Net: 1500 kg. approx. Gross: 2000 kg. approx.
Shipping Space:	3.8 cu. m. approx.

*N.B.—For improvement of the machine, we reserve the right to alter either the design or the specification.*

CODE: RT - 5018

對開膠版打樣機

SINGLE COLOUR OFFEST MACHINE

MODEL OHF WITH FLYER DELIVERY

MODEL OHC WITH CHAIN GRIPPER DELIVERY

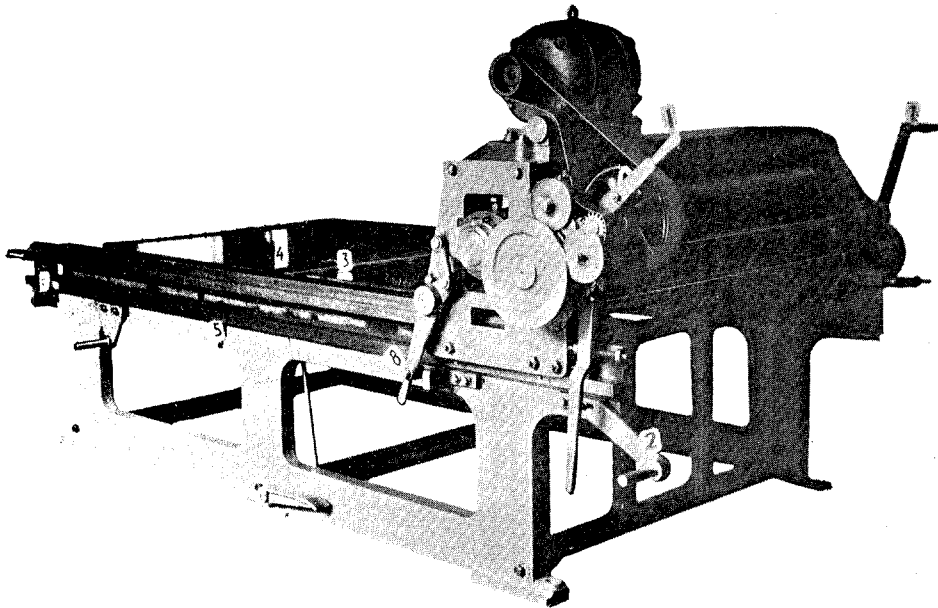

中國運輸機械進口公司經售

Exported by CHINA NATIONAL TRANSPORT MACHINERY IMPORT CORPORATION

香港代理處：華潤公司

Hong Kong Agency: CHINA RESOURCES CO.

BANK OF CHINA BUILDING

HONG KONG

CABLE ADDRESS: "CIRECO."



This is a popular machine for any offset printing establishment, capable of handling intricate colour printing on any kind of paper. It is provided with either flyer delivery or chain gripper delivery at buyers' option. Other unique features of this machine are: improved inking device, dense and sharp impression and perfect register.

Model:	OHF & OHC
Printing Surface:	610 x 915 mm (24" x 36")
Plate Size:	725 x 915 mm (28½" x 36")
Paper Size:	610 x 915 mm (24" x 36")
Blanket Size:	864 x 915 mm (34" x 36")
Production:	2700 sheets per hour on one side.
Drive Ratio:	5:1
Pulley Size:	550 mm (22") diameter
Motor:	3 h. p.
Installation Floor Space:	3000 x 2000 mm (10' 0" x 6' 8")
Weight:	Net: 3500 kg. approx. Gross. 4360 kg. approx.
Shipping Space:	12 cubic meters approx.

*N.B.—For improvement of the machine, we reserve the right to alter either the design or the specification.*

CODE: RT-5019

澆鉛版機

STEREO-PLATE CASTING MACHINE  
MODEL RD-14

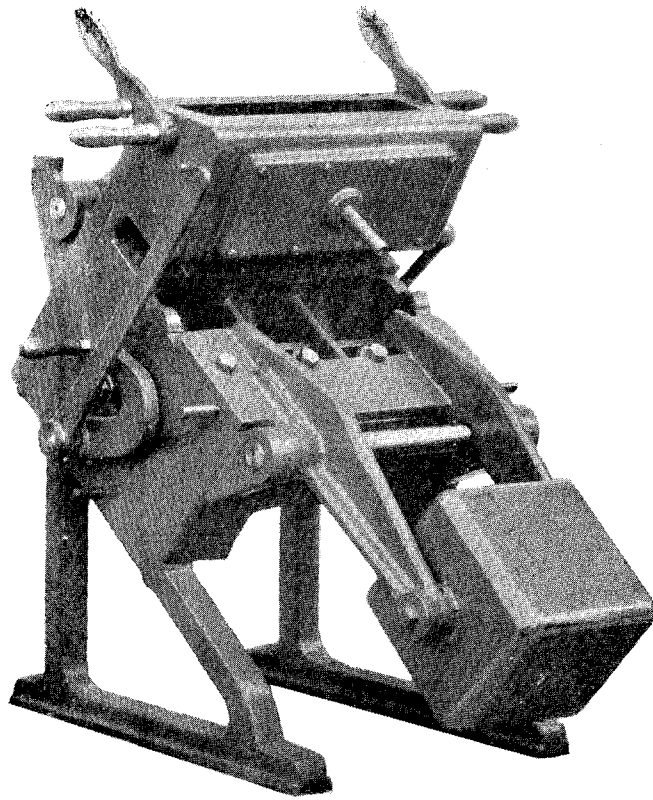

中國運輸機械進口公司經售

Exported by CHINA NATIONAL TRANSPORT MACHINERY IMPORT CORPORATION

香港代理處：華潤公司

Hong Kong Agency: CHINA RESOURCES CO.

BANK OF CHINA BUILDING

HONG KONG

CABLE ADDRESS: "CIRECO."

This machine is designed for mechanical casting of curved stereo-plates for rotary presses. It is oftenly used in combination with Model RN-14 melting oven. Left or right hand operated types can be supplied as required.

The installation of this machine is simple as only a concrete foundation is required for the work.

It comprises of a turnable vertical cylinder in the center of a curved casting box. After the machine is set in motion by a lever movement, molten metal is pumped into the mould and a stereo-plate is formed. Thereafter, the stereo-plate travels with the cylinder and is trimmed. Water cooling system is provided throughout the entire casting process.

Specifications:

Dimension of Stereo-plate:	To customers' requirement
Capacity:	1 plate per minute
Power required:	7½ H. P.
Space Required for Machine (including Oven & Pump) in sets:	Length 2 x width 2½ x height 2 meter
Net Weight:	2,000 kg. approx.
Gross Weight:	2,200 kg. approx.
Shipping Space:	4.8 cu. meter approx.

*N.B.—For improvement of the machine, we reserve the right to alter either the design or the specification.*

CODE: RT - 6001

捲 烟 機

HIGH SPEED CIGARETTE - MAKING MACHINE

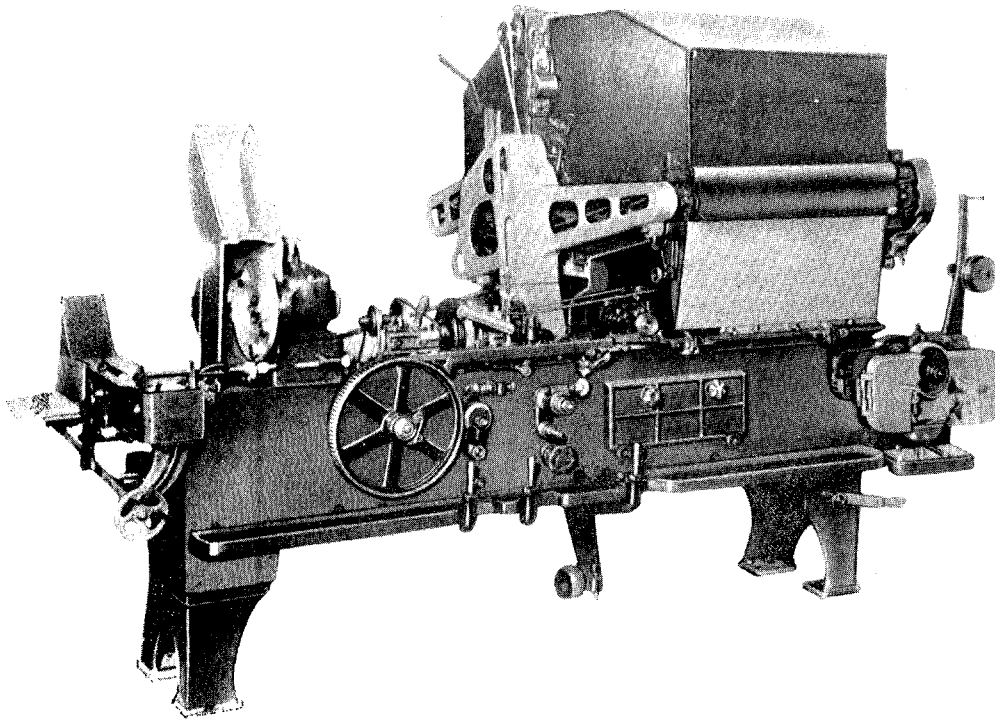

中國運輸機械進口公司經售

Exported by CHINA NATIONAL TRANSPORT MACHINERY IMPORT CORPORATION

香港代理處：華潤公司

Hong Kong Agency: CHINA RESOURCES CO.

BANK OF CHINA BUILDING  
HONG KONG

CABLE ADDRESS: "CIRECO."

**Specification:**

Production per minute	... ..	1000 pcs. (About 80 to 90 kgs. of tobacco are required to produce 50,000 cigarettes)
Length of Cigarette	... ..	70 mm
Power Required	... ..	3 H. P. Motor 1450 rpm.
Floor Space (L x W x H)	... ..	10 ft. x 6 ft x 7 ft.
Packing	... ..	In two wooden cases.
a) Measurement of Case #1	... ..	10½ x 3½ x 5 ft.
b) Measurement of Case #2	... ..	6½ x 5 x 7½ ft.
Weight	... ..	Net: 2500 kg. Gross: 3100 kgs.

**Auxiliary Machines**

1. Tobacco Cutting Machine with 10" knife: Capacity—140 kgs/hour
2. Tobacco Cutting Machine with 16" knife: Capacity—450 kgs./hour
3. Stem Crushing Machine: Capacity—200 kgs/hour
4. Cigarette Carton Making Machine
5. Waxed Paper Wrapping Machine
6. Packing Machine
7. Knife Grinding Machine
8. Tobacco Drying and Cooling Machine
9. Unpacking Machine
10. Tobacco Leaves Steaming Machine
11. Tobacco Leaves Baking Machine
12. Flavour Mixing Machine

*N.B.—For improvement of the machine, we reserve the right to alter either the design or the specification.*

CODE: RT - 6002

製 餅 干 機 設 備

BISCUIT BAKERY EQUIPMENT



中 國 運 輸 機 械 進 口 公 司 經 售

*Exported by* CHINA NATIONAL TRANSPORT MACHINERY IMPORT CORPORATION

香港代理處：華 潤 公 司

*Hong Kong Agency:* CHINA RESOURCES CO.

BANK OF CHINA BUILDING  
HONG KONG

CABLE ADDRESS: "CIRECO."

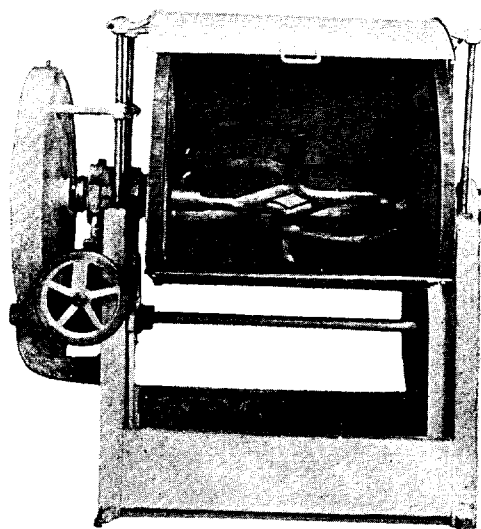

**BISCUIT DOUGH MIXER**  
MEDIUM SIZE

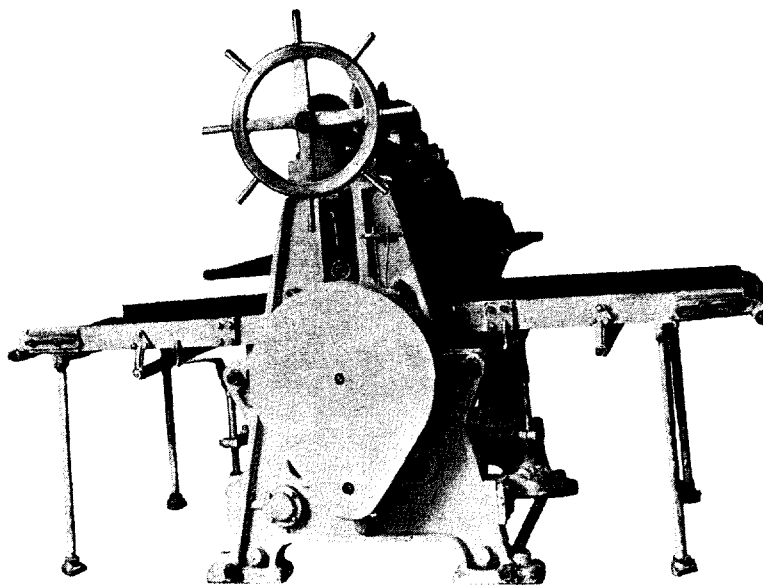

**BISCUIT MEAL - SHEETER**  
MEDIUM SIZE

Sanitized Copy Approved for Release 2010/02/02 : CIA-RDP80T00246A032700710001-0

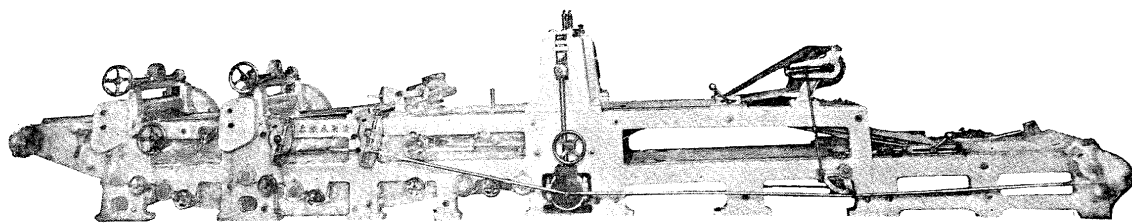

## BISCUIT MOLDING PRESS

MEDIUM SIZE



Specification:

1. Biscuit Molding Press (Medium size) 製餅鈺機(中型)
  - a) Adjustable Thickness of Meal Sheets 3-19 mm
  - b) Adjustable Speed of Molding 15-130 times per minute.
  - c) Output Capacity per hour ... .. Maximum 370 kgs.  
Minimum 120 kgs.
  - d) Power Required ... .. 7½ H. P. Motor
  
2. Biscuit - Dough - Mixer (Medium Capacity) 拌粉機(中型)
  - a) Dimension... .. Length 1700 mm  
Width 889 mm  
Depth 1700 mm
  - b) Flour Treated per Batch ... .. 150 kgs.
  - c) Power required ... .. 3 HP Motor
  
3. Biscuit Meal - Sheeter (Medium Size) 皮子機(中型)
  - a) Dimension of Table ... .. Length 2700 mm  
Width 800 mm  
Height 840 mm
  - b) Attached Equipment:
    - Rubber Belting 76 x 3556 mm... 2 pcs.
    - Motor Belt Pulley ... .. 1 pcs.
    - Foundation Bolts ... .. 4 pcs.
  - c) Power Required ... .. 5 HP Motor.
  
4. Circulated Turbo - Fan Oven 烘爐
  - a) Type ... .. 10 trays, 5 shelves, 2 layers in concentric  
Oven Conveyor: Outer Diameter 3150 mm  
Height 3300 mm  
Length of Conveyor Axis 4970 mm
  - b) Size of Fire-Brick Oven Shell ... Length 4700 mm  
Width 4700 mm  
Height 7000 mm
  - c) Power Required ... .. 2 HP Motor.

*N.B.—For improvement of the machine, we reserve the right to alter either the design or the specification.*

CODE: RT-8001

製大頭針機  
PIN MAKING MACHINE

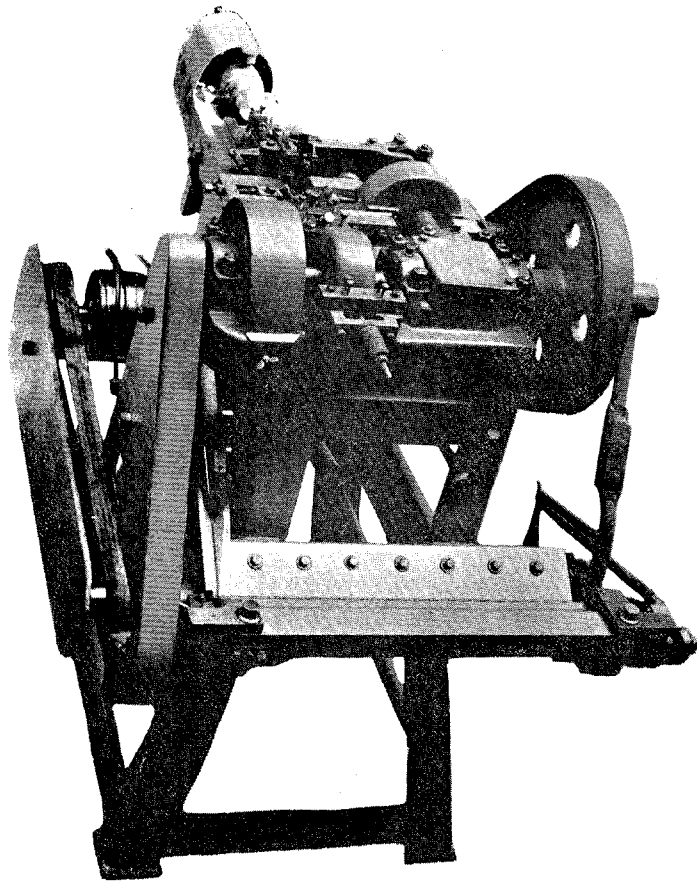

中國運輸機械進口公司經售

*Exported by* CHINA NATIONAL TRANSPORT MACHINERY IMPORT CORPORATION

香港代理處：華潤公司

*Hong Kong Agency:* CHINA RESOURCES CO.

BANK OF CHINA BUILDING  
HONG KONG  
CABLE ADDRESS: "CIRECO."

**Specification:**

Revolution: ... ..	300 R. P. M.
Raw Materials Required ... ..	Iron Wire, BWG 22.
Production ... ..	14 cm per 8 hours
Measurement ... ..	Length 52 inches
	Width 48 inches
	Height 52 inches
Weight ... ..	625 kgs.
Motor Required ... ..	1½ - 2 H. P.

*N.B.—For improvement of the machine, we reserve the right to alter either the design or the specification.*

CODE: RT - 8002A

自動壓杯機  
AUTOMATIC MOULD  
FOR MAKING DRINKING GLASS.

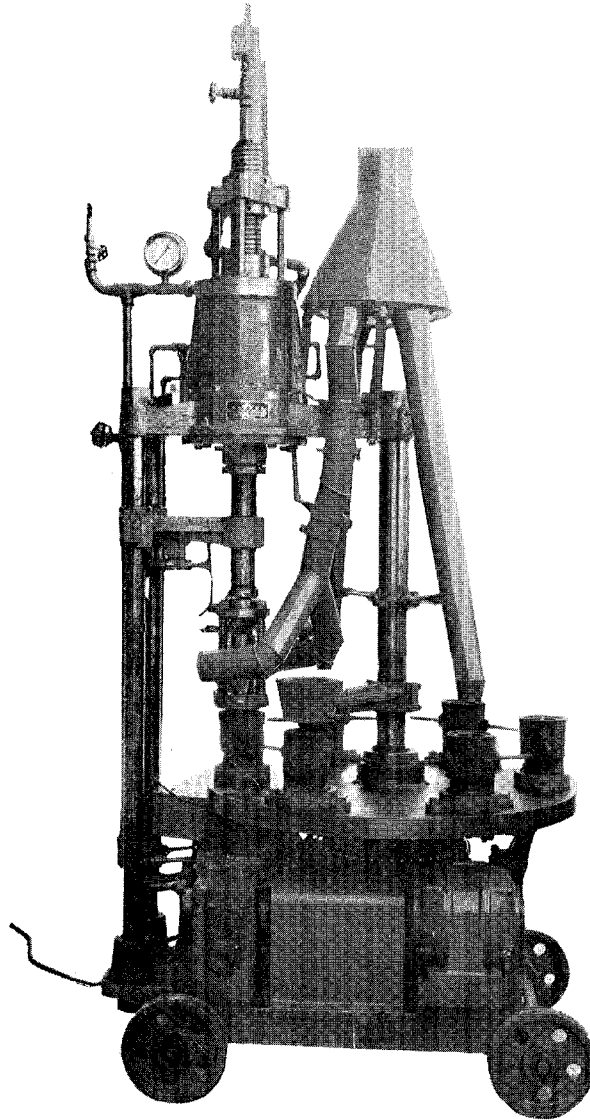

中國運輸機械進口公司經售

Exported by CHINA NATIONAL TRANSPORT MACHINERY IMPORT CORPORATION

香港代理處：華潤公司

Hong Kong Agency: CHINA RESOURCES CO.

BANK OF CHINA BUILDING  
HONG KONG  
CABLE ADDRESS: "CIRECO."

Driven by electric motor. Compressed air of 40-45 lbs./sq. in. pressure is used. Suitable for making drinking glass. Machine revolves at 11-19 revolutions per minute.

Production:	900 doz. per 8 hour-day
Overall Dimensions:	240 x 135 x 110 cm.
Weight:	1850 kgs.
Power Required:	1.2 kw.

*N.B.—For improvement of the machine, we reserve the right to alter either the design or the specification.*

CODE: RT - 8002B

半自動壓杯機  
SEMI-AUTOMATIC MOULD  
FOR MAKING DRINKING GLASS.

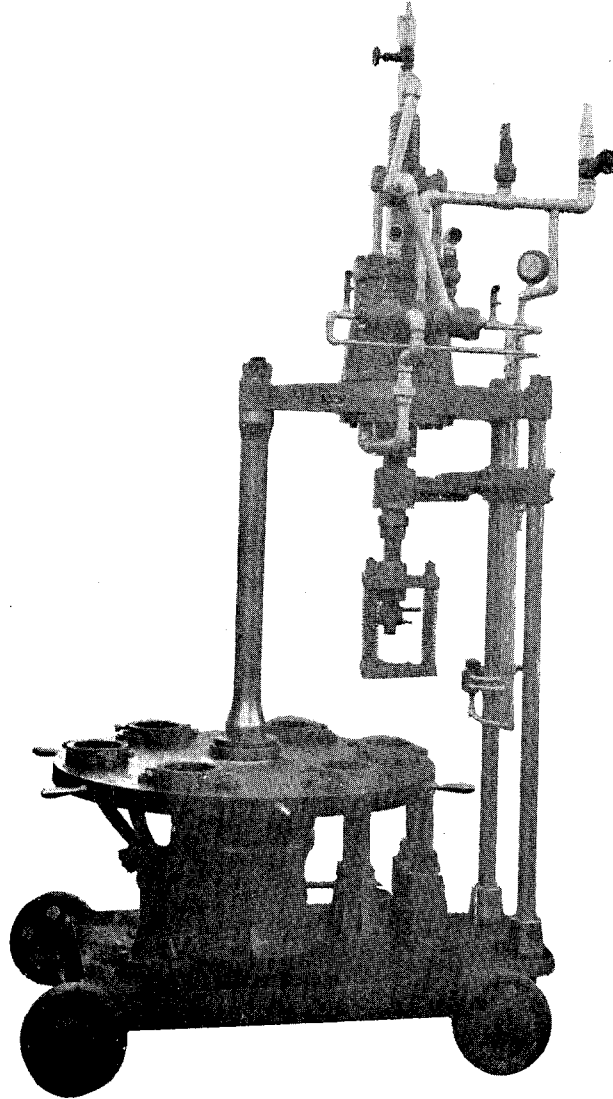

中國運輸機械進口公司經售

Exported by CHINA NATIONAL TRANSPORT MACHINERY IMPORT CORPORATION

香港代理處：華潤公司

Hong Kong Agency: CHINA RESOURCES CO.

BANK OF CHINA BUILDING  
HONG KONG

CABLE ADDRESS: "CIRECO."

Suitable for making drinking glass, dish, etc. with maximum height of 8 inches and diameter of 6 inches. Compressed air of about 45 lbs./sq. in. pressure is used.

Production:	450 doz. per 8 hour-day
Overall Dimension:	96 $\frac{1}{2}$ " x 52" x 32"
Weight:	1,650 kgs.

*N.B.—For improvement of the machine, we reserve the right to alter either the design or the specification.*

CODE: RT - 8002C

三 鐵 碗 吹 瓶 機  
BOTTLE BLOWING MACHINE  
WITH 3 MOULDS.

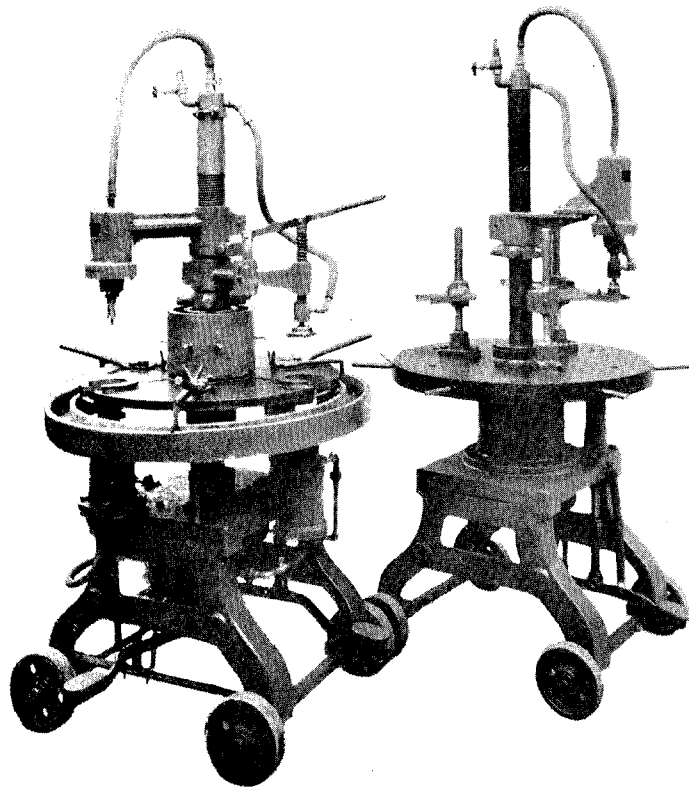

中國運輸機械進口公司經售

Exported by CHINA NATIONAL TRANSPORT MACHINERY IMPORT CORPORATION

香港代理處：華潤公司

Hong Kong Agency: CHINA RESOURCES CO.

BANK OF CHINA BUILDING

HONG KONG

CABLE ADDRESS: "CIRECO."



Usage:	Capable of blowing glass bottles of 50 to 500 cu. cm. contents.
Capacity:	About 6,000 pcs. per 8 hour-day
Overall Dimension:	29" x 29" x 65"
Weight:	850 kgs.

Compressed air of 25 to 30 lbs. per sq. in. pressure is to be used for blowing the glass bottles.

*N.B.—For improvement of the machine, we reserve the  
right to alter either the design or the specification.*

CODE: RT-8003

機 鈕 擱  
STUD MAKING MACHINES

雙行程擱鈕雄片落料翻邊車  
PUNCH PRESS (FOR MALE PART OF STUD)  
ITEM No. A-1

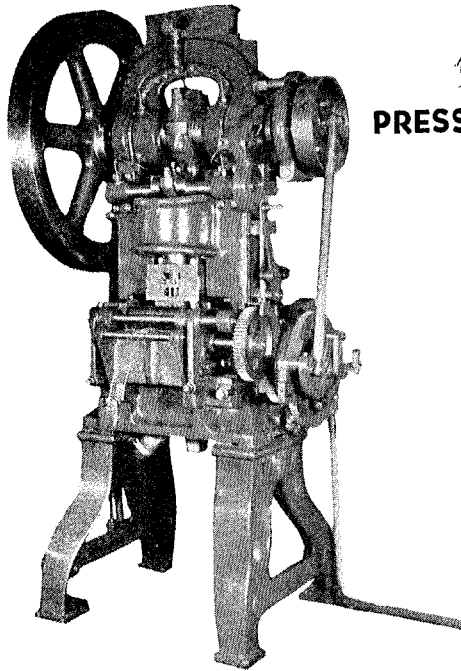

雙行程擱鈕雄片捲邊車  
PRESS (FOR MALE PART OF STUD)  
ITEM No. A-2

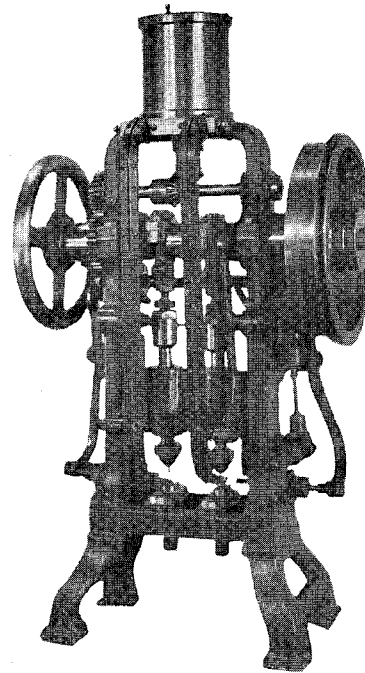

中國運輸機械進口公司經售

Exported by CHINA NATIONAL TRANSPORT MACHINERY IMPORT CORPORATION

香港代理處：華潤公司

Hong Kong Agency: CHINA RESOURCES CO.

BANK OF CHINA BUILDING  
HONG KONG

CABLE ADDRESS: "CIRECO."

單行程擷鈕雌片冲條車  
PRESS (FOR FEMALE PART OF STUD)  
ITEM No. B-1

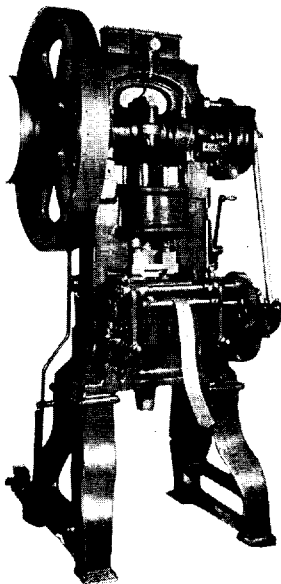

三行程擷鈕雌片落料翻邊車  
PUNCH PRESS (FOR FEMALE PART OF STUD)  
ITEM No. B-2

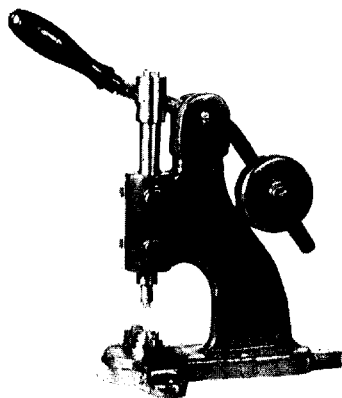
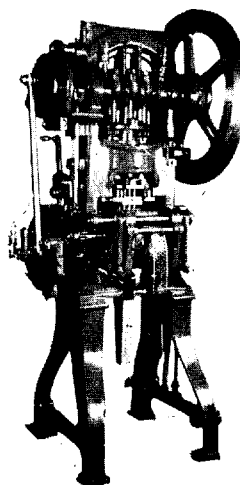

手扳裝擷鈕彈簧捲邊車  
HAND DRIVEN PRESS (FOR FEMALE PART  
OF STUD) ITEM No. B-3

擱鈕銅絲彈簧車

**WIRE SPRING MAKING MACHINE**  
**ITEM No. C.**

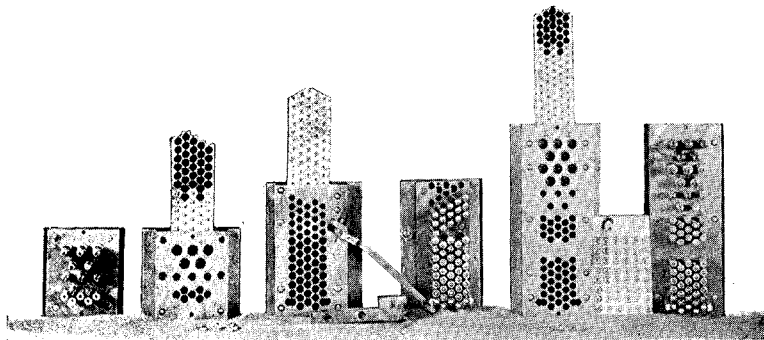
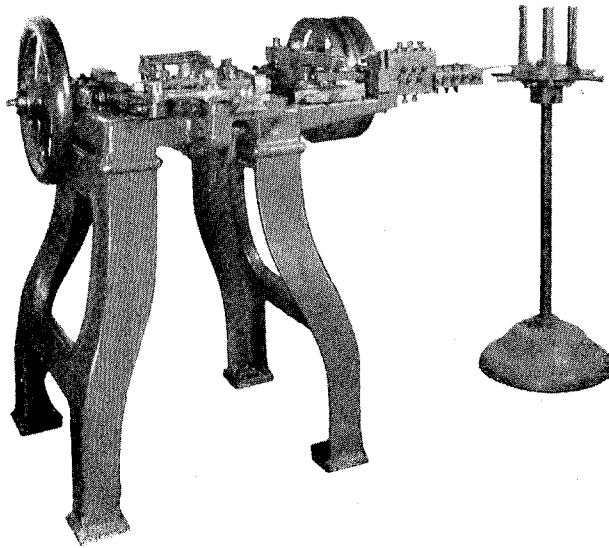

擱鈕車冲模  
**DIES.**

**Specifications:**

Name of machine	Spindle speed rpm	Stroke m/m	H. P. required	R. P. M.	Overall dimension m/m	Weigth Kg.	Output per min.
(A) 1	150	29x39	2½	960	1220 x 1070 x 2160	1725	750 pcs.
(A) 2	140	39x39	1/2	960	530 x 310 x 770	130	280 pcs.
(B) 1	150	29	2½	960	1220 x 1070 x 2160	1700	750 pcs.
(B) 2	150	10x30	2	960	990 x 690 x 1710	1400	750 pcs.
(B) 3					390 x 210 x 410	17	18 pcs.
(C)	150		1/2	960	950 x 690 x 970	130	600 pcs.
(D)	500		7½			250	

All power driven machines are coupled to the motor by Vee belt.

The name of machine is listed and explained as follow:

**NAME OF MACHINE****(A) For Male part of Stud**

1. Punch Press for cutting copper or zinc alloy strips into pieces and at the same time bead and sewing holes are formed and edge is turned downward.
2. Press for folding the edge of the stud.

**(B) For female part of Stud**

1. Press for making bead and sewing holes on strips,
2. Punch Press for cutting strips into pieces and at the same time edge is turned upward.
3. Hand driven Press for folding the edge of the Stud and at the same time wire spring is inserted.

**(C) Wire Spring Making Machine**

- (D) Vertical Air Compressor for the supply of compressed air to each machine to blast scraps from the dies.

*N.B.—For improvement of the machine, we reserve the right to alter either the design or the specification.*

CODE: RT - 8004 A

## 製木螺絲全套設備

## WOOD SCREW MAKING MACHINERY

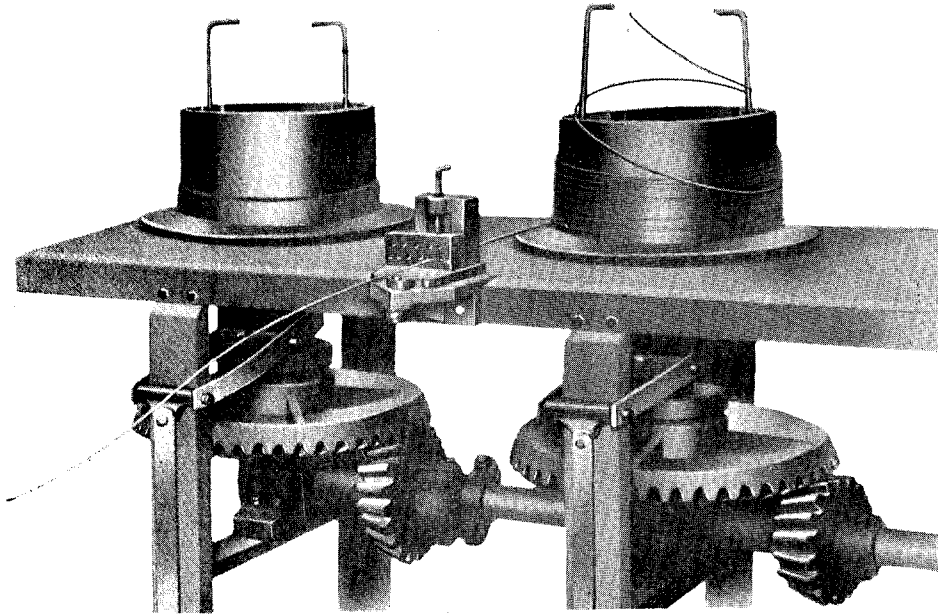

(A) WIRE DRAWING MACHINE (ARRANGED IN SERIES)

Specifications:

Diameter of Drawing drum in inches	Number of rel./min.	Distance between spindles in inches	Thickness of wire to be drawn (B.W.G.)	Weight of Machine in lbs.	Output in 8 hours in lbs.	Power consumption in H. P.
24	25	55	8/0 - 1	3800	6600	12
23	30	51	4/0 - 4	3650	4400	10
22	45	47	1 - 8	3450	3520	8
21	55	47	4 - 11	3350	2640	6

中國運輸機械進口公司經售

Exported by CHINA NATIONAL TRANSPORT MACHINERY IMPORT CORPORATION

香港代理處：華潤公司

Hong Kong Agency: CHINA RESOURCES CO.

BANK OF CHINA BUILDING  
HONG KONG  
CABLE ADDRESS: "CIRECO."

**(B) SINGLE STROKE OPEN DIE COLD HEADER (UNIVERSAL TYPE)**Specifications:

Size... ..	1/8"	1/4"	3/8"
	H-1	H-2	-3
Capacities:			
Max. dia. of wire S.G.) ...	0-5	4-10	9-14
Max. length shank ... ..	1"	2"	3"
Min. length wire blank ... ..	3/8"	1"	1 1/2"
Max. length wire blank ... ..	1 1/4"	2-3/8"	3 1/2"
Output per min. (pieces) ...	225/250	125/150	100
Output in 8 hours (gross) ...	480/550	300/400	245
Flywheel:			
Approximate weight ... ..	150	400	820
Diameter and face ... ..	ø24" x 4"	ø42" x 5 1/2"	ø48" x 8"
Motor:			
H. P. ... ..	2	5	7 1/2
R. P. M. ... ..	960	1400	1400
Floor Space ... ..	2'2" x 3'9"	3'10" x 5'10"	4'5" x 7'9"
Net Weight (lbs.) ... ..	2500	3750	8900
Boxed Weight (lbs) ... ..	2800	4350	9200
Boxed dimension ... ..	45 cu. ft.	120 cu. ft.	190 cu. ft.

**(C) HEAD TURNING & SLOTTING MACHINE  
(TWO SPINDLE MACHINE)**

The bolt head is first turned off then slotted, then again finish turned.

Specifications:

Size ... ..	S-0	S-1
Capacities:		
Max. dia. (S.G.) Wood Screw Gauge	0-8	7-14
Max. Length of Wood Screw ... ..	2"	3 1/4"
Output per min. (pcs.) ... ..	22-24	18-20
Output in 8 hours (gross)... ..	60-70	50-55
Motor:		
H. P. ... ..	0.75	1
R. P. M. ... ..	1400	1400
Floor Space ... ..	2' x 3'	2'6" x 3'6"
Net Weight (lbs) ... ..	650	800
Boxed Weight (lbs) ... ..	800	970
Boxed dimension ... ..	40 cu. ft.	46 cu. ft.

*N.B.—For improvement of the machine, we reserve the right to alter either the design or the specification.*

CODE:RT - 8004 B

製木螺絲全套設備

WOOD SCREW MAKING MACHINERY

木螺絲車

(D) SCREW THREADING MACHINE

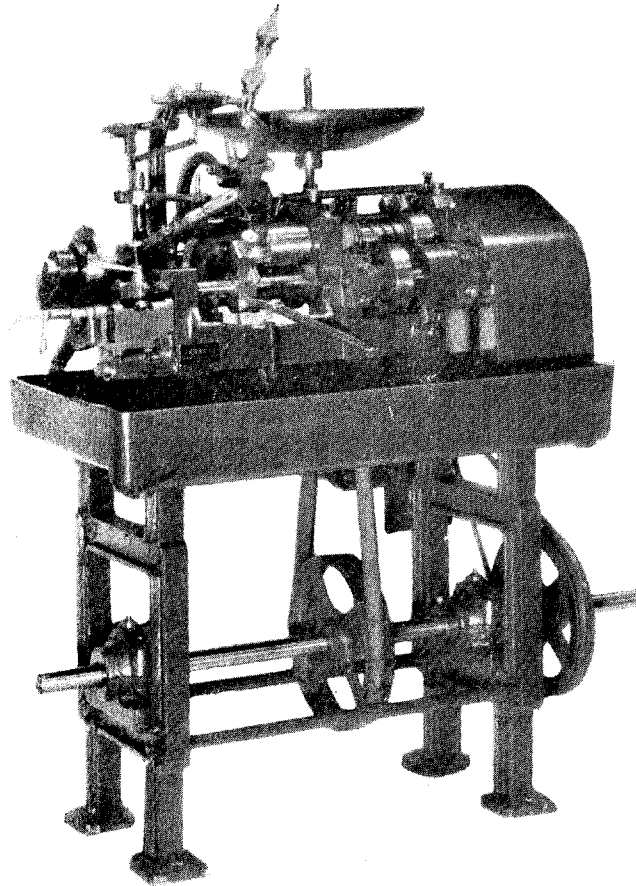

中國運輸機械進口公司經售

Exported by CHINA NATIONAL TRANSPORT MACHINERY IMPORT CORPORATION

香港代理處：華潤公司

Hong Kong Agency: CHINA RESOURCES CO.

BANK OF CHINA BUILDING

HONG KONG

CABLE ADDRESS: "CIRECO."



Specifications:

Size	T - 0	T - 1	T - 2
Capacities:			
Max. dia. (S.G.) wood screw gauge	0-8	7-12	10-16
Max. length of wood screw	$\frac{1}{4}$ " - $1\frac{1}{2}$ "	$\frac{3}{8}$ " - $2\frac{1}{2}$ "	$\frac{1}{2}$ " - $3\frac{1}{2}$ "
Output per min. (pcs.)	10 - 18	6 - 16	4 - 10
Output in 8 hours (gross)	25 - 50	18 - 40	13 - 25
Floor Space	2' x 3'	2'6" x 3'6"	2'6" x 4'0"
Motor:			
H. P.	0.5	0.75	1
R. P. M.	1400	1400	1400
Net Weight (lbs.)	650	800	1000
Boxed weight (lbs.)	800	970	1170
Boxed Dimension	40 cu. ft.	46 cu. ft.	52 cu. ft.

**(E) AUXILIARY MACHINE & APPARATUS****1. Scouring and Cleaning Drums (Rumblers)**

Length	34"
Diameter	22"
Motor: H. P.	1
R. P. M.	960
Net Weight	1000
Boxed Weight	1320
Boxed Dimension	14 cu. ft.

Rumblers with sheet iron cases and those with wood cases are required, the former for scouring the pressed blanks and the latter for cleaning the half finished and the finished wood screws coming from the head turning and slotting machines and the screw threading machines respectively.

**2. Milling Cutter Grinding Machine (Automatic Type)**

This Machine automatically sharpens the teeth of milling cutter for the head turning and slotting machines, where they have become blunt.

**3. Wire Reel**

For the heading presses wire reels are required for unwinding the wire.

**4. Centrifugal pump directly coupled with motor.**

The head turning and slotting machines as well as the screw threading machines requires a constant supply of a solution of soda for cooling the cutter and milling cutter.

\* \* \* \* \*

**Machines for an output of roughly 3000 gross of wood screw for 8 hours ranging in sizes from screw gauge No. 2 to S. G. No. 14 and 1/4" to 3" long are as follows:**

1 set	Wire Drawing Machines	W - 1
	4 heads arranged in series	
3 sets	Single stroke open die cold header	1/8" - H - 1
3 sets	Single stroke open die cold header	1/4" - H - 2
2 sets	Single stroke open die cold header	3/8" - H - 3
56 sets	Screw threading Machines	T - 0
24 sets	Screw threading Machines	T - 1
24 sets	Screw threading Machines	T - 2
44 sets	Head turning and slotting machines	S - 0
36 sets	Head turning and slotting machines	S - 1

*N.B.—For improvement of the machine, we reserve the right to alter either the design or the specification.*

CODE: RT - 8005

製安全別針全套設備

SAFETY PIN MACHINES.



中國運輸機械進口公司經售

*Exported by* CHINA NATIONAL TRANSPORT MACHINERY IMPORT CORPORATION

香港代理處：華潤公司

*Hong Kong Agency:* CHINA RESOURCES CO.

BANK OF CHINA BUILDING  
HONG KONG

CABLE ADDRESS: "CIRECO."

**WIRE STRAIGHTENING,  
CUTTING & SHARPENING  
MACHINE ITEM 1.**

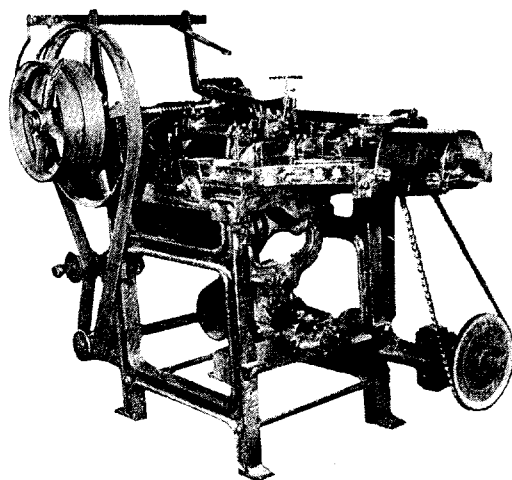

**WIRE COILING MACHINE  
ITEM 2.**

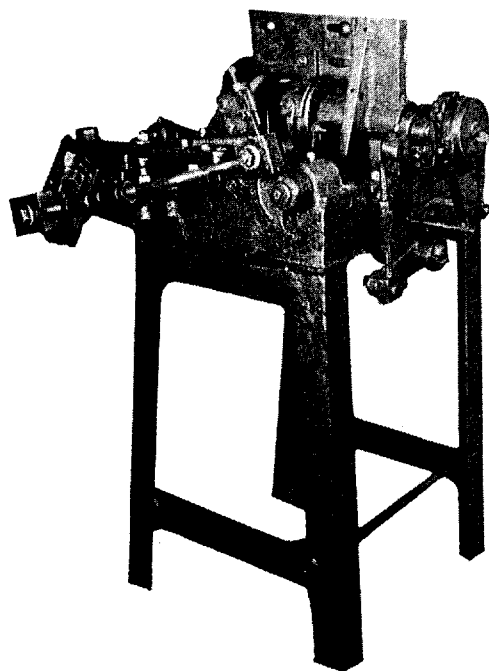

雙行程冲頭車

**LOCK MAKING PRESS**  
**ITEM 3.**

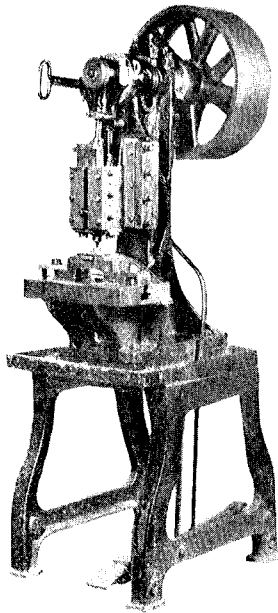

捲邊車

**LOCK GRIPPING PRESS**  
**ITEM 4.**

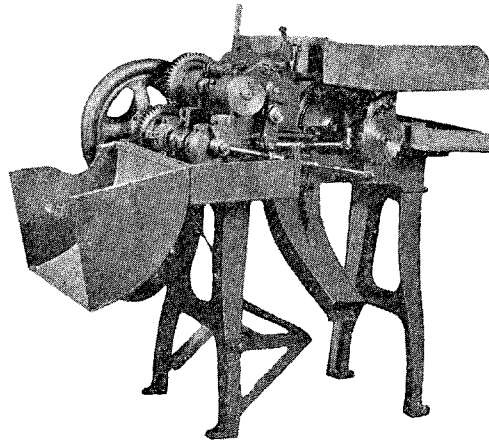

*Item 1*      Wire Straightening. Cutting & Sharpening Machine.

By means of this machine, low carbon steel wire in the form of coils is straightened, next cut into blanks of definite length (say 6.7 cm), and then one end of the blank is ground to form a sharpened point.

Motor required:  $1\frac{1}{2}$  HP, 960 RPM

Overall Dimension: 1630 x 1150 x 1450 mm

Weight: 800 kg.

Output: 120 pieces per minute

*Item 2*      Wire Coiling Machine

The blank with one end sharpened is coiled or bent into the required form with a helix giving the effect of a spring.

Motor required:  $\frac{1}{2}$  HP, 960 RPM

Overall Dimensions: 870 x 840 x 1020 mm

Weight: 240 kg.

Output: 120 pieces per minute

*Item 3*      Lock Making Press

The Press is of dual action type. In one action, raw material steel sheet is cut into small piece as blank for the other action, under which the blank is pressed to form Lock (but not in its final form).

Motor required:  $\frac{1}{2}$  HP, 960 RPM

Overall Dimension: 660 x 510 x 1600 mm

Weight: 310 kg.

Output: 144 pieces per minute

*Item 4*      Lock Gripping Press

The coiled wire and the Lock after being assembled by hand is fed, manually, into this Press, in which the Lock is pressed into the final form.

Motor required:  $\frac{1}{2}$  HP, 960 RPM

Overall Dimensions: 980 x 950 x 1010 mm

Weight: 270 kg.

Output: 120 pieces per minute

Remarks:      The finished product is then electro-plated and the processes are:

- a. barreling, to cleanse the safety pins.
- b. copper-plating, preparatory to nickel plating.
- c. nickel plating.

Particulars for such equipment, as well as those of Punch & Dies for Punching Presses, will be supplied upon request.

*N.B.—For improvement of the machine, we reserve the right to alter either the design or the specification.*

CODE: RT - 8006

# 鋼筆刻名機

## ENGRAVING INSTRUMENT.

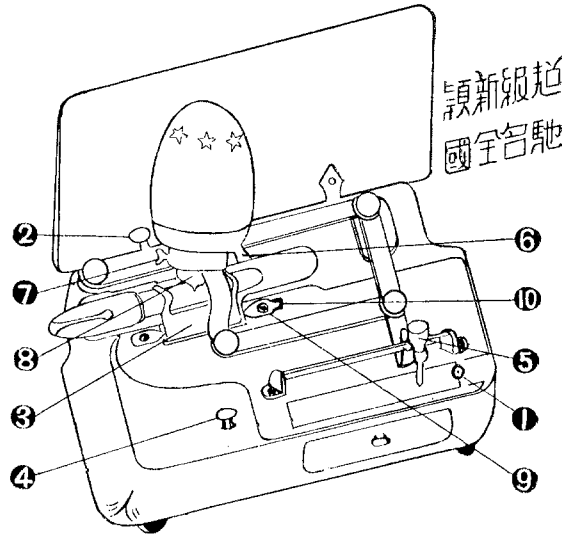

### 使用說明

- |         |  |         |                      |
|---------|--|---------|----------------------|
| 1. 簽名紙  | 放入隔層玻璃內將羅絲旋緊使玻璃不動即可                            | 6. 電珠   | 如遇陰天或夜晚光線不足時使用之      |
| 2. 軋筆機鈕 | 在機壳外面用手指將它掀下                                   | 7. 元寶羅絲 | 將它旋鬆蛋形刻字器即可拔出        |
| 3. 軋筆器  | 將鋼筆橫插入使牠平服即可                                   | 8. 換針軋頭 | 羅絲綫頭旋下換入新針舊針保存磨尖仍可使用 |
| 4. 機鈕   | 左手掀4右手拿5遇斷劃左手須放手遇大中小鋼筆型膠軟料將4往上退旋膠木硬料相反向下退旋隨意調節 | 9. 大羅絲  | 日久如遇鬆動則先將它旋鬆         |
| 5. 指針   | 像寫字式與4配合起來慢慢地照字劃移動指針                           | 10. 橫羅絲 | 將它較緊些再將9旋緊           |

附言初刻時先用廢鋼筆梗作試刻數次即會

中國運輸機械進口公司經售

Exported by CHINA NATIONAL TRANSPORT MACHINERY IMPORT CORPORATION

香港代理處：華潤公司

Hong Kong Agency: CHINA RESOURCES CO.

BANK OF CHINA BUILDING  
HONG KONG

CABLE ADDRESS: "CIRECO."

# 鋼筆刻名機

## ENGRAVING INSTRUMENT.

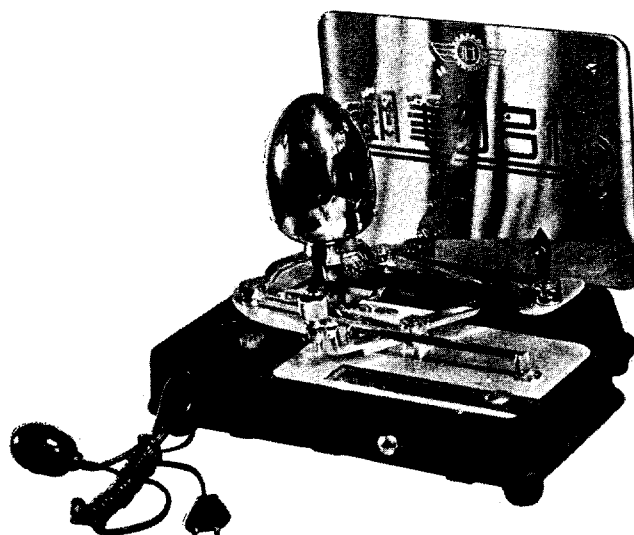

### Working Instructions:-

- |                              |   |
|------------------------------|---|
| 1. Signature specimen        | Place specimen of signature underneath glass plate (1). and tighten screw.  |
| 2. Clamp button              | Press button (2).   |
| 3. Clamp                     | Insert pen and have it held firm by clamp (3).  |
| 4. Impression control button | Press (4) with left hand finger and hold (5) with right hand. Release left hand finger when encountering broken strokes. When engraving on pen of soft material, moving screw button upward; when engraving on pen of hard material, screw button downward. The impression is thus regulated. |
| 5. Tracer                    | Trace along the signature in concord with the impression control button.  |
| 6. Bulb                      | This is intended to improve illumination whenever necessary.  |
| 7. Wing screw                | Loosen this screw to detach the eggshape engraver.  |
| 8. Chuck                     | Screw off chuck to replace needle.  |
| 9. Big screw                 | When big screw becomes loose after repeated use, loosen it first; tighten horizontal screw (10) and then tighten big screw.   |
| 10. Horizontal screw         |   |

*N.B.—For improvement of the machine, we reserve the right to alter either the design or the specification.*

CODE: RT - 3005

“飛人”牌18型鎖邊縫紉機

(供呢絨毛毯鎖邊用)

OVERLOCK STITCH SEWING MACHINE

“FLYING MAN” MODEL 18

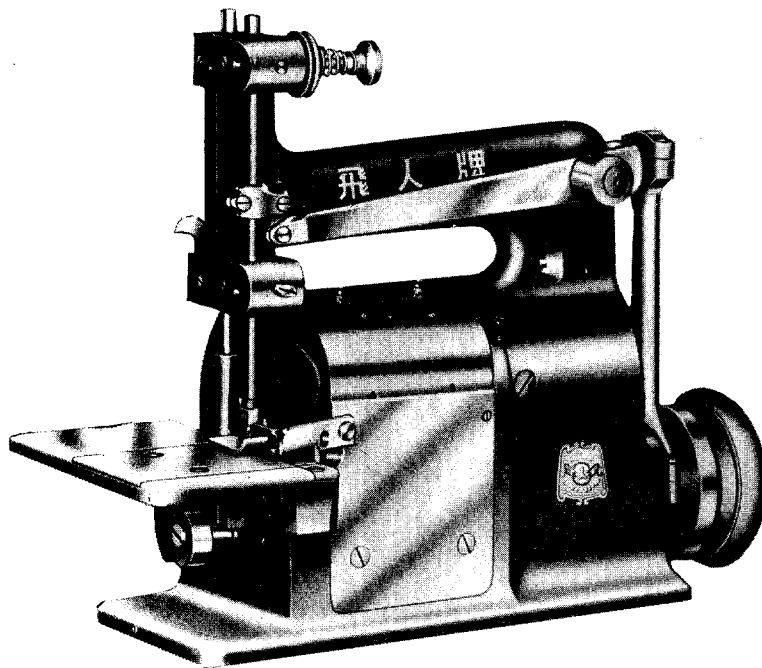

中國運輸機械進口公司經售

Exported by CHINA NATIONAL TRANSPORT MACHINERY IMPORT CORPORATION

香港代理處：華潤公司

Hong Kong Agency: CHINA RESOURCES CO.

BANK OF CHINA BUILDING  
HONG KONG

CABLE ADDRESS: "CIRECO."



Model 18 is a single thread overlock sewing machine for seaming, overedging or hemming work on all kinds of materials. It is specially adaptable for overedging woollen blankets.

The constructional features are compactness, easy threading, accessibility to moving parts and improved lubricating system. The pitch of the stitches can be adjusted from 2 to 6 mm by changing the cam.

The length of stitches can be adjusted up to 12 mm so that thick blankets can be seamed as desired. The sewing speed can be as high as 1200 stitches per minute enabling trained operators to overedge woollen blankets of normal size at a rate of 30 pieces per hour.

Length of stitch	12 mm.
Maximum sewing speed	1200 stitches per minute
Maximum pitch of stitches	6 mm.
Overall dimension (L x W x H)	300 x 136 x 255 mm.
Power required	$\frac{1}{4}$ HP.

#### Packing Information

Contents	Approximate Weight (kgs)		Approximate Measurement (cm)
	Nett	Gross	
1 set Head	12.5	20	

*N.B.—For improvement of the machine, we reserve the right to alter either the design or the specification.*

CODE: RT - 3008

“標準”牌81-6型工業用縫紉機

THREE-THREADED OVERLOCK  
SEWING MACHINE  
“TYPICAL” MODEL 81-6

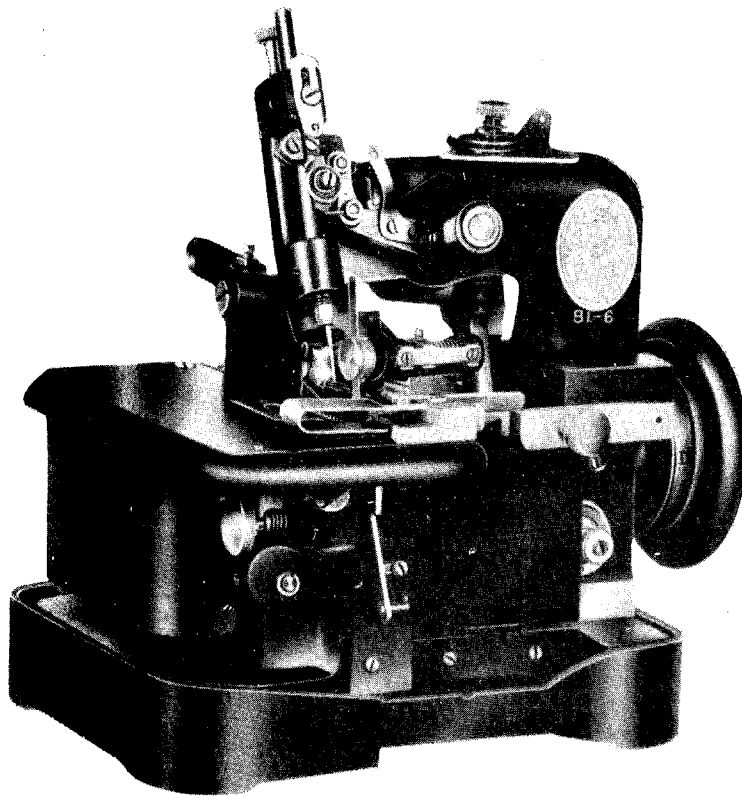

中國運輸機械進口公司經售

Exported by CHINA NATIONAL TRANSPORT MACHINERY IMPORT CORPORATION

香港代理處：華潤公司

Hong Kong Agency: CHINA RESOURCES CO.

BANK OF CHINA BUILDING

HONG KONG

CABLE ADDRESS: "CIRECO."

This machine is fitted with auxiliary feed and trimmer and is specially made for sewing fabrics, hosiery or light materials. The machine produces elastic chain stitch and is also designed for TRIMMING, OVEREDGING and BLIND STITCH HEMMING or WELTING, these can be done in a single operation.

Apart from the foregoing, this machine has made possible, quality production, high speed and low operating costs to a degree greater than ever before. It is easy to handle, simple to adjust, sturdy in design, accurate in workmanship and is readily adapted to many kinds of work.

Length of stitch	3.6 mm.
Maximum sewing speed	3000 stitches per minute
Sewing width	1.5-5 mm.
Thickness of material sewn	5 mm.
Needles	System ( 81 x 1 )
Power required	$\frac{1}{4}$ HP.

#### Packing Information

Contents	Approximate Weight (kgs)		Approximate Measurement (cm)
	Nett	Gross	
1 set Head	18	27	52 x 36 x 40

*N.B.—For improvement of the machine, we reserve the right to alter either the design or the specification.*

CODE: RT - 4001

萬 能 帶 鋸  
UNIVERSAL BAND SAW MACHINE

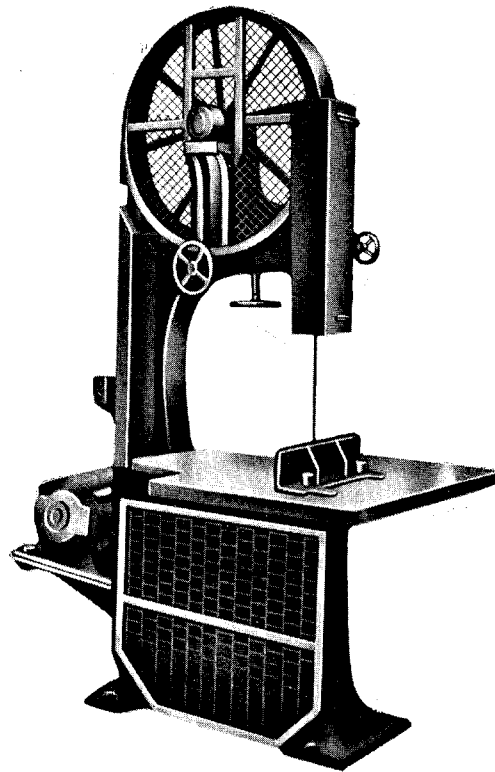

中國運輸機械進口公司經售

*Exported by* CHINA NATIONAL TRANSPORT MACHINERY IMPORT CORPORATION

香港代理處：華潤公司

*Hong Kong Agency:* CHINA RESOURCES CO.

BANK OF CHINA BUILDING  
HONG KONG  
CABLE ADDRESS: "CIRECO."

Wheel diameter	...	...	...	...	...	...	...	...	...	...	...	...	...	...	...	...	800 mm
Speed of wheel	...	...	...	...	...	...	...	...	...	...	...	...	...	...	...	...	800 RPM
Max. sawing height...	...	...	...	...	...	...	...	...	...	...	...	...	...	...	...	...	570 mm
Max. sawing width...	...	...	...	...	...	...	...	...	...	...	...	...	...	...	...	...	715 mm
Max. width of sawing blade...	...	...	...	...	...	...	...	...	...	...	...	...	...	...	...	...	35 mm
Work table	...	...	...	...	...	...	...	...	...	...	...	...	...	...	...	...	940 x 790 mm
Max. inclination of table	...	...	...	...	...	...	...	...	...	...	...	...	...	...	...	...	40°
Electric Motor																	
Power	...	...	...	...	...	...	...	...	...	...	...	...	...	...	...	...	4 - 5 KW
Speed	...	...	...	...	...	...	...	...	...	...	...	...	...	...	...	...	1500 RPM
Overall dimension	...	...	...	...	...	...	...	...	...	...	...	...	...	...	...	...	1809 x 943 x 2650 mm
Weight	...	...	...	...	...	...	...	...	...	...	...	...	...	...	...	...	920 kg. (approx)

*N.B.—For improvement of the machine, we reserve the right to alter either the design or the specification.*

CODE: RT - 3001

“飛人”牌146-1型縫袋用縫紉機  
(用於縫麵粉袋食糖袋及其他谷物袋的封口)

BAG CLOSING MACHINE  
“FLYING MAN” MODEL 146-1

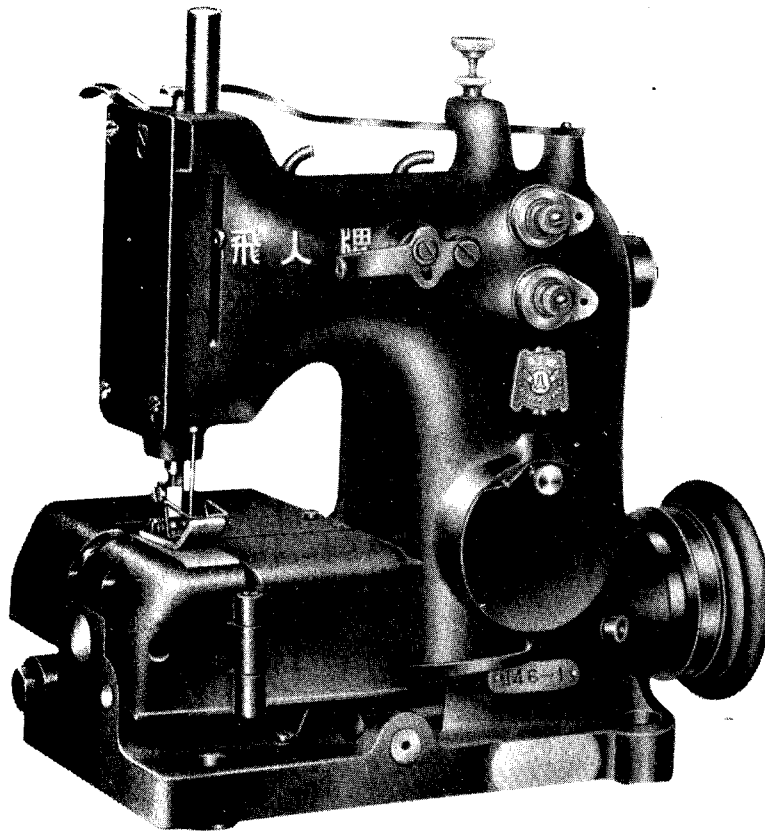

中國運輸機械進口公司經售

Exported by CHINA NATIONAL TRANSPORT MACHINERY IMPORT CORPORATION

香港代理處：華潤公司

Hong Kong Agency: CHINA RESOURCES CO.

BANK OF CHINA BUILDING  
HONG KONG

CABLE ADDRESS: "CIRECO."

This model is designed for closing filled bags containing sugar, flour, grain or other products which are usually packed in bags.

The machine makes two-thread chain stitch, so that strong and elastic seams can be produced to tightly close the bags, thus preventing commodities from leaking out at the seams despite rough handling in transportation.

The machine is equipped with an adjustable conveyor, upon the moving belt of which the filled bags are placed. The bags are thus carried to the operator who guides them through the machine for stitching.

Bags measuring from 20 cm. to 85 cm. from the bottom of the bag to the line of stitching, can be handled on the machine, the conveyor being raised or lowered by turning two handles at the back of the machine to accommodate the various sizes of the bags. As the conveyor belt is 30 cm. wide, bags up to 40 cm. in thickness can be sewn.

The conveyor is capable of carrying three 100-pound bags at the same time or the equivalent weight in as many bags as can be accommodated on the conveyor belt.

The sewing machine head being mounted on a hinged frame can be raised or lowered by a hand wheel, thus slight variation in the height of the bags of the same capacity can be taken care of without adjusting the conveyor.

The machine is equipped with a shear which can be used to cut the thread after each bag is stitched. The shear is operated by a hand lever.

Length of stitch	12 mm.
Maximum sewing speed	1800 stitches per minute
Working space under arm	85 x 70 mm.
Overall dimension (L x W x H) of sewing head	300 x 360 x 260 mm.
Thickness of material sewn	8 mm.
Power required	1 HP.
Efficiency (approx.)	500 bags per working hour
Overall dimension of machine with conveyor (L x W x H)	1200 x 1200 x 2000 mm.

#### Packing Information

Contents	Approximate Weight (kgs)		Approximate Measurement (cm)
	Nett	Gross	
1 set Head	19	25	44 x 32 x 46
1 set Head & Conveyor	529	765	158 x 135 x 183

*N.B.--For improvement of the machine, we reserve the right to alter either the design or the specification.*

CODE: RT - 3002

“飛人”牌124型縫袋用縫紉機  
(用於紙麻棉製袋的封口適用於水泥廠化工廠製袋廠用)

GUNNY BAG CAP SEWING MACHINE  
“FLYING MAN” MODEL 124

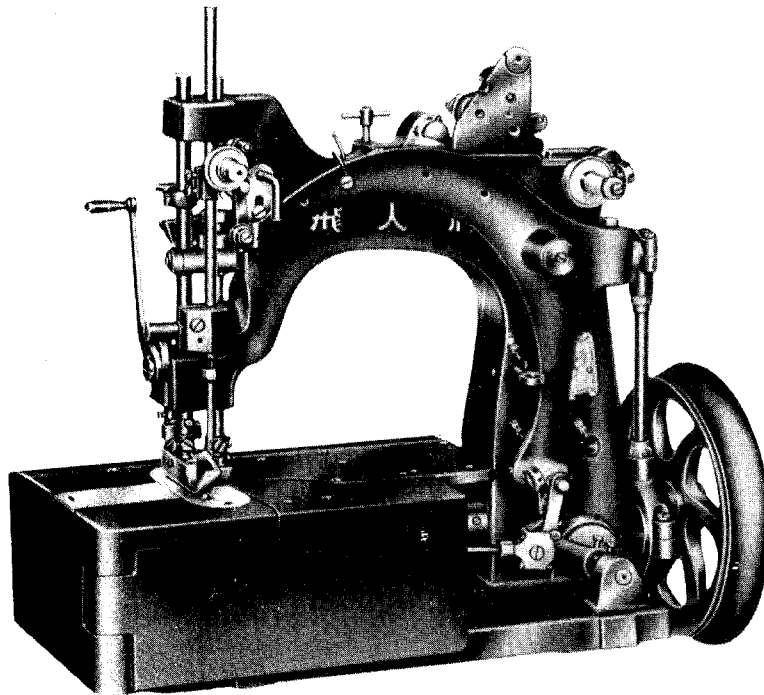

中國運輸機械進口公司經售

Exported by CHINA NATIONAL TRANSPORT MACHINERY IMPORT CORPORATION

香港代理處：華潤公司

Hong Kong Agency: CHINA RESOURCES CO.

BANK OF CHINA BUILDING  
HONG KONG

CABLE ADDRESS: "CIRECO."



This is the most powerful machine for making bags from burlaps and other heavy weight fabrics. It sews the bags either with single thread or two-thread chain stitch producing strong seams.

The machine is fitted with a positive drop feed and two separately hinged compensating presser feet, which ensure its successful operation on all grades of bag materials. This arrangement is particularly effective when hemming bags, as one of the presser feet rests upon the hem while the other rests on the body of the bag, each foot yielding independently according to the thickness of the work being sewn. A knee press for raising or lowering the presser feet is provided with each machine, enabling operator to use both hands in manipulating the work.

For convenience in threading the looper and to facilitate the making of adjustments, the front portion of the cloth plate is hinged so that it can be turned aside to permit easy access to the mechanism in the bed of the machine.

The machine is provided with an iron base which receives the dirt and surplus oil, thus helping to prevent the bags from becoming soiled while they are being sewn.

Length of stitch	12 mm.
Maximum sewing speed	1400 stitches per minute
Thickness of material sewn	15 mm.
Working space under arm	180 x 130 mm.
Overall dimension (L x W x H)	430 x 205 x 385 mm.
Power required	$\frac{1}{2}$ HP.

#### Packing Information

Contents	Approximate Weight (kgs)		Approximate Measurement (cm)
	Nett	Gross	
1 set Head	28 $\frac{1}{2}$	40 $\frac{1}{2}$	48 x 25 $\frac{1}{2}$ x 43 $\frac{1}{2}$

*N.B.—For improvement of the machine, we reserve the right to alter either the design or the specification.*

CODE: RT - 3009

“標準”牌69-41型工業用縫紉機

LOCKSTITCH SEWING MACHINE

“TYPICAL” MODEL 96 - 41

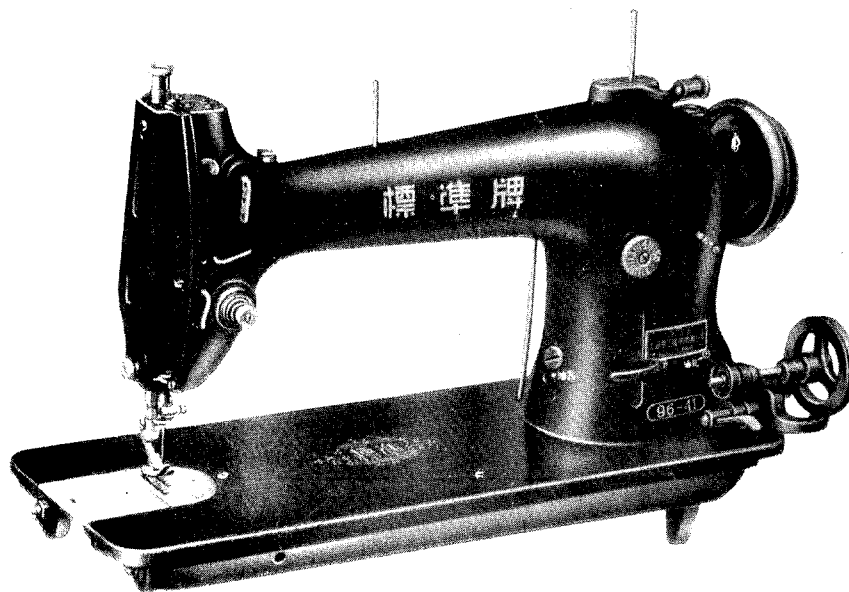

中國運輸機械進口公司經售

Exported by CHINA NATIONAL TRANSPORT MACHINERY IMPORT CORPORATION

香港代理處：華潤公司

Hong Kong Agency: CHINA RESOURCES CO.

BANK OF CHINA BUILDING  
HONG KONG

CABLE ADDRESS: "CIRECO."

Model 96 - 4 I is a single needle industrial machine for sewing with a straight lock-stitch. The shuttle is driven by gears and provided with a reversible feed.

When operating at the highest speed, the machine runs smoothly without appreciable vibration. All components are made of first grade materials, the moving parts being of heat treated steel. The machine is suitable for weaving mills or uniform factories, and for manufacture of shirts and underwears.

The machine can be supplied with either treadle drive stand or electric drive stand, in the latter case it is fitted with a knee press by which the presser foot can be raised when the operator's hands are engaged.

Length of stitch	4 mm.
Maximum sewing speed	2500 stitches per minute
Working space under arm	265 x 165 mm.
Thickness of material sewn	7 mm.
Power required	$\frac{1}{4}$ H.

#### Packjng Information

Contents	Approximate Weight (kgs)		Approximate Measurement (cm)
	Nett	Gross	
Treadle Stand	55	83	164 x 103 x 69
Head	23	33	62 x 28 x 46

*N.B.—For improvement of the machine we reserve the right to alter either the design or the specification.*

CODE: RT - 3007

“飛人”牌45K-50型工業用縫紉機  
(供印刷廠訂書用亦適用於皮革及篷帆製品)

LOCKSTITCH SEWING MACHINE  
“FLYING MAN” MODEL 45K-50

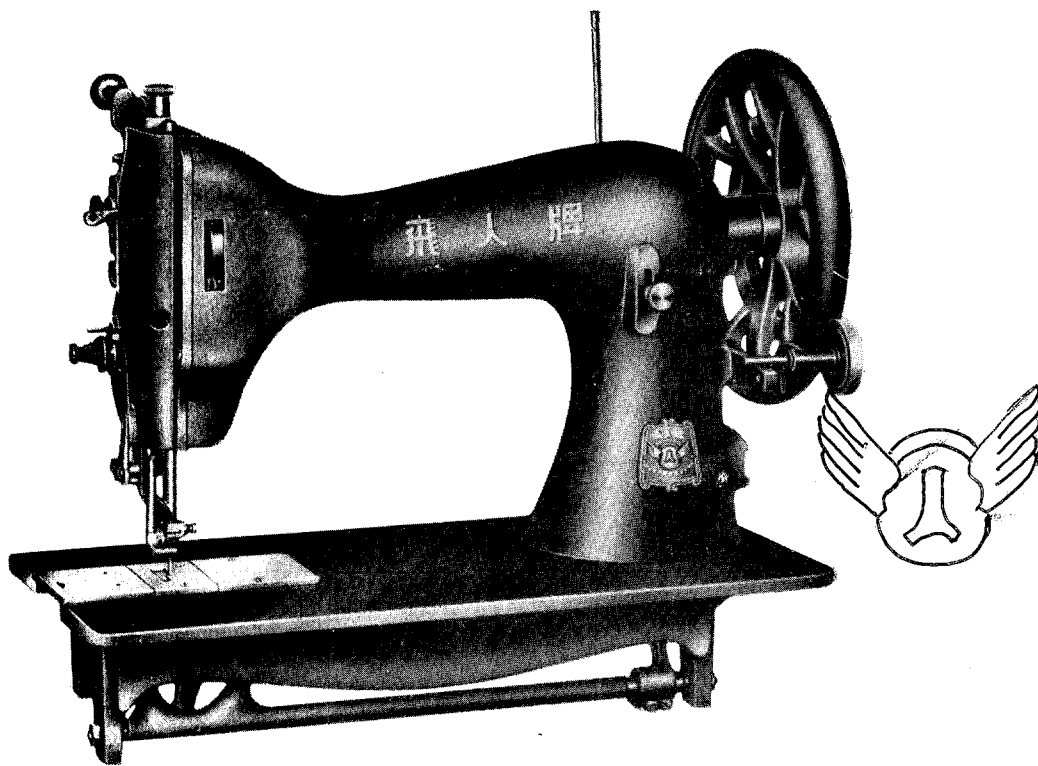

中國運輸機械進口公司經售

Exported by CHINA NATIONAL TRANSPORT MACHINERY IMPORT CORPORATION

香港代理處：華潤公司

Hong Kong Agency: CHINA RESOURCES CO.

BANK OF CHINA BUILDING

HONG KONG

CABLE ADDRESS: "CIRECO."

Model 45K-50 embodies the latest improvement in design. Its sturdy construction ensures durability and long serviceable life. All moving parts, made of high grade steel, are hardened and precision ground.

The machine is especially suitable for sewing heavy canvas or leather goods, as used in the manufacture of wagon covers, sails, heavy sacks, upholsteries, leather belts and other leather handicrafts.

It is fitted with an exceptionally large cylinder shuttle of the oscillating type having a bobbin of great thread capacity which feature makes the machine specially adaptable for mass production.

This model is in all respects same as Model 45K-25 except that it is fitted with a vibrating presser. In this form of presser, the presser foot moves forward at each stitch in unison with the feed, rises and automatically returns to its former position, thus ensuring a uniform and perfect feed when stitching fabrics of uneven or adhesive surfaces. It is also particularly effective when stitching materials are liable to pucker such as book binding, etc. The machine sews with a long, firm and tightly drawn lock-stitch.

Being light running, the machine can be easily operated by foot in which case it is supplied with a treadle drive stand and a two-speed drive wheel for regulating the sewing speed. For mass production, the machine can be supplied with an electric drive stand and a knee press by which the presser foot can be raised while the operator's hands are engaged.

Length of stitch	12 mm.
Sewing speed	350 - 1000 stitches per minute
Thickness of material sewn	12 mm.
Working space under arm	275 x 185 mm.
Power required	$\frac{1}{2}$ HP.

#### Packing Information

Contents	Approximate Weight (kgs)		Approximate Measurement (cm)
	Nett	Gross	
1 set Head	44	60	

*N.B.—For improvement of the machine, we reserve the right to alter either the design or the specification.*

: RT - 3004

“飛人”牌44-13型雙線連鎖縫紉機  
(供服裝工廠用)

CENTRAL BOBBIN SEWING MACHINE  
(WITH OSCILLATING SHUTTLE)  
“FLYING MAN” MODELE 44-13

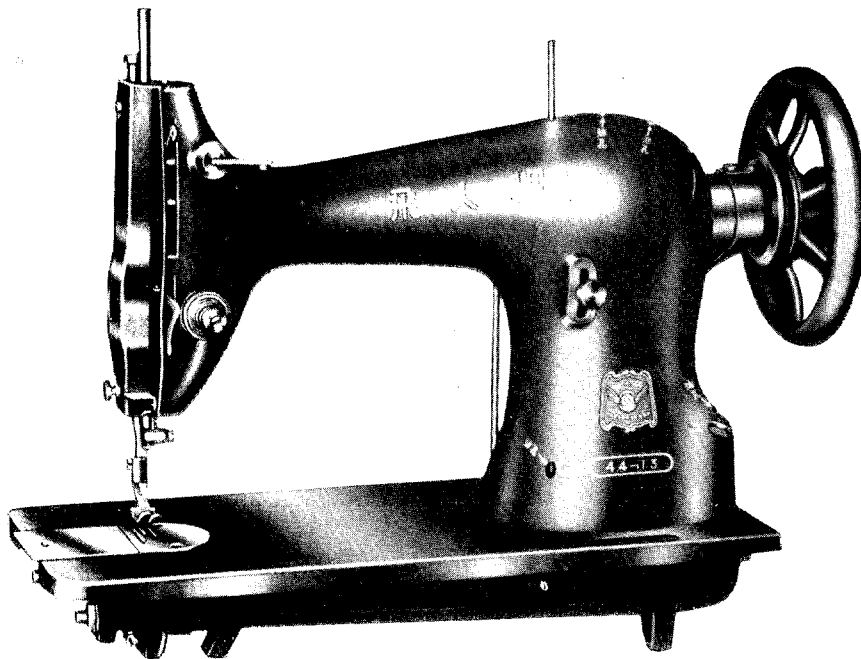

中國運輸機械進口公司經售

Exported by CHINA NATIONAL TRANSPORT MACHINERY IMPORT CORPORATION

香港代理處：華潤公司

Hong Kong Agency: CHINA RESOURCES CO.

BANK OF CHINA BUILDING

HONG KONG

CABLE ADDRESS: "CIRECO."

This is an indispensable machine for industrial use. The maximum speed is about 2000 stitches per minute. Aside from sewing light and medium weight fabrics, it also sews heavy weight materials such as canvas, leather, etc., and is especially suitable for mass production.

The machine shows the most judicious use of materials to resist strain and secure absolute stability. All running parts are carefully balanced so that there is no vibration to cause unusual wear of parts.

The machine can be supplied with either treadle drive stand or electric drive stand, in the latter case it is fitted with a knee press by which the presser foot can be raised when the operator's hands are engaged.

Length of stitch	4.5 mm.
Maximum sewing speed	2000 stitches per minute
Thickness of material sewn	5 mm.
Working space under arm	265 x 145 mm.
Power required	$\frac{1}{4}$ HP.
Stand	Treadle or Power

#### Packing Information

Contents	Approximate Weight (kgs)		Approximate Measurement (cm)
	Nett	Gross	
2 sets Head	39	49	55 x 45 x 43
2 sets Table & Stand	70	86	101 x 76 x 33

*N.B.—For improvement of the machine, we reserve the right to alter either the design or the specification.*

CODE: RT - 3003

“飛人”牌61300型工業用縫紉機  
(供被服廠針織廠縫製棉毛織物服裝用)

LOCKSTITCH SEWING MACHINE  
“FLYING MAN” MODEL 61300

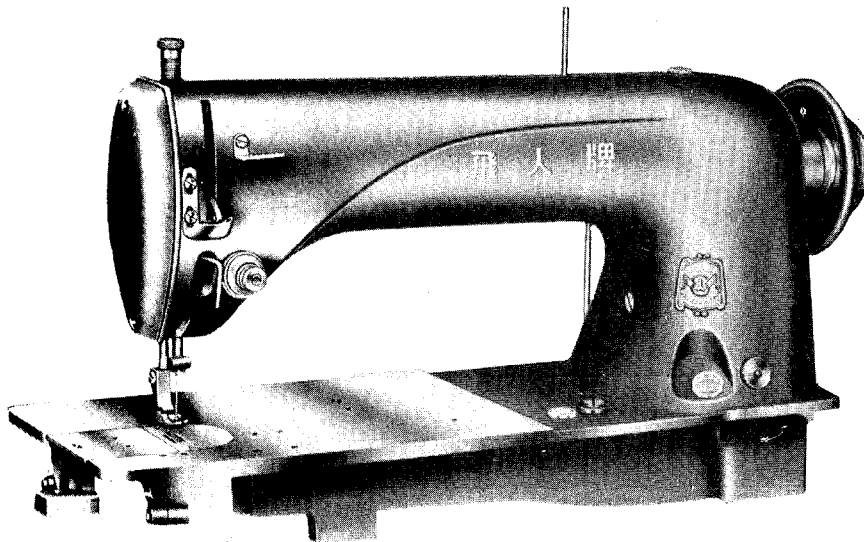

中國運輸機械進口公司經售

Exported by CHINA NATIONAL TRANSPORT MACHINERY IMPORT CORPORATION

香港代理處：華潤公司

Hong Kong Agency: CHINA RESOURCES CO.

BANK OF CHINA BUILDING  
HONG KONG

CABLE ADDRESS: "CIRECO."



This machine can be used advantageously in blanket factories, underwear factories, knitting mills and clothing factories for sewing cotton or woollen underwears and outerwears.

Constructed for two-thread lockstitch sewing, the main shaft runs at a very high speed of about 4000 stitches per minute, power being transmitted by canvas laminated bakelite gears ensuring smooth and silent running.

The essential working parts are heat treated and precision ground thereby minimizing friction and wear, so that these parts are very durable.

By means of automatic lubrication, oil is continuously feed into the essential working parts so that the machine has a long serviceable life. An oil level gauge is provided for frequent inspection of the oil contents. The oil can be changed once every six months of continuous operation.

The machine is equipped with thread take-up and knee-press for raising presser-foot.

Length of stitch	4.5 mm.
Maximum sewing speed	4000 stitches per minute
Thickness of material sewn	5 mm.
Working space under arm	275 x 110 mm.
Overall dimension	510 x 20 x 290 mm.
Power required	$\frac{1}{4}$ HP.
Stand	Electric or treadle drive

#### Packing Information

Contents	Approximate Weight (kgs)		Approximate Measurement (cm)
	Nett	Gross	
1 set Head	30	42	66 x 35 x 42

*N.B.—For improvement of the machine, we reserve the right to alter either the design or the specification.*

CODE: RT - 3006

“飛人”牌45K-25型工業用縫紉機  
(供縫製皮革篷帆布及布鞋底用)

CYLINDER ARM SEWING MACHINE  
“FLYING MAN” MODEL 45K-25

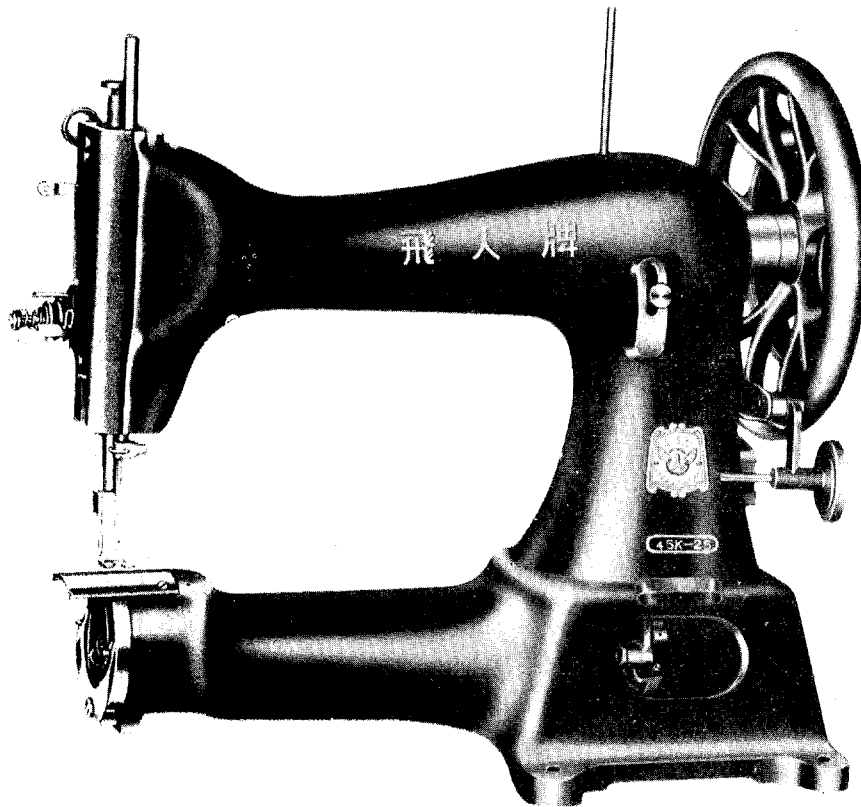

中國運輸機械進口公司經售

Exported by CHINA NATIONAL TRANSPORT MACHINERY IMPORT CORPORATION

香港代理處：華潤公司

Hong Kong Agency: CHINA RESOURCES CO.

BANK OF CHINA BUILDING

HONG KONG

CABLE ADDRESS: "CIRECO."

This machine is strongly built and specially designed for the manufacture of heavy canvas sacks, leather shoes and leather goods, etc. It makes a long, firm and tightly drawn lock-stitch.

The machine is fitted with a large cylinder shuttle of oscillating type, light running and easy to operate by treadle drive in which case it can be provided with a heavy balanced two-speed driving wheel to ensure great penetrating power and to permit change of the sewing speed to adapt it for various kinds of work. For use on power bench, the machine can be fitted with a knee press by which the presser foot can be raised while the operator's hands are engaged.

Length of stitch	7 mm.
Sewing speed	350 - 1000 stitches per minute
Thickness of material sewn	Leather 10 mm.
Working space under arm	275 x 185 mm.
Overall dimension (L x W x H)	530 x 270 x 480 mm.
Power required	$\frac{1}{2}$ HP.
Stand	Treadle or Power

#### Packing Information

Contents	Approximate Weight (kgs)		Approximate Measurement (cm)
	Nett	Gross	
1 set Head	3.5	52	67 x 39 x 62
1 " Table			
& Stand	60	84	135 x 72 x 31
1 set Wheel	10	20	44 x 37 x 40

*N.B.—For improvement of the machine, we reserve the right to alter either the design or the specification.*

**CHINA NATIONAL INSTRUMENTS IMPORT CORPORATION**

**HEAD OFFICE:**

Er-Li-Kou, Hsi Chiao, Peking, China.  
Cable Address: "INSTRIMP"

**BRANCH OFFICES:**

SHANGHAI: 27 Chungshan Road (E.I).  
Cable Address: "INSTRIMP"  
TIENTSIN: 171 Kien Shieh Road.  
Cable Address: "INSTRIMP"  
CANTON: 25 Tai Ping Road, S.  
Cable Address: "INSTRIMP"

# MOUSE

## Tubular paper condenser

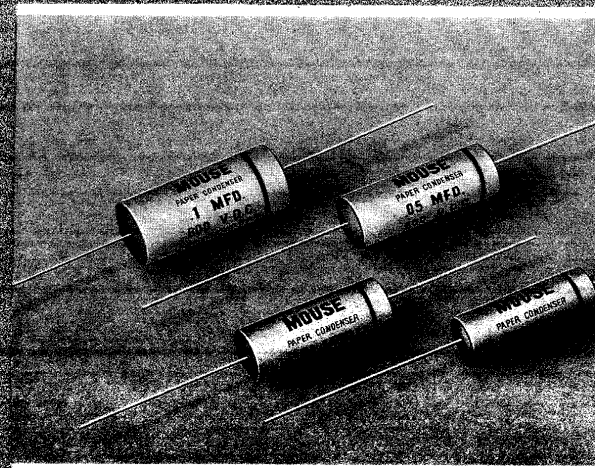

中國儀器進口公司

**"MOUSE" TUBULAR PAPER CONDENSER**

"MOUSE" Paper capacitors are sealed tight against moisture by a distinctive wax-molding process. This treatment assures longer life expectancy than ever before attained for wax sealed tubular paper capacitors.

The foil and paper employed in these capacitors are pre-tested for uniformly high quality, and winding are thoroughly impregnated. The hot-soldered tinned-copper leads provide a firm support for mounting.

Voltage ratings are consistent with the quality workmanship incorporated in this unique design. An especially important characteristic is their ability to give outstanding performance under high humidity service conditions.

Impregnation: Wax impregnated.

Terminals: Solid, tinned copper wire.

Lead sizes No. 22 SWG  
No. 21 SWG  
No. 20 SWG

Case Seal: External overall wax dip.

Markings: Type designation, capacitance, and voltage rating printed on tube.

Capacitance Tolerance:  $\pm 10\%$ . Special tolerances available upon request.

Insulation Resistance: 2000 megohms minimum.

Conservative D.C. Rating: Tested at 1200 volts D.C.

Catalog No.	Capacity Mfd.	Diameter	Length
ST-6T1	.0001	11 m/m	36 m/m
ST-6T2	.0002	" "	" "
ST-6T25	.00025	" "	" "
ST-6T5	.0005	" "	" "
ST-6D1	.001	" "	" "
ST-6D2	.002	" "	" "
ST-6D25	.0025	" "	" "
ST-6D3	.003	" "	" "
ST-6D4	.004	" "	" "
ST-6D5	.005	14 "	39 "
ST-6D6	.006	" "	" "
ST-6D8	.008	" "	" "
ST-6 S1	.01	" "	" "
ST-6 S15	.015	" "	" "
ST-6 S2	.02	" "	" "
ST-6 S3	.03	" "	" "
ST-6 S4	.04	15 "	39 "
ST-6 S5	.05	" "	" "
ST-6 S6	.06	" "	" "
ST-6 P1	.1	19 "	43 "

**I. F. Transformers.**

<u>CODE</u>	<u>DESCRIPTIONS</u>
1490	465 kc. plastic core I. F. Transformer, adjusting range 455-465 kc. Universal wound with litz wire. Connecting terminals fixed on a plastic base, easy for connecting. .....
1470	465 kc. iron core I. F. Transformer, adjusting range 455-465 kc. Litz wire universal wound coils on plastic tubing. Connecting terminals fixed on a plastic base.

**R. F. CHOKE**

<u>CODE</u>	<u>DESCRIPTIONS</u>
250	R. F. Choke 2.5 mh. 50 ma. Coils honey-comb wound on porcelain core. Len. 35 m/m .....
251	R. F. Choke 2.5 mh. 100 ma. (Similar in construction to the R. F. C. above.) Same as 250. .....
256	R. F. Choke Coils honey-comb wound on a stand off porcelain insulator. Inductance values of 1, 2.5 and 5 millihenries are available with a current rating of 600 millamperes.

**Model 300 Simple Receiver Coil**

<u>CODE</u>	<u>DESCRIPTIONS</u>
336	Medium wave broadcast band 3 circuits regenerative coil, made for all types of triode and pentode tubes, universal wound on paper form of 16 m/m in diameter and 42 m/m in length. All coils are sealed with wax. .....
338	Crystal receiving set coils. Set of two used with ganged condenser, best for its selectivity and sensibility. It can be used either double circuits or single circuit as desire. Universal wound by litz wire on paper form, 16 m/m in dia. and 42 m/m in len. All coils sealed with wax.

STAT

**BESTONE RADIO COIL MFG.**

SHANGHAI, CHINA.

CATALOGUE

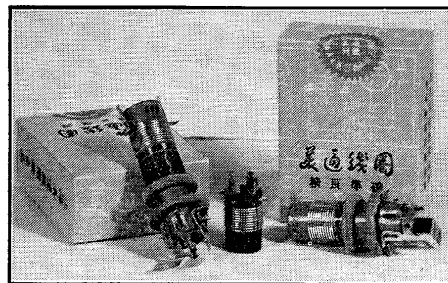

Exported by:

China National Instruments Import Corporation.

Shanghai, China.

**Model 500 Paper Form Superheterodyne Circuit Receiver Coil**

<u>CODE</u>	<u>DESCRIPTIONS</u>
5 5 1	Medium wave broadcasting band coil, for 6SA7 converter. Every set containing one antenna coil and one oscillator coil. Frequency range: 550-1650 kc. Paper form: dia. 12.5 m/m. len. 31 m/m. Antenna coil secondary universal wound by litz wire. Coils sealed with wax. .....
5 5 2	Medium wave broadcasting band coil, for 6A8, 6K8, 1A7GT, 1LA6 and 1R5 converters. Frequency range and other specifications same as 551. .....
5 5 3	Made for Medium and short wave bands of 6SA7 converter. Every set containing one antenna coil and one oscillator coil. Frequency range: 550-1650 kc. 6-18 mc. Paper form dia. 16 m/m. len. 48.5 m/m. Medium wave antenna coil secondary universal wound by litz wire. Coils sealed with wax. .....
5 5 4	Two bands coil, made for 6A8, 6K8, 1A7GT, 1LA6, 1LC6 and 1R5 converters. Frequency range and other specifications same as 553. .....
5 5 5	Three bands coil, for 6SA7 converters. Every set containing one antenna coil and one oscillator coil. Frequency covered in the three bands: 550-1650 kc. 2.2-7.5 mc. 7-22 mc. Paper form dia. 16 m/m. len. 56 m/m. Coils sealed with wax. .....
5 5 6	Three bands coil, for 6A8, 6K8, 1A7GT, 1LA6, 1LC6 and 1R5 converters. Frequency range and other specifications same as 555. .....
5 5 7	Two bands high frequency coil, made for 6K7, 6SK7 and 1T4 high frequency amplifiers, should be used with 553, 554. Frequency range and other specifications same as the antenna coil of 553 & 554. .....
5 5 8	Three bands high frequency coil, made for 6K7, 6SK7 and 1T4 high frequency amplifiers, should be used with 555, 556. Frequency range and other specifications same as the antenna coil of 555 & 556.

**Model 600 Bakelite form Superheterodyne Circuit Receiver Coil**

<u>CODE</u>	<u>DESCRIPTIONS</u>
6 1 0	Medium wave broadcasting band coil, Every set containing one antenna coil and one oscillator coil. Frequency range 550-1650 kc. For fitting in the characteristics of all type of converters, the coil may divide into four forms: 610-S for 6SA7      610-A for 6A8, 1A7GT 610-K for 6K8      610-R for 1R5 Coil form dia. 16 m/m. len. 25 m/m. Antenna coil secondary universal wound by litz wire. Connecting terminals besides the number, have colored sign for distinguishing. .....
6 2 0	Short wave band coil, every set containing one antenna coil and one oscillator coil. Frequency range 2.2-7.5 mc. The coil also divided into four forms: 620-S, 620-A, 620-K, 620-R. Antenna coil secondary closely wound with No. 30 enameled wire, others same as 610. .....
6 3 0	Short wave band coil, every set containing one antenna coil and one oscillator coil. Frequency range 7-22 mc. The coil also divided into four forms: 630-S, 630-A, 630-K, 630-R. Antenna coil secondary closely wound with No. 24 silver plated wire, other specifications same as 610. .....
6 4 0	Short wave band coil, every set containing one antenna coil and one oscillator coil. Frequency range 6-18 mc. The coil also divided into four forms: 640-S, 640-A, 640-K, 640-R. Method of winding and other specifications same as 630. .....
610-RF	Medium wave broadcasting band RF coil, made for 6K7, 6SK7 and 1T4 high frequency amplifiers, should be used with any form of 610. Frequency range and other specifications same as 610. .....
620-RF	Short wave band RF coil, made for 6K7, 6SK7 and 1T4 high frequency amplifiers, should be used with any form of 620. Frequency range and other specifications same as 620. .....
630-RF	Short wave band RF coil, made for 6K7, 6SK7 and 1T4 high frequency amplifiers, should be used with any form of 630. Frequency range and other specifications same as 630. .....
640-RF	Short wave band RF coil, made for 6K7, 6SK7 and 1T4 high frequency amplifiers, should be used with any form of 640. Frequency range and other specifications same as 640.

25X1

**Page Denied**