

INFORMATION REPORT INFORMATION REPORT

CENTRAL INTELLIGENCE AGENCY

This material contains information affecting the National Defense of the United States within the meaning of the Espionage Laws, Title 18, U.S.C. Secs. 793 and 794, the transmission or revelation of which in any manner to an unauthorized person is prohibited by law.

~~C-O-N-F-I-D-E-N-T-I-A-L~~

50X1-HUM

COUNTRY	Rumania/USSR	REPORT	
SUBJECT	Rumanian and Soviet Installation Date in Rumania	DATE DISTR.	20 February 1959
		NO. PAGES	117
		REFERENCES	RD
DATE OF INFO.			50X1-HUM
PLACE & DATE ACQ.			

SOURCE EVALUATIONS ARE DEFINITIVE. APPRAISAL OF CONTENT IS TENTATIVE.

50X1-HUM

~~C-O-N-F-I-D-E-N-T-I-A-L~~

STATE #	<input checked="" type="checkbox"/> ARMY #	<input checked="" type="checkbox"/> NAVY #	<input checked="" type="checkbox"/> AIR #	<input checked="" type="checkbox"/> FBI	AEC					
---------	--	--	---	---	-----	--	--	--	--	--

(Note: Washington distribution indicated by "X"; Field distribution by "#".)

INFORMATION REPORT INFORMATION REPORT

50X1-HUM

C-O-N-F-I-D-E-N-T-I-A-L

REPORT

COUNTRY Rumania

DATE DISTR. 31 JAN. 1959

SUBJECT Rumanian and Soviet Installation Data in Rumania

NO. OF PAGES 146

DATE OF INFORMATION

REFERENCES:

50X1-HUM

PLACE ACQUIRED

THIS IS UNEVALUATED INFORMATION

50X1-HUM

C-O-N-F-I-D-E-N-T-I-A-L

CONFIDENTIAL

50X1-HUM

-2-

RUMANIAN AND SOVIET INSTALLATION DATA IN RUMANIA (C)**Introduction**

50X1-HUM

This report contains [redacted] information on Rumanian and Soviet military installations in Rumania [redacted]

Included in this report are several installations of the security police, civil police, and fire department of Rumania. Although these installations were not strictly military, [redacted] they were part of the armed forces of Rumania. [redacted]

The following is a list of locations referred to in this report, with coordinates for each:

<u>Location</u>	<u>Geographic</u>	<u>UTM</u>
BAIA MARE	N47-40, E23-35	FT-9482
BANEASA	N44-05, E27-45	NJ-5679
BASARAB (formerly MURFLA-TAR)	N44-10, E28-23	PJ-1292
BASCOV	N44-54, E24-49	LK-2874
CARMEN-SYLVA	N44-03, E28-39	PJ-3375
CETATE	N44-06, E23-03	FP-6485
CHOMUTOV	N50-27, E13-26	UR-8891
COBADIN	N44-05, E28-13	NJ-9980
CURTEA-DE ARGES	N45-08, E24-42	LL-1701
DENTA	N45-22, E21-15	UTM coordinates not available
GAESTI	N44-42, E25-18	LK-6552
GIURGIU	N43-53, E25-57	MJ-1762
GOGOS	N44-23, E22-35	FQ-2715
ORSOVA	N44-43, E22-15	FQ-1354
MEDJIDIA	N44-15, E28-18	PK-0200
PITESTI	N44-51, E24-51	LK-3270
RAZVANI	N44-25, E26-52	MK-8720
TARGU-JIU	N45-03, E23-17	FQ-8190
TURNU-SEVERIN	N44-38, E22-40	FQ-3244
VANJU-MARE	N44-25, E22-52	FQ-4921

CONFIDENTIAL

CONFIDENTIAL

-3-

50X1-HUM

Listing of Annexes

RUMANIAN INSTALLATIONS	<u>Page Nr.</u>
Annex A: Pinpoint Locations of Military Installations in BUCHAREST, Rumania	8
Annex B: <input type="checkbox"/> Sketch of Casern Occupied by Unidentified Engineer Regiment and Unidentified Artillery Regiment in BUCHAREST, Rumania (See item 3, Annex A)	10 50X1-HUM
Annex C: <input type="checkbox"/> Sketch of Casern Occupied by the 2d Tank Regt and Local and Regional Military Commission in BUCHAREST, Rumania (See items 5 and 6, Annex A)	12 50X1-HUM
Annex D: <input type="checkbox"/> Sketch of Casern Occupied by Unidentified Military Hospital in BUCHAREST, Rumania (See item 7, Annex A)	14 50X1-HUM
Annex E: <input type="checkbox"/> Sketch of Casern Occupied by Border Guard Headquarters in BUCHAREST, Rumania (See item 8, Annex A)	16 50X1-HUM
Annex F: <input type="checkbox"/> Sketch of Casern Occupied by Unidentified Military Repair Shop for Vehicles and Weapons in BUCHAREST, Rumania (See item 9, Annex A)	18 50X1-HUM
Annex G: <input type="checkbox"/> Sketch of Casern Occupied by Tudor Vladimirescu (TV) Infantry Division in BUCHAREST, Rumania (See item 10, Annex A)	20 50X1-HUM
Annex H: <input type="checkbox"/> Sketch of Military Academy in BUCHAREST, Rumania (See item 11, Annex A)	22 50X1-HUM
Annex I: Pinpoint Location of Military Installations in BUCHAREST, Rumania	23
Annex J: <input type="checkbox"/> Sketch of Casern Occupied by 4th Trans Bn in BUCHAREST, Rumania (See item 1, Annex I)	24 50X1-HUM
Annex K: <input type="checkbox"/> Sketch of Casern Occupied by Unidentified Military Vehicle and Tank Repair Shop in BUCHAREST, Rumania (See item 3, Annex I)	26 50X1-HUM
Annex L: Pinpoint Locations of Military Installations in BUCHAREST, Rumania	28
Annex M: <input type="checkbox"/> Sketch of Caserns Occupied by Headquarters Civil Police (Militie) of Rumania in BUCHAREST (See item 4 and 5, Annex L)	30 50X1-HUM
Annex N: <input type="checkbox"/> Sketch of Casern Occupied by the Headquarters of the Fire Department of Rumania in BUCHAREST (See item 6, Annex L)	32 50X1-HUM
Annex O: Pinpoint Location of Military Installations in TURNU-SEVERIN, Rumania	33
Annex P: <input type="checkbox"/> Sketch of Casern Occupied by the Security Police (Securitate) and <input type="checkbox"/> Sketch of State Prison in TURNU-SEVERIN, Rumania (See figures 1 and 2, Annex O)	34 50X1-HUM 50X1-HUM

CONFIDENTIAL

CONFIDENTIAL

-4-



50X1-HUM

Page Nr.

Annex Q: Pinpoint Locations of Military Installations in TURNU-SEVERIN, Rumania	37	
Annex R: <input type="checkbox"/> Sketch of Casern Occupied by Headquarters, 9th Border Guard Regt in TURNU-SEVERIN, Rumania (See item 1, Annex Q)	38	50X1-HUM
Annex S: <input type="checkbox"/> Sketch of Casern Occupied by Unidentified Infantry Regiment and Underground Munition Storage Area in TURNU-SEVERIN, Rumania (See item 2, Annex Q)	41	50X1-HUM
Annex T: <input type="checkbox"/> Sketch of Casern Occupied by Unidentified Motorized Artillery Regiment in TURNU-SEVERIN, Rumania (See item 4, Annex Q)	43	50X1-HUM
Annex U: <input type="checkbox"/> Sketch of Casern Occupied by Unidentified Underground Ammunition Storage Area in TURNU-SEVERIN, Rumania (See item, 5, Annex Q)	45	50X1-HUM
Annex V: <input type="checkbox"/> Sketch of Military Railway Siding and Warehouses in TURNU-SEVERIN, Rumania (See item 6, Annex Q)	47	50X1-HUM
Annex W: <input type="checkbox"/> Sketch of Casern Occupied by Unidentified Border Guard Battalion in TURNU-SEVERIN, Rumania	49	50X1-HUM
Annex X: <input type="checkbox"/> Sketch of Casern Occupied by Unidentified Border Guard Battalion in ORSOVA, Rumania	51	50X1-HUM
Annex Y: <input type="checkbox"/> Sketch of Casern Occupied by an Unidentified Border Guard Battalion in GOGOS, Rumania	53	50X1-HUM
Annex Z: Pinpoint Location and <input type="checkbox"/> Sketch of Casern Occupied by Unidentified Border Guard Battalion in CETATE, Rumania	55	50X1-HUM
Annex AA: Pinpoint Location of Unidentified Infantry Regiment and Unidentified Motorized Artillery Regiment in VANJU MARE, Rumania	57	
Annex BB: <input type="checkbox"/> Sketch of Casern Occupied by Unidentified Infantry Regiment and Unidentified Motorized Artillery Regiment in VANJU MARE, Rumania	58	50X1-HUM
Annex CC: Pinpoint Location and <input type="checkbox"/> Sketch of Casern Occupied by the 7th Border Guard Regt in BALA MARE, Rumania	60	50X1-HUM
Annex DD: Pinpoint Locations of Military Installations in Area of PITESTI, Rumania	62	
Annex EE: <input type="checkbox"/> Sketch of Casern Occupied by Unidentified Armored Officers' School in PITESTI, Rumania (See item 1, Annex DD)	63	50X1-HUM
Annex FF: <input type="checkbox"/> Sketch of Casern Occupied by Unidentified Engineer Regiment and Underground Ammunitions Storage Area in BASCOV, Rumania (See items 2 and 3, Annex DD)	65	50X1-HUM
Annex GG: Pinpoint Location of 1st Border Guard Regt in GIURGIU, Rumania	67	
Annex HH: <input type="checkbox"/> Sketch of Casern Occupied by 1st Border Guard Regt in GIURGIU, Rumania	68	50X1-HUM

CONFIDENTIAL

CONFIDENTIAL

-5-

50X1-HUM

Page Nr.

Annex II:	Pinpoint Location of 14th Border Guard Regt in COBADIN, Rumania	70	
Annex JJ:	<input type="checkbox"/> Sketch of Caserns Occupied by the 14th Border Guard Regt in COBADIN, Rumania	71	50X1-HUM
Annex KK:	Pinpoint Location of Unidentified Border Guard Battalion in BANEASA, Rumania	74	
Annex LL:	<input type="checkbox"/> Sketch of Casern Occupied by Unidentified Border Guard Battalion in BANESA, Rumania	75	50X1-HUM
Annex MM:	Pinpoint Location of Unidentified Infantry Regiment and Unidentified Military Prison in TARGU-JIU, Rumania	77	
Annex NN:	<input type="checkbox"/> Sketch of Casern Occupied by Unidentified Infantry Regiment and Unidentified Military Prison in TARGU-JIU, Rumania	78	50X1-HUM
Annex OO:	Pinpoint Location of Ammunition Storage Area near DENTA, Rumania	80	
Annex PP:	<input type="checkbox"/> Sketch of Ammunition Storage Area near DENTA, Rumania	81	50X1-HUM
Annex QQ:	Pinpoint Location of Military Installations in ORADEA, Rumania	83	
Annex RR:	<input type="checkbox"/> Sketch of Casern Occupied by Unidentified Cavalry Regiment in ORADEA, Rumania (See item 1, Annex QQ)	84	50X1-HUM
Annex SS:	<input type="checkbox"/> Sketch of Casern Occupied by Headquarters, 10th Border Guard Regiment in ORADEA, Rumania (See item 2, Annex QQ)	86	50X1-HUM
Annex TT:	<input type="checkbox"/> Sketch of Casern Occupied by the Ministry of Interior Officers' School Number 3 in ORADEA, Rumania (See item 3, Annex QQ)	88	50X1-HUM
Annex UU:	<input type="checkbox"/> Sketch of Casern Occupied by Unidentified Infantry Division in ORADEA, Rumania (See item 4, Annex QQ)	90	50X1-HUM
Annex VV:	<input type="checkbox"/> Sketch of Casern Occupied by Ministry of Interior Officers' School Number 2 in ORADEA, Rumania (See item 5, Annex QQ)	93	50X1-HUM
Annex WW:	Pinpoint Location of Military Installations in ORADEA, Rumania	95	
Annex XX:	<input type="checkbox"/> Sketch of Casern Occupied by Unidentified Artillery Regiment and Unidentified Engineer Regiment in ORADEA, Rumania (See item 2, Annex WW)	96	50X1-HUM
Annex YY:	<input type="checkbox"/> Sketch of Ocorhei Firing Range in ORADEA, Rumania (See item 3, Annex WW)	98	50X1-HUM
Annex ZZ:	Pinpoint Location of Military Installations in CRAIOVA, Rumania	100	

CONFIDENTIAL

CONFIDENTIAL

-6-

50X1-HUM

Page Nr.

Annex AAA:	<input type="checkbox"/> Sketch of Casern Occupied by a Segment of the 8th Trans Bn in CRAIOVA, Rumania (See item 1, Annex ZZ.)	101	50X1-HUM
Annex BBB:	<input type="checkbox"/> Sketch of Casern Occupied by the 21st Inf Regt and a Segment of the 8th Trans Bn in CRAIOVA, Rumania (See item 2, Annex ZZ)	103	50X1-HUM
Annex CCC:	<input type="checkbox"/> Sketch of Casern Occupied by Headquarters, Horiea, Closea Si Crisan (HCC) Inf Div in CRAIOVA, Rumania (See item 3, Annex ZZ)	106	50X1-HUM
Annex DDD:	<input type="checkbox"/> Sketch of Casern Occupied by the 1st Heavy Arty Regt in CRAIOVA, Rumania (See item 4, Annex ZZ)	109	50X1-HUM
Annex EEE:	<input type="checkbox"/> Sketch of Casern Occupied by a Segment of the 8th Trans Bn in CRAIOVA, Rumania (See item 5, Annex ZZ)	111	50X1-HUM
Annex FFF:	<input type="checkbox"/> Sketch of Casern Occupied by Automotive Repair Shop Nr 5, 8th Trans Bn in CRAIOVA, Rumania (See item 5a, Annex ZZ)	113	50X1-HUM
Annex GGG:	<input type="checkbox"/> Sketch of Casern Occupied by Security Police Headquarters (Securitate) for District of CRAIOVA, Rumania (See item 6, Annex ZZ)	115	50X1-HUM
Annex HHH:	Pinpoint Location of Military Installations in CONSTANTA, Rumania	117	
Annex III:	<input type="checkbox"/> Sketch of Casern Occupied by Headquarters, 13th Border Guard Regt in CONSTANTA, Rumania (See item 2, Annex HHH)	118	50X1-HUM
Annex JJJ:	<input type="checkbox"/> Sketch of Casern Occupied by Unidentified Border Guard Battalion in CONSTANTA, Rumania (See item 3, Annex HHH)	120	50X1-HUM
Annex KKK:	Pinpoint Location of Unidentified Border Guard Battalion Near CARMEN-SYLVA, Rumania	122	
Annex LLL:	<input type="checkbox"/> Sketch of Casern Occupied by Unidentified Border Guard Battalion Near CARMEN-SYLVA, Rumania	123	50X1-HUM
Annex MMM:	Pinpoint Location of Headquarters, 4th Border Guard Regt in TIMISOARA, Rumania	125	
Annex NNN:	<input type="checkbox"/> Sketch of Casern Occupied by Headquarters, 4th Border Guard Regt in TIMISOARA, Rumania	126	50X1-HUM
Annex OOO:	Pinpoint Location of Two Military Units in GAESTI, Rumania	129	
Annex PPP:	<input type="checkbox"/> Sketch of Rumanian Military Casern at GAESTI, Rumania	130	50X1-HUM
Annex QQQ:	Pinpoint Location of Unidentified Rumanian Army Underground Ammunition Depot Near MEDJIDIA, Rumania	133	
Annex RRR:	Pinpoint Location of Unidentified Underground Rumanian Army Ammunition Depot near Basarabi, Rumania	134	

CONFIDENTIAL

CONFIDENTIAL

-7-

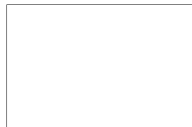

50X1-HUM

SOVIET INSTALLATIONSPage Nr

Annex SSS:	<input type="checkbox"/> Sketch of Unidentified Soviet and Rumanian Military Camp, Rumania	135	50X1-HUM
Annex TTT:	Pinpoint Location of Unidentified Soviet Armored Casern in TIMISOARA, Rumania	137	
Annex UUU:	<input type="checkbox"/> Sketch of Casern Occupied by Unidentified Soviet Armored Unit in TIMISOARA, Rumania	138	50X1-HUM
Annex VVV:	Pinpoint Location of Unidentified Soviet Military Installations in CONSTANTA, Rumania	140	
Annex WWW:	<input type="checkbox"/> Sketch of Casern Occupied by Unidentified Soviet Units in CONSTANTA, Rumania	142	50X1-HUM
Annex XXX:	Pinpoint Location of Unidentified Soviet Army Signal Regiment at RAZVANI, Rumania	145	
Annex YYY:	<input type="checkbox"/> Sketch of Camp of Unidentified Soviet Signal Regiment at RAZVANI, Rumania	146	50X1-HUM

CONFIDENTIAL

Annex A
PINPOINT LOCATIONS OF MILITARY INSTALLATIONS IN BUCHAREST, ROMANIA



CONFIDENTIAL
-8-

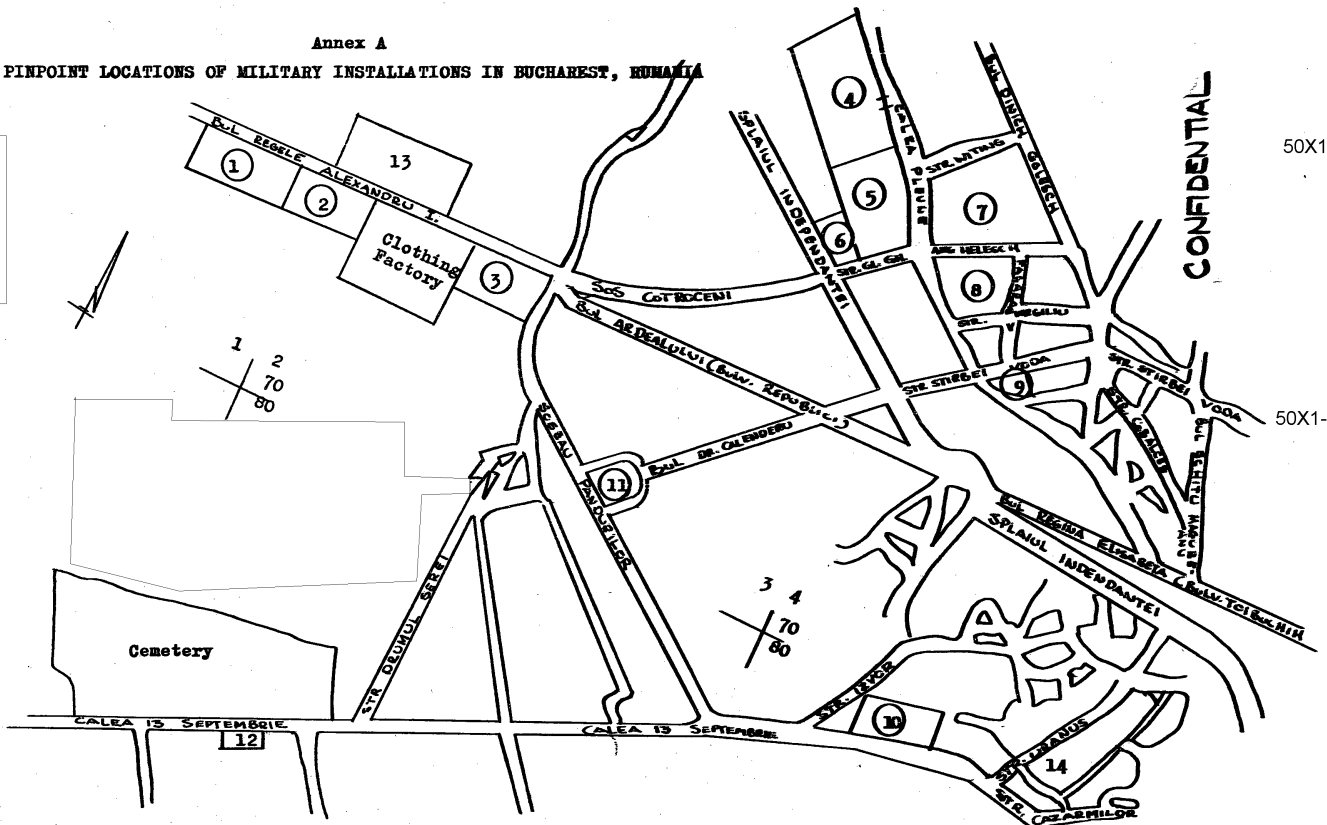

CONFIDENTIAL

50X1-HUM

50X1-HUM

CONFIDENTIAL

-9-

50X1-HUM

Legend to Annex A

50X1-HUM

- 1 and 2. Unidentified caserns located on Bulevardul Regele Alexandru I. [redacted]
[redacted]
[redacted]
officers and EM [redacted] wore the infantry insignia entering and leaving the caserns.
3. Casern occupied by an unidentified engineer regiment and an unidentified artillery regiment.
4. Unidentified casern located on Calea Plevne. [redacted]
[redacted] observed a guard on duty at the main gate and other soldiers entering and leaving this casern; they were wearing the infantry insignia. [redacted] there was a military bakery located in this casern. 50X1-HUM
5. Casern occupied by the 2d Tank Regt.
6. Offices of the regional and local military commissions.
7. Casern occupied by unidentified military hospital.
8. Casern occupied by the Border Guard Headquarters.
9. Repair shop for vehicles and weapons used by the Ministry of Interior.
10. Casern occupied by headquarters of the Tudor Vladimirescu (TV) Infantry Division.
11. Officers' Military Academy.
12. ASAN Military Motor Repair and Motor Parts Factory. [redacted] 50X1-HUM
[redacted] The factory area was 800 to 1000m long, 50X1-HUM
[redacted] In the front of this area was a 50X1-HUM
grey, stucco fence approximately 4 m high, and on the sides of the area were
barbed wire fences approximately 4 m high. [redacted] two entrances, 50X1-HUM
one for pedestrians, approximately 1.5 m wide, and one for vehicles, approx-
imately 8 m wide. A guard shack was erected at both entrances and a mili-
tary guard was on duty at all times. [redacted] four buildings, of 50X1-HUM
unrecalled size, on the northern side and two on the eastern side of the
area. [redacted] 50X1-HUM
13. Military factory for production of explosives (Pirotehnia armatei romane).
[redacted] military and civilian personnel entering the area. A military
guard was posted at the main gate. [redacted] 50X1-HUM
14. Military prison (Inchisoarea militara). [redacted] the front
(along Strada Uranus) of this four-story building [redacted] was approximately
300 x 20 m, of dark grey stucco with a red tile, gable roof. It had small,
barred windows on the upper three floors. In the center of this building
on the first floor was a solid, iron door approximately 7 x 10 m. This
door led through a tunnel to the center of this building where [redacted] 50X1-HUM
[redacted] there was a courtyard. [redacted] 50X1-HUM

CONFIDENTIAL

Annex B

SKETCH OF CASERN OCCUPIED BY UNIDENTIFIED ENGINEER REGIMENT
AND UNIDENTIFIED ARTILLERY REGIMENT IN BUCHAREST, ROMANIA

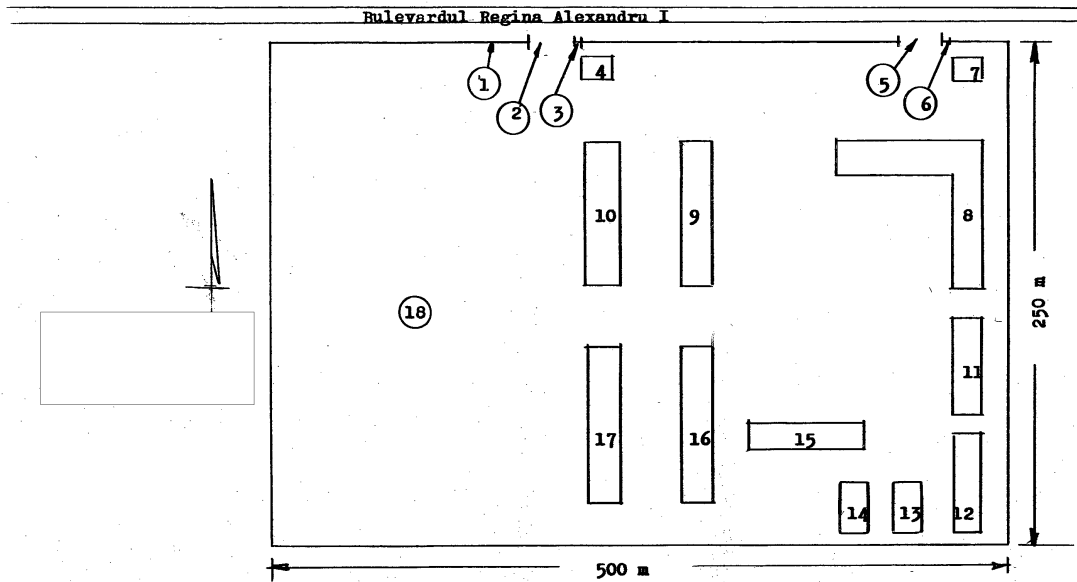

CONFIDENTIAL
-10-

CONFIDENTIAL

50X1-HUM

50X1-HUM

50X1-HUM

CONFIDENTIAL

-11-

50X1-HUM

Legend to Annex B

1. Grey, stucco fence, approximately 3.5 m high.
2. Unpainted, wooden, vehicle gate, approximately 8 m wide and 3.5 m high.
3. Unpainted, wooden, pedestrian gate, approximately 1.5 m wide and 3.5 m high.
4. A one-story guard shack, approximately 10 x 10 m, of white stucco with red tile, gable roof.
5. Same as 2.
6. Same as 3.
7. Same as 4.
8. Headquarters, administrative offices, EM barracks, and mess hall for unidentified engineer regiment in an L-shaped, three-story building approximately 100 m on the eastern side, 80 m on the northern side, and 20 m wide, of white stucco with a tin, gable roof.
9. EM barracks for unidentified engineer regiment in a three-story building, approximately 100 x 15 m, of white stucco with a tin, gable roof.
10. EM barracks for unidentified artillery regiment. Same description as 9.
11. EM barracks for unidentified engineer regiment in a three-story building, approximately 50 x 20 m, of white stucco with a tin, gable roof.
12. Same as 11.
- 13-14. Underground food storage area, approximately 35 x 20.
15. A two-story warehouse, approximately 45 x 50 x 15 m, of white stucco with a tin, gable roof.
16. Same as 9.
17. Same as 10.
18. Unknown number of unidentified buildings.

CONFIDENTIAL

Annex C

██████████ SKETCH OF CASERN OCCUPIED BY THE 2d TANK REGIMENT
AND LOCAL AND REGIONAL MILITARY COMMISSIONS IN BUCHAREST,
RUMANIA

50X1-HUM



CONFIDENTIAL
-12-

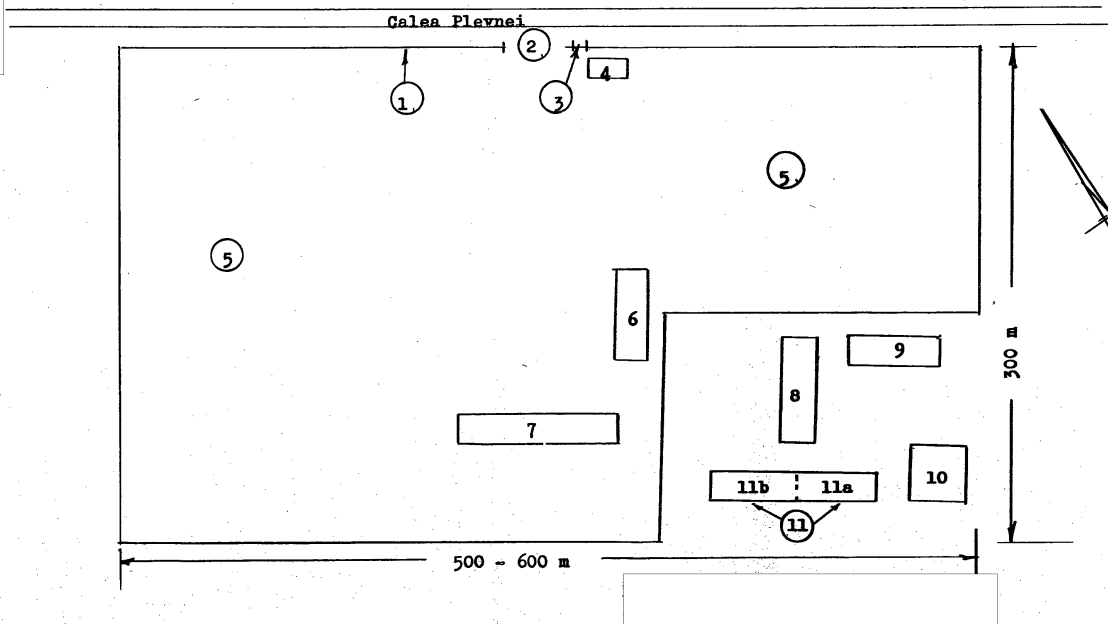

CONFIDENTIAL

50X1-HUM

CONFIDENTIAL

50X1-HUM

-13-



Legend to Annex C

Buildings Occupied by 2d Tank Regt

1. A grey, stucco fence, approximately 3.5 m high.
2. A steel, vehicle gate with its bottom portion made of a solid piece of steel and its top portion made of wire mesh. This was a double gate about 10 m wide and 3 m high, and its doors opened from the center.
3. A steel pedestrian gate with its bottom portion made of a solid piece of steel and its top portion made of wire mesh. It was approximately 1.5 m wide and 3 m high.
4. A white, stucco, one-story guard shack approximately 8 x 8 m, with a red tiled roof. A guard armed with a Czechoslovak ZB rifle was on duty at all times.

5. Other buildings



50X1-HUM

6. A white, stucco, unidentified, two-story building approximately 80 x 15 m, with a red tile roof.
7. A white, stucco, unidentified, three-story building approximately 100 to 120 x 20 m, with a red tile gable roof.

Buildings Occupied by Local and Regional Military Commission of BUCHAREST
(Comisariatul Militar Oras si Regiunea, BUCURESTI)

8. A white, stucco, one-story garage and warehouse approximately 45 x 15 x 5 m with a red tile roof.
9. A white, stucco, one-story EM barracks approximately 30 x 15 m with a red tile gable roof.
10. A white, stucco, two-story building approximately 15 x 15 m with a red tile, gable roof that was used for administrative offices and club.
11. A white, stucco, two-story building approximately 90 x 15 m with a red tile gable roof.
- 11a. Headquarters Local Military Commission for BUCHAREST.
- 11b. Headquarters Regional Military Commission for BUCHAREST.

CONFIDENTIAL

Annex D

SKETCH OF CASERN OCCUPIED BY UNIDENTIFIED
MILITARY HOSPITAL IN BUCHAREST, ROMANIA

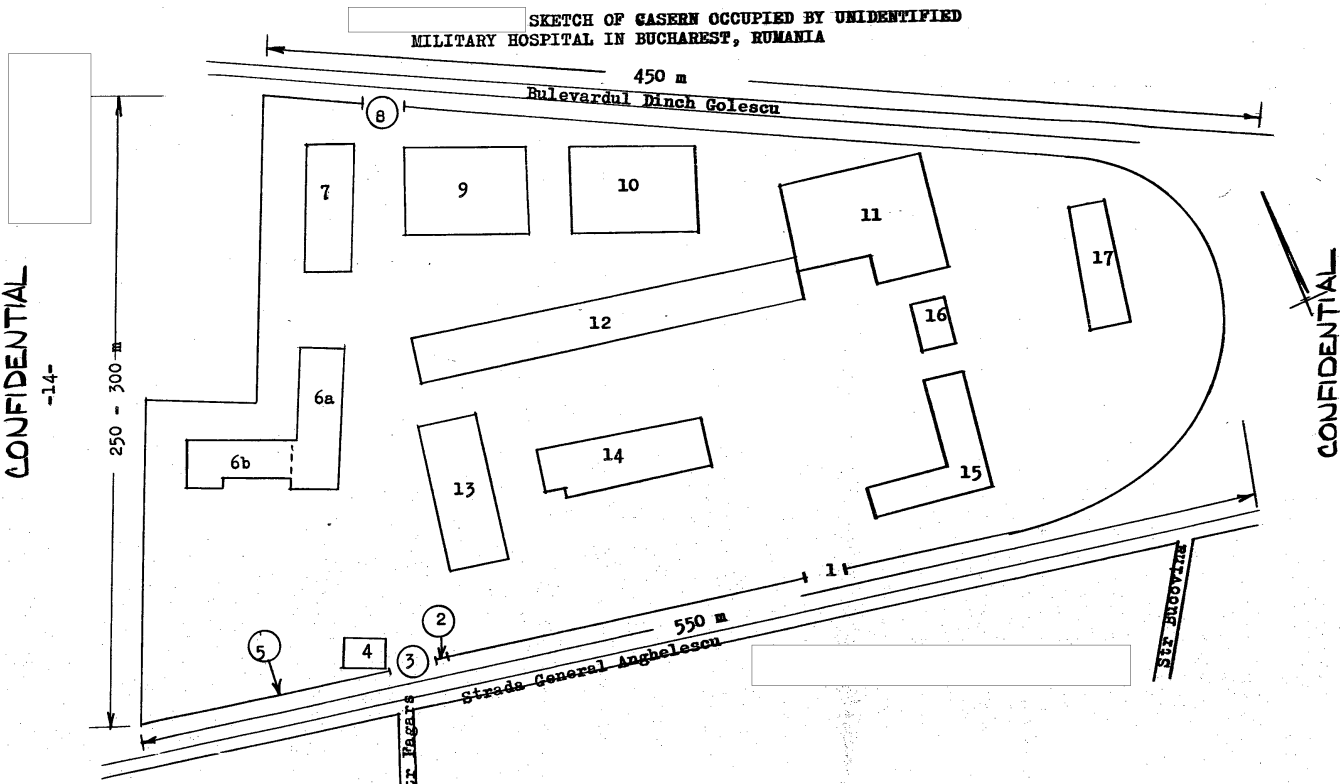

CONFIDENTIAL
-14-

CONFIDENTIAL

50X1-HUM

50X1-HUM

50X1-HUM

CONFIDENTIAL

-15-

50X1-HUM

Legend to Annex D



1. Green vehicle gate 8 m wide and 2.5 m high, constructed of iron poles. A guard armed with a Czechoslovak ZB rifle was on duty 24 hours.
2. This pedestrian gate was approximately 1.5 m high and 2.5 m wide, constructed of iron poles.
3. Same as 1. The guard on duty was also responsible for the adjacent pedestrian gate (item 2.)
4. A one-story guard shack, approximately 10 x 10 m, of white stucco with a red tile, gable roof.
5. This fence along Strada General Anghelescu had a cement base approximately 80 cm high and iron pickets approximately 2 m high. The remainder of the fence was grey stucco and approximately 3 m high.
6. An L-shaped, three-story building of white stucco with a red tile gable roof. The northern wing was approximately 50 x 20 m and the western wing was approximately 50 x 15 m.
- 6a. Headquarters and administrative offices.
- 6b. Unidentified medical school.
7. A two-story EM barracks approximately 60 x 15 m, of white stucco with a red tile, gable roof.
8. Vehicle gate approximately 10 m wide and 3 m high. Same as 1. This gate was permanently closed.
9. Unidentified wards in a three-story building approximately 45 x 40 m, of white stucco with a red tile, gable roof.
10. Same as 9.
11. Washrooms, laundry, supply room, and warehouse in a two-story building approximately 60 x 45 m, of white stucco with a red tile gable roof.
12. Unidentified wards in a three-story building approximately 150 x 20 m, of white stucco with a red tile gable roof.
13. A two-story building approximately 40 x 20 m, of white stucco with a red tile, gable roof. There was a kitchen on the first floor. No further information.
14. Out-patients' clinic and laboratory in a three-story building approximately 60 x 20 m, of white stucco with a red tile gable roof.
15. Unidentified wards in a two-story L-shaped building with its northern wing 45 x 15 m and its western wing 35 m x 15 m, of white stucco with a red tile, gable roof.
16. Canteen (PX) was in a one-story building approximately 20 x 15 m, of white stucco with a red tile, gable roof.
17. A one-story, old, wooden warehouse approximately 60 x 20 x 6 m with black tarpaper, gable roof.

CONFIDENTIAL

Annex E

SKETCH OF CASERN OCCUPIED BY BORDER GUARD HEADQUARTERS IN BUCHAREST, ROMANIA

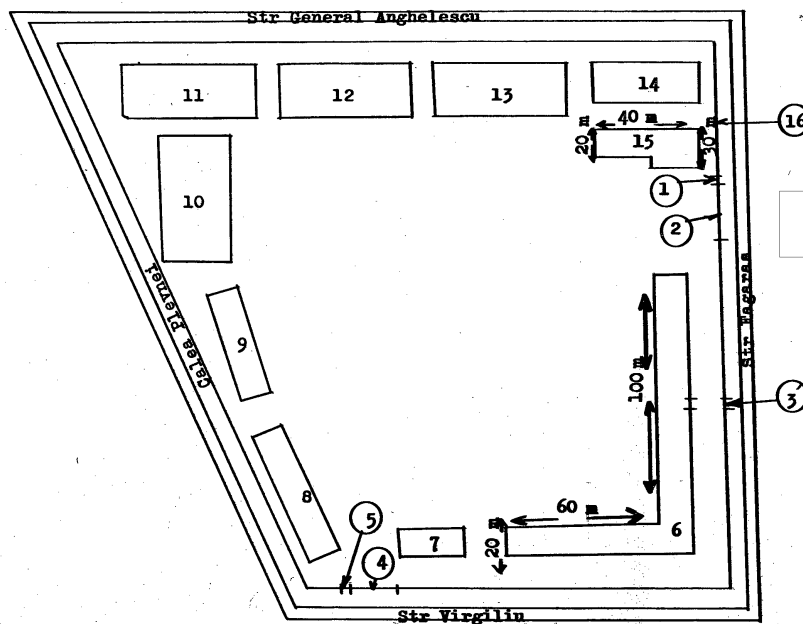

CONFIDENTIAL

-16-

CONFIDENTIAL

50X1-HUM
50X1-HUM

50X1-HUM

CONFIDENTIAL

-17-

50X1-HUM

Legend to Annex E

1. Green pedestrian gate approximately 1.5 m wide and 2 m high, with a steel frame and wire mesh on the upper half and a solid piece of steel on the lower half of the door.
2. Vehicle gate, approximately 8 x 2 m, same as 1.
3. Same as 1.
4. Same as 2.
5. Same as 1. A guard armed with a Soviet PPSH SMG was on duty 24 hours at gates 1,3, and 5.
6. Headquarters and administrative offices in a four-story L-shaped building, with its NE wing approximately 100 x 20 m and its NW wing approximately 60 x 20 m, of white stucco with a red tile, gable roof.
7. Mess hall, EM club, and unidentified offices in a three-story building approximately 30 to 35 x 20 m, of white stucco with a red tile, gable roof.
8. EM barracks in a two-story building approximately 50 x 15 m, of white stucco with a red tile, gable roof.
9. Kitchen and unidentified offices on the first floor and transient EM barracks on the second floor of a two-story building approximately 50 x 20 m, of white stucco with a red tile, gable roof.
10. Garage in a one-story building approximately 80 x 35 x 10 m, of white stucco with a red tile, gable roof.
- 11 and 12. One-story warehouses approximately 80 x 20 x 10 m, of white stucco with a red tile, gable roof.
13. Clothing warehouse and issue point for officers' clothing in a two-story building approximately 50 x 20 m, of white stucco with a red tile, gable roof.
14. Underground food storage area approximately 40 x 20 m and 3 to 5 m deep with a gable roof which extended about 1.8 m aboveground.
15. Guard building with information desk, waiting room, sleeping room for guards, and telephone switchboard in a one-story building approximately 40 x 20 m on the narrow side and 30 m on the opposite side, of white stucco with a red tile, gable roof.
16. This fence along Strada Fagaras had a concrete base approximately 1 m high with green, wooden slats approximately 2 m high. The other three sides of this fence were grey stucco approximately 4.5 m high.

CONFIDENTIAL

Annex F

██████████ SKETCH OF CASERN OCCUPIED BY UNIDENTIFIED MILITARY
REPAIR SHOP FOR VEHICLES AND WEAPONS IN BUCHAREST, ROMANIA

50X1-HUM

50X1-HUM

50X1-HUM

50X1-HUM

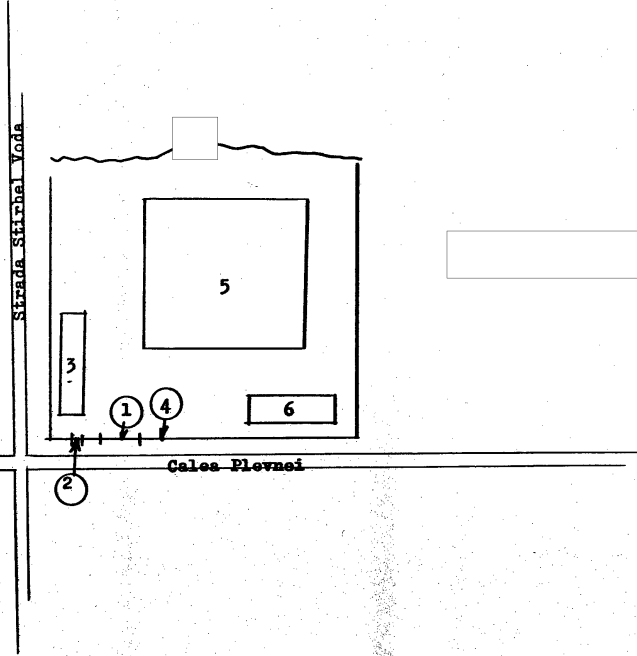
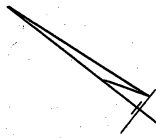

CONFIDENTIAL

-18-

CONFIDENTIAL

CONFIDENTIAL

-19-



50X1-HUM

Legend to Annex F

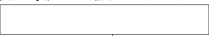
1. An iron vehicle gate with wire mesh approximately 8 m wide and 1.5 m high. A guard armed with a Soviet PPSH SMG was on duty at all times.
2. Pedestrian gate approximately 1.5 x 1.5 m, same as 1.
3. Administration building and EM barracks in a two-story building approximately 50 x 15 m, of light brown stucco with a red tile, gable roof.
4. This fence along the front of this area had a cement base approximately 80 cm high with wire mesh approximately 1 m high. The sides of this area had a fence of light brown stucco approximately 4 m high. 
5. Repair shop in a one-story building approximately 80 x 80 x 10 m, of light brown stucco with a red tile, gable roof. It had sliding doors along the front of the building.
6. Unidentified two-story building approximately 25 x 15 m of light brown stucco with a red tile, gable roof.

50X1-HUM

50X1-HUM

CONFIDENTIAL

Annex G

SKETCH OF CASERN OCCUPIED BY HEADQUARTERS TUDOR VLADIMIRESCU
DIVISION IN BUCHAREST, RUMANIA



CONFIDENTIAL
-20-

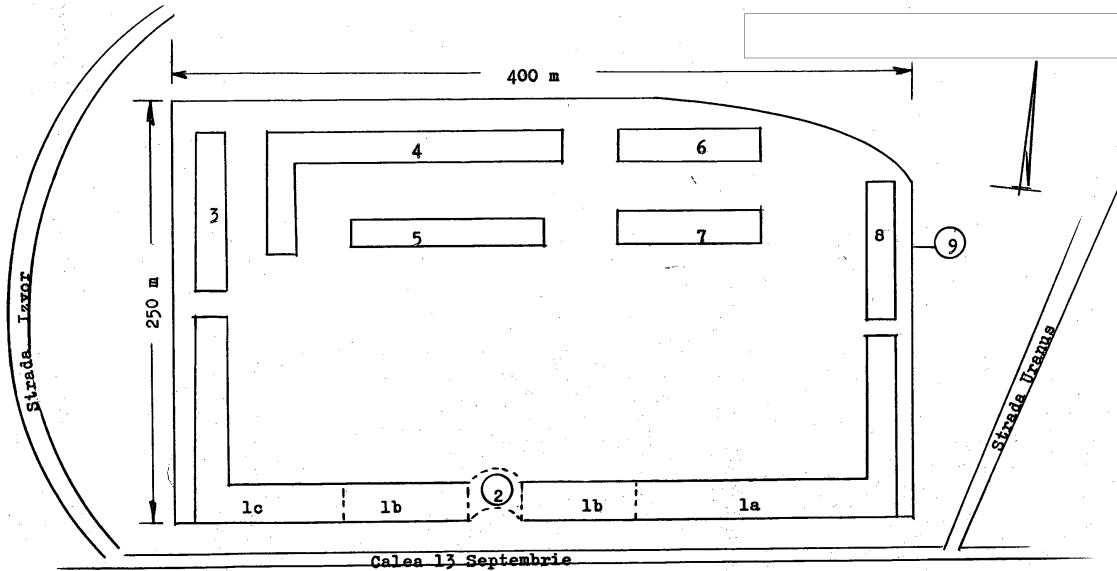

50X1-HUM

50X1-HUM

50X1-HUM

CONFIDENTIAL

CONFIDENTIAL

-21-

50X1-HUM

Legend to Annex G

1. A U-shaped, three-story building, approximately 350 x 15 m, with the east wing 60 x 15 m and the west wing 80 x 15 m, of white stucco with a red tile, gable roof.
 - 1a. EM barracks.
 - 1b. Headquarters and administrative offices.
 - 1c. EM barracks.
2. Green pedestrian and vehicle gate with steel, double doors approximately 8 m wide and 4 m high. Two guards were on duty 24 hours and were armed with Soviet PFSH SMG.
3. A three-story, EM barracks approximately 80 x 15 m, of white stucco with a red tile, gable roof.
4. An L-shaped, three story, EM barracks approximately 120 x 15 m on the northern side, 50 x 15 m on the western side, of white stucco with a red tile gable, roof.
5. A one-story mess hall approximately 60 x 15 m, of white stucco with a red tile, gable roof.
6. A one-story warehouse approximately 50 x 20 x 10 m, of white stucco with a red tile, gable roof. It had large sliding doors as an entrance.
7. A one-story kitchen approximately 50 x 15 m, of white stucco with a red tile, gable roof.
8. A three-story EM barracks approximately 80 x 15 m, of white stucco with a red tile, gable roof.
9. A light grey, fence approximately 4.5 m high, which extended around three sides of the casern. Security for the front of the casern was provided by the building itself.

CONFIDENTIAL

Annex H

[Redacted] SKETCH OF MILITARY ACADEMY IN BUCHAREST, ROMANIA

LEGEND:

All buildings were unidentified six-story buildings, of light grey stucco with red tile, gable roofs.

Bul Dr Calenderu

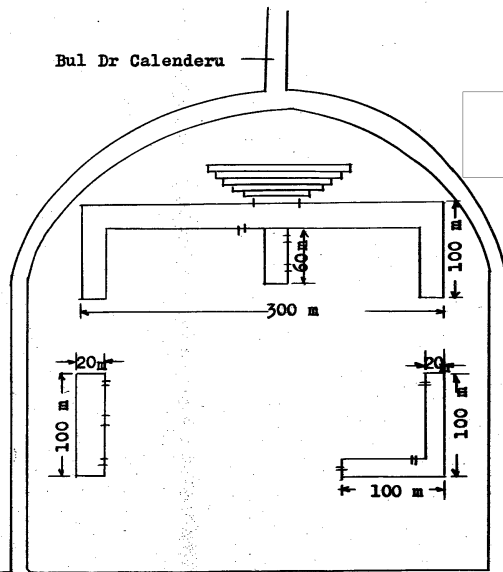

CONFIDENTIAL

-22-

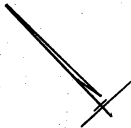

CONFIDENTIAL

50X1-HUM

50X1-HUM

50X1-HUM

Annex I

PINPOINT LOCATION OF MILITARY INSTALLATIONS IN
BUCHAREST, RUMANIA



CONFIDENTIAL
-23-

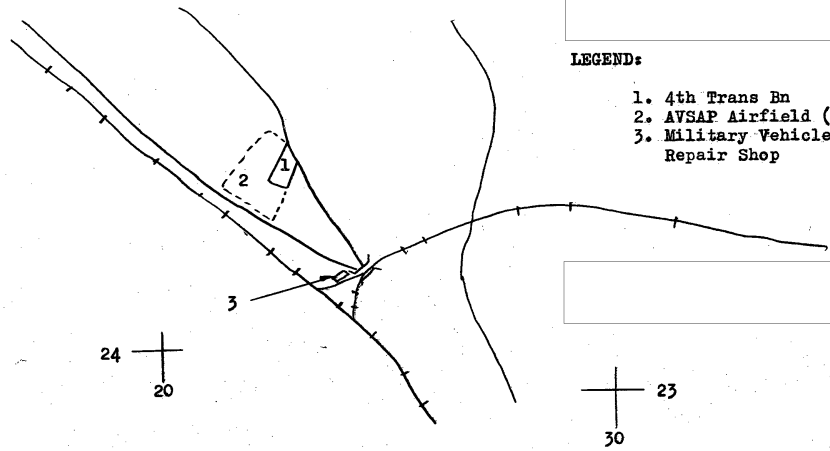

LEGEND:

- 1. 4th Trans Bn
- 2. AVSAP Airfield (for ref only)
- 3. Military Vehicle and Tank Repair Shop



CONFIDENTIAL

50X1-HUM

50X1-HUM

50X1-HUM

Annex J

SKETCH OF CASERN OCCUPIED BY THE 4TH TRANS BN
IN BUCHAREST, RUMANIA

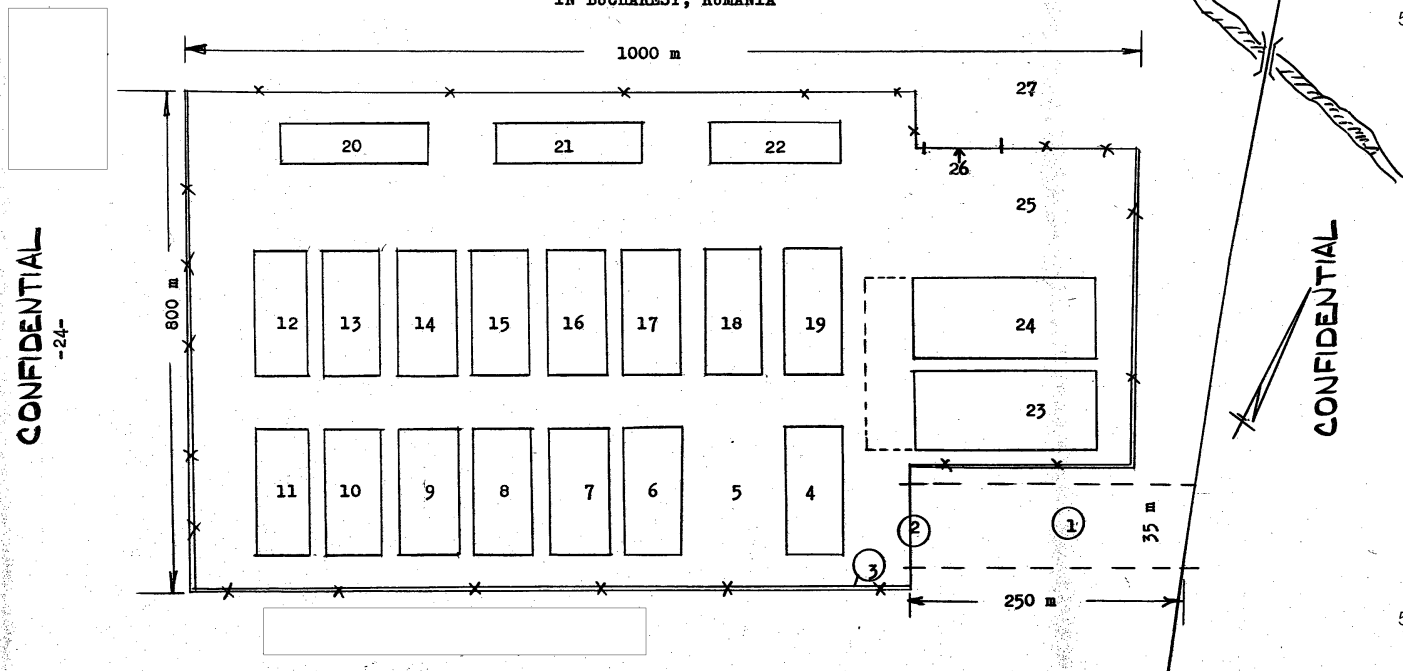

CONFIDENTIAL

-25-

50X1-HUM

Legend to Annex J

1. Concrete driveway from main highway to entrance of casern, approximately, 250 x 35 m.
2. Open entrance with two poles which could be lowered across driveway to restrict vehicles from entering without proper authorization. Two guards were on duty at all times and were armed with unidentified weapons.
3. Barbed wire fence approximately 3 m high. On the south, east, and west sides of this casern there were two barbed wire fences approximately 2 m apart with barbed wire strung between them.
4. Club and canteen (PX) in a white, one-story building approximately 70 x 15 m, of wood with a black tar-paper, gable roof. A loudspeaker, used for making announcements, was in this building.
5. Assembly area, approximately 70 x 50 m.
- 6 to 12. One-story, wooden EM barracks, approximately 70 x 15 m, painted white, with a black tar-paper, gable roof.
13. NCO students barracks, same description as 6.
14. Officer-student barracks, same description as 6.
- 15 and 16. Classrooms for officers and NCOs, same description as 6.
17. Classrooms for EM training, same description as 6.
18. Unidentified offices, same description as 6.
19. Headquarters and other unidentified offices, same description as 6.
20. Mess hall and kitchen for officers and NCOs, same description as 6.
21. Mess hall and kitchen for EM, same description as 6.
22. Movie theater and auditorium, approximately 50 x 20 m, same description as 6.
- 23 and 24. Repair shops in a one-story building approximately 100 x 50 m x 10 m, of white stucco with a tar-paper, gable roof. There was a cement area in front of these buildings.
25. Vehicle parking area.
26. A gate approximately 10 m wide, was only opened when vehicles left or entered the training area.
27. Training area and temporary parking area.

CONFIDENTIAL

Annex K

SKETCH OF CASERN OCCUPIED BY UNIDENTIFIED MILITARY VEHICLE
AND TANK REPAIR SHOP IN BUCHAREST, RUMANIA



CONFIDENTIAL
-26-

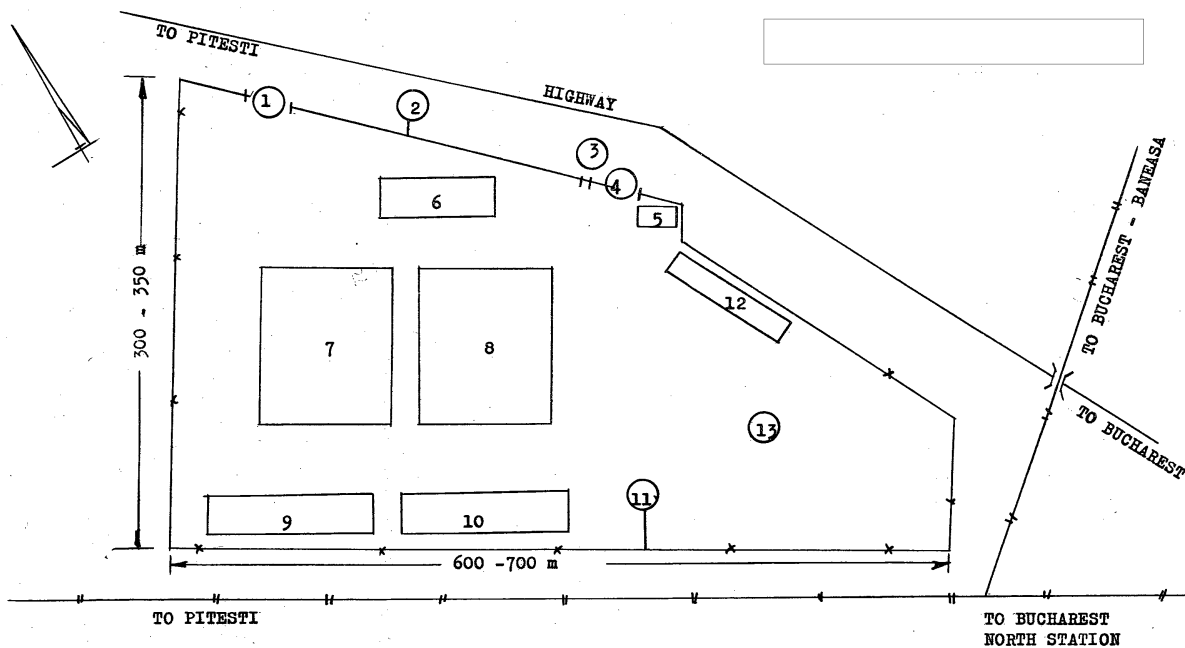

CONFIDENTIAL

50X1-HUM

50X1-HUM

50X1-HUM

CONFIDENTIAL

-27-

50X1-HUM

Legend to Annex K

1. A vehicle gate approximately 10 m wide and 3 m high, constructed of black iron posts. A guard armed with a Czech ZB rifle was on duty at all times.
2. A black, iron picket fence approximately 3 m high.
3. Pedestrian gate approximately 1.5 m wide and 3 m high, same description as 1.
4. Same as 1.
5. A one-story guard shack approximately 10 x 10 m, of white stucco with a red tile, gable roof. A guard armed with a Soviet PPSH SMG was on duty at all times and was responsible for gates mentioned as items 3 and 4.
6. Headquarters and administrative offices in a two-story building approximately 50 x 20 m, of white stucco with a red tile, gable roof.
- 7 and 8. Repair shops in one-story buildings approximately 120 x 80 x 10 m, of white stucco with a red tile, gable roof.
- 9 and 10. Repair shops in one-story buildings approximately 80 x 15 x 8 m, of white stucco with red tile, gable roofs.
11. Barbed wire fence approximately 3.5 m high.
12. Parts warehouse in a one-story building approximately 80 x 25 x 10 m, of white stucco with a red tile, gable roof.
13. Parking lot for vehicles undergoing repairs.



CONFIDENTIAL

CONFIDENTIAL
-29-

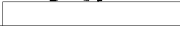
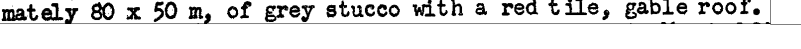

50X1-HUM

Legend to Annex L

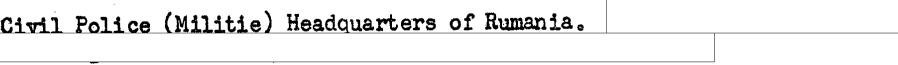
1. Ministry of National Defense Headquarters, located in an L-shaped four-story building with each wing approximately 80 x 40 m, of white stucco with a red tile, gable roof.  50X1-HUM
2. Ministry of Interior Headquarters, located in a five-story building approximately 80 x 50 m, of grey stucco with a red tile, gable roof.  50X1-HUM
3. Secret Police (Securitate) Headquarters of Rumania, located in a five-story building approximately 70 x 50 m, of grey stucco with a red tile, gable roof.  50X1-HUM
4. and 5. Civil Police (Militie) Headquarters of Rumania. 
6. Fire Department Headquarters of Rumania.
7. Air Force Headquarters, AVSAP.
8. Air Force Headquarters, Rumanian Army.

CONFIDENTIAL

Annex M

SKETCH OF CASERNS OCCUPIED BY THE HEADQUARTERS CIVIL
POLICE (MILITIE) OF RUMANIA IN BUCHAREST

50X1-HUM
50X1-HUM

CONFIDENTIAL

-30-

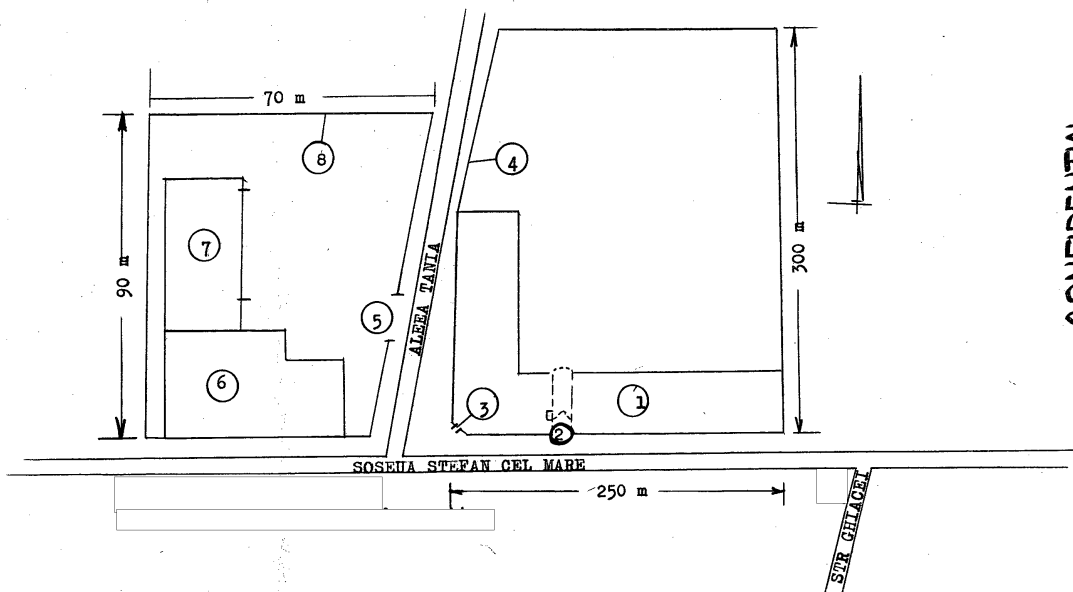

CONFIDENTIAL

50X1-HUM
50X1-HUM

CONFIDENTIAL

-31-



50X1-HUM

Legend to Annex M

1. Main headquarters for civil police (Militie) of Rumania in an L-shaped, four-story building approximately 250 x 20 m on the south wing and 60 x 20 m on the west wing, of grey stucco with a red tile, gable roof.
2. Vehicle and pedestrian entrance. There was a tunnel on the first floor, approximately 10 m wide, which led through the building to the rear. About a quarter of the way through this tunnel there was an iron picket gate and a guard office. Two NCO's were on duty at this office at all times and were armed with unidentified pistols. This entrance was used mainly by personnel who worked in this building.
3. Main entrance and waiting room. Just inside this entrance there was a female receptionist.
4. A wooden fence approximately 3.5 m high.
5. Vehicle and pedestrian, iron picket gate, approximately 10 m wide and 3 m high, no guard.
6. Mess hall, kitchen, and club in a two-story building approximately 50 x 30 m, of grey stucco with a red tile, gable roof.
7. A one-story garage approximately 40 x 20 m, of grey stucco with a red tile gable roof.
8. A wooden fence approximately 3 m high.



50X1-HUM

CONFIDENTIAL

Annex N

SKETCH OF CASERN OCCUPIED BY HEADQUARTERS OF THE FIRE DEPARTMENT OF RUMANIA IN BUCHAREST, RUMANIA

50X1-HUM

50X1-HUM

LEGEND:

1. Repair shop
2. Garage for fire engines. The second floor was the firemen's sleeping quarters. This was a two-story building approximately 100 x 30 m, of red stucco with a red tile, gable roof.
3. Headquarters and other administrative offices were in a three-story building approximately 100 x 20 m, of red stucco with a red tile, gable roof.
4. Two guards armed with Czech ZB rifles were on duty at all times.
5. A wooden picket fence approximately 3 m high.

CONFIDENTIAL

50X1-HUM

CONFIDENTIAL

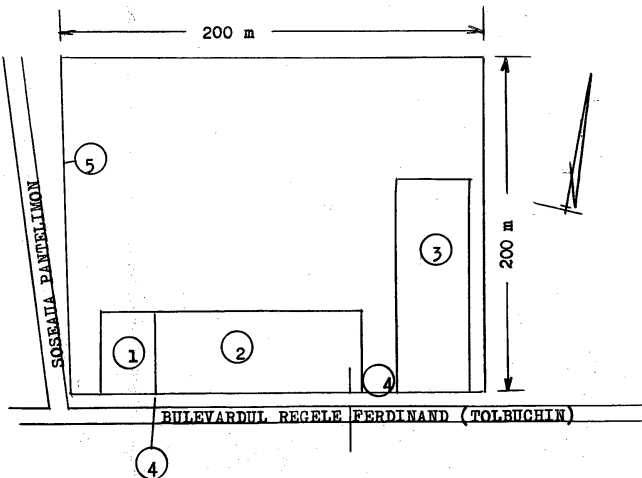

Annex O

PINPOINT LOCATION OF MILITARY INSTALLATIONS IN TURNU-SEVERIN,
RUMANIA

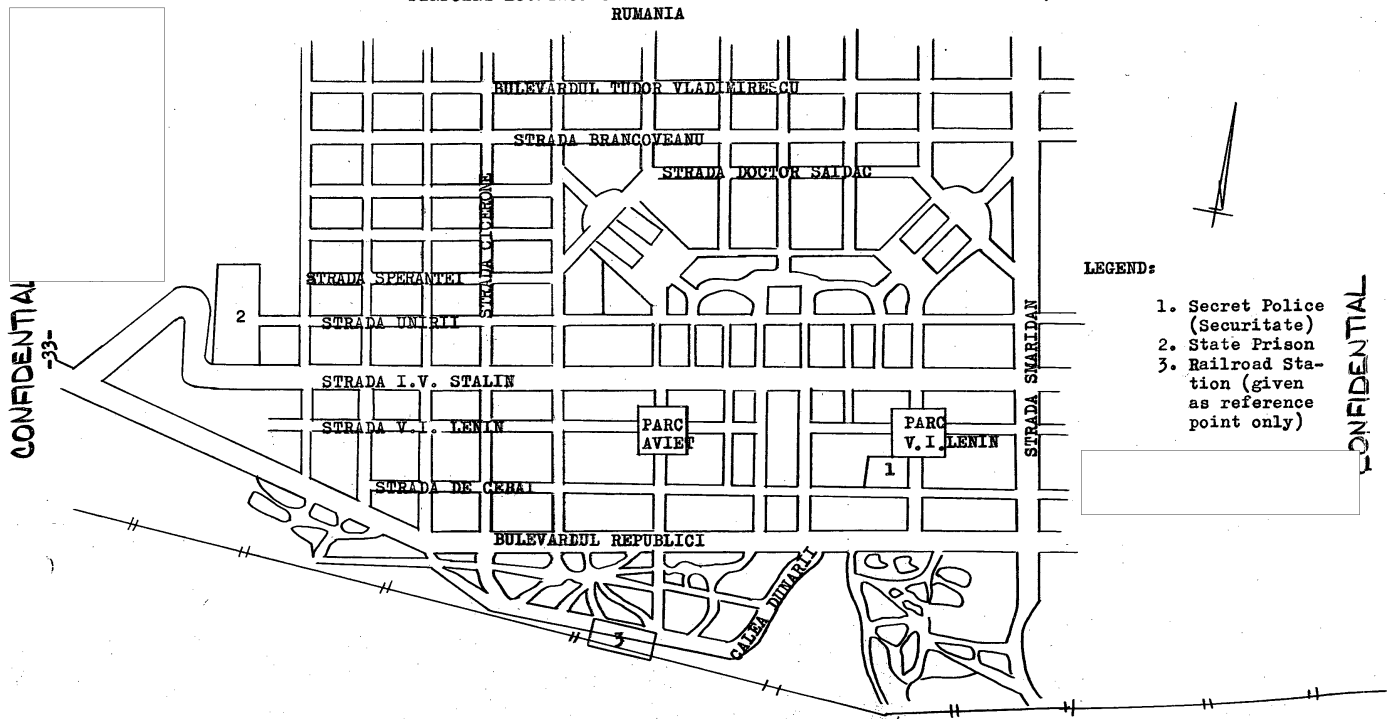

LEGEND:

- 1. Secret Police (Securitate)
- 2. State Prison
- 3. Railroad Station (given as reference point only)

CONFIDENTIAL
-33-

CONFIDENTIAL

50X1-HUM

50X1-HUM

Annex P

Figure 1

SKETCH OF CASERN OCCUPIED BY THE SECURITY POLICE (SECURITATE) IN TURNU-SEVERIN, ROMANIA

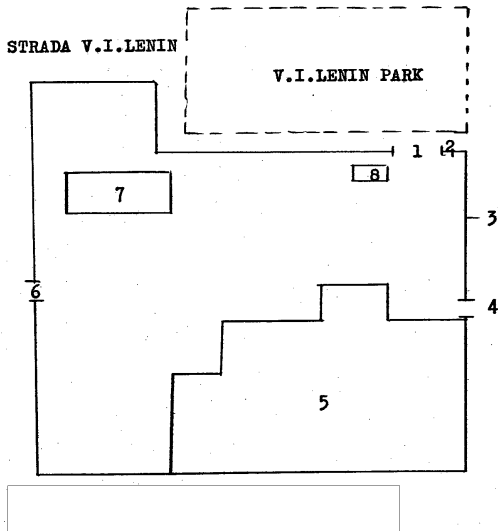
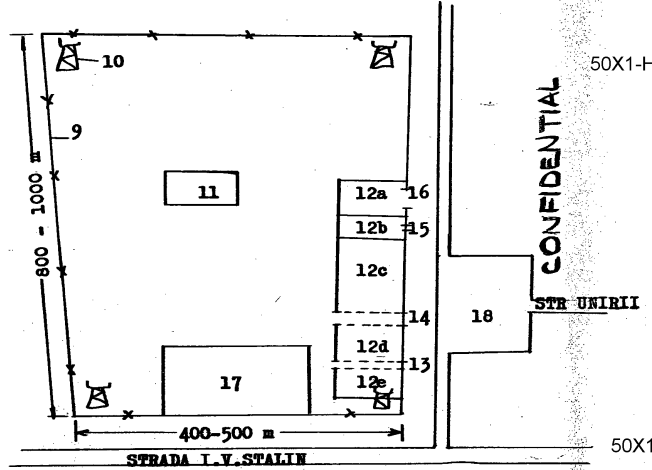

Figure 2

SKETCH OF STATE PRISON IN TURNU-SEVERIN, ROMANIA



CONFIDENTIAL

CONFIDENTIAL

50X1-HUM

50X1-HUM

50X1-HUM

50X1-HUM

-35-

50X1-HUM

Legend to Annex P

Secret Police Casern (Securitate)(Figure 1)

1. Black, steel, vehicle gate approximately 7 to 8 m wide and 3.5 m high.
2. Black, steel, pedestrian gate approximately 1.5 m wide and 3.5 m high.
3. Black wooden fence, approximately 3.5 m high.
4. Same as 2. This gate was closed and the guard on duty had the key.
5. Headquarters, administrative offices, and club in a three-story building approximately 40 to 50 x 30 m, of white stucco with a dull green tile, gable roof. In the basement of this building were about 10 cells for holding prisoners on a temporary basis.
6. Pedestrian gate, leading to an open walk used only by the assistant commander, who lived in a house in an enclosed area adjacent to this casern. The secretary of the Communist Party for TURNU-SEVERIN also lived in this area.
7. A one-story, green, wooden garage approximately 10 x 7 to 8 m. 50X1-HUM observed two vehicles in this garage, an English Land Hower and a Soviet Pobeda.
8. A one-story, green, wooden guard shack approximately 5 x 4 m. One guard was on duty 24 hours and was armed with a Soviet PPSH SMG. A Master Sergeant also on duty 24 hours, carried an unidentified pistol.

State Prison (Figure 2)

9. Barbed wire fence about 4.5 m high. In front of this casern was a dark grey, cement fence about 5 m high.
10. Guard tower. There was a tower in each corner of this area. Each was constructed of wood and was 7 to 8 m high. A guard was on duty on each tower and was armed with a Czechoslovak ZB machinegun.
11. Kitchen and washroom in a one-story building approximately 25 to 30 x 10 to 15 m, of dark grey stucco with a red tile, gable roof.
12. Headquarters, administrative offices, club, garage, warehouse, and cells. This was a two-story building approximately 50 x 30 m, of dark grey stucco with a red tile, gable roof. The second floor was one section of the jail with an unknown number of cells.
 - 12a. Garage
 - 12b. Club
 - 12c. Administrative offices
 - 12d. Commander's office
 - 12e. Warehouse

CONFIDENTIAL

-36-

50X1-HUM



Legend to Annex P, continued

13. Green, steel, pedestrian gate approximately 2 m wide and 3.5 m high which led into a tunnel through the first floor. One guard was on duty 24 hours and was usually armed with a Soviet PPSH SMG.
14. Vehicle gate, same as 13 except that it was 8 to 10 m wide.
15. Door leading into club, no guard.
16. Garage doors, no guard. Each driver had a key to this door.
17. Cells in a two-story building approximately 70 to 80 x 25 m of dark gray stucco with a red tile, gable roof.
18. Sport field.

CONFIDENTIAL

Annex Q

PINPOINT LOCATION OF THE MILITARY INSTALLATIONS IN
TURNU-SEVERIN, ROMANIA

50X1-HUM

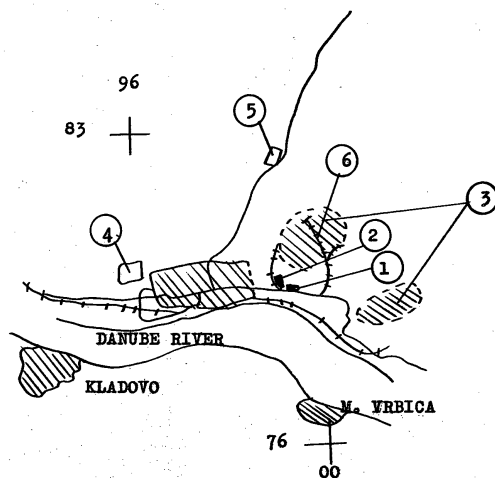

LEGEND:

1. Hq 9th Border Guard Regt
2. Unidentified Inf Regt and Munition Depot
3. Tng Area for units of TURNU-SEVERIN
4. Unidentified Motorized Arty Regt
5. Unidentified Underground Ammunition Storage Area
6. Military Railroad Siding and Warehouses



50X1-HUM

CONFIDENTIAL
-37-

CONFIDENTIAL

Annex R

SKETCH OF CASERN OCCUPIED BY HEADQUARTERS OF THE 9TH BORDER GUARD REGT IN TURNU-SEVERIN, RUMANIA

50X1-HUM

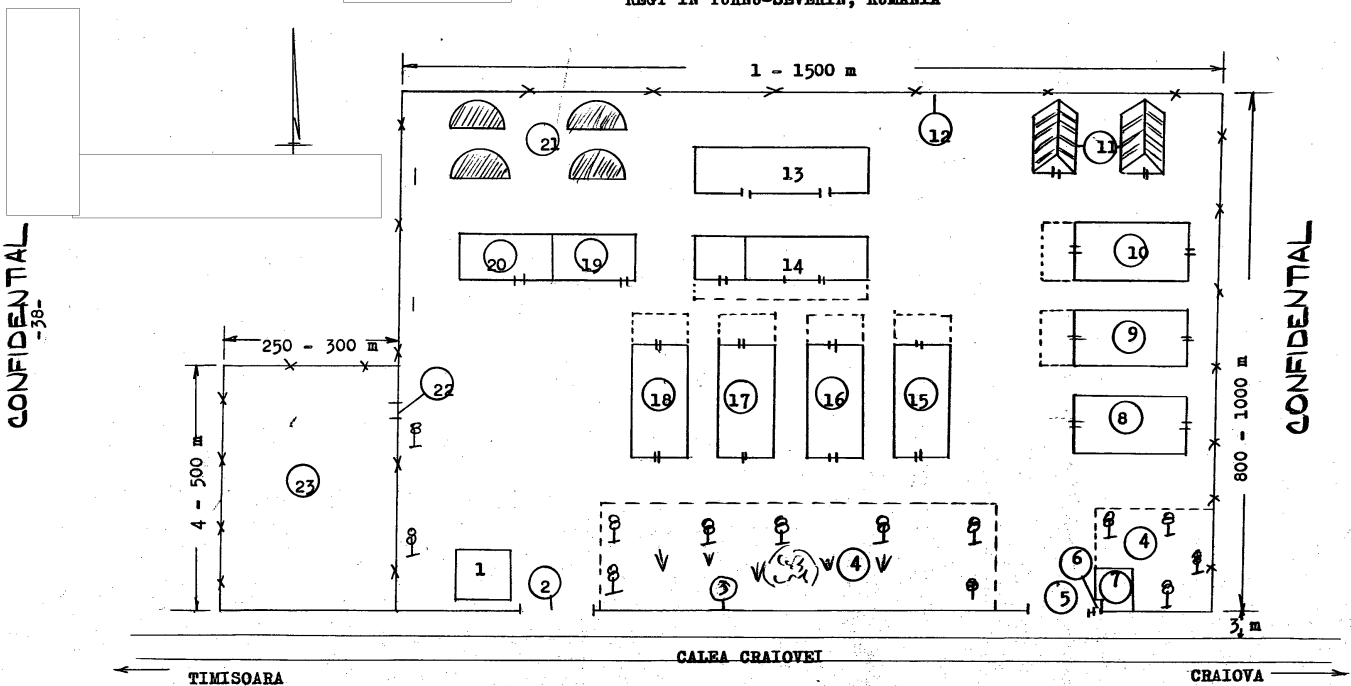

50X1-HUM

CONFIDENTIAL

-39-

50X1-HUM

Legend to Annex R

1. A one-story, guard house, white stucco approximately 8 x 6 m, with a light brown tiled, gable roof. The building consisted of a small office and a sleeping room with approximately 10 or 12 bunks.
2. Green, metal gate for supply vehicles approximately 1.8 m high and 4 to 5 m wide. One guard was on duty at all times and was armed with a Soviet PPSH SMG.
3. A green, wire mesh fence which extended along the entire front of the casern, approximately 1.5 m high.
4. Gardens
5. Green, metal, vehicle gate approximately 1.8 m high and 4 to 5 m wide.
6. Green, metal, pedestrian gate approximately 1.8 m high and 1 m wide. One guard was on duty at all times and was armed with a Soviet PPSH SMG. This guard was also responsible for the adjoining vehicle gate (item 5)
7. A one-story, white stucco guard house approximately 8 x 6 m with a light brown tile, gable roof. It consisted of the office of the guard officer, a waiting room, and a sleeping room with 10 or 12 bunks.
8. A two-story, white stucco headquarters building approximately 75 to 80 m long and 15 m wide with a light brown tile, gable roof. The first floor consisted of the commander's office, administrative offices, rear service office, and plans and training office. The second floor was used as a club for all members of the unit.
- 9 and 10. Unidentified buildings, possibly mess hall, supply rooms, and other administrative offices. These were two-story, white stucco buildings, approximately 75 to 80 m long and 15 m wide with light brown tile, gable roofs.
11. Underground storage facilities for food supplies, each approximately 50 m long, 10 to 15 m wide, and 3 to 4 m deep. The roofs were covered with an unknown type of grass or weeds.
12. Barbed wire fence approximately 2 meters high.
13. Stables in one-story, white stucco building approximately 60 to 70 m long and 12 to 15 m wide with a light brown tile, gable roof and 2-m-wide green doors.
14. A one-story, white stucco garage and auto repair shop, 50 to 60 m long, 10 to 12 m wide with a light brown tile, gable roof. The left side of this building was the repair shop. There was a concrete area 7 to 8 m wide along the entire length of the building.
- 15 to 18. Two-story, white stucco EM barracks approximately 75 to 80 m long and 15 m wide with light brown tile, gable roofs. There was a washroom and a latrine on both ends of the buildings and an assembly area on the north end of each building, where daily formations were held. Estimated capacity of each building was 280 to 300.

CONFIDENTIAL

50X1-HUM

CONFIDENTIAL

-40-



Legend to Annex R, continued

19. A one-story, white stucco bakery approximately 30 x 15 m with a light brown tile, gable roof.
20. A one-story, white stucco laundry approximately 30 x 15 m with a light brown tile, gable roof.
21. Open area containing haystacks.
22. Entrance to training area and soccer field, approximately 4 m wide.
23. Training area and soccer field.

CONFIDENTIAL

Annex 5

SKETCH OF CASERN OCCUPIED BY AN UNIDENTIFIED INFANTRY REGIMENT AND AN UNDERGROUND MUNITION STORAGE AREA IN TURNU-SEVERIN, RUMANIA



CONFIDENTIAL

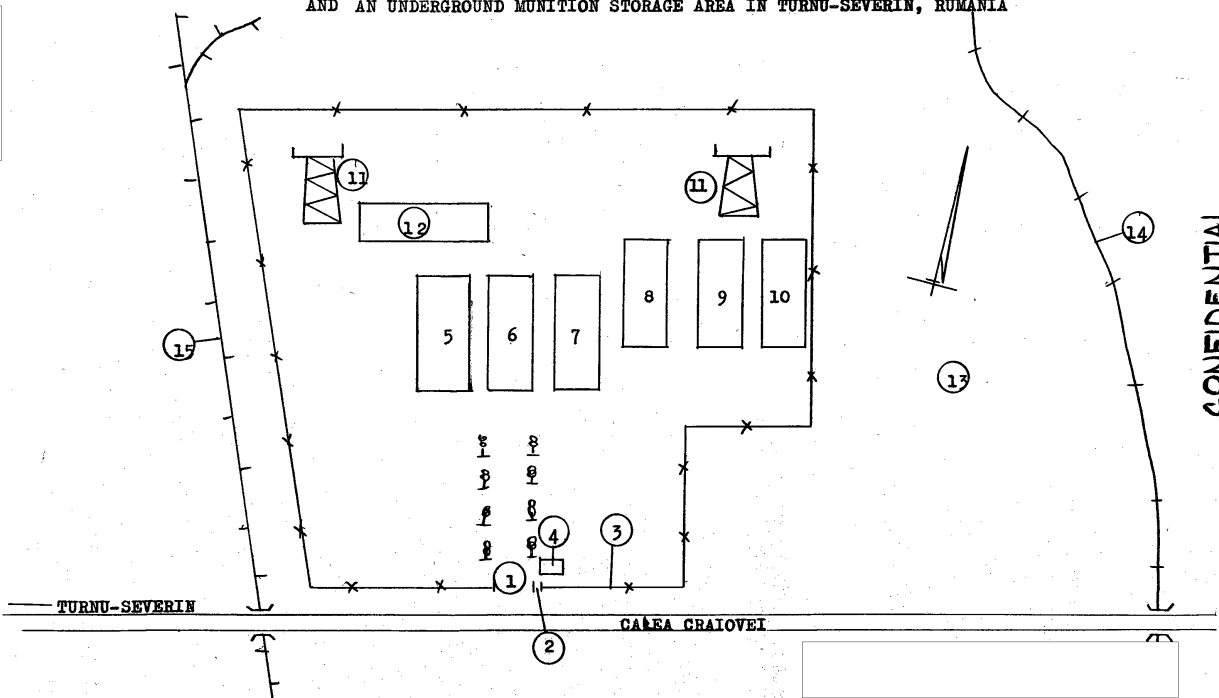

50X1-HUM
50X1-HUM

CONFIDENTIAL

50X1-HUM

CONFIDENTIAL

-42-



50X1-HUM

Legend to Annex S

1. White, steel, vehicle gate approximately 8 m wide and $2\frac{1}{2}$ m high.
2. Pedestrian gate, which was an open walkway approximately $1\frac{1}{2}$ m wide.
3. Barbed wire fence 2 to 3 m high.
4. A small, one-story guard shack approximately $1\frac{1}{2}$ x $1\frac{1}{2}$ x 3 m, of wood and painted white. One guard was on duty 24 hours and was armed with a Czechoslovak ZB rifle.
- 5 to 7. These were one-story, white, wooden, EM barracks, approximately 80 to 100 x 15 x 6 m, with black, tar-paper, gable roofs.
- 8 to 10. Underground munitions storage area approximately 60 to 70 x 20 m and 3 m deep. The roofs extended approximately 1.8 m above ground, were gabled, and had dirt on top of them. The inside of this area was lined with logs and there were individual bins for storage of ammunitions.
11. Unpainted, wooden towers 7 to 8 m high. A guard was posted on each tower and was armed with a Czechoslovak ZB rifle.
12. A one-story, white, wooden headquarters approximately 80 to 100 x 15 m, with a black tar-paper gable roof.
13. Location of the 9th Border Guard Regt.
14. Railroad line east of casern.
15. Small railroad line located across from casern and used by lumber company to transport logs.

CONFIDENTIAL

Annex T

SKETCH OF CASERN OCCUPIED BY AN UNIDENTIFIED
MOTORIZED ARTILLERY REGIMENT IN TURNU-SEVERIN, ROMANIA

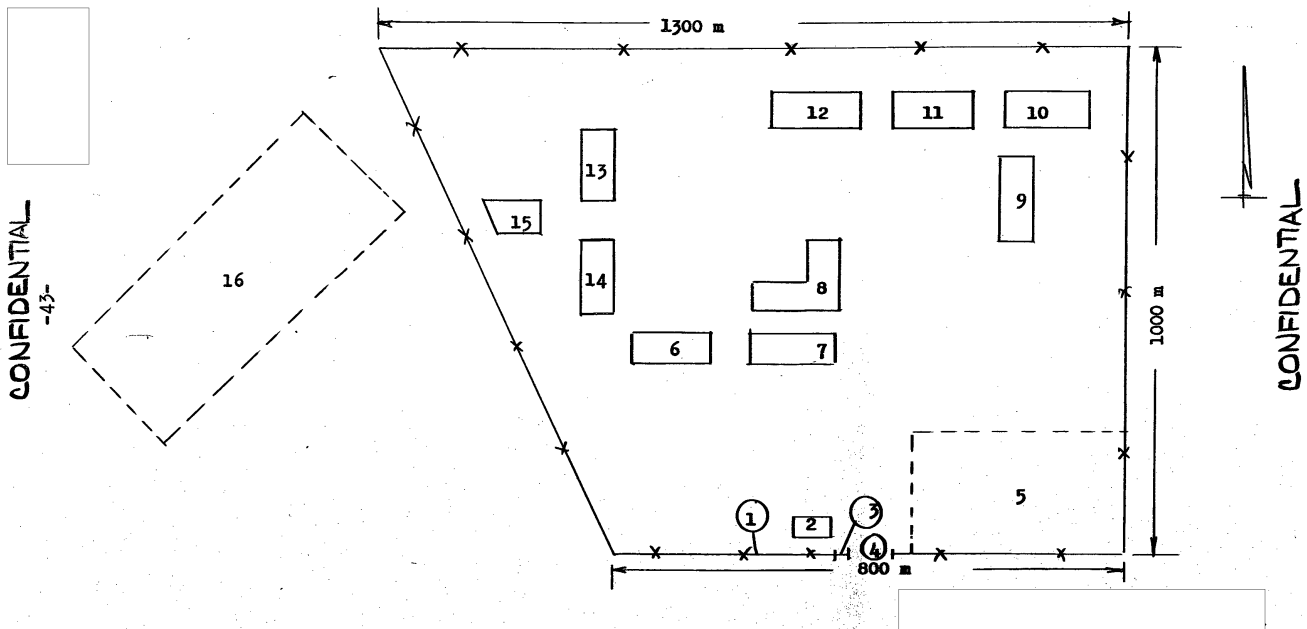

50X1-HUM

50X1-HUM

50X1-HUM

CONFIDENTIAL

-44-

50X1-HUM

Legend to Annex T

1. Barbed wire fence approximately 2 m high.
2. A one-story, white stucco guard shack, approximately 8 x 5 to 6 m with a black, tar-paper, gable roof. Guard was on duty 24 hours and was armed with a Soviet PPSH SMG. This building had a small office, telephone, and beds for 20 guards.
3. A white, pedestrian gate about 1½ m wide and 1.8 m high. The lower half was steel and the upper half was wire mesh.
4. A white, vehicle gate approximately 6 x 1.8 m. The lower half was steel and the upper half was wire mesh.
5. Park
- 6 to 7. Two-story EM barracks of white stucco, approximately 60 x 15 m with red tile, gable roofs.
8. Headquarters and offices in a two-story, L-shaped building, of white stucco with a red tile, gable roof. The east and south sides of the building were about 25 x 15 m.
- 9 to 12. Garages for tanks, artillery guns, and vehicles in one-story buildings approximately 60 x 20 to 25 x 8 m, of white stucco, with red tile, gable roofs. These buildings had large wooden doors approximately 20 m wide.
- 13 to 14. EM barracks in two-story buildings in white stucco, approximately 60 x 15 m, with red tile, gable roofs.
15. A one-story, white wooden unidentified building, approximately 6 x 6 m, with a red tile, gable roof.
16. Firing range approximately 800 x 35 m with an earth butt and beams on three sides 6 to 8 m high. The range was used for firing of small arms from 100 to 600 m and had sufficient space for 10 to 15 targets. Source fired at this range three or four times between 1954 and 1957.

CONFIDENTIAL

SKETCH OF CASEH¹ OCCUPIED BY AN UNIDENTIFIED UNDERGROUND AMMUNITION STORAGE AREA IN TURNU-SEVERIN, RUMANIA

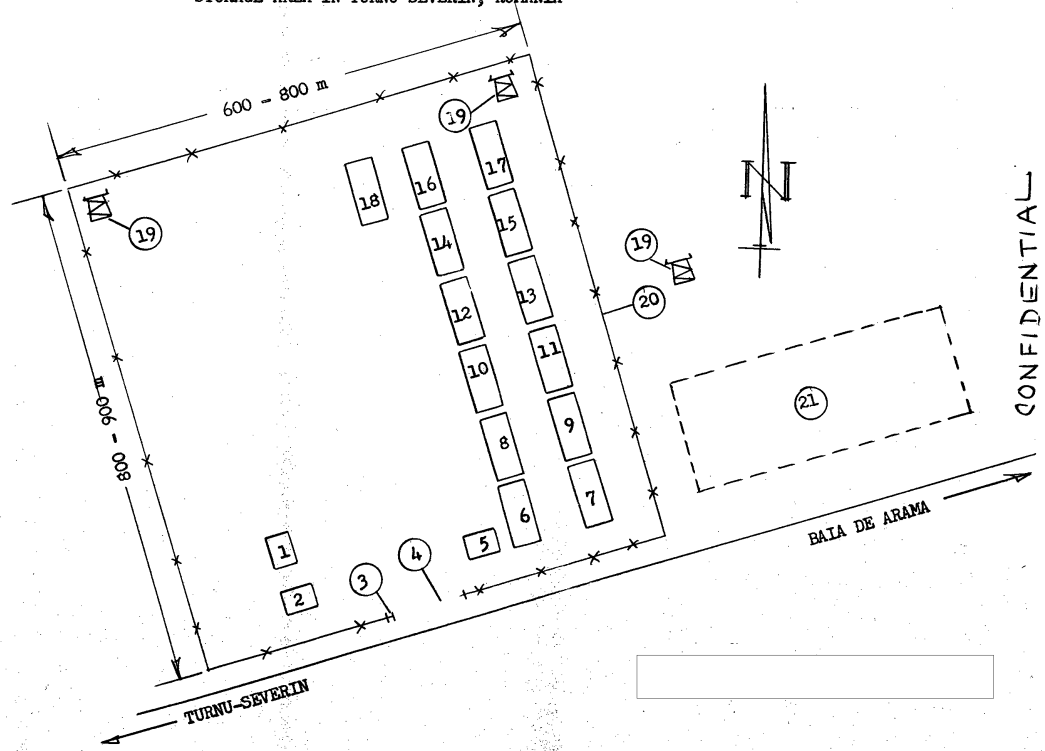

CONFIDENTIAL

-45-

50X1-HUM
50X1-HUM

CONFIDENTIAL

50X1-HUM

CONFIDENTIAL

-46-



50X1-HUM

Legend to Annex U

1. EM barracks in a one-story, white, stucco building approximately 15 to 20 x 15 m with a red tile, gable roof.
2. EM barracks, same as 1.
3. Pedestrian gate, constructed with a wooden frame and with barbed wire, approximately 1.5 m wide and 1.8 m high.
4. Vehicle gate constructed with a wooden frame and with barbed wire, approximately 8 m wide and 1.8 m high. A guard was on duty here 24 hours and was armed with a Soviet PPSH SMG.
5. EM barracks in a one-story, white, stucco building approximately 15 to 20 x 15 m with a red tile, gable roof.
- 6 to 18. Underground ammunition storage areas, each approximately 50 x 20 m and 3 to 4 m deep. The gabled roofs extended about 1.5 m aboveground, and were covered with dirt. [redacted] 50X1-HUM
 [redacted] the ammunition stored here was for all units in the area of TURNU-SEVERIN, including the outlying units. [redacted] estimated 50X1-HUM
 [redacted] 30 to 50 guards were assigned here. 50X1-HUM
19. Wooden guard towers 4 to 6 m high. A guard was on duty at each tower 24 hours and each was armed with a Czechoslovak semiautomatic ZB rifle.
20. Barbed wire fence approximately 2.5 m high.
21. Rifle range approximately 1500 x 800 m and used by military, civilian, and paramilitary organizations for firing small arms.

CONFIDENTIAL

Annex V

SKETCH OF MILITARY RAILWAY SIDING AND WAREHOUSES IN
TURNU-SEVERIN, ROMANIA

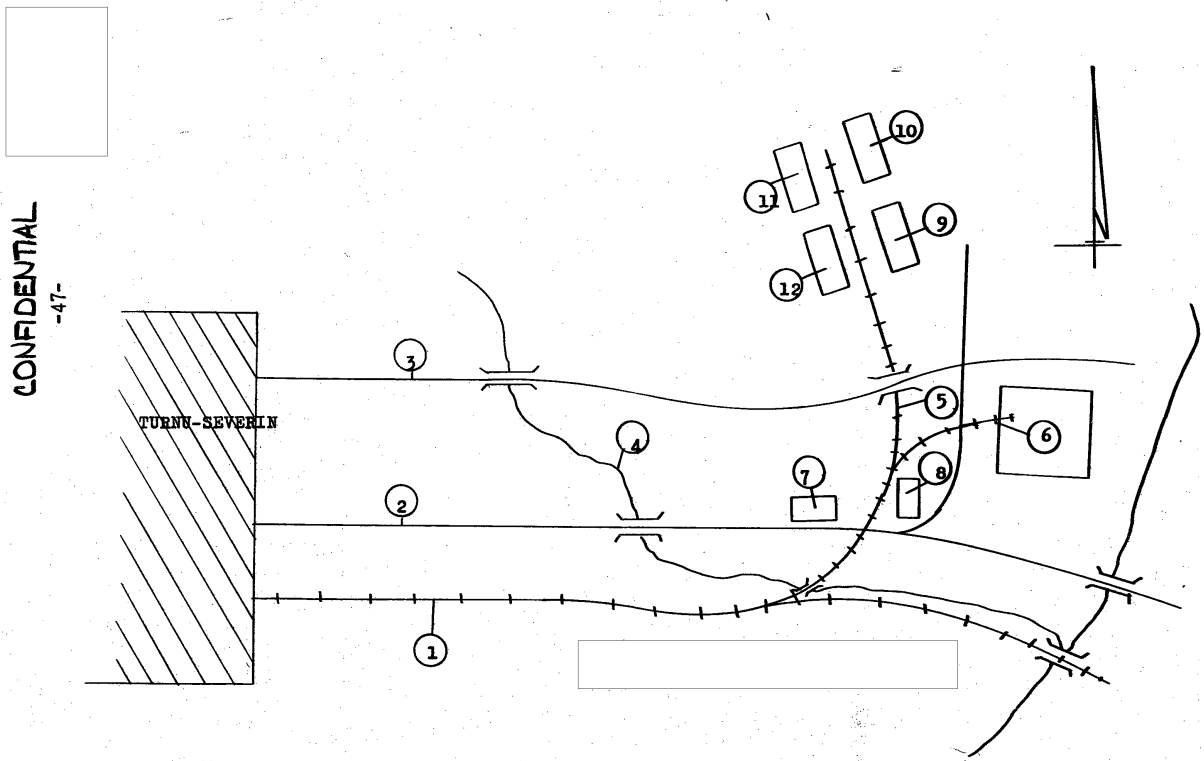

CONFIDENTIAL
-47-

CONFIDENTIAL

50X1-HUM
50X1-HUM

50X1-HUM

CONFIDENTIAL

-48-

50X1-HUM

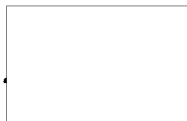

Legend to Annex V

1. Main railroad line TURNU-SEVERIN to BUCHAREST.
2. Main road TURNU-SEVERIN to CRAIOVA.
3. Secondary road
4. Small river 50X1-HUM
5. Secondary railroad line to military warehouse. [redacted] when a train arrived in TURNU-SEVERIN with supplies or equipment for military units, the boxcars would be sidled on this railroad siding and the cargo unloaded and stored temporarily in the warehouse or sometimes unloaded directly onto trucks for delivery to the respective units. [redacted] this equipment 50X1-HUM seldom remained in these warehouses more than three or four days.
6. Secondary railroad line to distillery.
7. EM barracks in a one-story building approximately 25 x 10 m, of white stucco with a dark brown, gable roof.
8. Warehouse for food, clothing, and other unknown items in a one-story building approximately 50 x 30 x 8 m, of white stucco with a dark brown, gable roof.
9. to 11. Storage areas for arms, ammunition. These areas were approximately 80 x 25 x 8 m with wooden, gable roofs and open sides. Guards were posted here to keep unauthorized personnel away.
12. Guard shack and office in a one-story building approximately 10 x 6 m, of white stucco with a red tile, gable roof.

CONFIDENTIAL

Annex W

Figure 1

SKETCH OF LOCATION OF UNIDENTIFIED
BORDER GUARD BATTALION IN TURNU-SEVERIN,
RUMANIA

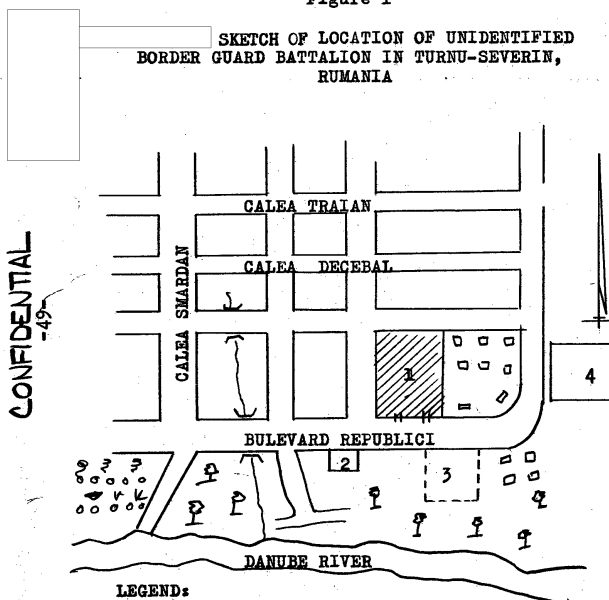

LEGEND:

- 1. Unidentified Guard Bn Casern
- 2. State Court House (For reference only)
- 3. Sport Field (For reference only)
- 4. Women Teachers' College (For reference only)

Figure 2

SKETCH OF CASERN OCCUPIED BY AN
UNIDENTIFIED BORDER GUARD BATTALION IN TURNU-
SEVERIN, RUMANIA

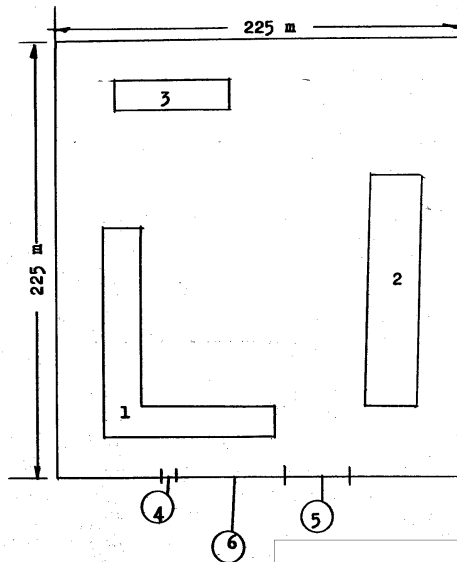

CONFIDENTIAL

50X1-HUM

50X1-HUM

50X1-HUM

CONFIDENTIAL

-50-



50X1-HUM

Legend to Annex W

(Figure 2)

1. Headquarters building in an L-shaped, one-story, white, stucco building approximately 40 m long on the western wing and 30 m long on the southern wing and 12 to 15 m wide, with a red tile, gable roof.
2. EM barracks in a one-story, white, stucco building 45 to 50 m x 10 to 12 m with a red tile, gable roof.
3. An old, wooden, one-story, unidentified building with a black, tar-paper, shed-type roof, approximately 20 x 8 to 10 m.
4. Green, steel, pedestrian gate, approximately 1.5 m wide and 1.8 m high. One guard armed with a Soviet PPSH SMG was on duty at all times.
5. Green, steel, vehicle gate, approximately 5 to 6 m wide and 1.8 m high. The guard on duty at the pedestrian gate (item 4) had the key for this gate.
6. Green fence on the southern side of casern, constructed with a concrete base with steel posts approximately 1.5 m high. The other three sides of the casern had a wooden fence approximately 1.5 m high with slits between the boards. It was painted white but rain and age made it dull yellow.

CONFIDENTIAL

Annex X

Figure 1
SKETCH OF LOCATION OF UNIDENTIFIED BORDER
GUARD BATTALION IN ORSOVA, RUMANIA

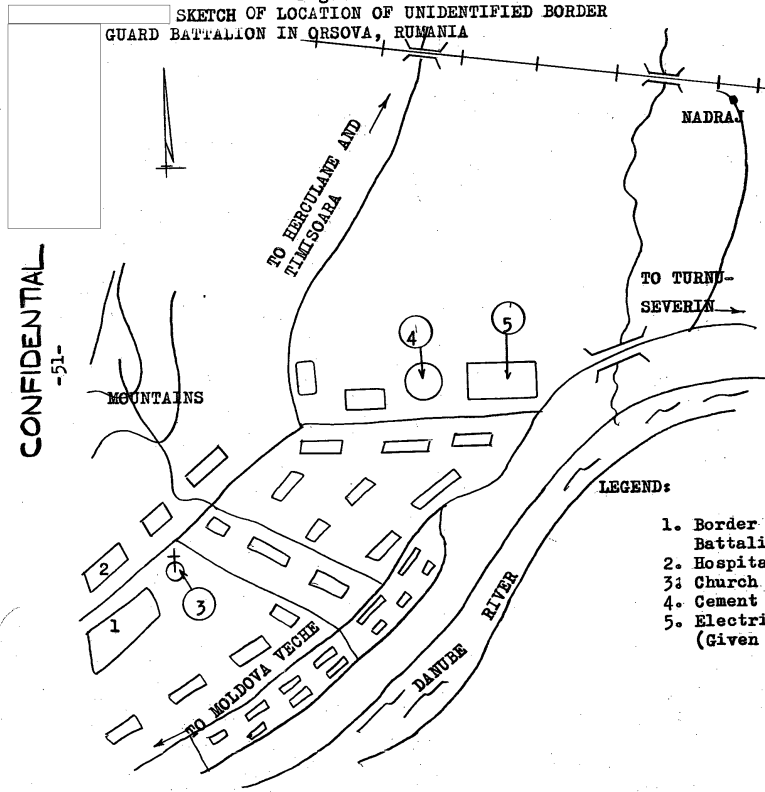

LEGEND:

- 1. Border Guard Battalion
- 2. Hospital
- 3. Church
- 4. Cement Factory
- 5. Electrical Power Plant
(Given as reference points)

Figure 2
SKETCH OF CASERN OCCUPIED BY UNIDENTIFIED BORDER GUARD BATTALION IN ORSOVA, RUMANIA

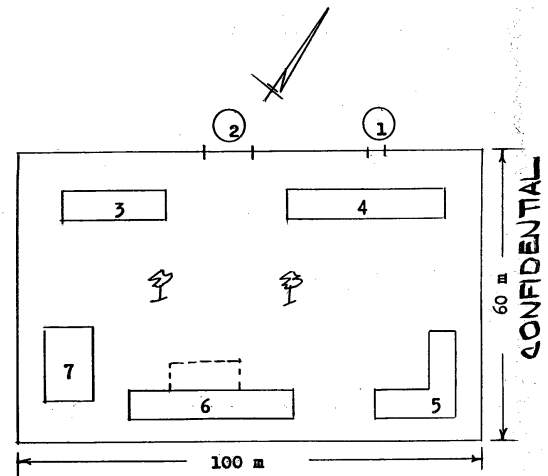

CONFIDENTIAL
-51-

CONFIDENTIAL

50X1-HUM
50X1-HUM

50X1-HUM

CONFIDENTIAL
-52-

50X1-HUM



Legend to Annex X

(Figure 2)

1. Green, wooden, pedestrian gate approximately 1.5 x 1.5 m. One guard armed with a Soviet PPSH SMG was on duty at all times.
2. Green, wooden, vehicle gate approximately 5 to 6 m wide and 1.5 m high. The guard at the pedestrian gate (item 1) had the key for this gate.
3. EM barracks in a two-story, rose stucco building approximately 30 x 10 to 12 m with a red tile, gable roof.
4. Headquarters, unidentified offices, and EM barracks in a two-story, rose stucco building approximately 30 x 10 to 12 m with a red tile, gable roof.
5. A two-story, L-shaped, unidentified rose stucco building with a red tile, gable roof; the south side was 10 x 4 m and the east side was 10 x 4 m.
6. Garage and workshops in a one-story, rose stucco building, approximately 25 x 10 m with a red tile, gable roof. There was a concrete area in front of the building.
7. A two-story, unidentified, rose stucco building, approximately 15 x 10 m with a red tile, gable roof.

CONFIDENTIAL

Annex Y

Figure 1

SKETCH OF LOCATION OF UNIDENTIFIED BORDER GUARD BATTALION IN GOGOS, RUMANIA

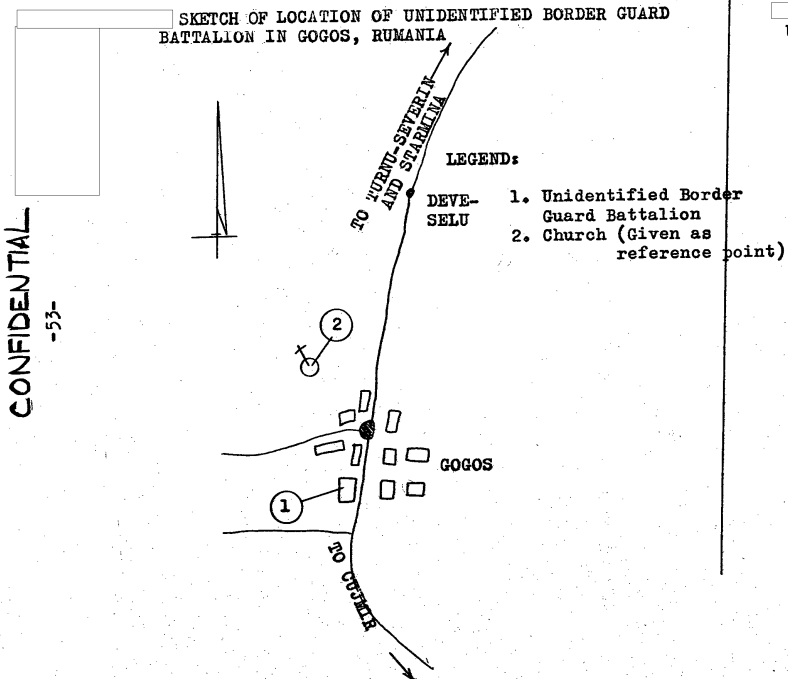
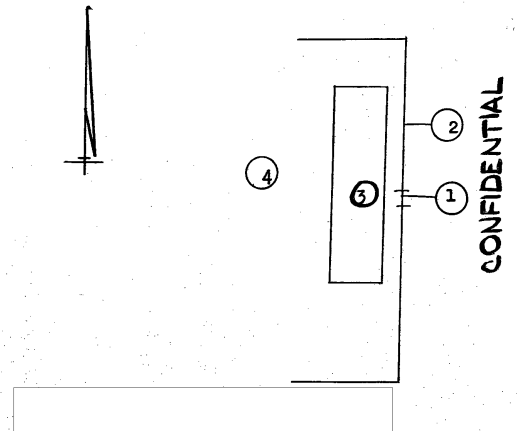

Figure 2

SKETCH OF CASERN OCCUPIED BY UNIDENTIFIED BORDER GUARD BATTALION IN GOGOS, RUMANIA



CONFIDENTIAL

-53-

CONFIDENTIAL

50X1-HUM

50X1-HUM

50X1-HUM

CONFIDENTIAL

-54-



50X1-HUM

Legend to Annex Y

(Figure 2)

50X1-HUM



1. White, wooden pedestrian gate, about 1.5 m wide and 1.5 m high. An unarmed guard was on duty at all times but Source could not identify the guard's weapon.
2. White, wooden fence about 1.8 m high.
3. A one-story, white stucco, unidentified building approximately 30 x 15 m with red tile, gable roof.
4.  several buildings were located here.

50X1-HUM

CONFIDENTIAL

Figure 1

PINPOINT LOCATION OF UNIDENTIFIED BORDER GUARD BATTALION IN CETATE, RUMANIA

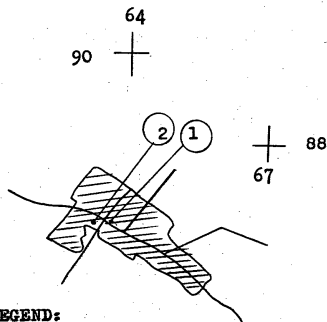

LEGEND:

- 1. HQ Unidentified Border Guard Battalion
- 2. Billets Unidentified Border Guard Battalion

Annex Z

Figure 2

SKETCH OF CASERN OCCUPIED BY UNIDENTIFIED BORDER GUARD BATTALION IN CETATE, RUMANIA

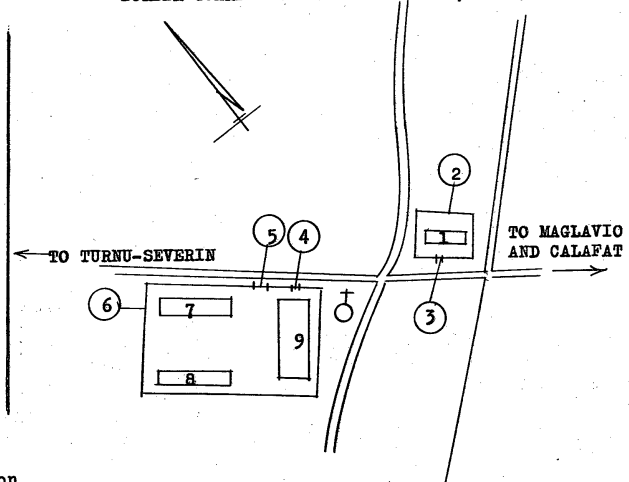

CONFIDENTIAL
-55-

CONFIDENTIAL

50X1-HUM
50X1-HUM

50X1-HUM

50X1-HUM

CONFIDENTIAL

-56-

50X1-HUM



Legend to Annex Z

(Figure 2)

1. Headquarters in a one-story, white, stucco building approximately 20 x 10 m with a red tile, gable roof.
2. White, wooden fence 1.8 m high that enclosed an area 40 x 40 m.
3. Green, wooden, pedestrian gate approximately 1.5 m wide, 1.8 m high. A guard armed with a Soviet PPSH SMG was on duty at all times.
4. Green, wooden, pedestrian gate approximately 1.5 m wide, 1.8 m high. A guard armed with a Soviet PPSH SMG was on duty at all times.
5. Green, wooden, vehicle gate approximately 5 to 6 m wide and 1.8 m high. The guard at the pedestrian gate (item 4) had the keys to this gate.
6. White, wooden fence approximately 150 x 100 x 1.8 m.
7. EM barracks in a one-story, white, stucco building approximately 30 x 10 to 12 m with a red tile, gable roof.
8. Stables in a one-story, white, stucco building 15 to 20 x 8 to 10 m with a red tile, gable roof.
9. EM barracks in a one-story, white, stucco building, approximately 30 x 10 to 12 m with a red tile, gable roof.

CONFIDENTIAL

**PINPOINT LOCATION OF UNIDENTIFIED INFANTRY REGIMENT AND UNIDENTIFIED
MOTORIZED ARTILLERY REGIMENT IN VANJU-MARE, ROMANIA**



CONFIDENTIAL

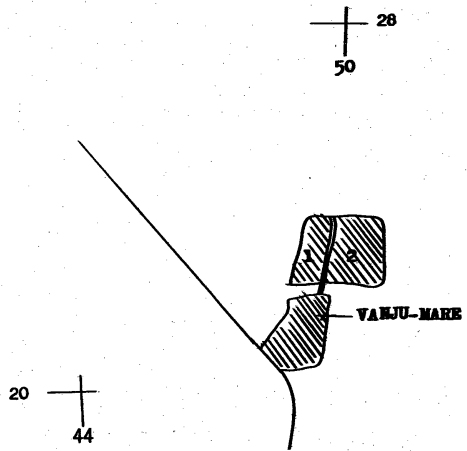

LEGEND:

- 1. Dependent Quarters for above units
- 2. Unidentified Motorized Artillery Regiment and Unidentified Infantry Regiment

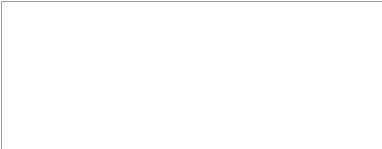

CONFIDENTIAL

50X1-HUM

50X1-HUM

Annex BB

SKETCH OF CASERN OCCUPIED BY UNIDENTIFIED INFANTRY REGIMENT
AND UNIDENTIFIED MOTORIZED ARTILLERY REGIMENT IN VANJU-MARE,
ROMANIA

50X1-HUM

50X1-HUM

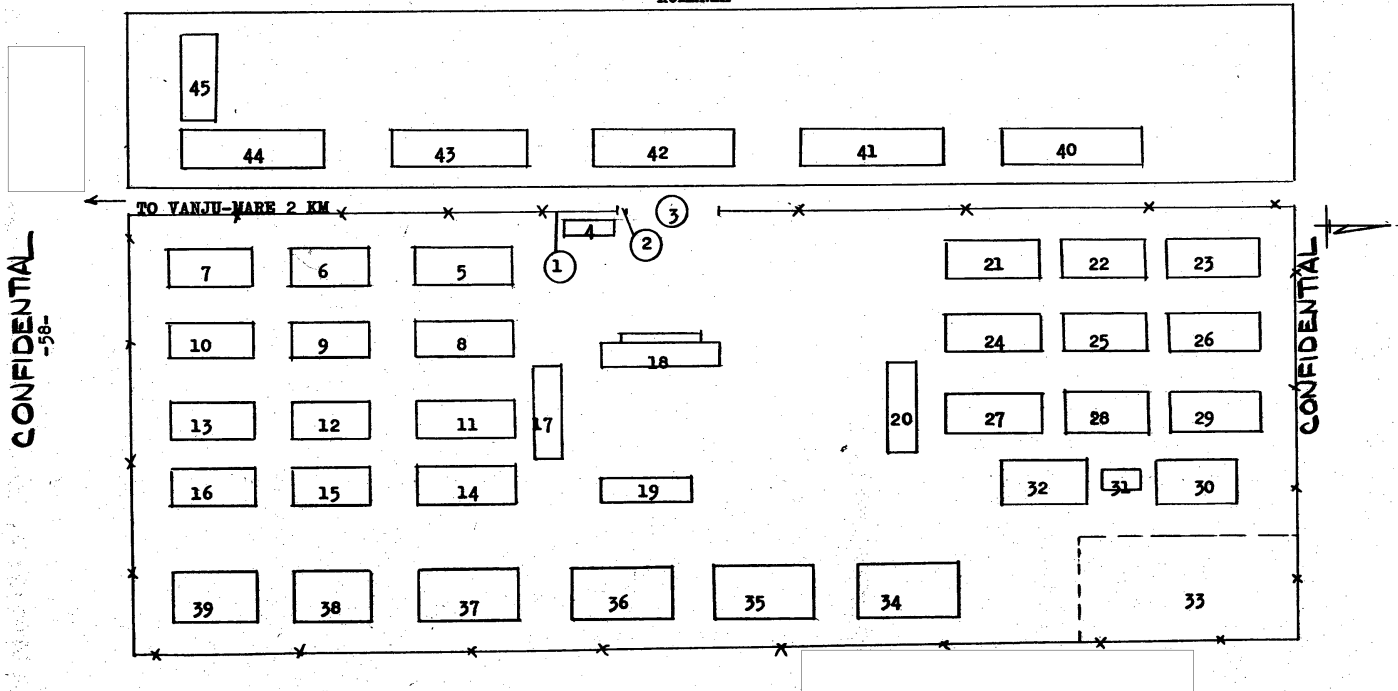

50X1-HUM

CONFIDENTIAL

-59-

50X1-HUM

Legend to Annex BB

1. Barbed wire fence with concrete posts approximately 3.5 m high.
2. White, pedestrian gate constructed with a metal pipe framework with wire mesh, approximately 1.5 m wide and 2.5 m high.
3. White vehicle gate constructed with a metal pipe framework with the lower half a solid piece of steel and the upper half wire mesh, approximately 10 m wide and 2.5 m high.
4. A one-story, guard shack approximately 25 x 10 to 15 m of white stucco with a red tile, gable roof. It contained a small office, a telephone, and bunks for approximately 30 guards. One guard armed with a Soviet PPSH SMG was on duty 24 hours and controlled both the pedestrian gate (item 2) and the vehicle gate (item 3).
- 5 to 17. EM barracks for the unidentified motorized artillery regiment in two-story buildings approximately 100 x 15 m, of white stucco with red tile, gable roofs.
18. Headquarters and other offices for the unidentified infantry regiment and the unidentified motorized artillery regt, in a two-story building approximately 120 x 20 m, of white stucco with a red tile, gable roof.
19. Kitchen in a one-story building approximately 80 x 15 m, of white stucco with a red tile, gable roof.
- 20 to 29. EM barracks for unidentified infantry regiment, same description as 5.
30. Underground food storage area approximately 70 x 25 m and 5 to 6 m deep. It had a gable roof, which extended approximately 1.5 m aboveground.
31. Warehouse for kitchen equipment and unknown food supplies in a one-story building approximately 20 x 10 m, of white stucco, with a red tile, gable roof.
32. Underground food storage area, same description as 30.
33. Open storage area for feed for horses.
34. Ammunition warehouse in an underground area 70 to 80 x 25 to 30 m and 4 to 6 m deep with a black gable roof, which extended about 2 m aboveground.
- 35 to 38. Garages for vehicles and guns in one-story buildings approximately 80 x 30 x 10 m, of white stucco, with red tile, gable roofs. The front of each building had large sliding doors which extended along the entire front.
39. POL dump in a one-story building approximately 80 x 30 x 8 m, of white stucco with a tin, gable roof.
- 40 to 45. Officer and NCO dependents' quarters were two-story buildings approximately 80 x 20 m, of white stucco with red tile, gable roofs.

CONFIDENTIAL

Annex CC

Figure 1

PINPOINT LOCATION OF 7TH BORDER GUARD REGIMENT IN BALA MARE, RUMANIA

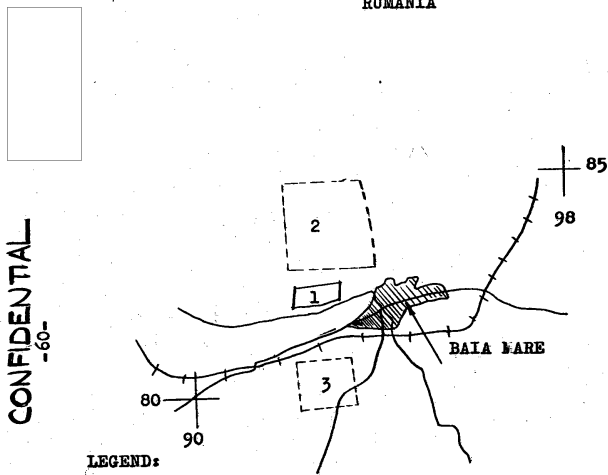

LEGEND:

- 1. 7th Border Guard Regiment
- 2. Training Area
- 3. Training Area

Figure 2

SKETCH OF CASERN OCCUPIED BY 7TH BORDER GUARD REGIMENT IN BALA MARE, RUMANIA

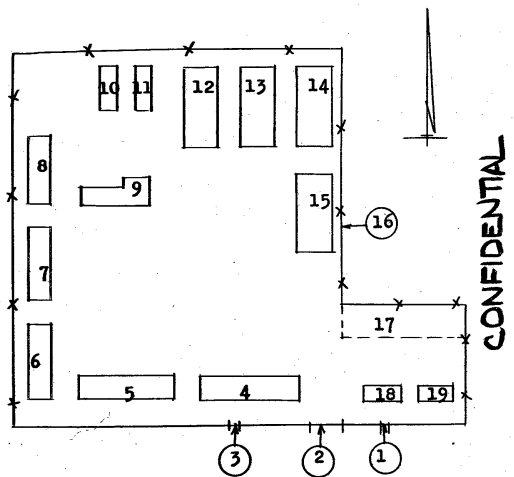

CONFIDENTIAL
-60-

CONFIDENTIAL

50X1-HUM
50X1-HUM

50X1-HUM
50X1-HUM

CONFIDENTIAL

-61-

50X1-HUM

Legend to Annex CC

(Figure 2)

1. Green, pedestrian gate constructed with steel pipe framework and wire mesh, approximately 1.5 m wide and 2.5 m high. A guard armed with a Soviet PPSH SMG was on duty 24 hours.
2. Vehicle gate, approximately 8 m wide and 2.5 m high, same description as 1.
3. Pedestrian gate, same as 1.
4. EM barracks in a three-story building approximately 100 x 15 m, of white stucco with a red tile, gable roof.
5. EM barracks, same description as 4, approximately 80 x 15 m.
6. Mess hall, kitchen, and canteen in a one-story building approximately 80 x 15 m, of white stucco with a red tile, gable roof.
- 7 and 8. EM billets in one-story buildings approximately 60 to 70 x 15 m, of white stucco with red tile, gable roofs.
9. Dispensary in a one-story L-shaped building with the south side 25 x 10 m and the east side 15 x 15 m, of white stucco with red tile, gable roof.
- 10 and 11. Underground food storage areas, 35 to 40 x 15 to 20 m and 4 to 5 m deep.
- 12 to 15. Garages for vehicles and artillery guns in one-story buildings approximately 60 x 30 x 10 m, of wood with brown gable roofs.
16. Barbed wire fence approximately 3m high.
17. Park
18. Headquarters and administrative offices in a two-story building approximately 20 to 25 x 15 m, of white stucco with a red tile, gable roof.
19. Political commander's office and club, same description as 18.

CONFIDENTIAL

CONFIDENTIAL
-62-



50X1-HUM

Annex DD

**PINPOINT LOCATIONS OF MILITARY INSTALLATIONS IN THE AREA OF PITESTI,
RUMANIA**

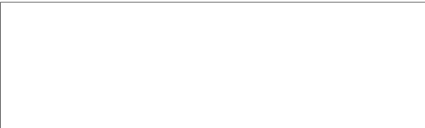

50X1-HUM

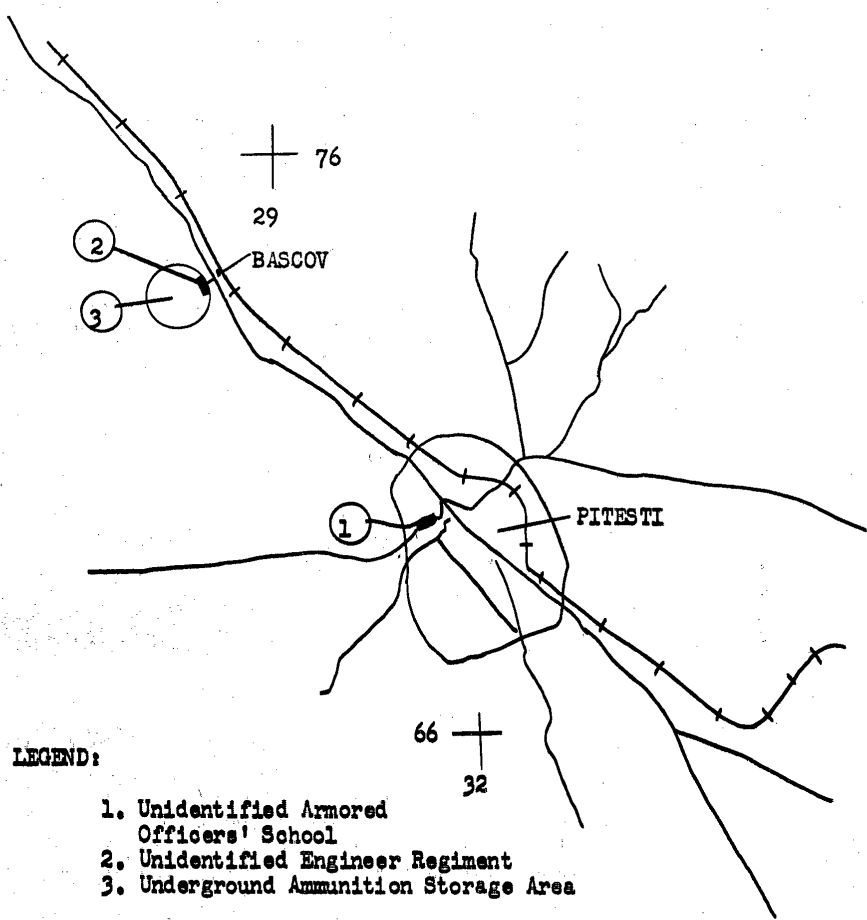

LEGEND:

- 1. Unidentified Armored Officers' School
- 2. Unidentified Engineer Regiment
- 3. Underground Ammunition Storage Area



50X1-HUM

CONFIDENTIAL

Annex EE

SKETCH OF CASERN OCCUPIED BY UNIDENTIFIED ARMORED OFFICERS'
SCHOOL IN PITESTI, RUMANIA

CONFIDENTIAL
-63-

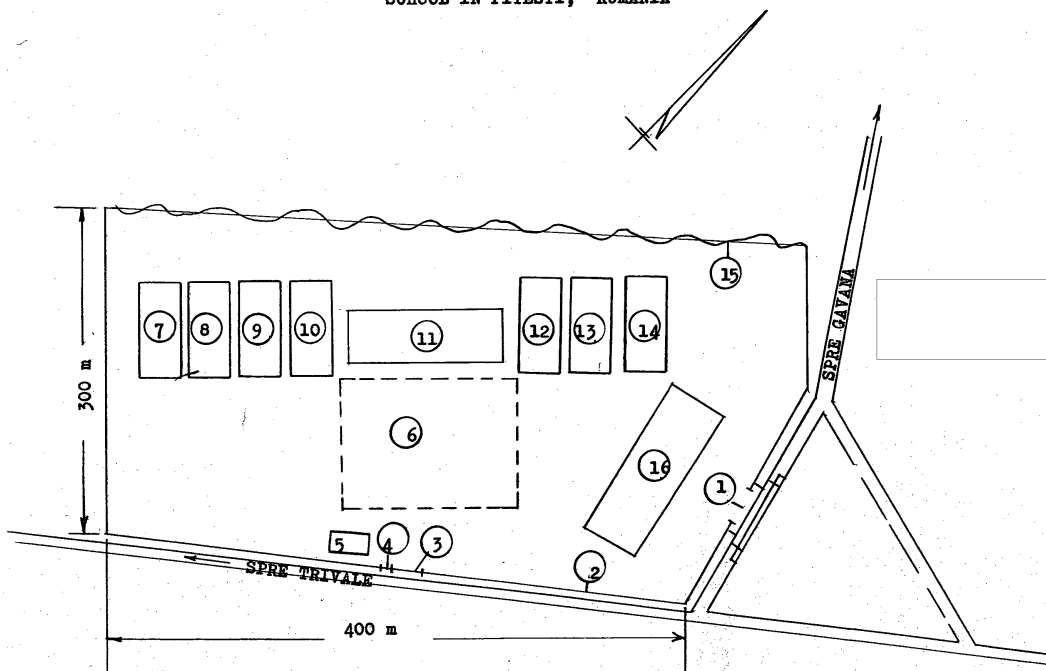

50X1-HUM
50X1-HUM
50X1-HUM

CONFIDENTIAL

-64-

50X1-HUM

Legend to Annex EE

1. Pedestrian gate approximately 6 m wide and 2.5 m high with double door constructed of iron pickets. A large sign above this gate read "REPUBLICA POPULARA ROMANA" (People's Republic of Rumania). Steps led from the street to this gate. One guard armed with a Soviet PPSH SMG was on duty at all times.
2. An iron picket fence approximately 3 m high with a concrete base approximately 40 cm high.
3. Vehicle gate approximately 8 m wide and 2.5 m high with a double door constructed of iron pickets.
4. Pedestrian iron picket gate approximately 1.5 m wide and 2.5 m high.
5. A one-story guard shack approximately 15 x 10 x 5 m, of white stucco with a red tile, gable roof. One guard was on duty at all times, who was responsible for gates mentioned as items 3 and 4.
6. Assembly area.
- 7 to 10. EM barracks in two-story buildings approximately 50 x 15 m, of white stucco with red tile, gable roofs.
11. A three-story unidentified building approximately 80 x 20 m, of white stucco with a red tile, gable roof.
- 12 to 14. EM barracks, same description as 7.
15. Fence
16. Headquarters in a three-story building approximately 60 x 20 m, of white stucco with a red tile, gable roof.

50X1-HUM

CONFIDENTIAL

Annex FF

SKETCH OF CASERN OCCUPIED BY UNIDENTIFIED ENGINEER REGIMENT AND LOCATION OF AN UNDERGROUND AMMUNITION STORAGE AREA IN BASCOV, ROMANIA

50X1-HUM

50X1-HUM

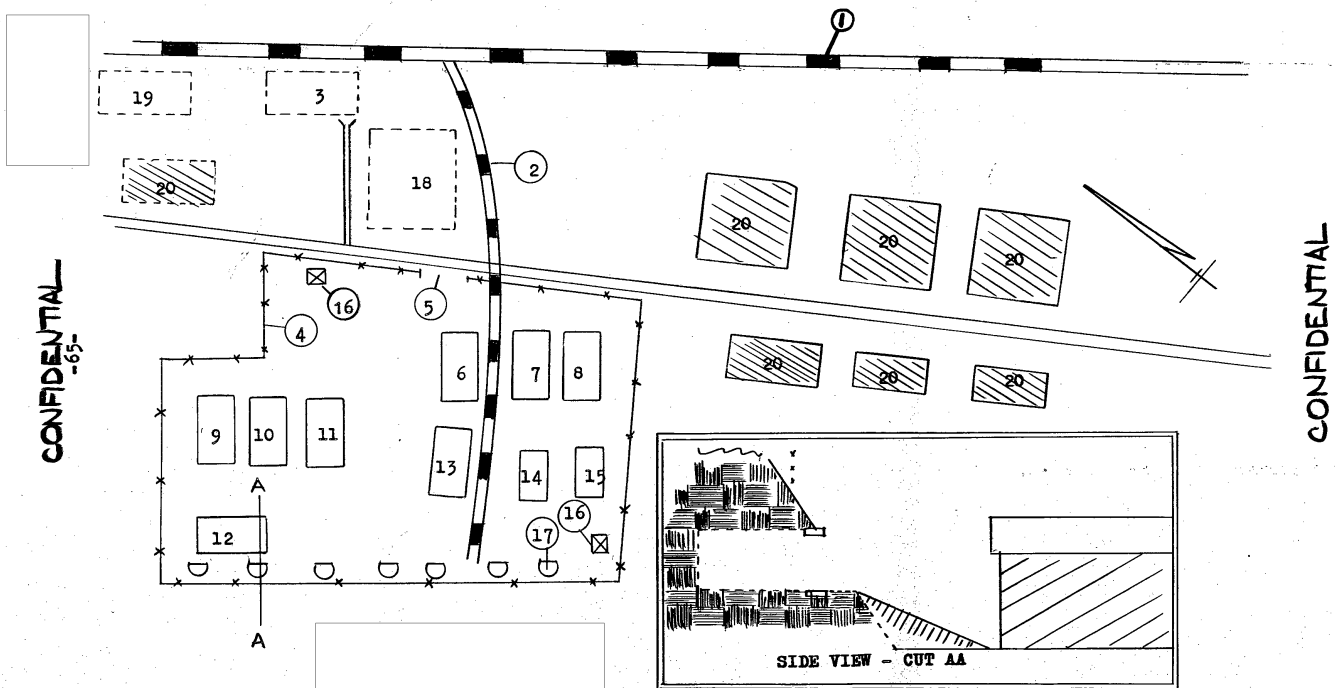

CONFIDENTIAL

50X1-HUM

CONFIDENTIAL

-66-

50X1-HUM



Legend to Annex FF

This casern was located on the side of a hill approximately 80 m high. An unidentified engineer regiment was constructing an underground ammunition storage area into the side of this hill.

1. Main railroad line PITESTI-CURTEA-DE ARGES.
2. Railroad siding constructed in 1954 by unidentified railroad troops.
3. BASCOV railroad station
4. Barbed wire fence approximately 3 m high.
5. Gate approximately 8 m wide and 2.5 m high, with a wooden framework and barbed wire. One guard armed with a Czechoslovak ZB rifle was on duty at all times.
- 6 to 15. Wooden, EM barracks and unidentified warehouses in temporary, one-story buildings approximately 60 x 15 m, painted white with grey tar-paper, gable roofs.
16. Wooden guard towers approximately 5 m high. One guard armed with a Czechoslovak ZB rifle was on duty on each tower during daylight hours.
17. Seven entrances leading into the hill, each approximately 6 m wide and 4 m high.
- 18 and 19. Open storage areas for equipment and supplies used in constructing the underground ammunition storage area.
20. Civilian houses.

CONFIDENTIAL

CONFIDENTIAL
-87-



50X1-HUM

Annex GG

PINPOINT LOCATION OF THE 1ST BORDER GUARD REGT IN GIURGIU, RUMANIA



50X1-HUM

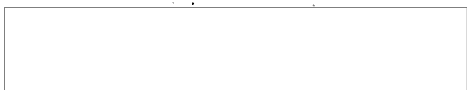
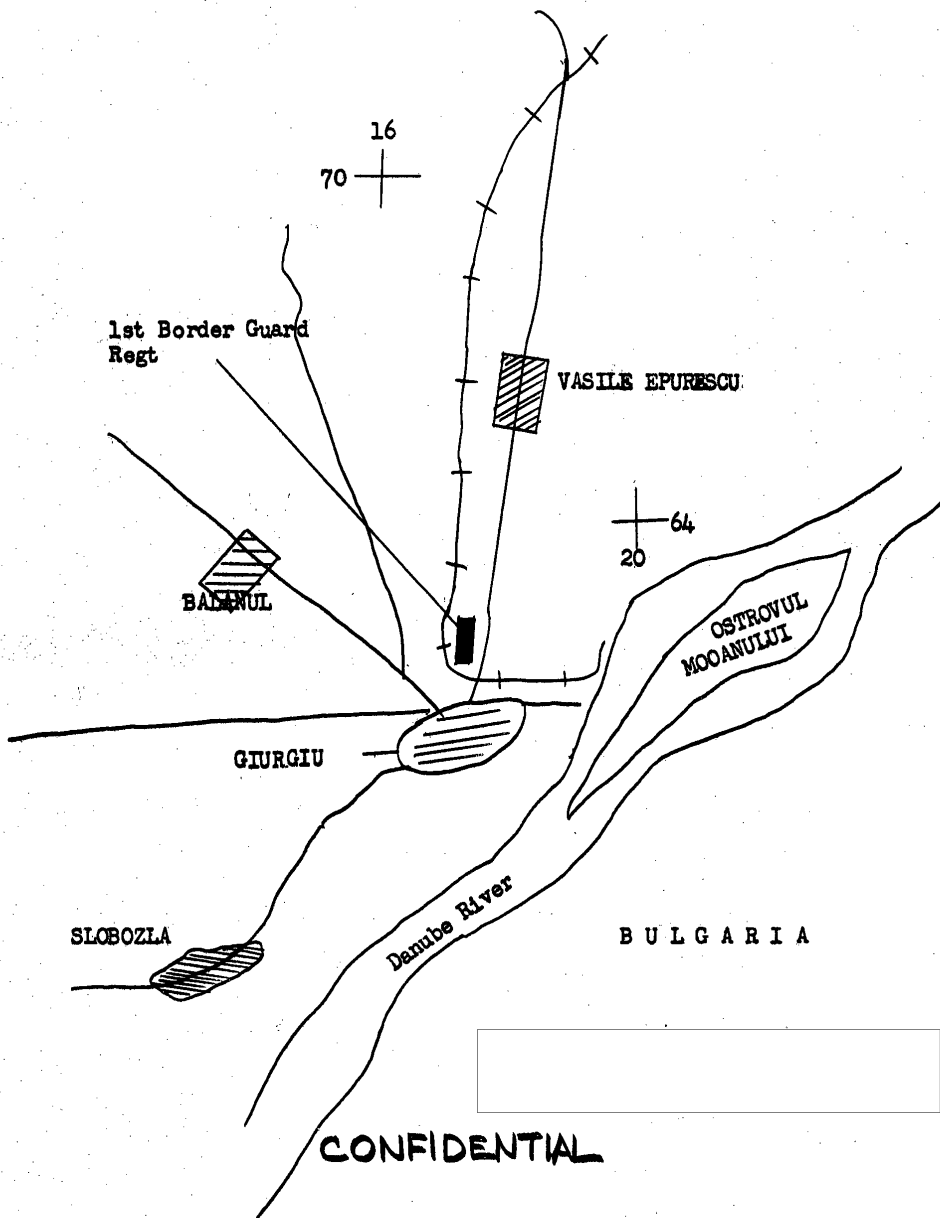

50X1-HUM

CONFIDENTIAL

Declassified in Part - Sanitized Copy Approved for Release 2014/03/04 : CIA-RDP80T00246A026801420001-7

Annex HH

SKETCH OF CASERN OCCUPIED BY THE 1ST BORDER GUARD REGIMENT, IN GIURGIU, ROMANIA

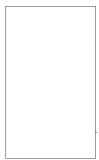
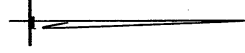

CONFIDENTIAL
-68-

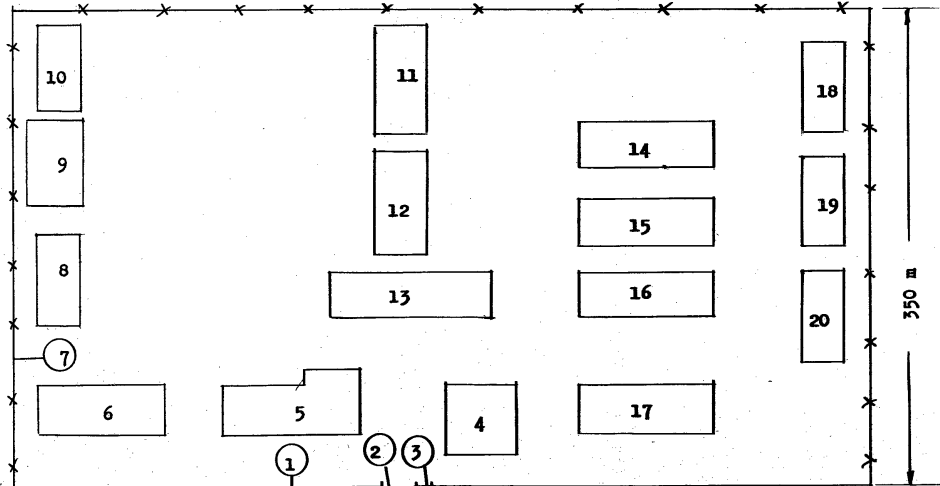

SOSEANA GIURGIU

VASILE EPORESCU

600 m

350 m

CONFIDENTIAL

50X1-HUM

50X1-HUM

50X1-HUM

Declassified in Part - Sanitized Copy Approved for Release 2014/03/04 : CIA-RDP80T00246A026801420001-7

CONFIDENTIAL

-69-

50X1-HUM

Legend to Annex HH

All buildings described were white stucco with red tile, gable roofs.

1. Green iron-picket fence approximately 2 m high with a concrete base about 30 cm high.
2. Vehicle gate with a green, iron-picket, double door approximately 6 m wide and 2 m high.
3. A green iron-picket, pedestrian gate approximately 1.5 m wide and 2 m high. One guard armed with a Soviet PPSH SMG was on duty at all times. He was also responsible for the gate mentioned as item 2.
4. A one-story guard house approximately 15 x 10 m, of white stucco with a red tile, gable roof. It had a sleeping room for guards, a waiting room, and a small office.
5. Headquarters in a three-story, L-shaped building, one wing approximately 60 x 20 m and the other, 25 x 20 m.
6. A three-story, EM barracks approximately 50 x 15 m.
7. Barbed wire fence approximately 2.5 m high.
8. Kitchen and mess hall in a one-story building approximately 60 x 15 m.
9. A one-story garage building approximately 50 x 20 m.
10. A one-story warehouse approximately 40 x 15 x 6 m.
11. Stables and garage for horsedrawn equipment in a one-story building approximately 60 x 15 x 5 m.
12. A one-story warehouse for ammunition and weapons approximately 40 x 10 x 5 m.
13. EM barracks in a three-story building approximately 50 x 15 m.
- 14 to 17. EM barracks in three-story buildings approximately 70 x 15 m.
18. Washrooms in a one-story building approximately 40 x 15 m.
19. Shed with wooden framework and a red tile, gable roof approximately 40 x 15 m.
20. A one-story building approximately 50 x 15 m used by women who ironed, sewed, and washed clothes for the troops assigned to this unit.

CONFIDENTIAL

CONFIDENTIAL

-70-



50X1-HUM

Annex II

**PINPOINT LOCATION OF 14TH BORDER GUARD REGIMENT IN COBADIN,
RUMANIA**

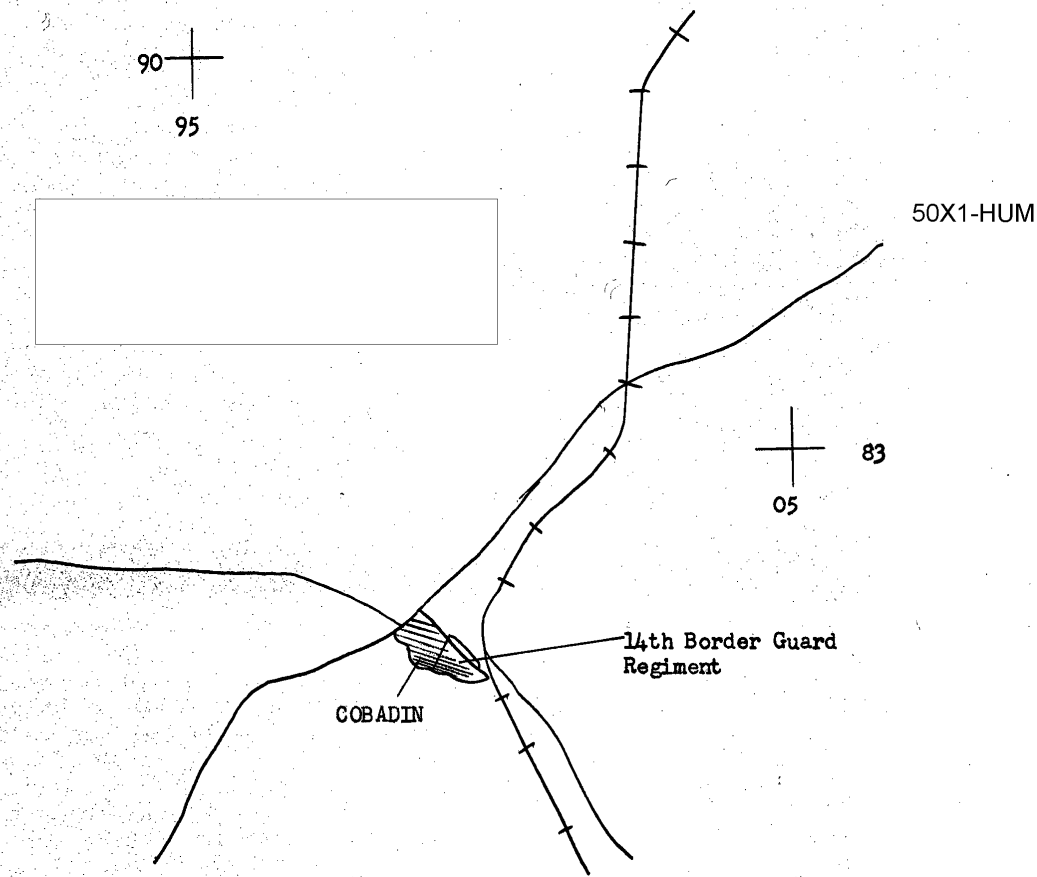

CONFIDENTIAL

Annex JJ
SKETCH OF CASERNS OCCUPIED BY THE 14TH BORDER
GUARD REGT IN COBADIN, RUMANIA

50X1-HUM

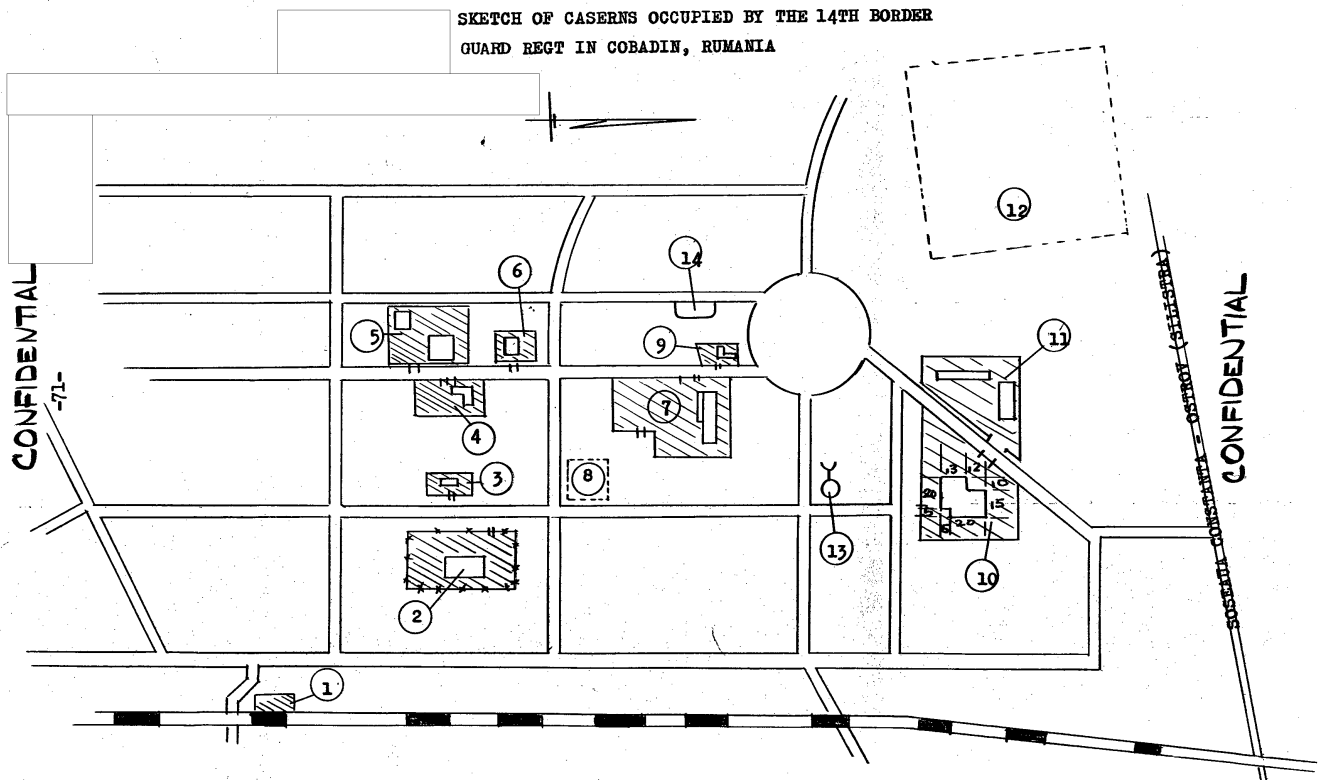

CONFIDENTIAL

-72-

50X1-HUM

Legend to Annex JJ

1. Main railroad station (Given as reference point).
2. A one-story ammunition warehouse approximately 50 x 15 x 10 m, of red stucco with a red tile, gable roof. It had a concrete base, which extended approximately 1.5 m below ground and 1 m aboveground. Two, large, wooden doors were located on both sides of this building, which was in an area approximately 150 x 60 m that was enclosed with a barbed wire fence approximately 3m high. There were two barbed wire fences approximately 1 m apart with barbed wire strung between them. Two guards armed with Czechoslovak ZB rifles were on duty at all times.
3. An intervention platoon was quartered in this one-story building, which was approximately 25 x 10 m, of white stucco with a red tile, gable roof. The building was located in an area approximately 50 x 30 m and enclosed with a stone fence approximately 1.5 m high. It had an open entrance where one guard armed with a Czechoslovak ZB rifle was on duty at all times.
4. Rear service office in an L-shaped, two-story building, the wings approximately 25 x 10 m and 15 x 10 m, of white stucco with a grey tar-paper gable roof. This building was located in an area approximately 100 x 50 m and enclosed with a white, wooden, picket fence approximately 1.8 m high. It had two wooden gates, one for vehicles and one for pedestrians. One guard armed with a Czechoslovak ZB rifle was on duty at all times.
5. Warehouse for food supplies, stables, and blacksmith shop. The white stucco warehouse with a red tile, gable roof was one-story building approximately 25 x 10 x 5 m. The stables and blacksmith shop were located in another building, which was approximately 20 x 10 x 5 m, of white stucco with a red tile, gable roof. These buildings were located in an area approximately 100 x 50 m, which was enclosed with a rock fence approximately 1.5 m high. There was an open entrance approximately 6 m wide and one guard armed with an unrecalled weapon was on duty at all times.
6. Warehouse for clothing, weapons, and other unrecalled military supplies and equipment in a one-story building approximately 20 x 10 x 5 m, of white stucco with a red tile, gable roof. It was located in an area approximately 60 x 60 m, which was enclosed with a rock fence approximately 1.5 m high. There was an open entrance approximately 6 m wide and one guard armed with a Czechoslovak rifle was on duty at all times.
7. Administrative company building (offices, sleeping quarters for approximately 40 troops, kitchen, and mess hall) was in a one-story building approximately 80 x 15 m, of white stucco with a grey tile, gable roof. It was located in an area approximately 150 x 100 m, which was enclosed with a wooden, picket fence approximately 1.8 m high. There were two vehicle gates and one pedestrian gate and each was guarded by an armed guard.
8. Sport field used by this unit.
9. An L-shaped, one-story dispensary, each wing approximately 25 x 10 m, of white stucco with a grey tile, gable roof. It was located in an area approximately 50 x 35 m, which was enclosed with a wooden, picket fence approximately 1.8 m high. It had two gates, a vehicle gate and a pedestrian gate, and one guard armed with a Soviet PFSH SMG was on duty at all times.

CONFIDENTIAL

CONFIDENTIAL

-73-



50X1-HUM

Legend to Annex JJ, continued

10. Headquarters in a two-story building, which was constructed of white stucco with a red tile, gable roof. It was located in an area approximately 250 x 150 m, which was enclosed with a wooden, picket fence, approximately 2 m high. It had a vehicle gate and a pedestrian gate, and a guard armed with a Soviet PPSH SMG was on duty at all times at each gate.
11. EM quarters and stables. The EM barracks was a one-story building approximately 10 x 8 x 5 m, of white stucco with a grey tile, gable roof. These buildings were located in an area approximately 250 x 100 m, which was enclosed with a rock fence approximately 1.5 m high. It had an open entrance, and a guard armed with a Soviet PPSH SMG was on duty at all times.
12. Regimental training area.
13. Turkish mosque (Given as reference point only).
14. Telephone and telegraph office. (Given as reference point only).

CONFIDENTIAL

CONFIDENTIAL
-74-

50X1-HUM



Annex KK

**PINPOINT LOCATION OF UNIDENTIFIED BORDER GUARD BATTALION IN
BANEASA, RUMANIA**



50X1-HUM

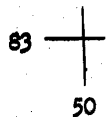
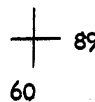
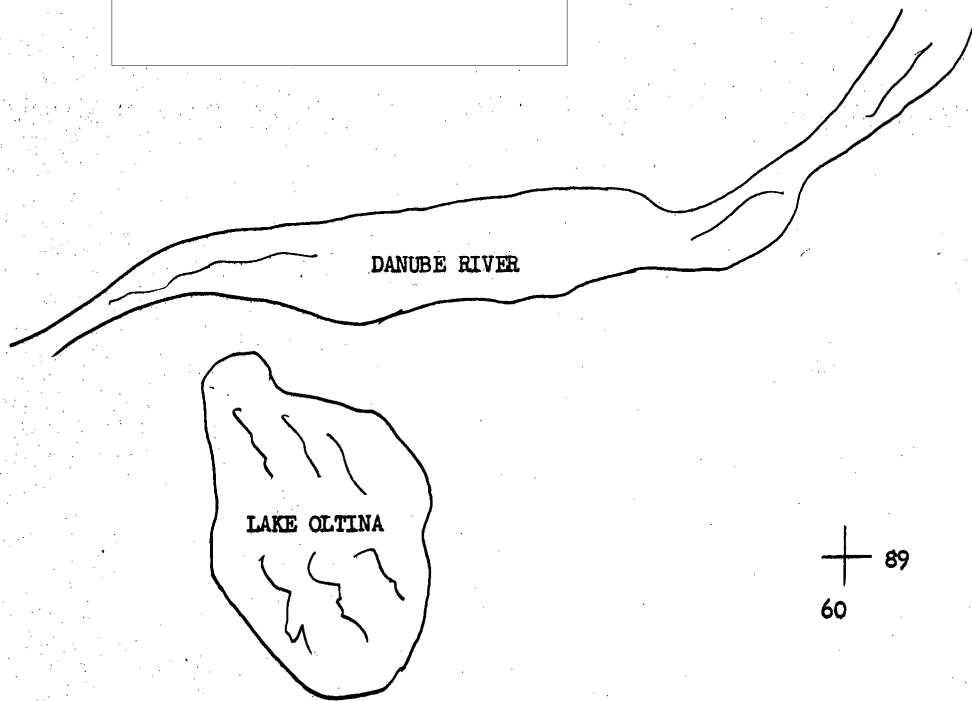

U/i Border Guard
Bn

BANEASA



50X1-HUM

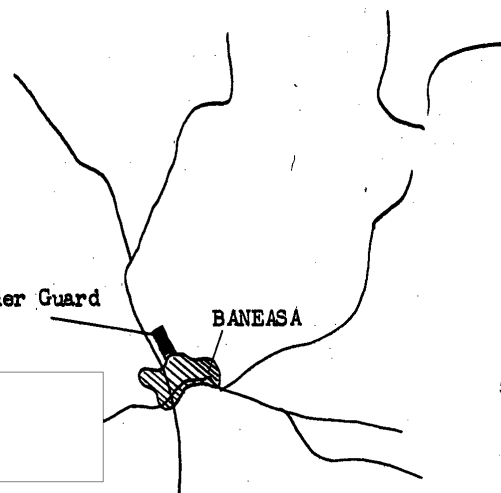

CONFIDENTIAL

Annex LL

SKETCH OF CASERN OCCUPIED BY UNIDENTIFIED BORDER GUARD BATTALION IN BANEASA, RUMANIA

50X1-HUM

50X1-HUM

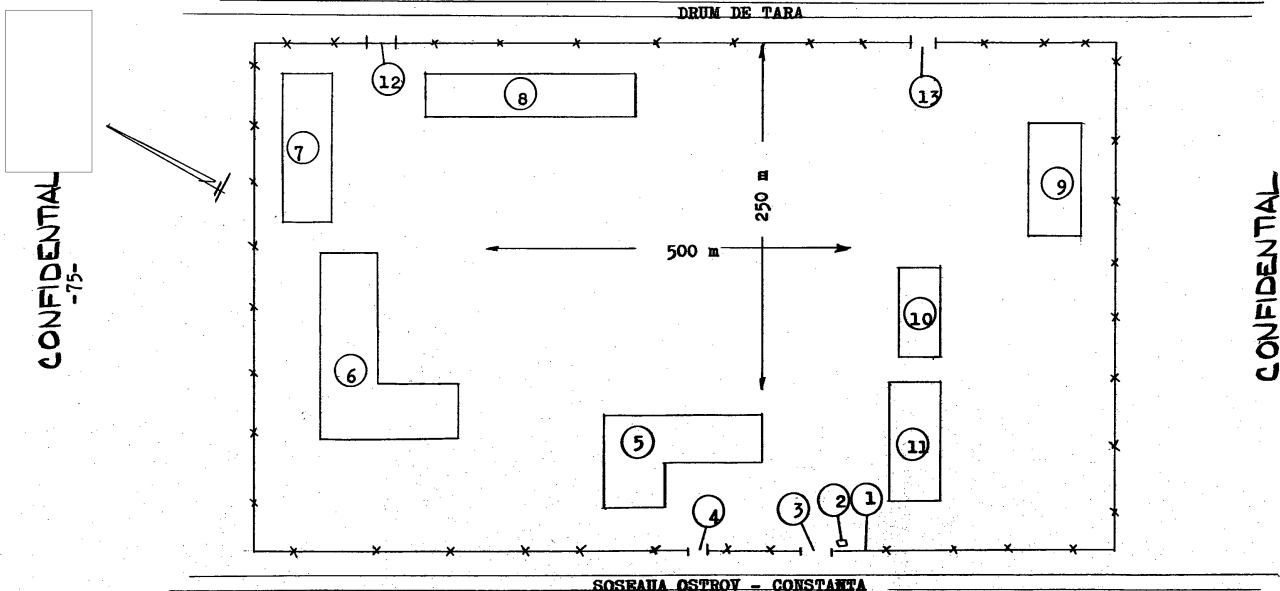

50X1-HUM

CONFIDENTIAL

-76-

50X1-HUM

Legend to Annex LL

1. Barbed wire fence approximately 2.5 m high.
2. A one-story wooden guard shack approximately 1.5 x 1.5 x 2.5 m. One guard armed with a Soviet PPSH SMG was on duty at all times.
3. A double door vehicle gate approximately 8 m wide and 2.5 m high, with a wooden frame and barbed wire.
4. Pedestrian gate approximately 1.5 m wide and 1.5 m high with a wooden frame and barbed wire. One guard armed with a Soviet PPSH SMG was on duty at all times.
5. Headquarters and dispensary in a one-story, L-shaped building; the wings approximately 30 x 10 m and 15 x 10 m, of white stucco with a red tile, gable roof.
6. EM barracks, kitchen, and mess hall in a one-story, L-shaped building; the wings were approximately 60 x 20 m and 40 x 20 m, of white stucco with a red tile, gable roof.
7. Stables in a one-story building approximately 25 x 15 x 5 m, of white stucco with a red tile, gable roof.
8. Hitching post for horses. A gable roof 50 x 20 m, supported by wooden framework, was constructed over this hitching post to protect the horses from the weather.
9. Bakery and warehouse in a one-story building approximately 50 x 15 m, of white stucco with a red tile, gable roof.
10. Club, day room, and class room in a one-story building approximately 20 x 10 m, of white stucco with a red tile, gable roof.
11. Intervention platoon barracks and arms room in a one-story building approximately 35 x 15 m, of white stucco with a red tile, gable roof.
- 12 and 13. Vehicle gates, same description as 3. One guard armed with a Czechoslovak ZB rifle was responsible for both gates. These gates were only opened when directed by the CO.

CONFIDENTIAL

CONFIDENTIAL

-77-



50X1-HUM

Annex MM

**PINPOINT LOCATION OF UNIDENTIFIED INFANTRY REGIMENT AND UNIDENTIFIED
MILITARY PRISON IN TARGU-JIU, RUMANIA**

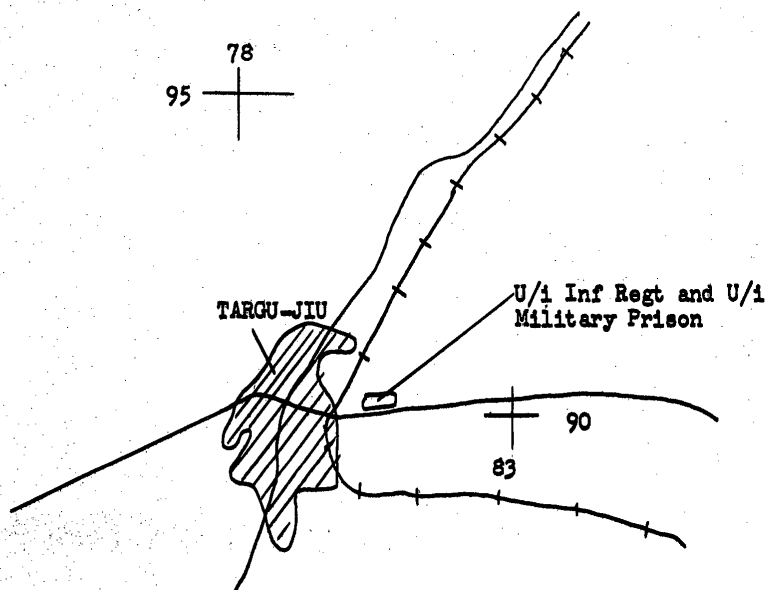

50X1-HUM

CONFIDENTIAL

SKETCH OF CASERN OCCUPIED BY UNIDENTIFIED INFANTRY
REGIMENT AND UNIDENTIFIED MILITARY PRISON IN TARGU-JIU,
RUMANIA

CONFIDENTIAL
-78-

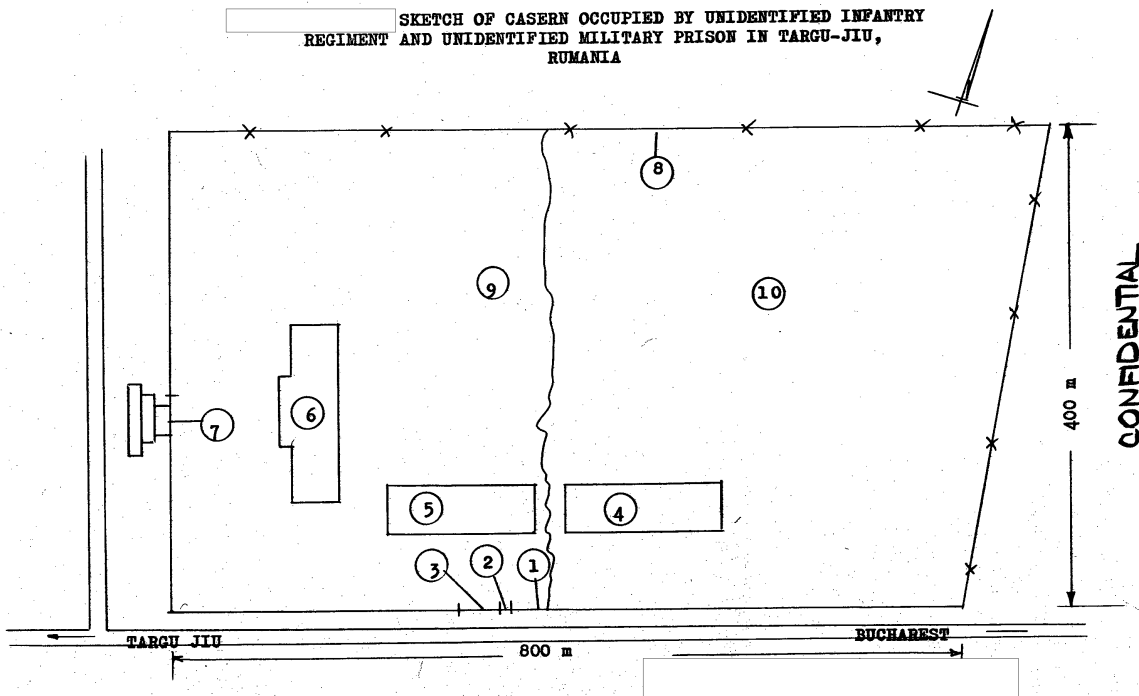

50X1-HUM

50X1-HUM



50X1-HUM

CONFIDENTIAL
-79-



50X1-HUM

Legend to Annex NN

1. Concrete fence approximately 2 m high.
2. Iron picket pedestrian gate approximately 1.5 m wide and 1.8 m high.
3. Double door, iron-picket, vehicle gate approximately 6 m wide and 2 m high. One guard armed with a Czechoslovak ZB rifle was on duty at all times and was also responsible for the gate mentioned as item 2.
4. A three-story, unidentified building approximately 70 x 20 m, of white stucco with a red tile, gable roof.
5. Unidentified building, same description as 4.
6. Probably the headquarters of the unidentified infantry regiment, in a three-story building approximately 80 x 20 m, of white stucco with a red tile, gable roof.
7. Open entrance approximately 6 m wide. One guard armed with a Soviet PPSH SMG was on duty at all times. Steps led from the street to this gate.
8. Barbed wire fence approximately 3.5 m high.
9.  there were many buildings located here. 50X1-HUM
10.  there were many buildings located here which belonged to an unidentified military prison. 50X1-HUM

CONFIDENTIAL

CONFIDENTIAL
-80-



50X1-HUM

Annex 00

PINPOINT LOCATION OF AMMUNITION STORAGE AREA NEAR DENTA, RUMANIA



50X1-HUM

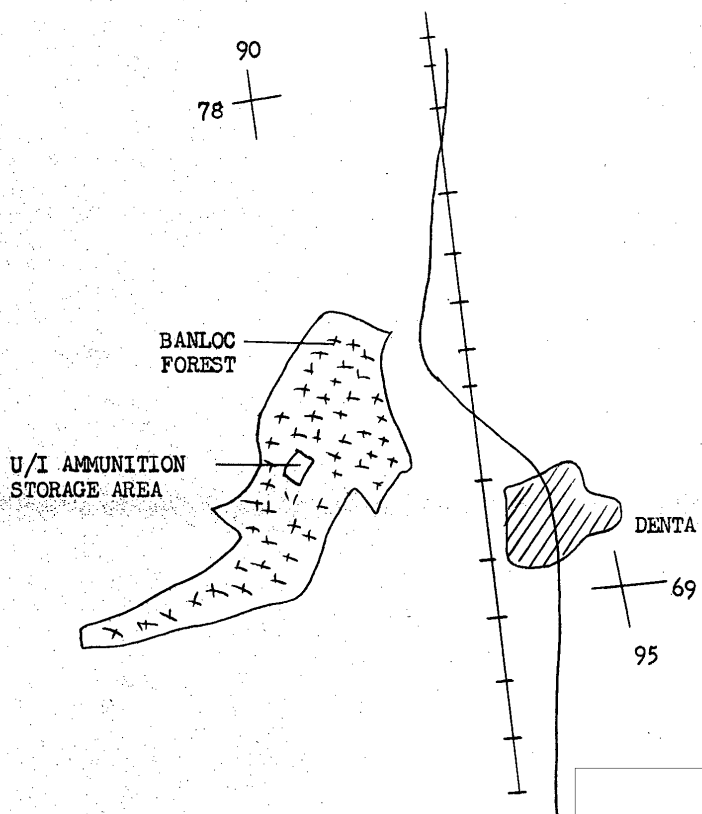

50X1-HUM

CONFIDENTIAL

Annex PP

SKETCH OF UNIDENTIFIED AMMUNITION STORAGE AREA NEAR DENTA, RUMANIA

50X1-HUM

50X1-HUM

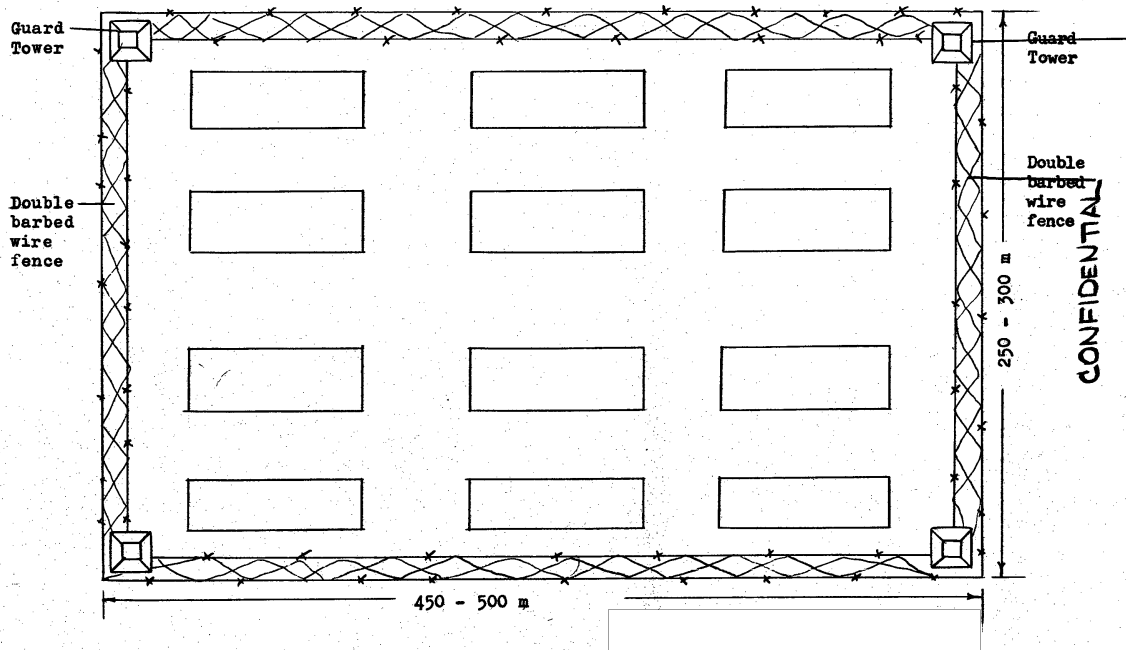

CONFIDENTIAL
-81-

CONFIDENTIAL

50X1-HUM

CONFIDENTIAL

-82-

50X1-HUM

Legend to Annex PP

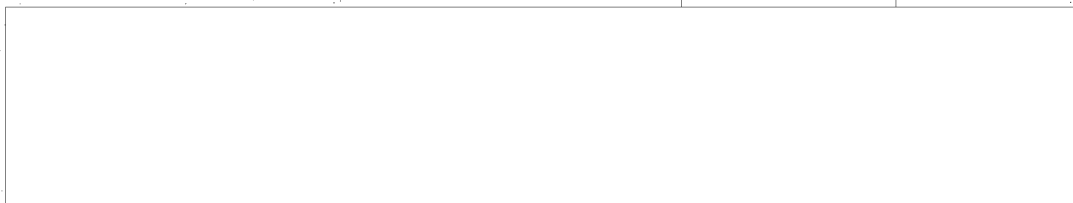
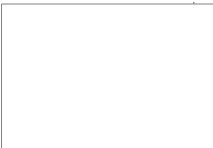

observed approximately 12, one-story warehouses, approximately 70 x 30 x 6 m, constructed of white stucco with red-tile gable roofs. Two barbed wire fences, approximately 3 m high with 1.5 m between them, surrounded this installation. There were four wooden guard towers approximately 6 meters high also located here. One guard with an unidentified weapon was on duty on each tower.

CONFIDENTIAL

CONFIDENTIAL

50X1-HUM

-83-
Annex QQ

PINPOINT LOCATION OF MILITARY INSTALLATIONS

IN ORADEA, RUMANIA

LEGEND:

- 1. Unidentified Cavalry Regiment
- 2. 10th Border Guard Regt and Securitate Intervention Bn
- 3. Ministry of Interior Officers' School Nr 3
- 4. Unidentified Inf Division
- 5. Ministry of Interior Officers' School Nr 2

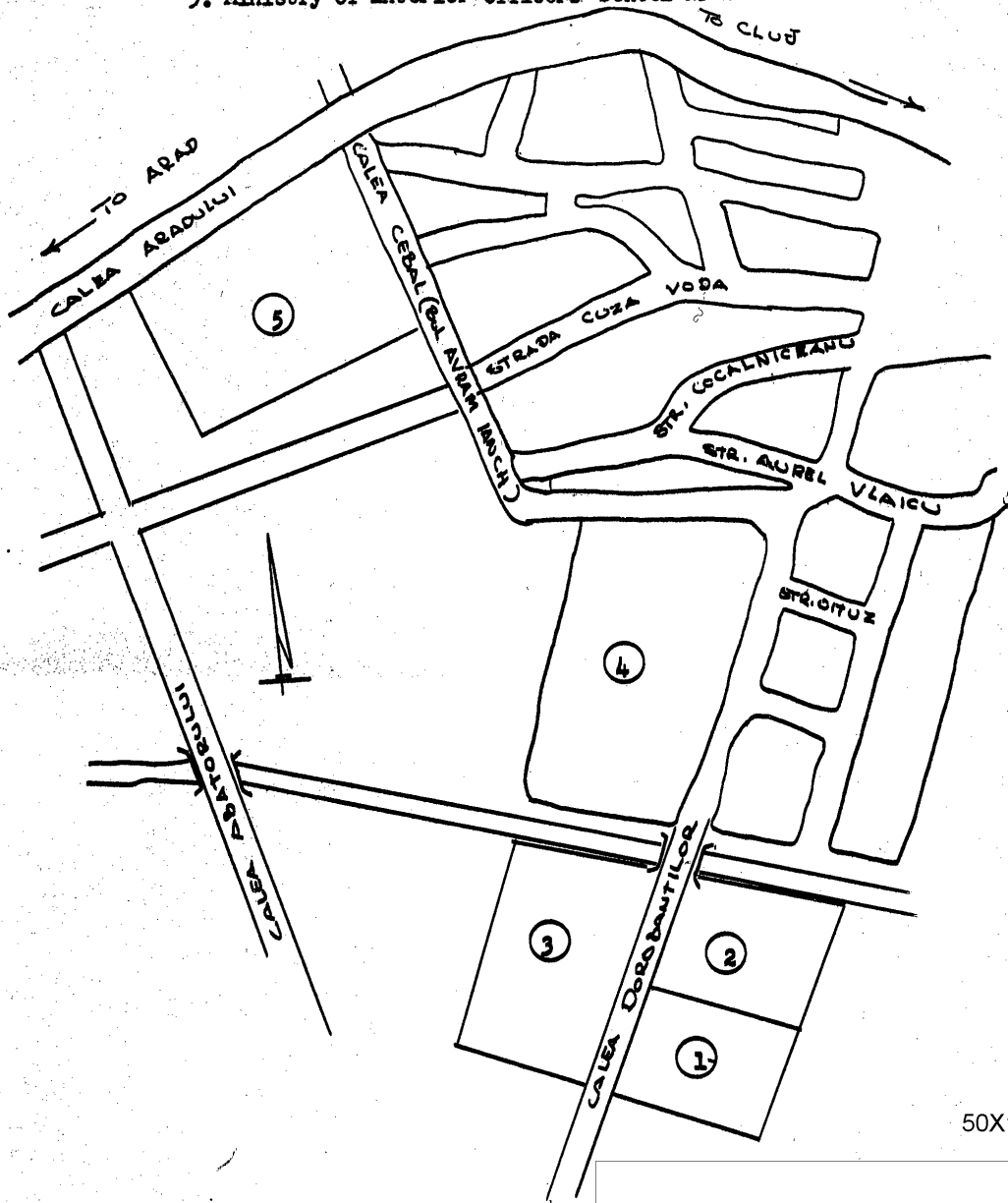

50X1-HUM

CONFIDENTIAL

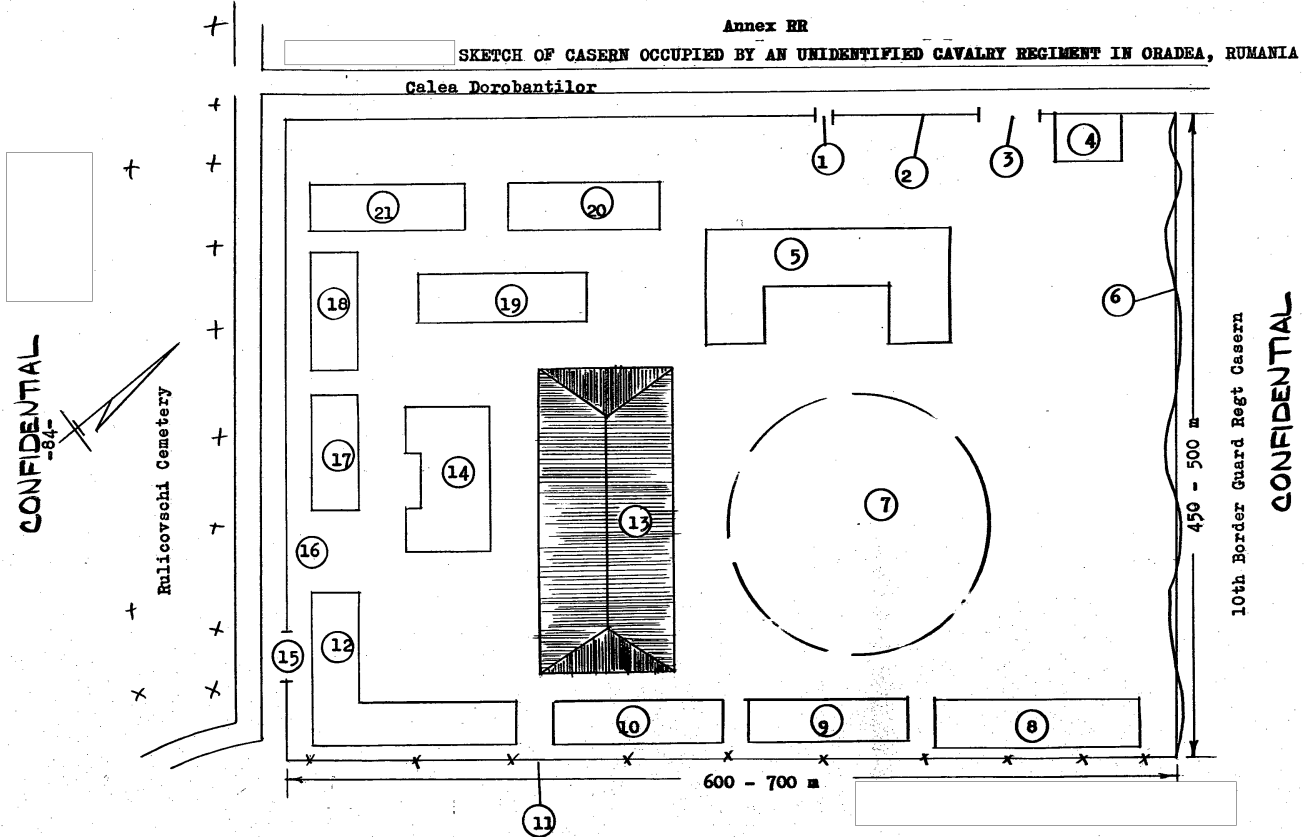

50X1-HUM

50X1-HUM

50X1-HUM

CONFIDENTIAL

-85-

50X1-HUM



Legend to Annex RR

1. A black iron-picket pedestrian gate approximately 1.5 m wide and 2.5 m high. A guard armed with a Soviet PPSH SMG was on duty at all times.
2. A black, iron-picket fence approximately 3 m high with a cement base approximately 30 cm high.
3. A double door, black, iron-picket, vehicle gate approximately 8 m wide and 2.5 m high. A guard armed with a Soviet PPSH SMG was on duty at all times.
4. A one-story guard shack approximately 10 x 10 m, of white stucco with a red tile, gable roof.
5. Headquarters, administrative offices, classrooms, and club in a U-shaped, three-story building, the front section 75 to 80 x 25 m and the wings 50 x 15 m, of white stucco with a red tile, gable roof.
6. Open field to the 10th Border Guard Regt area.
7. Training field for horses.
- 8 to 10. Stables were one-story buildings approximately 80 x 20 x 8 m, of white stucco with red tile, gable roofs.
11. Barbed wire fence approximately 3.5 m high.
12. Stables in an L-shaped, one-story building, both wings approximately 100 x 20 x 8 m, of white stucco with a red tile, gable roof.
13. Hitching post for horses was a wooden structure with a gable roof and framework approximately 200 x 25 m.
14. Blacksmith shop and repair shop in a one-story building approximately 50 x 20 x 6 m, of white stucco with a red tile, gable roof.
15. A double door vehicle gate with iron framework and barbed wire, approximately 8 m wide and 2.5 m high. A guard armed with a Czechoslovak ZB rifle was on duty at all times.
16. A grey, stucco fence approximately 3.5 m high.
- 17 to 21. Two-story EM barracks approximately 70 x 15 m, of white stucco with a red tile, gable roof.

CONFIDENTIAL

Annex SS

SKETCH OF CASERN OCCUPIED BY HEADQUARTERS 10TH
BORDER GUARD REGT IN ORADEA, RUMANIA

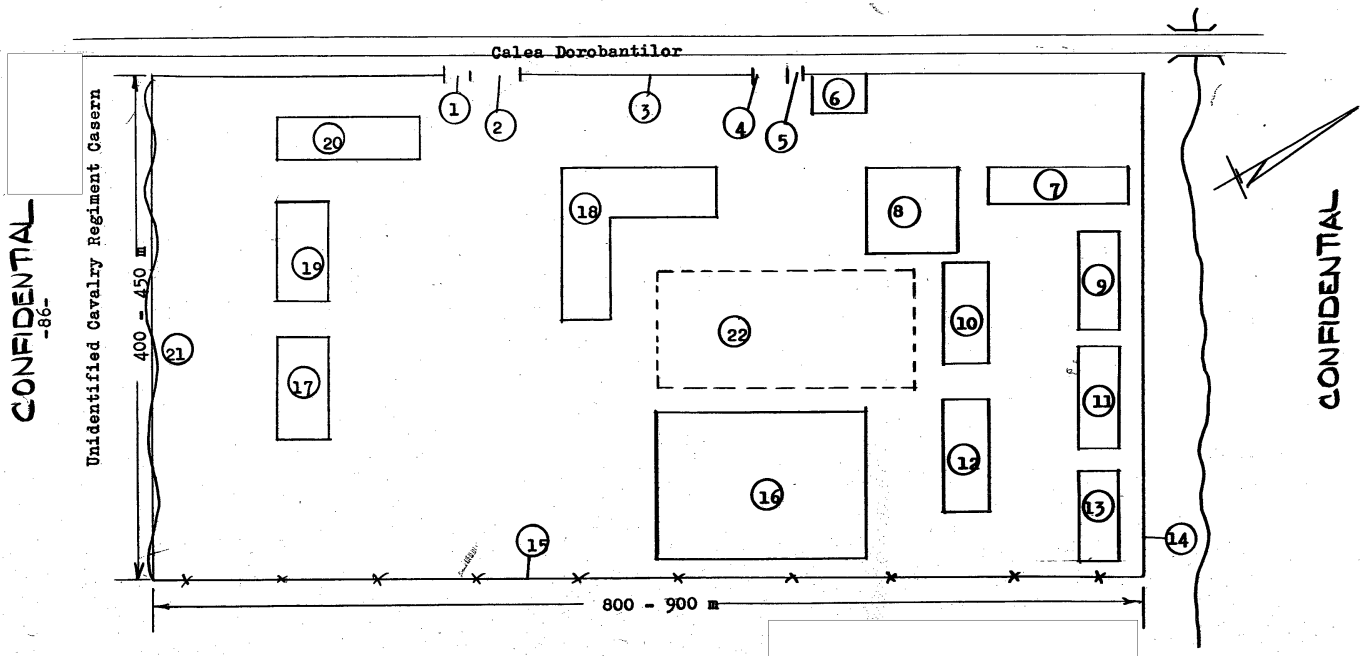

50X1-HUM

50X1-HUM

50X1-HUM

CONFIDENTIAL

-87-



50X1-HUM

Legend to Annex SS

1. An iron picket pedestrian gate approximately 1.5 m wide and 2.5 m high.
2. An iron picket, double-door, vehicle gate approximately 8 m wide and 2.5 m high. One guard armed with a Soviet PPSH SMG was on duty at all times. This guard was also responsible for the gate mentioned as item 1.
3. A green, iron-picket fence approximately 3 m high with a concrete base approximately 30 cm high.
4. Vehicle gate, same description as 2.
5. Pedestrian gate, same description as 1.
6. A one-story guard shack approximately 10 x 8 x 6 m, of white stucco with a red tile, gable roof.
7. A three-story EM barracks approximately 80 x 25 m, of white stucco with a red tile, gable roof.
8. Headquarters and administrative offices in a three-story building approximately 50 x 50 m, of white stucco with a red tile, gable roof.
- 9 to 13. EM barracks, same description as 7.
14. A grey stucco fence approximately 4 m high.
15. Barbed wire fence approximately 3.5 m high.
16. Garage for vehicles and other equipment in a one-story building approximately 150 x 60 x 10 m, of white stucco with a red tile, gable roof.
17. EM barracks, same description as 7.
18. Unidentified offices and EM barracks in a three-story building approximately 60 m long on both wings and 20 m wide, of white stucco with a red tile, gable roof.
19. EM barracks, same description as 7.
20. Secret Police (Securitate) Intervention Battalion in a two-story building approximately 60 x 15 m, of white stucco with a red tile, gable roof.
21. Open area which led to an unidentified cavalry regiment.
22. Assembly area.

CONFIDENTIAL

Annex FF

██████████ SKETCH OF CASERN OCCUPIED BY THE MINISTRY OF INTERIOR
OFFICERS' SCHOOL NUMBER 3 IN ORADEA, ROMANIA

50X1-HUM

50X1-HUM

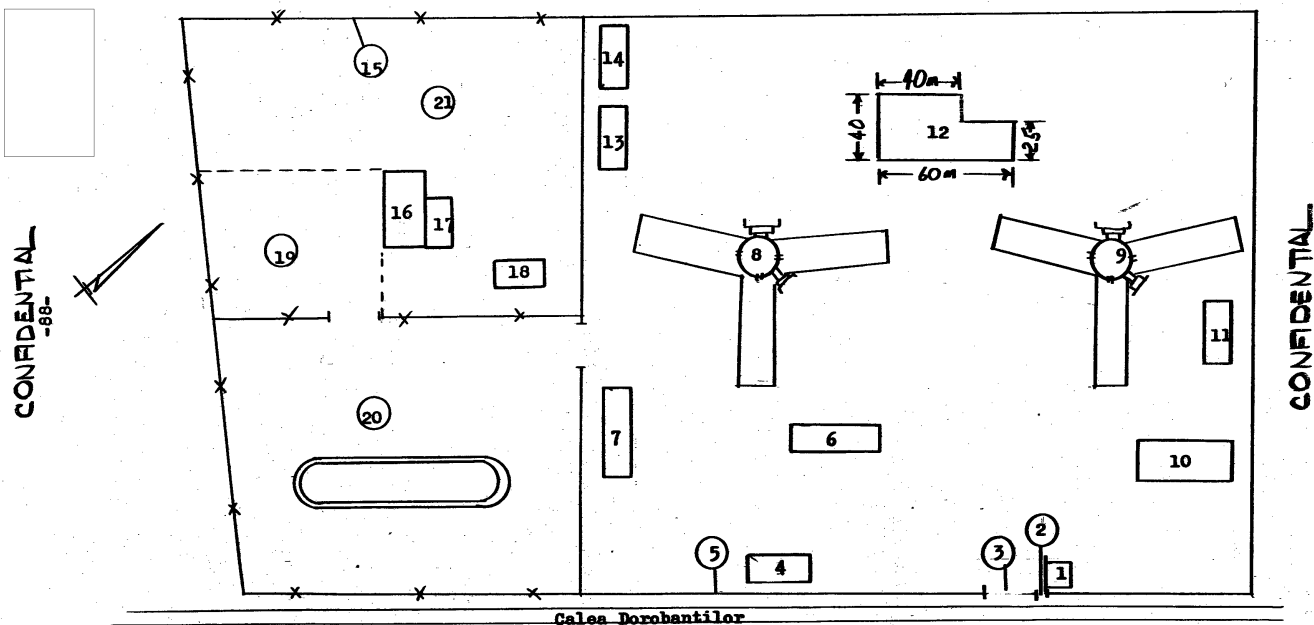

CONFIDENTIAL
-88-

CONFIDENTIAL

50X1-HUM

CONFIDENTIAL

-89-

50X1-HUM

Legend to Annex TT

1. A one-story guard shack approximately 8 x 8 m, of white stucco with a red tile, gable roof. One guard armed with a Soviet PPSH SMG was on duty at all times. In this building were an office and approximately 20 bunks for guards.
2. An iron-picket, pedestrian gate approximately 1.5 m wide and 2.5 m high.
3. An iron-picket, two-door, vehicle gate approximately 8 m wide and 2.5 m high.
4. A one-story jail house approximately 8 x 4 m, of white stucco with a red tile, gable roof.
5. An iron picket fence approximately 3 m high with a concrete base approximately 80 cm high.
6. Classrooms in a three-story building approximately 30 x 15 m, of white stucco with a red tile, gable roof.
7. An old, wooden, one-story warehouse approximately 30 x 10 x 7 m with a tar-paper gable roof.
8. EM barracks and mess hall in a Y-shaped, three-story building approximately 60 m long at each wing and 20 m wide, of white stucco with a red tile, gable roof. Mess hall was located in the basement.
9. EM barracks, mess hall, and kitchen, same description as 8.
10. Headquarters in a two-story building approximately 50 x 30 m, of white stucco with a red tile, gable roof.
11. Dispensary and canteen (PX) in a two-story building approximately 25 x 15 m, of white stucco with a red tile, gable roof.
12. Central heating plant, repair shop for weapons, indoor swimming pool, and washrooms in a one-story building, which was constructed of white stucco with a red tile, gable roof.
13. and 14. Underground food storage areas, each approximately 40x20m and 4 to 5 m deep.
15. Barbed wire fence approximately 3 m high.
16. Open shed approximately 20 x 10 x 6 m, with a black tar-paper gabled roof. It was used for storing hay.
17. Stables in a one-story building approximately 15 x 10 m, of unpainted wood with a black tar-paper gable roof.
18. A one-story shed for garden tools approximately 6 x 4 m, of unpainted wood with a black tar-paper gable roof.
19. Training Area.
20. Sports field.
21. Flower garden.

CONFIDENTIAL

Annex UU

SKETCH OF CASERN OCCUPIED BY UNIDENTIFIED INFANTRY DIVISION IN ORADEA, RUMANIA

CONFIDENTIAL
-90-

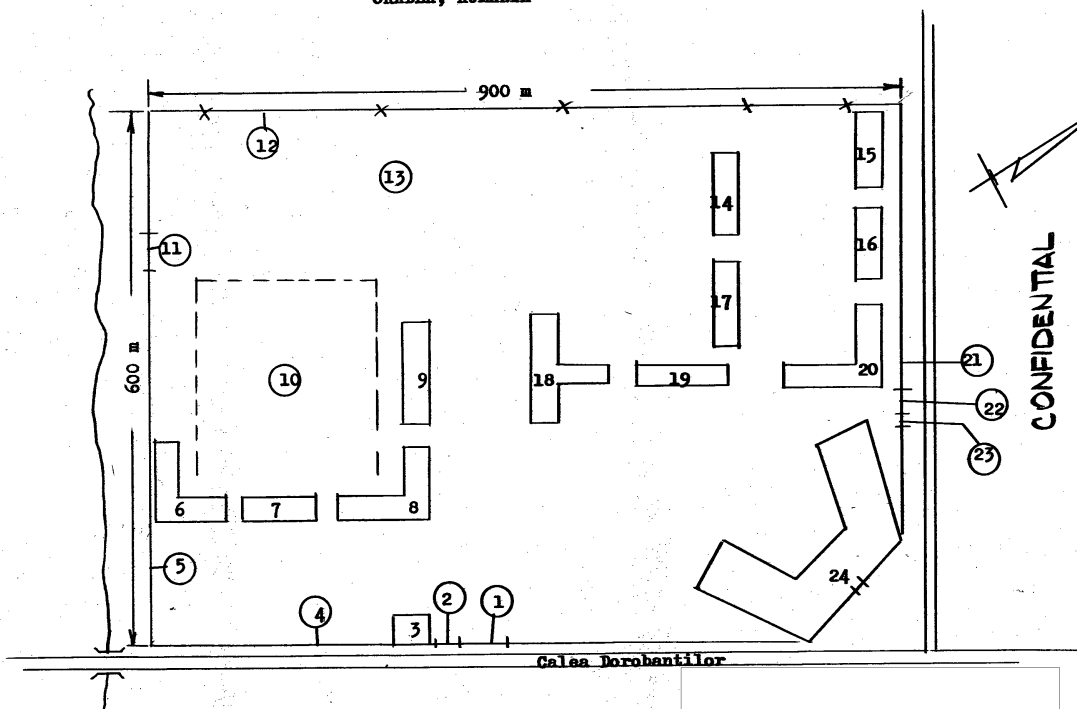

CONFIDENTIAL

50X1-HUM

50X1-HUM

50X1-HUM

CONFIDENTIAL
-91-

50X1-HUM

Legend to Annex UU

1. A double door, grey, iron-picket vehicle gate approximately 8 m wide and 2.5 m high.
2. A grey, iron-picket pedestrian gate approximately 1.5 m wide and 2.5 m high.
3. A one-story guard shack approximately 10 x 10 m, of white stucco with a red tile, gable roof. It had a small office, telephone, and bunks for about 20 to 25 guards. One guard armed with a Soviet PPSH SMG was on duty at all times and was responsible for gates mentioned as items 1 and 2.
4. A grey, iron-picket fence approximately 3 m high with a concrete base approximately 30 cm high.
5. A grey, stucco fence approximately 3 m high.
6. A three-story, L-shaped EM barracks, each wing about 60 x 15 m, of white stucco with a red tile, gable roof.
7. A three-story EM barracks approximately 60 x 15 m, of white stucco with a red tile, gable roof.
8. EM barracks, same description as 6, except that it was approximately 70 m long.
9. EM barracks, same description as 7.
10. Assembly area.
11. Vehicle gate with a metal frame and barbed wire approximately 8 m wide and 3 m high. One guard armed with a Czechoslovak ZB rifle was on duty at all times.
12. Barbed wire fence approximately 3 m high.
13. An unrecalled number of unidentified buildings. 50X1-HUM
14. and 15. Three-story EM barracks approximately 70 x 15 m, of white stucco with red tile, gable roofs.
16. EM barracks, mess hall, and kitchen. Same description as 14. The mess hall and kitchen were on the first floor.
17. EM barracks, same description as 14.
18. Regimental headquarters in a three-story T-shaped building approximately 70 x 15 m at the top of the T and 35 x 15 m along the stem of the T, of white stucco with a red tile, gable roof.
19. EM barracks, same description as 14.
20. A three-story, L-shaped EM barracks, each wing approximately 60 x 15 m, of white stucco with a red tile, gable roof.
21. Fence, same description as 4.

CONFIDENTIAL

CONFIDENTIAL
-92-

50X1-HUM

Legend to Annex UU, continued

22. Vehicle gate, same description as 1.
23. Pedestrian gate, same description as 2. One guard armed with a Czechoslovak ZB rifle was on duty at all times and was also responsible for gate mentioned as item 22.
24. Division headquarters in a three-story, U-shaped building approximately 70 m long on both wings, 50 m long at the base, and 25 m wide, of red stucco with a red tile, gable roof. Although the headquarters building was located in the fenced-in area, the main entrance was located on Calea Dorobantilor, on the east side of the building; therefore, access to the headquarters could be gained without going into the casern area.

CONFIDENTIAL

Annex VV

SKETCH OF CASERN OCCUPIED BY THE MINISTRY OF INTERIOR
OFFICERS' SCHOOL NUMBER 2 IN ORADEA, RUMANIA

CONFIDENTIAL
-93-

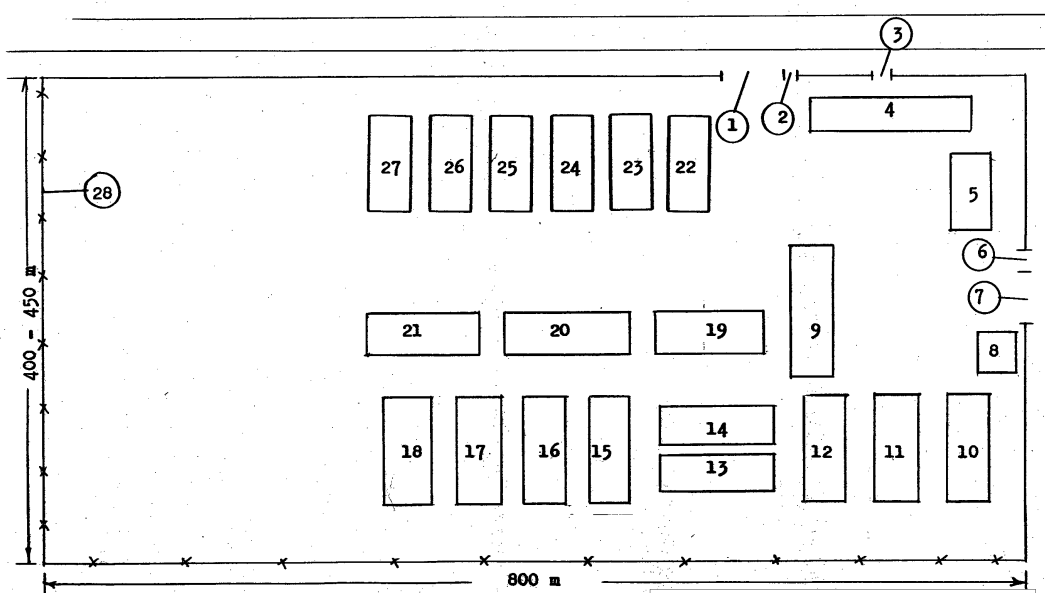

Bulevardul Avram Iancu
CONFIDENTIAL

50X1-HUM

50X1-HUM

50X1-HUM

CONFIDENTIAL

-94-

50X1-HUM

Legend to Annex VV

1. A double-door, green, wooden vehicle gate approximately 8 m wide and 2.5 m high. One guard armed with a Czechoslovak ZB rifle was on duty at all times.
2. A green, wooden picket fence approximately 2.5 m high with a concrete base approximately 80 cm high.
3. A green, wooden pedestrian gate approximately 1.5 m wide and 2.5 m high. A guard armed with a Soviet PPSH SMG was on duty at all times.
4. Headquarters in a two-story building approximately 75 x 20 m, of white stucco with a red tile, gable roof.
5. Administrative offices for headquarters, approximately 60 x 20 m, same description as 4.
6. Pedestrian gate, same description as 3.
7. Vehicle gate, same description as 1. Guard from gate mentioned as item 6 was also responsible for this gate.
8. A one-story guard shack approximately 8 x 8 m, of white stucco with a red tile, gable roof. This building had a small office, telephone, and beds for about 20 guards.
9. Classroom in a one-story building approximately 80 x 20 m, of white stucco with a red tile, gable roof.
- 10 to 12. One-story, brown, wooden EM barracks approximately 70 x 15 m with black tar-paper gable roofs.
- 13 and 14. Classrooms, same description as 9.
- 15 to 18. EM barracks, same description as 10.
- 19 to 21. Mess halls, same description as 10. Kitchen was located in building mentioned as item 21.
- 22 to 27. EM barracks, same description as 10.
28. Barbed wire fence approximately 3 m high.

CONFIDENTIAL

Annex WW
PINPOINT LOCATION OF MILITARY INSTALLATIONS
IN ORADEA, RUMANIA

LEGEND:

- 1. Training Area
- 2. U/i Arty Regt and U/i Engr Regt
- 3. Firing Range
- 4. Main Road through ORADEA
- 5. Casern under construction

14
65

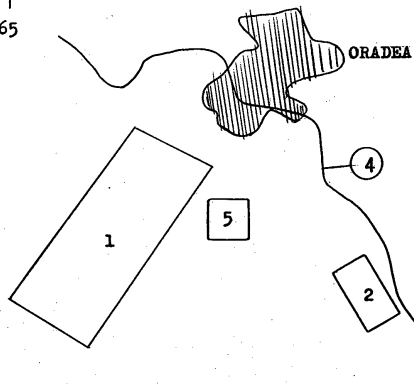

CONFIDENTIAL

-95-

CONFIDENTIAL

50X1-HUM

50X1-HUM

50X1-HUM

Annex XX

SKETCH OF CASERN OCCUPIED BY UNIDENTIFIED ARTILLERY REGIMENT AND UNIDENTIFIED ENGINEER REGIMENT IN ORADEA, ROMANIA

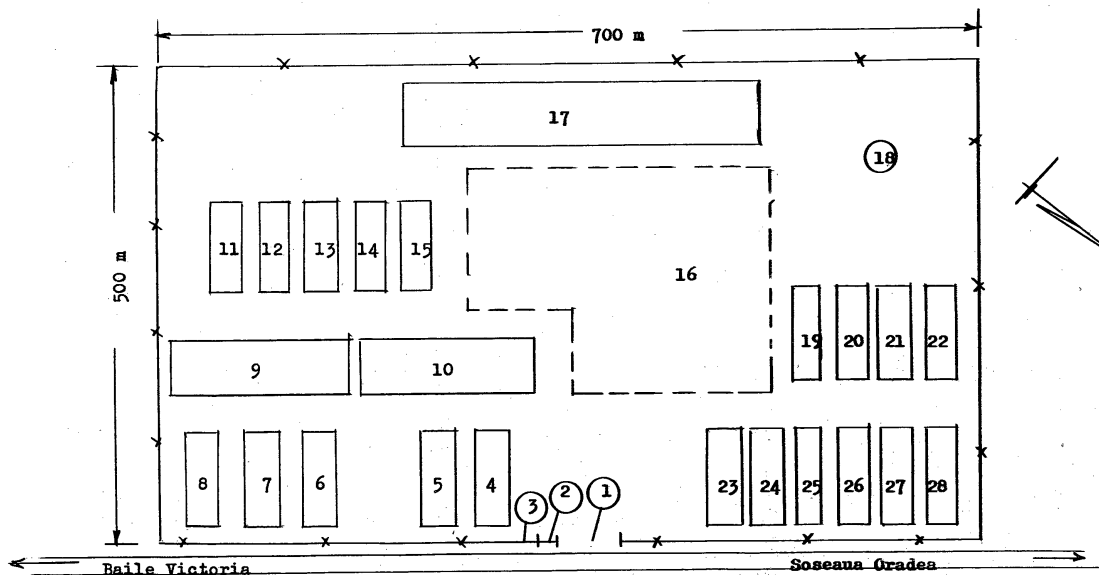

CONFIDENTIAL

-96-

CONFIDENTIAL

50X1-HUM

50X1-HUM

50X1-HUM

CONFIDENTIAL

-97-



50X1-HUM

Legend to Annex XX

1. A double-door vehicle gate, with a metal framework and barbed wire approximately 10 to 12 m wide and 2.5 m high.
2. Pedestrian gate, same description as 1 except that it was a single-door gate approximately 2 m wide and 2.5 m high. A guard armed with a Soviet PPSH SMG was on duty at all times and was also responsible for gate mentioned as item 1.
3. Barbed wire fence approximately 3 m high.
- 4 to 8. EM barracks in temporary one-story buildings approximately 75 x 15 x 5 m, constructed of logs painted white with grey tar-paper gable roofs; also, 2.5 m of this building was below ground and 2.5 m projected aboveground.
- 9 and 10. Hitching post for horses, wooden framework with a grey tar-paper gable roof approximately 100 x 25 x 6 m.
- 11 to 15. EM barracks, same description as 4.
16. Assembly area for troops, and parking area for vehicles and artillery guns.
17. Open shed for parking artillery guns, vehicles, and other equipment. A wooden framework approximately 200 x 30 x 8 m with a grey tar-paper gable roof.
18. Unrecalled number of unidentified buildings.
- 19 to 28. EM barracks, same description as 4.

CONFIDENTIAL

Annex YY

SKETCH OF OSORHEI FIRING RANGE IN ORADEA, RUMANIA

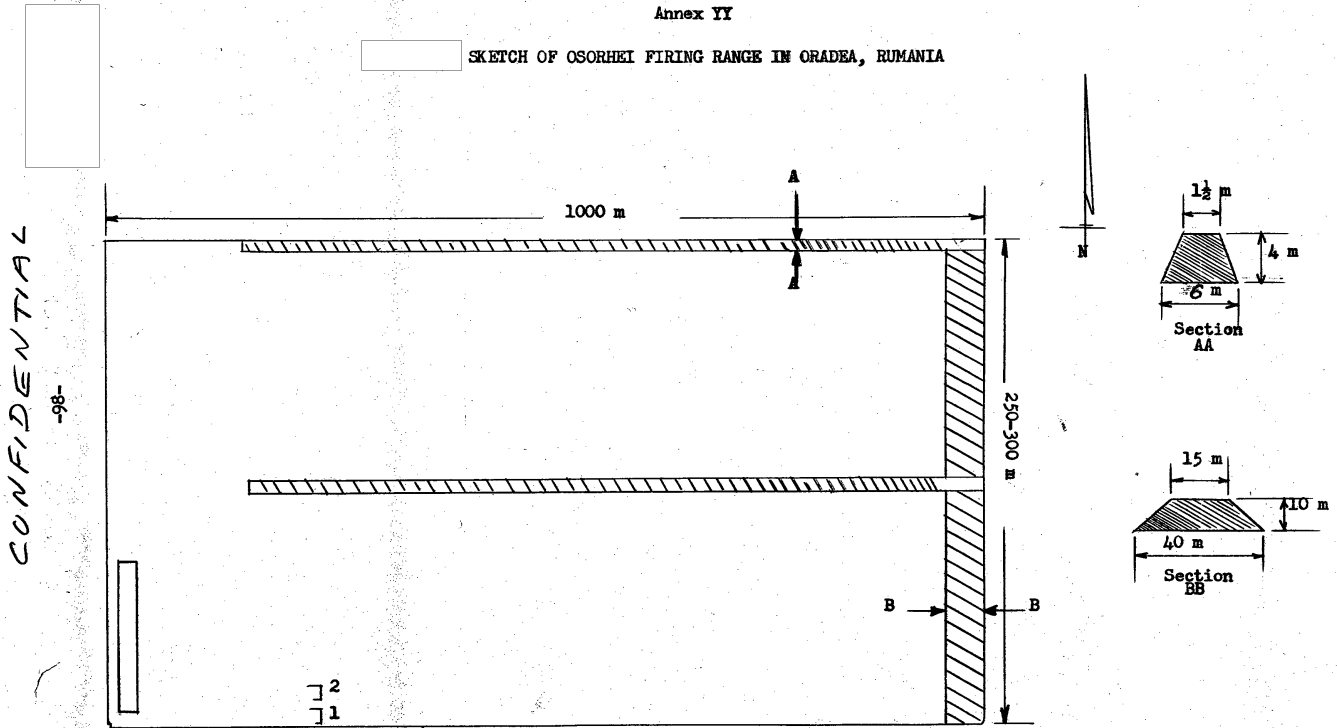

50X1-HUM
50X1-HUM

CONFIDENTIAL

50X1-HUM

CONFIDENTIAL

50X1-HUM

-99-

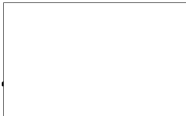

Legend to Annex YY

This firing range was used by all units in the ORADEA area.

50X1-HUM

[Redacted] There was one building located on the range which was used for supplies. This was a one-story building approximately 120 x 20 x 10 m, constructed of red stucco with a red-tile, gable roof. There were two concrete walls (see items 1 and 2 on Annex) used for protection while the men were practicing throwing hand grenades. The walls were approximately 8 m long on one side, 10 m long on the other, and 2 m high.

It was possible to fire from any distance between 25 m and 800 m. The range was capable of having between 25 to 30 targets up at one time.

50X1-HUM

[Redacted] the following types of weapons [Redacted] fired on this range: pistols, rifles, submachineguns, machineguns, grenades, antitank rifles, and French Hotchkiss anti-aircraft 25 mm guns, which were leveled at the target and could be used against tanks.

50X1-HUM

50X1-HUM

CONFIDENTIAL

CONFIDENTIAL

50X1-HUM

-100-

Annex ZZ

**PINPOINT LOCATIONS OF MILITARY INSTALLATIONS IN CRAIOVA,
RUMANIA**



50X1-HUM

LEGEND:

- 1. Segment of 8th Trans Bn
- 2. 21st Inf Regt and Segment of 8th Trans Bn
- 3. Hq HCC Inf Div
- 4. 1st Hvy Arty Regt
- 5. Segment of 8th Trans Bn
- 5A Automotive Repair Shop #5, 8th Transportation Bn
- 6. Hq Security Police for District of Craiova

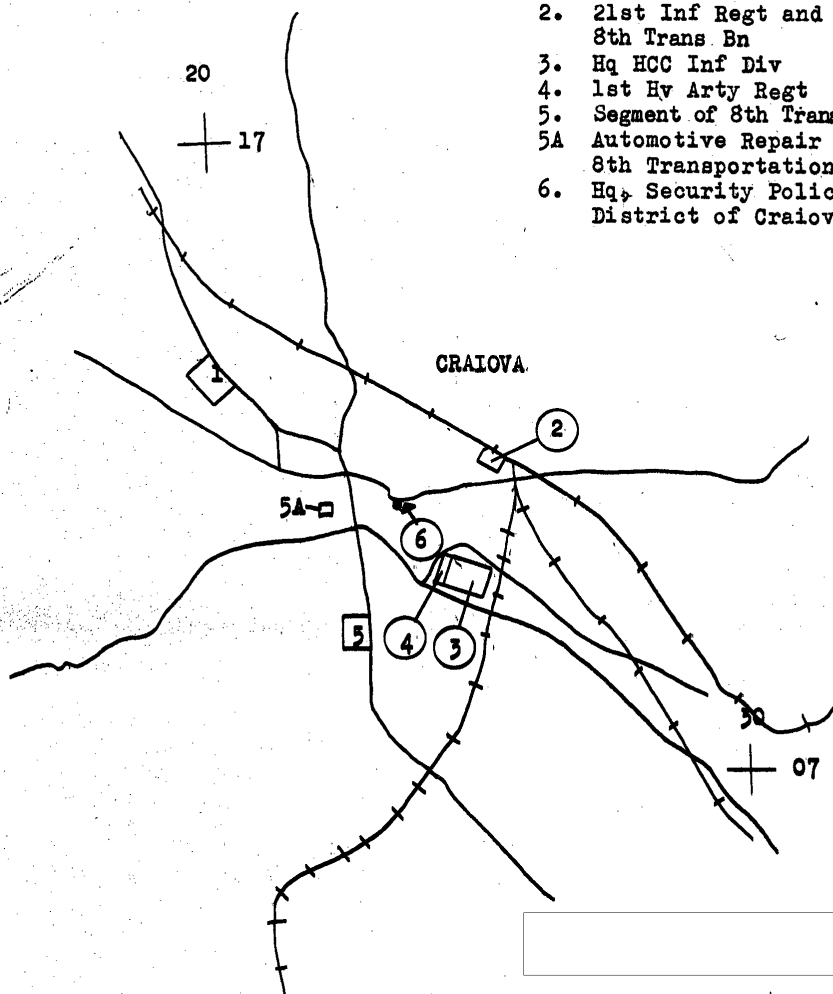

50X1-HUM



CONFIDENTIAL

Annex AAA

██████████ SKETCH OF CASERN OCCUPIED BY A SEGMENT OF THE
8TH TRANS BN IN CRAIOVA, RUMANIA

50X1-HUM

50X1-HUM

~~CONFIDENTIAL~~
-101-

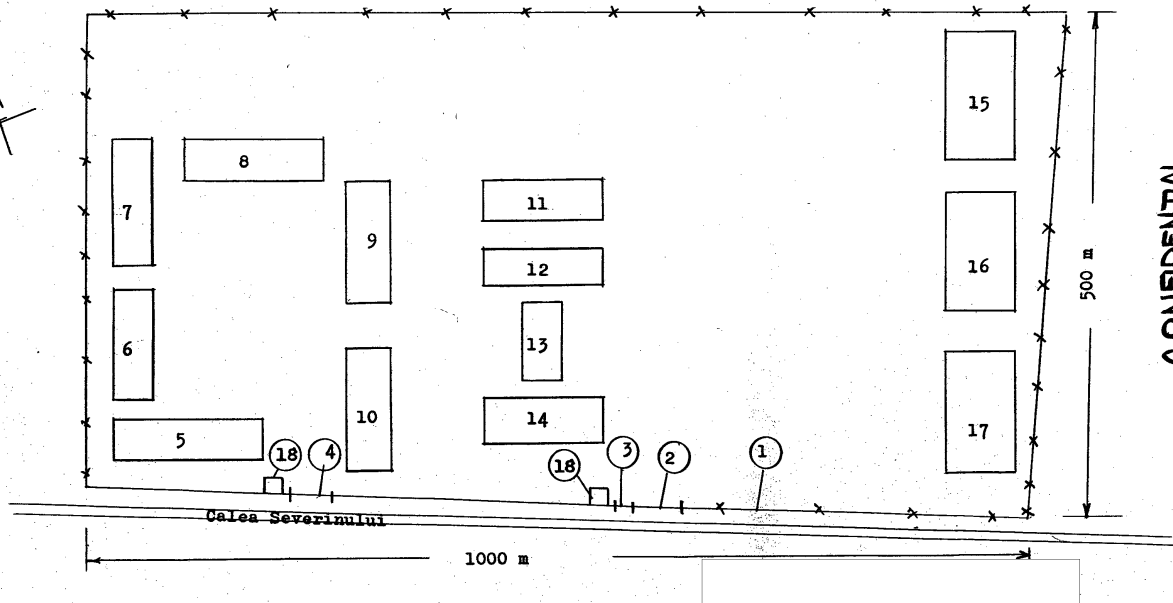

~~CONFIDENTIAL~~

50X1-HUM

CONFIDENTIAL
-102-

50X1-HUM

Legend to Annex AAA

All buildings described with the exception of the building mentioned as item 14 were one-story buildings constructed of wood and painted dark grey with grey tar-paper gable roofs.

1. Barbed wire fence approximately 3 m high.
2. A double-door, vehicle gate constructed with a wooden frame and barbed wire approximately 8 m wide and 2.5 m high.
3. Pedestrian gate constructed with a wooden frame and barbed wire approximately 1.5 m wide and 2.5 m high. A guard armed with a Czechoslovak ZB rifle was on duty at all times and was also responsible for the gate mentioned as item 2.
4. Vehicle gate, same description as 2. A guard armed with a Czechoslovak ZB rifle was on duty at all times.
- 5 to 10. EM barracks approximately 80 x 15 x 5 m.
11. Mess hall and kitchen, approximately 60 x 15 x 5 m.
12. Warehouse and unidentified offices, approximately 60 x 15 x 5 m.
13. Unidentified offices and club, approximately 60 x 15 x 5 m.
14. Headquarters for this casern (Headquarters for the 8th Auto Bn was located in another area) in a one-story building approximately 60 x 15 x 5 m, of white stucco with a red tile, gable roof.
- 15 to 17. Garages, approximately 100 x 25 x 10 m.
18. One-story guard shacks, 2 x 2 m.

CONFIDENTIAL

Annex BBB

SKETCH OF CASERN OCCUPIED BY A SEGMENT OF THE 8TH TRANS
BN AND THE 21ST INF REGT IN CRAIOVA, ROMANIA

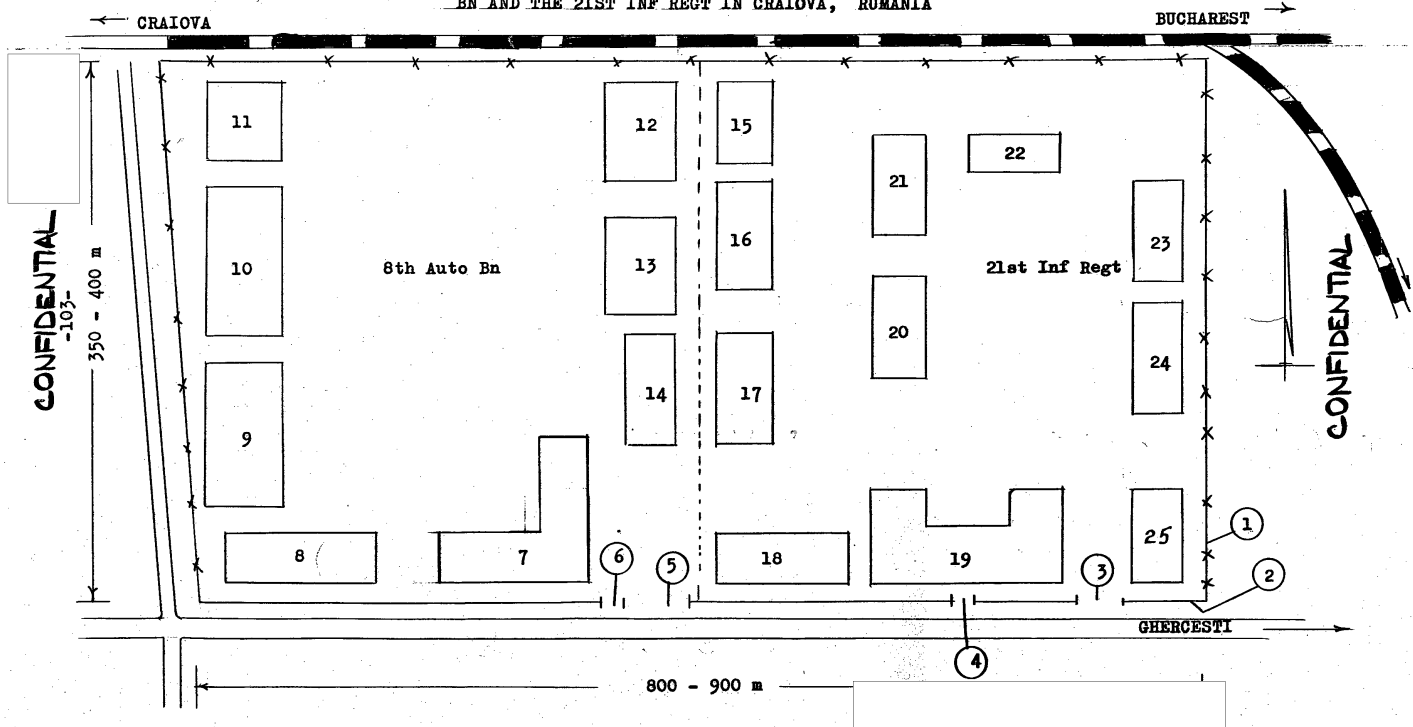

50X1-HUM

50X1-HUM

50X1-HUM

CONFIDENTIAL

-104-

50X1-HUM

Legend to Annex BBB

This casern was jointly occupied by the 8th Auto Bn and the 21st Inf Regt.

1. Barbed wire fence approximately 3 m high.
2. A wire-mesh fence approximately 1.8 m high with a concrete base approximately 30 cm high.
3. A double-door, vehicle gate approximately 8 m wide and 1.8 m high constructed of wire mesh on a metal frame. Guard armed with a Czechoslovak ZB rifle was on duty at all times.
4. A wire-mesh, pedestrian gate approximately 1.5 m wide and 1.8 m high. One guard armed with a Soviet PPSH SMG was on duty at all times.
5. Vehicle gate, same description as 3.
6. Pedestrian gate, same description as 4. One guard armed with a Soviet PPSH SMG was on duty at all times and was also responsible for the gate mentioned as item 5.

8th Auto Bn

7. Headquarters in a two-story, L-shaped building, with the south side 50 x 20 m and the east side 50 x 20 m, of white stucco with a red tile gable roof.
8. A two-story EM barracks approximately 60 x 15 m, of white stucco with a red tile, gable roof.
9. A wooden one-story garage, approximately 80 x 25 x 10 m, painted white with a grey tar-paper gable roof.
10. Garage, same description as 9.
11. Garage, 40 x 25 x 10 m, same description as 9.
12. Garage, 60 x 25 x 10 m, same description as 9.
13. Warehouse for parts, tires, motors, and auto supplies, 60 x 25 x 10 m, same description as 8.
14. A wooden, one-story EM barracks approximately 80 x 15 m, painted white with a grey tar-paper gable roof.

21st Inf Regt

15. A two-story EM barracks approximately 50 x 15 m, of white stucco with a red tile, gable roof.
- 16 and 17. EM barracks 80 x 15 m, same description as 15.

CONFIDENTIAL

CONFIDENTIAL

-105-

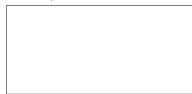

50X1-HUM

Legend to Annex BBB, continued

18. Unidentified offices in a three-story building approximately 40 x 20 m, of white stucco with a red tile, gable roof.
19. Headquarters on first floor and EM quarters on 2d and 3d floor. This was a three-story, U-shaped building approximately 80 m long, with both wings 40 m long and 20 m wide, of white stucco with a red tile, gable roof.
20. A one-story EM barracks, approximately 70 x 15 m, of white stucco with a red tile, gable roof.
21. Kitchen and mess hall, 60 x 15 m, same description as 20.
22. Unidentified warehouse, 30 x 15 m, same description as 20.
- 23 and 24. EM barracks, same description as 20.
25. A two-story EM barracks approximately 50 x 15 m, of white stucco with a red tile, gable roof.

CONFIDENTIAL

Annex CCG

SKETCH OF CASERN OCCUPIED BY HEADQUARTERS HORIEA CLOSCA S. CRISAN (HCC)
INF DIV IN CRAIOVA, RUMANIA



CONFIDENTIAL
-106-

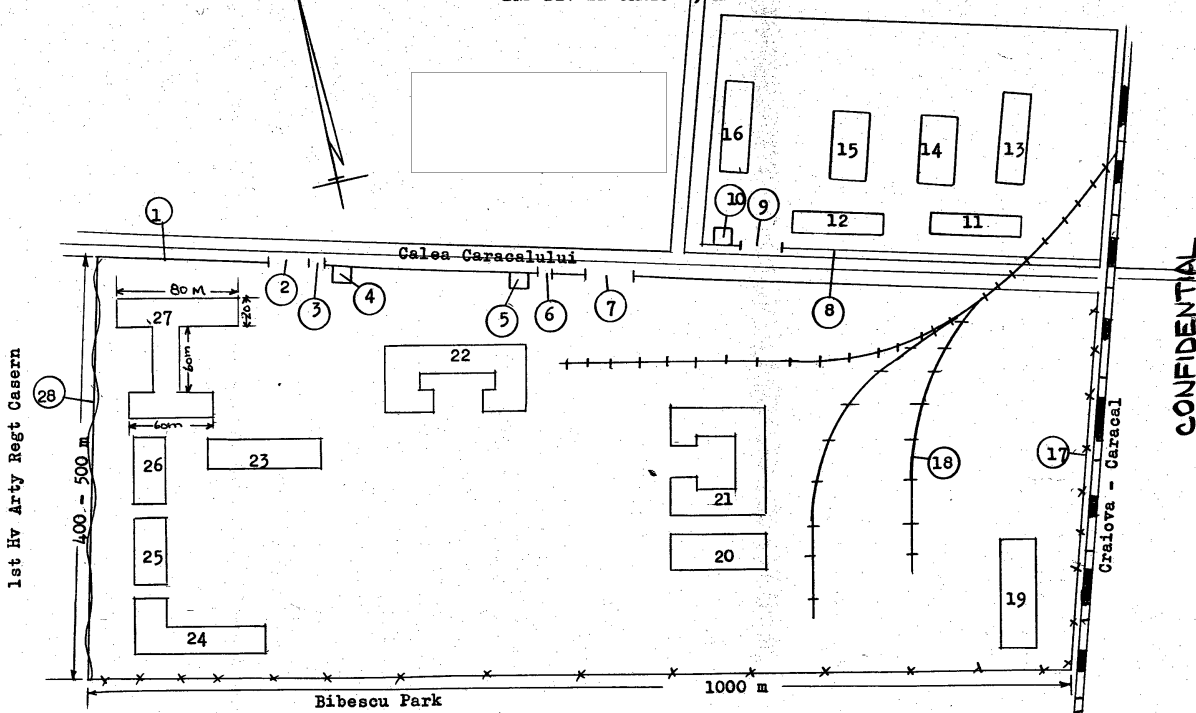

50X1-HUM

50X1-HUM

50X1-HUM

CONFIDENTIAL

CONFIDENTIAL

-107-

50X1-HUM

Legend to Annex CCC

1. A wire fence approximately 2.5 m high with a concrete base approximately 30 cm high.
2. A double-door, vehicle gate approximately 8 m wide and 2.5 m high, with a metal frame and wire mesh.
3. A pedestrian gate, with a metal frame and wire mesh approximately 1.5 m wide and 2.5 m high.
4. A one-story guard shack approximately 1.5 x 1.5 x 3 m. One guard armed with a Soviet PPSH SMG was on duty at all times.
5. Guard shack, same description as 4.
6. Pedestrian gate, same description as 3.
7. Vehicle gate, same description as 2.
8. Wire-mesh fence approximately 2.5 m high with a concrete base approximately 30 cm high. The other three sides of this area had a barbed wire fence approximately 3 m high.
9. Vehicle gate, same description as 3.
10. Guard shack, same description as 4.
11. A two-story unidentified building approximately 80 x 20 m, of grey stucco with a red tile, gable roof.
12. Unidentified building, same description as 11.
13. A three-story, unidentified building approximately 100 x 20 m, of grey stucco with a red tile, gable roof.
14. Unidentified building, approximately 60 x 40 m, same description as 13.
15. Unidentified building, same description as 14.
16. Unidentified building, same description as 13.
17. Barbed wire fence approximately 3 m high.
18. Railroad tracks.
19. Underground storage area for food approximately 60 x 20 m.
20. A two-story, unidentified building approximately 50 x 20 m, of dull yellow stucco with a red tile, gable roof.
21. A three-story, unidentified, U-shaped building with the main section 100 m long, both wings 50 m long and 20 m wide, of a dull yellow stucco with a red tile, gable roof.

CONFIDENTIAL

CONFIDENTIAL

-108-

50X1-HUM

Legend to Annex CCC, continued

22. A three-story, unidentified U-shaped building with the main section 60 m long and both wings 25 m long and 25 m wide, of dull yellow stucco with a red tile, gable roof.
23. A one-story unidentified building approximately 120 x 25 x 8 m, of dull yellow stucco with a red tile, gable roof.
24. A two-story, unidentified, L-shaped building, with the south side 120 x 20 m and the west side 35 x 20 m, of dull yellow stucco with a red tile, gable roof.
- 25 and 26. Garages for vehicles and equipment. These were one-story buildings approximately 80 x 25 x 9 m, of red stucco with red tile, gable roofs.
27. A three-story unidentified building of dull yellow stucco with a red tile, gable roof.
28. Open area leading to the casern of the 1st Heavy Arty Regt.

CONFIDENTIAL

Annex DDD

SKETCH OF CASERN OCCUPIED BY THE 1ST HEAVY ARTY REGT IN CRAIOVA,
ROMANIA

CONFIDENTIAL

-109-

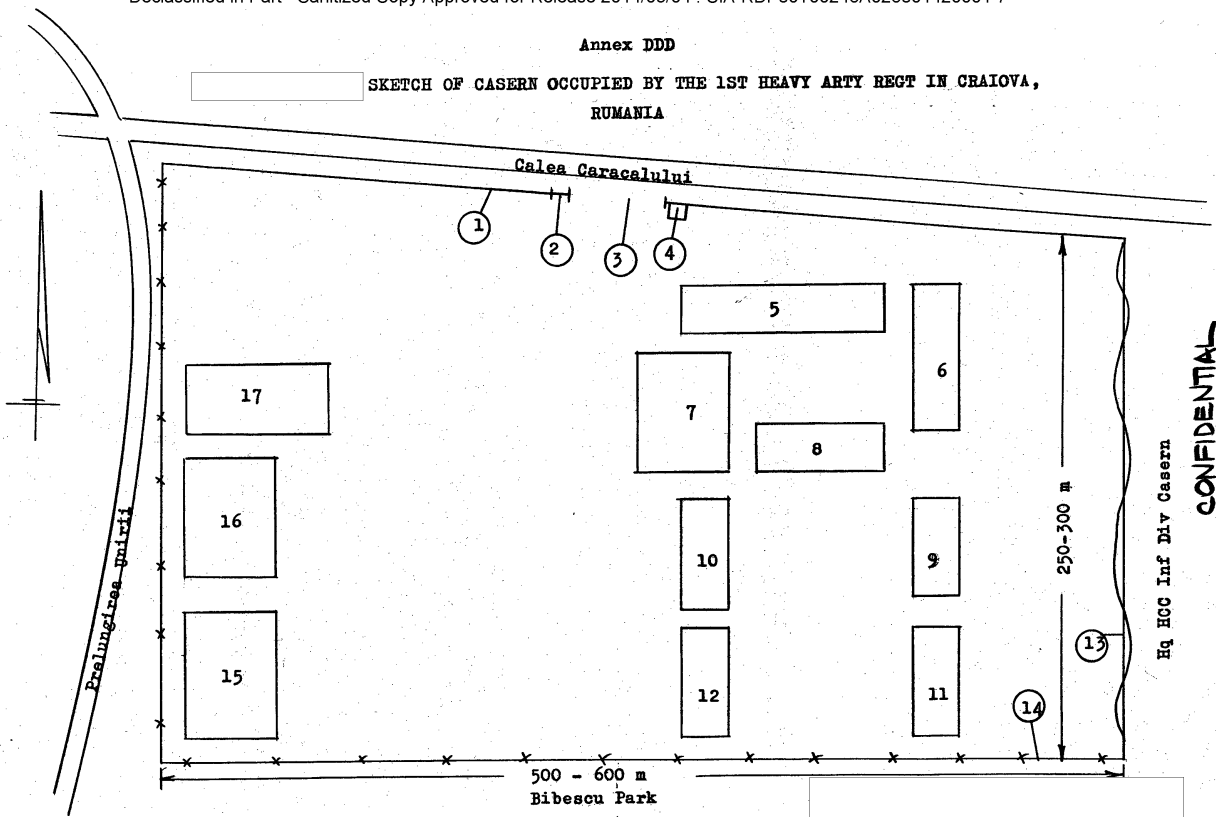

CONFIDENTIAL

50X1-HUM

50X1-HUM

50X1-HUM

CONFIDENTIAL

-110-

50X1-HUM

Legend to Annex DDD

1. A wire-mesh fence approximately 2.5 m high with a concrete base approximately 30 cm high.
2. Pedestrian gate approximately 1.5 m wide and 2 m high, of wire mesh with a metal frame.
3. A double-door, vehicle gate approximately 8 m wide and 2 m high, of wire mesh with a metal frame.
4. A one-story, wooden guard shack approximately 1.5 x 1.5 x 2.5 m, painted OD with a black tar-paper gable roof. One guard armed with an unidentified weapon was on duty at all times and was responsible for the gates mentioned as items 2 and 3.
5. Headquarters in a three-story building approximately 70 x 20 m, of dull yellow stucco with a red tile, gable roof.
6. EM barracks, approximately 70 x 15 m, same description as 5.
7. Garage for vehicles, artillery, and other equipment in a one-story, wooden building approximately 80 x 30 x 10 m, painted white with a grey tar-paper gable roof.
8. Stables in a one-story building approximately 60 x 15 m, of white stucco with a red tile, gable roof.
- 9 to 12. EM barracks. These were two-story buildings approximately 60 x 15 m, of white stucco with red tile, gable roofs.
13. Open area which led to the Moriea Clesca S. Crisan (HCC) Infantry Division.
14. Barbed wire fence approximately 3 m high.
- 15 to 17. Garages, same description as 7.

CONFIDENTIAL

Annex EEE

SKETCH OF CASERN OCCUPIED BY A SEGMENT OF THE 8TH TRANS
BN IN CRAIOVA, RUMANIA

50X1-HUM

50X1-HUM

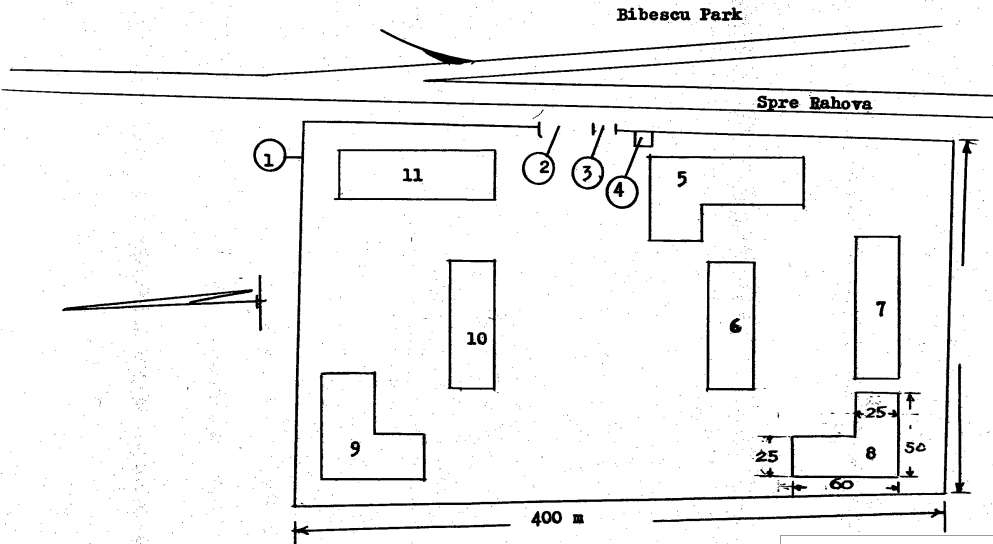

CONFIDENTIAL
-111-

CONFIDENTIAL

50X1-HUM

CONFIDENTIAL

-112-

50X1-HUM

Legend to Annex EEE

1. Grey stucco fence approximately 2.5 m high.
2. A double-door, grey iron-picket vehicle gate, approximately 8 m wide and 2.5 m high.
3. An iron-picket pedestrian gate approximately 1.5 m wide and 2.5 m high.
4. A one-story, wooden guard shack approximately 1.5 x 1.5 x 2.5 m, painted OD with a tar-paper gable roof. One guard armed with a Soviet PPSH SMG was on duty at all times and was responsible for the gates mentioned as items 2 and 3.
5. Headquarters for this casern (Headquarters for the 8th Auto Bn was located in another area) on the first floor and EM quarters on the second and third floors. This was a three-story, L-shaped building with east side 60 x 20 m and north side 30 x 20 m, of white stucco, with a red tile, gable roof.
6. Mess hall and kitchen in a one-story building approximately 60 x 20 m, of white stucco with a red tile, gable roof.
7. A two-story EM barracks approximately 60 x 15 m of white stucco with a red tile, gable roof.
- 8 and 9. Garages and repair shops. These were one-story, L-shaped buildings (see items on Annex) of white stucco with red tile, gable roofs.
10. A one-story EM barracks approximately 80 x 15 m, of white stucco with a red tile, gable roof.
11. A three-story EM barracks approximately 80 x 20 m, of white stucco with red tile, gable roof.

CONFIDENTIAL

Annex FFF

SKETCH OF AUTOMOTIVE REPAIR SHOP
NR 5, 8TH TRANS. BN IN CRAIOVA, ROMANIA

(Not to Scale)

Agronomical
Institute

(Formerly the
Queen Elizabeth
Lyceum for girls)

50X1-HUM

50X1-HUM

Strada Calomfirescu

Strada Bucovatului

CONFIDENTIAL
-113-

CONFIDENTIAL

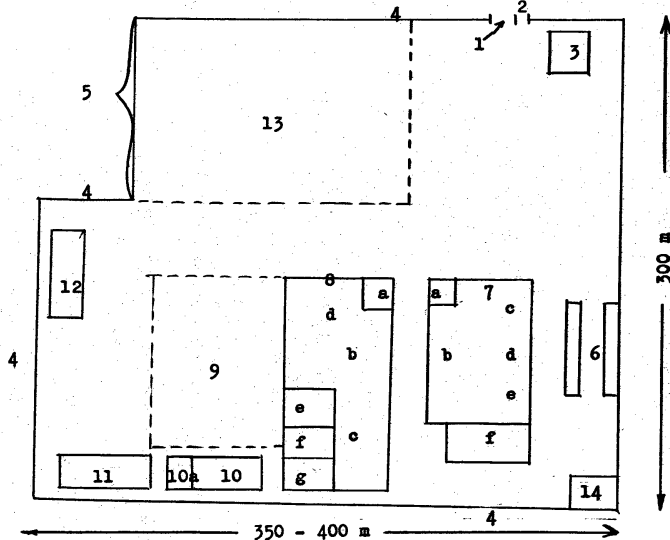

50X1-HUM

CONFIDENTIAL

-114-

50X1-HUM



Legend to Annex FFF

1. Iron-picket, swinging, double gate, 8 m wide and 3 m high.
2. Small, iron, pedestrian gate.
3. Guard shack, about 10 x 6 x 5 m, stucco with a red tile, hipped roof.
4. Brick wall, 4 or 5 m high.
5. Solid board fence, 2½ m high.
6. Two wooden grease racks.
7. Repair shops in a red brick building, 100 to 120 x 25 to 30 x 12 to 15 m, with a flat concrete roof.
 - a. Office
 - b. Assembly and disassembly shop
 - c. Sheet metal shop
 - d. Welding shop
 - e. Radiator shop
 - f. Foundry
8. Red brick repair shop, 110 to 130 x 25 to 30 x 12 to 15 m, with a flat concrete roof.
 - a. Office of the technical chief of the repair base.
 - b. Motor and transmission shop
 - c. Lathe and grinding shop
 - d. Assembly and disassembly shop
 - e. Upholstery and paint shop
 - f. Electrical shop
 - g. Forge
9. Parking area, where vehicles were stored while awaiting repair.
10. A wooden EM mess hall, about 35 x 15 x 6 m, with a tar-paper hipped roof.
- 10a. Food storage.
11. EM billets, similar to item 10.
12. Officers' and civilians' mess hall and small delicatessen shop, similar to item 10.
13. Parking area.
14. Latrine.

CONFIDENTIAL

Annex GGG

██████████ SKETCH OF CASERN OCCUPIED BY SECURITY POLICE HEADQUARTERS
(SECURITATE) FOR DISTRICT OF CRAIOVA, RUMANIA

50X1-HUM

50X1-HUM



CONFIDENTIAL
-115-

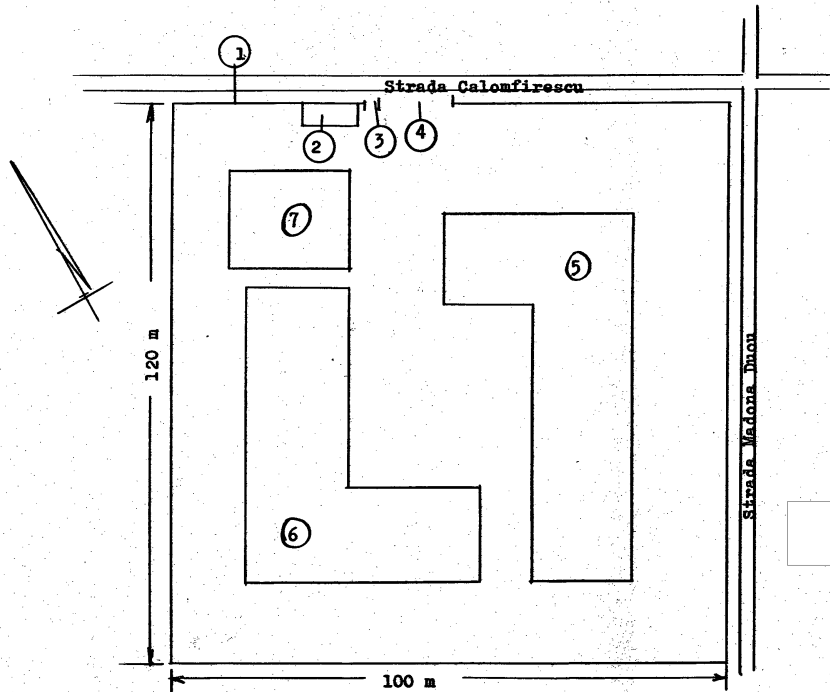

CONFIDENTIAL

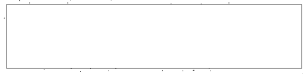

50X1-HUM

CONFIDENTIAL

-116-

50X1-HUM

Legend to Annex GGG



1. Dull yellow stucco fence approximately 4 m high.
2. A one-story guard shack approximately 10 x 5 m, of white stucco with a red tile, gable roof.
3. Pedestrian gate with a metal plate door approximately 1.5 m wide and 2.5 m high.
4. A double-door, metal-plate vehicle gate approximately 8 m wide and 2.5 m high. Two guards armed with an unidentified pistol and a Soviet PPSH SMG were on duty at all times, and were also responsible for the gate mentioned as item 3.
5. Unidentified offices and cells in the basement for prisoners. This was a three-story, L-shaped building, with the north side 50 x 20 m and the east side 80 x 20 m, of white stucco with a red tile, gable roof.
6. Unidentified offices and cells in the basement for prisoners, with the south side 50 x 20 m and the west side 6 x 20 m; same description as Item 5 above.
7. Headquarters in a three-story building approximately 20 x 20 m, of white stucco with a red tile, gable roof.

CONFIDENTIAL

CONFIDENTIAL
-117-



50X1-HUM

Annex HHH

PINPOINT LOCATION OF MILITARY INSTALLATIONS IN CONSTANTA, RUMANIA

LEGEND:



50X1-HUM

1. Unidentified military casern



2. Headquarters, 13th Border Guard Regt.

3. Unidentified border guard battalion.

BLACK
SEA

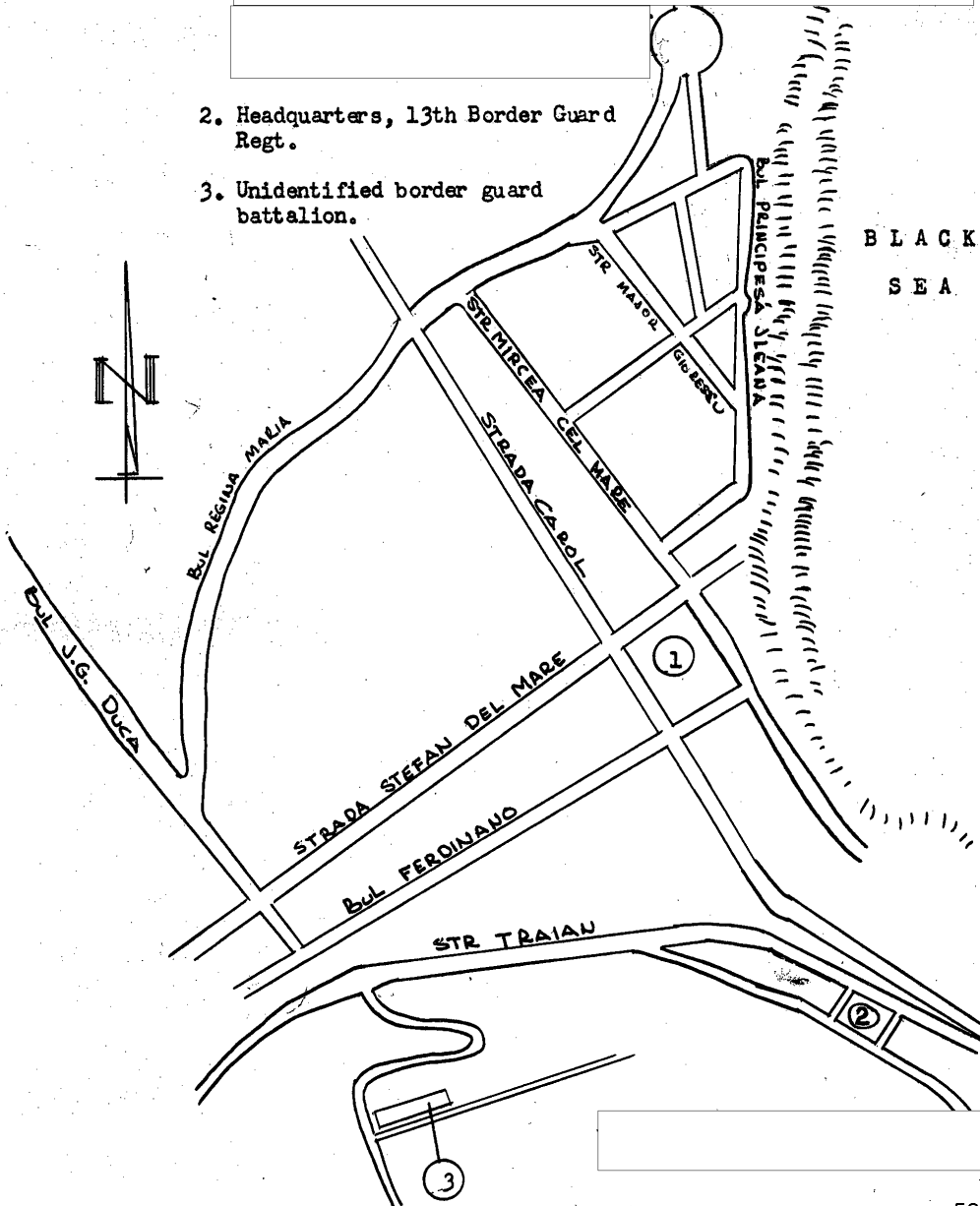

CONFIDENTIAL

50X1-HUM

Annex III

██████████ SKETCH OF CASERN OCCUPIED BY HEADQUARTERS
OF THE 13TH BORDER GUARD REGT IN CONSTANTA, ROMANIA

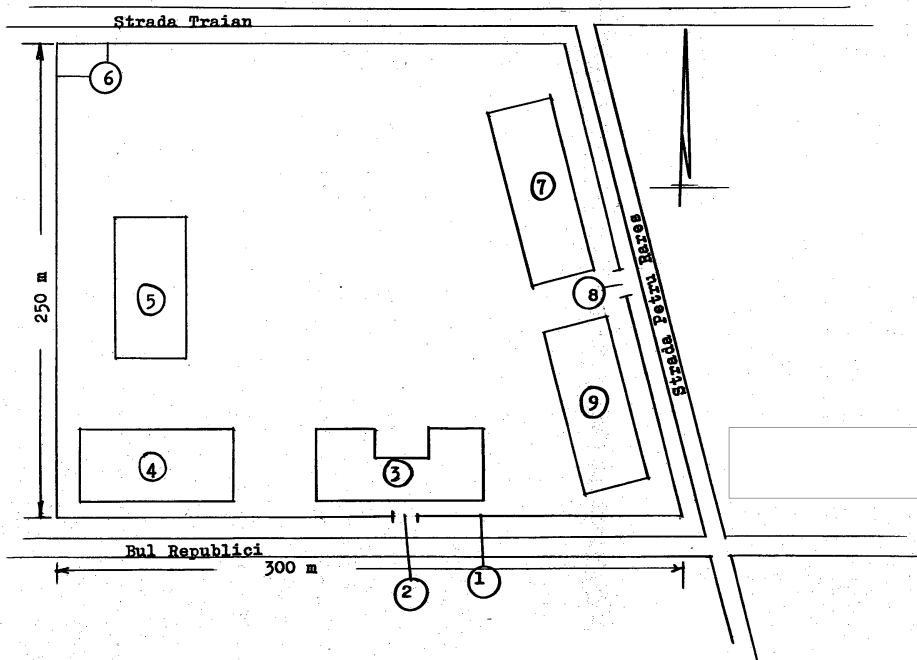

CONFIDENTIAL
-118-

CONFIDENTIAL

50X1-HUM

50X1-HUM

50X1-HUM

CONFIDENTIAL

-119-

50X1-HUM

Legend to Annex III

1. A green, wire-mesh fence approximately 1.8 m high with a concrete base approximately 30 cm high.
2. A green, pedestrian, wire-mesh gate approximately 1.5 m wide and 1.8 m high. One guard armed with a Soviet PPSH SMG was on duty at all times.
3. Headquarters in a three-story, U-shaped building approximately 80 m long at the main section, both wings 40 m long and 20 m wide, of white stucco with a red tile, gable roof.
4. Unidentified offices on first floor and supply room and sleeping quarters for EM on the second floor in a two-story building approximately 50 x 25 m, of white stucco with a red tile, gable roof. There were double-decker bunks to accommodate 100 troops in the sleeping quarters.
5. A one-story garage approximately 50 x 20 x 9 m, of white stucco with a red tile, gable roof.
6. Grey stucco fence approximately 3 m high.
7. A one-story warehouse approximately 60 x 20 x 8 m, of white stucco with a red tile, gable roof.
8. A green, double-door, vehicle gate of wire mesh, approximately 8 m wide and 1.8 m high. A guard armed with a Soviet PPSH SMG was on duty at all times.
9. A three-story EM barracks approximately 80 x 20 m, of white stucco with a red tile, gable roof.

CONFIDENTIAL

Annex JJJ

SKETCH OF CASERN OCCUPIED BY UNIDENTIFIED BORDER GUARD BATTALION IN CONSTANTA, RUMANIA
Constanta
Railroad Station

50X1-HUM

50X1-HUM

CONFIDENTIAL
-120-

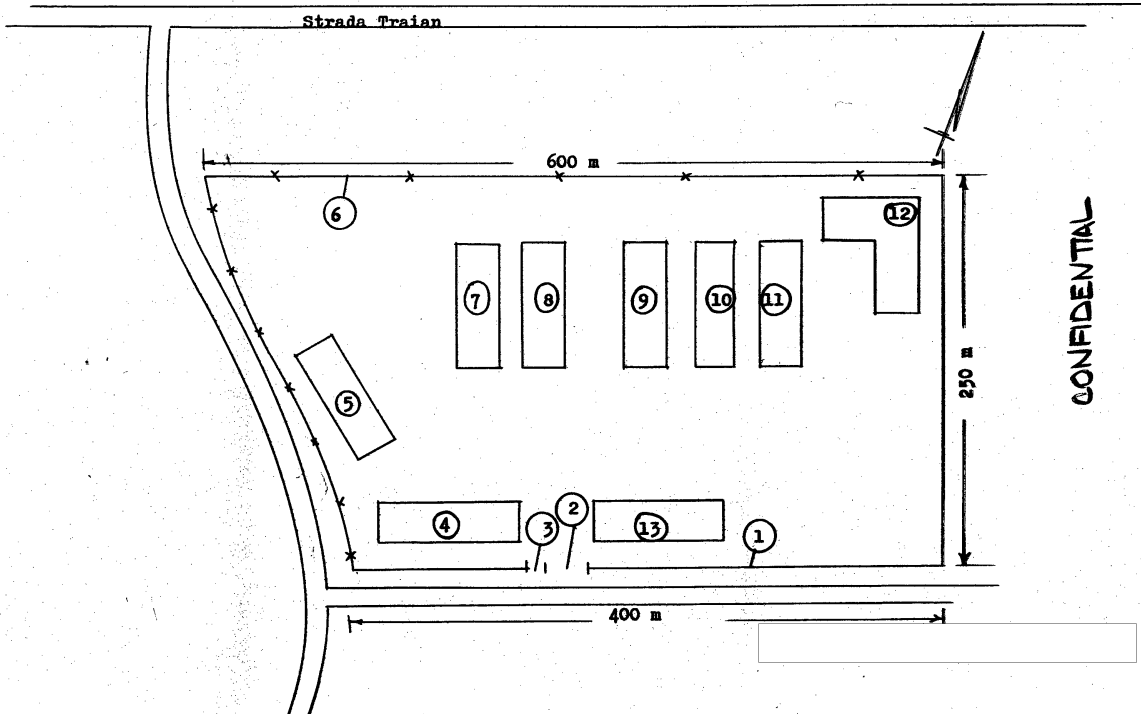

CONFIDENTIAL

50X1-HUM

CONFIDENTIAL

-121-

50X1-HUM



Legend to Annex JJJ

1. A green, wooden, picket fence approximately 2.5 m high.
2. A double-door, green, wooden, picket, vehicle gate approximately 8 m wide and 1.8 m high.
3. A green, wooden, picket, pedestrian gate approximately 1.5 m wide and 1.8 m high. One guard armed with a Soviet PPSH SMG was on duty at all times, and was also responsible for the gate mentioned as item 2.
4. Headquarters in a three-story building approximately 50 x 15 m, of white stucco with a red tile, gable roof.
5. A two-story EM barracks approximately 60 x 15 m, of white stucco with a red tile, gable roof.
6. Barbed wire fence approximately 3 m high.
- 7 to 11. One-story EM barracks approximately 60 x 15 m, of white stucco with red tile, gable roofs.
12. Kitchen and mess hall on the first floor and warehouse on the second floor in a two-story, L-shaped building, the wings approximately 50 x 15 m and 40 x 15 m, of white stucco with a red tile, gable roof.
13. Club, day room, and classrooms on the first floor and unidentified offices on the second floor in a two-story building approximately 50 x 20 m, of white stucco with a red tile, gable roof.

CONFIDENTIAL

CONFIDENTIAL
-122-



50X1-HUM

Annex KKK

**PINPOINT LOCATION OF UNIDENTIFIED BORDER GUARD BATTALION NEAR
CARMEN-SYLVA, RUMANIA**



50X1-HUM

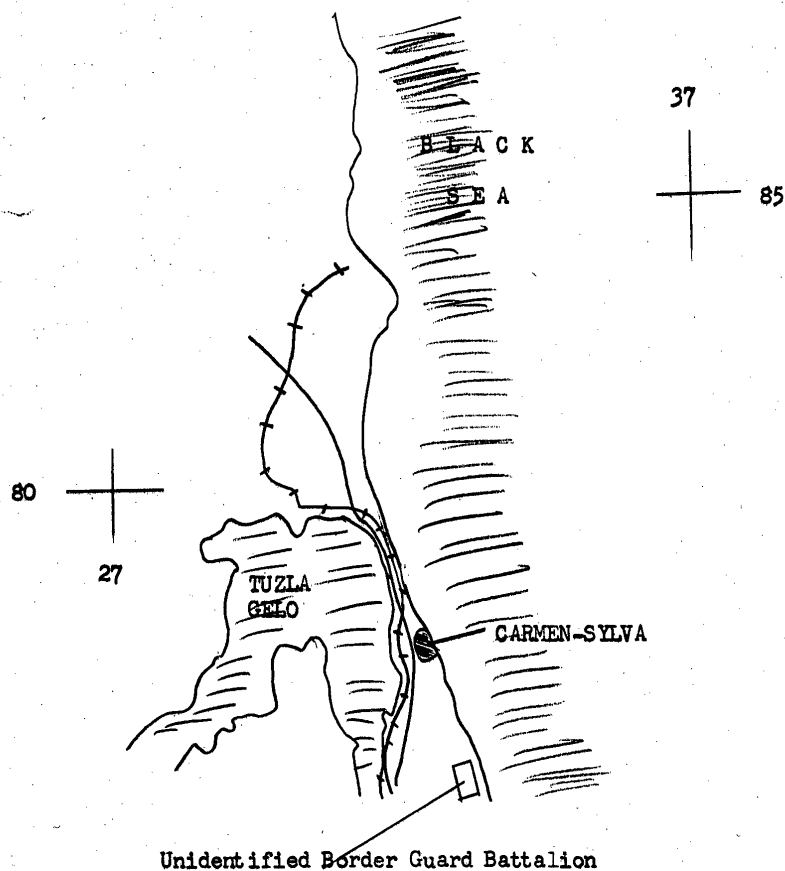

50X1-HUM



CONFIDENTIAL

Annex LLL

SKETCH OF CASERN OCCUPIED BY UNIDENTIFIED BORDER GUARD
BATTALION IN CARMEN-SYLVA, HUMANIA

To CARMEN-SYLVA →

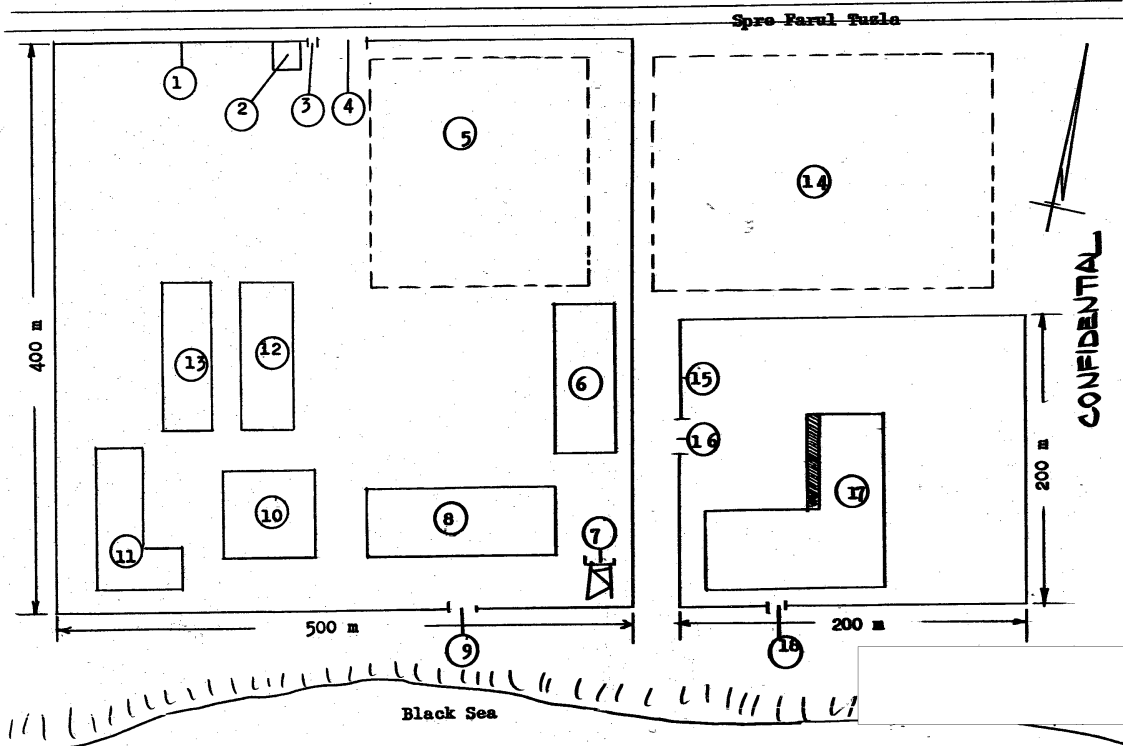

CONFIDENTIAL
-123-

CONFIDENTIAL

50X1-HUM

50X1-HUM

50X1-HUM

CONFIDENTIAL

-124-

50X1-HUM

Legend to Annex LLL

1. A white, wooden, picket fence approximately 1.8 m high.
2. A one-story, wooden guard shack approximately 1.5 x 1.5 x 2.5 m. One guard armed with a Soviet PPSH SMG was on duty at all times.
3. A white, wooden, picket, pedestrian gate approximately 1.5 m wide and 1.8 m high.
4. A white, wooden, picket, double-door, vehicle gate approximately 8 m wide and 1.8 m high.
5. Assembly area.
6. Billets for the intervention platoon in a one-story building approximately 60 x 15 m, of white stucco with a red tile, gable roof.
7. A wooden guard tower approximately 15 m high. Two guards armed with Czechoslovak ZB SMGs were on duty during daylight hours.
8. Headquarters, unidentified offices, and EM billets in a three-story building approximately 80 x 20 m, of white stucco with a red tile, gable roof.
9. Pedestrian gate, same description as 3. One guard armed with a Soviet PPSH SMG was on duty at all times.
10. A two-story officers' club approximately 25 x 25 m, of white stucco with a red tile, gable roof.
11. A one-story, L-shaped warehouse with the west side 60 x 20 x 6 m and the south side 35 x 20 x 6 m, of white stucco with a red tile, gable roof.
- 12 and 13. One-story EM barracks approximately 60 x 15 m, of white stucco with red tile, gable roofs.
14. Sport field.
15. Fence, same description as 1.
16. Vehicle gate, same description as 4. A guard armed with a Soviet PPSH SMG was on duty at all times.
17. This was a two-story, L-shaped unidentified building believed to be a radar station, with each wing approximately 50 x 30 m, of white stucco with a red tile, gable roof.
18. Pedestrian gate. A guard armed with a Soviet PPSH SMG was on duty at all times; same description as 9.

CONFIDENTIAL

Annex MMM

**PINPOINT LOCATION OF HQ 4TH BORDER GUARD REGT IN TIMISOARA,
RUMANIA**

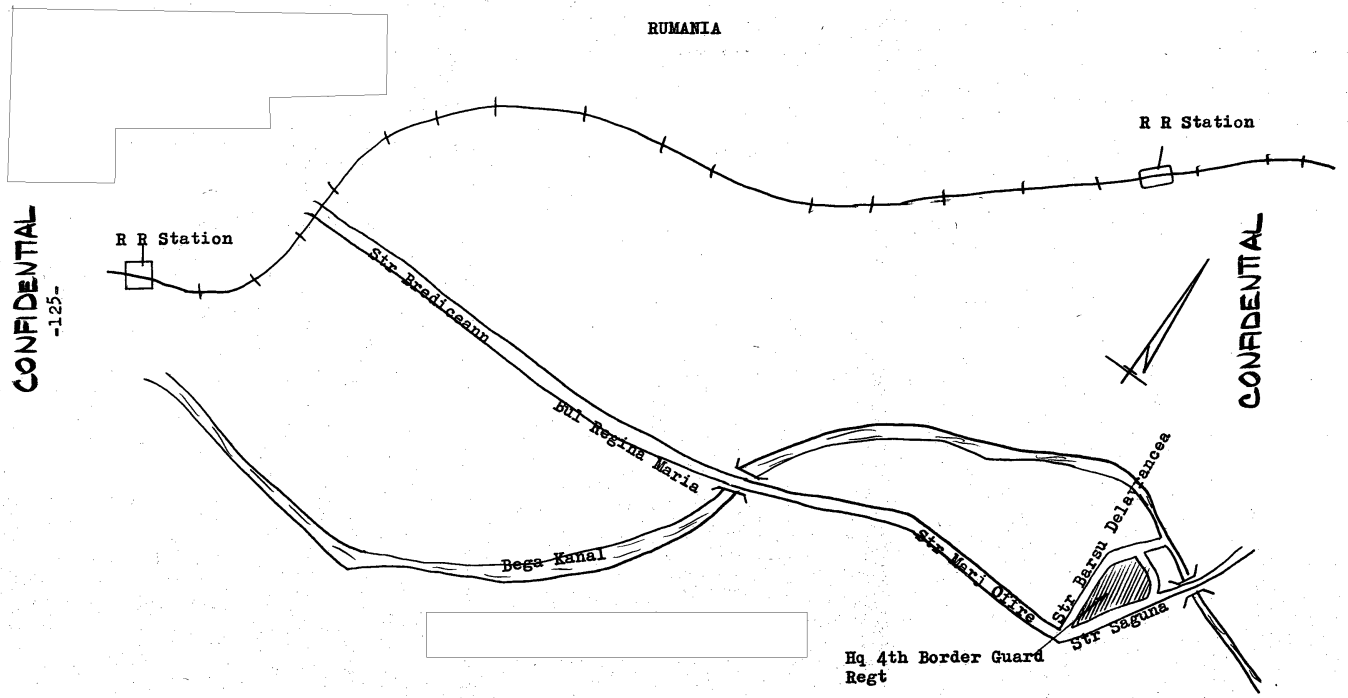

CONFIDENTIAL
-125-

CONFIDENTIAL

50X1-HUM

50X1-HUM

Annex NNW

SKETCH OF CASERN OCCUPIED BY HQ, 4TH BORDER GUARD REGT
IN TIMISOARA, RUMANIA

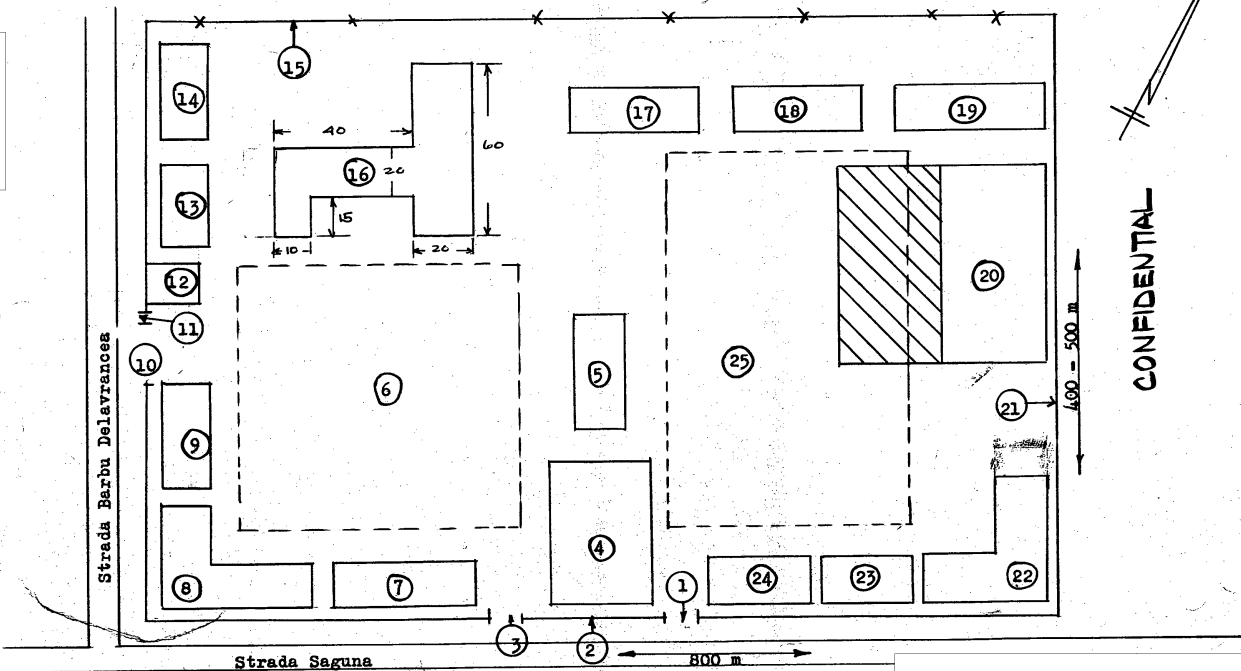

CONFIDENTIAL
-126-

CONFIDENTIAL

50X1-HUM

50X1-HUM

50X1-HUM

CONFIDENTIAL

-127-

50X1-HUM

Legend to Annex NNN

1. A double-door, vehicle gate painted green with an iron frame and wire mesh approximately 8 m wide and 1.8 m high. A guard armed with a Soviet PPSH SMG was on duty at all times.
2. A 2 m high green fence, with iron framework and wire mesh and a cement base approximately 35 cm high.
3. A green, pedestrian gate with an iron frame and wire mesh, approximately 1.5 m wide and 1.8 m high. A guard armed with a Soviet PPSH SMG was on duty at all times.
4. Headquarters in a three-story building approximately 60 x 40 m, of white stucco with a red tile, gable roof.
5. Mess hall, club, classrooms, kitchen, and office for Communist youth groups in a three-story building approximately 50 x 15 m, of white stucco with a red tile, gable roof.
6. Assembly area.
7. A three-story EM barracks approximately 60 x 15 m, of white stucco with a red tile, gable roof.
8. An L-shaped, three-story EM barracks with the south side 50 x 15 m and the west side 40 x 15 m, of white stucco with a red tile, gable roof.
9. A two-story warehouse for (Source believed) food supplies, clothing, and other unknown items, approximately 50 x 15 m, of white stucco with a red tile, gable roof.
10. Vehicle gate, same description as 1.
11. Pedestrian gate, same description as 3. One guard armed with a Soviet PPSH SMG was on duty at all times and was also responsible for the gate mentioned as item 10.
12. A one-story guard shack approximately 12 x 8 m, of white stucco with a red tile, gable roof. There were a small office, telephone, and sleeping quarters for approximately 25 guards.
13. A three-story EM barracks approximately 40 x 15 m, of white stucco with a red tile, gable roof.
14. A three-story EM barracks approximately 60 x 15 m, of white stucco with a red tile, gable roof.
15. Barbed wire fence approximately 3.5 m high.
16. Unidentified offices and EM quarters in a three-story, odd-shaped building, which was constructed of white stucco with a red tile, gable roof.
- 17 to 19. Three-story EM barracks approximately 60 x 15 m, of white stucco with red tile, gable roofs.
20. Garage for vehicles, artillery pieces, and other equipment in a one-story building approximately 100 x 25 x 10 m, of white stucco with a red tile, gable roof. It had a concrete driveway approximately 100 x 25 m.

CONFIDENTIAL

CONFIDENTIAL

-128-

50X1-HUM

Legend to Annex NNN, continued

21. Grey stucco fence approximately 3.5 m high.
22. An L-shaped, three-story EM barracks, with each wing about 60 x 15 m, of white stucco with a red tile, gable roof.
23. A three-story EM barracks approximately 40 x 15 m, of white stucco with a red tile, gable roof.
24. EM barracks, approximately 50 x 15 m, same description as 23.
25. Assembly area.

CONFIDENTIAL

CONFIDENTIAL

-129-



50X1-HUM

Annex 000



PINPOINT LOCATION OF TWO RUMANIAN MILITARY UNITS AT
GAESTI, RUMANIA

50X1-HUM

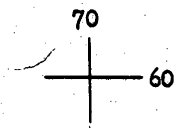

PITESTI

GAESTI

BUCHAREST

Permanent Repair Base
Nr 41, 4th Trans Bn

Engineer
Officer Candidate School

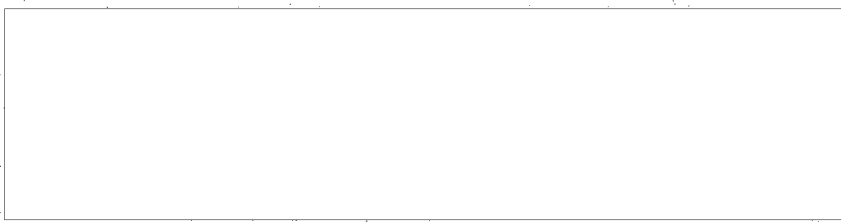

50X1-HUM

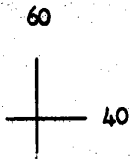

CONFIDENTIAL

CONFIDENTIAL

-131-

50X1-HUM

Legend to Annex PPP

1. Open water reservoir about 20 m in diameter, the basin possibly 4 m deep with concrete walls.
2. Wooden, EM mess hall, about 50 x 15 x 5 m, with a tar-paper hipped roof; item 2a was EM club.
3. Same type and size building as 2, officers' and civilians' mess hall; item 3a was officers' and civilians' club.
4. Headquarters of the permanent repair base in a two-story white stucco building about 24 x 15 m, with a red tile, hipped roof.
5. Pedestrian entrance gate, guarded by a sentry armed with a Soviet PPSH SMG. Reliefs were three hours.
6. Large, iron, double gate, 8 m wide and 2 m high. The bottom half of each gate was solid sheet iron, the upper half iron grating.
7. Concrete road 10 m wide.
8. Main repair shops in a brick building, about 150 x 20 to 25 m, with a grey tile hipped roof.
 - a. Foundry
 - b. Vulcanizing shop
 - c. Shop where molds were prepared for use in the foundry
 - d. Electrical shop
 - e. Power plant for the building, with a 250-HP diesel engine.
 - f. Lathe and grinding shop.
 - g. Paint shop
 - h. Radiator shop
 - i. Body and upholstery shop
 - j. Transmission shop
 - k. Motor shop
 - l. Office
9. A two-story dispensary 15 x 12 x 8 to 9 m. Personnel included one unidentified medical officer and one NCO.
10. Unpaved parking area enclosed by a high barbed wire strand fence. It was about 150 x 250 to 300 m. It was guarded by a sentry. This parking area was used for vehicles awaiting repair and was fenced to prevent theft.
- 11 to 14. Garages where vehicles undergoing repair were assembled and disassembled. They were about 100 x 50 m. The walls were about 10 m high, the lower 8 m of which were brick, and the upper 2 m wooden siding. The shed roof was of red tile and was about 15 m high at the upper end. Since the buildings were placed in pairs, the effect was that of a sawtooth roof.
- 15 and 16. Wooden, one-story buildings, about 60 x 15 x 7 m, with tar-paper hipped roofs. Use unknown, but in WW II they were used for barracks.
17. Same as 15 and 16, but used as a food and clothing warehouse in WW II.
18. Solid board fence.

CONFIDENTIAL

CONFIDENTIAL

-132-

50X1-HUM

Legend to Annex PPP, continued

19. Wooden gate for railroad line, 6 m wide and $2\frac{1}{2}$ m wide.
20. Railroad line for training purposes only. It was a one-track line of the same width as that used in mines and quarries. It was about 2 or 3 kilometers long and ended at the Targes River. This track was used for training in both construction of a railroad line and operation of the locomotive and several cars with which it was equipped.
21. Wooden latrines.
22. Wire screen fence.
23. Wooden guard shack, $1\frac{1}{2}$ x $1\frac{1}{2}$ x $2\frac{1}{2}$ m, painted in wide red, yellow, and blue stripes, the tricolor of Rumania.
24. Headquarters in a two-story building about 15 x 10 x 9 or 10 m, with a red tile, hipped roof.
- 25 and 26. Wooden warehouses, about 70 x 15 x 8 m, with tar-paper hipped roofs. Item 26 and one-half of item 25 were used to store unidentified construction materials, while the remaining one-half of item 25 was used to store food, clothing, and probably ammunition for the guard.
27. This was a three-story, stuccoed brick building, 120 to 150 x 20 to 25 x 15 to 18 m, with a red tile, hipped roof, and with a basement. It contained student and cadre quarters, mess hall and kitchen, and classrooms.
28. A stuccoed brick construction shop about 40 x 20 x 10 to 12 m, with a red tile, hipped roof.
29. Civilian gasoline storage depot, consisted of about 15 to 20 tanks, both above and below ground, each with a capacity of 15 to 20 metric tons.

CONFIDENTIAL

Annex QQQ

[redacted] LOCATION OF UNIDENTIFIED RUMANIAN ARMY UNDERGROUND AMMUNITION DEPOT NEAR MEDJIDIA, RUMANIA

50X1-HUM

LEGEND:

An unidentified Rumanian Army ammunition depot was located at UTM NK-9401 near MEDJIDIA (N44-15, E28-18)(UTM PK-0200). [redacted]

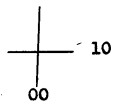

50X1-HUM

50X1-HUM

[redacted] It was completely underground. [redacted] observed 10 or 12 large steel doors set into the hillside, guarded by Rumanian soldiers. There was no fence around the area. [redacted] it was built by the Germans during WW II.

50X1-HUM

50X1-HUM

CONFIDENTIAL

-133-

CONFIDENTIAL

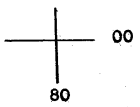

Approximate boundaries of the area

50X1-HUM



50X1-HUM

CONFIDENTIAL

-134-



50X1-HUM

Annex RRR

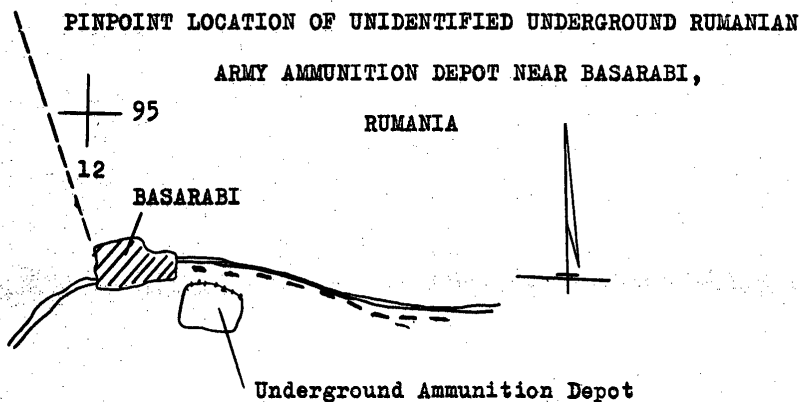

50X1-HUM

LEGEND:

This unidentified underground ammunition depot was constructed during World War II, possibly by the Germans. There were six or seven heavy steel doors set into the hillside, with concrete facing. [redacted] this was an underground ammunition depot, and he observed armed Rumanian military guards and officers near it. [redacted]

50X1-HUM



CONFIDENTIAL

Annex SSS

SKETCH OF UNIDENTIFIED SOVIET AND RUMANIAN MILITARY CAMP
AT UTM MK-392258, RUMANIA

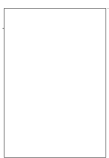

CONFIDENTIAL
-135-

U/i Soviet
Signal Troops'
Tents

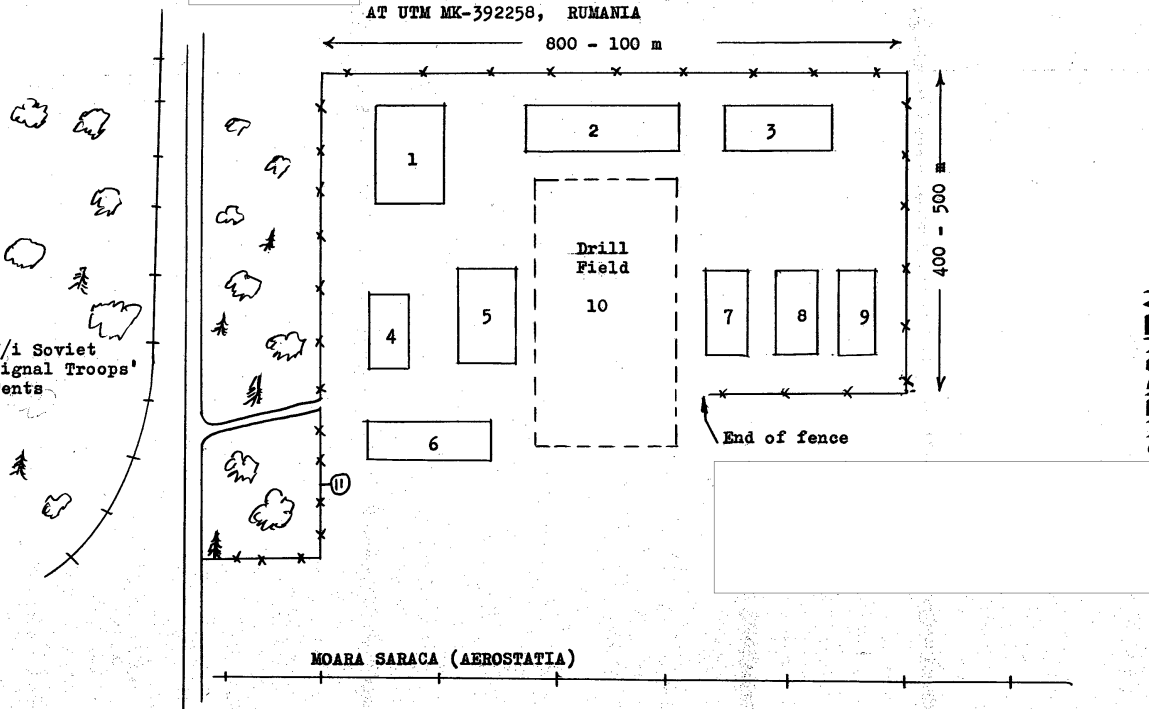

50X1-HUM

50X1-HUM

CONFIDENTIAL

50X1-HUM

CONFIDENTIAL

-136-

50X1-HUM

Legend to Annex SSS

1. A red brick building, two-story, about 30 x 15 m, with a red tile, hipped roof.
2. A red brick building, four-story, about 60 x 20 m, with a red tile, hipped roof.
3. Similar to 1.
4. A red brick building, two-story, about 40 x 10 m, with a red tile, hipped roof.
- 5 to 9. One-story, wooden warehouses, formerly barracks, about 50 x 10 m, with black tar-paper, hipped roofs.
10. Drill field.
11. Barbed wire fence approximately 2 m high.

CONFIDENTIAL

Annex TTT

PINPOINT LOCATION OF UNIDENTIFIED SOVIET ARMORED CASERN IN TIMISOARA, RUMANIA

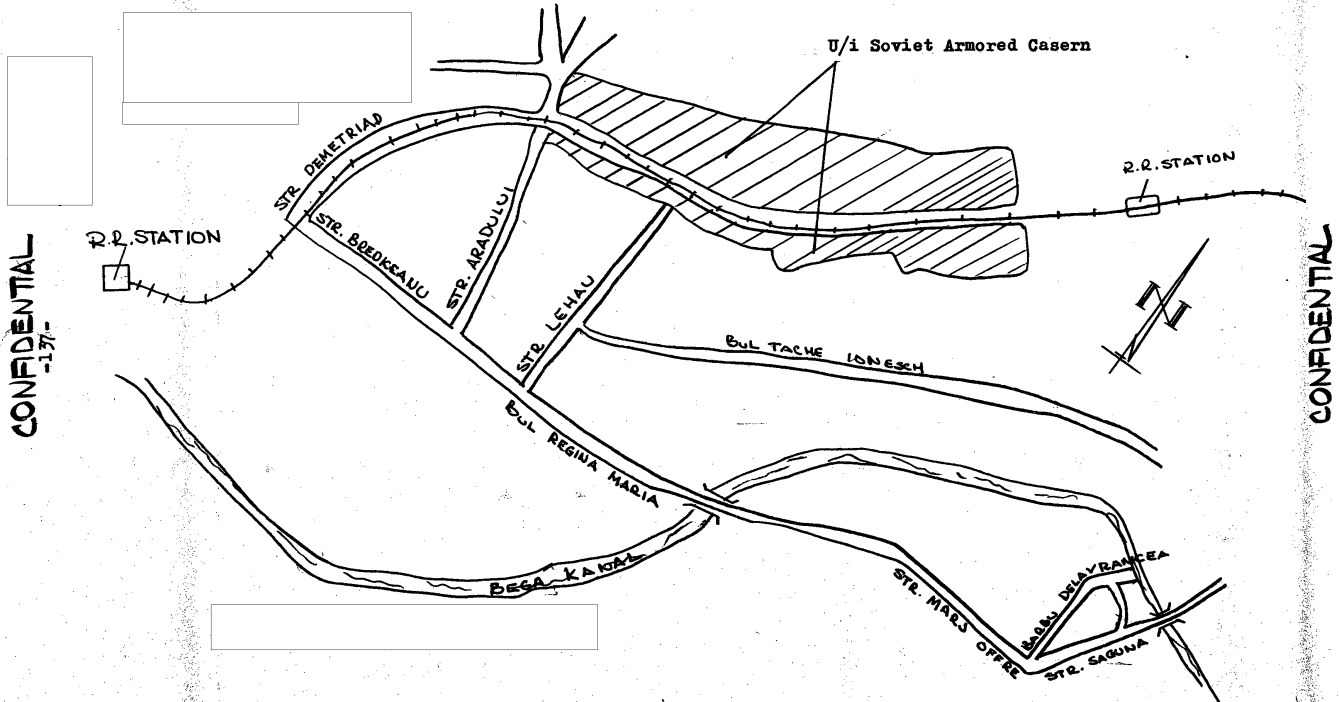

50X1-HUM
50X1-HUM
50X1-HUM

50X1-HUM

Annex UUU

██████████ SKETCH OF CASERN OCCUPIED BY UNIDENTIFIED
SOVIET ARMORED UNIT IN TIMISOARA, RUMANIA

50X1-HUM

50X1-HUM

50X1-HUM

CONFIDENTIAL
-138-

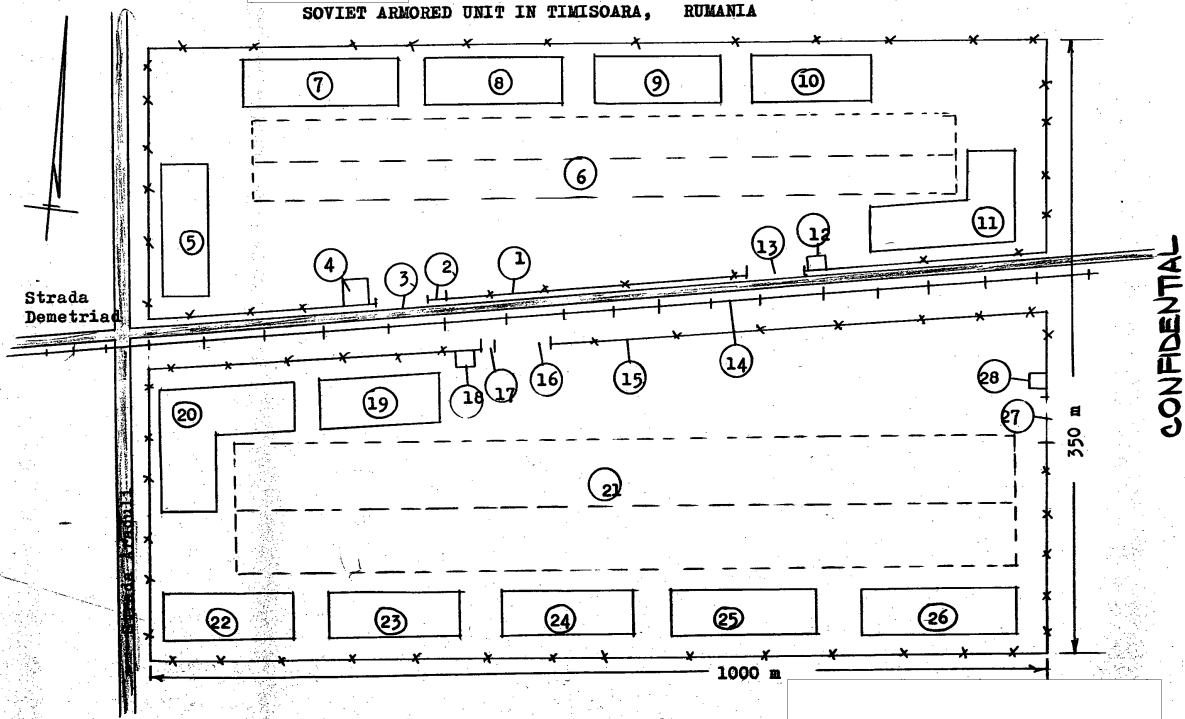

CONFIDENTIAL

-139-

50X1-HUM

Legend to Annex UUU

1. Barbed wire fence approximately 3 m high.
2. Pedestrian gate approximately 1.5 m wide and 3 m high, with a metal frame and barbed wire.
3. A double-door, vehicle gate, approximately 8 to 10 m wide and 3 m high, with a metal frame and barbed wire.
4. An old, one-story guard shack approximately 1.5 x 1.5 x 2.5 m with a tar-paper, gable roof. One guard armed with a Soviet PPSH SMG was on duty at all times.
5. A three-story EM barracks approximately 80 x 20 m, of white stucco with a red tile, gable roof.
6. Parking area for tanks, with white lines indicating a place for each tank.
- 7 to 10. Unidentified, wooden buildings, approximately 100 x 30 x 10 m with grey, tar-paper, gable roofs.
11. An L-shaped, three-story, unidentified building with the south side 70 x 20 m and the east side 50 x 20 m, of white stucco with red tile, gable roof. 50X1-HUM
12. Guard Shack, same as 4. 50X1-HUM
13. Vehicle gate, same as 3.
14. Railroad track from TIMISOARA to BUCHAREST.
15. Barbed wire fence approximately 3 m high.
16. Vehicle gate, same as 3.
17. Pedestrian gate, same as 2.
18. Guard shack, same as 4.
19. A three-story, unidentified building approximately 80 x 20 m, of light red stucco with a red tile, gable roof. Source believed this was EM quarters.
20. An L-shaped, four-story, unidentified building, each wing about 80 x 20 m, of light red stucco with a red tile, gable roof.
21. Parking area for tanks, with white lines indicating a place for each tank.
- 22 to 26. Unidentified buildings, same as 7.
27. Vehicle gate, same as 3.
28. Guard shack, same as 4.

CONFIDENTIAL

CONFIDENTIAL

-140-

Annex VVV

50X1-HUM

**PINPOINT LOCATION OF UNIDENTIFIED SOVIET MILITARY INSTALLATIONS IN
CONSTANTA, RUMANIA**

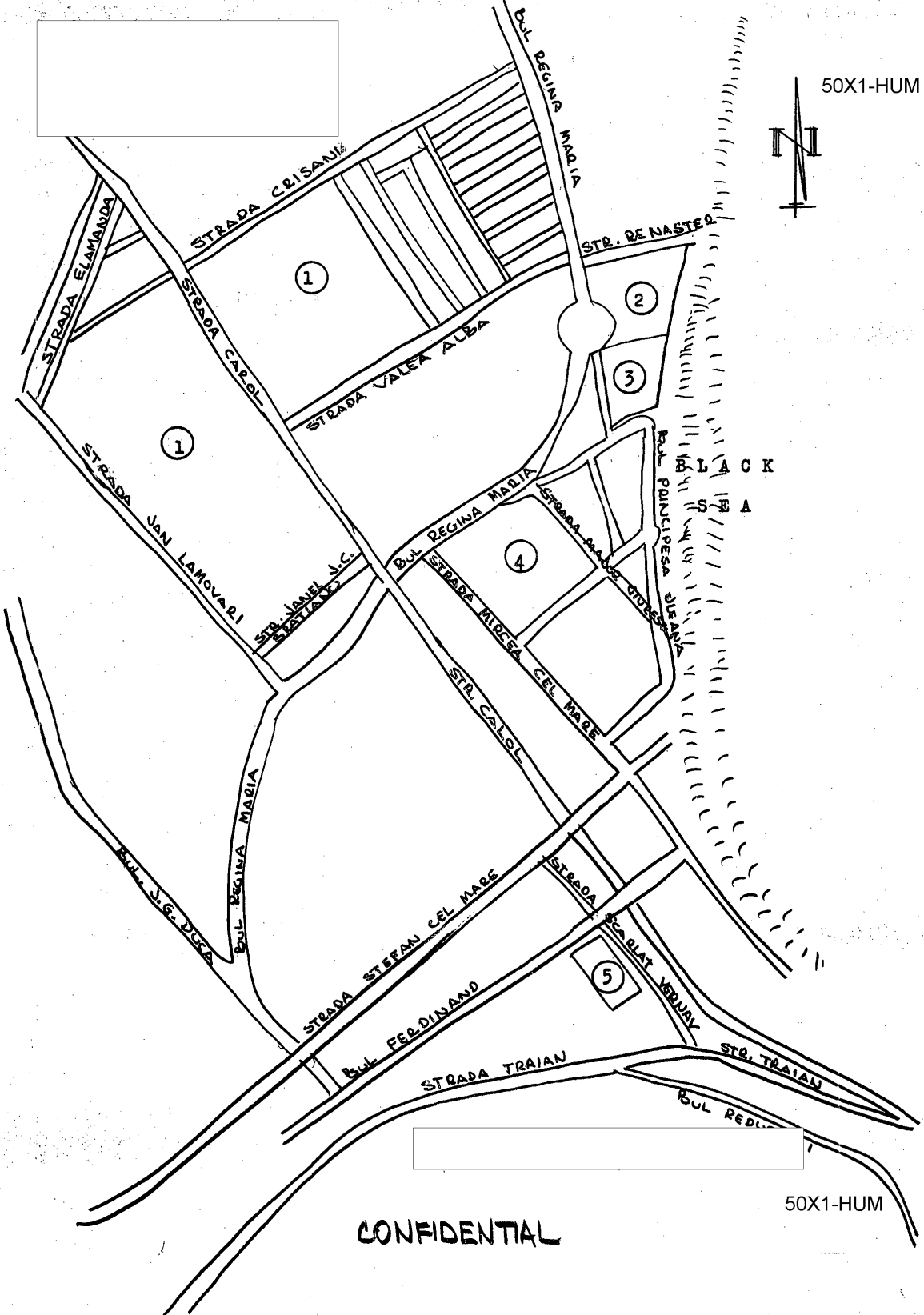

CONFIDENTIAL

50X1-HUM

CONFIDENTIAL

-141-



50X1-HUM

Legend to Annex VVV

1. Unidentified Soviet military casern. (See Annex WWW for description.) 50X1-HUM

2 to 5. Unidentified Soviet Military casern. 

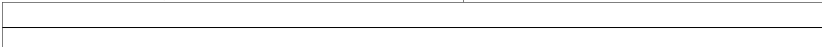
 observe

Soviet soldiers entering and leaving the casern.

CONFIDENTIAL

Annex WWW

SKETCH OF CASERN OCCUPIED BY UNIDENTIFIED SOVIET UNITS IN CONSTANTA, RUMANIA

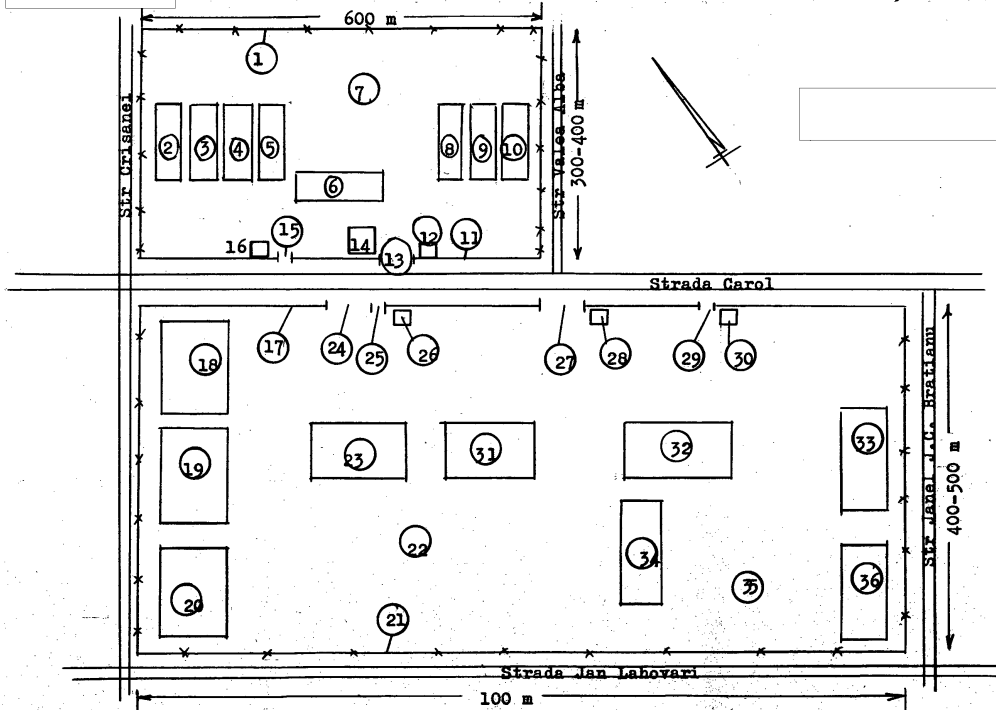

50X1-HUM

50X1-HUM

50X1-HUM

CONFIDENTIAL
-142-





CONFIDENTIAL

CONFIDENTIAL
-143-

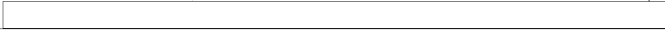

50X1-HUM

Legend to Annex WWW

- 1. Barbed wire fence approximately 2.5 m high.
- 2.to 6. Unidentified, two-story buildings approximately 60 x 15 m, of grey stucco with red tile, gable roofs. 50X1-HUM
- 7. Unidentified area. 

- 8. Headquarters building, same description as 2.
- 9.and 10. Unidentified buildings, same description as 2.
- 11. Wire-mesh fence approximately 2.5 m high.
- 12. A one-story, wooden guard shack approximately 1.5 x 1.5 x 2.5 m, with a tarpaper, gable roof. One guard armed with a Soviet PPSH SMG was on duty at all times.
- 13. A double-door, vehicle gate of wire mesh approximately 8 m wide and 2.5 m high.
- 14. A one-story guard house, approximately 10 x 10 m, of white stucco with a red tile, gable roof.
- 15. A wire-mesh pedestrian gate approximately 1.5 m wide and 2.5 m high.
- 16. Same as 12.
- 17. Wire-mesh fence approximately 2.5 m high.
- 18 to 20. Unidentified, one-story buildings believed to be garages, each approximately 80 x 25 x 10 m, of grey stucco with red tile, gable roofs.
- 21. Barbed wire fence approximately 2.5 m high.
- 22. Unidentified area. 
 50X1-HUM
- 23. A two-story headquarters approximately 50 x 25 m, of grey stucco with a red tile, gable roof.
- 24. Same as 13.
- 25. Same as 15.
- 26. Same as 12.
- 27. Same as 13.
- 28. Same as 12.
- 29. Same as 15.
- 30. Same as 12.



CONFIDENTIAL

CONFIDENTIAL
-144-



50X1-HUM

Legend to Annex WWW, continued

- 31. A two-story, unidentified building approximately 35 x 25 m, of grey stucco with a red tile, gable roof.
- 32. A three-story, unidentified building approximately 60 x 25 m, of grey stucco with a red tile, gable roof.
- 33 and 34. Two-story, unidentified buildings approximately 60 x 15 m, of grey stucco with red tile, gable roofs.
- 35. Unidentified area. 

36. Same as 33.

50X1-HUM

CONFIDENTIAL

Annex XXX

 PINPOINT LOCATION OF UNIDENTIFIED SOVIET ARMY SIGNAL REGIMENT AT RAZVANI, ROMANIA

50X1-HUM

50X1-HUM

50X1-HUM

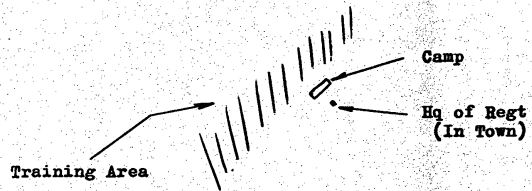
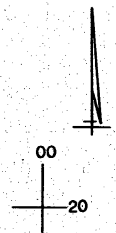

CONFIDENTIAL
-245-

CONFIDENTIAL



Annex YYY

SKETCH OF CAMP OF UNIDENTIFIED SOVIET SIGNAL REGIMENT AT RAZVANI, RUMANIA

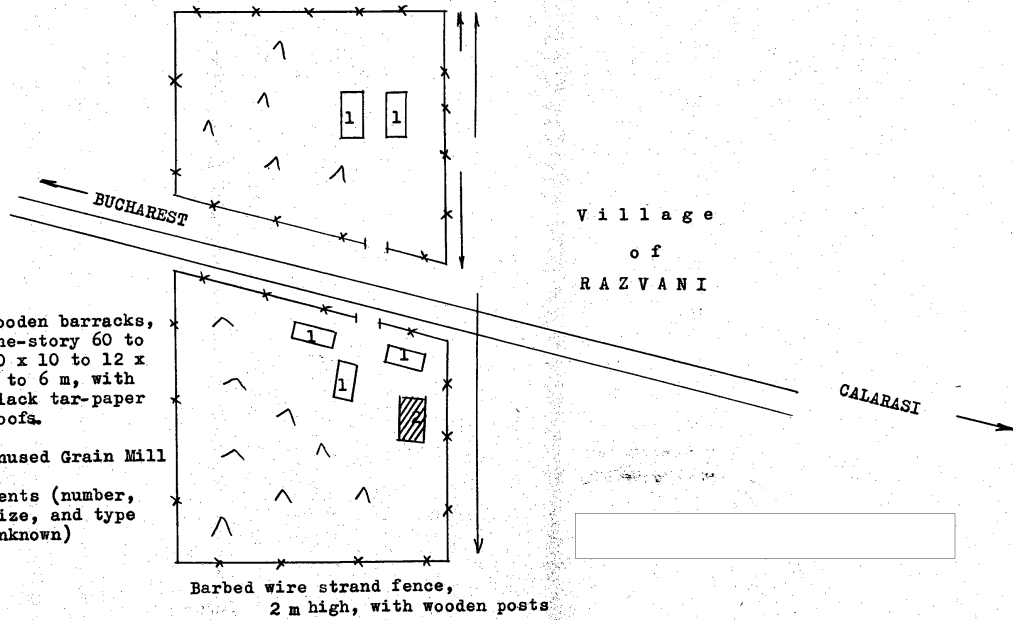

LEGEND:

- 1. Wooden barracks, one-story 60 to 80 x 10 to 12 x 5 to 6 m, with black tar-paper roofs.
- 2. Unused Grain Mill
- △ = Tents (number, size, and type unknown)

Barbed wire strand fence, 2 m high, with wooden posts

CONFIDENTIAL
-146-

CONFIDENTIAL

50X1-HUM

50X1-HUM

50X1-HUM