

March 7, 1978

SG1A

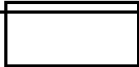

Dear



I am writing to request that you return to us the original tape cassettes of the Price-crane experiment.

In our original agreement with [redacted] we were to archive all of the original data in our files so that it would continue to be available for further research, and we were to supply [redacted] with duplicates. In the case of these Price tapes, however, we were in a time bind and therefore submitted our originals. If you need copies for your files, I am certainly willing to take responsibility to duplicate them for you.

SG1A

SG1A

The reason I wish to get them back, beyond having complete data in our archives, is that we believe we have developed a set of linguistic indicators which permit us to begin to discriminate as to what is correct and what is incorrect in remote viewing transcripts. We are now in the process of checking our hypothesis by passing old transcripts through our discrimination sieve, and we are especially anxious to reexamine our best transcripts from the past.

I believe there is nothing irregular in our request, as you can determine by talking with [redacted] and we sorely need the data to help us evaluate our new discrimination procedures.

With best regards,

H. E. Puthoff, Ph.D.
Senior Research Engineer
Radio Physics Laboratory

HEP:dlt

cc:



17 May
Per discussions with [redacted] was authorized to return these tapes to SRI. It is to be noted that these tapes come into our possession only thru an aberration in procedures; thus, the return of these tapes completes SRI's inventory of all original tapes of this project.

SG1A

SG1A

SRI International





STANFORD RESEARCH INSTITUTE
Menlo Park, California 94025 · U.S.A.

Final Report

December 1, 1975

Covering the Period January 1974 through February 1975

PERCEPTUAL AUGMENTATION TECHNIQUES

Part Two--Research Report

By: Harold E. Puthoff and Russell Targ
Electronics and Bioengineering Laboratory

SRI Project 3183

Classification Determination Pending.
Protect as though classified SECRET.

Approved by:

Earle Jones, Director
Electronics and Bioengineering Laboratory

Bonnar Cox, Executive Director
Information Science and Engineering Division

Certain individual pages of this document are UNCLASSIFIED. However, the association and compilation of this material may indicate defense information, the unauthorized disclosure of which could reasonably be expected to cause serious damage to the national security; hence, an overall classification of SECRET is warranted.

SECRET

Approved For Release 2003/06/24 : CIA-RDP79-00999A000300100034-4

~~SECRET~~

RESEARCH REPORT		Page
Illustrations		iii
Tables		iv
I	ABSTRACT	1
II	PROGRAM RESULTS--APPLIED RESEARCH EFFORT	3
	A. Remote Viewing	3
	1. Long-Distance Remote Viewing: Sponsor-Designated Targets (Exploratory Research)	3
	a. West Virginia Site (S3)	4
	b. West Virginia Site (S1)	6
	c. Urals Site (S1)	7
	d. Summary of Exploratory Research	8
	2. Long-Distance Remote Viewing: Sponsor-Designated Target (Operational Target, Semipalatinsk, USSR)	8
	3. Long-Distance Remote Viewing: SRI-Designated Targets (Exploratory Research, Costa Rica Series)	12
	4. Short-Distance Remote Viewing (Cipher Machine Analog)	15
	5. Short-Distance Remote Viewing (Technology Series)	17
	B. Detection of Secret Writing Target Material	27
III	PROGRAM RESULTS--BASIC RESEARCH EFFORT	35
	A. Screening Tests	35
	1. Remote Viewing of Natural Targets Under Standard Protocol Conditions	36
	a. Subject S1 (Experienced)	38
	b. Subject S4 (Learner/Controls)	40
	c. Subjects S2 and S3 (Experienced)	46
	d. Subjects S5 and S6 (Learner/Controls)	49
	e. Sponsor Subjects (Learner/Controls)	49
	f. Summary of Remote-Viewing Experiments (Standard Protocol)	53
	2. Four-State Electronic Random Number Generator	66
	a. Machine Description	67
	b. Data from Experiments	69
	B. Identification of Measurable Characteristics Possessed by Gifted Subjects	76
	1. Medical Evaluation	76

~~SECRET~~

UNCLASSIFIED

	Page
2. Psychological Evaluation	79
a. Evaluation by Clinical Psychologist Administering Tests	80
b. Evaluation by Chief Clinical Psychologist	83
3. Neuropsychological Evaluation	88
C. Identification of Neurophysiological Correlates That Relate to Paranormal Activity	94
1. Remote Strobe Experiment	97
2. Mid-Experiment Monitoring of Physiological Parameters During Routine Experimentation in Remote Viewing	103
D. Identification of the Nature of Paranormal Phenomena and Energy	106
1. Experiments with Physical Apparatus	106
a. Experiments with Geiger Counter	106
b. Experiments with Laser-Monitored Torsion Pendulum	107
c. Experiments with Superconducting Differential Magnetometer (Gradiometer)	108
d. Discussion of Physical Perturbation Effects	113
2. Discussion of Possible "Mechanisms" in Remote Viewing	117
3. Communication Theory Approach to Channel Utilization	121
4. Soviet Efforts	129
5. Conclusions	130
IV PROGRAM SUMMARY	132
REFERENCES	135
APPENDICES	
A. Remote Viewing Transcript for Subject S6, Learner/Control, First Experiment	A-1
B. Instructions to Subject: EEG Experiment	B-1
C. Universal Randomization Protocol	C-1

UNCLASSIFIED

UNCLASSIFIED

ILLUSTRATIONS

1. Maps of West Virginia Site Drawn by Subject S3
2. Map and Detail of Site Drawn by Subject S1
3. Artist's Rendering of Site
4. Costa Rica Site Drawings and Photographs
5. Abacus/Clock Drawings and Photograph
6. Video Terminal
7. Typewriter
8. Xerox Machine
9. Drill Press
10. Procedure for Card Sorting by Sequential Sampling
11. Swimming Pool Complex (S1)
12. Pedestrian Overpass (S4)
13. Bicycle Shed (S4)
14. Tennis Court (S2)
15. Palo Alto City Hall (S3)
16. White's Plaza, Stanford University (S6)
17. Merry-Go-Round
18. Windmill
19. Four-State Random Number Generator Used in This Experiment
20. Data Summary for Subject S2
21. Drawings and Interpretations by Associative Visual Agnosia Patients
22. Shielded Room Used for EEG Experiments
23. Occipital EEG Frequency Spectra of Subject S4
24. Polygraph Data from Subject S4
25. Superconducting Differential Magnetometer (Gradiometer)
26. Gradiometer Data
27. Enhancement of Signal-to-Noise Ratio by Sequential Sampling Procedure
28. Operating Characteristic Curve for Sequential Sampling Procedure
29. Average Sample Number for Sequential Sampling Procedure

UNCLASSIFIED

UNCLASSIFIED

TABLES

1. Subject, Target Selection Procedure, and Figure Numbers for Technology Series.
2. Rank Ordering Match of Drawings to Target Locations (Blind Judging, Technology Series)
3. Critical Values of Sums of Ranks for Preferential Matching
4. The Probability of M Correct Guesses of N Distinct Items
5. Key for Secret Writing Experiment
6. Raw Data Call Sheet for Secret Writing Experiment
7. Distribution of Rankings of Transcripts Associated with Each Target Selection for Subject S1, Experienced.
8. Distribution of Rankings of Transcripts Associated with Each Target Location for Subject S4, Learner/Control
9. Distribution of Rankings of Transcripts Associated with Each Target Location for Subjects S2 and S3, Experienced
10. Distribution of Rankings of Transcripts Associated with Each Target Location for Subjects S5 and S6, Learner/Control
11. Distribution of Rankings of Transcripts Associated with Each Target Location for Sponsor Subjects, Learner/Control
12. Summary--Remote Viewing of Natural Targets
13. Four-State Electronic Random Number Generator Summary
14. Randomness Tests for Machine M1 Output during Successful Experimental Series
15. Randomness Tests for Machine M2 Output during Successful Experimental Series
16. Randomness Tests for Entire Machine Output During Successful Experimental Run
17. Subject S2 Selections on Machine M1 during Successful Experimental Series
18. Subject S2 Selections on Machine M2 during Successful Experimental Series
19. Neuropsychology Test Battery
20. EEG Data for Subject S4
21. Geiger Counter Experiment Summary
22. Five-Bit Code for Alphanumeric Characters

UNCLASSIFIED

UNCLASSIFIED

I ABSTRACT

As a result of exploratory research on human perception carried out in SRI's Electronics and Bioengineering Laboratory, we initiated a program to investigate a perceptual channel whereby individuals can access by means of mental imagery and describe randomly chosen sites remote from their physical location. This ability appeared to be sufficiently well developed in certain individuals to allow them to at times describe correctly--often in great detail--geographical or technical material, such as buildings, roads, laboratory apparatus, and the like. In this final report (Part Two--Research Report[†]), we document in detail the 12-month study at SRI of this human information-accessing capability which we call "remote viewing," the characteristics of which appear to fall outside the range of well-understood perceptual or information-processing abilities. This phenomenon is one of a broad class of abilities of certain individuals to access, by means of mental processes, and describe information sources blocked from ordinary perception and generally accepted as secure against access.

The phenomenon we investigated most extensively was the ability of individuals to view remote geographical locations (up to several thousand kilometers away), given only coordinates (latitude and longitude) or a person at a location on whom to target. The development at SRI of successful experimental procedures to elicit this capability has evolved to the point where (a) visiting personnel of the sponsoring organization without any previous exposure to such concepts have performed well under controlled laboratory conditions (that is, generated target descriptions of sufficiently high quality to permit blind matching of descriptions to targets by independent judges), and (b) subjects trained over a two-year period have performed well under operational conditions (that is, provided data of operational significance later verified by independent sources). Our accumulated data thus indicate that both specially selected and unselected persons can be assisted in developing remote perceptual abilities to a level of useful information transfer. The primary achievement of the SRI program was thus the elicitation of high-quality remote viewing by

[†] For summary, see Part One--Executive Summary

UNCLASSIFIED

UNCLASSIFIED

individuals who agreed to act as subjects.

In carrying out this program we concentrated on what we considered to be our primary responsibility--to resolve under unambiguous conditions the basic issue of whether this class of paranormal perception phenomenon exists. At all times the researchers and SRI management took measures to prevent sensory leakage and subliminal cueing and to prevent deception, whether intentional or unintentional. All experiments were carried out under protocols in which target selection at the beginning of experiments and blind judging of results at the end of experiments were handled independently of the researchers involved in carrying out the experiments, thus assuring evaluations independent of the belief structures of both experimenters and judges.

The program was divided into two categories of approximately equal effort--applied research and basic research. In Section II we summarize the results of the applied research effort in which the operational utility of the above perceptual abilities was explored. In Section III we summarize the results of the basic research effort, which was directed toward identification of the characteristics of individuals possessing such abilities and the determination of neurophysiological correlates and basic mechanisms involved in such functioning. With an eye toward selection of future subjects, individuals possessing a well-developed natural ability in the area under investigation underwent complete physical, psychological, and neuropsychological profiling, the results of which suggest some hypotheses for developing a screening procedure. The program summary is presented in Section IV.

With regard to understanding the phenomenon, the precise nature of the information channel that couples remote locations is not yet understood. However, its general characteristics are compatible with both quantum theory and information theory as well as with recent developments in research on brain function. Therefore, our working assumption is that the phenomenon of interest does not lie outside the purview of modern physics and with further work will yield to analysis and specification.

Finally, it is concluded by the research contractor (SRI) that the development of experimental procedures and the accrual of experience in

UNCLASSIFIED

UNCLASSIFIED

three years of successful effort constitutes an asset that could be utilized in the future, both for operational needs and for training others in the development and use of the remote-sensing capability.

II PROGRAM RESULTS--APPLIED RESEARCH EFFORT

A. Remote Viewing

As mentioned in the Abstract, the phenomenon we investigated most extensively was the ability of individuals to view remote geographical locations (up to several thousand kilometers away), given only coordinates (latitude and longitude) or a person at a location on whom to target. Individuals exhibiting this faculty include not only SRI participants but also visiting staff members of the sponsoring organization who participated as subjects so as to critique the protocol.

As observed in the laboratory, the basic phenomenon appears to cover a range of subjective experiences variously referred to in the literature as autoscopy (in the medical literature); exteriorization or disassociation (psychological literature); simple clairvoyance, traveling clairvoyance, or out-of-body experience (parapsychological literature); or astral projection (occult literature). We choose the term "remote viewing" as a neutral descriptive term free of occult assumptions or bias as to the mechanisms involved.

We begin our report in subsections 1 and 2 with experiments under the control of the sponsor. These experiments were designed to provide a vehicle whereby the sponsor could establish independently of SRI, some degree of confidence as to the existence of the long-distance remote viewing faculty.

1. Long-Distance Remote Viewing: Sponsor-Designated Targets (Exploratory Research)

So as to subject the remote-viewing phenomena to a rigorous long-distance test under external control, a request for geographical coordinates of a site unknown to subject and experimenters was forwarded to the sponsor's group responsible for threat analysis in this area. In response, an SRI experimenter received a set of coordinates identifying

UNCLASSIFIED

UNCLASSIFIED

what is hereafter referred to as the West Virginia Site. The SRI experimenter then carried out remote-viewing experiments with two subjects on a double-blind basis, that is, with target content blind to experimenter as well as to subjects. (Following the experiment both subjects claimed unfamiliarity with the West Virginia area.) The experiment had as its goal the determination of the utility of remote viewing under conditions approximating an operational scenario.

a. West Virginia Site (S3)*

Date: 29 May 1973, 1634 to 1640 hours, Menlo Park, California. Protocol: Coordinates 38°23'45" to 48"N, 79°25'00"W, described simply as being in West Virginia, were relayed to experimenter Dr. H.E. Puthoff by telephone, who then relayed this information to subject S3 to initiate experiment. No maps were permitted, and the subject was asked to give an immediate response. The session was recorded on video tape. The oral response is reproduced here from the tape:

This seems to be some sort of mounds or rolling hills. There is a city to the north (I can see the taller buildings and some smog). This seems to be a strange place, somewhat like the lawns that one would find around a military base, but I get the impression that there are either some old bunkers around, or maybe this is a covered reservoir. There must be a flagpole, some highways to the west, possibly a river over to the far east, to the south more city.

The map in Figure 1(a) was drawn by the subject.

On the following morning, S3 submitted a written report of a second reading, dated 30 May 1973, 0735 to 0758 hours, Mountain View, California:

Cliffs to the east, fence to the north. There's a circular building (a tower?), buildings to the south. Is this a former Nike base or something like that? This is about as far as I could go without feedback, and perhaps guidance as to what was wanted. There is something strange about this area, but since I don't know particularly what to look for within the scope of the cloudy ability, it is extremely difficult to make decisions on what is there and what is not. Imagination seems to get in the way. (For example, I seem to get the impression of something

*S3 identifies a subject. A key to numerical designations for subjects is available from the sponsor's Contracting Officer Technical Representative (COTR).

UNCLASSIFIED

UNCLASSIFIED

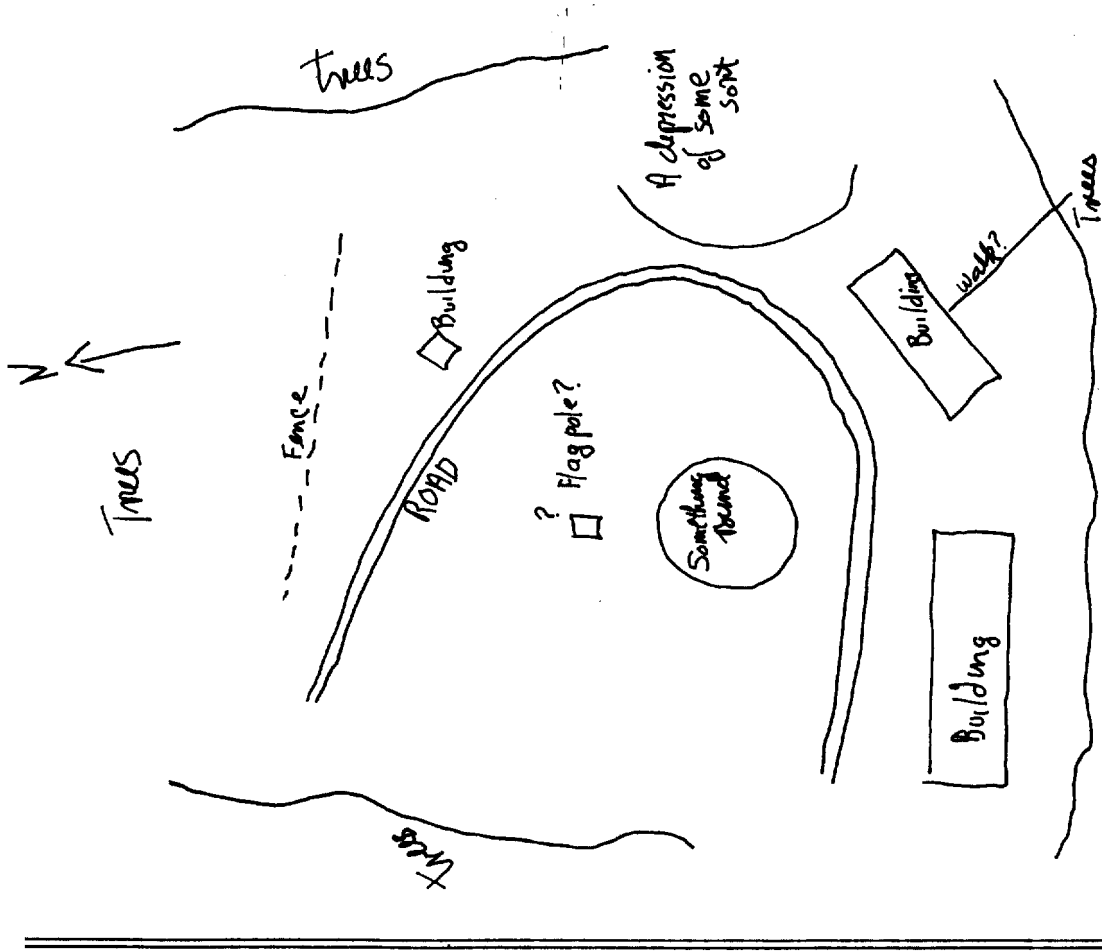

(b) DETAIL

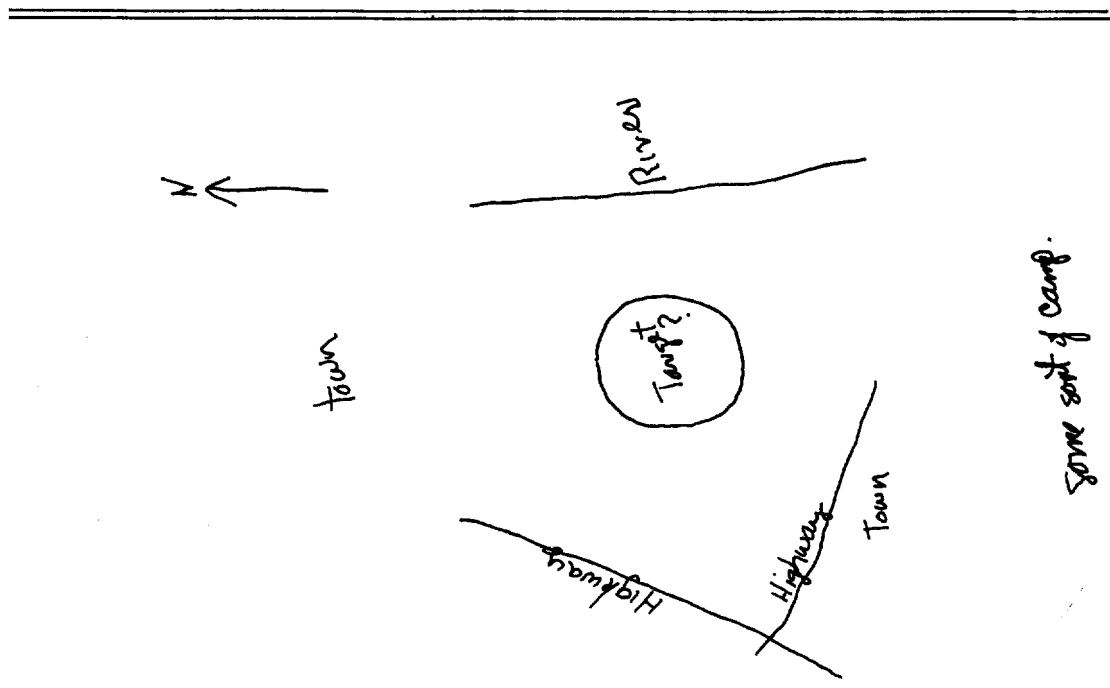

some sort of camp.

(a) OVERVIEW

FIGURE 1 MAPS OF WEST VIRGINIA SITE DRAWN BY SUBJECT S3

UNCLASSIFIED

UNCLASSIFIED

underground, but I'm not sure.) However, it is apparent that on first sighting, the general location was correctly spotted.

The map in Figure 1(b) also was drawn by the subject.

b. West Virginia Site (S1)

As a backup test, the coordinates were given to a second subject, S1. The task was presented to the second subject independently of the first subject, both to prevent collaboration and to prevent any sense of competition.

Date: 1 June 1973, 1700 hours, Menlo Park, California.
Protocol: Coordinates 38°23'45" to 48"N, 79°25'00"W were given (with no further description) by experimenter Dr. H.E. Puthoff to subject S1 by telephone to initiate experiment.

On the morning of 4 June 1973, S1's written response (dated 2 June 1973, 1250 to 1350 hours, Lake Tahoe, California) was received in the mail:

Looked at general area from altitude of about 1500 ft above highest terrain. On my left forward quadrant is a peak in a chain of mountains, elevation approximately 4996 ft above sea level. Slopes are greyish slate covered with variety of broad-leaf trees, vines, shrubbery, and undergrowth. I am facing about 3° to 5° west of north. Looking down the mountain to the right (east) side is a roadway--freeway, country style--curves then heads ENE to a fairly large city about 30 to 40 miles distant. This area was a battleground in civil war--low rolling hills, creeks, few lakes or reservoirs. There is a smaller town a little SE about 15 to 20 miles distant with small settlements, village type, very rural, scattered around. Looking across the peak, 2500 to 3000 ft mountains stretch out for a hundred or so miles. Area is essentially wooded. Some of the westerly slopes are eroded and gully washed--looks like strip mining, coal mainly.

Weather at this time is cloudy, rainy. Temperature at my altitude about 54°F--high cumulo nimbus clouds to about 25,000 to 30,000 ft. Clear area, but turbulent, between that level and some cirro stratus at 46,000 ft. Air mass in that strip moving WNW to SE.

1318 hours--Perceived that peak area has large underground storage areas. Road comes up back side of mountains (west slopes), fairly well concealed, looks deliberately so. It's cut under trees where possible--would be very hard to detect flying over area. Looks like former missile site--bases for launchers still there, but area now houses record storage area, microfilm, file cabinets; as you go into underground area

UNCLASSIFIED

SECRET

through aluminum rolled up doors, first areas filled with records, etc. Rooms about 100-ft long, 40-ft wide, 20-ft ceilings, with concrete supporting pilasters, flare-shaped. Temperature cool--fluorescent lighted. Personnel, Army 5th Corps Engineers. M/Sgt. Long on desk placard on grey steel desk--file cabinets security locked--combination locks, steel rods through eye bolts. Beyond these rooms, heading east, are several bays with computers, communication equipment, large maps, display type, overlays. Personnel, Army Signal Corps. Elevators.

1330 hours--Looked over general area from original location again--valleys quite hazy, lightning about 30 miles north along mountain ridge. Temperature drop about 6°F, it's about 48°F. Looking for other significances: see warm air mass moving in from SW colliding with cool air mass about 100 miles ESE from my viewpoint. Air is very turbulent--tornado type; birds in my area seeking heavy cover. There is a fairly large river that I can see about 15 to 20 miles north and slightly west; runs NE then curves in wide valley running SW to NE; river then runs SE. Area to east: low rolling hills. Quite a few Civil War monuments. A marble colonnade type: 'In this area was fought the battle of Lynchburg where many brave men of the Union and Confederate Armys (sic) fell. We dedicate this area to all peace loving people of the future--Daughters G.A.R.'

On a later date S1 was asked to return to the West Virginia site with the goal of obtaining information on code words, if possible. In response, S1 supplied the following information:

Top of desk had papers labeled "Flytrap" and "Minerva".

File cabinet on north wall labeled "Operation Pool..."
(third word unreadable).

Folders inside cabinet labeled "Cueball", "14 Ball", "4 Ball", "8 Ball", and "Rackup".

Name of site vaguely seems like Hayfork or Haystack. Personnel: Col. R.J. Hamilton, Maj. Gen. George R. Nash, Major John C. Calhoun (??).

c. Urals Site (S1)

After obtaining a reading on the West Virginia Site, S1 volunteered that he had scanned the other side of the globe for a Communist Bloc equivalent and found one located in the Urals at 65°00'57"N, 59°59'59"E, described as follows:

Elevation, 6200 ft. Scrubby brush, tundra-type ground hummocks, rocky outcroppings, mountains with fairly steep slopes. Facing

SECRET

SECRET

north, about 60 miles ground slopes to marshland. Mountain chain runs off to right about 35° east of north. Facing south, mountains run fairly north and south. Facing west, mountains drop down to foothills for 60 miles or so; some rivers running roughly north. Facing east, mountains are rather abrupt, dropping to rolling hills and to flat land. Area site underground, reinforced concrete, doorways of steel of the roll-up type. Unusually high ratio of women to men, at least at night. I see some helipads, concrete. Light rail tracks run from pads to another set of rails that parallel the doors into the mountain. Thirty miles north (5° west of north) of the site is a radar installation with one large (165 ft) dish and two small fast-track dishes.

The two reports for the West Virginia Site, and the report for the Urals Site were verified by personnel in the sponsor organization as being substantially correct. The results of the evaluation are contained in a separate report filed with the COTR.

d. Summary of Exploratory Research

The observation of such unexpectedly high-quality descriptions early in our program led to a large-scale study of the phenomenon under secure double-blind conditions (i.e., target unknown to experimenters as well as subjects), with independent random target selection and blind judging. The results, presented later, provide strong evidence for the robustness of this phenomenon, one whereby complex remote stimuli can be detected by a human perceptual modality of extreme sensitivity. Before discussing these results, however, we consider further examples of both operational and operational-analog experiments.

2. Long-Distance Remote Viewing: Sponsor-Designated Target (Operational Target--Semipalatinsk, USSR)

To determine the utility of remote viewing under operational conditions, a long-distance remote viewing experiment was carried out on a sponsor-designated target of current interest, an unidentified research center at Semipalatinsk, USSR.

This experiment, carried out in three phases, was under direct control of the COTR. To begin the experiment, the COTR furnished map coordinates in degrees, minutes, and seconds. The only additional information provided was the designation of the target as an R&D test facility. The experimenters then closeted themselves with subject S1, gave him the

SECRET

SECRET

map coordinates and indicated the designation of the target as an R&D test facility. A remote-viewing experiment on the target was then carried out. This activity constituted Phase I of the experiment.

Figure 2(a) shows the subject's graphic effort for building layout; Figure 2(b) shows the subject's particular attention to a multi-story gantry crane he observed at the site. Both results were obtained by the experimenters on a double-blind basis before exposure to any additional COTR-held information, thus eliminating the possibility of cueing. These results were turned over to the client representatives for evaluation. For comparison an artist's rendering of the site as known to the COTR (but not to the experimenters until later) is shown in Figure 3(a), with crane detail shown in Figure 3(b).

Were the results not promising, the experiment would have stopped at this point. Description of the multistory crane, however, a relatively unusual target item, was taken as indicative of possible target acquisition. Therefore, Phase II was begun, defined by the subject being made "witting" (of the client) by client representatives who introduced themselves to the subject at that point; Phase II also included a second round of experimentation on the Semipalatinsk site with direct participation of client representatives in which further data were obtained and evaluated. As preparation for this phase, client representatives purposely kept themselves blind to all but general knowledge of the target site to minimize the possibility of cueing. The Phase II effort was focused on the generation of physical data that could be independently verified by other client resources, thus providing a calibration of the process.

The end of Phase II gradually evolved into the first part of Phase III, the generation of unverifiable data concerning the Semipalatinsk site not available to the client, but of operational interest nonetheless. Several hours of tape transcript and a notebook full of drawings were generated over a two-week period.

The data describing the Semipalatinsk site were evaluated by the sponsor, and are contained in a separate report. In general, several details concerning the salient technology of the Semipalatinsk site appeared to dovetail with data from other sources, and a number of specific

SECRET

UNCLASSIFIED

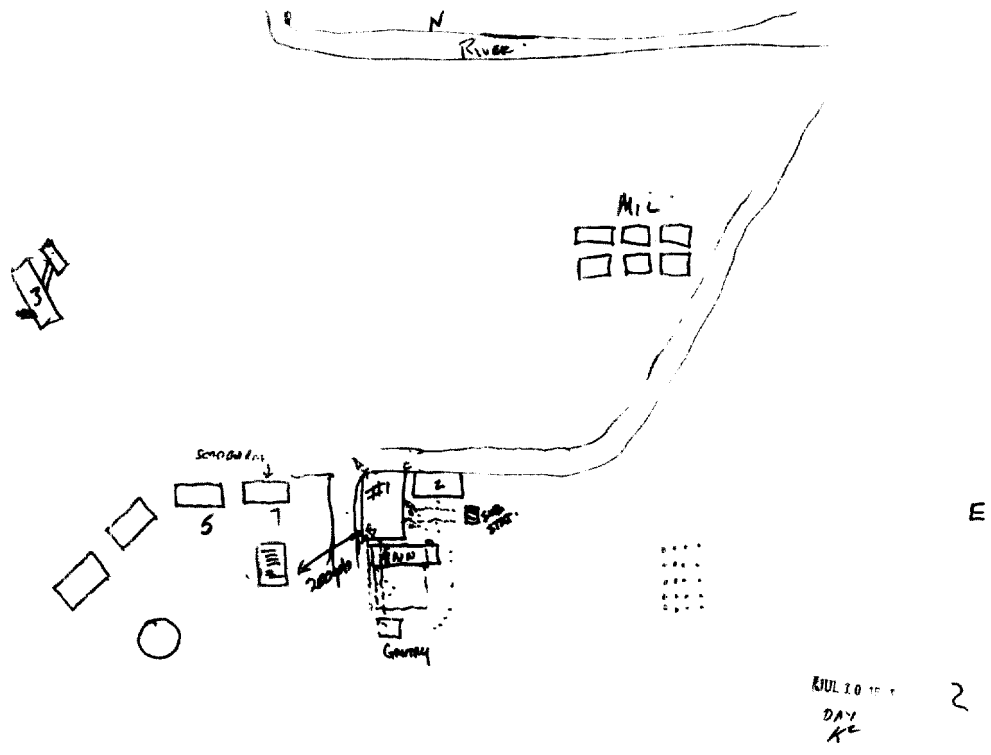

(a) SUBJECT EFFORT AT BUILDING LAYOUT

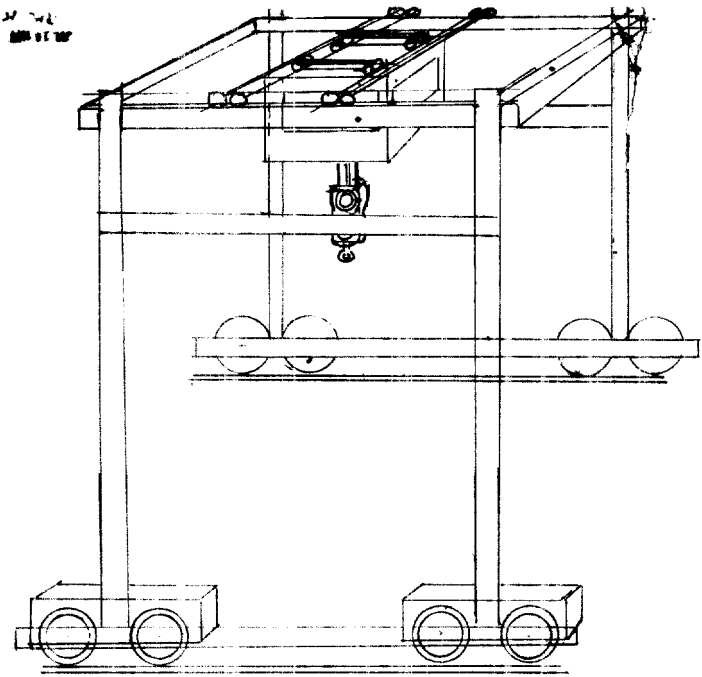

(b) SUBJECT EFFORT AT CRANE CONSTRUCTION

FIGURE 2 MAP AND DETAIL OF SITE DRAWN BY SUBJECT S1

UNCLASSIFIED

SECRET

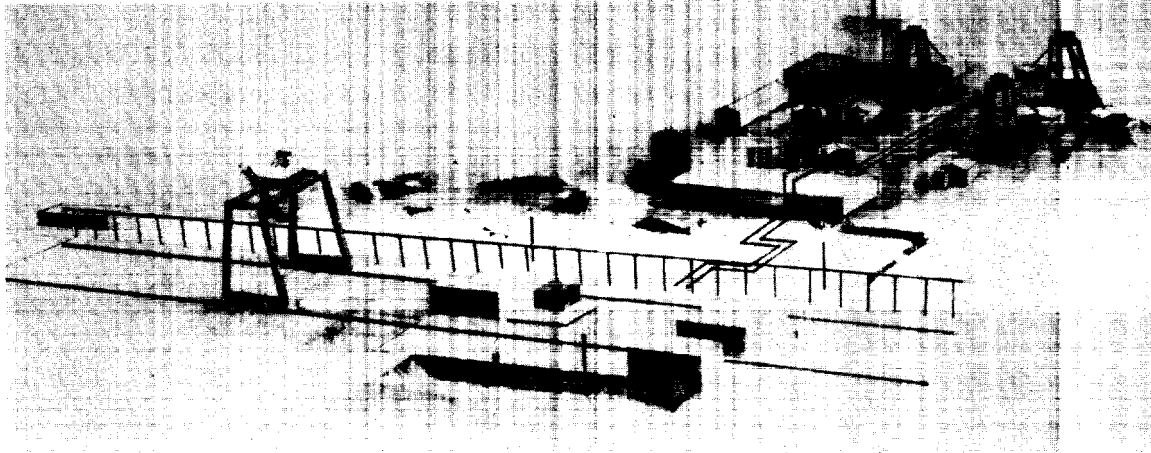

(a) TARGET SITE

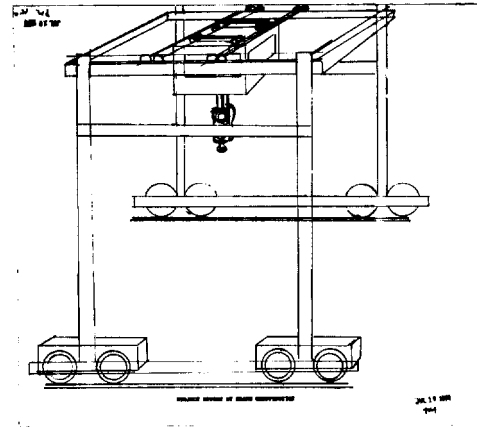
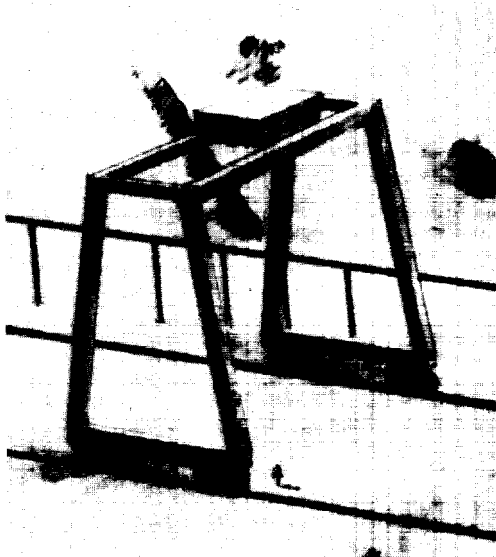

(b) CRANE COMPARISON

FIGURE 3

SECRET

UNCLASSIFIED

large structural elements were correctly described. The results contained noise along with the signal, but were nonetheless clearly differentiated from the chance results that were generated by control subjects in comparison experiments carried out by the COTR.

3. Long-Distance Remote Viewing: SRI-Designated Targets (Exploratory Research, Costa Rica Series)

The experimental procedures of Subsections 1 and 2 were designed to provide a vehicle whereby the client could establish, independently of SRI, some degree of confidence as to the existence of a long-distance remote viewing faculty. Although the results were indicated to be positive, from the standpoint of SRI personnel who could not participate in the evaluation phase, it was considered necessary to supplement the above experiments with a similar set under SRI control. Therefore, SRI-controlled experiments were undertaken to enable the experimenters to participate directly in the evaluation phase of the remote-viewing experiments.

Two subjects (S1 and S4) were asked to participate in a long-distance experiment focusing on a series of targets in Costa Rica. The subjects said they had never been to Costa Rica.

In this experiment, one of the experimenters (Dr. Puthoff) spent ten days traveling through Costa Rica on a combination business/pleasure trip. This information was all that was known to the subjects about the traveler's itinerary. The experiment called for Dr. Puthoff to keep a detailed record of his location and activities, including photographs, each of seven target days at 1330 PDT. A total of 12 daily descriptions were collected before the traveler's return: six responses from S1, five responses from S4, and one response from an SRI experimenter, who acted as a subject in one experiment on a day in which S4 was not available and the other subject arrived late.

For its illustrative value we consider first the single response submitted by the experimenter filling in as a subject. The response, a drawing submitted for a day in the middle of the series, is shown in Figure 4 together with photographs taken at the site. Although Costa Rica is a mountainous country, the subject unexpectedly perceived the traveler at a beach and ocean setting. With some misgivings, he described an

UNCLASSIFIED

UNCLASSIFIED

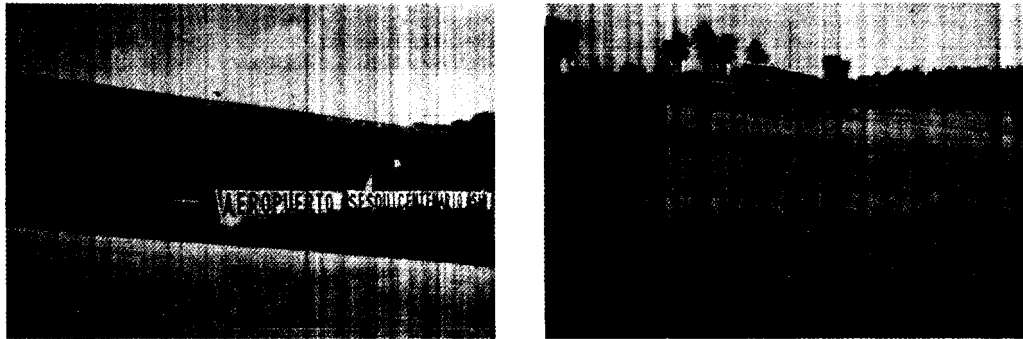

AIRPORT IN SAN ANDRES, COLOMBIA, USED AS REMOTE VIEWING TARGET

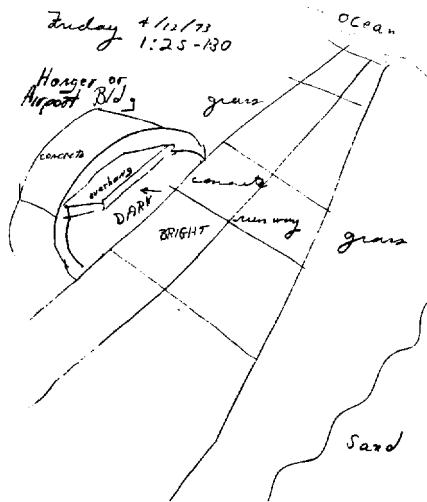

SA-3183-20

FIGURE 4 AIRPORT IN SAN ANDRES, COLOMBIA, USED AS REMOTE VIEWING TARGET ALONG WITH SKETCH PRODUCED BY SUBJECT IN CALIFORNIA

UNCLASSIFIED

UNCLASSIFIED

airport on a sandy beach and an airstrip with the ocean at the end (correct). An airport building also was drawn, and shown to have a large rectangular overhang (correct). The traveler had taken a one-day unplanned side trip to an offshore island and at the time of the experiment had just disembarked from a plane at a small island airport as described, 4000 kilometers from SRI. The sole discrepancy was that the drawing showed a Quonset-hut type of building in place of the rectangular structure.

The above description was chosen as an example to illustrate two major points observed a number of times throughout the program. First, in opposition to what might be expected, a subject's description does not necessarily portray what might reasonably be expected to be correct (an educated or "safe" guess) but often runs counter to even the subject's own expectations. Second, individuals other than those with putative "paranormal ability" are able to exhibit a remote viewing faculty.

The remaining submissions provided further examples of excellent correspondences between target and response. (A target period of pool-side relaxation was identified, a drive through a tropical forest at the base of a truncated volcano was described as a drive through a jungle below a large bare table mountain, a hotel room target description, including such details as rug color, was correct, and so on.) So as to determine whether such matches were simply fortuitous, i.e., could reasonably be expected on the basis of chance alone, when Dr. Puthoff returned he was asked to blind match the 12 descriptions to the seven target locations. On the basis of this conservative evaluation procedure, which vastly underestimates the statistical significance of the individual descriptions, five correct matches were obtained (two each of subjects S1 and S4, and the single submission by the experimenter). This number of matches is significant at $p = 0.02$ by exact binomial calculation.*

* The probability of a correct daily match by chance for any given transcript is $p = 1/7$. Therefore, the probability of at least five correct matches by chance out of 12 tries can be calculated from

$$p = \sum_{i=5}^{12} \frac{12!}{i!(12-i)!} \left(\frac{1}{7}\right)^i \left(\frac{6}{7}\right)^{12-i} = 0.02.$$

UNCLASSIFIED

~~UNCLASSIFIED~~

Therefore, this pilot study, completely under control of SRI, provided confirmatory data supporting that obtained under sponsor control, indicating the existence of an apparent long-distance remote viewing faculty.

4. Short-Range Remote Viewing (Cipher Machine Analog)

As a further test of operational utility of the remote viewing faculty, the COTR tasked the contractors with an experiment designed to duplicate as closely as possible an operational situation of current interest, the remote viewing of an abacus-type device. During a trip to the East Coast, the experimenters were to proceed to New York, where they were to purchase locally an abacus to be used as a target in a remote viewing experiment. (The abacus was to constitute a target analogous to a cipher machine of particular interest.) Following the purchase they were to contact a subject who lived there (S3) by telephone with a surprise request to come to the experimenters' hotel room later that day to participate in a remote-viewing experiment.

The above steps were carried out in preparation for the experiment. In this case the experimenters knew what the target was, an exception to the double-blind rule followed in all our other work. Therefore, while awaiting the subject's arrival, a preamble for the experiment was prerecorded by one of the experimenters (Targ) and carefully checked to ensure against verbal cueing:

Hal and I have brought a present for you. We wandered around New York this morning and we bought an object. This object is of the type that one interacts with, and Hal will use it for its normal purpose. Today is Friday, September 26, 1974. As in all our remote viewing experiments, we'd like to ask you to describe the object as you see it rather than attempting to give the object a name.

When the subject entered the hotel room, this instruction tape was played by one experimenter (R.T.) while the other experimenter (H.P.) took a large locked suitcase containing the target object into an adjacent room, locked the door, and removed the abacus, shown in Figure 5(a), actions verified earlier as being inaudible. Thus the only available cue was an upper bound on the size.

The subject produced the outline drawing I of Figure 5(b) in approximately one minute. (The large purplish-silver object corresponds

~~UNCLASSIFIED~~

UNCLASSIFIED

16

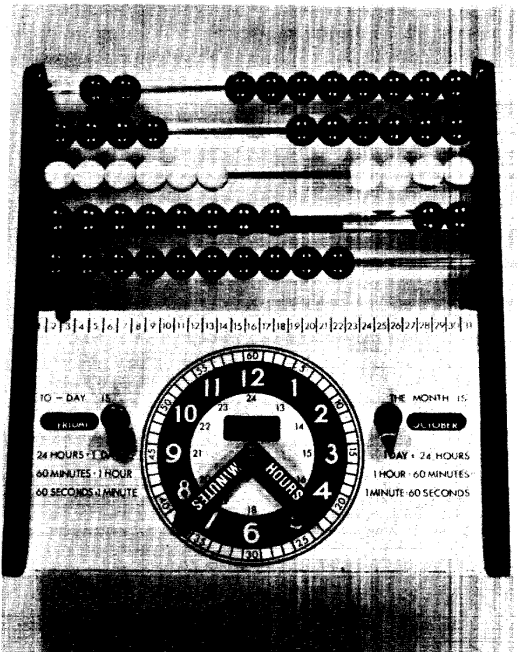

(a) ABACUS/CLOCK TARGET (TECHNOLOGY SERIES)

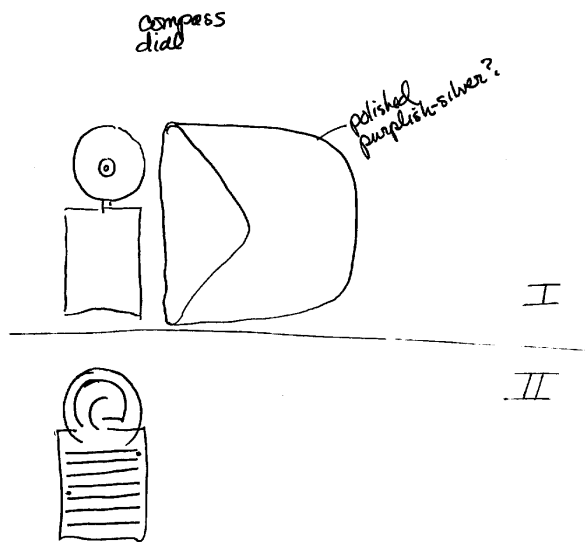

(b) SUBJECT S3 RESPONSES I AND II TO ABACUS/CLOCK TARGET He Described Target as "Game Box with Little Balls"

UNCLASSIFIED

SA-3183-1

FIGURE 5

UNCLASSIFIED

to the suitcase interior and is not taken to be evidential.) The experimenter remaining with the subject asked for more detail, and the subject produced the drawing II of Figure 5(b), describing the object as a "game box with little balls." The entire experiment was tape recorded and extreme caution was taken to prevent cueing of any kind. The experiment took place in five minutes total time.

Considering the high-strangeness factor of the target item, and essentially total lack of restriction on the possibilities as far as the subject was concerned, the correlation of subject drawings and target was taken as indicative of a potential utility for remote viewing of technological targets, and resulted in a decision to experiment further in this area.

After the target was shown to the subject, a short follow-up experiment was carried out to determine whether the position of the balls on the abacus could be determined by remote viewing, but this degree of resolution was found to be beyond the subject's capability.

5. Short-Range Remote Viewing (Technology Series)

So as to measure the resolution capability of the remote viewing phenomenon, a series of experiments targeting on remote laboratory equipment within the SRI complex was carried out.

Thirteen experiments were carried out with five different subjects, two of whom were sponsor staff personnel. A subject was told that one of the experimenters would be sent by random protocol to a laboratory within the SRI complex and that he would interact with the equipment or apparatus at the location. It was further explained that the experimenter remaining with the subject was kept ignorant of the contents of the target pool to prevent cueing during questioning. (The remaining experimenter only knew that from time to time, on a random basis, previously used targets would be reinserted into the target pool to provide an opportunity for multiple responses to a given target, and that during sponsor visits the targets might be selected by sponsor staff personnel rather than by the established random protocol procedures.) The subject was asked to describe the target both verbally (tape recorded) and by means of drawings during the time-synchronized 15-minute interval in which the outbound experimenter interacted in an appropriate manner with the equipment in the

UNCLASSIFIED

UNCLASSIFIED

target area.

In the 13 experiments eight targets were used: a drill press, computer-driven flight simulator (Link trainer), Xerox machine, video terminal, chart recorder, four-state random target generator (used in screening tests described later), typewriter, and machine shop. Three of these were used twice (drill press, video terminal, and typewriter) and one (Xerox machine) came up three times. As an example of drawings generated by subjects, all of the subject outputs generated for the latter three (video terminal, typewriter, and Xerox machine) are shown in Figures 6, 7, and 8. A summary of subject and target selection procedure is given in Table 1.

As is apparent from the illustrations alone, certain of the experiments provide circumstantial evidence for an information channel of useful bit rate. This includes experiments (Experiments 4 and 13) in which sponsor staff personnel participated as subjects to observe the protocol.

To obtain independent objective judgment of the quality of the remote viewing of technological targets, various analyses based on blind judging were employed.

In the first judging procedure, a judge was asked to blind-match the drawings alone (i.e., without tape transcripts) to the targets. Multiple subject responses to a given target were stapled together, and thus there were seven subject-drawing response packets to be matched to the seven different targets for which drawings were made. (No drawings were made for the Link trainer.) The judge did not have access to our photographs of the target locations, used for demonstration only (as in Figures 6 through 8), but rather proceeded to each of the target locations by list. While standing at each target location, the judge was required to rank order the seven subject-drawing response packets (presented in random order) on a scale one to seven (best to worst match), as shown in Table 2. The statistic of interest is the sum of ranks on the diagonal, lower values indicating better matches. For seven targets, the sum of ranks could range from seven to forty-nine. The probability that a given sum of ranks s or less will occur by chance is given by:¹

UNCLASSIFIED



TARGET: VIDEO MONITOR FOR TEXT EDITING (TECHNOLOGY SERIES)

UNCLASSIFIED

UNCLASSIFIED

19

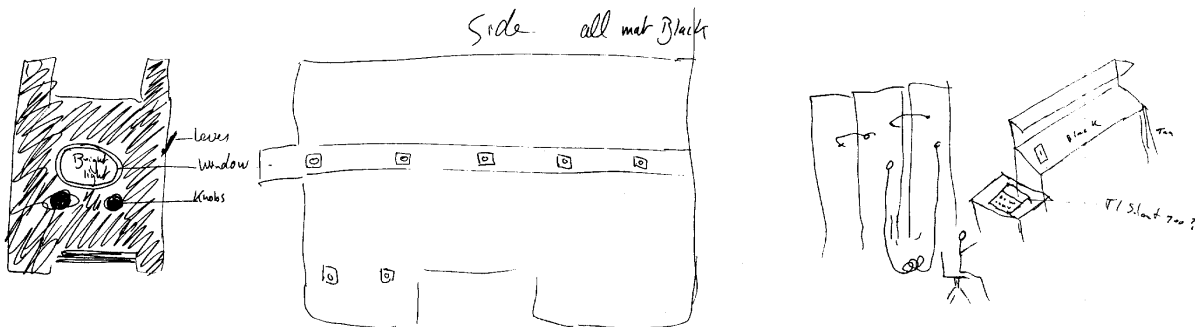

SUBJECT (S4) DRAWING OF "BOX WITH LIGHT COMING OUT OF IT . . . PAINTED FLAT BLACK AND IN THE MIDDLE OF THE ROOM"

SECOND SUBJECT (V2) SAW A COMPUTER TERMINAL WITH RELAY RACKS IN THE BACKGROUND

SA-3183-8

FIGURE 6 DRAWING BY TWO SUBJECTS OF A VIDEO MONITOR TARGET

UNCLASSIFIED

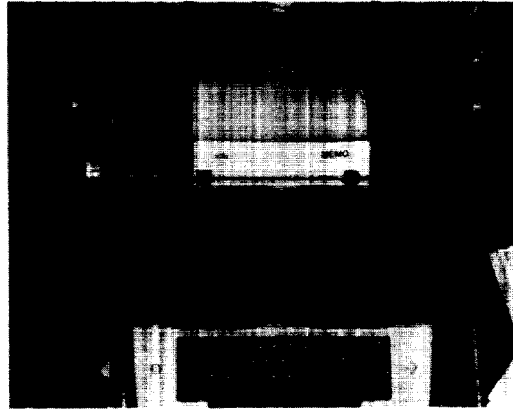
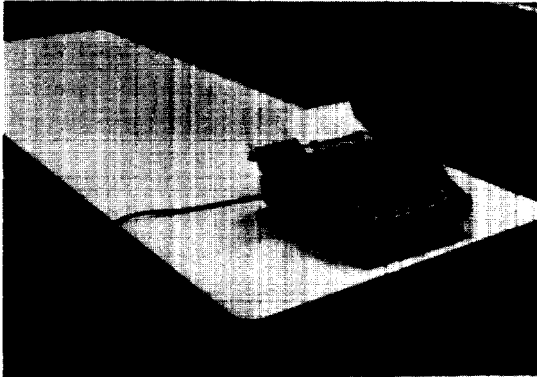

TECHNOLOGY SERIES
TYPEWRITER TARGET

Seems to resolve into 2 parts
one sitting on top of the other -
a machine in 2 parts.
white on the side.
see the floor now - bridge

11.23

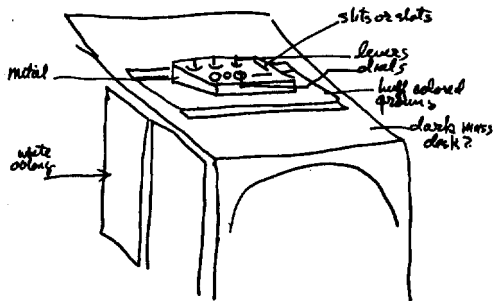

The lights need to inside
a green cocoon.

SUBJECT S3 RESPONSE

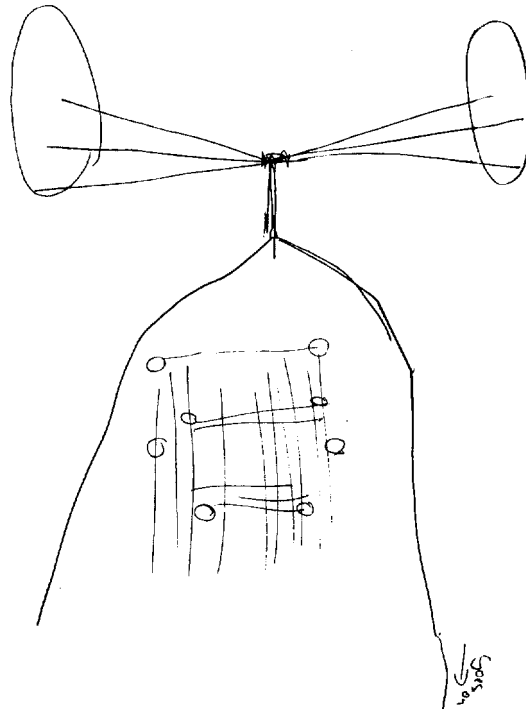

SUBJECT S4 RESPONSE

TA-760525-5

FIGURE 7 DRAWINGS OF A TYPEWRITER TARGET BY TWO SUBJECTS

UNCLASSIFIED

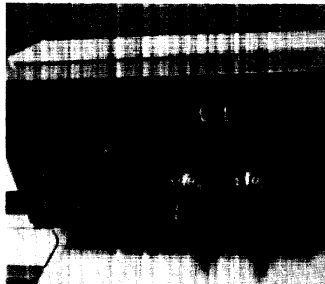
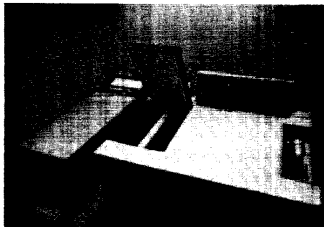

TARGET LOCATION: XEROX MACHINE
(TECHNOLOGY SERIES)

TO ADD INTEREST TO TARGET
LOCATION EXPERIMENTER WITH
HIS HEAD BEING XEROXED

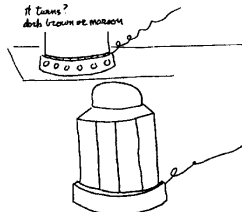

(2)

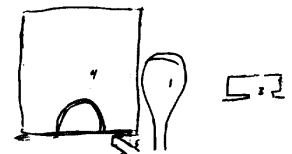

UNCLASSIFIED

21

UNCLASSIFIED

TA-760525-6

FIGURE 8 DRAWINGS BY THREE SUBJECTS (S2, S3, AND V3) FOR XEROX MACHINE TARGET

When subject (V3) was asked to describe the square at upper left, the subject said, "There was this predominant light source which might have been a window, and a working surface which might have been the sill, or a working surface or desk." Earlier the subject had said, "I have the feeling that there is something still posted against the window." Shown at right.

UNCLASSIFIED

TABLE 1
 SUBJECT AND TARGET SELECTION PROCEDURE
 FOR TECHNOLOGY SERIES

Experiment	Target	Target Selection Procedure*	Subject
1	Link trainer	a	SRI-S4
2	Video terminal	a	SRI-S4
3	Drill press	a	SRI-S4
4	Xerox machine	b	Sponsor-V1
5	Xerox machine	b	SRI-S2
6	Random number generator	c	SRI-S4
7	Machine shop	b	SRI-S4
8	Typewriter	b	SRI-S4
9	Typewriter	c	SRI-S3
10	Chart recorder	c	SRI-S3
11	Xerox machine	c	SRI-S3
12	Drill press	c	SRI-S3
13	Video terminal	c	Sponsor-V2

*Target selection procedures

- a. Outbound SRI experimenter selects target site arbitrarily after leaving subject area.
- b. Visiting sponsor staff member selects target site arbitrarily after leaving subject area.
- c. Standard protocol, in which a target is issued to outbound experimenter by division director who selects the target by random number technique from a target pool stored in a secure safe.

UNCLASSIFIED

TABLE 2

RANK ORDERING MATCH OF SUBJECT-DRAWING RESPONSE PACKETS
TO TARGET LOCATIONS (BLIND JUDGING, TECHNOLOGY SERIES)

Place Visited \ Subject Drawing Number	1	2	3	4	5	6	7
Video terminal	1	7	5	6	4	3	2
Random number generator	4	6	5	7	2	3	1
Xerox machine	6	1	2	5	7	4	3
Machine shop	5	2	1	3	4	6	7
Drill press	7	3	5	1	2	4	6
Typewriter	3	7	5	6	1	2	4
Chart recorder	4	7	5	3	6	1	2

Note on judging procedure: When standing at target locations shown on left, each of the seven subject-drawing response packets (originally labeled in random order) are rank ordered one to seven (best to worst match) by the judge. Statistic of interest is the sum of ranks on the diagonal, lower values indicating better matches (see text). The sum in this case (18) is significant at $p < 0.04$.

UNCLASSIFIED

$$\text{Prob}(s \text{ or less}) = \frac{1}{N^n} \sum_{i=n}^s \sum_{\ell=0}^k (-1)^\ell \binom{n}{\ell} \binom{i-N\ell-1}{n-1},$$

where s = obtained sum of ranks

N = number of assignable ranks

n = number of occasions on which rankings were made

ℓ takes on values from zero to the least positive integer k in (i-n)/n.

Table 3 is a table to enable easy application of the above formula to those cases in which N = n. The sum in this case (18) is significant at p < 0.04.

In the second judging procedure, another judge was given 12 subject-response packages, which included drawings and tape transcripts, and asked to blind match, without replacement, the 12 response packages to 12 target locations, which he visited. (The thirteenth location, the machine shop, included in the first judging, was left out of this judging by an oversight.) In the forced-choice matching without replacement, (that is, each response packet used only once), the judge obtained four direct hits, the Link trainer (Experiment 1), video terminal (Experiment 2), drill press (Experiment 3) and Xerox machine (Experiment 5). (The Link trainer, for which no drawings were made, was matched on the basis of tape-recorded transcript alone. It is a standard computer-controlled flight simulator that resembles the cockpit of an aircraft. It was cramped quarters for the outbound experimenter who flew the trainer according to a printed flight plan book laid over his arm. The windows were frosted and translucent. Subject S4 gave a description of the experimenter crowded into a very small space illuminated by gray diffuse light and with a long paper, such as a waiter's towel, over his arm. Although not unambiguous, the subject's description was nevertheless essentially devoid of incorrect statements.)

As indicated by Table 4, the probability of obtaining by chance four direct hits out of 12 matches is p = 0.015; thus, this judging procedure also indicates that, from a statistical standpoint, there is significant evidence of useful information transfer.

In a third judging procedure the COTR arbitrarily selected the

UNCLASSIFIED

TABLE 3

Critical Values of Sums of Ranks for Preferential Matching

Number of Assignable Ranks (N)	Probability (One-Tailed) that the Indicated Sum of Ranks or Less Would Occur by Chance													
	0.20	0.10	0.05	0.04	0.025	0.01	0.005	0.002	0.001	0.0005	10 ⁻⁴	10 ⁻⁵	10 ⁻⁶	10 ⁻⁷
4	7	6	5	5	5	4	4							
5	11	10	9	8	8	7	6	6	5	5				
6	16	15	13	13	12	11	10	9	8	7	6			
7	22	20	18	18	17	15	14	12	12	11	9	8		
8	29	27	24	24	22	20	19	17	16	15	13	11	9	8
9	37	34	31	30	29	26	24	22	21	20	17	14	12	10
10	46	42	39	38	36	33	31	29	27	25	22	19	16	13
11	56	51	48	47	45	41	38	36	34	32	28	24	20	17
12	67	61	58	56	54	49	47	43	41	39	35	30	25	22

This table applies only to those special cases in which the number of occasions on which objects are being ranked (n) is equal to the number of assignable ranks (N). Each entry represents the largest number that is significant at the indicated p-level.

Source: R. L. Morris¹

UNCLASSIFIED

UNCLASSIFIED

TABLE 4

The Probabilities of M Correct Guesses of N Distinct Items

M \ N	1	2	3	4	5	6	7	8	9	10	11	12
05000	.3333	.3750	.36667	.36806	.36786	.367882	.367879	.367879	.3678794	.3678794
1	1.0005000	.3333	.37500	.36667	.36806	.367857	.367882	.367879	.3678795	.3678794
2		.50002500	.16667	.18750	.18333	.184028	.183929	.183941	.1839396	.1839397
3			.166708333	.05556	.06250	.061111	.061343	.061310	.0613137	.0613132
4				.041702083	.01389	.015625	.015278	.015336	.0153274	.0153284
5					.0083300417	.002778	.003125	.003056	.0030671	.0030655
6						.00139000694	.000463	.000521	.0005093	.0005112
7							.00020000099	.000066	.0000744	.0000728
8								.000025000012	.0000083	.0000093
9									.0000030000014	.0000009
10										.0000000000001
11											.0000000	...
12												.0000000

Source: N. Feller²

UNCLASSIFIED

UNCLASSIFIED

SECRET

data of Experiment 3 (drill press/S4) as a test case. An analyst of the sponsor organization, blind as to the target and given only the subject's taped narrative and drawings (Figure 9), was able, from the subject's description alone, to correctly classify the target as a "man-sized vertical boring machine."

In general, it appears that use of multiple-subject responses to a single target provides better signal-to-noise ratio than target identification by a single individual. Further, our observation is that most of the correct information is of a nonanalytic nature pertaining to shape, form, color, and material rather than to function or name. That is, we often observe the correct description of basic elements and patterns coupled with incomplete or erroneous analysis of function. As a result, we have learned to urge our subjects simply to describe what they see as opposed to interpreting the perceived data. One should not infer that analytic functioning in the remote viewing mode is never observed, however, as indicated by codeword retrieval in the West Virginia Site experiment discussed in Subsection 1-B above, and by the sponsor-staff-member-generated response of Figure 6.

B. Detection of Secret Writing (SW) Target Material

To determine whether documents containing secret writing (SW) could be differentiated from other documents, SRI carried out a double-blind experiment under sponsor control. Twenty-seven numbered envelopes containing target drawings of variable content and preparation, sealed and specially secured by the sponsor, were submitted to SRI researchers for sorting. The goal was the differentiation of the 12 envelopes containing the SW drawings from the envelopes containing either pencil drawings (6) or blanks (9). This distribution was the only datum given to researchers and subject. The key, shown in Table 5, remained under sponsor control until the experiment was completed and the data were submitted to the COTR.

A series of sorting runs to detect SW material was carried out with SRI subject S1. The series consisted of 24 runs through the 27 cards, choosing 12 cards each run, the goal being to choose the 12 SW cards. Thus, each run consisted of a sort into one of two binary channels, non-SW or SW, say (0,1). The numbered envelopes containing the target

SECRET

UNCLASSIFIED

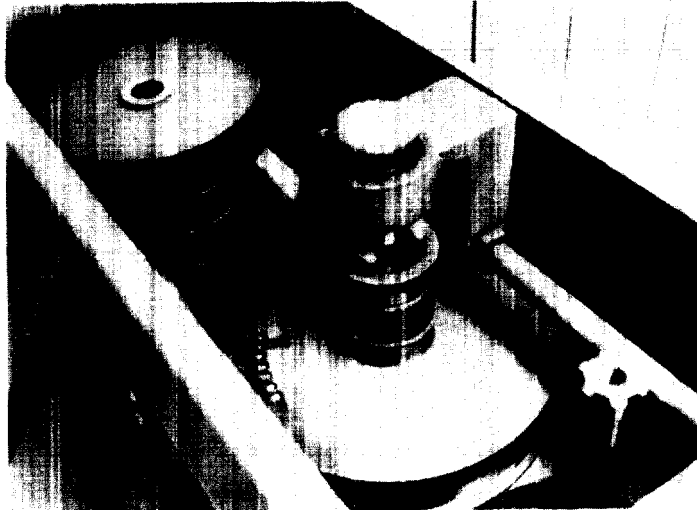
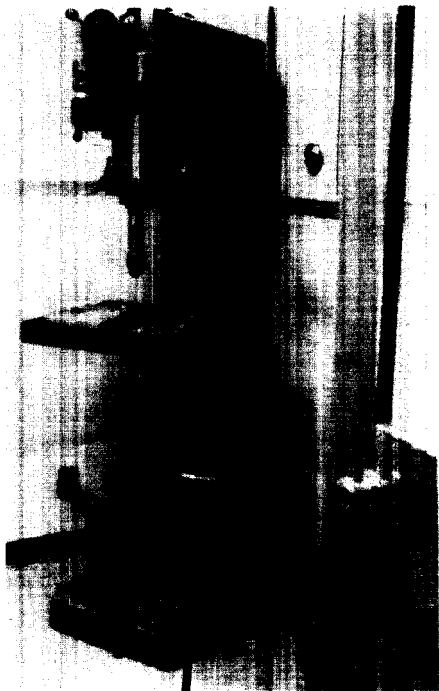

BELT DRIVE FOR DRILL PRESS (CAN BE SEEN ONLY FROM ABOVE MACHINE)

TARGET: DRILL PRESS (TECHNOLOGY SERIES)

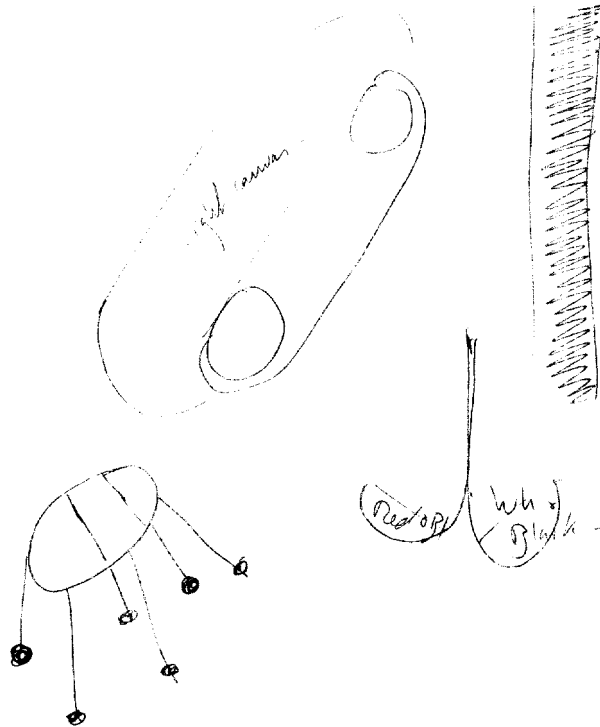

SA-3183-7

FIGURE 9 SUBJECT (S4) DRAWING OF DRILL PRESS SHOWING BELT DRIVE, STOOL AND "VERTICAL GRAPH THAT GOES UP AND DOWN"

UNCLASSIFIED

SECRET

TABLE 5

KEY FOR SECRET WRITING EXPERIMENT

(Kept blind to experimenters until experiment completion)

Card No.	Target Material	Target Content
1	Pencil	Large X
2	Pencil	Small Δ
3	Pencil	Large Δ
4	Blank	Blank
5	Blank	Blank
6	Pencil	Large 0
7	Pencil	Small x
8	Pencil	Small o
9	Blank	Blank
10	Blank	Blank
11	CD-294	Small Δ
12	CD-294	Large X
13	CD-294	Large Δ
14	CD-294	Small o
15	Blank	Blank
16	CD-294	Small x
17	Blank	Blank
18	CD-294	Large 0
19	CD-175	Large 0
20	Blank	Blank
21	CD-175	Large X
22	CD-175	Small Δ
23	Blank	Blank
24	Blank	Blank
25	CD-175	Small o
26	CD-175	Large Δ
27	CD-175	Small x

SECRET

UNCLASSIFIED

material were randomized before each run and placed inside unnumbered opaque envelopes before being presented to the subject for sorting.

The appropriate analysis technique for a binary sort (0,1) is the method known as sequential sampling.³ The sequential method gives a rule of procedure for making one of three possible decisions for each card following a given binary sort: accept 1 as the bit being carried by the card; reject 1 as the bit being carried by the card (i.e., accept 0); or continue sampling of the card under consideration. The sequential sampling procedure differs from fixed-length statistical analysis procedures in that the number of sorts required to reach a final decision on a card bit is not fixed before sampling, but depends on the results accumulated with each sampling run. The primary advantage of the sequential sampling procedure as compared with the other methods is that, on the average, fewer sorts per final decision are required for an equivalent degree of reliability.

Use of the sequential sampling procedure requires the specification of parameters that are determined on the basis of the following considerations. Assume that a labeling bit (0 or 1) is being carried by each card. From the standpoint of the sorter, the probability of correctly identifying the bit being carried is some value p_c because of chance alone. An operative sensing channel could then be expected to alter the probability of correct identification to a higher value $p = p_c + \psi$. Good psi functioning on a repetitive task is observed to result in $\psi = 0.12$, as reported by Ryzl.⁴ Therefore, let us assume a baseline psi parameter $\psi_b = 0.12$.

The question to be addressed in the case of sorting 12 SW cards from among 27 cards is whether a given card is sorted into the SW channel at a low rate p_0 commensurate with the hypothesis H_0 that the card in question is a non-SW card, or at a higher rate p_1 commensurate with the hypothesis H_1 that the card in question is indeed an SW card. The decision-making process requires the specification of four parameters:

- (1) p_0 : The probability of sorting incorrectly a non-SW (0) card into the SW (1) channel. In the sort of 12 SW cards from among 27, the probability of correctly sorting a non-SW (0) card into

UNCLASSIFIED

UNCLASSIFIED

the non-SW (0) channel is $p = p_c + \psi_b = 15/27 + 0.12 = 0.676$. Therefore, the probability of a non-SW (0) card being incorrectly sorted into the SW (1) channel is $1 - p = 0.324 = p_o$.

- (2) p_1 : The probability of sorting correctly an SW (1) card into the SW (1) channel. In the sort of 12 SW cards from among 27, the probability of correctly sorting an SW (1) card into the SW (1) channel is $p_1 = p_c + \psi_b = 12/27 + 0.12 = 0.564$.
- (3) α : The probability of rejecting a correct identification for a non-SW (0) card (designated in statistics as a Type I error). We shall take $\alpha = 0.1$.
- (4) β : The probability of accepting an incorrect identification for an SW (1) card (designated in statistics as a Type II error). We shall take $\beta = 0.1$.

(Lower values for α and β result in increased accuracy, but at the expense of requiring longer runs. Therefore, a compromise must be made between the desire to maximize reliability and to minimize redundancy.)

With the parameters thus specified, the sequential sampling procedure provides for construction of a decision graph as shown in Figure 10. A cumulative record of sorts of a given card is compiled run by run until either the upper or lower limit line is reached, at which point a decision is made to label the card as 0 (non-SW) or 1 (SW).

As indicated in Figure 10, during the 24 runs carried out, SW cards 13, 18, 21, 22, 25, 26, and 27 correctly emerged through the upper limit line to be labeled SW, along with pencil cards 1 and 2 and blank card 17, the latter three incorrectly. We note that five of the six CD-175 cards ended up correctly sorted. With regard to the lower limit line, pencil cards 3, 6, and 8, and blank cards 4, 20, and 23 correctly emerged through the lower limit line to be labeled non-SW, along with (incorrectly) SW cards 12, 16, and 19. Thus, of the 19 cards that emerged through the limit lines, 13 are correct. Although we cannot rule out the possibility of obtaining 13 correct choices out of 19 labelings by chance ($p = 0.09$ by

UNCLASSIFIED

UNCLASSIFIED

32

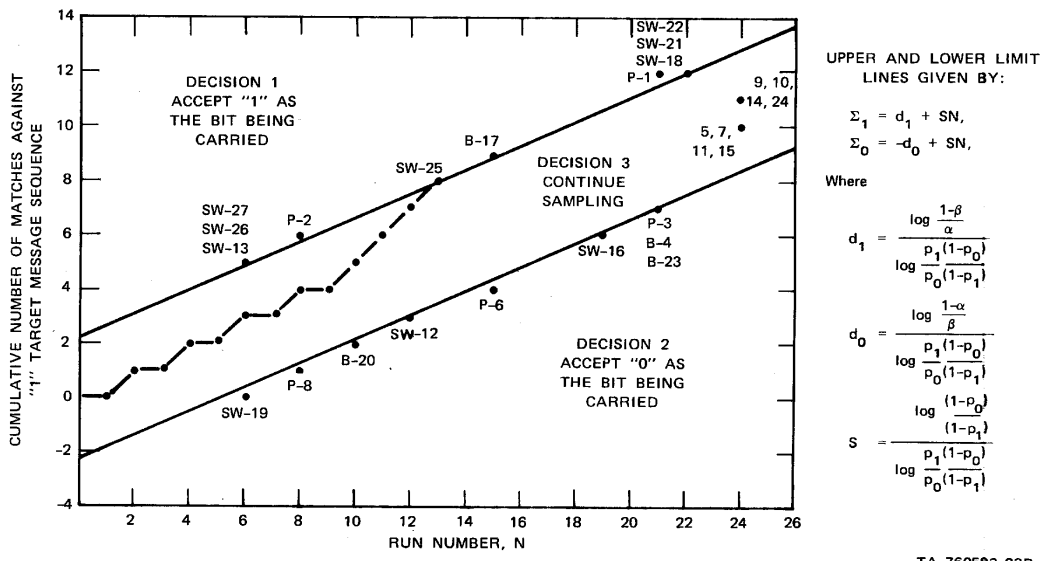

FIGURE 10 PROCEDURE FOR CARD SORTING BY SEQUENTIAL SAMPLING
 $p_0 = 0.324, p_1 = 0.564, \alpha = 0.1, \beta = 0.1$
 BROKEN LINE SHOWS SAMO SAMPLING SEQUENCE FOR CARD NO. 25

UNCLASSIFIED

UNCLASSIFIED

exact binomial calculation*), the result indicates a tendency toward correct labeling that could be explored further. With an increased number of runs, the probabilities for α and β errors can be reduced while still permitting a large percentage of labelings to be made. (For completeness we include the raw data call sheet as Table 6.)

A second shorter series of 18 sorting runs through the 27 cards to choose the six pencil cards yielded chance results.

* Recognizing that the probability of a correct choice by chance is the probability that an SW card is sorted into the SW channel, or a non-SW card is sorted into the non-SW channel, we have

$$p(\text{corr}) = \frac{12}{27} \times \frac{12}{27} + \frac{15}{27} \times \frac{15}{27} = 0.506.$$

From this the probability of at least 13 correct choices by chance out of 19 tries can be calculated from

$$p = \sum_{i=13}^{19} \frac{19!}{i!(19-i)!} (0.506)^i (0.494)^{19-i} = 0.09$$

UNCLASSIFIED

UNCLASSIFIED

TABLE 6
 RAW DATA CALL SHEET FOR SECRET WRITING EXPERIMENT
 (SELECT 12 PER RUN)

Card Chosen

P P P B B P P P B B SW SW SW SW B SW B SW SW B SW SW B B SW SW SW
 1 2 3 4 5 6 7 8 9 10 11 12 13 14 15 16 17 18 19 20 21 22 23 24 25 26 27

Run #	1	2	3	4	5	6	7	8	9	10	11	12	13	14	15	16	17	18	19	20	21	22	23	24	25	26	27			
1	x				x				x	x				x	x				x		x	x		x		x	x			
2		x						x				x	x	x	x	x	x				x		x	x	x					
3	x		x	x			x			x					x			x			x	x	x			x	x			
4	x	x			x	x			x			x	x	x			x	x							x		x			
5	x		x					x	x			x			x	x	x						x	x		x	x			
6	x	x				x					x		x	x				x		x	x				x	x	x			
7	x	x	x	x	x			x	x	x					x	x					x	x								
8	x	x				x					x		x					x	x	x	x		x		x		x			
9	x		x	x	x		x		x	x			x		x									x			x			
10				x	x				x			x	x	x			x	x	x				x		x		x			
11	x	x				x	x			x				x		x				x		x	x		x		x			
12	x	x	x	x			x	x			x					x						x				x	x			
13	x			x	x							x		x				x		x	x	x				x	x			
14	x	x					x				x	x	x	x	x			x	x				x			x				
15					x		x		x								x	x	x			x	x		x	x		x		
16	x		x	x		x				x	x							x	x			x	x	x			x			
17							x	x	x	x					x	x	x				x	x		x	x					
18	x	x			x		x							x	x						x	x	x				x	x		
19	x				x	x	x	x				x	x	x								x	x				x			
20	x										x	x	x	x	x							x				x	x	x	x	
21	x						x		x					x		x						x	x	x			x	x		
22		x									x	x											x	x			x	x		
23	x		x																									x	x	
24	x																												x	x

UNCLASSIFIED

UNCLASSIFIED

III PROGRAM RESULTS--BASIC RESEARCH EFFORT

In addition to experimentation carried out under conditions appropriate to assessing the operational utility of paranormal abilities, approximately 50 percent of the program effort was devoted to a basic research effort that included:

- (1) Identification of measurable characteristics possessed by gifted individuals,
- (2) Identification of neurophysiological correlates that relate to paranormal activities,
- (3) Identification of the nature of paranormal phenomena and energy.

A. Screening Tests

To meet the above objectives, the first prerequisite was the establishment of criteria capable of differentiating individuals apparently gifted in paranormal functioning from those who were not. This prerequisite was met by carrying out a series of screening tests under fixed protocol conditions. The tests were designed to ensure that all conventional communications channels were blocked, and that the outcomes could be sufficiently unambiguous to determine whether paranormal functioning occurred. Individuals gifted in certain areas of paranormal functioning could then be differentiated from those who were not on the basis of whether their results differed significantly from chance.

Two experimental paradigms were utilized as screening tests on the basis that these tests had been useful for such purposes prior to this program (in the sense that certain apparently gifted individuals did exceedingly well in at least one of these tests, whereas the results of unselected volunteers did not differ significantly from chance expectation). The tests were (a) the remote viewing of natural targets, and (b) the determination of the state of a four-state random target generator. The first type of test constitutes a so-called "free-response" paradigm in which the subject originates freely about contents of his awareness; furthermore, the channel in general may involve both direct perception of the remote site and perception of the mental contents of an observer at the site. In the second type of test, on the other hand, the target

UNCLASSIFIED

UNCLASSIFIED

is more abstract (an electronic state), the target is blind to all participants, and the subject's choice is precisely constrained.

For the purpose of screening, a result is considered unambiguously paranormal if the a priori probability for the occurrence of the result by chance, under the null hypothesis, is $p < 10^{-6}$. A result with $p < 10^{-2}$ is taken as strongly indicative of paranormal functioning, while a result at $p < 0.05$ is taken as circumstantial evidence for paranormal functioning but requiring further exploration before assessment can be considered secure.

Six subjects were chosen for the study, subjects S1 through S3 considered gifted or experienced, subjects S4 through S6 acting as learners/controls. The dichotomy between gifted and learners/controls was based on the former group having been successful in other studies prior to this program either at SRI or elsewhere; the latter group being naive with regard to paranormal experimentation.

An effort at parity between the two groups was a factor in subject selection. Subject S5 (learner/control), a male, age 54, is matched by age and sex with experienced subject S1, a male, age 55. Learner/control subject S6, a female, age 34, is by age and background matched with experienced subject S2, a male, age 31 (both are research analysts at SRI). Learner/control S4 (female, age 53) and experienced subject S3 (male, age 41) are matched on the basis of similar artistic interests, backgrounds, and occupations (professional photographer and painter, respectively).

1. Remote Viewing of Natural Targets Under a Uniform Standard Protocol

Observations described earlier in this report (Section II-A) suggested the hypothesis that it may be possible for a subject to access and describe, by means of mental imagery, randomly chosen geographical sites located several miles from the subject's position and demarcated by some appropriate means. An experimental series was therefore set up to test this hypothesis under rigorously controlled scientific conditions. The experiment consisted of a series of double-blind tests with local targets in the San Francisco Bay Area so that several independent judges

UNCLASSIFIED

UNCLASSIFIED

could visit the sites to establish documentation. The protocol was to closet the subject with an experimenter at SRI and at an agreed-on time to obtain from the subject a description of an undisclosed, remote site being visited by a target team. In each of the experiments one of the six program subjects served as remote-viewing subject, and SRI experimenters served as a target demarcation team at the remote location chosen in a double-blind protocol as follows.

In each experiment a target location within 30-minute driving time from SRI was randomly chosen by SRI management from a list of targets kept blind to subject and experimenters and used without replacement. (A set of target locations clearly differentiated from each other had been chosen from a target-rich environment of more than 100 targets of the type used in the experimental series. Before the experimental series began, the Director of the Information Science and Engineering Division, not otherwise associated with the experiment, established the set of locations as the target pool. The target locations were printed on cards sealed and kept in the SRI Division office safe. They were available only with the personal assistance of the Division Director who issued a single randomly selected target card that constituted the traveling orders for that experiment.)

In detail, to begin the experiment, the subject was closeted with an experimenter at SRI to wait 30 minutes before beginning a narrative description of the remote location. A second experimenter then obtained from the Division Director a target location from a set of traveling orders previously prepared and randomized by the Director and kept under his control. The target demarcation team, consisting of two to four SRI experimenters and, occasionally, sponsor staff personnel, then proceeded by automobile directly to the target without any communication with the subject or experimenter remaining behind. The experimenter remaining with the subject at SRI was in ignorance of both the particular target and the target pool so as to eliminate the possibility of subliminal cueing and to allow him freedom in questioning the subject to clarify his descriptions. The demarcation team remained at the target site for an agreed-on 15-

UNCLASSIFIED

minute period following the 30 minutes allotted for travel.* During the observation period, the remote-viewing subject was asked to describe his impressions of the target site into a tape recorder and to make any drawings he thought appropriate. An informal comparison was then made when the demarcation team returned, and the subject was taken to the site to provide feedback.

a. Subject S1 (Experienced)

To begin the series, experienced subject S1 participated as a subject in nine experiments. In general, S1's ability to describe correctly buildings, docks, roads, gardens, and the like, including structural materials, color, ambience, and activity--sometimes in great detail--indicated the functioning of a remote perceptual ability. Nonetheless, the descriptions contained inaccuracies as well as correct statements. A typical example is indicated by the subject's drawing in Figure 11 of one of the targets in which he correctly described a park-like area containing two pools of water: one rectangular, 60 x 89 ft (actual dimensions 75 x 100 ft); the other circular, diameter 120 ft (actual diameter 110 ft). He incorrectly indicated the function, however, as water filtration rather than recreational swimming. As discussed earlier in connection with the technology series, we often observe essentially correct descriptions of basic elements and patterns coupled with incomplete or erroneous analysis of function. As can be seen from his drawing, he also included some elements, such as the tanks shown in the upper right, that are not present at the target site. We also note an apparent left-right reversal, often observed in paranormal perception experiments.

To obtain a numerical evaluation of the accuracy of the remote-viewing experiment, the experimental results were subjected to independent judging on a blind basis by an SRI research analyst not

* The first subject (S1) was allowed 30 minutes for his descriptions, but it was found that he fatigued and had little comment after the first 15 minutes. The viewing time was therefore reduced to 15 minutes for subjects S2 through S6.

UNCLASSIFIED

39

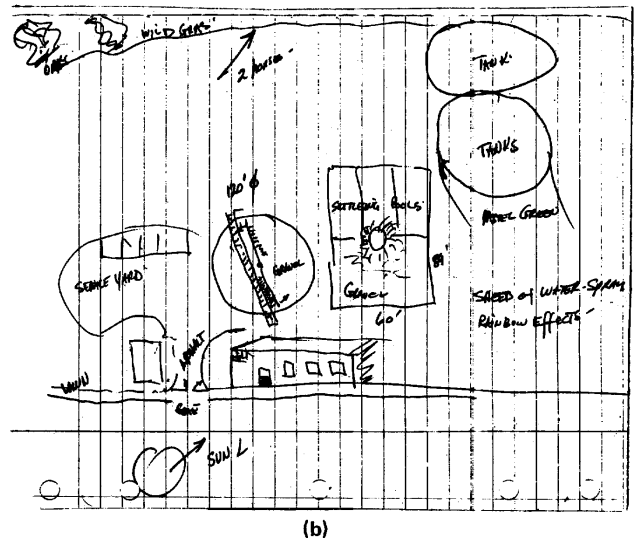
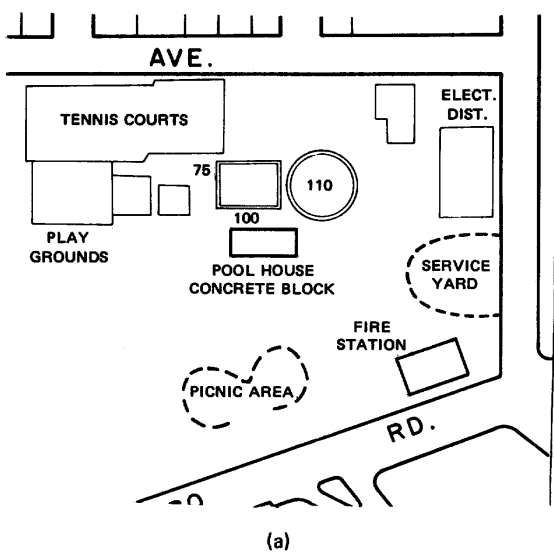

UNCLASSIFIED

FIGURE 11 SWIMMING POOL COMPLEX AS REMOTE VIEWING TARGET
(a) City map of target location, (b) Drawing by S1.

TA-760525-1

UNCLASSIFIED

otherwise associated with the research. The subject's response packets, which contained the typed transcripts of the nine tape-recorded narratives along with any associated drawings, were unlabeled and presented in random order. While standing at each target location, visited in turn, the judge was required to blind rank order the nine packets on a scale of one to nine (best to worst match); the results are shown in Table 7. As mentioned in Section II-A-5, where this procedure was used in the judging of the technology series, the statistic of interest is the sum of ranks assigned to the target-associated transcripts, lower values indicating better matches. For nine targets the sum of ranks could range from nine to eighty-one. The actual sum of this case, which included seven direct hits, was 16, a result significant at $p = 2.9 \times 10^{-5}$ by exact calculation.

In experiments 3, 4, and 6 through 9, the subject was secured in a double-walled, copper-screen Faraday cage. The Faraday cage provides 120 dB attenuation for plane wave radio frequency radiation over a range of 15 kHz to 1 GHz. For magnetic fields the attenuation is 68 dB at 15 kHz and decreases to 3 dB at 60 Hz. The results of rank order judging (Table 7) indicates that the use of Faraday cage electrical shielding does not prevent high quality descriptions from being obtained.

As a backup judging procedure, a panel of five additional SRI scientists not otherwise associated with the research were asked simply to blind match the unedited typed transcripts (with associated drawings) generated by the remote viewer, against the nine target locations which they independently visited in turn. The transcripts were, of course, unlabeled and presented in random order. A correct match consisted of a transcript of a given date being matched to the target of that date. Instead of the expected number of one match each per judge, the number of correct matches obtained by the five judges was 7, 6, 5, 3, and 3, respectively. Thus, rather than the expected number of five correct matches from the judges, 24 such matches were obtained.

b. Subject S4 (Learner/Control)

Following the first series of nine experiments with experienced subject S1, a nine-target replication series was carried out with learner/control subject S4 who had no previous experience in paranormal functioning.

UNCLASSIFIED

UNCLASSIFIED

TABLE 7

Distribution of Rankings Assigned to Transcripts Associated
With Each Target Location for Experienced Subject (S1)

Target Location	Distance (km)	Rank of Associated Transcript
Hoover Tower, Stanford	3.4	1
Baylands Nature Preserve, Palo Alto	6.4	1
Radio Telescope, Portola Valley	6.4	1
Marina, Redwood City	6.8	1
Bridge Toll Plaza, Fremont	14.5	6
Drive-in Theatre, Palo Alto	5.1	1
Arts and Crafts Plaza, Menlo Park	1.9	1
Catholic Church, Portola Valley	8.5	3
Swimming Pool Complex, Palo Alto	3.4	1
Total sum of ranks		16 ($p=2.9 \times 10^{-5}$)

UNCLASSIFIED

UNCLASSIFIED

Because of this subject's artistic background, she was capable of drawing and describing visual images that she could not identify in any cognitive or analytic sense, an asset in remote viewing. (Subjects are encouraged to make drawings of anything they visualize and associate with the remote location, since drawings made by subjects are in general more accurate than the subject's verbal description.) When the target demarcation team went to a target location which was a pedestrian overpass, for example, the subject said that she saw "a kind of trough up in the air," which she indicated in the upper part of her drawing in Figure 12. She went on to explain that "If you stand where they are standing you will see something like this," indicating the nested squares at the bottom of Figure 12. As it turned out, a judge standing where she indicated would have a view closely resembling what she had drawn, as can be seen from the accompanying photographs of the target location.

In another experiment, the subject described seeing "an open barn-like structure with a pitched roof." She also saw a "kind of slatted side to the structure making light and dark bars on the wall." Her drawing and a photograph of the associated bicycle shed target are shown in Figure 13.

For the entire series of nine, the numerical evaluation based on blind rank ordering of transcripts at each site was significant at $p = 1.8 \times 10^{-6}$, and included five direct hits and four second ranks for the target-associated transcripts (see Table 8).

Again, as a backup judging procedure, a panel of five additional SRI scientists not otherwise associated with the research were asked simply to blind match the unedited typed transcripts, with associated drawings, generated by the remote viewer, against the nine target locations which they independently visited in turn. A correct match consisted of a transcript of a given date being matched to the target of that date. Instead of the expected number of one match each per judge, the number of correct matches obtained by the five judges was 5, 3, 3, 2, and 2, respectively. Thus, rather than the expected number of five correct matches from the judges, 15 such matches were obtained.

UNCLASSIFIED

UNCLASSIFIED

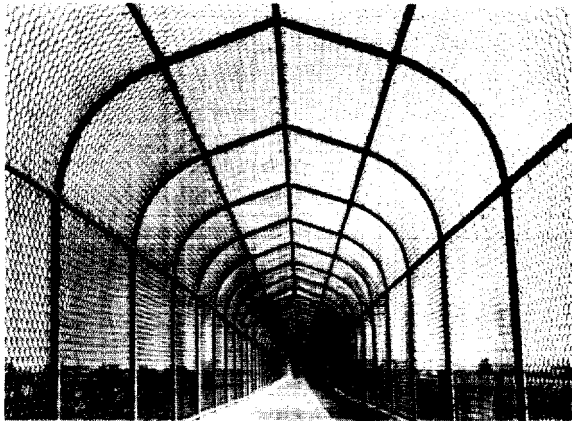

PEDESTRIAN OVERPASS TARGET

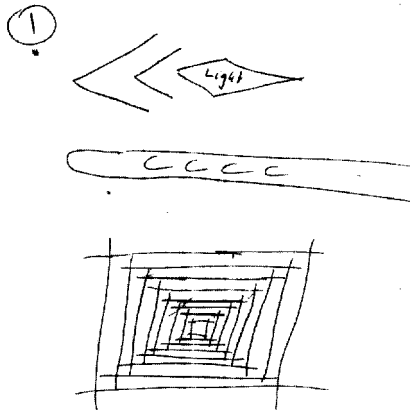

SA-3183-5

FIGURE 12 SUBJECT S4 DRAWING, DESCRIBED AS "SOME KIND OF DIAGONAL TROUGH UP IN THE AIR"

UNCLASSIFIED

UNCLASSIFIED

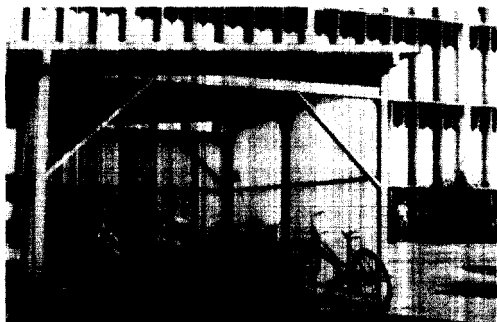

BICYCLE SHED TARGET

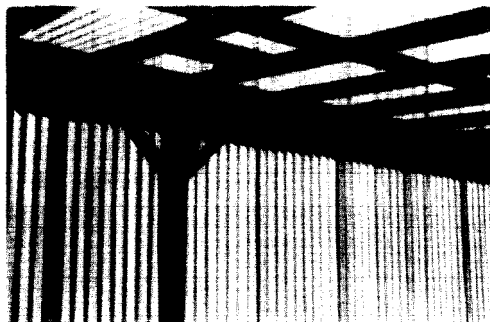

DETAIL OF BICYCLE SHED



SA-3183-19

FIGURE 13 SUBJECT S4 RESPONSE TO BICYCLE SHED TARGET DESCRIBED AS AN OPEN "BARN-LIKE BUILDING" WITH "SLATS ON THE SIDES" AND A "PITCHED ROOF"

UNCLASSIFIED

TABLE 8

Distribution of Rankings Assigned to Transcripts Associated
With Each Target Location for Learner Subject (S4)

Target Location	Distance (km)	Rank of Associated Transcript
Methodist Church, Palo Alto	1.9	1
Ness Auditorium, Menlo Park	0.2	1
Merry-Go-Round, Palo Alto	3.4	1
Parking Garage, Mountain View	8.1	2
SRI International Courtyard, Menlo Park	0.2	1
Bicycle Shed, Menlo Park	0.1	2
Railroad Trestle Bridge, Palo Alto	1.3	2
Pumpkin Patch, Menlo Park	1.3	1
Pedestrian Overpass, Palo Alto	5.0	2
Total sum of ranks		13 ($p=1.8 \times 10^{-6}$)

UNCLASSIFIEDc. Subjects S2 and S3 (Experienced)

Having completed a series of 18 remote-viewing experiments, nine each with experienced subject S1 and learner/control subject S4, it was apparent that the projected completion of an additional series of nine each for experienced subjects S2 and S3 and learner/control subjects S5 and S6 was beyond the limits imposed by funding and time available. Therefore, on a best-effort basis, it was decided to complete four each with the remaining subjects. To place the judging on a basis comparable to that employed with S1 and S4, the four transcripts each of experienced subjects S2 and S3 were combined into a group of eight for rank order judging, to be compared with the similarly combined results of the learner/control subjects S5 and S6.

The series with experienced subjects S2 and S3 provided a further example of the dichotomy between verbal and drawing responses during an experiment in which two sponsor staff personnel (the COTR and an associate) participated as members of the target demarcation team, the COTR choosing the target. The target, a tennis court, is shown in Figure 14, along with the drawings generated by the subject (S2). In discussing the drawings, the subject indicated that he was uncertain as to the action, but had the impression that the demarcation team was located at a museum in a particular park. In fact, the tennis court was located in that park about 100 yards from the indicated museum. Once again we note the characteristic (discussed earlier) of a resemblance between the target site and certain gestalt elements of the subject's response, especially as regards the drawings, coupled with incomplete or erroneous analysis of the significances. When rank ordering transcripts one through eight at the site, this transcript was ranked second.

A second example from this group, however, indicates the level of precision that can be attained. The target location chosen by the standard double-blind protocol was the Palo Alto City Hall. Subject S3 described a tall building with vertical columns and "set in" windows. (His sketch, together with the photograph of the site is shown in Figure 15.) He said there was a fountain, "but I don't hear it." At the time the target team was at the City Hall during the experiment, the fountain was not running. He also made an effort to draw a replica of the designs

UNCLASSIFIED



TARGET—TENNIS COURTS

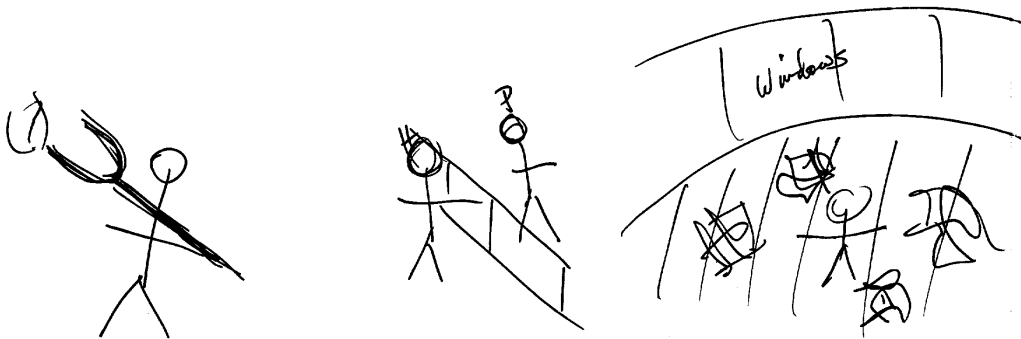

SA-3183-18

FIGURE 14 SUBJECT S2 DRAWINGS IN RESPONSE TO TENNIS COURT TARGET

UNCLASSIFIED

47

UNCLASSIFIED

UNCLASSIFIED

48

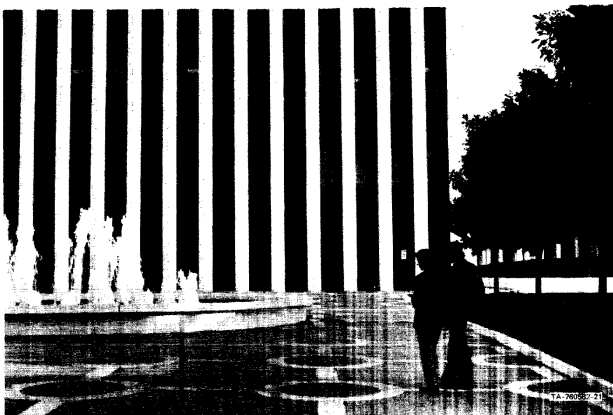

TARGET—PALO ALTO CITY HALL

Picture of the miniature golf course from yesterday?

fledgling green-jobs - wind trees?

a corridor of some sort - a walk behind the trees building.

lawns - an open field.

an enclosed area of some sort - a quad.

a fountain - but I don't know it.

buildings to the left cross walks - basket ball court - open field.

Saturday 13 Nov 74. 1040 am.

long building

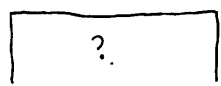
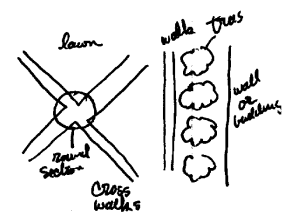

UNCLASSIFIED

SA-3183-14

FIGURE 15 SUBJECT S3 RESPONSE TO CITY HALL TARGET

in the pavement in front of the building, and correctly indicated the number of trees (four) in the sketch.

For the entire series of eight, four each from S2 and S3, the numerical evaluation based on blind-rank ordering of transcripts at each site was significant at $p = 3.8 \times 10^{-4}$, and included three direct hits and three second ranks for the target-associated transcripts (see Table 9).

d. Subjects S5 and S6 (Learner/Control)

To complete the series, four experiments each were carried out with learner/control subjects S5 and S6.

The results in this case, taken as a group, did not differ significantly from chance. For the series of eight (judged as a group of seven since one target came up twice, once for each subject) the numerical evaluation based on blind-rank ordering of transcripts at each site was nonsignificant at $p = 0.08$, even though there were two direct hits and two second ranks out of the seven (see Table 10).

One of the direct hits, which occurred with subject S6 on her first experiment, is an example of the "first-time effect" that has been rigorously explored and is well-known to experimenters in the field.⁵ In the narrative, the subject began to describe a large square with a fountain. Two minutes into the experiment she recognized the location and correctly identified it by name (see Figure 16). It should be noted that in the area from which the target locations were drawn there are several other fountains, some of which were in the target pool as well. As an example of the style of the narratives generated during remote viewing experiments with a naive subject, and the part played by the experimenter remaining with the subject in such a case, we have included the entire unedited text of this experiment as Appendix A.

e. Sponsor Subjects (Learner/Control)

Two sponsor staff personnel participated as subjects in five experiments so as to experience the protocols from the subjects' viewpoint. In this role they provide an additional calibration for this part of the program with regard to:

UNCLASSIFIED

TABLE 9

Distribution of Rankings Assigned to Transcripts Associated With Each Target Location for Experienced Subjects (S2) and (S3)

Subject	Target Location	Distance (km)	Rank of Associated Transcript
S2	BART Station (Transit System), Fremont	16.1	1
S2	Shielded Room, SRI, Menlo Park	0.1	2
S2	Tennis Court, Palo Alto	3.4	2
S2	Golf Course Bridge, Stanford	3.4	2
S3	City Hall, Palo Alto	2.0	1
S3	Miniature Golf Course, Menlo Park	3.0	1
S3	Kiosk in Park, Menlo Park	0.3	3
S3	Baylands Nature Preserve, Palo Alto	6.4	3
Total sum of ranks			15 ($p=3.8 \times 10^{-4}$)

UNCLASSIFIED

UNCLASSIFIED

TABLE 10

Distribution of Rankings Assigned to Transcripts Associated
With Each Target Location for Learner Subjects S5 and S6

Subject	Target Location	Distance (km)	Rank of Associated Transcript
S5	Pedestrian Overpass, Palo Alto	5.0	3
S5	Railroad Trestle Bridge, Palo Alto	1.3	6
S5	Windmill, Portola Valley	8.5	2
S5,S6	White Plaza, Stanford (2)	3.8	1
S6	Airport, Palo Alto	5.5	2
S6	Kiosk in Park, Menlo Park	0.3	5
S6	Boathouse, Stanford	4.0	1
Total sum of ranks			20
			(p=0.08, NS)

UNCLASSIFIED

UNCLASSIFIED



WHITE PLAZA AT STANFORD UNIVERSITY

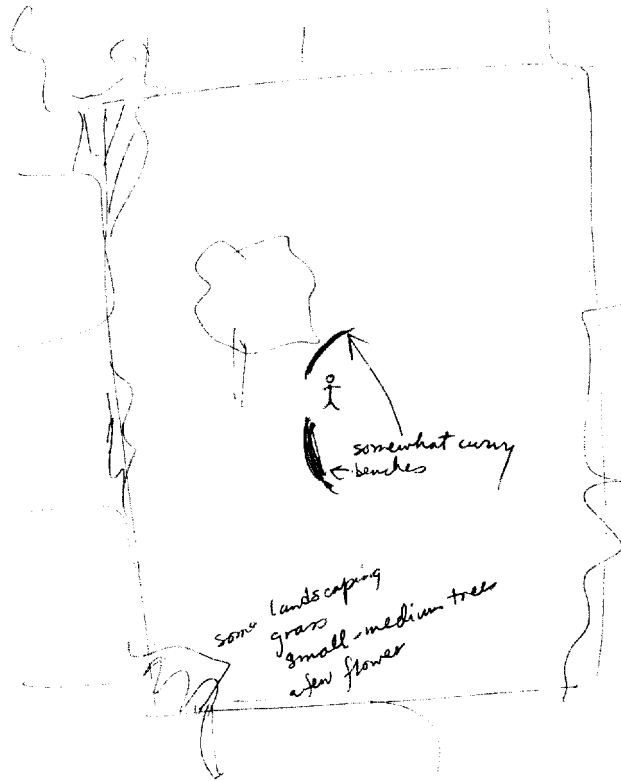

**SUBJECT DREW WHAT SHE CALLED
"CURVY BENCHES" AND THEN
ANNOUNCED CORRECTLY THAT THE
PLACE WAS "WHITE PLAZA AT STANFORD"**

SA-3183-4

FIGURE 16 SUBJECT S6 DRAWING OF WHITE PLAZA, STANFORD UNIVERSITY

UNCLASSIFIED

UNCLASSIFIED

- (a) Indicating the level of proficiency that can be expected from unselected volunteers, and,
- (b) Providing sponsor personnel with firsthand experience against which the results contained in the report can be evaluated.

The first sponsor staff member (V3) participated as a subject in a three-experiment series. All three experiments contained elements descriptive of the associated target locations, the quality of response increasing with practice. The third response is shown in Figure 17, where again, as in the results reported previously, the pattern elements in the drawing appeared to be a closer match than the subject's interpretation of the target object as a cupola.

The second sponsor staff member participated as a subject in two experiments. In his first experiment he generated one of the higher signal-to-noise results we have observed. He began his narrative "There is a red A-frame building and next to it is a large yellow thing (a tree --editor). Now further left there is another A-shape. It looks like a swing-set, but it is pushed down in a gully so I can't see the swings." (All correct--see Figure 18.) He then went on to describe a lock on the front door that he said "looks like it's made of laminated steel, so it must be a Master lock." (Also correct.)

For the series of five, three from the first subject, two from the second, the numerical evaluation based on blind rank ordering of the transcripts at each site was significant at $p = 0.017$, and included three direct hits and one second rank for the target-associated transcripts (see Table 11).

f. Summary of Remote-Viewing Experiments (Standard Protocol)

The descriptions supplied by the subjects in the experiments involving remote viewing of natural targets, although containing inaccuracies, were sufficiently accurate to permit the judges to differentiate among various targets to the degree indicated. A summary tabulation of the statistical evaluations of these experiments, carried out under standard protocol, is presented in Table 12. The overall result, evaluated conservatively on the basis of a judging procedure that ignores

UNCLASSIFIED

UNCLASSIFIED

54

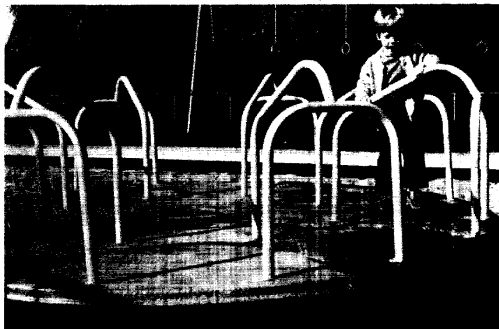

MERRY-GO-ROUND TARGET

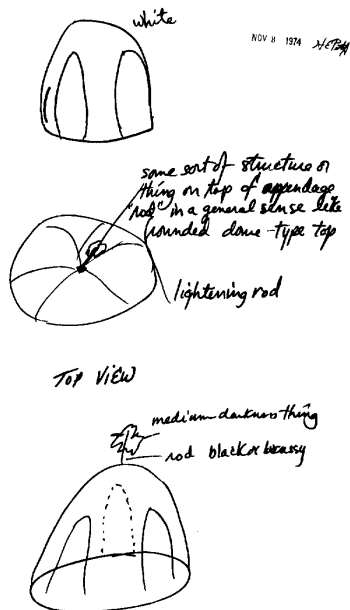

RESPONSES OF VISITING SPONSOR SUBJECT V3

UNCLASSIFIED

FIGURE 17 SUBJECT V3 DRAWING OF MERRY-GO-ROUND TARGET

SA-3183-17

UNCLASSIFIED

Approved For Release 2003/06/24 : CIA-RDP79-00999A000300100034-4

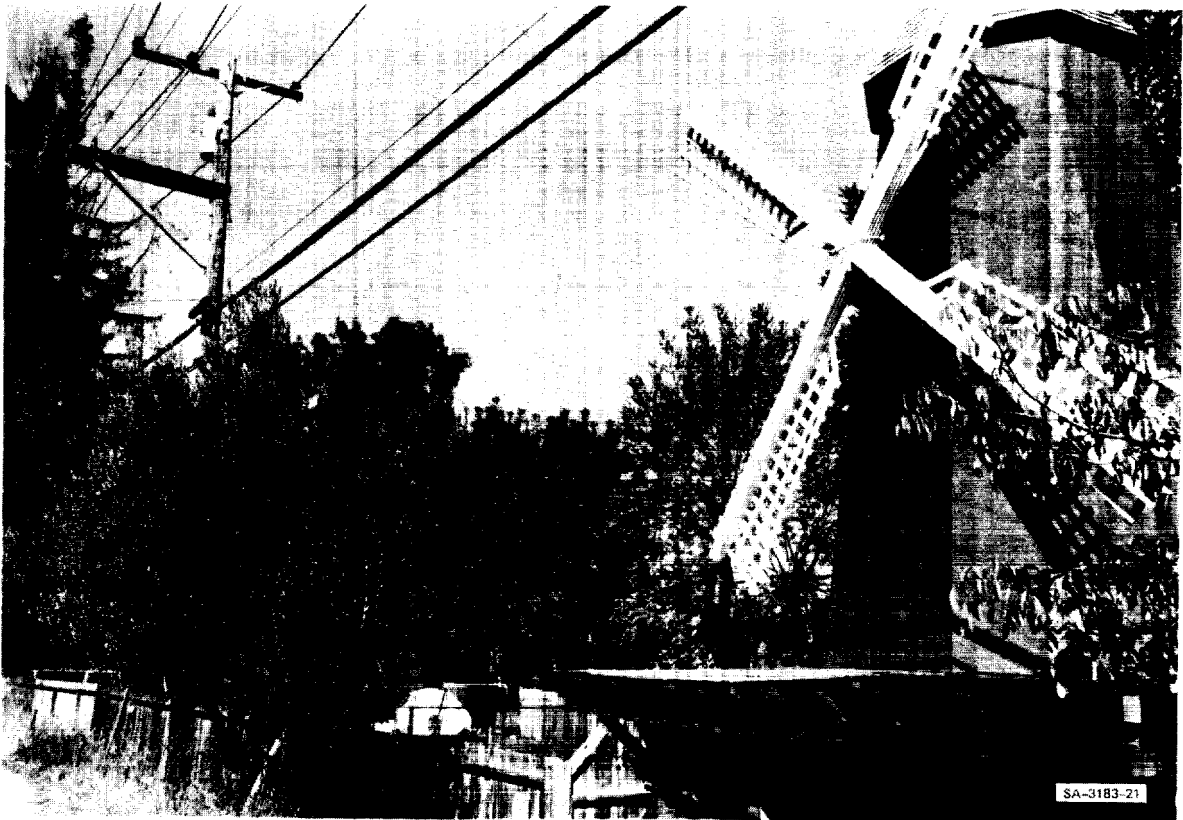

WINDMILL TARGET. SPONSOR SUBJECT V2 CORRECTLY DESCRIBED "RED A-FRAME BUILDING WITH DECK, YELLOW TREE, A-FRAME SWING SET, AND GRAY TRANSFORMER," ALL SHOWN IN PICTURE. HE ALSO DESCRIBED "MASTER TYPE LOCK OF LAMINATED STEEL" WHICH IS ON FRONT DOOR OF WINDMILL (NOT SHOWN).

FIGURE 18

UNCLASSIFIED

Approved For Release 2003/06/24 : CIA-RDP79-00999A000300100034-4

UNCLASSIFIED

TABLE 11

Distribution of Rankings Assigned to Transcripts Associated
 With Each Target Location for Visiting Sponsor Subjects V3 and V2

Subject	Target Location	Distance (km)	Rank of Associated Transcript
V3	Bridge Over Stream, Menlo Park	0.3	1
V3	Baylands Nature Preserve, Palo Alto	6.4	2
V3	Merry-Go-Round, Palo Alto	3.4	1
V2	Windmill, Portola Valley	8.5	1
V2	Apartment Swimming Pool, Mountain View	9.1	3
Total sum of ranks			8 (p=0.017)

UNCLASSIFIED

UNCLASSIFIED

TABLE 12

Summary--Remote Viewing of Natural Targets

Experienced Subjects		
Subject	No. Experiments	p-value, rank order judging
S1	9	$p = 2.9 \times 10^{-5}$
S2	4 } 8	$p = 3.8 \times 10^{-4}$
S3	4 }	

Learner/Control Subjects		
Subject	No. Experiments	p-value, rank order judging
S4	9	$p = 1.8 \times 10^{-6}$
S5	4 } 8	$p = 0.08$ (NS)
S6	4 }	

Sponsor Subjects		
Subject	No. Experiments	p-value, rank order judging
V3	3 } 5	$p = 0.017$
V2	2 }	

UNCLASSIFIED

UNCLASSIFIED

transcript quality beyond that necessary to rank order the narratives (vastly underestimating the statistical significance of individual descriptions), clearly indicates the presence of an information channel of useful bit rate. Furthermore, it appears that the primary difference between experienced subjects and naive volunteers is not that the latter never exhibit the faculty, but rather that their results are simply less reliable, more sporadic. Nonetheless, as described earlier, individual transcripts from the latter group of subjects number among some of the best obtained. Such observations indicate a hypothesis that remote viewing may be a latent and widely-distributed perceptual ability.

The following is quoted from a report on an analysis of patterns observed in the remote viewing transcripts. This report was submitted to the researchers by the judge responsible for the independent blind rank-order judging, an individual not otherwise associated with the research.

These observations are based on a survey of the remote viewing transcripts from the SRI experiments. In the process of judging --attempting to match transcripts against targets on the basis of the information in the transcripts--some patterns and regularities in the transcript descriptions became evident, particularly regarding individual styles in remote viewing, and in the perceptual form of the descriptions given by the subjects.

Styles of Response. The transcripts were taken from several different subjects. Comparing the transcripts of one subject with those of another revealed that each person tended to focus on certain aspects of the remote target complex and exclude others, so that each had an individual pattern of response, like a signature.

Subject S3, for example, frequently responded with topographical descriptions, maps, and architectural features of the target locations. Subject S2 often focused on the behavior of the remote experimenter or the sequence of actions he carried out at the target. The transcripts of subject S4, more than those of other subjects, had descriptions of the feel of the location, and experiential or sensory gestalts, e.g., light/dark elements in the scene; indoor/outdoor and enclosed/open distinctions. Prominent features of S1's transcripts were detailed descriptions of what the target persons were concretely experiencing, seeing, or doing, e.g., standing on asphaltly blacktop overlooking water; looking at a purple iris.

The range of any individual subject's responses was wide, and anyone might draw a map, or describe the mood of the remote

UNCLASSIFIED

UNCLASSIFIED

experimenter, but the consistency of each subject's overall approach suggests that just as individual descriptions of a directly viewed scene would differ, so these differences also occur in remote viewing processes.

Nature of the descriptions. The concrete descriptions that appear most commonly in transcripts are at the level of sub-units of the overall scene. For example, when the target was a Xerox copy machine, the responses included (S2) a rolling object (the moving light), ordials and a cover that is lifted (S3), but the machine as a whole was not identified by name or function.

In a few transcripts the subjects correctly identified and named the target. In the case of a computer terminal, the subject (V2) apparently mentally saw the terminal and the relay racks behind it. In the case of targets which were Hoover Tower and White Plaza, the subjects (S1 and S6, respectively) seemed to identify the locations through analysis of their initial images of the elements of the target.

There were also occasional incorrect recognitions; gestalts that were incorrectly named, e.g., swimming pools in a park being identified as water storage tanks at a water filtration plant (S1).

Phenomenological descriptions, e.g., "motion past the experimenter," and "red outlining blue," occurred occasionally, but were not frequent in the transcripts.

The most common perceptual level was thus an intermediate one--the individual elements and items that comprise the target. This is suggestive of a scanning process that takes sample perceptions from within the overall environment.

When the subjects tried to make sense out of these fragmentary impressions, they often resorted to metaphors or constructed an image with a kind of perceptual inference. From a feeling of the target as an "august" and "solemn" building, the subject (S4) said it might be a library. It was a church. A pedestrian overpass above a freeway was described as a conduit (S4). A rapid transit station, elevated above the countryside, was associated with an observatory (S2). When the remote experimenter climbed into a Link trainer, the subject said it was a small place, like a bathroom; perhaps he had locked himself in a closet. These responses seem to be the result of attempts to process partial information and occur similarly in other parapsychological experiments.

When the subjects augmented the verbal transcripts with drawings or sketches, these often expressed the target elements more accurately than the verbal descriptions, and sometimes corresponded with the targets more clearly and precisely than the words of the transcript.

UNCLASSIFIED

UNCLASSIFIED

The descriptions given by the subjects sometimes went beyond what the remote experimenter experienced, at least consciously. For example, one subject (S4) described and drew a belt drive at the top of a drill press, which was not even visible to the remote experimenter who was operating the machine.

Curiously, objects in motion at the remote site were rarely mentioned in the transcript, e.g., trains crossing the railroad trestle target were not described (S4), though the remote experimenter stood very close to them.

Also, in a few cases, the subject descriptions were inaccurate regarding size of structures. A 20 foot courtyard separating two buildings was described (S1) as 200 feet wide, and a small shed was expanded to a barn-like structure (S4).

Blind judging of transcripts. The judging procedure involved examining the transcripts for a given experimental series and attempting to match the transcripts with the correct targets on the basis of their correspondences. The transcripts varied from coherent and accurate descriptions to mixtures of correspondences and non-correspondences. Since a judge did not know a priori which elements of the descriptions were correct and incorrect, the task was complicated, and transcripts often seemed plausibly to match more than one target. A confounding factor in these studies is that many target locations have similarities that seem alike at some level of perception. For example, a radio telescope at the top of a hill, the observation deck of a tower, and a jetty on the edge of a bay all match a transcript description of "looking out over a long distance." A lake, a fountain, and a creek may all result in an image of water for the subject.

In my own judging, the procedure that was most successful was a careful element by element comparison, testing each transcript against every target, using the transcript descriptions and drawings as arguments for or against assigning the transcript to a particular target. In most cases this resulted in either a clear conclusion or at least a ranking of probably matches, and these matches were subjected to statistical analyses.

A subjective viewpoint of the remote viewing process as stated in a report to the researchers by subject S3 likens the difficulties in remote viewing to those occurring in subliminal (low level) or tachistoscopic (high speed) viewing by ordinary sensory modalities. The following is quoted from his report.

Current Status. Experimentation in viewing of remote targets conducted at SRI has provided data confirming the existence of a paranormal remote viewing ability. Several breakthroughs were needed to uncover the remote viewing possibilities. These have accumulated and are reflected in previous clients' reports. If breakthroughs have tended to expose such ability, subsequent

UNCLASSIFIED

quantitative analysis has also established the existence of certain qualitative problems that need to be resolved if remote viewing abilities are to move from a general to an operative category.

The General Problem. Among the several subjects tested, dependable data resolvable from viewing targets at remote locations seem to have a signal-to-noise ratio in the range of approximately 25 to 75%. This percentage is an estimate and has differed between subjects and between experiments. In experimentation the emergence of even 25% accurate information does establish strategic implications; the occurrence of erroneous or superfluous data in subject responses to the degree that it is currently observed, however, tends to obviate tactical or operational deployment of the discovered ability. For various reasons as described below, the emergence of erroneous data in subjects' responses to given targets has been given the working name of "analytical overlay."

Definition of Analytical Overlay. Accumulated responses from subjects' attempts to view distant targets indicates that the target often is actually viewed, but in some way the target also acts as a prompter for the spontaneous appearance of seemingly irrelevant data. This is especially obvious when the subject's drawing of the target is by observation specifically applicable to the target, but his interpretation, either verbally or in the form of mental image pictures, is far from the mark. Since verbalization, or imagery, presupposes mental analysis, it seems reasonable to assume that we are dealing with automatic analytical functions of some sort, and that hypothetically these are the source of the diluted or erroneous response. Analytical functions are associated with resolving, breaking down, and dissecting incoming information in terms of experience and memory. In sensory perception, this process takes place on an almost automatic basis and is governed by learned logical necessity. Since at the sensory level these processes are continuously taking place at sub-awareness levels, it is often forgotten that logical familiarity is a learned condition, governed by experience applied to memory.

This is easily demonstrable by presenting a person with something he has never seen before. The analytical functions of the mind spontaneously output data-rich memories that assist in identification, either by similarity or differences, with the unfamiliar object. Further, in determining the nature of the unfamiliar object, the analytical processes, busily overlaying sequences of logical possibility, are prompted by sensory (tactile, visual, etc.) appreciation of the object. In this manner, the person eventually is able to logically place the unfamiliar object by means of his total fund of experience and knowledge. In terms of objective space, time, and matter, this entire procedure is anchored by a continual flow of sensory data about the object. A decision-making process buttressed by sensory

UNCLASSIFIED

perception thus takes place.

In the paranormal sense, however, ordinary sensory buttressing is absent since experimental safeguards ensure sensory separation of subject and target. The subject is therefore thrown back solely on the perception and possibilities inherent in the unknown modes of acquiring information that are currently under study. In such case, one of two things can now take place: either the subject can by paranormal modes inflow accurate information on a bit-per-second basis sufficient to allow him to make an accurate or semi-accurate decisional response as to the character or nature of the target; or his response to the target and experimental situation is weak and irresolute or perhaps displaced, at which time the content of multiple analytical processes seem to be selected. When this latter occurs, it is identified as analytical overlay.

Some Observations. It is safe to assume that in experiments where the response did not at all accord with the target, no psi functioning took place and that mental functions of some other nature were offered up by a subject. In examining research results, however, one consistency can easily be identified, this consistency giving rise to the term analytical overlay as contrasted to analytical error. Descriptors pertaining to the target can often be found imbedded in the subject's response to a degree beyond that expected by chance, even when the majority of the response appears to be involved with something else. Since this is so, it seems relevant to hypothesize that the subject is perceiving the target at some level of awareness sufficient to prompt logical mental processing in the subject. The subject's response therefore usually includes not only descriptors relevant to the target, but also other details coming out of the logical analytical comparison doubtlessly going on as he tries to "recognize" the target.

This kind of situation is exactly one that might be expected where a person is treated to only a momentary glance at an unfamiliar object and then asked to determine what it was. A series of analytical statements such as, "looks like this", or "looks like that", or "it is similar to", will probably be volunteered by the experient deprived of a continuing sensory information inflow about the object. The sensory and parasensory situations thus hold in common certain structures that can be studied either in the sensory or in the parasensory function.

With regard to their differences, in ordinary sensory perception, the decision-making response is held in place by continuous sensory perception of the object, and logical deduction and decision depends upon the solidity provided by the sensory faculties. In the paranormal sense, however, we are indeed asking the subject to begin his perception at some as yet unknown point and work simultaneously toward both perception of the object and decision as to what it is.

UNCLASSIFIED

Since descriptors pertaining to the target can almost always in some form be found imbedded in the subject's response, it seems reasonable to hypothesize that perception of the target is taking place, but in some unaccustomed modality. If this is so, as the data suggest, then the problem is not solely one of parasensory perception, but also one of conversion of the contents of the psi field into constructed form.

Let us assume that a gifted subject is gifted because he can resolve psi-field signals into recognizable mental patterns, which are in turn then converted into experiential, logical sequences. This kind of conversion process resembles that which takes place in the semaphore system or that of Morse code. The thing that is missing in the psi-field conversion process would be, of course, familiarity with the signals emanating from the psi-field matrix. As experiments demonstrate, these signals typically emerge in an unaligned sequence along with the partly logical possibilities volunteered by the analytical process. That this is so is understandable if we observe that it is human nature to depress or suppress the unfamiliar in favor of the familiar; therefore such scattering of the unfamiliar data in favor of the memory-familiar takes place both in the sensory and parasensory functions. In the paranormal case, when the data are signal-wise sufficient to bypass analytical assistance fortuitously being provided by the catalyst of memory, the so-called psi phenomena can result in exceptionally good data. Otherwise, a mixture is obtained.

Summary. Experimental results confirm the probability of abilities that permit identification and description of objects at locations at a distance. The simultaneous inflow of extraneous data termed analytical overlay seems to dilute the correctness of the overall response and detract from the operational form of the remote viewing ability. Enough data about this difficulty has been gathered to establish that it is not necessarily a perceptual problem but in all probability a process problem concerned with the converting of the signal of the psi-field matrix into a correct analytical sequence. It seems reasonable to assume that could the process difficulties be resolved, then the analytical overlay would convert into a positive adjunct of the conversion process, rather than working against it.

Any concept of utilizing remote viewing ability in an operational form has to entertain a minimum as well as a maximum criterion for proficiency. So far, in experimental expectation only the maximum possibility has been entertained. The entire onus of responsibility of achieving the maximum has lain in the expectation of attaining precise information; whereas even minimal efficiency of target perception by the subject might yield enormous clues as to the nature of the target if reviewed by professionals concerned with such a target; the target itself may have no correlate within the subject's logical repertoire

UNCLASSIFIED

and may not be correctly prompted via memory.

Thus, to achieve operational status, both changes in expectation of the ability, as well as an increased familiarity with the problems associated with analytical overlay may lead to results of increasing practical utility.

From the viewpoint of the researchers, we do not yet have an understanding of the nature of the information-bearing signal that a subject perceives. We know only that the subjects commonly report they perceive the signal visually as though looking at the object or place from a position in its immediate neighborhood. Furthermore, the subjects' perceptual viewpoint has mobility in that they are able to shift their point of view to allow them to describe elements of a scene that would not be visible to an observer simply standing at ground level and describing what he sees. (In particular, a subject often describes correctly elements not visible to the target demarcation team.) Finally, motion is in general not perceived; in fact, moving objects often are not seen at all even when nearby static objects are correctly identified.

In comparing the remote-viewing results (a so-called free-response task) with the random number generator results discussed in the next section, we note that from a statistical viewpoint a subject is more likely to describe accurately a remote site, chosen at random from nearby locations, than he is to select correctly one of four random numbers. Our experience with these phenomena lead us to consider that this difference in task performance may stem from fundamental signal-to-noise considerations. Two principal sources of noise in the system apparently are memory and imagination, both of which can give rise to mental pictures of greater clarity than the target to be perceived. In the random number task, a subject can create a perfect mental picture of each of the four possible outputs in his own imagination and then attempt to obtain the correct answer by a mental matching operation. In remote viewing, on the other hand, the subject is apparently more like to approach the task with a blank mind as he attempts to perceive pictorial information from remote locations about which he may have no stored mental data. (Subjects S1, S3, and S4 were unfamiliar with the San Francisco Bay area at the start of experimentation, their homes having been elsewhere.)

UNCLASSIFIED

UNCLASSIFIED

Finally, our observation is that most of the correct information that subjects relate to us is of a nonanalytic nature pertaining to shape, form, color, and material rather than to function or name. That is, we often observe the correct description of basic elements and patterns coupled with incomplete or erroneous analysis of function.

In consultation with Dr. Robert Ornstein of the Langley Porter Neuropsychiatric Institute, San Francisco, and with Dr. Ralph Kiernan of the Department of Neurology, Stanford University Medical Center, Stanford, California, we have formed the tentative hypothesis, based on these observed characteristics, that remote viewing may involve a specialization characteristic of the brain's right hemisphere. This possibility, discussed in detail later, is derived from a variety of evidence from clinical and neurosurgical sources, which indicate that the two hemispheres of the human brain are specialized for different cognitive functions, the left hemisphere being predominantly active in verbal and other analytical functioning, the right hemisphere in spatial and other holistic processing.^{6,7}

Further research is necessary to elucidate the relationship between right hemispheric function and paranormal abilities. Nonetheless, we can say at this point that the remote viewing results of the group of subjects at SRI have characteristics in common with performance that require right hemispheric function. The similarities include the highly schematicized drawings of objects in a room or of remote scenes. Verbal identification of these drawings is often highly inaccurate and the drawings themselves are frequently left-right reversed relative to the target configuration. Further, written material generally is not cognized. These characteristics have been seen in left brain-injured patients and in callosal-sectioned patients.

As a result of the above considerations, we have learned to urge our subjects simply to describe what they see as opposed to what they think they are looking at. We have learned that their unanalyzed perceptions are almost always a better guide to the true target than their interpretations of the perceived data.

One should not infer that analytic functioning in the remote viewing mode is never observed, however, as indicated by codeword

UNCLASSIFIED

UNCLASSIFIED

retrieval in the West Virginia Site experiment discussed in Subsection 1-b, earlier, the recognition of a computer terminal by the sponsor staff member in the technology series, and the recognition of Hoover Tower and White Plaza by subjects S1 and S6, respectively, in the natural target series.

2. Four-State Electronic Random Target Generator

This study provided an opportunity to determine whether the remote-sensing capability could be extended to the perception of the internal state of a piece of electronic equipment. For this purpose, an automated experiment designed around a four-state electronic random target generator was initiated. The solid-state machine, manufactured by Aquarius Electronics, Mendocino, California, has no moving parts and provides no sensory cue to the user as to its target generation.

To determine unambiguously whether a result was meaningful, the following strategy was used. First, so as to discriminate against subject strategies based on machine statistics, four machines were checked for departures from randomness by a statistical analysis of over 10,000 pre-experiment trials, and only the three machines that showed no significant departures from randomness were used. Second, the subjects interacted with the machines to generate the data, the machines being interchanged at arbitrary intervals without the subject's knowledge (to interfere with possible learning strategies associated with even non-significant departures from randomness). Third, for any subject whose score was significant, the statistics of the machines during the successful experiment were tabulated to ensure that the machines' outputs had not departed from randomness in the period in which the significant result was obtained. Fourth, even in the absence of a departure from randomness, the optimum strategy as determined post hoc from the distribution of actual machine outputs was compared with subject strategy. Fifth, a subject generating a good score was asked to repeat the entire experiment one month later under continuous observation by an experimenter. Finally, the entire data analysis was carried out by an independent statistics group at SRI under the direction of Dr. Richard Singleton.

UNCLASSIFIED

UNCLASSIFIEDa. Machine Description

The machine configuration provides as a target one of four art slides (reproductions of paintings) chosen randomly ($p = 1/4$) by an electronic random target generator. The generator does not show its choice until the subject indicates his choice to the machine by pressing a button (yellow, green, blue, or red) associated with each art slide (see Figure 19). (The machine has four stable internal states. A 1.0-MHz square-wave oscillator sends pulses to an electronic "scale-of-four" counter which passes through each of its four states 250,000 times per second. The state of the counter is determined by the length of time the oscillator has run--that is, the time between subject choices.) As soon as the subject indicates his choice, the target slide is illuminated to provide visual and auditory (bell if correct) feedback as to the correctness or incorrectness of his choice. Until that time, both subject and experimenter remain ignorant of the machine's choice, so the experiment is of the double-blind type. Five legends at the top of the machine face are illuminated one at a time with increasing correct choices (6, 8, 10, ...) to provide additional reinforcement. The machine choice, subject choice, cumulative trial number, and cumulative hit number are printed automatically on continuous fanfold paper tape. After trial number 25, the machine must be reset manually by depressing a RESET button.

A methodological feature of the machine is that the choice of a target is not forced. That is, a subject may press a PASS button when he wishes not to guess, in which case the machine indicates what its choice was. The machine thus scores neither a hit nor a trial and then goes on to make its next selection. Thus, the subject does not have to guess at targets when he feels that he has no idea as to which to choose.

Under the null hypothesis of random binomial choices with probability $1/4$ and no learning, the probability of observing $\leq k$ successes in n trials is approximated by the probability of a normal distribution value, t ,

$$t \geq \left(k - \frac{n}{4} - \frac{1}{2} \right) / (3n/16)^{\frac{1}{2}} .$$

UNCLASSIFIED

UNCLASSIFIED

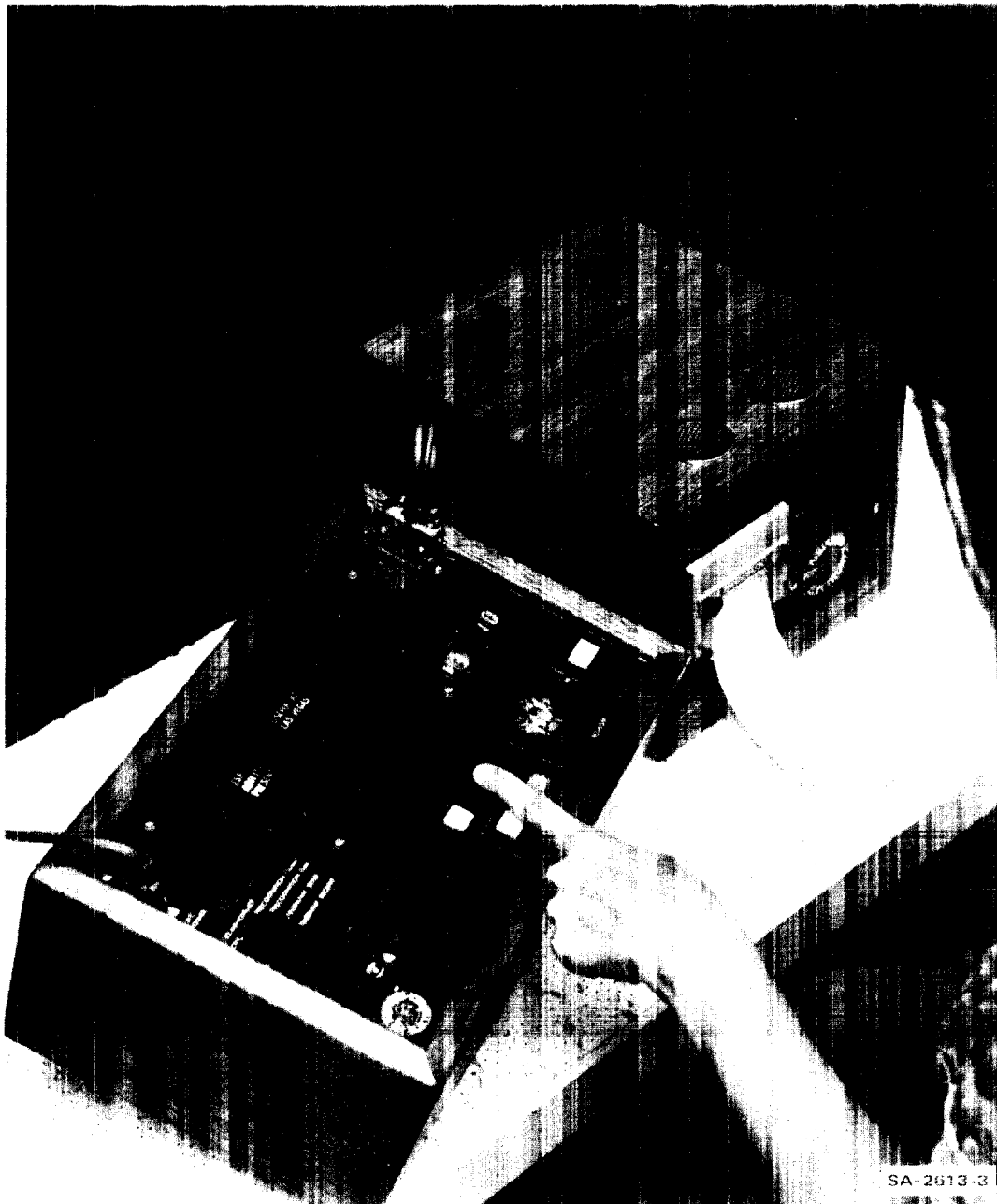

FIGURE 19 FOUR-STATE RANDOM TARGET GENERATOR USED IN THIS EXPERIMENT
An incorrect choice of target is indicated. Two of the five "encouragement lights" at the top of the machine are illuminated. The printer to the right of the machine records data on fan-fold paper tape.

UNCLASSIFIED

UNCLASSIFIED

b. Data from Experiments

Data were collected from subjects S1 through S6. Each subject was asked to complete 100 25-trial runs (i.e., a total of 2500 trials each). The results are tabulated in Table 13. (One subject, S3, declined to complete the 2500-trial run, citing a lack of rapport with the machine and, hence, a lack of motivation for the task.) Of the six subjects, only one (S2) scored significantly above chance. For the 2500 trials, S2 averaged 29.36 hits/100 trials rather than the expected 25/100, a result whose a priori probability under the null hypothesis is $p = 3 \times 10^{-7}$. His scores are plotted in Figure 20.

TABLE 13

Four-State Electronic Random Target Generator Summary

Subject	Mean Score/100 Trials over 2500 Trials	Binomial Probability
S1	25.76	0.22
S2	29.36	3×10^{-7}
S3	24.67 (750 trials)	0.60
S4	25.76	0.22
S5	25.20	0.33
S2	27.88	4.8×10^{-4}
All trials	26.47 (15,750 trials)	1.1×10^{-5}

The statistics of the machines during the successful run of subject S2 were tabulated for the entire 3483 machine transitions (2500 choices, 983 passes), both by machine and in total. The results, shown in Tables 14 through 16, indicate no significant departures from random expectation during the successful run, and therefore, the significant result cannot be attributed to machine malfunction.

UNCLASSIFIED

UNCLASSIFIED

70

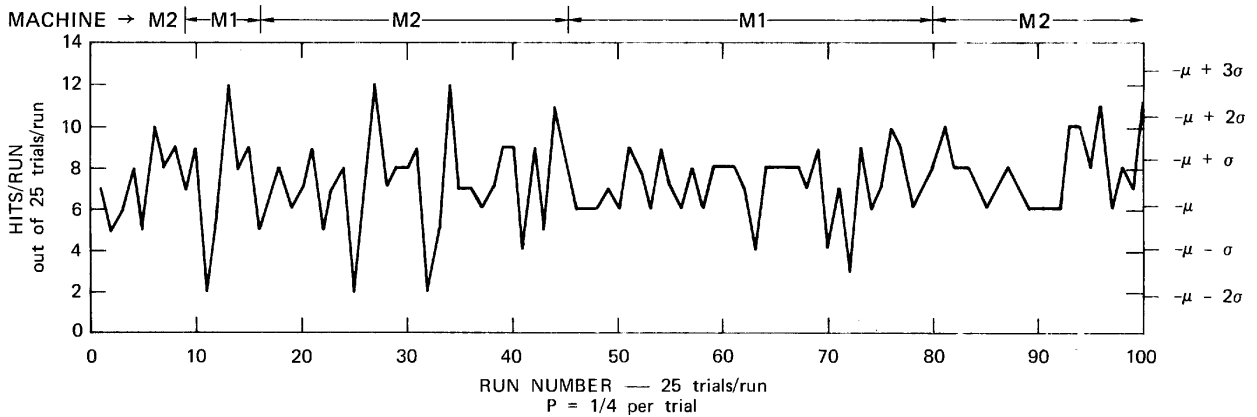

UNCLASSIFIED

FIGURE 20 DATA SUMMARY FOR SUBJECT S2
2500-trial experiment with four-state electronic random number generator (significant at $p = 3 \times 10^{-7}$).

UNCLASSIFIED

TABLE 14
 Randomness Tests for Machine M1 Output
 During Successful Experimental Series by Subject S2
 (Runs 9 through 16 and 45 through 80)

		Buttons				Number of Trials	Chi-Square	Binomial probability
		Yellow	Green	Blue	Red			
Transitions	Y	96	79	88	92	355	1.789	> 0.50
	To							
	G	85	87	86	88	346	0.058	> 0.99
From	B	85	82	90	87	344	0.395	> 0.90
	R	91	91	83	92	357	0.591	> 0.80
Initial states		8	14	9	13	44	2.364	> 0.50
All states		365	353	356	372	1446	0.622	> 0.80
Nondiagonal transitions		261	252	257	267	1037	0.466	> 0.90
Diagonal transitions		96	87	90	92	365	0.468	> 0.90

TABLE 15
 Randomness Tests for Machine M2 Output
 During Successful Experimental Series by Subject S2
 (Runs 1 through 8, 17 through 44, and 81 through 100)

		Buttons				Number of Trials	Chi-Square	Binomial probability
		Yellow	Green	Blue	Red			
Transitions	Y	108	120	111	124	463	1.458	> 0.50
	To							
	G	107	131	136	119	493	4.095	> 0.20
From	B	126	124	138	135	523	1.061	> 0.70
	R	118	115	140	129	502	3.100	> 0.30
Initial states		16	15	13	12	56	0.714	> 0.80
All states		475	505	538	519	2037	4.149	> 0.20
Nondiagonal transitions		351	359	387	378	1475	2.247	> 0.50
Diagonal transitions		108	131	138	129	506	3.960	> 0.20

UNCLASSIFIED

UNCLASSIFIED

TABLE 16

RANDOMNESS TESTS FOR ENTIRE MACHINE
 OUTPUT DURING SUCCESSFUL EXPERIMENTAL RUN

	Buttons				Number or Trials	Chi-Square	Binomial probability	
	Yellow	Green	Blue	Red				
Transitions	Y	204	199	199	216	818	0.944	> 0.80
From	To G	192	218	222	207	839	2.578	> 0.30
	B	211	206	228	222	867	1.397	> 0.70
	R	209	206	223	221	859	1.009	> 0.70
Initial states		24	29	22	25	100	1.040	> 0.70
All states		840	858	894	891	3483	2.364	> 0.50
Nondiagonal transitions		612	611	644	645	2512	1.736	> 0.50
Diagonal transitions		204	218	228	221	871	1.399	> 0.70

UNCLASSIFIED

UNCLASSIFIED

With regard to the possibility that the subject developed an optimum strategy based on slight, even though nonsignificant, machine departures from chance expectation, it is sufficient to determine the most favorable strategy based on machine statistics and examine whether use of such a strategy would be capable in principle of producing a result as significant as that produced by the subject.

For machine M1 the optimum strategy, according to Table 17 is: if in the initial state, press green; if yellow, press yellow; otherwise, pass. Use of such a strategy would, in the 44 runs carried out, result in 14 correct initial state selections and a scoring fraction $96/355 = 0.2704$ on the remaining $44 \times 24 = 1056$ transitions, resulting in 300 hits.

For machine M2 the optimum strategy, according to Table 18, is: if in the initial state, press yellow; if red, press blue; otherwise pass. Use of such a strategy would, in the 56 runs carried out, result in 16 correct initial state selections and a scoring fraction $140/502 = 0.2789$ on the remaining $56 \times 24 = 1344$ transitions, resulting in 391 hits. Thus, an optimum strategy derived from the machine distribution post hoc yields a scoring fraction $691/2500 = 0.2764$, significantly less than the observed scoring fraction 0.2936. In any case, it is clear from an examination of the compilation of subject choices (Tables 17 and 18) that subject selections, although extremely nonrandom, differed widely from those strategies favorable to the production of results based on machine statistics. Further, there is no evidence of learning to support the hypothesis that a successful strategy was developed. A more detailed analysis of strategies, confirming these conclusions, was carried out by the sponsor under the direction of the COTR.

When subject S2 was asked to repeat the entire experiment at a later time, he was able to replicate successfully a high mean scoring rate (27.88/100 average over 2500 trials, a result whose a priori probability under the null hypothesis is $p = 4.8 \times 10^{-4}$).

We thus conclude from the machine study that of the six subjects tested, one subject (S2) was able to generate a significant and replicable result. From these results, we conclude that there is evidence for the existence of a human perceptual capability whereby electronically

UNCLASSIFIED

UNCLASSIFIED

TABLE 17

SUBJECT S2 SELECTIONS ON MACHINE M1
 DURING SUCCESSFUL EXPERIMENTAL SERIES
 (Runs 9 through 16 and 45 through 80)

		Buttons				
		Yellow	Green	Blue	Red	Pass
Transitions	Y	51	47	35	141	73
From 	To G	45	12	13	70	30
	B	30	17	2	38	16
	R	149	58	37	82	110
	Pass	73	36	13	108	116
Initial states		14	4	6	19	1
All states		362	174	106	458	346

TABLE 18

SUBJECT S2 SELECTIONS ON MACHINE M2
 DURING SUCCESSFUL EXPERIMENTAL SERIES
 (Runs 1 through 8, 17 through 44, and 81 through 100)

		Buttons				
		Yellow	Green	Blue	Red	Pass
Transitions	Y	67	77	54	179	125
From 	To G	68	2	14	107	38
	B	50	22	2	40	15
	R	208	96	38	31	111
	Pass	105	33	22	129	348
Initial states		21	7	1	27	0
All states		519	237	131	513	637

UNCLASSIFIED

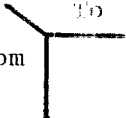
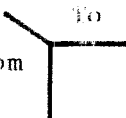
UNCLASSIFIED

stored information can be accessed by means of a perceptual modality not mediated by physical parameters as yet identified.

The characteristics of such a channel can be specified in accordance with the precepts of communication theory. The bit rate associated with the information channel is calculated from⁸

$$R = H(x) = H_y(x) \quad , \quad (1)$$

where $H(x)$ is the uncertainty of the source message containing symbols with an a priori probability p_i

$$H(x) = - \sum_{i=1}^2 p_i \log_2 p_i \quad , \quad (2)$$

and $H_y(x)$ is the conditional entropy based on the a posteriori probabilities that a received signal was actually transmitted,

$$H_y(x) = \sum_{i,j=1}^2 p(i,j) \log_2 p_i(j) \quad . \quad (3)$$

For S2's first run, with $p_i = 1/4$, $p_j(j) = 0.2936$, and an average of 30 s/choice, we have a source uncertainty $H(x) = 2$ bits and a calculated bit rate

$$R = 0.007 \text{ bits/symbol}$$

or

$$R/T = 2 \times 10^{-4} \text{ bits/s} \quad .$$

In a larger study for NASA, devoted specifically to the question of whether learning could take place, 147 subjects were screened.⁹ Of these subjects, six showed a positive learning slope significant at the 0.01 level or better; the binomial probability of this occurring by chance is 3.8×10^{-3} . At the other extreme, no subjects had a negative slope at the 0.01 level or better, in contrast to those six who had a positive slope at the 0.01 level. The slopes of the remaining 141 subjects (448,000 trials) were found to be normally distributed.

UNCLASSIFIED

UNCLASSIFIED

B. Identification of Measurable Characteristics Possessed by Gifted Subjects

1. Medical Evaluation

The medical evaluation of program participants was assigned to the Palo Alto Medical Clinic. Coordination of the program was handled by Dr. Robert Armbruster, Director of the Clinic's Department of Environmental Medicine.

The testing procedures fall into six categories:

- (1) General physical examination, including complete medical and family history.
- (2) Laboratory examinations, including SMA-12 panel blood chemistries, protein electrophoresis, blood lipid profile, urinalysis, serology, blood type and factor, pulmonary function screening, and 12-lead electrocardiogram.
- (3) Neurological examination, including comprehensive and electroencephalogram (sleeping and routine).
- (4) Audiometric examination, including comprehensive, Bekesy bone conduction, speech discrimination, and impedance bridge test.
- (5) Ophthalmologist examination, including comprehensive, card testing, peripheral field test, muscle test, dilation funduscope, and indirect ophthalmoscopic and fundus examination.
- (6) EMI brain scan.

The detailed subject-by-subject test results are on file with the sponsor. Following are the summary evaluations prepared by Dr. Armbruster.

a. Subject S1 (Experienced)

This 55-year-old male completed an extensive medical evaluation recently in conjunction with special studies being performed at SRI for personnel gifted in paranormal functioning.

Aside from a duodenal ulcer in 1952, his past medical history was essentially normal. At present significant defects on physical examination were small, bilateral inguinal hernias, and dental caries. An electrocardiogram was interpreted as abnormal, showing characteristics of coronary artery disease.

UNCLASSIFIED

UNCLASSIFIED

SI was advised of this report by letter on August 9, 1974, with recommendations for further evaluation by a cardiologist.*

Laboratory data--including waking and sleeping electroencephalograms, protein electrophoresis, complete blood count, serology, and urinalysis--were normal. He has blood type AB, Rh positive. Blood chemistries were essentially normal with the exception of slight elevations of uric acid and cholesterol with marked elevation of triglycerides.

Ophthalmological examination revealed a minimal refractive error corrected easily to normal. An extensive neurological examination and history were considered normal. The EMI computerized brain scan was considered negative except for slight enlargement of the right ventricle. No significance can be presently placed on this finding.

Audiometry revealed a mild bilateral high-frequency hearing loss at 3000 cps secondary to past exposure to high noise levels.

b. Subject S2 (Experienced)

This 31-year-old male research scientist completed an extensive medical evaluation recently in conjunction with special studies being performed at SRI for gifted psychic personnel.

His past medical history reveals a right inguinal herniorrhaphy and appendectomy. Physical examination revealed no significant abnormalities. Laboratory data--including electrocardiography, protein electrophoresis, audiometry, pulmonary function, serology, blood chemistries, urinalysis, waking and sleeping electroencephalograms, and EMI brain scan--were normal.

Ophthalmological exam revealed a myopic refractive error correctable to 20/15 bilaterally.

Neurological examination was negative. History revealed the presence of periodic muscular contraction headaches. Migraine headaches have been completely relieved since institution of biofeedback training.

c. Subject S3 (Experienced)

This 40-year-old male research consultant completed an extensive medical evaluation recently in conjunction with special studies being performed at SRI for gifted psychic personnel.

His past medical history, other than a case of hepatitis while in the Armed Services, was essentially noncontributory to this study. Physical examination was entirely within normal limits.

* In spite of follow-up medical treatment, we note with sadness his death in July 1975 due to a coronary.

UNCLASSIFIED

UNCLASSIFIED

Laboratory data--including electrocardiography, protein electrophoresis, audiometry, pulmonary function, complete blood count, serology, urinalysis, and EMI brain scan--were normal. Blood chemistries were normal with the exception of moderate elevation of blood lipids. He has blood type A, Rh positive.

He has myopic astigmatism correctable to 20/20 bilaterally; otherwise a normal ophthalmological examination.

Neurological history, examination, and both sleeping and waking encephalograms were reported as normal.

4. Subject S4 (Learner/Control)

This 53-year-old female photographic consultant completed a medical evaluation recently in conjunction with special studies being performed at SRI for gifted psychic personnel.

Except for several surgeries, her past history is essentially noncontributory to her medical record. Her physical examination was normal with the exception of a minor gynecological problem.

Laboratory data--including electrocardiography, protein electrophoresis, audiometry, pulmonary function, complete blood count, serology, blood chemistries, and urinalysis--were normal. Blood type is O, Rh positive. Ophthalmological examination was normal except for a mild correctable refractive error.

Both waking and sleeping electroencephalograms were normal as were the neurological history and physical examinations.

The EMI brain scan was reported as suggestive of very mild frontal atrophy. No other abnormal features are noted.

5. Subject S5 (Learner/Control)

This 54-year-old male staff scientist completed an extensive medical evaluation recently in conjunction with special studies being performed at SRI for gifted psychic personnel.

His past history reveals a duodenal ulcer in 1964 but is otherwise not significant. Physical examination was essentially negative.

Laboratory data--including electrocardiography, lipoprotein electrophoresis, complete blood count, serology, blood chemistries, blood lipids, urinalysis, and EMI brain scan--were normal. Audiometry revealed a mild bilateral perceptive-type hearing loss at 4000 cps probably due to noise exposure. Pulmonary function suggested mild pulmonary obstructive disease secondary to cigarette smoking.

Ophthalmological exam was normal except for a corrective refractive error. Neurological history revealed rare migraine auras without headache. Neurological examination was entirely normal.

UNCLASSIFIED

UNCLASSIFIED

f. Subject S6 (Learner/Control)

This 34-year-old female completed an extensive medical examination recently in conjunction with special studies being performed at SRI for gifted psychic personnel.

Her past medical history was essentially noncontributory except for the vague but unlikely possibility of Reiters Syndrome.

Laboratory data--including electrocardiography, protein electrophoresis, audiometry, pulmonary function, complete blood count, serology, blood chemistries, urinalysis, and EMI brain scan--were normal. She has blood type A, Rh positive.

Ophthalmological examination, with the exception of a moderate but corrected myopic astigmatism, was within normal limits.

Although her waking EEG was abnormal, her sleeping EEG and neurological examination were perfectly normal. It was not considered necessary or advisable to pursue this mild abnormality any further, especially in view of a normal neurological exam and EMI brain scan. The patient was not made aware of this minor deviation. Neurological history substantiates period muscular contraction headaches.

g. Summary of Medical Evaluation

In summary, it appears that the medical profiling is noncontributory to the study, all subjects showing essentially normal medical profiles without any discernible spread among the subjects.

2. Psychological Evaluation

The psychological evaluation of the program participants was assigned to the Palo Alto Medical Clinic. Coordination of the program was handled by Dr. J.E. Heenan, Chief Clinical Psychologist of the Clinic's Department of Psychiatry. The testing itself was carried out by Dr. Karen Nelson, Clinical Psychologist at the Clinic.

The tests administered included:

- (1) In-depth interviews, including objective events and subjective views relating to the discovery and enhancement of paranormal capacities; socioeconomic, cultural, familial, religious environment; outstanding emotional peaks, traumas; values, motivation, interpersonal style.
- (2) Wechsler Adult Intelligence Scale (WAIS)
- (3) Bender Gestalt Visual Motor Test
- (4) Benton Visual Memory Test

UNCLASSIFIED

UNCLASSIFIED

- (5) Wechsler Memory Scale
- (6) Luscher Color Test
- (7) Strong Vocational Interest Blank
- (8) Minnesota Multiphasic Personality Inventory (MMPI)
- (9) Edwards Personality Preference Schedule (EPPS)
- (10) Rorschach Inkblot
- (11) Thematic Apperception Test (TAT)

The detailed test results for each subject are on file with the COTR. Due to the personal nature of the data we present here only the summary evaluations, first by the clinical psychologist who administered the tests and interviewed the subjects in depth, and second by the chief clinical psychologist who analyzed the data on a blind basis.

1. Evaluation by Clinical Psychologist Administering Tests

The following is quoted from the psychologist's report:

During late summer and early fall, 1974, six subjects were referred to the Clinic for testing for the parapsychology study at Stanford Research Institute. Three of the subjects were designated as sensitive subjects and three of the subjects were designated as controls. It was planned that I would do the testing without knowledge of which subjects were considered sensitive and which subjects were considered controls. However, in the course of my contacts with these subjects, it proved impossible not to know which subjects belonged to which group, since I was to interview each person in depth. Since personal experience with apparently extrasensory perception is a fairly dramatic event, subjects could not avoid talking about these events and still be honest in an in-depth interview. Consequently, a secondary plan was developed in which I would do the psychological testing and write individual reports for each subject, and the Chief Clinical Psychologist, Dr. Heenan, would read the test blind and see whether he could pick out three test records which seemed more similar to each other than the rest, thereby discriminating between sensitive and non-sensitive subjects.

Intellectual Functioning

All of the subjects in this study displayed distinctly above-average intellectual abilities. Most subjects reached the superior range, and several of the subjects reached the gifted range. As it happened, the control subjects tended to show higher average intellectual functioning scores than did sensitive subjects, although the difference could not be said to be significant, given that there were only three subjects in each group. Two of the subjects from the sensitive group showed highly variable

UNCLASSIFIED

UNCLASSIFIED

subtest scores within their intelligence test battery. That is, some of the subskills would be extremely high and other subskills would be extremely low. The variable patterns shown are consistent with ambivalent motivation as regards learning tasks and academic situations. I was able to spot no consistent trends as to which subskills tended to be high and which subskills tended to be low. For all six subjects, verbal and performance skills tended to be about evenly balanced, and memory skills were approximately what would be expected, given the intelligence scores attained. The number scores on memory tests as well as the performances of the subjects themselves reflect a slight tendency toward better memory for material which is organized logically or which appears in a meaningful context than for rote memory material. In the control group, this tendency seems less pronounced and in fact one subject showed a clear preference for rote memory material. The subjects themselves did not feel that any of the intelligence test material tapped skills or propensities on their part which might be linked to their extrasensory capabilities, and since the patterns of strength and weakness within the test profiles varied so widely, I am inclined to accept their judgment with one possible exception. It is possible that sensitive subjects tend to be holistic perceivers rather than analytic perceivers; that is, to perceive in Gestalt rather than analytic elements. This might underlie the tendency for better short term memory of contextual logical material. Psychological tests which are directly relevant to this difference in perceptual style appear not be standardized as yet and so it is difficult to follow this lead.

Personality Functioning

When looked at from the point of view of psychopathology, the indicators both in projective and in objective testing do not appear to me to show marked trends, either for the six subjects taken together or for the subjects in each group. There does appear to be an interesting similarity in defensive style, particularly when this is taken together with a similarity in interests and vocational aptitude, which can be seen in a large number of the subjects both in sensitive and control groups. To elaborate, all six subjects tended to have high feminine scores on the masculinity-femininity scale of the MMPI. That scale does not measure sexual orientation but rather sex role stereotype. For example, a person who is highly active in expressing his aggression, who is self assertive and who adopts "masculine" interest in, say, sports, mechanics, etc., is likely to get a high masculine score; a person who tends to be fairly passive in expressing aggression, even manipulative, who tends to be interested in the arts, in music, in aesthetic sensitivities, is likely to gain a high feminine score. Both the men and women in this group of subjects tended to have high feminine scores. The trend is seen again in the vocational aptitude survey, the Strong Vocational Interest Blank, wherein all of the subjects tended to achieve high scores in music, art

UNCLASSIFIED

UNCLASSIFIED

and writing, but particularly in writing was this consistent. The score on writing aptitude appeared to be above average for the general population in each subject and for several of the subjects it was one of the highest scores obtained. These two trends in the objective personality test data can be compared with another trend found in the projective test data, namely on the Rorschach. Here, the responses of the subjects tended to emphasize animal or human movement and to de-emphasize color. This pattern is common in people who tend to be introspective, to have a rich inner fantasy life, and in fact to prefer that kind of expression of their emotions to interpersonal expression. The capacity to stand back from one's feelings, observe them, analyze them, even to savor them, is common among artists and particularly among writers.

Unfortunately, two of the subjects (S1 and S3) from the sensitive group were highly defensive about test-taking and their defensiveness was most pronounced in the projective personality tests. The result was that they gave very minimal records, very few responses, and were close-mouthed in talking about their responses. Hence, the pattern to which I refer can be seen more clearly in the control subjects than in the sensitive subjects even though it appears to occur for all six subjects.

In the course of the testing, the control subjects began to tell me that as they participated in the SRI study, they appeared to be developing more and more sensitivity on the experiments performed and each was not certain that he should be properly classified as a control subject. In talking with Dr. Puthoff, I learned that they did appear to be showing some sensitivity but that their performances were not reliable and so they still could be said to be importantly different from the sensitive subjects. If the sensitive subjects could be induced to be less defensive in test-taking, it is possible that their records would show a pattern which could be distinguished from that of the control subjects. Since that is not the case, we are left with a dilemma. A tendency toward artistic interests, a rich fantasy life and an introversive style of emotional expression may be accidental in all of these six subjects. It may be characteristic of persons who are willing to participate in parapsychological studies. It may be characteristic of persons who have some extrasensory capacity, whether great or small, or it may relate to some other variable which happens to be common to these six subjects.

Should the pattern of emotional style and aesthetic interest prove relevant to extrasensory capacity, it would seem that the Rorschach gets at the most fundamental level of this quality. The objective tests are more likely to be measuring the end products of that fundamental level of emotional expression. Since my reading of projective test material is likely to be colored by my acquaintance with the subjects and what they said about themselves, I will be interested to see whether Dr. Heenan

UNCLASSIFIED

UNCLASSIFIED

can discern the same pattern, and for my own curiosity I would like to be able to test the sensitive subjects again, without them having read this report, to see whether I could put them more at ease on a second contact and get more productive records from them. Two of these subjects (S1 and S3) said frankly that they were alienated at the thought of psychological testing because their experience was that people with extrasensory capacity were written off as nuts and that psychologists and psychiatrists always examined them with an eye toward any pathology they could discover. If they could be reassured that that was not the point of interest and at the same time not be coached as to what kinds of responses I was interested in, another session of projective testing might be productive.

Karen L. Nelson, PhD
Clinical Psychologist
Palo Alto Medical Clinic

b. Evaluation by Chief Clinical Psychologist (On a Blind Basis)

An effort complementary to the overall analysis performed by Dr. K. Nelson was carried out by Dr. J. Heenan, Chief Clinical Psychologist, Department of Psychiatry, Palo Alto Medical Clinic. He took on as a task the ferreting out of responses to specific test items to determine whether a particular cluster of items might serve as the core of a screening procedure. Dr. Heenan's analysis was carried out on a blind basis, that is, without knowledge of which subjects were labeled sensitive and which were labeled control. The following is quoted from Dr. Heenan's report:

I have finished going over the psychological test data on the six subjects tested and this is a summary of my thoughts, impressions, clinical judgments, guesses and comparisons of various dimensions.

The six persons tested are labeled S1 through S6. Subject S1 would not take the TAT test and did not return the EPPS test, and there is not a Strong vocational interest test in the file on him. I included him in the comparisons on the tests which he did take.

What I did was formulate some hypotheses and then examine the test data, ranking people according to what their tests reflected on those hypotheses, and from that arrived at which subjects might have, according to the hypothesis, a more than ordinary ability to communicate by non-ordinary means. First of all, I examined all the test data rather carefully from a clinical psychologist's point of view and without any specific hypotheses--that is, on the basis of my overall intuition--made guesses, for each battery of tests, whether or not I thought this person would be likely to have unusual abilities. On this basis I guessed subjects S3, S6 and S4 as the most likely ones to have been high achievers

UNCLASSIFIED

UNCLASSIFIED

in your experiments.

The following is a series of hypotheses on the Rorschach Ink Blot Test and following each hypothesis are the three subjects who best fit that hypothesis from the test data.

HYPOTHESIS #1. White space responses reflect lower ability to use non-ordinary means of communication.

Results: Subjects S3, S6 and S4 have the fewest white space responses and therefore, according to this hypothesis, would have the higher ability among this group.

HYPOTHESIS #2. Preoccupation with minor details (Dd) will be inconsistent with the ability to communicate by non-ordinary means.

Results: Subjects S3, S6 and S4 reflect the least use of minor details in Rorschach responses.

HYPOTHESIS #3. Those persons with the highest percentage of human movement responses will be those most likely to be able to communicate by non-ordinary means.

Results: Subjects S4, S6 and S2 are the three highest in this regard.

HYPOTHESIS #4. The use of instant whole responses will be greater in those persons with the ability to communicate by non-ordinary means.

Results: Subjects S3, S6 and S4 are the highest in this regard.

HYPOTHESIS #5. Using shading responses as an index for anxiety, those who have the most shading responses will do the least well in communicating by non-ordinary means.

Results: Subjects S4, S1 and S2 have the most shading responses.

HYPOTHESIS #6. Those subjects able to communicate best by non-ordinary means will tend to be more childlike in their general approach to life and this will be reflected by higher animal content percent on the Rorschach test.

Results: Subjects S5, S4 and S1.

HYPOTHESIS #7. (This hypothesis is relevant to Hypothesis #6.) Those subjects with the most animal movement responses will tend to be able to communicate more by non-ordinary means.

Results: Subjects S4, S6 and S2.

HYPOTHESIS #8. The persons who most use color in their responses will be most likely to be able to communicate better by non-ordinary means.

Results: There is no spread among the subjects on this particular scoring determinant.

HYPOTHESIS #9. Those subjects using the most emotional determinants will be most likely to be able to communicate by non-ordinary means.

Results: Subjects S3, S6 and S4 have the most use of emotional determinants on the Rorschach Test.

UNCLASSIFIED

UNCLASSIFIED

On the MMPI, the following hypotheses were checked out.

HYPOTHESIS #1. Subjects who show the most unusual configurations on the MMPI will be those most likely to be able to communicate by non-ordinary means (scores above 70).

Results: Subjects S3, S6 and S2.

HYPOTHESIS #2. Those subjects who reflect the most emotional energy as measured by the Ma score will be most likely to communicate by non-ordinary means.

Results: Subjects S6, S3 and S2--the opposite of this hypothesis is that those with the lowest Ma scores were subjects S1, S5 and S4.

HYPOTHESIS #3. Those subjects who show the most interest in human interaction will be most likely to do well in non-ordinary communication as measured by the Si score; the rank among the subjects from highest to lowest is S5, S4, S6, S2, S1, S3. Therefore, subjects S5, S4 and S6, according to this hypothesis, would be the successful ones.

HYPOTHESIS #4. Those subjects showing the most depression would be least likely to be able to communicate by non-ordinary means; the rank on the depression score among the subjects is from highest to lowest--S6, S4, S3, S2, S1, S5, with S6, S4, and S3 being the predicted least likely to do well at your tasks, and subjects S2, S1 and S5 the most likely.

The Wechsler Bellevue Intelligence Scale hypotheses were simple and easy to check. The first hypothesis on the results of the Wechsler, HYPOTHESIS #1, is that higher intelligence as measured by the IQ score will reflect higher ability to communicate by non-ordinary means. Using the Full Scale IQ score, the rank from highest to lowest on IQ is subjects S5, S2, S6, S4, S1, and S3. Therefore, S5, S2, S6, according to this hypothesis, would be the subjects most likely to have succeeded. There is very little difference in the ranking in general, using the verbal IQ and the performance IQ. Taking a closer look at the subtest scores of the Wechsler, the following hypotheses were checked out.

HYPOTHESIS #2 on the subtest scores: Persons with the highest ability in visual motor coordination, as reflected by the Block Design subtest, will be most likely to be able to communicate by non-ordinary means. The rank on the Block Design subtest from high to low is S5, S3, S6, S4, S2, and S1.

HYPOTHESIS #3. Those with the best immediate memory as reflected by the Digit Span subtest will be the most likely to achieve in the non-ordinary communication modality. The rank for subjects from highest to lowest on Digit Span is S3, S6, S4, S5, S2, and S1 with very little spread among them.

Other aspects of the Wechsler which were specifically checked out were the Picture Completion subtest and the Arithmetic subtest. The rank from highest to lowest in Picture Completion is S1, S2, S5, S3, S4, S6, and the rank on the Arithmetic subtest is S5, S4, S2, S3, S1, and S6. I did not have a hypothesis about these particular subtests since they are reflections of

UNCLASSIFIED

UNCLASSIFIED

higher IQ, which was already covered before.

Careful review of the Strong Vocational Interest Blank results, tabulating various scored categories and profile configuration, revealed no pattern that separated any group of subjects from any other group of subjects. This, however, is a multi-dimensional test with many variables and perhaps a more complex statistical analysis, such as analysis of variants, may show some clusters not visible to this examiner.

On the Bender Gestalt Visual Motor test, the simple hypothesis was made that the higher the ability to reproduce better designs, the more likely would be the person's ability to communicate by non-ordinary means. The Bender test results were ranked according to quality in form, Gestalt and accuracy, and the following ranks were obtained. From highest to lowest, subjects S4, S3, S6, S5, S1, and S2. No other evident material was reflected on the Bender designs.

It appears to me that according to most of the hypotheses I came up with, subjects S3, S6 and S4 are the most likely candidates. The results of the Luscher and TAT tests, after careful examination, do not suggest any systematic means for breaking this group of six into two groups of three. However, on the TAT subjects S3, S6 and S5 appeared to this examiner to reflect more spontaneity and childlike exuberance for living and therefore might be inferred to possess more sensitivity or awareness to non-cognitive dimensions of experience; therefore, I think subjects S3, S6, and S4 are the most likely ones to have done the experiments well. I also note that those who couldn't apparently were learning how, and therefore apparently whatever this ability is, it is a learnable one--of course, if such communication does exist, that should be true since we all come with essentially the same basic equipment.

J.E. Heenan, PhD
Chief Clinical Psychologist
Palo Alto Medical Clinic

On a post hoc basis, we can examine the various hypotheses suggested by Dr. Heenan and determine which ones tend to correlate with observable paranormal functioning. However, given the small sample size, no significant conclusions can be drawn--rather, these points simply suggest hypotheses to be examined in future testing.

On the basis of the remote viewing and random target generator experiments, experienced subjects S1 through S3 and learner/control S4 performed reliably in contrast to learner/control subjects S5 and S6. There were four tests which tended to correlate with this partition in the sense that three of the four successful subjects lacked a trait

UNCLASSIFIED

UNCLASSIFIED

which was possessed by both of the unsuccessful subjects. These were the traits considered in Rorschach Hypothesis #5, MMPI Hypothesis #3, and WBIS Hypotheses #1 and #2; the four hypotheses suggested by Dr. Heenan were all counterindicated, that is, the responses suggested as probable for successful subjects were found to hold for the unsuccessful ones. On the basis of this small sample, therefore, one might consider investigating the following traits as potentially indicating a lesser ability in paranormal functioning: low anxiety index as indicated by low degree of shading response in the Rorschach, a high degree of interest in human interaction as measured by the Si score of the MMPI, an exceptionally high IQ (gifted range) as measured by the Wechsler Bellevue Intelligence Scale, and excellent visual motor coordination as reflected in the Block Design subtest of the Wechsler Bellevue Intelligence Scale. It must be emphasized, however, that although subjects scoring highest with regard to the above factors did least well in the tests of paranormal functioning, all subjects scored higher than the norm in these psychological factors, so it would be erroneous to extrapolate on the basis of these data that low scoring might indicate paranormal ability. It is simply that extremely high scores are observed to correlate negatively with success on the particular paranormal tasks investigated. Finally, we reiterate that the correlation as observed on the basis of such a small sample may be gratuitous and should therefore only be considered as a basis for further hypothesis testing.

UNCLASSIFIED

UNCLASSIFIED

3. Neuropsychological Evaluation

Neuropsychological profiles on the six subjects were obtained by the administration of the Halstead-Reitan Neuropsychology Test Battery as well as other tests known to be sensitive to brain dysfunction. These tests have proven useful in predicting, for example, both the presence and location of brain damage in a variety of neurological diseases. Since, when no damage is present these tests also reflect abilities dependent on brain function, it was hoped that some meaningful pattern of test performance would emerge for the program subjects. The testing and evaluation was handled by Dr. Ralph Kiernan, Clinical Neuropsychologist, Department of Neurology, Stanford University Medical Center, Stanford, California.

The following is his evaluation;

All subjects were given the following tests:

- (1) Halstead Category Test
- (2) Tactual Performance Test
- (3) Speech Perception Test
- (4) Seashore Rhythm Test
- (5) Finger Tapping Test
- (6) Trail Making Test
- (7) Knox Cube Test
- (8) Raven Progressive Matrices
- (9) Verbal Concept Attainment Test
- (10) Buschke Memory Test
- (11) Grooved Pegboard Tests

Two additional tests were added after several subjects had been tested and were not administered to all subjects. These were:

- (12) The Gottschaldt Hidden-Figures Test
- (13) The spatial relations subtest of the SRA Primary Mental Abilities Test.

A description of these tests along with subject scores is given in Table 19.

Since other psychological testing was completed previously on these same subjects at the Palo Alto Medical Clinic, the results of two of these tests (The Wechsler Adult Intelligence Scale and the Benton Visual Retention Test) were consulted in the overall neuropsychological evaluation.

Very few of the results are common to all six subjects. In fact, the only ones that are common involve general

UNCLASSIFIED

TABLE 19. NEUROPSYCHOLOGY TEST BATTERY

Test	Description	Scoring						Y	O	
		S1	S2	S3	S4	S5	S6			
Halstead Category Test	Nonverbal test requiring abstraction of conceptual relationships. Score: Total errors.	7	14	33	26	6	28	μ SD	15 5	15 5*
Tactual Performance Test	Requires placement of 10 geometrically shaped blocks in their correct locations on a formboard while blindfolded. Separate RT, LT, and bimanual trials. Score: Total time (minutes).	16.4	11.8	7.7	7.7	11.4	6.9	μ SD	11.4 3.6	14.7 4.8
Speech Perception Test	Discrimination of nonword speech sounds. Score: Total errors.	4	2	0	2	5	3	μ SD MAX	4 3 0	5.5 2.5 0
Seashore Rhythm Test	Discrimination of nonverbal rhythms. Score: Number correct.	27	25	28	29	26	29	μ SD MAX	26 3 30	25.5 3 30
Finger Tapping Test	Measure of finger oscillation rate for 10-second period, both RT and LT hand trials. Score: Number taps per 10 seconds.	RT/LT 53/50	RT/LT 53/49	RT/LT 48/47	RT/LT 54/53	RT/LT 47/47	RT/LT 48/43	μ SD	50/43 6/6	44/39 11/10
Trail Making Test (Part A)	Requires connecting numbered circles in order from 1 to 25. Paper and pencil task. Score: Total times (seconds).	40	16	18	19	30	27	μ SD	26 11	33 9
Trail Making Test (Part B)	Requires connecting alphabetic and numbered circles by alternating 1-A-2-B, and so on. Score: Total time (seconds).	56	50	55	50	54	53	μ SD	62 16	79.5 31.0
Knox Cube Test	Measure of attention span and immediate visual memory. Score: Number correct.	13	14	13	16	17	17	μ SD MAX	13 4 18	13 4 18
Raven Progressive Matrices	Nonverbal intelligence test involving spatial matrices. Score: Number correct.	39	53	49	55	60	54	μ SD MAX	35 10 60	42 10 60
Verbal Concept Attainment Test	Requires abstraction of verbal conceptual relationships. Score: Number correct.	22	24	27	23	21	24	μ SD MAX	21 5.4 27	21 5.4 27
Buschke Memory Test	Requires learning a 20-word list in a maximum of 12 trials with repetition of words omitted after each trial. Score: Maximum number words correctly remembered; List: Number words consistently remembered.	Total: 14/20 List: 8/20	17/20	18/20	19/20	20/20	20/20	μ SD MAX	Total / List 18/12 3/2* 20/20	
Grooved Pegboard Test	Requires insertion of 25 pegs in their holes in a pegboard. Both RT and LT hand trials. Score: Total time (seconds).	RT/LT 76/74	RT/LT 69/70	RT/LT 58/67	RT/LT 59/67	RT/LT 72/70	RT/LT 48/50	μ SD	61/66 9/9	70/76 10/11
Spatial Relations Subtest of the PMA	Requires mental rotation and identification of figures rotated in two dimensions. Score: Number correct minus number of errors.	-	-	-	-	60	52	μ SD	28 14	28 14
Gottschaldt Hidden Figures Test	Requires tracing outline of simple figure hidden within lines of more complex figure. Score: Time and number correct.	Poor	Avg.	-	V. good	Outst.	Outst.	None Available		

*Approximate; Y, Age <35; O, Age ≥35.

UNCLASSIFIED

89

UNCLASSIFIED

intelligence as measured by the Wechsler Adult Intelligence Scale. All subjects were in the bright average to very superior range of intelligence with full scale IQ's ranging from 116 to 134, the average IQ being 125. Performance IQ's tended to be slightly higher than Verbal IQ's (126 average versus 123). All other test performances ranged widely from the mildly below average to the very superior range.

A consistent pattern of test results does emerge, however, when four of the subjects are looked at in a single group. These four subjects are S3 through S6. All tests which depended heavily on spatial abilities were extremely well performed by these subjects. The block design subtest of the WAIS is the most sensitive subtest to brain injuries which disrupt spatial abilities. Although these subjects obtained excellent WAIS scores in general, their near-perfect performances on this subtest are significantly better than most of the other subtest scores. The Tactual Performance Test (TPT) is also very sensitive to brain dysfunction involving spatial abilities. This test was extremely well performed by these subjects with three of them obtaining total times of 7.7 minutes or less. Times of less than eight minutes are very rarely achieved on this test. The TPT and block designs are two of the most sensitive tests to variations in spatial ability. A third test, the spatial relations subtest of the Primary Mental Abilities test, was given to only two of the four subjects in this group. Again, very superior scores (quotient scores greater than 130) were obtained by each. This test is not highly correlated with general intelligence, and high scores indicate special proficiency in visual-spatial ability.

Two additional tests which appear to measure general ability but which depend upon visual-perceptual ability for their correct performance were performed in the superior range. These are the Raven's Progressive Matrices and the Gottschaldt Hidden Figures.

Other test performances varied substantially among these four subjects. Three of the four had difficulty on the Category Test and on the Buschke Memory Test. No sensible interpretation of these results is readily apparent.

The two remaining subjects, S1 and S2, were quite different in their test performances from the above group. S2, who obtained the second highest full scale IQ, did well on the spatial tests described above but not as well as any of the four above. His spatial abilities appeared to be less well developed than his verbal skills. S1 was even less like the group than S2. His spatial test performances were only average for his age, and the TPT and Gottschaldt tests were poorly performed.

UNCLASSIFIED

In summary, the single, most compelling conclusion from the test data is that six subjects studied are of significantly above-average intellectual ability. In addition, there is consistent evidence that four of the six subjects were particularly proficient on measures of visual and tactual spatial ability. The performance of tests which measure this ability is most seriously impaired by lesions which involve the right, posterior cerebral hemisphere. There is more than presumptive evidence that normal performance of these tests is mediated by the right hemisphere. Therefore, at least four of the subjects obtained test results consistent with proficiency on these right hemisphere related tasks. It should be pointed out that this finding can be, at best, considered as a basis for hypothesis formation regarding paranormal ability. Verification of such hypotheses would depend on the results of future research.

The test results for S2 are not in conflict with the above interpretation. Those obtained for S1, however, are in conflict with this hypothesis and are not readily reconciled with it.

As pointed out above, further research is necessary to elucidate the relationship between spatial abilities, the right hemisphere and paranormal abilities. Nonetheless, it can be said at this point that many of the tasks performed by the group of subjects at SRI have at least a superficial resemblance to performances which require right hemisphere function. The similarities include the highly schematicized drawings of objects in a room or of remote scenes. Verbal identification of these drawings is often highly inaccurate, and the drawings themselves are frequently left-right reversed relative to the target configuration. Further, written material is generally not cognized. These characteristics have been seen in left brain-injured patients and in callosal sectioned patients.

More relevant, perhaps, than right hemisphere functioning per se are the resemblances to a class of functioning known as associative visual agnosia. Associative visual agnosia involves the inability of a patient to name or otherwise identify objects which he is capable of seeing. Such patients who do not have more generalized intellectual impairment are rare, and only a few have been described in the neurological literature. Several of these patients have demonstrated the ability to copy with pencil and paper the picture or object which they failed to name. It is this quality which impressed me as being similar to the remote viewing performances of the SRI subjects.

In a recent review of such cases¹⁰ five patients were found who had the ability to draw an object without being

UNCLASSIFIED

UNCLASSIFIED

able to name it. These are the patients reported by Mack et al. (1975)¹⁰, Albert et al. (1975)¹¹, Davidenkov (1956)¹², Rubens and Benson (1971)¹³, and Lhermitte and Beauvois (1973)¹⁴. Drawings and attempted namings of pictured material for one of the patients in the studies is shown in Figure 21.

In attempting to name an object, these patients would generally produce inappropriate names which, nevertheless, reflected some visual form characteristics of the object in question. Their attempts seem forced and made in piecemeal fashion to various characteristics of the picture rather than to the picture as a whole. In similar fashion Teuber's patient (1975)¹⁵ described the figure below as an apple with a worm and wormholes in it.



The above description and many of those in the references clearly illustrate that the patient sees the object and is able to respond to at least some of its visual characteristics. Most of the drawings in the references are sufficiently complete so that an observer would be able to name the object represented. Yet the author of the drawing cannot do this. This type of defective performance was frequently seen in the SRI subjects when they were producing drawings in the remote viewing experiments. Two obvious differences exist, however, between the patients with associative visual agnosia and the SRI subjects. The SRI subjects are able to name objects appropriately when pictures are presented directly to the visual modality. The patients cannot do this, and, in addition, these patients have a variety of other visual disabilities. The latter difference is to be expected since the patients have substantial brain injury.

The location of brain damage in associative visual agnosia is fairly well established. Two disconnections appear necessary in order to produce this symptom. One involves destruction of the left visual area as evidenced by the right homonymous hemianopia invariably found in these patients. The second involves isolation of the right visual area from speech areas in the left hemisphere. This can be the result of extensive destruction of left visual association areas or of damage to the posterior portion of the corpus callosum. The net result of these injuries is that objects can be seen because of visual input to the right hemisphere visual area but that they cannot be named because of isolation of this area from left hemisphere language areas. Use of these objects and the drawing of pictures of them can be accomplished because of intact pathways within the right hemisphere.

UNCLASSIFIED

UNCLASSIFIED

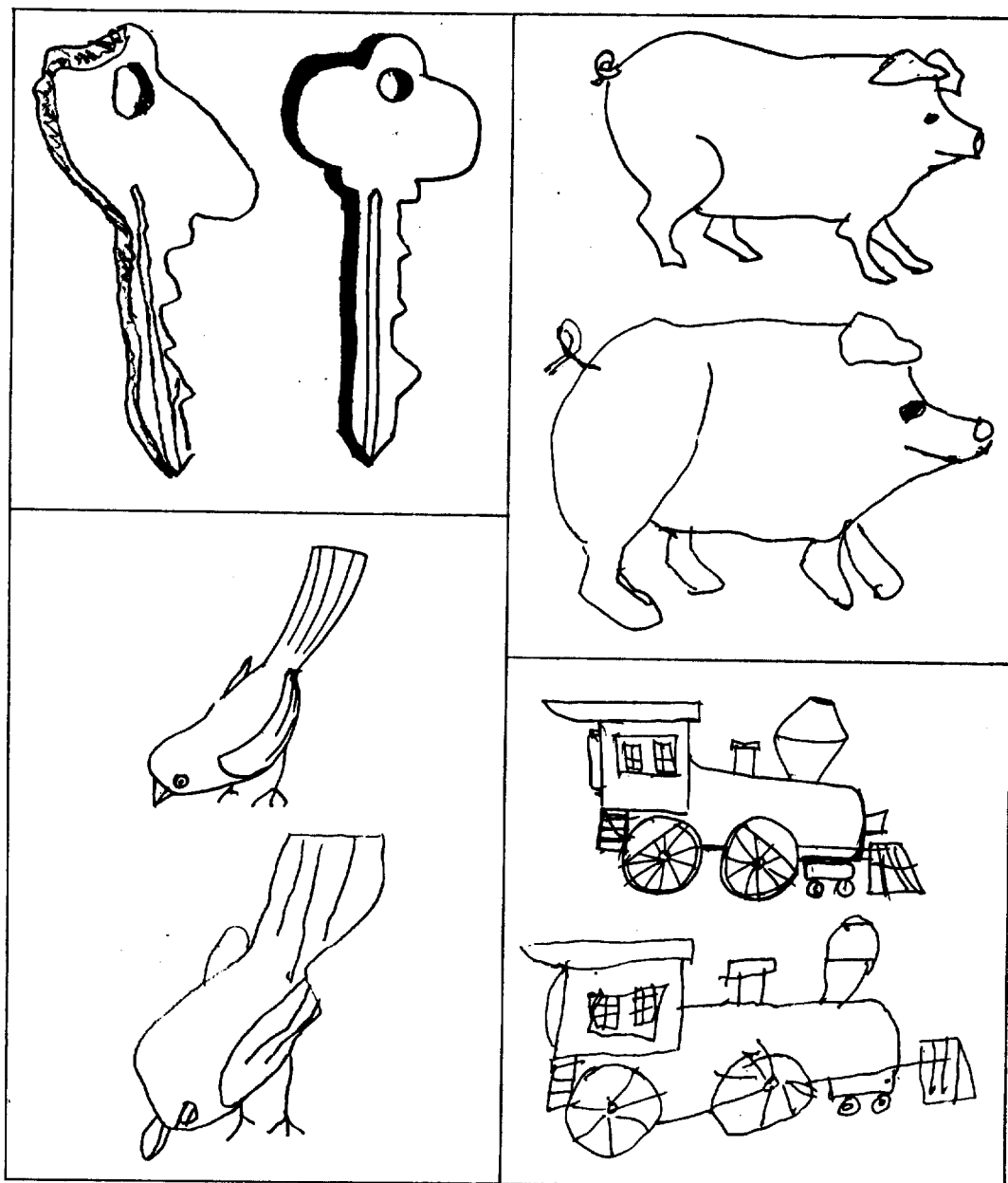

FIGURE 21 DRAWINGS AND INTERPRETATIONS BY ASSOCIATIVE VISUAL AGNOSIA PATIENTS

Copies of line drawings. Patient was unable to identify any before copying. After making copy, his identifications were top left, key - "I still don't know"; top right, pig - "Could be a dog or any other animal"; bottom left, bird - "Could be a beach stump"; bottom right, locomotive - "A wagon or a car of some kind. The larger vehicle is being pulled by the smaller one."

UNCLASSIFIED

UNCLASSIFIED

It remains to speculate on the meaning of the similarity between the patients described above and the SRI subjects. It should first be noted that the similarities are more than superficial in that the verbal descriptions attempted by some of the SRI subjects bear a striking resemblance in kind to those of the patient shown in Figure 21. It is as if they are struggling with similar difficulties in verbalizing the image which they can readily draw. In this regard the lateralization involved is consistent with other indications of right hemisphere function in the SRI subjects. A highly speculative hypothesis is that during remote viewing the subjects "see" a grossly degraded image which is not distinct enough to encode directly into a verbal label. Hence the piecemeal verbalization similar to that found in patients with associative visual agnosia.

In summary, it would appear that the neuropsychological data are compatible with the hypotheses that (1) information received in a putative remote viewing mode is processed piecemeal in pattern form (consistent with a low bit rate process but not necessarily requiring it) and (2) the errors arise in the processes of attempted integration of the data into larger patterns directed toward verbal labeling.

C. Identification of Neurophysiological Correlates That Relate to Paranormal Activities

This part of the program had as its goal the identification of neurophysiological correlates of paranormal activity. The existence of such correlates is hypothesized on the expectation that, in addition to obtaining overt responses such as verbalizations or key presses from a subject, it should be possible to obtain objective evidence of information transfer by direct measurement of some physiological parameter of a subject. Kamiya, Lindsay, Pribram, Silverman, Walter, and others brought together to discuss physiological methods to detect ESP functioning, for example, have suggested that a whole range of electroencephalogram (EEG) responses--such as evoked potentials (EPs), spontaneous EEG, and the contingent negative variation (CNV)--might be sensitive indicators of the detection of remote stimuli not mediated by usual sensory processes.¹⁶

The purpose of this part of the study was twofold: (a) to obtain information about the neurophysiological state associated with paranormal

UNCLASSIFIED

~~UNCLASSIFIED~~

activity in general, and (b) to determine whether physiological correlates could be used as an indicator of paranormal functioning, hopefully to provide indicators that differentiate between correct and incorrect responses to a paranormally applied stimulus so that an independently-determined bias factor could be applied during the generation of data by a subject.

Early experimentation of this type was carried out by Douglas Dean at the Newark College of Engineering. In his search for physiological correlates of information transfer, he used the plethysmograph to measure changes in the blood volume in a finger, a sensitive indicator of autonomic nervous system functioning.¹⁷ A plethysmographic measurement was made on the finger of a subject during paranormal communication experiments. A sender looked at randomly selected target cards consisting of names known to the subject, together with names unknown to him (selected at random from a telephone book). The names of the known people were contributed by the subject and were to be of emotional significance to him. Dean found significant changes in the chart recording of finger blood volume when the remote sender was looking at those names known to the subject as compared with those names randomly chosen.

Two other early experiments using the physiological approach were also published. The first work by Tart¹⁸ and the later work by Lloyd¹⁹ both follow a similar pattern. Basically, a subject is closeted in an electrically shielded room while his EEG is recorded. Meanwhile, in another laboratory, a second person is stimulated from time to time, and the time for that stimulus is marked on the magnetic tape recording of the subject's EEG. The subject does not know when the remote stimulus periods occur.

At SRI three facilities are in use for the purpose described above. One is a standard EEG facility under the direction of Dr. Charles Rebert, Life Sciences Division. This facility consists of a visually opaque, acoustically and electrically shielded, double-walled steel room, as shown in Figure 22, a Grass Model 5 polygraph, and an Ampex

~~UNCLASSIFIED~~

UNCLASSIFIED



GA-2613-14

FIGURE 22 SHIELDED ROOM USED FOR EEG EXPERIMENTS

UNCLASSIFIED

UNCLASSIFIED

SP-300 magnetic tape recorder. The second facility is a standard EEG facility under the direction of Dr. Jerry Lukas, head of SRI's Sleep Studies program. This facility consists of two sound-isolated rooms with appropriate signal lead connections, an eight-channel polygraph for recording visually, and a magnetic tape/computer processing/printer readout that provides on-line processing of the polygraph data. In our configuration we obtain a hardcopy printout of five-second averages of eight channels of polygraph information 15 minutes following a 15-minute run. At present we monitor broad band alpha (7 to 14 Hz) and beta (14 to 34 Hz) brainwave components from the left and right occipital regions, galvanic skin response, and two channels of plethysmograph data (blood volume and pulse height).

The third facility is a smaller, semiportable four-channel polygraph with a GSR channel, reflected-light plethysmograph indicating blood volume/pulse height, one channel of unfiltered EEG activity, and a fourth EEG channel with zero-crossing digital filtering. The last permits percent-time measurements in any band, with upper and lower band edge settings in one-hertz increments.

Two lines of investigation were pursued in the SRI program. The first was basic in nature, an effort to determine whether, in a repeatable experiment under laboratory conditions, the remote viewing of a specific stimulus (strobe light in another laboratory) would provide any evidence of EEG correlates. The second involved mid-experiment monitoring of a number of physiological parameters during routine experimentation in remote viewing.

1. Remote Strobe Experiment

The following is a description of the first line of experimentation, the remote viewing of a strobe light stimulus. With regard to choice of stimulus, it was noted that in previous work others had attempted, without success, to detect evoked potential changes in a subject's EEG in response to a single flash stimulus observed by another subject.²⁰ In a discussion of that experiment, Kamiya suggested that because of the unknown temporal characteristics of the information channel, it might be more appropriate to use repetitive bursts of light

UNCLASSIFIED

UNCLASSIFIED

to increase the probability of detecting information transfer.²¹ Therefore, in our study we chose to use a stroboscopic flash train of ten seconds duration as the remote stimulus.

In the design of the study, we assumed that the application of the remote stimulus would result in responses similar to those obtained under conditions of direct stimulation. For example, when an individual is stimulated with a low-frequency (< 30 Hz) flashing light, the EEG typically shows a decrease in the amplitude of the resting rhythm and a driving of the brain waves at the frequency of the flashes.²² We hypothesized that if we stimulated one subject in this manner (a putative sender) the EEG of another subject in a remote room with no flash present (a receiver) might show changes in narrow band alpha (9 to 11 Hz) activity and possibly an EEG driving similar to that of the sender, either by coupling to the sender's EEG,²³ or by coupling directly to the stimulus.

We informed our subject (S4) that at certain times a light was to be flashed in a sender's eyes in a distant room, and if the subject perceived that event, consciously or unconsciously, it might be evident from changes in his EEG output. The instructions to the subject are in accordance with requirements governing activities with human subjects (see Appendix B). The receiver was seated in the visually opaque, acoustically and electrically shielded double-walled steel room shown in Figure 22. The sender was seated in room about seven meters from the receiver.

A Grass PS-2 photostimulator placed about one meter in front of the sender was used to present flash trains of ten seconds duration. The receiver's EEG activity from the occipital region (Oz), referenced to linked mastoids, was amplified with a Grass 5P-1 preamplifier and associated driver amplifier with a bandpass of 1 to 120 Hz. The EEG data were recorded on magnetic tape with an Ampex SP 300 recorder.

On each trial, a tone burst of fixed frequency was presented to both sender and receiver and was followed in one second by either a ten second train of flashes or a null flash interval presented to the sender. Thirty-six such trials were given in an experimental session, consisting

UNCLASSIFIED

UNCLASSIFIED

of 12 null trials--no flashes following the tone--12 trials of flashes at 6 fps and 12 trials of flashes at 16 fps, all randomly intermixed, determined by entries from a table of random numbers. Each of the trials generated an 11 second EEG epoch. The last 4 seconds of the epoch was selected for analysis to minimize the desynchronising action of the warning cue. This 4 second segment was subjected to Fourier analysis on a LINC 8 computer.

Spectrum analyses gave no evidence of EEG driving in any receiver, although in control runs the receivers did exhibit driving when physically stimulated with the flashes.

Data from seven sets of 36 trials each were collected from the subject on three separate days. This comprises all the data collected with this subject under the test conditions described above. The alpha band was identified from average spectra, then scores of average power and peak power were obtained from individual trials and subjected to statistical analysis.

Figure 23 shows an overlay of the three averaged spectra from one of the subject's 36-trial runs, displaying differences in alpha activity for the three stimulus conditions.

Mean values for the average power and peak power for each of the seven experimental sets are given in Table 20. The power measures were less in the 16 fps case than in the 0 fps in all seven peak-power measures and in six out of seven average-power measures. Note also the reduced effect in the case in which the subject was informed that no sender was present (Run 3). It seems that overall alpha production was reduced for this run in conjunction with the subject's expressed apprehension about conducting the experiment without a sender. This is in contrast to the case (Run 7) in which the subject was not informed.

Siegel's two-tailed t approximation to the nonparametric randomization test²⁴ was applied to the data from all sets, which included the two sessions in which the sender was removed. Average power on trials associated with the occurrence of 16 fps was significantly less (-24%) than when there were no flashes ($t = 2.09$, $d.f. = 118$, $P < 0.04$).

UNCLASSIFIED

UNCLASSIFIED

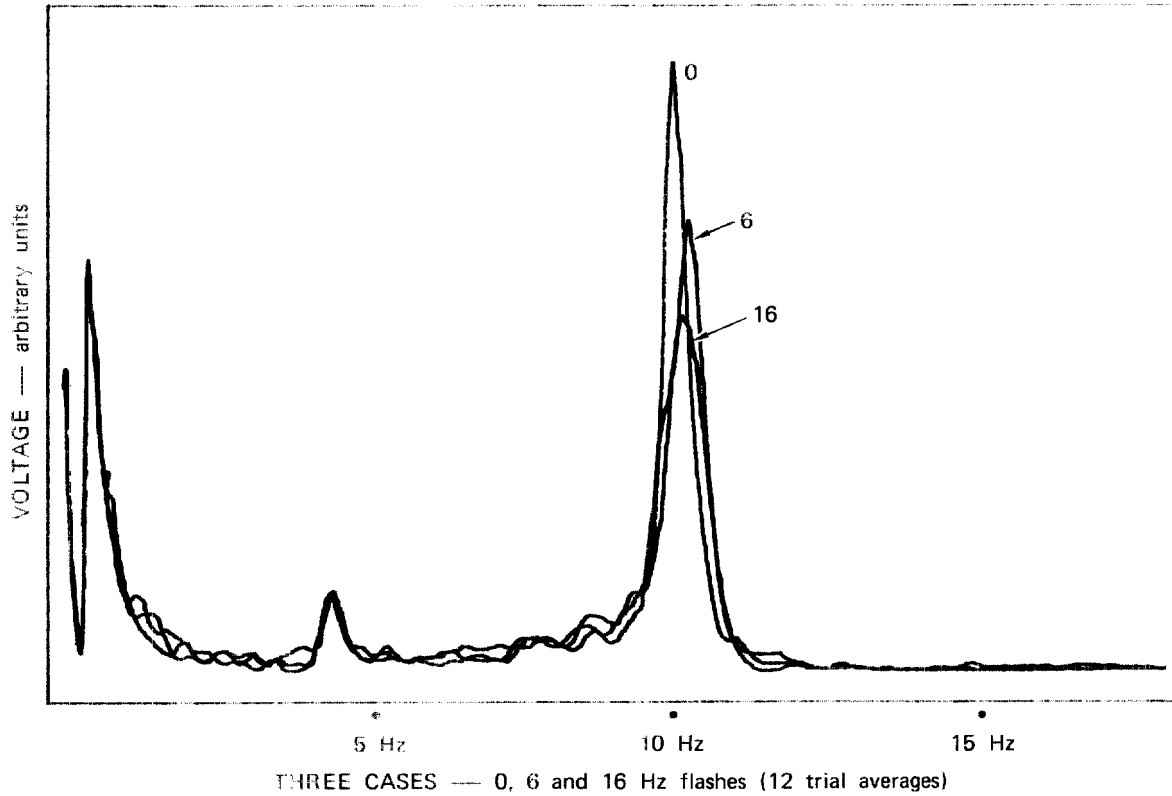

DA-2613-15

FIGURE 23 OCCIPITAL EEG FREQUENCY SPECTRA, 0 TO 20 Hz, OF SUBJECT S4 ACTING AS RECEIVER, SHOWING AMPLITUDE CHANGES IN THE 9 TO 11-Hz BAND AS A FUNCTION OF STROBE FREQUENCY

UNCLASSIFIED

TABLE 20
 EEG Data for Subject S4 Showing Average Power and Peak Power in the
 9- to 11-Hz Band, as a Function of Flash Frequency and Sender.
 (Each Table Entry is an Average Over 12 Trials)

Sender \ Flash Frequency	Average Power			Peak Power		
	0	6	16	0	6	16
J.L.	94.8	84.1	76.8	357.7	329.2	289.6
R.T.	41.3	45.5	37.0	160.7	161.0	125.0
No Sender (Subject informed)	25.1	35.7	28.2	87.5	95.7	81.7
J.L.	54.2	55.3	44.8	191.4	170.5	149.3
J.L.	56.8	50.9	32.8	240.6	178.0	104.6
R.T.	39.8	24.9	30.3	145.2	74.2	122.1
No Sender (Subject not informed)	86.0	53.0	52.1	318.1	180.6	202.3
Averages	56.8	49.9	43.1	214.5	169.8	153.5
		-12%	-24%		-21%	-28%
		(p < .04)			(p < .03)	

UNCLASSIFIED

101

UNCLASSIFIED

The second measure, peak power, was also significantly less (-28%) in the 16 fps conditions than in the null condition ($t = 2.16$, d.f. = 118, $P < 0.03$). The average response in the 6 fps condition was in the same direction as that associated with 16 fps (-12% in average power, -21% in peak power) but the effect did not reach statistical significance.

As part of the experimental protocol, the subject was asked to indicate a conscious assessment for each trial (via telegraph key) as to the nature of the stimulus; analysis showed these guesses to be at chance. Thus, arousal as evidenced by significant alpha blocking occurred only at the noncognitive level of physiological response. Hence, the experiment provided direct physiological (EEG) evidence of perception of remote stimuli even in the absence of overt cognitive response.

Several control procedures were undertaken to determine if these results were produced by system artifacts or by subtle cueing of the subject. Low-level recordings were made from saline of 12 k Ω resistance in place of the subject, with and without the introduction of 10-Hz, 50- μ V signals from a battery-operated generator. The standard experimental protocol was adhered to and spectral analysis of the results was carried out. There was no evidence in the spectra of activity associated with the flash frequencies, and the 10-Hz signal was not perturbed by the remote occurrence flicker.

In another control procedure, a 5-ft pair of leads was draped across the subject's chair (subject absent). The leads were connected to a Grass P-5 amplifier via its high-impedance input probe. The bandwidth was set 0.1 Hz to 30 KHz with a minimum gain of 200,000. The output of the amplifier was connected to one input of a C.A.T. 400C "averager." Two-second sweeps, triggered at onset of the tone, were taken once every 13 seconds for approximately two hours, for about 550 samples. No difference in noise level between the fore period and the onset of flicker was observed.

Finally, no sounds associated with flicker could be detected in the receiver's chamber.

Three further experimental runs were carried out in the sleep lab under the direction of Dr. Lukas, this time with monitoring of

UNCLASSIFIED

right and left occipital regions. Each experiment consisted of 20 15-second trials, with 10 no-flash trials, and 10 16-Hz trials randomly intermixed. Reduction of alpha activity (arousal response) correlated with remote stimuli was observed as in previous experiments, but essentially only in the right hemisphere (average alpha reduction 16% in right hemisphere, 2% in left, during the 16-Hz trials as compared with the no-flash trials). This tends to support the hypothesis that par-normal functioning might involve right hemispheric specialization, but the sample is too small to provide confirmation without further work.

In comparing the results of our work with that of others, we note that whereas in our experiments we used a remote light flash as a stimulus, Tart¹⁸ in his work used an electrical shock to himself as sender, and Lloyd¹⁹ simply told the sender to think of a red triangle each time a red warning light was illuminated within his view. Lloyd observed a consistent, evoked potential in his subjects; whereas in our experiments and in Tart's, a reduction in amplitude and a desynchronization of alpha was observed, an arousal response. (If a subject is resting in an alpha-dominant condition and he is then stimulated, for example in any direct manner, one will observe a decrease and desynchronization in alpha power.) We consider that these combined results thus provide evidence for the existence of noncognitive awareness of a remote stimulus, and the EEG procedures described appear to be sensitive techniques for detecting the occurrence of such information transfer, even in the absence of overt cognitive response, at least when used to detect discrete arousing stimuli.

2. Mid-Experiment Monitoring of Physiological Parameters During Routine Experimentation in Remote Viewing

In this series of experiments measurements were obtained during a random selection of seven remote viewing experiments. The subject was connected to the physiological recording instruments of the smaller, semiportable four-channel polygraph described above. Baseline and experimental measures of the following observables were made:

UNCLASSIFIED

UNCLASSIFIED

- (1) Galvanic skin response (GSR) was recorded using finger electrodes taped in place on second and fourth fingers
- (2) Blood volume/pulse height was recorded using a reflected-light plethysmograph
- (3) Unfiltered EEG was recorded from the right occipital region
- (4) Percent-time in alpha (8 to 12 Hz) was recorded on the fourth channel; the alpha filter was a sharp cutoff digital type with essentially zero-pass outside the prescribed bandpass limits.

A sample chart record is shown in Figure 24. (Time runs from right to left.) The traces, top to bottom, are the unfiltered EEG, blood volume/pulse height, GSR, and filtered (alpha) EEG.

During the course of an experiment, the subject was asked to describe his perceptions as to the nature of the remote target. His comments were tape-recorded and noted on the polygraph, along with the time. A correlation was then attempted between those descriptions that were found to be uniquely correct and accurate, and the corresponding sections of polygraph recording.

Seven experiments of this type were carried out. In our investigations we did not find any significant correlations between the observed physiological parameters and the indicators of accuracy in the data.

The failure to observe any physiological correlates of a putative "state" associated with paranormal functioning thus parallels the similar failure to observe any physiological correlates of the putative hypnotic state reported by others. In a survey of the major literature on hypnosis by Sarbin and Slagle, entitled "Hypnosis and Psychophysiological Outcomes"²⁵, they cataloged experiments dealing with measurements of heart rate, hemodynamics and vasomotor functioning, genitourinary functions, gastrointestinal functions, endocrine and metabolic functions, cutaneous functions, dermal excretions, skin temperature, electrodermal changes, evoked potentials, spontaneous EEG activity, rapid eye movements, slow eye movements, optokinetic nystagmus, changes

UNCLASSIFIED

UNCLASSIFIED

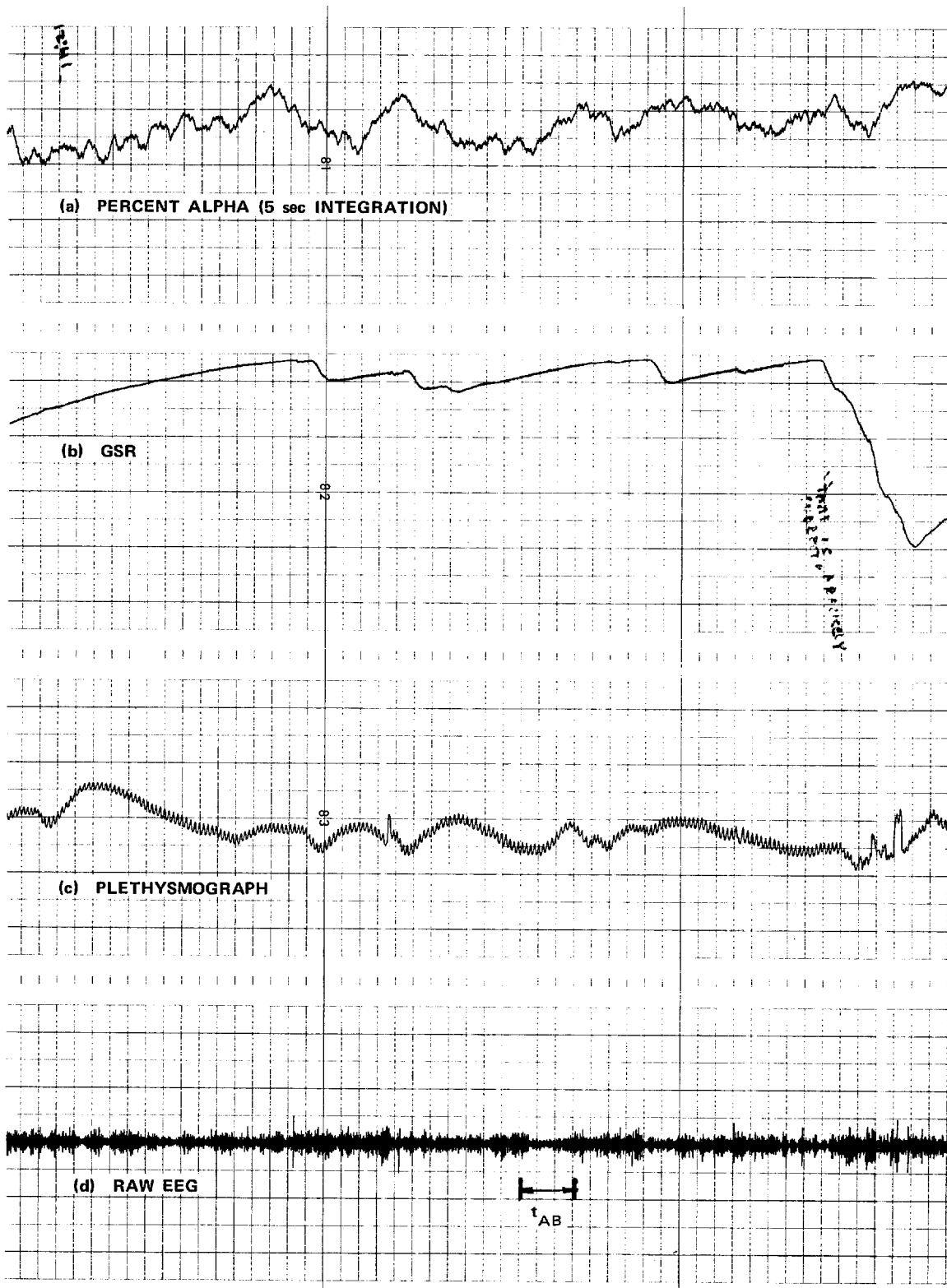

SA-3183-10

FIGURE 24 POLYGRAPH DATA

Correct verbal description given during time interval t_{AB} .

UNCLASSIFIED

in pupillary diameter, and ocular anatomy. Their conclusion is that "there is no evidence for a physiological process that could serve as an independent criterion of the postulated hypnotic state." Similarly, we found no evidence in the physiological processes that we monitored that could serve as an indicator of the postulated paranormal state beyond the general EEG arousal response observed for discrete stimulus conditions.

D. Identification of the Nature of Paranormal Phenomena and Energy

This portion of the program was devoted to efforts to understand the nature and scope of paranormal phenomena, including investigation of the physical laws underlying the phenomena.

1. Experiments with Physical Apparatus

a. Experiments with Geiger Counter

A series of experiments were conducted with subject S1 to determine whether a Geiger counter in the γ -ray mode (i.e., beta shield in place) would register subject-directed efforts.

The output of a Geiger counter,* fed into a Monsanto Model 1020 counter/timer, indicated that the background count due to cosmic rays was approximately 35 counts/minute. Experimental protocol required the subject to try to change the registered count by concentration on the Geiger counter probe from a distance of about 0.5 m. Each run consisted of 15 60-s trials, with 10-s separations between the trials. Preceding each run was a control run of equal duration.

The results, shown in Table 21, indicate no effect of statistical significance, either in the mean or standard deviation of counts.

Table 21

GEIGER COUNTER EXPERIMENT SUMMARY

Run	Control Runs		Experimental Runs	
	Mean	Standard Deviation	Mean	Standard Deviation
1	36.07	5.73	35.33	6.00
2	34.87	6.23	33.87	7.27
3	33.87	5.88	34.00	5.25
4	35.20	5.09	35.67	5.77

* OCDM Item No. CD V-700, Model No. 66, Electro-Neutronics, Inc., Oakland, California.

UNCLASSIFIED

b. Experiments with Laser-Monitored Torsion Pendulum

In this series of experiments we examined the possibility that a subject may be able to exert a physical influence on a remotely located mechanical system. The target was a torsion pendulum suspended by a metal fiber inside a sealed glass bell jar. The pendulum consists of three 100-g balls arranged symmetrically at 120° angles on a 2-cm radius. The entire apparatus is shock mounted, and protected from air currents by the bell jar.

The angular position of the pendulum is measured by means of an optical readout system. The system consists of a laser beam from a low-power argon laser* reflected from a small mirror on the pendulum onto a position-sensing silicon detector† 1.5 m from the pendulum. The detector yields an output voltage proportional to spot position. The output from the detector is monitored by a chart recorder‡, which provides a continuous sine wave record of pendulum position.

The system exhibits a sensitivity of approximately 10 μ rad. Under typical experimental conditions, random acoustical fluctuations drive the pendulum in its torsional normal mode of 10-s period to a level ~100 μ rad angular deviation. During control runs the pendulum executes harmonic motion with a maximum variation in amplitude of $\pm 10\%$ over an hour period. Sudden vibrational perturbations in the environment (artifacts) produce oscillation of the pendulum in the vertical plane at 0.1 Hz.

The subject is asked, as a mental task, to affect the pendulum motion, the results of which are available as feedback from the chart recorder. The subject is then encouraged to work with the pendulum from a distance of 1 m, observing effects being produced. If satisfied that there is a possibility of producing effects, the subject is removed to a room 22 m down the hall with three intervening office spaces to determine whether effects can be produced from a remote location. The subject is provided feedback at the remote location either by closed circuit video or by a second chart recorder in parallel with

* Spectra Physical Model 262.

† United Detector Technology Model SC/10.

‡ Brush Model Mark 200.

UNCLASSIFIED

UNCLASSIFIED

the recorder in the enclosed target laboratory. The remote aspect was instituted both to prevent artifactual effects from body heat, motion, and the like, and also to determine whether energy can be coupled via the remote-viewing channel to a remote location.*

In an experiment, timing of subject efforts to increase or decrease oscillation amplitude are determined by an experimenter utilizing a randomization protocol described in Appendix C. Each experiment lasts one hour and consists of six five-minute work periods alternated with six five-minute rest periods.

Although there appeared to be some evidence in pilot studies that a subject could, by concentration, increase or decrease pendulum motion on command, data taken in three controlled experiments produced 11 changes in the correct direction out of 18 tries, a result nonsignificant at $p = 0.24$ by exact binomial calculation.

c. Experiments with Superconducting Differential Magnetometer (Gradiometer)

One of the first psychoenergetically produced physical effects observed by SRI personnel in early research (1972) was the apparent perturbation of a Josephson effect magnetometer.²⁷ The conditions of that pilot study, involving a few hours use of an instrument committed to other research, prevented a proper investigation. The number of data samples was too few to permit meaningful statistical analysis, and the lack of readily available multiple recording equipment prevented investigation of possible "recorder only" effects.

At the suggestion of the sponsor, a series of experiments was carried out using the superconducting second-derivative gradiometer† shown in Figure 25.

* Both experimental evidence and theoretical work indicate that distance may not be a strong factor in paranormal phenomena. See, for example, "Foundations of Paraphysical and Parapsychological Phenomena," by E.H. Walker, U.S. Army Ballistic Research Laboratories, Aberdeen Proving Ground, Maryland.²⁶

† Develco Model 8805, Develco, Inc., Mountain View, California.

UNCLASSIFIED

UNCLASSIFIED

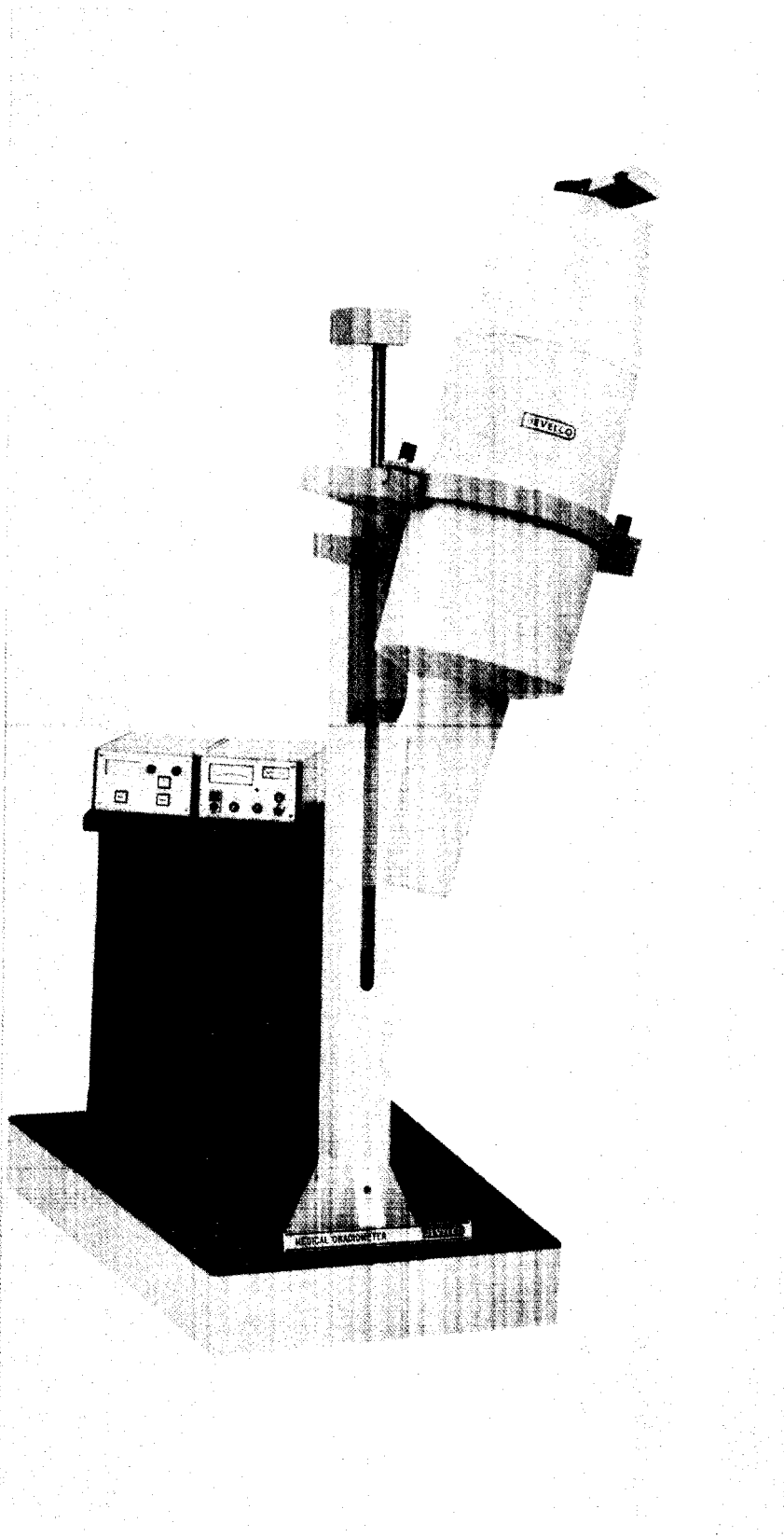

FIGURE 25 SUPERCONDUCTING DIFFERENTIAL MAGNETOMETER

UNCLASSIFIED

UNCLASSIFIED

Basically, the gradiometer is a four-coil Josephson effect magnetometer device consisting of a pair of coil pairs wound so as to provide a series connection of two opposing first-derivative gradiometers, yielding a second-derivative gradiometer (that is, a device sensitive only to second- and higher-order derivative fields). As a result, the device is relatively insensitive to uniform fields and to uniform gradients. This arrangement allows for sensitive measurement of fields from nearby sources while discriminating against relatively uniform magnetic fields produced by remote sources. The device is ordinarily used to measure magnetic fields originating from processes within the human body, such as action currents in the heart that produce magnetocardiograms. The sensitive tip of the instrument is simply placed near the body area of interest.

In our application, however, the subject is located in an adjoining laboratory at a distance of 4 m from the gradiometer probe. As a result the subject is located in a zone of relative insensitivity; for example, standing up, sitting down, leaning forward, and arm and leg movements produce no signals. From this location the subject is asked, as a mental task, to affect the probe. The results of his efforts are available to him as feedback from three sources: an oscilloscope, a panel meter, and a chart recorder, the latter providing a permanent record.

A protocol for subject participation was instituted as follows. The subject removes all metal objects from his clothing and body, and the effects of body movements are checked at the start of each experimental period. The subject then works with the machine in a learning mode, observing effects being produced, if any, via feedback from the instrumentation. Once satisfied that a possibility exists of producing effects on command under experimenter control, the experimenter announces the start of the experiments. A randomization protocol (discussed in Appendix C) is then used to generate ten ON (subject activity) and OFF (subject no activity) periods of equal length (e.g., 25 s each as determined by the experimenter).

UNCLASSIFIED

UNCLASSIFIED

The trace from the chart recording of a sample run (Run 1, Subject S1) is shown in Figure 26. The randomly generated ON (activity) trials occurred in periods 2, 8, and 9. As observed, signals appear in each of these three periods. The signal appearing in period 9 was strong enough to cause loss of continuous tracking. This latter type of signal can be the result of an exceptionally strong flux change or an RF burst, whether subject-generated or artifactual*, and is handled on the basis of statistical correlation as discussed below. An artifact due to the passage of a truck in the parking lot adjacent to the laboratory (under continuous surveillance by the experimenter) is noted in period 6. The signals recorded in periods 2 and 8 correspond to an input of approximately 1.6×10^{-9} Gauss/cm² (second derivative $\partial^2 B_z / \partial Z^2$), which is equivalent to approximately 3.5×10^{-7} Gauss referred to one pickup coil.

The interpretation of such observations must be subjected to careful analysis. For example, the emphasis on "corresponds to" is based on the following: although the probe is designed to register magnetic fields, and the simplest hypothesis is that an observed signal is such, in a task as potentially complex as willed perturbation effects one must be cautious about assigning a given observed effect to a specific cause. One can only conclude that generation of a magnetic field is the most probable cause, without presuming to identify a particular source. With regard to signal display, the signal was observed simultaneously on three recording devices at different stages of the electronics, and thus a "recorder only" effect can be considered low probability, although an electronics interference effect ahead of all display cannot be ruled out. We therefore treat the magnetic cause as tentative, although most probable, and concentrate our attention on whether a correlation exists between system disturbances and subject efforts.

Thirteen ten-trial runs were obtained with S1. Each of the ten trials in the run lasted 50 seconds†, the activity/no-activity

* RF interference effects are sometimes in evidence due to noise bursts from other instrumentation.

† With the exception of the first run where 25-second trials were used.

UNCLASSIFIED

UNCLASSIFIED

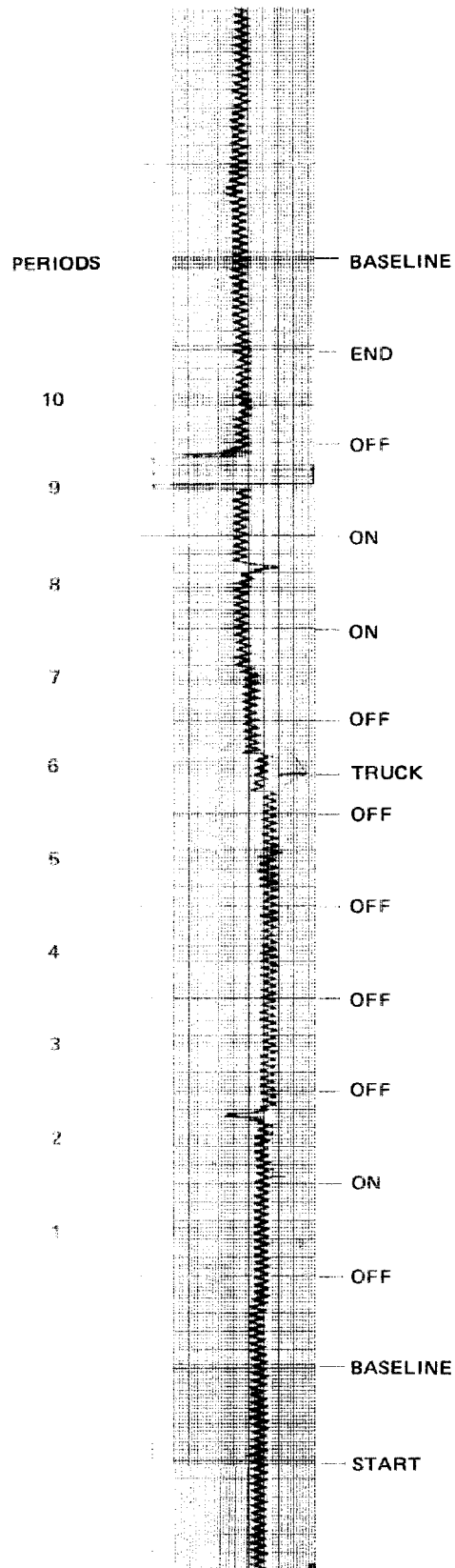

FIGURE 25 GRADIOMETER DATA

UNCLASSIFIED

UNCLASSIFIED

command for each trial being identified by the randomization technique discussed in Appendix C. In the $13 \times 10 = 130$ trials, consisting of a random distribution of 64 activity and 66 no-activity periods, 63 events of signal-to-noise ratio greater than unity were observed. Of these 63 events, 42 were distributed among the activity periods, 21 among the no-activity periods, a correlation significant at the $p = 0.004$ level.

Subjects S2 and S6 also interacted with the device. Although subject efforts and observed perturbations sometimes coincided, activity was generally low and did not appear to be the signature of correlated activity under control. A controlled ten-trial run with Subjects S2 and two such runs with Subject S6 yielded nonsignificant results.

We therefore conclude that for Subject S1 the observed number of precisely timed events in pilot work coupled with the statistically significant ($p = 0.004$) correlation between subject effort and signal output in controlled runs indicate a highly probable cause-effect relationship. Thus it appears that a subject can interact with a second derivative magnetic gradiometer of sensitivity on the order of 10^{-9} Gauss/cm² from a distance of 4 m. Further work would be required to determine the precise nature of the interaction, although given the equipment design the generation of a magnetic field is the most probable mechanism.

A successful independent replication of this experiment has been carried out by Dr. Richard Jarrard, Geology Department, University of California, Santa Barbara, using a single-coil cryogenic magnetometer.* The experiments, carried out with the subject in a room located 50 ft diagonally across a courtyard from the magnetometer room, resulted in events distributed across work and rest periods in ratio $>3:1$, respectively, paralleling our results.²⁸

d. Discussion of Physical Perturbation Effects

One significance of the perturbation of remote sensitive equipment lies in the indication that the remote-sensing channel may

* Superconducting Technology Cryogenic Magnetometer.

UNCLASSIFIED

UNCLASSIFIED

possess a bilateral aspect. That is, there is the possibility that an information-bearing signal can be coupled from an individual to a remote location as well as in reverse, thus implying that the information channel under consideration may sustain information transfer in either direction.

The above concept has a rigorous basis in quantum theory in the so-called "observer problem," the effect of an observer on experimental measurement. In quantum theory it is recognized that although the evolution of a physical system proceeds deterministically on the basis of Schrodinger's equation (or its equivalent), the result of a calculation is not in general the prediction of a well-defined value for some experimental variable. Rather, it is the prediction of a range of possibilities with a certain distribution of probabilities. In a given measurement, however, some particular value for a variable is actually obtained, which implies that an additional event--so-called state vector collapse--must take place during the measurement process itself and in a manner that is unpredictable except probabilistically. Analysis of the significance of this latter process leads inescapably to the conclusion that to the degree that consciousness is involved in observation and measurement (and it always is), to that degree consciousness must also be seen to interact with the physical environment and to participate in the collapse of the state vector. Efforts to extract quantum theory from this conclusion by, for example, an infinite regression of measuring apparatus, have proved unsuccessful. These conclusions, arrived at by theorists such as Wigner,²⁹ imply the possibility of nontrivial coupling between consciousness and quantum states of the physical environment at an extremely fundamental level. Such a realization has led to theories of paranormal phenomena modeled on the basis of this so-called "observer problem" in quantum theory.²⁶

The phenomena implied by the observer problem are generally unobservable on the gross macroscopic scale for statistical reasons. This is codified in the thermodynamic concept that for an isolated system entropy (disorder) on the average increases, effectively masking the microscopic observer effects. It is just this requirement of

UNCLASSIFIED

UNCLASSIFIED

isolation, however, that can be expected to be weakened under conditions of efforts at paranormal perturbation via the remote-sensing channel, and it can be argued that observer effects would be maximally operative in just those situations where the intrusion of consciousness as an ordering phenomenon could result in a significant local reversal of entropy increase.

These considerations lead to the following series of conceptualizations or hypotheses around which future experiments can be designed.

(1) Researchers in the area of willed perturbation effects appear to be plagued by results whose amplitudes have a signal-to-noise ratio near unity, regardless of the process or mechanism involved. This may indicate that, rather than simple perversity, what is being articulated by the experimental results is a coherence phenomena involving partial mobilization of system noise, as if the components of the noise spectrum had been brought into phase coherence, and thus the magnitude constraint. The subject would thus appear to act as a local negentropic (that is, entropy-decreasing) source. If true, it may be more advantageous as a practical matter to work with extremely noisy systems, rather than with highly constrained or organized systems, so as to maximize possible effects due to the introduction of order.

(2) Willed perturbation effects often appear to be more the result of coincidence than the effect of a well-defined cause. Again, rather than being the result of the perversity of nature, the observed goal-oriented synchronicity may indicate that physical systems are more easily manipulated

UNCLASSIFIED

UNCLASSIFIED

at the global level of boundary conditions and constraints rather than at the level of mechanism. Thus, the apparency that a given result may be explained away by a coincidental but "natural" event needs to be explored more fully. Unexpected but natural causes may be the effect of a series of causal links, outside the defined experimental boundaries but representing an unforeseen line of least resistance. At worst, such causal links may in fact be unobservable in the sense of the hidden variables concept in quantum theory, but nevertheless act as instruments of the will.

(3) Willed perturbation effects appear to be intrinsically spontaneous; i.e., it is difficult to evoke such effects "on cue," with the result that the phenomenon is often considered to not be under good control, and therefore not amenable to controlled experimentation. This difficulty is so pronounced that it is likely that we are observing some macroscopic analog of a quantum transition, an event similarly unpredictable in time except as a probability function. If the analogy is correct, experimentation in this area simply needs to be treated in the manner of, for example, weak photon experiments.

(4) Possibly related to Item (3), the more closely one attempts to observe willed perturbation effects, the less likely one is to see them, a factor considered by many to support hypotheses of poor observation, fraud, and the like. To a sophisticated observer, however, simple dismissal does

UNCLASSIFIED

not stand up under scrutiny. Invoking again the idea of a microscopic analog of a quantum transition, we may, as observers of delicate phenomena, be witnesses to observer effects generally associated with the uncertainty principle. Paradoxically, from the subject's viewpoint, the production of the phenomena may also be an observer effect, perturbing as it does the expected behavior of a piece of instrumentation. In this model the scrutiny of psychokinetic phenomena under laboratory conditions could in principle be considered to be a collective phenomena involving interfering observer effects in a manner known to occur at the microscopic quantum level.

(5) Finally, it may be useful as a guiding principle to continually recognize that all of the phenomena we deal with in macroscopic psychoneuroenergetics are totally permissible at the microscopic level within the framework of physics as presently understood. It is simply that time reversibility, tunneling through barriers, simultaneous multiple-state occupation, and so on are generally unobservable as gross macroscopic phenomena for statistical reasons only, as codified in the concept of increasing disorder (entropy). Therefore, it may be appropriate to consider an individual with psychokinetic abilities primarily as a source of ordering phenomena of sufficient magnitude so as to restructure the otherwise random statistics of the macroscopic environment.

2. Discussion of Possible "Mechanisms" in Remote Viewing

With regard to the wider problem of the remote-viewing channel itself, beyond the specific aspects of equipment perturbation via

UNCLASSIFIED

this channel there is considerable current interest in quantum theory in the implications brought on by the observation^{30,31} of nonlocal correlation or "quantum interconnectedness" (to use Bohm's term³²) of distant parts of quantum systems of macroscopic dimensions. Bell's theorem³³ emphasizes that no theory of reality compatible with quantum theory can require spatially separated events to be independent,³⁴ but must permit interconnectedness of distant events in a manner that is "contrary" to "commonsense" concepts.^{35,36} This prediction has been experimentally tested and confirmed in the recent experiments of, for example, Freedman and Clauser.^{30,31} E.H. Walker and O. Costa de Beauregard, independently proposing theories of paranormal functioning based on quantum concepts, argue that observer effects open the door to the possibility of nontrivial coupling between consciousness and the environment, and that the nonlocality principle permits such coupling to transcend spatial and temporal barriers.^{26,37}

An alternative hypothesis (that is, alternative to the specifically quantum hypothesis) has been put forward by I.M. Kogan, Chairman of the Bioinformation Section of the Moscow Board of the Popov Society, USSR. He is a Soviet engineer who until 1969 published extensively in the open literature on the theory of paranormal communication.³⁸⁻⁴¹ His hypothesis is that information transfer under conditions of sensory shielding is mediated by extremely-low-frequency (ELF) electromagnetic waves in the 300- to 1000-km region, a proposal which does not seem to be ruled out by any obvious physical or biological facts. Experimental support for the hypothesis is claimed on the basis of: slower than inverse-square attenuation, compatible with source-per-recipient distances lying in the induction field range as opposed to the radiation field range; observed low bit rates (0.005 to 0.1 bit/s) compatible with the information-carrying capacity of ELF waves; apparent ineffectiveness of ordinary electromagnetic shielding as an attenuator; and standard antenna calculations entailing biologically generated currents yielding results compatible with observed signal-to-noise ratios.

UNCLASSIFIED

UNCLASSIFIED

M. Persinger, Psychophysiology Laboratory, Laurentian University, Toronto, Canada, has narrowed the ELF hypothesis to the suggestion that the 7.8-Hz "Shumann waves", and their harmonics propagating along the earth-ionosphere waveguide duct, may be responsible. Such an hypothesis is compatible with driving by brain-wave currents, and leads to certain hypotheses, such as asymmetry between east-west and west-east propagation, preferred experimental times (midnight to 4 a.m.), and expected negative correlation between success and the U index (a measure of geomagnetic disturbance throughout the world). Persinger claims initial support for these factors on the basis of a literature search.^{42,43}

On the negative side with regard to a straightforward ELF interpretation as a blanket hypothesis are: (a) apparent real-time descriptions of remote activities in sufficient detail to require a channel capacity in all probability greater than that allowed by a conventional modulation of an ELF signal; (b) lack of a proposed mechanism for coding and decoding the information onto the proposed ELF carrier; and (c) apparent precognition data. The hypothesis must nonetheless remain open at this stage of research, since it is conceivable that counterindication (a) may eventually be circumvented on the basis that the apparent high bit rate results from a mixture of low-bit-rate input and high-bit-rate "filling in the blanks" from imagination; counterindication (b) is common to a number of normal perceptual tasks and may therefore simply reflect a lack of sophistication on our part with regard to perceptual functioning;⁴⁴ and counterindication (c) may be accommodated by an ELF hypothesis if advanced waves as well as retarded waves are admitted.^{27,45} Experimentation to determine whether the ELF hypothesis is viable can be carried out by the use of ELF sources as targets, by the study of parametric dependence on propagational directions and diurnal timing, and by the exploration of interference effects caused by creation of a high-intensity ELF environment during experimentation, all of which are under consideration as part of a proposed follow-up program in our laboratory.

UNCLASSIFIED

UNCLASSIFIED

The above arguments are not intended to indicate that we understand the precise nature of the information channel coupling remote events and human perception. Rather, we intend only to show that modern theory is not without resources that can be brought to bear on the problems at hand, and it is our expectation that these problems will, with further work, yield to analysis and specification.

UNCLASSIFIED

UNCLASSIFIED

3. Communication Theory Approach to Channel Utilization

Independent of the mechanisms that may be involved in remote sensing, observation of the phenomenon implies the existence of an information channel in the information-theoretic sense. Since such channels are amenable to analysis on the basis of communication theory techniques, channel characteristics, such as bit rate, can be determined independent of a well-defined underlying theory in the sense that thermodynamic concepts can be applied to the analysis of systems independent of underlying mechanisms. Therefore, the collection of data under specified conditions permits headway to be made despite the formidable work that needs to be done to clarify the underlying bases of the phenomena.

One useful application of the communication channel concept was the utilization of such a channel for error-free transmission of information by the use of redundancy coding. The experiment was carried out by Dr. Milan Ryzl, a chemist with the Institute of Biology of the Czechoslovakian Academy of Science. He reasoned that a paranormal channel exhibits the attributes of a communication channel perturbed by noise, and that redundancy coding could be used to combat the effects of the noisy channel in a straightforward application of communication theory.⁸ Ryzl had an assistant randomly select five groups of three decimal digits each. These 15 digits were then encoded into binary form and translated into a sequence of green and white cards sealed in opaque envelopes. With the use of a subject who has produced highly significant results with many contemporary researchers,⁴⁶⁻⁵¹ he was able, by means of redundant calling and an elaborate majority vote protocol, to correctly identify all 15 numbers, a result significant at $p = 10^{-15}$. The experiment required 19,350 calls, averaging nine seconds per call. The hit rate for individual calls was 61.9 percent, 11,978 hits and 7,372 misses.^{4†}

[†]Note added in proof. It has been brought to our attention that a similar procedure was used to transmit without error the word "peace," in International Morse Code; J.C. Carpenter "Toward the Effective Utilization of Enhanced Weak-Signal ESP Effects," presented at the annual meeting of the American Association for the Advancement of Science, New York, Jan. 27, 1975.

UNCLASSIFIED

UNCLASSIFIED

As discussed in the section on the random target generator, the bit rate is calculated from

$$R = H(x) - H_y(x) ,$$

where $H(x)$ is the uncertainty of the source message containing symbols with a priori probability p_i

$$H(x) = - \sum_{i=1}^2 p_i \log_2 p_i ,$$

and $H_y(x)$ is the conditional entropy based on the a posteriori probabilities that a received signal was actually transmitted,

$$H_y(x) = - \sum_{j=1}^2 p(i,j) \log_2 p_1(j) .$$

For the above run, with $p_i = 1/2$, $p_1(j) = 0.619$, and an average time of nine seconds per choice, we have a source uncertainty $H(x) = 1$ bit and a calculated bit rate

$$R = 0.041 \text{ bits/symbol}$$

or

$$R/T = 0.0046 \text{ bits/second.}$$

Since the 15-digit number (49.8 bits) was actually transmitted at the rate of 2.9×10^{-4} bits per second, an increase in bit rate by a factor of about 20 could be expected on the basis of a coding scheme more optimum than that used in the experiments. The actual bit rate is roughly the same as that observed in our random target generator experiment discussed earlier.

An excellent redundancy coding technique for a communication channel is the sequential sampling procedure used earlier in Section II-B for the sorting of SW from non-SW cards. In this application of the sequential sampling procedure, one would first express the message to be sent as a series of binary digits, encoded, for example, as shown in Table 22. The sequential method then gives a rule of procedure for making one of three possible decisions following the receipt of each bit: accept 1 as the bit being transmitted; reject 1 as the bit being transmitted

UNCLASSIFIED

TABLE 22

Five-Bit Code for Alphanumeric Characters

E	00000	Y	01000
T	11111	G,J	10111
N	00001	W	01001
R	11110	V	10110
I	00010	B	01010
O	11101	∅	10101
A	00011	1	01011
S,X,Z	11100	2	10100
D	00100	3	01100
H	11011	4	10011
L	00101	5	01101
C,K,Q	11010	6	10010
F	00110	7	01110
P	11001	8	10001
U	00111	9	01111
M	11000	.	10000

Note: Alphabet characters listed in order of decreasing frequency in English text. See, for example, A. Sinkov, Elementary Cryptanalysis --A Mathematical Approach.⁵² (The low frequency letters, X,Z,K,Q, and J have been grouped with similar characters to provide space for numerics in a five-bit code.) In consideration of the uneven distribution of letter frequencies in English text, this code is chosen such that 0 and 1 have equal probability.

(i.e., accept 0); or continue transmission of the bit under consideration.

As discussed earlier, use of the sequential sampling procedure requires the specification of parameters that are determined on the basis of the following considerations. Assume that a message bit (0 or 1) is being transmitted. In the absence of a priori knowledge, we may assume equal probability ($p = 0.5$) for the two possibilities (0,1) if an encoding procedure like that of Table 22 is used. Therefore, from the standpoint of the receiver, the probability of correctly identifying the bit being transmitted is $p = 0.5$ because of chance alone. An operative remote

UNCLASSIFIED

sensing channel could then be expected to alter the probability of correct identification to a value $p = 0.5 + \psi$, where the parameter ψ satisfies $0 < |\psi| < 0.5$. (The quantity may be positive or negative, depending on whether the paranormal channel results in so-called psi-hitting or psi-missing.) Good psi functioning on a repetitive task is observed to result in $\psi = 0.12$, as reported by Ryzl.⁴ Therefore, to indicate the design procedure, let us assume a baseline psi parameter $\psi_b = 0.1$ and design a communication system on this basis.

The question to be addressed is whether, upon repeated transmission, a given message bit is labeled a "1" at a low rate p_0 commensurate with the hypothesis H_0 that the bit in question is a "0", or at a higher rate p_1 commensurate with the hypothesis H_1 that the bit in question is indeed a "1". The decision making process requires the specification of four parameters:

- * p_0 : The probability of labeling incorrectly a "0" message bit as a "1". The probability of labeling correctly a "0" as a "0" is $p = 0.5 + \psi_b = 0.6$. Therefore, the probability of labeling incorrectly a "0" as a "1" is $1-p = 0.4 = p_0$.
- * p_1 : The probability of labeling correctly a "1" message bit as a "1", given by $p_1 = 0.5 + \psi_b = 0.6$.
- * α : The probability of rejecting a correct identification for a "0" (Type I error). We shall take $\alpha = 0.01$.
- * β : The probability of accepting an incorrect identification for a "1" (Type II error). We shall take $\beta = 0.01$.

With the parameters thus specified, the sequential sampling procedure provides for construction of a decision graph as shown in Figure 27. The equations for the upper and lower limit lines are, respectively,

$$\begin{aligned} \Sigma_1 &= d_1 + sn \quad , \\ \Sigma_0 &= -d_0 + sn \quad , \end{aligned}$$

where

$$d_1 = \frac{\log \frac{1-\beta}{\alpha}}{\log \frac{p_1}{p_0} \frac{1-p_0}{1-p_1}} \quad ,$$

UNCLASSIFIED

UNCLASSIFIED

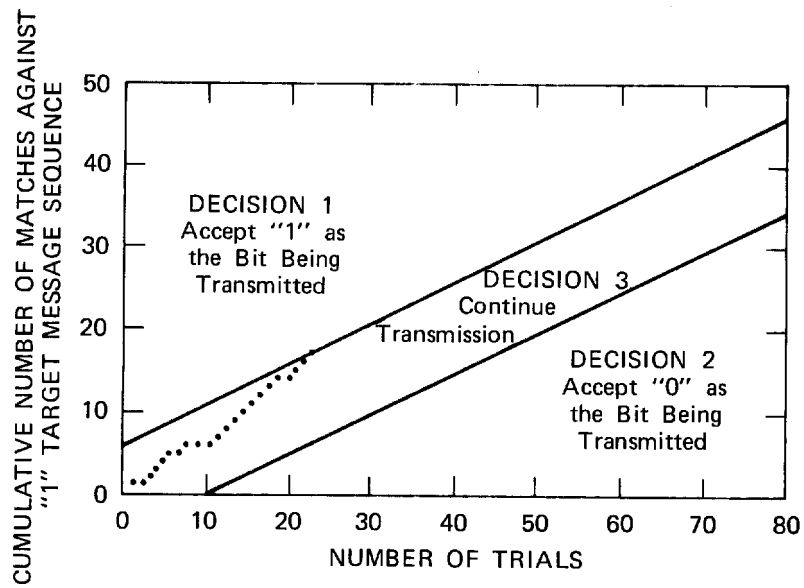

TA-760525-8

FIGURE 27 ENHANCEMENT OF SIGNAL-TO-NOISE RATIO BY SEQUENTIAL SAMPLING PROCEDURE ($p_0 = 0.4$, $p_1 = 0.6$, $\alpha = 0.01$, $\beta = 0.01$)

UNCLASSIFIED

UNCLASSIFIED

$$d_0 = \frac{\log \frac{1-\alpha}{\beta}}{\log \frac{p_1(1-p_0)}{p_0(1-p_1)}},$$

and

$$s = \frac{\log \frac{1-p_0}{1-p_1}}{\log \frac{p_1(1-p_0)}{p_0(1-p_1)}}$$

A cumulative record of receiver-generated responses to the target bit is compiled until either the upper or lower limit line is reached, at which point a decision is made to accept 0 or 1 as the bit being transmitted.

Channel reliability (probability of correctly determining message being transmitted) as a function of operative ψ parameter ψ is plotted in Figure 28. As observed, the sequential sampling procedure can result in 90 percent or greater reliability with ψ parameters of the order of a few percent. Figure 29 indicates the average number of trials required to reach a decision on a given message bit. The average number of trials falls off rapidly as a function of increasing ψ parameters ψ .

Implementation of the sequential sampling procedure requires the transmission of a message coded in binary digits. Therefore, the target space must consist of dichotomous elements such as the white and green cards used in the experiments by Ryzl.

In operation, a sequence corresponding to the target bit (0 or 1) is sent and the cumulative entries are made (Figure 27) until a decision is reached to accept either a 1 or 0 as the bit being transmitted. At a prearranged time, the next sequence is begun and continues as above until the entire message has been received. A useful alternative, which relieves the percipient of the burden of being aware of his self-contradiction from trial to trial, consists of cycling through the entire message repetitively, entering each response on its associated graph until a decision has been reached on all message bits.

From the results obtained in such experiments, the channel bit rate can be ascertained for the system configuration under consideration.

UNCLASSIFIED

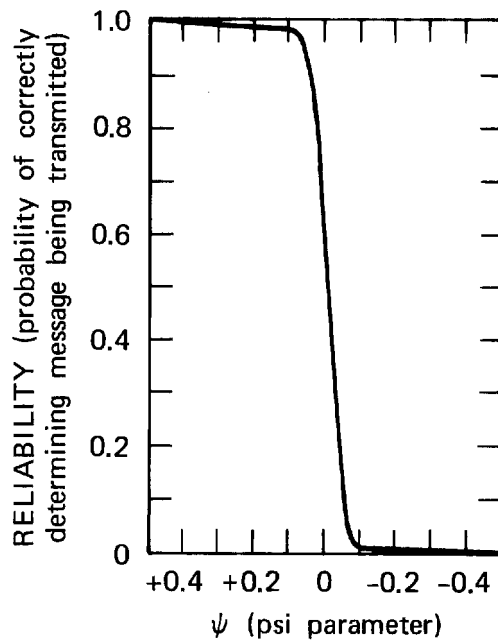

TA-760525-9

FIGURE 28 RELIABILITY CURVE FOR SEQUENTIAL SAMPLING PROCEDURE ($p_0 = 0.4$, $p_1 = 0.6$, $\alpha = 0.01$, $\beta = 0.01$)

UNCLASSIFIED

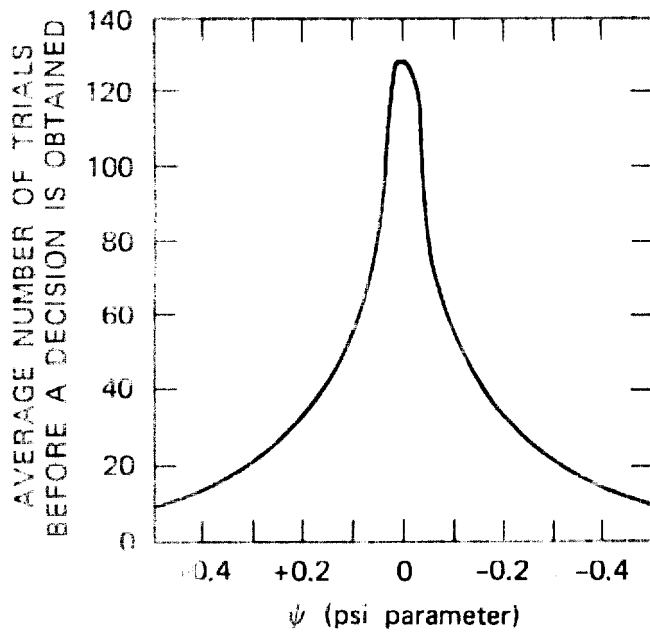

FIGURE 29 AVERAGE SAMPLE NUMBER FOR SEQUENTIAL SAMPLING PROCEDURE ($p_0 = 0.4$, $p_1 = 0.6$, $\alpha = 0.01$, $\beta = 0.01$)

UNCLASSIFIED

Furthermore, bit rates for other degrees of reliability (i.e., for other P_0, P_1, α , and β) can be estimated by construction of other decision curves over the same data base and thus provide a measure of the bit rate per degree of reliability.

In summary, the procedures described here can provide a specification of the characteristics of a remote sensing channel under well-defined conditions. These procedures also provide for a determination of the feasibility of such a channel for particular applications.

4. Soviet Efforts

This discussion would be incomplete if we did not mention certain aspects of the current state of research in the USSR. Since the 1930s in the laboratory of L. Vasiliev (Leningrad Institute for Brain Research), there has been an interest in the use of paranormal communication as a method of influencing the behavior of a person at a distance. In Vasiliev's book Experiments in Mental Suggestion,⁵³ he makes it clear that the bulk of his laboratory's experiments were aimed at long-distance communication and what we would today call behavior modification; for example, putting people to sleep at a distance through hypnosis.

The behavior modification type of experiment has been carried out in recent times by I.M. Kogan. He was concerned with three principal kinds of experiments: mental suggestion without hypnosis over short distances, in which the percipient attempts to identify an object; mental awakening over short distances, in which a subject is awakened from a hypnotic sleep at the "beamed" suggestion from the hypnotist; and long-range (intercity) paranormal communication.³⁹ Kogan's main interest has been to quantify the channel capacity of the paranormal channel. He finds that the bit rate decreases from 0.1 bits per second for laboratory experiments to 0.005 bits per second for his 1000-km intercity experiments.

As indicated earlier, in the USSR serious consideration is given to the hypothesis that paranormal communication is mediated by extremely-low-frequency (ELF) electromagnetic propagation. In general, the entire field of paranormal research in the USSR is part of a larger one concerned with the interaction between electromagnetic fields and living organisms.^{54,55}

UNCLASSIFIED

At the First International Congress on Parapsychology and Psychotronics in Prague, Czechoslovakia, in 1973, for example, Kholodov spoke at length about the susceptibility of living systems to extremely low-level ac and dc fields. He described conditioning effects on the behavior of fish from the application of 10 to 100 μW of RF to their tank.⁵⁶ The USSR take these data seriously in that the Soviet safety requirements for steady-state microwave exposure set limits at 10 $\mu\text{W}/\text{cm}^2$, whereas the United States has set a steady-state limit of 10 mW/cm^2 .⁵⁷ Kholodov spoke also about the nonthermal effects of microwaves on animals' central nervous systems. His experiments were very carefully carried out and are characteristic of a new dimension in paranormal research both in the USSR and elsewhere.

The increasing importance of this area in Soviet research was indicated recently when the Soviet Psychological Association issued an unprecedented position paper calling on the Soviet Academy of Sciences to step up efforts in this area.⁵⁸ The Association recommended that the newly formed Psychological Institute within the Soviet Academy of Sciences and the Psychological Institute of the Academy of Pedagogical Sciences review the area and consider the creation of a new laboratory within one of the institutes to study persons with unusual abilities. They also recommended a comprehensive evaluation of experiments and theory by the Academy of Sciences' Institute of Biophysics and Institute for the Problems of Information Transmission.

5. Conclusions

"It is the province of natural science to investigate nature, impartially and without prejudice."⁵⁹ Nowhere in scientific inquiry has this dictum met as great a challenge as in the area of so-called paranormal perception, the detection of remote stimuli not mediated by the usual sensory processes. Such phenomena, although under scientific consideration for over a century, have historically been fraught with unreliability and controversy, and validation of the phenomena by accepted scientific methodology has been slow in coming. Even so, a recent survey conducted by the British publication New Scientist revealed that 67 percent of nearly 1500 responding readers (the majority of whom are working

UNCLASSIFIED

UNCLASSIFIED

scientists and technologists) considered paranormal perception to be an established fact or a likely possibility, and 88 percent held the investigation of paranormal perception to be a legitimate scientific undertaking.⁶⁰

A review of the literature reveals that although well-conducted experiments by reputable researchers yielding reproducible results were begun over a century ago (e.g., Sir William Crookes' study of D.D. Home, 1860s),^{61,62} many consider the study of these phenomena as only recently emerging from the realm of quasi-science. One reason for this is that, despite experimental results, no satisfactory theoretical construct had been advanced to correlate data or to predict new experimental outcomes. Consequently, the area in question remained for a long time in the recipe state reminiscent of electrodynamics before the unification brought about by the work of Ampere, Faraday, and Maxwell. Since the early work, however, we have seen the development of quantum theory, information theory, and neurophysiological research, and these disciplines provide powerful conceptual tools that appear to bear directly on the issue. In fact, several leading physicists are now of the opinion that, contrary to "common sense" notions, these phenomena are not at all inconsistent with the framework of modern physics: the often-held view that observations of this type are a priori incompatible with known laws is erroneous, such a concept being based on the naive realism prevalent before the development of quantum theory. In the emerging view it is accepted that research in this area can be conducted so as to uncover not just a catalog of interesting events, but rather patterns of cause-effect relationships of the type that lend themselves to analysis and hypothesis in the forms with which we are familiar in the physical sciences.

Accordingly, we consider it important to continue data collection and to encourage others to do likewise; investigations such as those reported here need replication and extension under as wide a variety of rigorously controlled conditions as possible.

UNCLASSIFIED

IV PROGRAM SUMMARY

As a result of exploratory research on human perception carried out in SRI's Electronics and Bioengineering Laboratory, we initiated an investigation of a perceptual channel whereby individuals can access by means of mental imagery and describe randomly-chosen remote sites located several miles or more away.⁵³ In this final report, we document the study at SRI of this human information-accessing capability that we call "remote viewing," the characteristics of which appear to fall outside the range of well-understood perceptual or information-processing abilities. This phenomenon is one of a broad class of abilities of certain individuals to access by means of mental processes and describe information sources blocked from ordinary perception and generally accepted as secure against such access. Individuals exhibiting this faculty include not only SRI subjects, but visiting staff members of the sponsoring organization who participated as subjects so as to critique the protocol.

The program was divided into two categories of approximately equal effort--applied research and basic research. The applied research effort explored the operational utility of the above perceptual abilities. The basic research effort was directed toward identification of the characteristics of individuals possessing such abilities and the determination of neurophysiological correlates and basic mechanisms involved in such functioning.

The phenomenon we investigated most extensively was the ability of individuals to view remote geographical locations (up to several thousand kilometers away), given only coordinates (latitude and longitude) or a person on whom to target. We have worked with a number of individuals, including sponsor personnel, whose remote perceptual abilities have been developed sufficiently to allow them at times to describe correctly--often in great detail--geographical or technical material, such as buildings, roads, laboratory apparatus, and the like.

The development at SRI of successful experimental procedures to elicit this capability has evolved to the point where (a) visiting personnel of the sponsoring organization without any previous exposure to such

UNCLASSIFIED

UNCLASSIFIED

concepts have performed well under controlled laboratory conditions (that is, generated target descriptions of sufficiently high quality to permit blind matching of descriptions to targets by independent judges), and (b) subjects trained over a two-year period have performed well under operational conditions (that is, provided data of operational significance later verified by independent sources). Our data thus indicate that both specially selected and unselected persons can be assisted in developing remote perceptual abilities to a level of useful information transfer.

Furthermore, the data, accumulated from over 50 experiments with more than a half dozen subjects, indicates the following: a) the phenomenon is not a sensitive function of distance over a several-km range and is still operative over a several thousand km range; b) Faraday cage shielding does not appear to degrade the quality or accuracy of perception; c) most of the correct information that subjects relate is of a nonanalytic nature pertaining to shape, form, color, and material rather than to function or name--(this aspect suggests a hypothesis that information transmission under conditions of sensory shielding may be mediated primarily by the brain's right hemisphere); and d) the principal difference between experienced subjects and naive volunteers is not that the naive never exhibit the faculty, but rather that their results are simply less reliable--(this observation suggests the hypothesis that remote viewing may be a latent and widely distributed though repressed perceptual ability).

The primary achievement of the SRI program was thus the elicitation of high-quality remote viewing by individuals who agreed to act as subjects. Criticism of this claim could in principle be put forward on the basis of three potential flaws: (1) the study could involve naivete in protocol that permits various forms of cueing, intentional or unintentional; (2) the experiments discussed could be selected out of a larger pool of experiments of which many are of poorer quality; (3) data for the reported experiments could be edited to show only the matching elements, the nonmatching elements being discarded.

All three criticisms, however, are invalid. First, with regard to cueing, the use of double-blind protocols ensures that none of the persons in contact with the subject can be aware of the target. Second, selection

UNCLASSIFIED

UNCLASSIFIED

of experiments for reporting did not take place; every experiment was entered as performed on a master log and is included in the statistical evaluations. Third, data associated with a given experiment remain unedited; all data associated with an experiment are tape recorded and included unedited in the data package to be judged, evaluated, and so on. Finally, the entire unedited file of tape recordings, transcripts, and drawings for every experiment is available to the COTR and others in the scientific community for independent analysis.

Although the precise nature of the information channel coupling remote events and human perception is not yet understood, certain concepts in information theory, quantum theory, and neurophysiological research appear to bear directly on the issue. Therefore, our working assumption is that the phenomenon of interest is consistent with modern scientific thought, and can therefore be expected to yield to the scientific method. Further, it is recognized that communication theory provides powerful techniques, such as the use of redundancy coding to improve signal-to-noise ratio, which can be employed to pursue special purpose application of the remote sensing channel independent of an understanding of the underlying mechanisms.

Finally, it is concluded by the research contractors (SRI) that the development of experimental procedures and the accrual of experience in three years of successful effort constitutes an asset that could be utilized in the future both for operational needs and for training others in the development and use of the remote-sensing capability.

UNCLASSIFIED

UNCLASSIFIED

REFERENCES

1. R. Morris, "An Exact Method for Evaluating Preferentially Matched Free-Response Material," J. Amer. Soc. for Psychical Research, vol. 66, No. 4, p. 401 (October 1972).
2. N. Feller, An Introduction to Probability Theory and its Applications, vol. 1, (2nd Ed.), p. 98 (John Wiley and Sons, Inc. New York, 1950).
3. P. Hoel, Introduction to Mathematical Statistics, 2nd edition, p. 27 (John Wiley and Sons, Inc., New York, New York, 1954).
4. M. Ryzl, "A Model for Parapsychological Communication," J. Parapsychology, vol. 30, pp. 18-31 (March 1966).
5. W. Scherer, "Spontaneity as a Factor in ESP," J. ASPR, vol. 12, pp. 126-147 (1948).
6. R. Ornstein, The Nature of Human Consciousness, Chapter 7 and 8, (W.H. Freeman and Company, San Francisco, California, 1973).
7. R.W. Sperry, "Cerebral Organization and Behavior," Science, vol. 133, pp. 1749-1757 (1961).
8. C. Shannon and W. Weaver, The Mathematical Theory of Communication (University of Illinois Press, Urbana, Illinois, 1949).
9. R. Targ, P. Cole, and H. Puthoff, "Techniques to Enhance Man/Machine Communication," final report, NASA Contract NAS7-100, Stanford Research Institute, Menlo Park, California (June 1974).
10. J.L. Mack, et. al, "Associative Visual Agnosia and its Related Deficits," presented to the third annual meeting of the International Neuropsychology Society, Tampa, 1975.
11. M.L. Albert, et. al, "Associative Visual Agnosia without Alexia," Neurology, vol. 25, pp. 322-326 (1975).
12. S.N. Davidenkov, Clinical Lectures in Nervous Diseases (State Publishing House of Medical Literature, Leningrad, 1956).
13. A.B. Rubens and D.F. Benson, "Associative Visual Agnosia," Arch. Neurol. vol. 24, pp. 305-316 (1971).
14. F. Lhermitte and M.F. Beauvois, "A Visual-Speech Disconnection Syndrome," Brain, vol. 96, pp. 695-714 (1973).

UNCLASSIFIED

UNCLASSIFIED

15. H.L. Teuber, personal communication from Dr. William Langston.
16. Proceedings of an International Conference on Methodology in PSI Research, Roberto Cavanna, ed., (Parapsychology Foundation, New York, New York, 1970).
17. E. Douglas Dean, "Plethysmograph Recordings as ESP Responses," Intnl. J. Neuropsychiatry, vol. 2 (September 1966).
18. C. Tart, "Physiological Correlates of PSI Cognition," Intnl. J. Parapsychology, No. 4 (1963).
19. D.H. Lloyd, "Objective Events in the Brain Correlating with Psychic Phenomena," New Horizons, vol. 1, No. 2 (Summer 1973).
20. J. Silverman and M.S. Buchsbaum, "Perceptual Correlates of Consciousness; a Conceptual Model and its Technical Implications for PSI Research," Psi Favorable States of Consciousness, R. Cavanna, ed., pp. 143-169 (Parapsychology Foundation, New York, New York, 1970).
21. J. Kamiya, "Comment to Silverman and Buchsbaum," Psi Favorable States of Consciousness, R. Cavanna, ed., pp. 158-159 (Parapsychology Foundation, New York, New York, 1970).
22. D. Hill and G. Parr, Electroencephalography. A Symposium on its Various Aspects (The Macmillan Company, New York, New York, 1963).
23. T.D. Duane and T. Behrendt, "Extrasensory Electroencephalographic Induction Between Identical Twins," Science, vol. 150, p. 367 (1965).
24. S. Siegel, Nonparametric Statistics for the Behavioral Sciences, pp. 152-156 (McGraw-Hill, New York, 1956).
25. T. Sarbin and R. Slagle, "Hypnosis and Psychophysiological Outcomes," Hypnosis: Research Developments and Perspectives, E. Fromm and R. Shor, ed., pp. 185-214 (Aldine Publishing Company, Chicago, Illinois 1972).
26. E.H. Walker, "Foundations of Paraphysical and Parapsychological Phenomena," in Quantum Physics and Parapsychology, L. Oteri, ed., pp. 1-53 (Parapsychology Foundation, Inc., New York, 1975).
27. H. Puthoff and R. Targ, in Psychic Exploration--A Challenge for Science, J. White, ed., pp. 522-542 (G.P. Putnam's Sons, New York, New York, 1974).
28. R. Jarrard, K. Corcoran, R. Mayfield, and R. Morris, "Psychokinesis Experiments with a Cryogenic Magnetometer," Research brief presented at the 18th Annual Convention of the Parapsychological Assoc., Santa Barbara, August 1975.

UNCLASSIFIED

UNCLASSIFIED

29. E.P. Wigner, "The Problem of Measurement," Am. J. Physics, vol. 31, No. 1, p. 6 (1963).
30. J.J. Freedman and J.F. Clauser, "Experimental Test of Local Hidden Variable Theories," Phys. Rev. Letters, vol. 28, p. 938 (3 April 1972).
31. J.F. Clauser and M.A. Horne, "Experimental Consequences of Objective Local Theories," Phys. Rev. D., vol. 10, No. 2, p. 526 (15 July 1974).
32. D. Bohm and B. Hiley, "On the Intuitive Understanding of Non-locality as Implied by Quantum Theory," Preprint, Birkbeck College, London, England (February 1974).
33. J.S. Bell, "On the Problem of Hidden Variables in Quantum Theory," Rev. Modern Physics, vol. 38, No. 3, p. 447 (July 1966).
34. H. Stapp, "Theory of Reality," Lawrence-Berkeley Laboratory Report No. LBL-3837, University of California, Berkeley, California (April 1975).
35. A. Einstein, B. Podolsky, and N. Rosen, "Can Quantum-Mechanical Description of Physical Reality be Considered Complete?," Phys. Rev., vol. 47, p. 777 (15 May 1935).
36. R.H. Dicke and J.P. Wittke, Introduction to Quantum Mechanics, Chapter 7 (Addison-Wesley Publishing Co., Inc., Reading, Massachusetts, 1960).
37. O. Costa de Beauregard, "Time Symmetry and Interpretation of Quantum Mechanics," Foundations of Physics (in press), Lecture delivered at the Boston Colloquium for the Philosophy of Science, February, 1974.
38. I.M. Kogan, "Is Telepathy Possible?" Radio Engineering, vol. 21, No. 1, p. 75 (January 1966).
39. I.M. Kogan, "Telepathy, Hypotheses and Observations," Radio Engineering, vol. 22, No. 1, p. 141 (January 1967).
40. I.M. Kogan, "Information Theory Analysis of Telepathic Communication Experiments," Radio Engineering, vol. 23, No. 3, p. 122 (March 1968).
41. I.M. Kogan, "The Information Theory Aspect of Telepathy," RAND publication, p. 4145, Santa Monica, California (July 1969).
42. M.A. Persinger, "ELF Waves and ESP," New Horizons Transactions of the Toronto Society for Psychical Research, vol. 1, No. 5 (January 1975).

UNCLASSIFIED

UNCLASSIFIED

43. M.A. Persinger, The Paranormal, Part II: Mechanisms and Models, (M.S.S. Information Corp., New York, New York, 1974).
44. B. Julesz, Foundations of Cyclopean Perception (University of Chicago Press, Chicago, Illinois, 1971).
45. G. Feinberg, "Precognition--a Memory of Things Future?," Proc. Conf. on Quantum Physics and Parapsychology, Geneva, Switzerland (Parapsychology Foundation, New York, New York, 1975).
46. M. Ruzl and J. Pratt, "A Repeated-Calling ESP Test with Sealed Cards," J. Parapsychology, vol. 27, pp. 161-174 (1963).
47. M. Ruzl and J. Pratt, "A Further Confirmation of Stabilized ESP Performance in a Selected Subject," J. Parapsychology, vol. 27, pp. 73-83 (1963).
48. J. Pratt, "Preliminary Experiments with a 'Borrowed' ESP Subject," J. Amer. Soc. Psych. Res., vol. 42, pp. 333-345 (1964).
49. J. Pratt and J. Blom, "A Confirmatory Experiment with 'Borrowed' Outstanding ESP Subject," J. Amer. Soc. Psych. Res., vol. 42, pp. 381-388 (1964).
50. W.G. Roll and J.G. Pratt, "An ESP Test with Aluminum Targets," J. Amer. Soc. Psych. Res., vol. 62, pp. 381-387 (1968).
51. J. Pratt, "A Decade of Research with a Selected ESP Subject: An Overview and Reappraisal of the Work with Pavel Stepanek," Proc. Amer. Soc. Psych. Res., vol. 30 (1973).
52. A. Sinkov, Elementary Cryptanalysis--a Mathematical Approach (Random House, New York, New York, 1968).
53. L.L. Vasiliev, Experiments in Mental Suggestion, (ISMI Publications Hampshire, England, 1963).
54. A.S. Presman, Electromagnetic Fields and Life (Plenum Press, New York, New York, 1970).
55. Influence of Magnetic Fields on Biological Objects, Y.A. Kholodov, ed., JPRS 63038, NTIS, Springfield, Virginia (September 24, 1974).
56. Y.A. Kholodov, "Investigation of the Direct Effect of Magnetic Fields on the Central Nervous System," Proc. of the First Conference on Psychotronic Research, JPRS L/5022-1 and 2 (September 6, 1974).
57. D. Mennie, "Consumer Electronics," IEEE Spectrum, pp. 34-35 (March 1975).

UNCLASSIFIED

UNCLASSIFIED

58. W.P. Zinchenko, et. al., "Parapsychology: Fiction or Reality?," Questions of Philosophy, vol. 9, pp. 128-136 (1973).
59. Science and ESP, J.R. Smythies, ed., (Routledge and Kegan Paul, London, England, 1967).
60. C. Evans, "Parapsychology--What the Questionnaire Revealed," New Scientist, pp. 209 (January 25, 1973).
61. Alan Gauld, The Founders of Psychical Research (Schocken Books, New York, New York, 1968).
62. Wm. Crookes, Researches in the Phenomena of Spiritualism, J. Burns, London, England, 1874.
63. R. Targ and H. Puthoff, "Information Transmission Under Conditions of Sensory Shielding," Nature, vol. 252, No. 5476, pp. 602-607 (October 18, 1974).

UNCLASSIFIED

UNCLASSIFIED

Approved For Release 2003/06/24 : CIA-RDP79-00999A000300100034-4

APPENDIX A

Remote Viewing Transcript
for Subject S6 Learner/Control, First Experiment

Following is the unedited transcript of the first experiment with learner/control S6, an SRI volunteer, a mathematician in the computer science laboratory, without any previous experience in remote viewing. The target, determined by random procedure, was White's Plaza, a plaza with a fountain at Stanford University. The capitalized words are the experimenter's statements and questions. As is our standard protocol, the experiment with the subject is kept ignorant of the specific target visited as well as of the contents of the target pool.

* * *

TODAY IS MONDAY, OCTOBER 7TH. IT IS 11:00 AND THIS IS A REMOTE VIEWING EXPERIMENT WITH RUSS TARG, S6, AND HAL PUTHOFF. IN THIS EXPERIMENT HAL WILL DRIVE TO A REMOTE SITE CHOSEN BY A RANDOM PROCESS, S6 WILL BE THE REMOTE VIEWER, AND RUSS TARG IS THE MONITOR (EXPERIMENTER). WE EXPECT THIS EXPERIMENT TO START AT TWENTY MINUTES AFTER ELEVEN AND RUN FOR FIFTEEN MINUTES.

IT IS JUST ABOUT TWENTY MINUTES AFTER ELEVEN AND HAL SHOULD BE AT HIS TARGET LOCATION BY NOW.

WHY DON'T YOU TELL ME WHAT KIND OF PICTURE YOU SEE AND WHAT YOU THINK HE MIGHT BE DOING OR EXPERIENCING.

The first thing that came to mind was some sort of a large, square kind of a shape. Like Hal was in front of it. It was a...not a building or something, it was a square. I don't know if it was a window, but something like that so that the bottom line of it was not at the ground. About where his waist was, at least. That's what it seemed to me.

It seems outdoors somehow. Tree.

DOES HAL SEEM TO BE LOOKING AT THAT SQUARE?

I don't know. The first impression was that he wasn't, but I have a sense that whatever it was was something one might look

A-1

UNCLASSIFIED

Approved For Release 2003/06/24 : CIA-RDP79-00999A000300100034-4

UNCLASSIFIED

at. I don't know if it would be a sign, but something that one might look at.

CAN YOU TELL IF IT IS ON THE GROUND OR VERTICAL?

It seemed vertical.

I don't have a sense that it was part of anything particular. It might be on a building or part of a building, but I don't know. There was a tree outside, but I also got the impression of cement. I don't have the impression of very many people or traffic either. I have the sense that he is sort of walking back and forth. I don't have any more explicit picture than that.

CAN YOU MOVE INTO WHERE HE IS STANDING AND TRY TO SEE WHAT HE IS LOOKING AT?

I picked up he was touching something--something rough. Maybe warm and rough. Something possibly like cement.

IT IS TWENTY-FOUR MINUTES AFTER ELEVEN.

CAN YOU CHANGE YOUR POINT OF VIEW AND MOVE ABOVE THE SCENE SO YOU CAN GET A BIGGER PICTURE OF WHAT'S THERE?

I still see some trees and some sort of pavement or something like that. Might be a courtyard. The thing that came to mind was it might be one of the plazas at Stanford campus or something like that, cement. Some kinds of landscaping.

I said Stanford campus when I started to see some things in White Plaza, but I think that is misleading.

I have the sense that he's not moving around too much. That it's in a small area.

I guess I'll go ahead and say it, but I'm afraid I'm just putting on my impressions from Stanford campus. I had the impression of a fountain. There are two in the plaza, and it seemed that Hal was possibly near the, what they call Mem Claw.

WHAT IS THAT?

UNCLASSIFIED

UNCLASSIFIED

It's a fountain that looks rather like a claw. It's a black sculpture. And it has benches around it made of cement.

ARE THERE ANY BUILDINGS AT THE PLACE YOU WERE LOOKING AT? ARE THERE ANY BUILDINGS? YOU DESCRIBED A KIND OF A COURTYARD. USUALLY AT SOME PLACES THERE SHOULD BE A BUILDING, LARGE OR SMALL THAT THE COURTYARD IS ABOUT.

LOOK AT THE END OR THE SIDES OF THE COURTYARD. IS THERE ANYTHING TO BE SEEN?

I have a sense that there are buildings. It's not solid buildings. I mean there are some around the periphery and I have a sense that none of them are very tall. Maybe mostly one story, maybe an occasional two-story one.

DO YOU HAVE ANY BETTER IDEA OF WHAT YOUR SQUARE WAS THAT YOU SAW AT THE OUTSET?

No. I could hazard different kinds of guesses.

DOES IT SEEM PART OF THIS SCENE?

It...I think it could be. It could almost be a bulletin board or something with notices on it maybe.

Or something that people were expected to look at. Maybe a window with things in it that people were expected to look at.

WHAT KIND OF TREES DO YOU SEE IN THIS PLACE?

I don't know what kind they are. The impression was that they were shade trees and not terribly big. Maybe 12 feet of trunk and then a certain amount of branches above that. So that the branches have maybe a 12-foot diameter, or something. Not real big trees.

NEW TREES RATHER THAN OLD TREES?

Yeah, maybe five or ten years old, but not real old ones.

IS THERE ANYTHING INTERESTING ABOUT THE PAVEMENT?

No. It seems to be not terribly new or terribly old. Not very

UNCLASSIFIED

UNCLASSIFIED

interesting. There seems to be some bits of landscaping around. Little patches of grass around the edges and peripheries. Maybe some flowers. But, not lush.

YOU SAW SOME BENCHES. DO YOU WANT TO TELL ME ABOUT THEM?

Well, that's my unsure feeling about this fountain. There was some kind of benches of cement. Curved benches, it felt like. They were of rough cement.

WHAT DO YOU THINK HAL IS DOING WHILE HE IS THERE?

I have a sense that he is looking at things trying to project them. Looking at different things and sort of walking back and forth not covering a whole lot of territory. Sometimes standing still while he looks around.

I just had the impression of him talking, and I almost sense that it was being recorded or something. I don't know if he has a tape recorder, but if it's not that, then he is saying something because it needed to be remembered.

IT'S 11:33. HE'S JUST PROBABLY GETTING READY TO COME BACK.

UNCLASSIFIED

UNCLASSIFIED

APPENDIX B

INSTRUCTIONS TO SUBJECT: EEG EXPERIMENT*

The purpose of these experiments is to determine whether stimuli (flashing lights, geographical locations, and so on) located in adjoining laboratories or at more distant locales can be perceived, even though the signals are so low due to intervening walls, distance, and the like, as ordinarily to be considered blocked from the visual modes of perception. In addition to obtaining oral responses, we will also from time to time be measuring physiological parameters with standard apparatus (for example, EEG) to determine whether there is evidence for subliminal perception as registered by physiological correlates, even in the absence of conscious perception.

There is no risk associated with these tests, and the only discomfort expected is that attendant to sitting quietly in a darkened room for 30-minute test intervals.

During the experimentation feel free to ask any questions that come to mind as to the procedures, purposes, results, and so on associated with the study.

As with all our activity you are free to withdraw consent and to discontinue participation in the project at any time without prejudice.

*This statement is required by the SRI Administration Manual Topic 812, "Requirements Governing Activities with Human Subjects."

UNCLASSIFIED

UNCLASSIFIED

APPENDIX C
UNIVERSAL RANDOMIZATION PROTOCOL

It was deemed desirable in our work to establish a universal randomization protocol independent of the particular experiment under consideration. The only exceptions were to be automated experiments where target selection is determined by radioactive decay or electronic randomization.

The randomization procedure is designed around a ten-unit base, e.g., ten targets, ten work periods, and so on. A ten-digit sequence governing an experiment is blind to both experimenter and subject, and is uncovered by means of the following procedure. A three-page RAND Table of Random Digits (Table C-1) is entered to obtain a ten-digit sequence, the entrance point being determined by throws of a die,* the first 1, 2, or 3 determining page, the next 1, 2, 3, or 4 determining column block, the following 1, 2, 3, or 4 determining row block, and the final throw determining from which of the first six rows in the block the ten-digit sequence is to be taken. An opaque card with a single-digit window is then moved across the row to uncover digits one at a time. If a multiplicity of targets exist, the digits 0 through 9 are employed directly. If a binary command is required (e.g., increase/decrease or activity/no activity) the parity of the digit (even or odd) is employed.

*A technique found in control runs to produce a distribution of die faces differing nonsignificantly from chance expectation.

UNCLASSIFIED

TABLE C-1

Table of Random Digits

11 16 43 63 18	75 06 13 76 74	40 60 31 61 52	83 23 53 73 61
21 21 59 17 91	76 83 15 86 78	40 94 15 35 85	69 95 86 09 16
10 43 84 44 82	66 55 83 76 49	73 50 58 34 72	55 95 31 79 57
36 79 22 62 36	33 26 66 65 83	39 41 21 60 13	11 44 28 93 20
73 94 40 47 73	12 03 25 14 14	57 99 47 67 48	54 62 74 85 11
19 56 31 28 72	14 06 39 31 04	61 83 45 91 99	15 46 98 22 85
64 20 84 82 37	41 70 17 31 17	91 40 27 72 27	79 51 62 10 07
51 48 67 28 75	38 60 52 93 41	58 29 98 38 80	20 12 51 07 94
99 75 62 63 60	64 51 61 79 71	40 68 49 99 48	33 88 07 64 13
71 32 55 52 17	13 01 57 29 07	75 97 86 42 98	08 07 46 20 55

65 28 59 71 98	12 13 85 30 10	34 55 63 98 61	88 26 77 60 68
17 26 45 73 27	38 22 42 93 01	65 99 05 70 48	25 06 77 75 71
95 63 99 97 54	31 19 99 25 58	16 38 11 50 69	25 41 68 78 75
61 55 57 64 04	86 21 01 18 08	52 45 88 88 80	78 35 26 79 13
78 13 79 87 68	04 68 98 71 30	33 00 78 56 07	92 00 84 48 97
62 49 09 92 15	84 98 72 87 59	38 71 23 15 12	08 58 86 14 90
24 21 66 34 44	21 28 30 70 44	58 72 20 36 78	19 18 66 96 02
16 97 59 54 28	33 22 65 59 03	26 18 86 94 97	51 35 14 77 99
59 13 83 95 42	71 16 85 76 09	12 89 35 40 48	07 25 58 61 49
29 47 85 96 52	50 41 43 19 66	33 18 68 13 46	85 09 53 72 82

96 15 59 50 09	27 42 97 29 18	79 89 32 94 48	88 39 25 42 11
29 62 16 65 83	62 96 61 24 68	48 44 91 51 02	44 12 61 94 38
12 68 97 52 91	71 02 01 72 65	94 20 50 42 59	68 98 35 05 61
14 54 43 71 34	54 71 40 24 01	38 64 80 92 78	81 31 37 74 00
83 40 38 88 27	09 83 41 13 33	04 29 24 60 28	75 66 62 69 54
67 64 20 52 04	30 69 74 48 06	17 02 64 97 37	85 87 51 21 39
61 04 19 90 11	61 04 02 73 09	48 07 07 68 48	02 53 19 77 37
17 04 89 45 23	97 44 45 99 04	30 15 99 54 50	83 77 84 61 15
93 03 98 94 16	52 79 51 06 31	12 14 89 22 31	31 36 16 06 50
82 24 43 43 92	96 60 71 72 20	73 83 87 70 67	24 86 39 75 76

96 99 05 52 44	70 69 32 52 55	73 54 74 37 59	95 63 23 95 55
09 11 97 48 03	97 30 38 87 01	07 27 79 32 17	79 42 12 17 69
57 66 64 12 04	47 58 97 83 64	65 12 84 83 34	07 49 32 80 98
46 49 26 15 94	26 72 95 82 72	38 71 66 13 80	60 21 20 50 99
08 43 31 91 72	08 32 02 08 39	31 92 17 64 58	73 72 00 86 57
10 01 17 50 04	86 05 44 11 90	57 23 82 74 64	61 48 75 23 29
92 42 06 54 31	16 53 00 55 47	24 21 94 10 90	08 53 16 15 78
35 54 25 58 65	07 30 44 70 10	31 30 94 93 87	02 33 00 24 76
86 59 52 62 47	18 55 22 94 91	20 75 09 70 24	72 61 96 66 28
72 11 53 49 85	58 03 69 91 37	28 53 78 43 95	26 65 43 78 51

Source: The RAND Corporation

UNCLASSIFIED

TABLE C-1 (Continued)

07 42 85 88 63	96 02 38 89 36	97 92 94 12 20	86 43 19 44 85
35 37 92 79 22	28 90 65 50 13	40 56 83 32 22	40 48 69 11 22
10 98 22 28 07	10 92 02 62 99	41 48 39 29 35	17 06 17 82 52
90 12 73 33 41	77 80 61 24 46	93 04 06 64 76	24 99 04 10 99
63 00 21 29 90	23 51 06 87 74	76 86 93 93 00	84 97 80 75 04
40 77 98 63 82	48 45 46 52 69	02 98 25 79 91	50 76 59 19 30
43 21 61 26 08	18 16 78 46 31	94 47 97 65 00	39 17 00 66 29
96 16 76 43 75	74 10 89 36 43	52 29 17 58 22	95 96 69 09 47
70 97 56 26 93	35 68 47 26 07	03 68 40 36 00	52 83 15 53 81
85 81 26 18 75	23 57 07 57 54	58 93 92 83 66	86 76 56 74 65

37 10 06 24 92	63 64 24 76 38	54 72 35 65 27	53 07 63 82 35
53 40 61 38 55	38 51 92 95 00	84 82 88 12 48	25 54 83 40 75
55 17 28 15 56	18 85 65 90 43	65 79 90 19 14	81 36 30 51 73
40 35 38 48 07	47 76 74 68 90	87 91 73 85 49	48 21 37 17 08
18 89 90 96 12	77 54 15 76 75	26 90 78 81 73	71 18 92 83 77
68 14 12 53 40	92 55 11 13 26	68 05 26 54 22	88 46 00 63 52
51 55 99 11 59	81 31 06 32 51	42 58 76 81 49	88 14 79 97 00
92 21 43 33 86	73 45 97 93 59	97 17 65 54 16	67 64 20 50 51
15 08 95 05 57	33 16 68 70 94	53 29 58 71 33	38 26 49 47 08
96 46 10 06 04	11 12 02 22 54	23 01 19 41 08	29 19 66 51 87

28 17 74 41 11	15 70 57 38 35	75 76 84 95 49	24 54 36 32 85
66 95 34 47 37	81 12 70 74 93	86 66 87 03 41	66 46 07 56 48
19 71 22 72 63	84 57 54 98 20	56 72 77 20 36	50 34 73 35 21
68 75 66 47 57	19 98 79 22 22	27 93 67 80 10	09 61 70 44 08
75 02 26 53 32	98 60 62 94 51	31 99 46 90 72	37 35 49 30 25
11 32 37 00 69	90 26 98 92 66	02 98 59 53 03	15 18 25 01 66
55 20 86 34 70	18 15 82 52 83	89 96 51 02 06	95 83 09 54 06
11 47 40 87 86	05 59 46 70 45	45 58 72 96 11	98 57 94 24 81
81 42 28 68 42	60 99 77 96 69	01 07 10 85 30	74 30 57 75 09
21 77 17 59 63	23 15 19 02 74	90 20 96 85 21	14 29 33 91 94

42 27 81 21 60	32 57 61 42 78	04 98 26 84 70	27 87 51 54 80
17 69 76 01 14	63 24 73 20 96	19 74 02 46 37	97 37 73 21 12
05 68 63 02 43	34 13 40 29 36	50 19 77 98 69	86 49 76 87 09
52 99 24 66 50	89 91 05 73 95	46 95 46 75 36	28 96 88 19 36
94 51 89 39 84	81 47 86 77 50	82 54 96 26 76	31 12 34 98 99
00 18 47 21 86	78 90 67 54 80	61 79 88 16 00	80 01 88 47 42
87 46 26 31 65	79 81 66 16 30	57 66 62 90 55	46 51 80 14 87
88 69 25 87 16	12 27 34 81 76	29 80 56 49 94	66 87 26 22 30
20 09 44 29 62	41 38 21 67 68	06 71 13 49 39	19 59 97 62 47
60 93 58 15 04	50 52 08 21 53	13 93 44 68 85	58 31 58 83 66

UNCLASSIFIED

TABLE C-1 (Continued)

51	39	28	59	36	43	89	85	05	96	28	54	99	83	27	99	94	32	53	77
54	23	94	19	18	79	52	64	62	74	40	87	16	18	03	25	76	75	54	84
57	89	27	33	94	07	16	09	02	62	47	70	43	83	55	71	70	88	01	17
62	33	07	47	36	53	27	44	44	68	62	61	11	96	98	09	30	42	92	65
76	11	52	92	47	55	34	25	12	99	03	04	78	39	81	11	91	60	92	67
63	31	28	18	86	29	08	52	01	01	26	46	05	05	01	31	73	11	89	38
27	63	22	15	70	34	27	45	64	26	01	76	42	59	59	69	29	38	98	75
06	33	56	21	11	44	01	45	25	67	11	76	25	48	06	02	65	15	29	12
64	14	28	76	76	21	35	88	87	73	31	73	63	16	95	11	52	36	42	13
28	43	62	54	68	75	23	57	53	70	97	15	54	87	06	52	23	92	18	31

09	52	28	38	55	85	97	31	58	88	31	18	14	96	72	17	23	70	40	24
93	71	41	54	14	93	71	20	27	42	32	11	58	26	83	67	18	28	90	30
15	68	15	35	99	58	18	57	38	40	07	06	87	59	47	71	74	36	92	85
77	71	22	39	14	08	90	74	37	68	26	62	27	41	84	75	16	69	67	48
78	45	35	48	44	61	50	90	12	45	02	80	55	26	76	22	51	94	78	48
24	86	06	82	84	19	36	72	90	73	32	30	15	87	01	04	19	33	01	42
37	28	40	68	44	78	88	75	72	76	26	33	95	69	09	39	33	14	21	01
35	48	85	24	73	37	63	43	25	69	95	27	40	95	08	81	01	24	24	13
51	59	55	99	09	35	22	34	49	91	24	27	53	96	32	09	77	79	88	00
90	66	03	51	71	30	02	19	11	20	36	11	64	21	28	65	40	19	41	99

47	50	50	20	08	20	30	08	71	88	96	19	50	70	59	13	26	63	13	89
13	35	00	84	14	64	04	99	43	77	22	40	89	49	58	19	09	55	80	35
33	00	69	26	90	69	24	89	74	43	53	89	62	35	08	16	22	75	69	29
55	21	66	38	86	06	80	41	18	61	22	56	50	24	75	00	25	87	90	18
21	99	12	62	28	14	80	11	91	92	49	43	82	07	72	60	84	66	97	32
71	02	52	82	12	10	47	42	75	22	65	62	03	46	84	00	21	00	48	63
65	52	21	52	42	84	55	47	45	60	20	24	62	69	41	41	29	80	47	63
27	97	55	49	23	90	65	00	61	70	09	43	30	91	67	35	16	63	27	31
07	30	00	97	04	36	09	96	15	77	95	55	27	34	56	16	57	88	81	40
54	35	71	36	89	19	56	90	38	14	76	05	30	51	50	69	12	56	94	42

00	97	70	44	81	42	04	40	86	49	34	82	23	58	43	78	46	88	23	80
13	92	07	87	61	12	31	19	28	08	07	75	30	40	73	58	52	08	00	22
08	39	53	70	43	37	88	03	41	72	04	20	49	44	34	62	79	88	19	02
46	16	66	72	06	01	61	94	37	69	96	77	01	94	40	29	70	04	20	93
87	76	77	76	07	03	74	20	16	13	65	98	96	28	43	10	91	73	44	58
29	88	09	52	88	21	64	44	65	87	06	64	49	47	84	66	99	56	18	12
36	24	83	66	66	14	89	45	92	73	88	95	04	60	77	34	65	11	20	38
12	38	62	96	56	30	47	42	59	64	21	48	29	54	22	02	00	23	36	71
52	06	87	38	01	52	18	81	94	91	55	13	76	10	39	02	00	66	99	13
41	72	75	21	71	56	71	90	60	54	98	44	18	15	29	59	60	76	52	25

UNCLASSIFIED



STANFORD RESEARCH INSTITUTE
Menlo Park, California 94025 · U.S.A.

Final Report

Covering the Period January 1974 through February 1975

PERCEPTUAL AUGMENTATION TECHNIQUES

Part One--Executive Summary

By: Harold E. Puthoff and Russell Targ
Electronics and Bioengineering Laboratory

SRI Project 3183

Approved by:

Earle Jones, Director
Electronics and Bioengineering Laboratory

Bonnar Cox, Executive Director
Information Science and Engineering Division

CLASSIFIED BY: [REDACTED]
EXEMPT FROM GENERAL DECLASSIFICATION SCHEDULE OF E.O. 11652, EXEMPTION CATEGORY SP (1), (2), (3), OR (4) (CIRCLE ONE OR MORE) AUTOMATICALLY DECLASSIFIED ON
<u>Impossible to determine</u> (UNLESS IMPOSSIBLE, INSERT DATE OR EVENT)

SG1A

NATIONAL SECURITY INFORMATION Unauthorized Disclosure Subject to Criminal Sanctions.
--

UNCLASSIFIED

I OBJECTIVE

The goal of this program was to determine the extent to which certain individuals obtain accurate information about their environment under conditions thought to be secure against such access and without the use of known human perceptual modalities.

The program was divided into two categories of approximately equal effort--applied research and basic research. The applied research effort explored the operational utility of the above perceptual abilities. The basic research effort was directed toward identification of the characteristics of individuals possessing such abilities and the determination of neurophysiological correlates and basic mechanisms involved in such functioning.

UNCLASSIFIED

UNCLASSIFIED

II SUMMARY

As a result of exploratory research on human perception carried out in SRI's Electronics and Bioengineering Laboratory, we observed the emergence of a perceptual channel whereby certain individuals access and describe, by means of mental imagery, randomly-chosen remote sites located several miles or more away. In this final report, we document the study at SRI of this human information-accessing capability which we call "remote viewing," the characteristics of which appear to fall outside the range of well-understood perceptual/information-processing abilities. This phenomenon pertains to the ability of certain individuals to access and describe, by means of internal mental processes, information sources blocked from ordinary perception and generally accepted as secure against such access. These individuals include not only SRI subjects, but visiting staff members of the sponsoring organization who participated as subjects in order to critique the protocol. Experiments carried out under controlled laboratory conditions included the reproduction of line drawings shielded against ordinary perception, the determination of the electronic state of a four-state random number generator, and the viewing of remote geographical locations, all at levels of statistical significance $p < 10^{-6}$. Our initial work in this area has been reported in the open literature under the title "Information Transmission Under Conditions of Sensory Shielding," Nature 252, 18 October 1974, and reprinted in the IEEE Communications 13, January 1975. A copy of this publication is included as Appendix A of this report.

Since our initial work the phenomenon we have investigated most

UNCLASSIFIED

SECRET

extensively is the ability of individuals to view remote geographical locations (up to several thousand kilometers), given only coordinates (latitude and longitude) or a person on whom to target. We have worked with a number of individuals, including sponsor personnel, whose remote perceptual abilities have been developed sufficiently to allow them at times to describe correctly--often in great detail--geographical or technical material such as buildings, roads, laboratory apparatus, and the like.

The development of this capability at SRI has evolved to the point where (a) visiting CIA personnel with no previous exposure to such concepts have performed well under controlled laboratory conditions (that is, generated target descriptions of sufficiently high quality to permit blind matching of descriptions to targets by independent judges), and (b) subjects trained over a one-year period have performed well under operational conditions (that is, provided data of operational significance later verified by independent sources). Our accumulated data thus indicate that both specially selected and unselected persons can be assisted in developing remote perceptual abilities to a level of useful information transfer.

To indicate the level of proficiency that can be reached, we present four examples generated by experienced subjects. The first category consists of long-distance (trans-Atlantic) remote-viewing of a large-scale installation. The second category consists of two or more subjects remote-viewing the same target, independently, which in this series was technical apparatus. The third category consists of remote sensing of the internal state of a piece of electronic equipment. The fourth category consists of the perturbation of remote equipment.

SECRET

A. Category I: Long-Distance Remote Viewing

In order to subject the remote viewing phenomena to a rigorous long-distance test under external control, a request for geographical coordinates of a site unknown to subject and experimenters was forwarded to the OSI group responsible for threat analysis in this area. In response, SRI personnel received a set of geographical coordinates (latitude and longitude in degrees, minutes, and seconds) of a facility, hereafter referred to as the West Virginia Site. The experimenters then carried out a remote viewing experiment on a double-blind basis, that is, blind to experimenters as well as subject. The experiment had as its goal the determination of the utility of remote viewing under conditions approximating an operational scenario. Two subjects targeted on the site, a sensitive installation. One subject drew a detailed map of the building and grounds layout, the other provided information about the interior including codewords, data subsequently verified by sponsor sources (report available from COTR).

A long-distance remote viewing experiment was then carried out on a sponsor-designated target of interest, a research center at Semipalatinsk, USSR. The Contracting Officer Technical Representative (COTR) furnished map coordinates to the experimenters. The only additional information provided was the designation of the target as an R&D test facility. The experimenters then carried out a remote viewing experiment on a double-blind basis with a subject (S1) * trained in the SRI program. Figure 1(a) shows the subject's graphic effort for building layout; Figure 1(b) shows the subject's particular attention to a multistory gantry crane he observed at the site. (Again, these results were obtained on a double-blind basis

* A key to numerical designations for subjects is available from the COTR.

UNCLASSIFIED

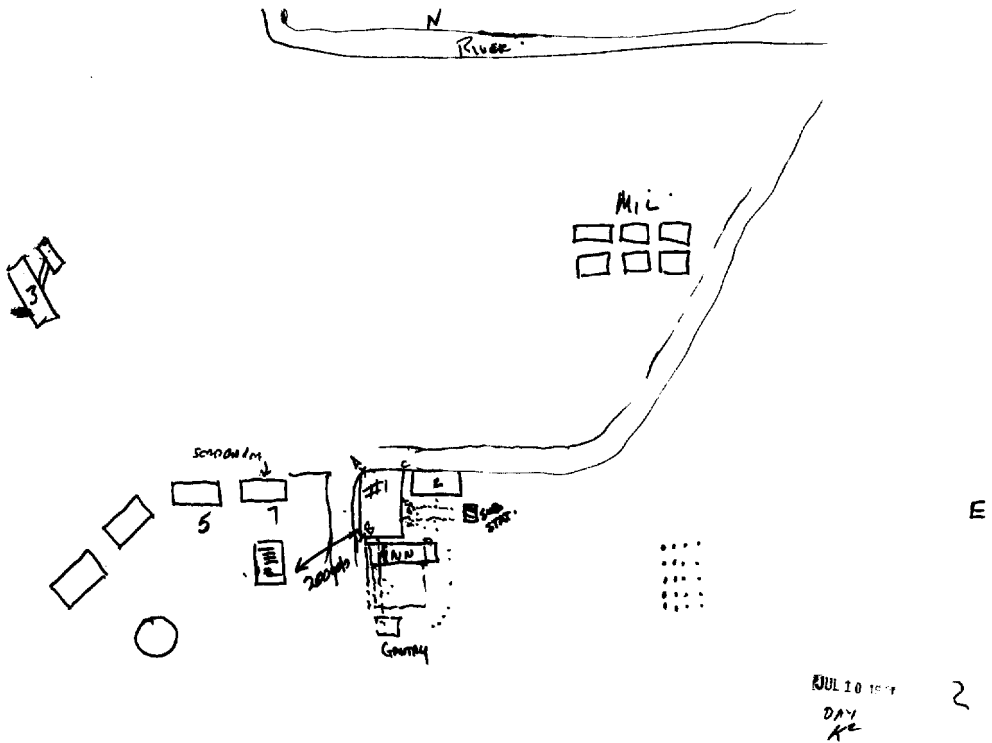

(a) SUBJECT EFFORT AT BUILDING LAYOUT

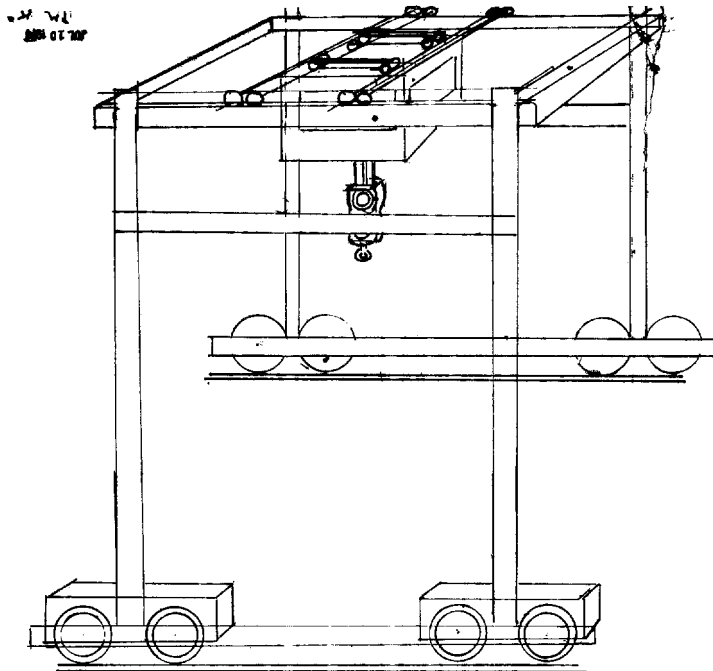

(b) SUBJECT EFFORT AT CRANE CONSTRUCTION

FIGURE 1

UNCLASSIFIED

SECRET

before exposure to the COTR-held information, thus eliminating the possibility of cueing.) For comparison an artist's rendering of the site as known to the COTR (but not to contract personnel) is shown in Figure 2(a), with crane detail shown in Figure 2(b). The exceptionally accurate description of the multistory crane was taken as indicative of probable target acquisition, and therefore the subject was introduced to sponsor personnel who collected further data for evaluation. The latter contained both additional physical data which were independently verified by other sponsor resources, thus providing additional calibration, and also initially-unverifiable data of current operational interest. Several hours of tape transcript and a notebook full of drawings were generated over a two-week period. A description of the data and evaluation is contained in a separate report. The results contained noise along with the signal, but were nonetheless clearly differentiated from the chance results generated by control subjects in comparison experiments carried out by the COTR.

B. Category II: Technology Series (Multiple)

A series of experiments designed to measure the resolution capability of the remote viewing phenomenon were carried out within the confines of SRI. In each experiment a subject was asked to attempt to describe remote laboratory equipment, demarcated only by a target individual sent to a location of interest by means of a random protocol outside the experimenters' control. The experimenter remaining with the subject was kept ignorant of the contents of the target pool to prevent cueing during questioning. The subject was asked to describe the apparatus both verbally (tape recorded) and by means of drawings. The sample presented here is not an edited collection of "best ever" results, but rather consists of the results of the entire collection of experiments directly involving visiting CIA personnel in which

SECRET

SECRET

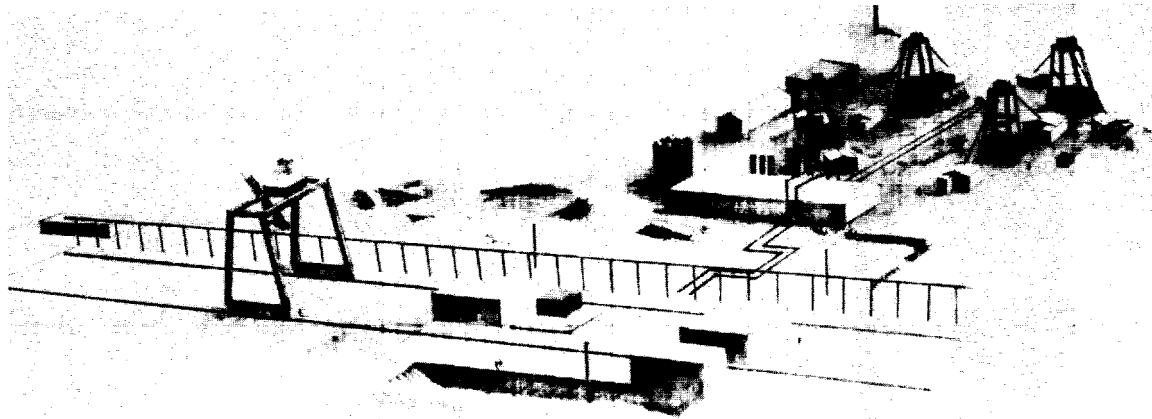

(a) TARGET SITE

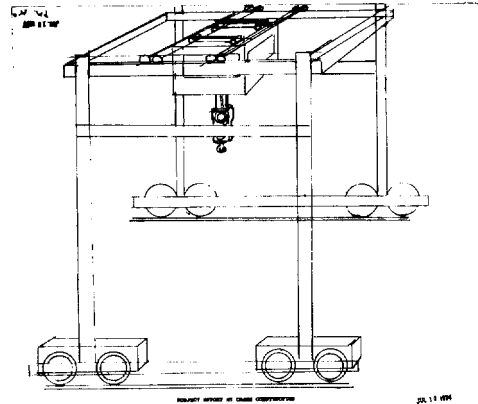
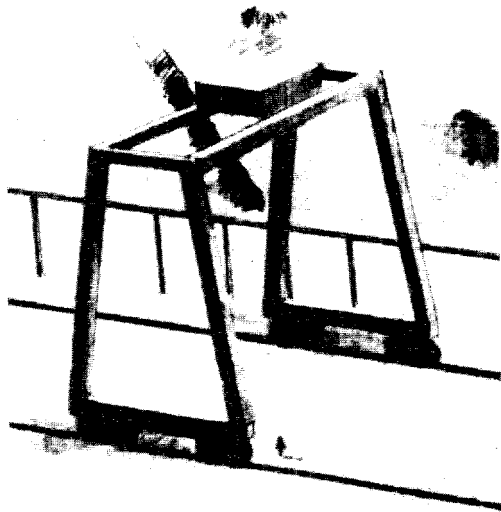

(b) CRANE COMPARISON

FIGURE 2

SECRET

two or more subjects independently viewed an identical technological target.

The target for Experiment 1, a typewriter, was chosen by a sponsor staff member during a site visit. The response drawn by the subject (S4), located approximately 100 yards away, is shown on the right of Figure 3. The target was re-used at a later date with another subject, resulting in the response on the left.

The target for Experiment 2 was a Xerox machine, chosen by the COTR during a site visit. In response the drawing on the right of Figure 4 was generated by a second sponsor staff member who agreed to participate as a subject in this one experiment in order to evaluate the protocol. The target was re-used at a later date with an SRI subject (S2) in an experiment under observation by sponsor personnel, resulting in the response on the left. Finally, the same target came up for subject S3 during a random technological target series, resulting in the drawing in the center.

The target for Experiment 3, a computer input-output unit, resulted in the responses shown in Figure 5. The response on the left was generated by SRI subject S4, the one on the right by a visiting sponsor staff member who participated as a subject in a random technological target series.

Such results, generated in experiments with viewing windows of 15-min. duration, indicate the presence of an information channel of useful bit rate. Furthermore, it would appear that by correlating a number of subject responses to a given target, we can obtain enhancement of the signal-to-noise ratio.

UNCLASSIFIED

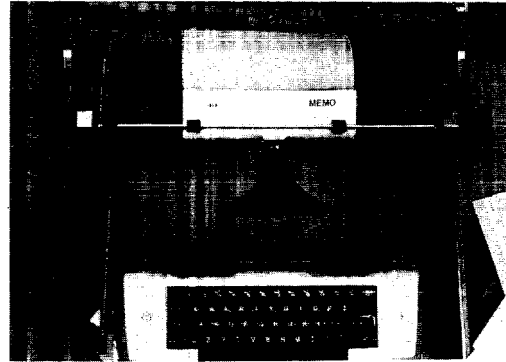

**TECHNOLOGY SERIES
TYPEWRITER TARGET**

*seems to resolve into 2 parts
one sitting on top of the other -
a machine in 2 parts.
white on the side.
see the floor now - beige*

1123

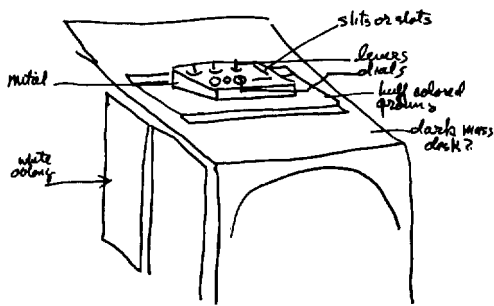

*the lights must be inside
a green crescent*

SRI SUBJECT S3 RESPONSE

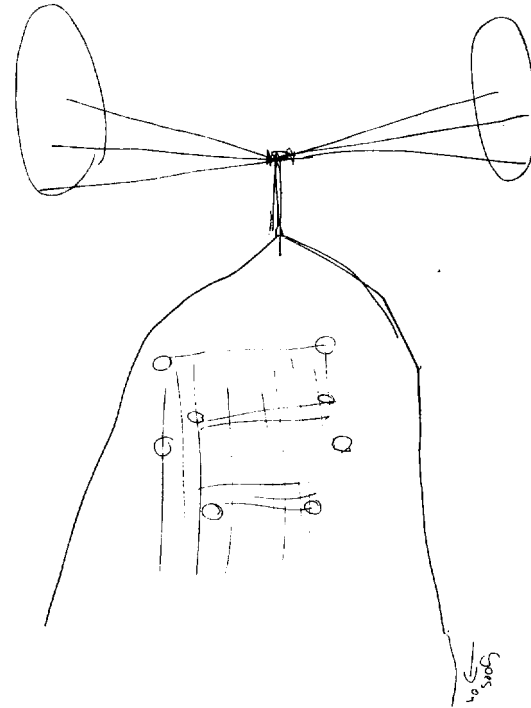

SRI SUBJECT S4 RESPONSE

TA-760522-75

FIGURE 3 DRAWINGS BY TWO SUBJECTS OF A TYPEWRITER TARGET

UNCLASSIFIED

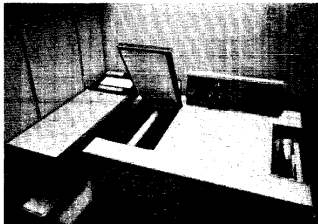

TARGET LOCATION: XEROX MACHINE
(TECHNOLOGY SERIES)

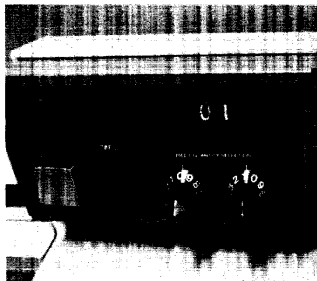

EXPERIMENTER WITH HIS
HEAD BEING XEROXED
(TO ADD INTEREST TO
TARGET LOCATION)



SRI SUBJECT S2 RESPONSE

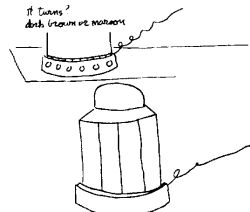
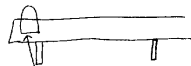

SRI SUBJECT S3 RESPONSE

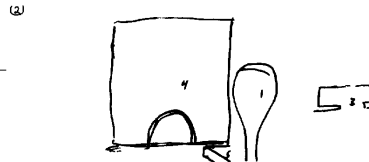

When asked to describe the square at upper left, the subject said, "There was this predominant light source which might have been a window, and a working surface which might have been the sill, or a working surface or desk." Earlier the subject had said, "I have the feeling that there is something silhouetted against the window."

SPONSOR SUBJECT RESPONSE

1A-760522-74

FIGURE 4 DRAWINGS BY THREE SUBJECTS FOR XEROX MACHINE TARGET

UNCLASSIFIED

UNCLASSIFIED

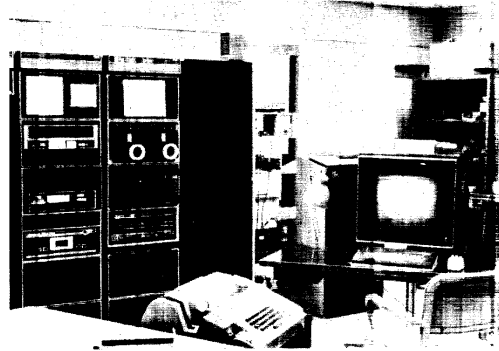
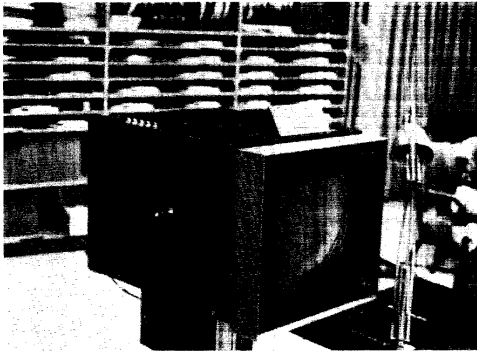

TARGET: VIDEO MONITOR FOR TEXT EDITING (TECHNOLOGY SERIES)

UNCLASSIFIED

UNCLASSIFIED

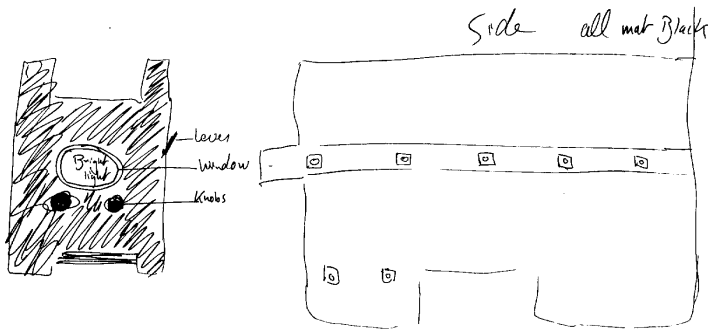

SUBJECT DRAWING OF "BOX WITH LIGHT COMING OUT OF IT . . . PAINTED FLAT BLACK AND IN THE MIDDLE OF THE ROOM"
SRI SUBJECT S4 RESPONSE

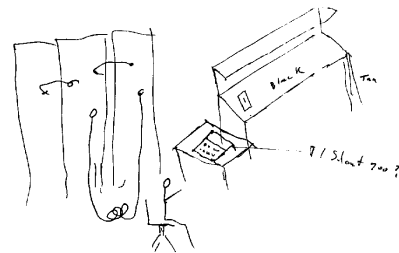

SECOND SUBJECT SAW A TEXAS INSTRUMENTS "SILENT 700" COMPUTER TERMINAL
SPONSOR SUBJECT RESPONSE

SA-3183-8

FIGURE 5 DRAWING BY TWO SUBJECTS OF A VIDEO MONITOR TARGET

C. Category III: Remote Sensing of Internal States of Electronic Equipment

To determine whether remote viewing could be extended beyond visual perception to the sensing of the internal state of a piece of electronic equipment, further experimentation was carried out with six subjects who had shown an ability in remote viewing. The task was the determination of the internal electronic state of a four-state random number generator ($p = 1/4$ for each of four equal-probability outputs) whose characteristics had been examined in detail to verify its randomness. The solid-state machine has no moving parts and provides no sensory cue to the user as to its target generation. (See Figure 6.) Although the task appeared more difficult, one of six subjects consistently scored significantly better than chance ($p = 3 \times 10^{-7}$). In the required 2500-trial run the latter obtained 17.4% more hits (734) than would be expected by chance (625). When the subject was asked to repeat the entire experiment at a later time, he was able to replicate successfully a high scoring rate (11.5% more hits than expected by chance, $p = 4.8 \times 10^{-4}$).

UNCLASSIFIED



FIGURE 6 FOUR-STATE RANDOM NUMBER GENERATOR

The printer to the right of the machine records data automatically on fan-fold paper tape.

UNCLASSIFIED

SECRETD. Category IV: Perturbation of Remote Equipment

Additional experimentation was initiated to investigate the possibility that the remote sensing channel may possess bilateral aspects; for example, it might be possible to couple energy from an individual to a remote location as well as in reverse. To test this hypothesis, experiments were carried out with a sensitive magnetometer in an adjoining laboratory as the remote target. Use of an ORD-developed magnetometer was arranged by ORD personnel. In a series of thirteen 10-trial runs with 50 seconds per trial, perturbations of the magnetometer by a subject gifted in remote viewing were obtained under a strict randomization protocol, yielding a positive result significant at the $p = 0.004$ level. Because of the potential significance and implications of such findings, we intend to collect considerable additional data before arriving at a hard conclusion. Nonetheless, as a tentative conclusion there is evidence that a piece of sensitive equipment can be perturbed by a subject during remote viewing, thus implying that the information channel under investigation may sustain energy transfer in either direction.

E. General Considerations

The primary achievement of the SRI program was the elicitation of high quality remote viewing by individuals who agreed to act as subjects. Criticism of this claim could in principle be put forward on the basis of three potential flaws: (1) the study could involve naivete in protocol which permits various forms of cueing, intentional or unintentional; (2) the experiments discussed could be selected out of a larger pool of experiments of which many are of poorer quality; (3) data for the reported experiments could be edited to show only the matching elements, the non-matching

SECRET

UNCLASSIFIED

elements being discarded.

All three criticisms, however, are invalid. First, with regard to cueing, the use of double-blind protocols ensures that no person in contact with the subject can be aware of the target. Second, no selection of experiments for reporting takes place; every experiment is entered as performed on a master log and is included in the statistical evaluations. Third, data associated with a given experiment remain unedited; all data associated with an experiment are tape recorded and included unedited in the data package to be judged, evaluated, etc. Finally, the entire unedited file of tape recordings, transcripts and drawings for every experiment is available to the COTR and others in the scientific community for independent analysis.

The observed results outlined in A through D above (target acquisition, equipment description, electronic state specification, and perturbation of instrument operation) may together constitute different aspects of a single remote coupling phenomenon. With regard to understanding the phenomenon itself, the precise nature of the information channel coupling remote locations is not yet understood. However, we can show that its characteristics are compatible with both quantum theory and information theory and with recent developments in research on brain function. Therefore, our working assumption is that the phenomenon of interest does not lie outside the purview of modern physics and with further work will yield to analysis and specification.

Further, with an eye toward future subject selection, subjects possessing a well-developed natural ability in the area under consideration underwent complete physical, psychological, and neuropsychological profiling, the results of which suggest the core of a screening procedure.

UNCLASSIFIED

UNCLASSIFIED

Finally, it is concluded by the research contractors that the accrual of experience in three years of successful effort constitutes an asset that could be utilized in the future both for operational needs and for training others in the development and use of the remote sensing capability.

UNCLASSIFIED

SG1A

Approved For Release 2003/06/24 : CIA-RDP79-00999A000300100034-4

Next 14 Page(s) In Document Exempt

Approved For Release 2003/06/24 : CIA-RDP79-00999A000300100034-4



STANFORD RESEARCH INSTITUTE
MENLO PARK, CALIFORNIA 94025
(415) 326-6200

January 27, 1975

SG1A





SG1A

Dear

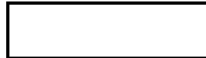

I am writing to let you know that we have apparently struck pay dirt in the administration of the Halstead-Reitan Neuropsychology Test Battery. Let me begin by expressing my appreciation for your guidance in suggesting this particular series of tests.

According to the neuropsychologist who administered the tests, preliminary analysis of the data indicated very promising results. On the basis of the analyses to date, it appears that a consistent pattern is emerging in which good performers in our area of interest show a very high level of proficiency in certain spatial tasks as compared to more average abilities in other tasks. (Some individual results were exceedingly atypical with respect to the established norms.) The preliminary findings suggested a congruence with other data on right versus left hemispheric specialization of sufficient strength that he added some special tests for this area. He is presently correlating the data with that obtained by the Department of Psychiatry, Palo Alto Medical Clinic, and will be forwarding his results to me shortly. As soon as the written report is in hand I shall send it along without delay.

Please distribute the additional copies of the letter to   as I do not have an expedient address for them.

SG1A

SG1A

With best regards,

H.E. Puthoff PhD
Electronics and Bioengineering Laboratory

HEP:jls

Enc.

cc:



SG1A

(b) Physical Measurements

A meeting was held with a representative of the client's organization in which it was agreed that an experiment shall be carried out utilizing a client-supplied Josephson junction gradiometer. Alternate SRI locations were examined and a suitable one chosen. The purpose of the experiment is (1) to determine whether magnetic field gradients can be established on command by the subject, and, if so, (2) to investigate such effects under conditions of viewing the probe from remote locations, and, if the latter is positive, to examine the effect as a function of subject-probe distance.

The additional sensitive instruments are being set up as remote probes. One is a radiation probe box which includes a photo-multiplier and geiger counter. The other is a mechanical force indicator consisting of a torsion pendulum suspended on a metal fiber, enclosed in a bell jar, and monitored by a laser beam reflected from a mirror on the pendulum to a beam-position detector. Baseline data are being taken for these instruments, and experimentation will proceed during April.

Reference 1: "Hemispheric Specialization and the Duality of Consciousness," David Galin, M.D. and Robert E. Ornstein, Ph.D., in press in: Widroe, Harvey, M.D., ed. Human Behavior and Brain Function, Published by Charles C. Thomas, Springfield, Illinois, 1973.

(b) Physical Measurements

A meeting was held with a representative of the client's organization in which it was agreed that an experiment shall be carried out utilizing a client-supplied Josephson junction gradiometer. Alternate SRI locations were examined and a suitable one chosen. The purpose of the experiment is (1) to determine whether magnetic field gradients can be established on command by the subject, and, if so, (2) to investigate such effects under conditions of viewing the probe from remote locations, and, if the latter is positive, to examine the effect as a function of subject-probe distance.

The additional sensitive instruments are being set up as remote probes. One is a radiation probe box which includes a photo-multiplier and geiger counter. The other is a mechanical force indicator consisting of a torsion pendulum suspended on a metal fiber, enclosed in a bell jar, and monitored by a laser beam reflected from a mirror on the pendulum to a beam-position detector. Baseline data are being taken for these instruments, and experimentation will proceed during April.

Reference 1: "Hemispheric Specialization and the Duality of Consciousness," David Galin, M.D. and Robert E. Ornstein, Ph.D., in press in: Widroe, Harvey, M.D., ed. Human Behavior and Brain Function, Published by Charles C. Thomas, Springfield, Illinois, 1973.

(b) Physical Measurements

A meeting was held with a representative of the client's organization in which it was agreed that an experiment shall be carried out utilizing a client-supplied Josephson junction gradiometer. Alternate SRI locations were examined and a suitable one chosen. The purpose of the experiment is (1) to determine whether magnetic field gradients can be established on command by the subject, and, if so, (2) to investigate such effects under conditions of viewing the probe from remote locations, and, if the latter is positive, to examine the effect as a function of subject-probe distance.

The additional sensitive instruments are being set up as remote probes. One is a radiation probe box which includes a photo-multiplier and geiger counter. The other is a mechanical force indicator consisting of a torsion pendulum suspended on a metal fiber, enclosed in a bell jar, and monitored by a laser beam reflected from a mirror on the pendulum to a beam-position detector. Baseline data are being taken for these instruments, and experimentation will proceed during April.

Reference 1: "Hemispheric Specialization and the Duality of Consciousness," David Galin, M.D. and Robert E. Ornstein, Ph.D., in press in: Widroe, Harvey, M.D., ed. Human Behavior and Brain Function, Published by Charles C. Thomas, Springfield, Illinois, 1973.

(b) Physical Measurements

A meeting was held with a representative of the client's organization in which it was agreed that an experiment shall be carried out utilizing a client-supplied Josephson junction gradiometer. Alternate SRI locations were examined and a suitable one chosen. The purpose of the experiment is (1) to determine whether magnetic field gradients can be established on command by the subject, and, if so, (2) to investigate such effects under conditions of viewing the probe from remote locations, and, if the latter is positive, to examine the effect as a function of subject-probe distance.

The additional sensitive instruments are being set up as remote probes. One is a radiation probe box which includes a photo-multiplier and geiger counter. The other is a mechanical force indicator consisting of a torsion pendulum suspended on a metal fiber, enclosed in a bell jar, and monitored by a laser beam reflected from a mirror on the pendulum to a beam-position detector. Baseline data are being taken for these instruments, and experimentation will proceed during April.

Reference 1: "Hemispheric Specialization and the Duality of Consciousness," David Galin, M.D. and Robert E. Ornstein, Ph.D., in press in: Widroe, Harvey, M.D., ed. Human Behavior and Brain Function, Published by Charles C. Thomas, Springfield, Illinois, 1973.

SG1A

Approved For Release 2003/06/24 : CIA-RDP79-00999A000300100034-4

Next 20 Page(s) In Document Exempt

Approved For Release 2003/06/24 : CIA-RDP79-00999A000300100034-4



STANFORD RESEARCH INSTITUTE
Menlo Park, California 94025 · U.S.A.

24 April 1974

Progress Report No. 2
Covering the Period 1 March to 1 April 1974
Stanford Research Institute Project 3183

PERCEPTUAL AUGMENTATION TECHNIQUES

by
Harold E. Puthoff

Client Private

I OBJECTIVE

The purpose of the program is to determine the characteristics of those perceptual modalities through which individuals obtain information about their environment, wherein such information is not presented to any known sense.

The program is divided into two categories of investigation of approximately equal effort, applied research and basic research. The purpose of the applied research effort is to explore experimentally the potential for applications of perceptual abilities of interest, with special attention given to accuracy and reliability. The purpose of the basic research effort is to identify the characteristics of individuals possessing such abilities, and to identify neurophysiological correlates and basic mechanisms involved in such functioning.

II PROGRESS DURING THE REPORTING PERIOD

A. Applied Research

1. Remote Viewing

(a) Local Targets

An experiment is continuing in which ten sites known to the subject are being visited in random sequence, with replacement, by a target demarcation team. A comparison is to be made as to hit accuracy under conditions of (1) identifying the site by name and, (2) identifying the site by photographs.

(b) Remote Targets

In conjunction with a vacation trip by one of the experimenters (H.P.) to Costa Rica, a week of remote target viewing will be carried out at 1330 local time (1430 Costa Rica time). Pictures of the target locations are to be taken. Upon return and development of the pictures, the subject will be asked to match target pictures with narratives, as will the experimenter, both in blind fashion.

2. Detection of Variable Density Target Material

An initial experiment with twenty-seven sponsor drawings of variable content and density was completed. The goal was the differentiation of twelve low-density cards, six pencil, and nine blank cards. The numbered envelopes containing the target material, sealed and specially secured by the sponsor, were randomized before each trial and placed inside non-numbered opaque envelopes before being presented to the subject for sorting.

Two series were carried out. The first consisted of 24 runs through the 27 cards, choosing 12 cards each run, the goal being to choose the 12 low-density cards. Out of the $12 \times 24 = 288$ choices, the expected number of target cards by chance was 128, the observed number chosen, 133. The second series consisted of 18 runs through the 27 cards, choosing 6 cards each run, the goal being to choose the 6 pencil cards. Out of the $6 \times 18 = 108$ choices, the expected number of target cards by chance was 24, the observed number chosen, 19. Thus, the overall result given the task did not differ significantly from chance.

However, when we examine the ranking of cards by number of times chosen, we observe a significant skew in the distribution. Independent of the assigned task, in the 24-run series of 12 choices each, the expected number of times a given card is chosen is 11.

In the 18 run series of 6 choices each, the expected number of times a given card is chosen is 4. In the two series, of the 17 cards chosen more often than expected by chance, the expected number of low density cards is 7.5, the observed number 13, a result significant at the $p = 2 \times 10^{-3}$ level. Thus, in the overall distribution certain of the low-density cards were chosen often enough to yield a significant result in the ranking distribution.

It is considered that the initial experiment was unnecessarily complex, there being a mixture of target sizes (2), symbols (3), and ink techniques (3). New experiments are to be carried out to clarify whether a usable talent exists in this area.

B. Basic Research

1. Testing Program

(a) Psychological Testing

Arrangements have been made with Dr. Donald Lim of the Palo Alto Veteran's Administration Hospital for the administration of the Halstead-Reitan neuropsychology test battery. Dr. Lim is experienced in the administration of the battery and has personally consulted with Dr. Reitan on testing procedures and interpretation.

In connection with testing hypotheses associated with hemispheric specialization of the brain, Dr. Robert Ornstein of the Langley Porter Neuropsychiatric Institute, University of California, San Francisco, has agreed to administer tests appropriate to testing hemispheric predisposition.

(b) Medical Testing

The physical characteristics part of the program will be administered by the Environmental Medicine facility of the Palo Alto

Medical Clinic. The basic physical includes urinalysis, bloodwork (hemoglobin, STS, CBC, blood pressure pulse), hearing tests (frequency and intensity), eye tests (depth perception, color vision, far and near vision, peripheral vision), pulmonary function test, EKG, tonometry, height, weight, and a physical examination. A consultation appointment has been set up to explore further testing for special areas beyond the basic physical.

2. Measurement Program

(a) EEG Experiment

A variety of evidence from clinical and neurosurgical sources indicates that the two hemispheres of the human brain are specialized for different cognitive functions. The left hemisphere is predominantly involved in verbal and other analytic functioning, the right in spatial and other holistic processing. (See Appendix,)¹

In consultation with Dr. Robert Ornstein of the Langley Porter Neuropsychiatric Institute, an hypothesis was formed based on certain observed characteristics that paranormal functioning might involve right hemispheric specialization. To test this hypothesis, the EEG remote strobe-flash experiment described in Report No. 1 was repeated three times with monitoring of right and left occipital regions. Each experiment consisted of 20 15-second trials, 10 no-flash trials, and 10 16 Hz trials randomly intermixed. Reduction of alpha activity (arousal response) correlated with remote stimuli was observed as in previous experiments, but essentially only in the right hemisphere (average alpha reduction 16 percent in right hemisphere, 2 percent in left, during the 16 Hz trials as compared with the no-flash trials). Such results indicate initial support for the hypothesis of right hemispheric specialization, and therefore further investigation of right hemisphere specialization seems indicated.

(b) Physical Measurements

A meeting was held with Mr. Stacy Luke of the client's organization in which it was agreed that an experiment shall be carried out utilizing the client's Josephson junction gradiometer. Alternate SRI locations were examined and a suitable one chosen. The purpose of the experiment is (1) to determine whether magnetic field gradients can be established on command by the subject, and, if so, (2) to investigate such effects under conditions of viewing the probe from remote locations, and, if the latter is positive, to examine the effect as a function of subject-probe distance.

Two additional sensitive instruments are being set up as remote probes. One is a radiation probe box which includes a photo-multiplier and geiger counter. The other is a mechanical force indicator consisting of a torsion pendulum suspended on a metal fiber, enclosed in a bell jar, and monitored by a laser beam reflected from a mirror on the pendulum to a beam-position detector. Baseline data are being taken for these instruments, and experimentation will proceed during April.

Reference 1: "Hemispheric Specialization and the Duality of Consciousness," David Galin, M.D. and Robert E. Ornstein, Ph.D., in press in: Widroe, Harvey, M.D., ed. Human Behavior and Brain Function, Published by Charles C. Thomas, Springfield, Illinois, 1973.

APPENDIX

Hemispheric Specialization and the
Duality of Consciousness

David Galin, M.D. and Robert E. Ornstein, Ph.D.
Institute for the Study of Human Consciousness
Langley Porter Neuropsychiatric Institute
University of California, San Francisco

in press in:

Widroe, Harvey, M.D., ed. Human Behavior and Brain Function

published by

Charles C Thomas

Springfield, Illinois

1973

Hemispheric Specialization and the
Duality of Consciousness

David Galin, M.D., and Robert E. Ornstein, Ph.D.

Institute for the Study of Human Consciousness

Langley Porter Neuropsychiatric Institute

University of California, San Francisco

A variety of evidence from clinical and neurosurgical sources indicates that the two hemispheres of the human brain are specialized for different cognitive functions. This evidence has been confirmed in studies of normal subjects. The left hemisphere is predominantly involved in verbal and other analytic functions, the right in spatial and other holistic processing.

The two hemispheres have been surgically separated for the treatment of certain cases of epilepsy; after the operation, it has been found that each hemisphere is conscious, and can carry out complex cognitive processes of the type for which it is specialized. In short, there appear to be two separate, conscious minds in one head. The study of how these two half-brains cooperate or interfere with each other in normal, intact people has just begun. We believe that this work has important implications for psychiatric theory and practice, and education, as well as for clinical neurology.

In our laboratory at Langley Porter we have been studying this lateralization of function with EEG techniques. With the method which we have developed we can distinguish between these two cognitive modes as they occur in normal subjects, using simple scalp recordings.

We will review some of the experiments and clinical observations on this duality in human nature, and mention some of the opportunities for future research that seem to us most promising.

1. Specialization of the two Hemispheres - "Split-Brain" studies:

The asymmetrical localization of cognitive function has long been established. Language was ascribed to the left hemisphere by Dax in 1836 (Benton & Joynt, 1960). Since then clinical work with brain damaged patients has continued to differentiate the cognitive functions of the hemispheres (Semmes et al., 1955, Milner, 1965a, Luria, 1966, Corkin, 1965). For example right temporal lobectomy produces a severe impairment on visual and tactile mazes. In contrast left temporal lobectomy of equal extent produces little deficit on these tasks but impairs verbal memory (Milner, 1965a, Corkin, 1965). In general, clinical work has found verbal and arithmetical functions (analytic, linear) depend on the left hemisphere while spatial relationships (holistic, gestalt) are the special province of the right hemisphere. Sperry, Gazzaniga, Bogen and their associates (1969, Levy, 1970, Bogen, 1969) have had a unique opportunity to study the specialization of the two halves of the brain isolated from each other. They worked with patients who had undergone surgical section of the corpus callosum for the treatment of epilepsy. These "split brain" patients were tested with special apparatus to insure that the task was presented to only one hemisphere at a time. Sperry, Gazzaniga and Bogen have been able to establish that each hemisphere can function independently and is independently conscious. Learning and memory are found to continue separately in each hemisphere. The right hand literally does not know what

the left hand is doing. Both halves independently sense, perceive and conceptualize. Unilateral associations between tactual, visual and auditory sensations remain. In these patients, the left hemisphere is capable of speech, writing and mathematical calculation, and is severely limited in problems involving spatial relations. The right hemisphere has use of only a few words and can perform simple addition only up to ten, but can perform tasks involving spatial relationships and music patterns.

It is important to emphasize that what most characterizes the hemispheres is not that they are specialized to work with different types of material, (the left with words and the right with spatial forms); rather each hemisphere is specialized for a different cognitive style; the left for an analytic, logical mode for which words are an excellent tool, and the right for a holistic, gestalt mode, which happens to be particularly suitable for spatial relations, and music. The difference in cognitive style is explicitly described in a recent paper by Levy, Trevarthen, and Sperry, 1972 :

"Recent commissurotomy studies have shown that the two disconnected hemispheres, working on the same task, may process the same sensory information in distinctly different ways, and that the two modes of mental operation involving spatial synthesis for the right and temporal analysis for the left, show indications of mutual antagonism (Levy, 1970). The propensity of the language hemisphere to note

analytical details in a way that facilitates their description in language seems to interfere with the perception of an over-all Gestalt, leaving the left hemisphere 'unable to see the wood for the trees.' This interference effect suggested a rationale for the evolution of lateral specialization..." (Levy, et al., 1972) (See also Nebes, 1971, Semmes, 1968).

Sperry and his collaborators have found that "in general, the post-operative behavior of (the commissurotomy patients) has been dominated by the major (left) hemisphere..." except in tasks for which the right hemisphere is particularly specialized. (Levy, et al., 1972).

To understand the method of testing and interviewing each half of the brain separately, two points of functional anatomy must be kept in mind. The first is that since language functions (speech, writing) are mediated predominantly by the left hemisphere in most people, the disconnected right hemisphere cannot express itself verbally. The second point is that the neural pathways carrying information from one side of the body and one-half of the visual field cross over and connect only with the opposite side of the brain. This means that sensations in the right hand and images in the right visual space will be projected almost entirely to the left hemisphere. Similarly, the major motor output is crossed, and the left hemisphere mainly controls the movements of the right hand. Therefore, patients with the corpus callosum sectioned can describe or answer questions about objects placed in their right hands, or pictures flashed to the right visual field with a tachistoscope, but can give no correct verbal

response when the information is presented to the left hand or the left visual field (they will in fact, often confabulate). The mute right hemisphere can, however, indicate its experience with the left hand, for example, by selecting the proper object from an array.

2. Dissociation of Experience:

The dissociation between the experiences of the two disconnected hemispheres is sometimes very dramatic. A film made by Sperry and his colleagues shows two illustrative incidents.

The film shows a young female patient being tested with a tachistoscope as described above. In the series of neutral geometrical figures being presented at random to the right and left fields, a nude pin-up was included and flashed to the right (nonverbal) hemisphere. The girl blushed and giggled. Sperry asked "What did you see?" She answered "Nothing, just a flash of light," and giggled again, covering her mouth with her hand. "Why are you laughing then?" asks Sperry, and she laughs again and says, "Oh, Dr. Sperry, you have some machine!" The episode is very dramatic, and if one did not know her neurosurgical history one might have seen this as a clear example of perceptual defense: one might infer that she was repressing the perception of the conflictful sexual material--even her final response (a socially acceptable nonsequitur) was convincing. (see also Sperry, Am. Psychol, 1968, 23:723-33, esp. p. 732).

In another section of the film a different patient is performing a block design task; he is trying to match a colored geometric design with a set of painted blocks. The film shows the left hand (right hemisphere) quickly carrying out the task. Then the experimenter disarranges the

blocks and the right hand (left hemisphere) is given the task; slowly and with great apparent indecision it arranges the pieces. In trying to match a corner of the design the right hand corrects one of the blocks, and then shifts it again, apparently not realizing it was correct: the viewer sees the left hand dart out, grab the block to restore it to the correct position--and then the arm of the experimenter reaches over and pulls the intruding left hand off-camera.

3. Psychiatric Implications:

There is a compelling formal similarity between these dissociation phenomena seen in the commissurotomy patients and the phenomena of repression; according to Freud's early "topographical" model of the mind, repressed mental contents functioned in a separate realm, which was inaccessible to conscious recall or verbal interrogation, functioning according to its own rules, developing and pursuing its own goals, affecting the viscera and insinuating itself in the stream of ongoing consciously directed behavior.

This parallel suggests that we examine the hypothesis that in normal, intact people mental events in the right hemisphere can become disconnected functionally from the left hemisphere (by inhibition of neuronal transmission across the corpus callosum and other cerebral commissures), and can continue a life of their own. This hypothesis suggests a neurophysiological mechanism for at least some cases of repression, and an anatomical locus for the unconscious mental contents.

What are the circumstances under which such a dissociation could take place? There are several ways in which the two hemispheres of an ordinary

person could begin to function as if they had been surgically disconnected, and cease exchanging information. The first way is by active inhibition of information transfer because of conflict. Imagine the effect on a child when his mother presents one message verbally, but quite another with her facial expression and body language; "I am doing it because I love you, dear", say the words, but "I hate you and will destroy you" says the face. Each hemisphere is exposed to the same sensory input, but because of their relative specializations, they each emphasize only one of the messages. The left will attend to the verbal cues because it cannot extract information from the facial gestalt efficiently; the right will attend preferentially to the non-verbal cues because it cannot easily understand the words (Levy et al., 1972). Effectively a different input has been delivered to each hemisphere, just as in the laboratory experiments in which a tachistoscope is used to present different pictures to the left and right visual fields. We offer the following conjecture: In this situation the two hemispheres might decide on opposite courses of action; the left to approach, and the right to flee. Because of the high stakes involved each hemisphere might be able to maintain its consciousness and resist the inhibitory influence of the other side. The left hemisphere seems to win control of the output channels most of the time (Sperry, 1968), but if the left is not able to "turn off" the right completely it may settle for disconnecting the transfer of the conflicting information from the other side. The connections between hemispheres are relatively weak compared to the connections within hemispheres (Bogen 1969) and it seems likely that each hemisphere treats the weak contralateral input in the same way in

which people in general treat the odd discrepant observation which does not fit with the mass of their beliefs; first we ignore it, and then if it is insistent, we actively avoid it (Stent, 1972).

The mental process in the right hemisphere, cut off in this way from the left hemisphere consciousness which is directing overt behavior, may nevertheless continue a life of its own. The memory of the situation, the emotional concomitants, and the frustrated plan of action all may persist, affecting subsequent perception and forming the basis for expectations and evaluations of future input.

But active inhibition arising from conflicting goals is not the only way to account for a lack of communication between the two hemispheres, and a consequent divergence of consciousness. In the simplest case, because of their special modes of organization and special areas of competence, the knowledge which one hemisphere possesses may not translate well into the language of the other. For example, the experience of attending a symphony concert is not readily expressed in words, and the concept "Democracy requires informed participation" is hard to convey in images. What may be transmitted in such cases may be the conclusion as to action, and not the details on which the evaluation was based. It is possible to convey some of the richness of the holistic consciousness in words, but it requires a great artist.

4. Neo-Phrenology:

It is not clear to what extent specific cognitive performances can be said to depend on specific areas of the cerebrum, beyond the gross distinction between left and right hemispheres. Without going too far in

the direction of assigning "centers" to each mental quality in the manner of the phrenologists, there seems to be some evidence for within-hemisphere localization. For example, Milner (1965b) has correlated disorders in specific kinds of language processing with lesions in specific areas of the left hemisphere; verbal memory deficits with anterior temporal lesions, speech deficits with posterior temporal lesions, fluency deficits with frontal lesions and reading deficits with lesions in the region of the parieto-occipital junction.

The difficulties inherent in "localizing" complex functions are exemplified in the conflicting literature on the lateralization of arithmetic calculation. Luria finds "primary acalculia" or primary arithmetical disturbances with lesions of the left infero-parietal lobe (Luria, 1966), but Kinsbourne finds no systematic lateralization for arithmetic (1972).

The problem is complex, according to Critchley (1953) because calculation may entail more than one type of mentation and different people seem to employ different methods. Lesions in different areas would be expected to produce dyscalculia insofar as a person depended on the use of specific visual symbols or notation, or on rote memory (e.g. multiplication tables) or on an ideokinetic factor based on concrete manipulation such as counting on fingers. The horizontal and vertical arrangement of numbers to represent units, tens, hundreds, etc., depends on spatial and constructional factors. Vivid imagery for numerical forms and sequences may be important to some people (Humphrey and Zangwill, 1952). Critchley concludes, "Nonetheless, there are certain 'vulnerable' regions of the

brain, wherein a lesion is more apt to be followed by a severe dyscalculia bearing certain clinical hallmarks. Thus disease of the dominant left hemisphere is more often followed by severe disorders of calculation." (Critchley, 1953)

5. Evidence for Lateral Specialization in Normal People:

Some caution should be exercised in making the inference of lateral specialization of cognitive function in normal people from lesion studies alone. One might consider whether the 'split' functions are due in some part to the radical surgery, or to the other disturbances in these patients. The study of neurological disorders or surgical preparations cast light on normal functioning, but the most important and most practical question is whether the normal brain, engaged in everyday activities is organized around lateralization of cognitive function.

Recent research with normal subjects provides support for the inference that the intact brain does in fact make use of lateral specialization. With normal subjects, Filbey and Gazzaniga have measured the time required for information presented to one hemisphere to be acted upon by the other. A verbal reaction to information presented to the non-verbal right hemisphere took longer than a non-verbal response. (Filbey and Gazzaniga, 1969). McKeever found faster tachistoscopic word recognition for words projected to the left hemisphere than to the right (McKeever and Huling, 1970). In dichotic listening tasks, normal subjects have better recall for verbal material presented to the right than to the left ear and better recall for melodies presented to the left. (Kimura, 1961).

Other laboratories have used electrophysiological techniques such as evoked potentials and DC potentials. Buchsbaum recorded averaged visual evoked potentials from the left and right occipital areas in response to words and geometric stimuli (Buchsbaum and Fedio, 1969). The responses to these two classes of stimuli were the same in the right hemisphere, but different in the left hemisphere. Wood et al. (1971) found similar results with auditory stimuli; subjects listened to verbal stimuli under two conditions; to process them for speech cues (stop consonants) and for non-speech cues (pitch). The evoked responses were the same in the right hemisphere, but different in the left hemisphere.

Morrell and Salamy (1971) reported that evoked potentials to speech sounds were larger in the left hemisphere leads than in the right, and Vella et al. (1972) reported that responses to complex visual forms were larger in the right. McAdam and Whitaker recorded DC potentials over the left and right fronto-temporal areas. Just before subjects spoke, a negative shift appeared, more pronounced on the left than on the right. No shift was seen preceding non-verbal vocal tract activities (voluntary coughing, spitting) (McAdam and Whitaker, 1971).

In the past three years we have applied EEG methods to the study of this lateral specialization in normal people. By studying EEG asymmetry we were able to distinguish the two cognitive modes as they occur in normal subjects using simple scalp recording (Galin and Ornstein, 1972). In brief, we examined the EEGs of subjects performing verbal and spatial tasks to determine whether there were differences in activity between the appropriate and inappropriate hemispheres. We recorded from the temporal

and parietal areas since clinico-anatomical evidence indicates that these areas should be differently engaged in these tasks. We found that during verbal tasks the integrated whole-band power in the left hemisphere is less than that in the right, and during spatial tasks the integrated power in the right hemisphere is less than in the left. Most of the task-dependent asymmetry appeared to be in the alpha band. Our method of analyzing the ratios of right to left EEG power was adopted by McKee, Humphrey and McAdam (1973) in a study contrasting musical and verbal processing. They confirm our general finding that the ratio is higher in the verbal tasks compared to the non-verbal task.

Table 1 summarizes some of the results from two of our experiments. The average alpha ratios (right/left) were computed for temporal, parietal, and central recordings during verbal and spatial tasks intended to engage primarily the left or the right hemisphere. Spatial tasks included building geometric designs from memory with blocks, mirror drawing and a mental Form Board task. Verbal tasks included composing a letter mentally and in writing, and memorizing and writing the main facts from a text passage. The task pairs which were selected differ in their requirement for motor output, and for memory. The attention-to-breathing task was included as a "neutral" non-cognitive condition. (For further details of the methods and results of Experiment 1, see Galin and Ornstein, 1972, Doyle, Ornstein and Galin, 1973).

TABLE I Inter- and Intra-hemispheric Specialization for Cognitive Mode:
Differences between Electrode Locations - Alpha ratios*

Experiment I

		Motor tasks		Mental tasks		"Non-cognitive"	
		Written		Form	Mental		Attention
N=10	Blocks	Letter	p	Board	Letter	p	to-Breath
P4/P3	0.97	1.09	.01	0.81	0.98	ns	0.94
T4/T3	0.68	1.06	.01	0.79	1.06	.05	0.87

Experiment II

		Memory tasks		Non-memory tasks		"Non-cognitive"	
		Write		Mirror	Text		Attention
N=35	Blocks	from	p	Drawing	Copying	p	to-Breath
P4/P3	0.99	Memory	.0003	1.01	1.07	.04	1.20
T4/T3	0.77	1.12	.00003	0.75	0.94	.0004	0.88
C4/C3	0.79	1.17	.0003	0.83	1.03	.0006	0.97

* Geometric means over all subjects of EEG power ratios (right/left)

** Significance of differences tested by Wilcoxon Matched-Pair Signed-Ranks Test, all P values two-tailed, ns = .05.

Fig. 1 shows a sample from the EEG from one subject during the Blocks and Written Letter tasks. Fig. 2 shows the results of frequency spectrum analysis of the EEG from which Fig. 1 was taken.

Insert Figures 1 and 2 about here

The second experiment confirms the main effect found in the first; higher ratios are found during verbal tasks than during spatial tasks. All three lead pairs show the task-dependent asymmetry in both comparisons (Blocks vs. Write-from-Memory, and Text Copying vs. Mirror Drawing).

There are systematic differences between the leads. The parietal leads, in all comparisons, in both experiments, exhibit the least task-dependent asymmetry, i.e. the difference in alpha ratio on the verbal task and the spatial task is smaller on the parietal leads than on the temporal and central leads. The temporal and central leads appear to behave similarly in this respect.

The Attention-to-Breath task most closely approximates the conditions under which clinical EEGs are recorded; i.e. little information processing, passive, unstructured. Clinical EEG texts generally state that alpha amplitude is normally higher on the right than the left. We find this to be so for the parietal leads, but consistently reversed for the temporal leads. Table II shows the results from the Breathing task of Experiment II. Most subjects have predominant right parietal alpha and predominant left temporal alpha. The central leads show an equal distribution. This reversal between parietal and temporal alpha predominance can also be seen

during the active cognitive tasks. (Table 1, all tasks except Mental Letter)

TABLE II

Differences between electrode locations in "resting" alpha asymmetry

	Parietal	Temporal	Central
Higher Right Alpha	27	9	16
Higher Left Alpha	6	24	15

The functional significance of this reversal of asymmetry is not yet clear, but it precludes classifying a person simply as "right dominant" or "left dominant"; intrahemispheric specialization must be taken into account.

Previous investigators have sought to relate electrophysiological recordings to cognitive functions. A major effort has been devoted to relating the EEG to "intelligence" (see review by Vogel, et al., 1968). Our approach to this problem takes into account three factors which seem to have been neglected in the past:

1. Recording while the subject is engaged in a task, rather than trying to relate a "resting" EEG or averaged evoked potential to subsequent performance.
2. Selection of cognitive tasks which clinical evidence has shown to depend more on one hemisphere than the other, and which therefore should be associated with a predictable distribution of brain activity.
3. Selection of electrode placements on clinico-anatomical grounds. A wealth of evidence suggests that temporal and parietal leads should be the

most functionally asymmetrical, and occipital leads the most similar. Unfortunately, occipital leads have been used most often in the past, probably because they are not as sensitive to eye movement and muscle artifacts. Usually recordings have been made only unilaterally.

Now that we have established a method for determining lateralization of cognitive function in normal Ss, several major areas of concern can be studied: the generality of lateral specialization of cognitive function in the population, the role of lateral specialization in critical academic skills, the effect of social drugs on hemispheric interaction, and the possibility of training voluntary control over patterns of lateral asymmetry using the feedback EEG.

6. Lateralization in Left Handed and Ambidexterous People:

The lateralization of cognitive functions described above is characteristic of right handed people. The cerebral lateralization of left handed people is more complex. Hecaen (1964,1971) has provided an extensive review of the neurological literature and a summary of his own clinical studies, and concluded that left handers show a greater cerebral ambi-laterality, not only for language, but also for gnostic and praxic functions. Hecaen distinguishes between left handedness which is familial and that which follows a perinatal injury to the left hemisphere. The familial type may or may not have reversed language lateralization.

These conclusions were generally confirmed by Satz et al. (1967) in a study of a neurologically normal population. They used the dichotic listening test to assess language lateralization and carefully tested

manual superiority rather than relying on the subjects' self-classification as to handedness.

Following the hypothesis of Orton that stuttering and dyslexia can be due to poorly established cerebral specialization, many studies have found high incidences of left handers and ambidexterous people among these clinical groups. Hecaen (1964) concludes that while no convincing direct relation has been demonstrated, "disorders of laterality can play a part in a certain number of these cases."

The nature of these "disorders of laterality" is not clear. To our knowledge there have been no attempts to quantitatively evaluate the interaction between the verbal-analytic and spatial-holistic cognitive systems in normal daily activities. Our opinion is that in many ordinary activities normal people simply alternate between cognitive modes rather than integrating them. These modes compliment each other but do not readily substitute for each other. Although it is possible to process complex spatial relationships in words, it would seem much more efficient to use visual-kinesthetic images. For example, consider what most people do when asked to describe a spiral staircase; they begin using words, but quickly fall back on gesturing with a finger.

Processing in the inappropriate cognitive system may not only be inefficient; it may actually interfere with processing in the appropriate system. This 'interference hypothesis' is supported by a study of left-handed subjects who were presumed to have bilateral language representation (Levy, 1969). Levy compared left-handed and right-handed subjects with equal WAIS verbal scores and found that the left handers had significantly

lower performance scores, which she attributed to interference from the presumed ambilaterality of language. Her observation has been confirmed by Miller (1971). Similarly, in a group of patients in whom right-hemisphere language was demonstrated with carotid amygdalotomy, Lansdell (1969) found a negative correlation between language ability and spatial performance scores. Brooks (1970) presents additional support for the hypothesis of "interhemispheric interference". Reading a description of spatial relations interferes with the subsequent manipulation of those spatial relations. DenHyser and Barrett (1971) demonstrated selective loss of spatial and verbal information in short term memory by means of spatial and verbal interpolated tasks. Levy has in fact suggested that verbal and non-verbal functions evolved in opposite hemispheres to reduce interference of one system with the other (Levy, 1969).

This evidence of interference between the right and left cognitive modes provides a new kind of support for the hypothesis of Orton, that lack of cerebral lateral specialization plays a major role in dyslexia and stuttering. This hypothesis has continued to sustain interest, in spite of a lack of convincing direct evidence. Until recently, the only generally available index of cerebral lateralization was handedness, and people with little hand preference, or left handers who were "switched" or those with mixed hand and eye preference were considered to be "high risk". The incidence of such people in clinical categories such as stuttering, dyslexia, and specific learning disability is usually found to be higher than in the normal population.

Our EEG method for studying lateralization of cognitive function, along with the dichotic listening test, can provide a much more direct and presumably more sensitive means for investigating disorders of laterality than measures based on hand, eye, or foot dominance. Our present proposal to extend our measures to left handed and ambidexterous populations will lay the groundwork for these clinical studies.

7. Biofeedback Training for Voluntary Control of EEG Asymmetry:

Our research has demonstrated characteristic patterns of activity and inactivity for both the verbal and the spatial cognitive modes. It is reasonable to suppose that more selective inhibition and facilitation of each hemisphere can improve performance. It has been shown in many laboratories that, when subjects are given exteroceptive feedback on the state of a physiological variable, they can learn control of the variable, e.g. EEG alpha, heart rate, EMG (Nowlis and Kamiya, 1970; Budzynski, Stoyva and Adler, 1970; Hnatow and Lang, 1965). For example, O'Malley and Connors (1972) have reported a pilot case of a dyslexic boy who was given lateralized alpha feedback training, and showed significant changes in EEG asymmetry. Therefore, with the aid of feedback from our electrophysiological index of cognitive mode, subjects may be able to learn to reduce the interference between hemispheres, and thereby improve cognitive performance.

8. Implications for Education:

Our EEG and eye movement studies (Kocel et al., 1972; Galin & Ornstein, 1973) provide potential methods of assessing an individual's preferred cognitive mode. An individual's preferred cognitive style may facilitate

his learning of one type of subject matter, e.g., spatial, relational, and hamper the learning of another type, e.g., verbal analytical. A student's difficulty with one part of a curriculum may arise from his inability to change to the cognitive mode appropriate to the work he is doing.

Studies by Cohen (1969), Marsh et al. (1970), and by Bogen et al. (1972), have indicated that subcultures within the United States are characterized by a predominant cognitive mode: the middle class is likely to use the verbal-analytic mode; the urban poor is more likely to use the spatial-holistic mode. This results in a cultural conflict of cognitive style and may in part explain the difficulties of the urban poor children in the school system oriented toward the middle class. There seems to be a new recognition among educators of the importance of both modes of experiencing the world (J. Bruner, On Knowing; Essays for the Left Hand, 1965). Many new programs (e.g., Sesame Street) emphasize helping verbally-analytically oriented children to develop holistic mode skills as well as helping holistically-oriented children to make use of the traditional verbal-analytic materials. If our project is successful, it may make it feasible to train an individual child to enter both cognitive modes appropriately. With EEG feedback an individual may be able to learn to sustain a pattern of brain activity and the concomitant cognitive mode which is appropriate to reading and arithmetic on the one hand and painting and construction on the other.

Our approach may also be of use in the study of cognitive development. Since brain injuries before the age of 12 rarely result in permanent aphasia, it is reasonable to suppose that the lateralization of cognitive

function is still in flux in young children after the acquisition of speech and even after the acquisition of written language. The maturation of the child's cognitive power may be paralleled by, and perhaps even depend upon, increasing lateral specialization with a resulting decrease in interference between cognitive systems. Our EEG measures of cognitive functioning could be powerful tools for mapping the course of this growth. These measures could be used in diagnosing aberrations in cognitive development. For example, certain forms of dyslexia may be caused by interhemispheric interference. Perhaps "feedback" training to improve selective inhibition of the inappropriate cognitive mode would prove useful in therapy.

BIBLIOGRAPHY

- Benton, A. L. & Joynt, R. J. "Early descriptions of aphasia." Archives of Neurol. 3:205-222, 1960.
- Bogen, J.E. "The other side of the brain." I, II, III, Bulletin of the Los Angeles Neurological Society 34:73-105, 135-162, 191-220, 1969.
- Bogen, J. E., DeZure, R., Tenhouten, W. D. & Marsh, J. F. "The other side of the brain: IV. The A/P ratio." Bull. Los Angeles Neurol. Soc., 37:49-61, 1972.
- Brooks, L.R. "An extension of the conflict between visualization and reading." Quart. J. Exper. Psychol. 22:91-96, 1970.
- Buchsbaum, M. and Fedio, P. "Visual information and evoked responses from the left and right hemispheres." EEG Clin. Neurophysiol. 26:266-272, 1969.
- Budzynski, T.H., Stoyva, J., Adler, C. "Feedback-Induced muscle relaxation: Application to tension headaches." J. Behav. Ther. Exper. Psychiat. 1:205-211, 1970.
- Cohen, R.A. "Conceptual styles, culture conflict and non-verbal tests of intelligence." Amer. Anthropologist 71:826-856, 1969.
- Corkin, Suzanne. "Tactually-guided maze learning in man: Effects of unilateral cortical excisions and bilateral hippocampal lesions." Neuropsychologia 3:339-351, 1965.
- Critchley, M. The Parietal Lobes. London: E. Arnold, 1953.
- DenHyar, K. and Barrett, B. "Selective loss of visual information in short term memory by means of visual and interpolated tasks." Psychon. Sci. 25:100-102, 1971.

- Doyle, J.C., Ornstein, R., Galin, D. "Lateral specialization of cognitive mode:
II. EEG frequency analysis. Psychophysiology, 1973, in press.
- Filbey, R.A. and Gazzaniga, M.S. "Splitting the normal brain with reaction time."
Psychon. Sci. 17:335, 1969.
- Galin, D. and Ornstein, R. "Lateral specialization of cognitive mode: An EEG
study." Psychophysiology 9:412-418, 1972.
- Galin, D. and Ornstein, R. "Individual differences in cognitive style:
I. Reflective eye movements. Neuropsychologia, 1973, in press.
- Gazzaniga, M.S. The Bisectioned Brain. New York: Appleton-Century-Crofts, 1970.
- Hecaen, H. and Ajuraguerra, J. de. Left-Handedness, Manual Superiority and
Cerebral Dominance. New York and London: Grune and Stratton, 1964.
- Hecaen, H. and Sauguet, J. "Cerebral dominance in left-handed subjects."
Cortex 7:19-48, 1971.
- Hniatow, M. and Lang, P. "Learned stabilization of cardiac rate."
Psychophysiology 1:330, 1965.
- Humphrey, M.E. and Zangwill, O.L. "Cessation of dreaming after brain injury."
J. Neurol. Neurosurg. Psychiat. 14:322-325, 1951.
- Humphrey, M. E. & Zangwill, O. L. Effects of a right-sided occipito-
parietal brain injury in a left-handed man. Brain, 75:312-324, 1952.
- Kimura, D. "Cerebral dominance and the perception of verbal stimuli."
Can. J. Percept. 15:166-171, 1961.
- Kinsbourne, M. "Eye and head-turning indicates cerebral lateralization."
Science 176:539-541, 1972.
- Kocel, K. Galin, D., Ornstein, R., Merrin, E. L. Lateral eye movement
and cognitive mode. Psychonom. Sci., 27:223-224, 1972.
- Lansdell, H. "Verbal and non-verbal factors in right hemisphere speech."
J. Comp. and Physiol. Psychol. 69:734-738, 1969

- Levy, J., Trevarthen, C., Sperry, R.W. "Perception on bilateral chimeric figures following hemispheric deconnexion." Brain 95:61-78, 1972.
- Levy, J. Possible basis for the evolution of lateral specialization of the human brain." Nature 224:614-615, 1969.
- Levy, J. "Information processing and higher psychological functions in the disconnected hemispheres of human commissurotomy patients. (Unpublished Thesis, California Institute of Technology, 1970.
- Luria, A.R. Higher Cortical Functions in Man. New York: Basic Books, 1966.
- Marsh, J.F., TenHouten, W.D., Bogen, J.E. " A theory of cognitive functioning and social stratification." Progress Report O.E.O. contract, Department of Sociology, University of California, Riverside, 1970.
- McAdam, D.W. and Whitaker, H.A. "Language production: Electroencephalographic localization in the normal human brain." Science 172:499-502, 1971.
- McKee, G., Humphrey, B., McAdam, D. "Scaled lateralization of alpha activity during linguistic and musical tasks. (In Press, Psychophysiology).
- McKeever, W.F. and Huling, M. "Left cerebral hemisphere superiority in tachistoscopic word recognition performance." Percept. Mot. Skills 30:763-766, 1970.
- Miller, E. "Handedness and the pattern of human ability." Br. J. Psychol. 62:111-112, 1971.
- Milner, B. "Visually guided maze learning in man: Effects of bilateral, frontal, and unilateral cerebral lesions." Neuropsychologia 3:317-338, 1965a.
- Milner, B. "Brain mechanisms suggested by studies of temporal lobes." In Language New York: Grune and Stratton, 1965b.
- Morrell, L.K. and Salamy, J.G. "Hemispheric asymmetry of electrocortical responses to speech stimuli." Science 174:164-166, 1971.
- Approved For Release 2003/06/24 : CIA-RDP79-00999A000300100034-4

- Nebes, R. "Superiority of the minor hemisphere in commissurotomed man for the perception of part-whole relations." Cortex 7:333-349, 1971.
- Nowlis, D. and Kamiya, J. "Control of EEG alpha rhythms through auditory feedback and the associated mental activity." Psychophysiology 4:476-484, 1970.
- O'Malley, J.E. and Conners, C.K. "The effects of unilateral alpha training on visual evoked responses in a dyslexic adolescent." Psychophysiology 9:467-470, 1972.
- Orton, S.T. "Some studies in language function." Res. Publ. Assoc. Nerv. Ment. Dis. 13:614-632, 1934.
- Satz, P., Achenbach, K., Fennell, E. "Correlations between assessed manual laterality and predicted speech laterality in a normal population." Neuropsychologia 5:295-310, 1967.
- Semmes, J., Weinstein, S., Ghent, L., Teuber, H.L. "Spatial orientation in man after cerebral injury: 1. Analyses by locus of lesion." J. Psychol. 39:227-244, 1955.
- Semmes, J. "Hemispheric specialization: A possible clue to mechanism." Neuropsychologia 6:11-26, 1968.
- Sperry, R.W., Gazzaniga, M.S., Bogen, J.E. "Interhemispheric relationships: The neocortical commissures, syndromes of hemisphere disconnection." In Handbook of Clinical Neurology Vol. 4, Amsterdam: North Holland Publishing Co., 1969. pp. 273-290.
- Sperry, R.W. "Hemisphere deconnection and unity in conscious awareness." Amer. Psychol. 23:723-733, 1968.
- Stent, G. "Prematurity and uniqueness in scientific discovery." Sci. Amer. 84-93, Dec. 1972.

function." Nature 236:125-126, 1972.

Vogel, W., Broverman, D.M., Klaiber, E.L. "EEG and mental abilities."

EEG Clin. Neurophysiol. 24:166-175, 1968.

Wood, C., Goff, W. R., Day, R. S. "Auditory evoked potentials during
speech perception." Science 173:1248-1251, 1971.

Figure Legends

Figure 1. Change in EEG asymmetry during the Blocks and Written Letter Tasks: P_3 = left parietal, P_4 = right parietal, T_3 = left temporal, T_4 = right temporal. The ratio of power in homologous leads T_4/T_3 and P_4/P_3 is greater on the spatial task than on the verbal task.

"Reprinted from Galin and Ornstein, 1972."

Figure 2. Sample Fourier power spectra for Blocks and Written Letter tasks. For each lead EEG power is plotted versus frequency in 1 Hz intervals from 1-29 Hz; the last point on each plot is an average for frequencies 30-64 Hz. The ordinate is scaled in arbitrary units in which a 10 Hz sine wave of 80 microvolts p-p corresponds to 80,000 units. The ratio of alpha-band power from homologous leads T_4/T_3 and P_4/P_3 is greater on the Blocks task than on the Written Letter task. These spectra correspond to the sample EEG tracings shown in Figure 1.

"Reprinted from Doyle, Ornstein and Galin, 1973."

Figure 1

BLOCK DESIGN

723

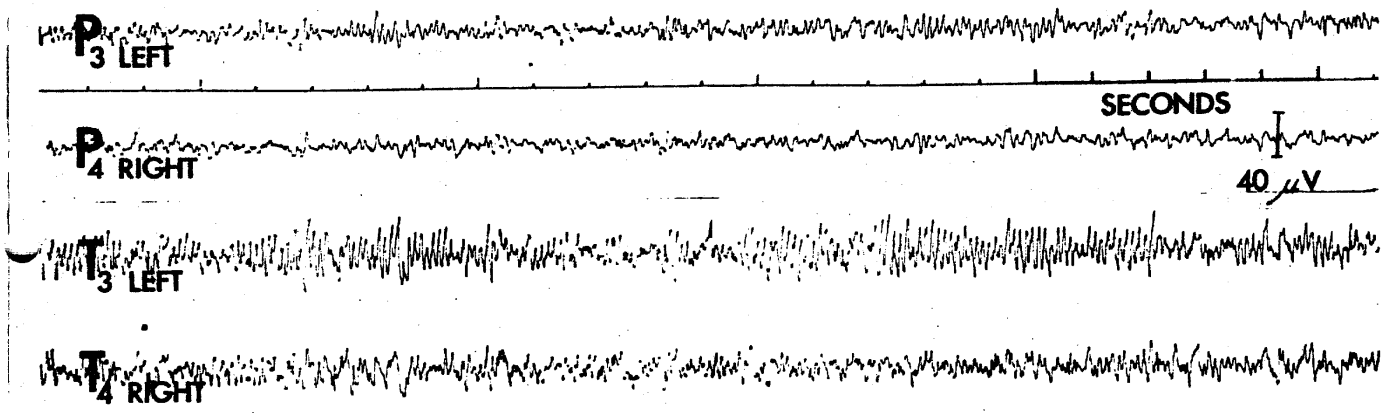

WRITTEN LETTER

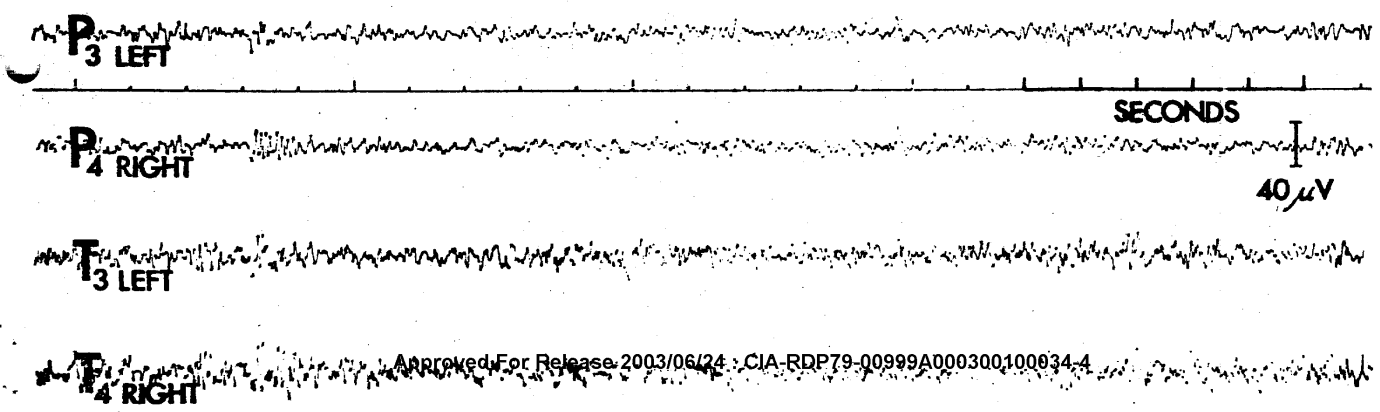

Figure 2

SAMPLE FOURIER POWER SPECTRA

Approved For Release 2003/06/24 : CIA-RDP79-00999A000300100034-4

BLOCKS

WRITTEN LETTER

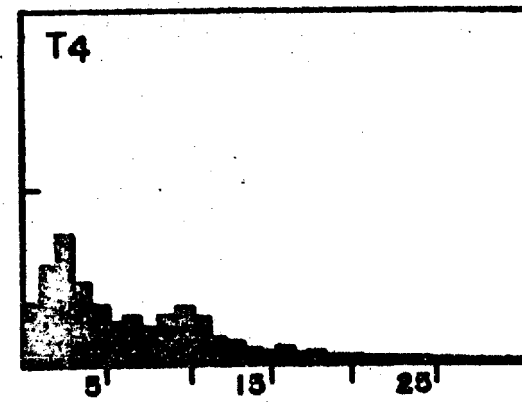
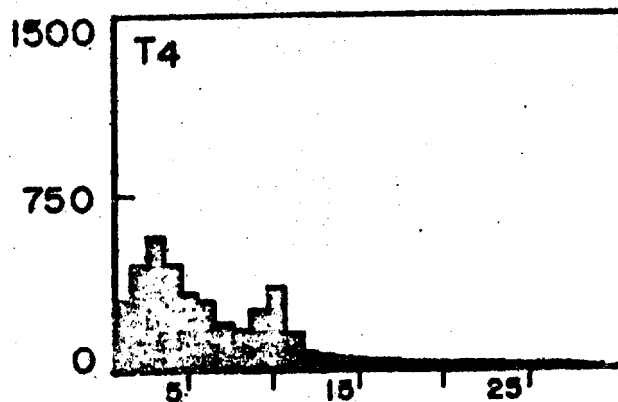
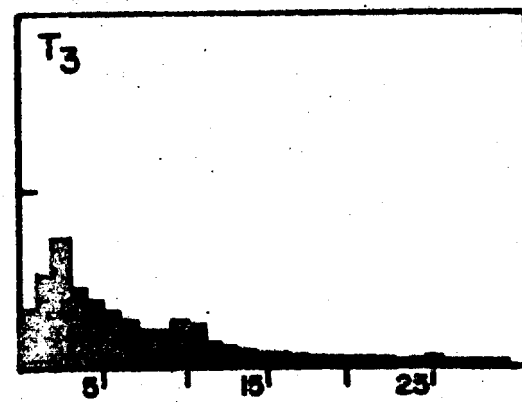
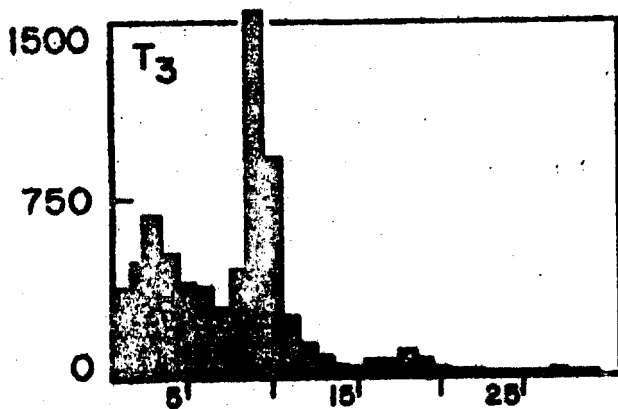
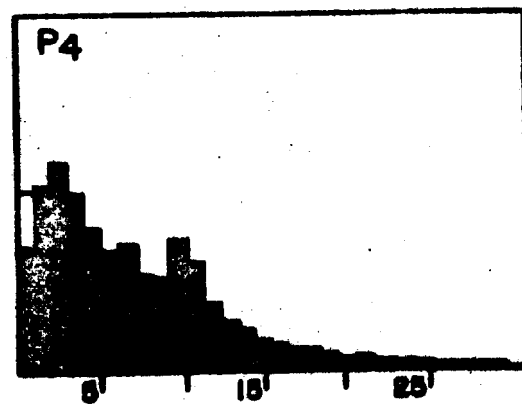
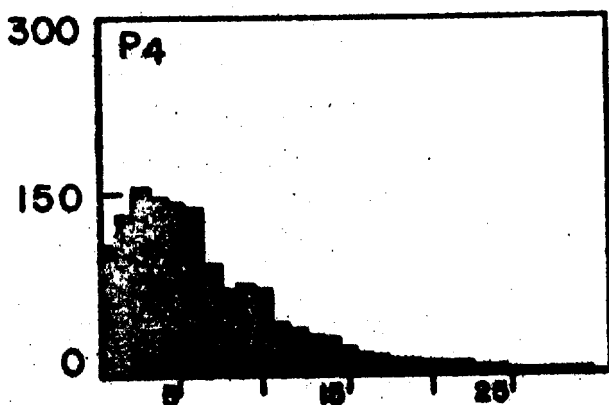
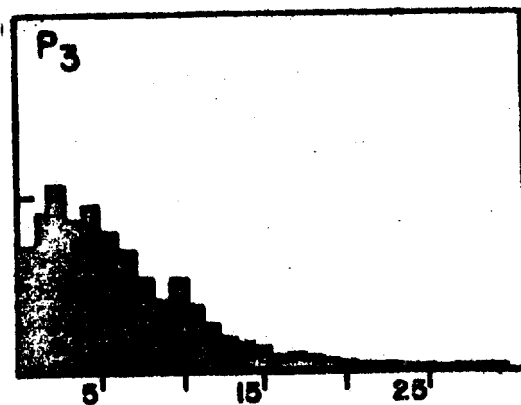
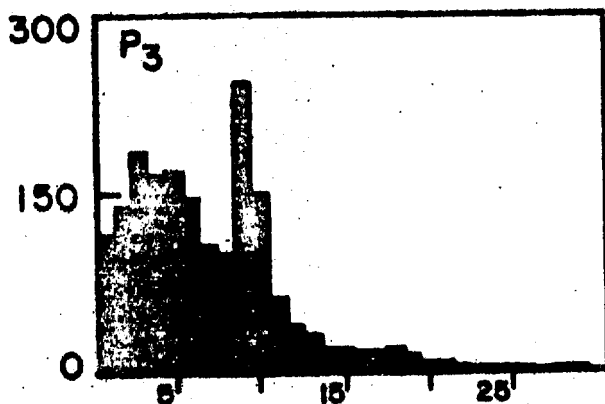

SG1A

Approved For Release 2003/06/24 : CIA-RDP79-00999A000300100034-4

Next 3 Page(s) In Document Exempt

Approved For Release 2003/06/24 : CIA-RDP79-00999A000300100034-4



ele
000

STANFORD RESEARCH INSTITUTE
Menlo Park, California 94025 · U.S.A.

12 March 1974

Progress Report No. 1
Covering the Period 28 January to 1 March 1974
Stanford Research Institute Project 3183

PERCEPTUAL AUGMENTATION TECHNIQUES

by
Harold E. Puthoff

Client Private

I OBJECTIVE

The purpose of the program is to determine the characteristics of those perceptual modalities through which individuals obtain information about their environment, wherein such information is not presented to any known sense.

The program is divided into two categories of investigation of approximately equal effort, applied research and basic research. The purpose of the applied research effort is to explore experimentally the potential for applications of perceptual abilities of interest, with special attention given to accuracy and reliability. The purpose of the basic research effort is to identify the characteristics of individuals possessing such abilities, and to identify neurophysiological correlates and basic mechanisms involved in such functioning.

II PROGRESS DURING THE REPORTING PERIOD

A. Applied Research

1. Remote Viewing

A number of efforts were begun with respect to obtaining further information concerning remote viewing phenomena. First, an experiment has been designed in consultation with SRI psychologists which will yield precise statistical data as to discrimination ability. Ten sites known to the subject are to be visited in random sequence by a target demarcation team. The subject must then make a choice as to which site is being visited, in addition to providing descriptive material for content analysis.

Secondly, a pilot series involving real-time questioning of the subject by the target team via walkie talkie is being explored to provide information for designing a protocol to investigate real-time correlations. One viewing with positive results has been carried out.

Finally, a preliminary remote viewing pilot experiment was carried out with a subject (H.H.) previously screened by the EEG correlates experiment described in our paper submitted for publication (Appendix I). The target chosen at random was a small red clapboard schoolhouse structure with a bell steeple on top in a miniature golf course. The subject's response was that she saw a red clapboard structure with a steeple that seemed to be artificial as in a movie set. Based on this result, a series of remote viewing experiments under strict protocols are planned with this subject.

2. Detection of Variable Density Target Material

Twenty-seven envelopes were submitted by the sponsor to the client containing target drawings of variable content and density. Several hundred sorting trials resulting from six passes per day through the 27 cards have been carried out, the goal to date being delineation of the twelve low density target cards from the pencil (6) and blank (9) cards. The numbered envelopes containing the target material, sealed and specially secured by the sponsor, are randomized before each trial and placed inside non-numbered opaque envelopes before being presented to the subject for sorting. Statistical analysis of the results and comparison with the key (unknown to the client) will be carried out after completion of the experimental series.

B. Basic Research

1. Testing Program

During the first month of this program, the Wechsler Adult Intelligence Scale (WAIS) instrument was administered by [redacted] of [redacted] to three subjects screened in other programs as being gifted in the area of paranormal perception. They are Mr. Patrick H. Price, screened for remote viewing ability, Mrs. Hella Hammid, screened for EEG correlates to remote stimuli, and Mr. Duane Elgin, screened for high scoring response to a random target generator. Further in-depth interviewing of the first two subjects was carried out by [redacted] and his colleague, [redacted]. A report is in preparation by [redacted] and will be available to the contract technical representatives when completed.

On the basis of discussion with technical representative, [redacted] SRI representatives have consulted with a number of Bay Area neurophysiologists concerning administration of the Halstead-Reitan (H-R) Neuropsychology Test Battery. Those contacted include Dr. Karl Pribram of the Stanford Medical School, Dr. Robert Ornstein of the Langley-Porter Neuropsychiatric Clinic, and Dr. Donald Lim of the Veteran's Administration Hospital in Palo Alto. To date satisfactory arrangements for administration of the H-R instrument have not yet been made, as only the latter facility has personnel experienced in its administration, but not ordinarily available for subcontracted consulting. The three individuals named above have, however, agreed to help locate an appropriate individual or facility to carry out such testing so no difficulty is anticipated in meeting this requirement.

A measure of the visual acuity of one subject (P.P.) was obtained utilizing one of the instruments available in the optics group of the Electronics and Bioengineering Laboratory of SRI. The measurement method involves forced-choice discrimination on the part of the subject between alternate zero and finite-contrast grating images, for each of a number of spatial-frequency gratings. (See Appendix II.)

The system, which is automated, tracks and records the subject's forced-choice responses to yield a curve of threshold (75% correct choice) contrast sensitivity as a function of spatial frequency. As might be expected, higher contrast is required at the low and high frequency tails of the distribution, as compared with the middle range, to discriminate between grating and uniform images. The purpose of the test with regard to our program was to determine whether a subject possessing an unusual ability to view remote stimuli also possessed an unusual visual acuity response in a threshold-determining instrument, either because of unusual acuity in the ordinary sense, or through the use of an extraordinary ability to discriminate between a target and a blank under conditions of vanishingly-small information content.

The resultant curve lay within the range of expected human variation indicating no unusual response activity.

2. Measurement Program

A 10-channel polygraph facility under the direction of Dr. Jerry Lukas of the Sensory Sciences Research Center has been brought into the program and certain functions tailored to our specification. The facility will be used initially to monitor GSR, blood flow (plethysmograph), and EEG activity of subjects carrying out tasks involving perception of remote stimuli. For our purposes, the display of raw data has been augmented by a computer program which has been

written and debugged to provide on-line 5-second averages of EEG activity in the theta, alpha, and beta bands. Discussions are now in progress on experimental protocols to be employed in the utilization of this facility.

EEG data taken prior to this program, but unanalyzed, has been subjected to analysis in an effort to determine whether a particular protocol was a viable instrument for defining correlates of remote perception. The description of the experiment and the results of the analysis is given in the EEG section of a paper submitted for publication to Nature, given here as Appendix I.

In an effort to determine the effects of motivation on paranormal functioning, the following test procedure has been initiated. One subject (P.P.) has completed 7075 trials on guessing the state of a four-stage electronic random target generator without monetary reward being associated with the scoring, and is now repeating the series with a monetary reward scaled to scoring. Upon completion of the series, the results will be analyzed to determine whether the difference between scoring under the two conditions is significant. The reward system, shown in Table 1, is scaled linearly with difficulty.

Table 1

REWARD SYSTEM FOR SCORING ON 25-TRIAL RUN, $P=1/4$ PER TRIAL

<u>Nr. hits/25-trial run, N</u>	<u>Prob. of at least N hits</u>	<u>Reward</u>
10	0.071	\$ 1
11	0.030	2
12	0.010	5
13	0.0034	12
14	0.00092	35

INFORMATION TRANSMISSION UNDER CONDITIONS OF SENSORY SHIELDING

Russell Targ

Harold Puthoff

Electronics and Bioengineering Laboratory

Stanford Research Institute

Menlo Park, California

FIGURE CAPTIONS

1. Target pictures and responses drawn by Uri Geller under shielded conditions.
2. Computer drawings and responses drawn by Uri Geller.
 - a. Computer drawing stored on video display
 - b. Computer drawing stored in computer memory only
 - c. Computer drawing stored on video display with zero intensity
3. Occipital EEG spectra, 0 to 20 Hz, for one subject (H.H.) acting as receiver, showing amplitude changes in the 9 - 11 Hz band as a function of strobe frequency. Three cases: 0, 6, and 16 flashes per second (12 trial averages).

INTRODUCTION

In this paper we present results of experiments suggesting the existence of one or more perceptual modalities through which individuals obtain information about their environment, wherein this information is not presented to any known sense. Such perceptual abilities are often considered to be paranormal. The literature in the field¹⁻³ coupled with our own observations have led us to conclude that such abilities can be studied under laboratory conditions.

The phenomena we have investigated most extensively pertain to the ability of certain individuals to describe graphical material or remote scenes shielded against ordinary perception. In addition, we also performed pilot studies to determine if electroencephalographic (EEG) recordings might indicate perception of remote happenings even in the absence of correct overt responses.

In these experiments we concentrated on what we considered to be our primary responsibility--namely, to resolve under conditions as unambiguous as possible the basic issue of whether a certain class of paranormal perception phenomena exists. Therefore, we conducted our experiments with sufficient control, utilizing visual, acoustic, and electrical shielding, to ensure that all conventional paths of sensory input were blocked. At all times we were vigilant in the design of our experiments to take measures to prevent sensory leakage and to prevent deception, whether intentional or unintentional, on the part of our subjects.

The overall goal of our research program is the determination of the laws underlying these phenomena. That is, our goal is not just to catalog interesting events, but rather to uncover patterns of cause-effect relationships that lend themselves to analysis and hypothesis in the forms with which we are familiar in scientific study. The results presented here constitute a first step toward that goal, in that we have established under known conditions a data base from which departures as a function of physical and psychological variables can be studied in future work.

In this paper we describe three related experiments which we consider to represent a single ability exhibiting different rates of information transmission. First, we conducted experiments with Mr. Uri Geller in which we examined his ability, while located in an electrically shielded room, to reproduce target pictures drawn by experimenters located at remote locations. Second, we conducted double-blind experiments with two individuals, Mr. Ingo Swann and Mr. Pat Price, in which we measured their ability to describe remote outdoor scenes many miles from their physical location. Finally, we conducted preliminary tests using electroencephalograms (EEG), in which subjects were asked to perceive whether a remote light was flashing, and to determine whether a subject could perceive the presence of the light, even if only at a noncognitive level of awareness.

REMOTE PERCEPTION OF GRAPHIC MATERIAL

We describe here a series of experiments in paranormal perception with a 27 year old Israeli subject, Uri Geller. In preliminary testing Mr. Geller apparently demonstrated an ability to reproduce simple pictures

(line drawings) which had been drawn and placed in opaque sealed envelopes which Mr. Geller was not permitted to handle. However, since each of the targets was known to at least one experimenter in the room with Mr. Geller, it was not possible on the basis of the preliminary testing to discriminate between Mr. Geller's direct perception of envelope contents and perception via some mechanism involving the experimenters, whether paranormal or subliminal.

Therefore, an experimental study was undertaken to examine the phenomenon under conditions specifically designed to eliminate all conventional information channels, overt or subliminal. This was accomplished by separating Mr. Geller from both the target material and anyone knowledgeable of the target material, as in the recent experiments by Musso and Granero.⁴

The first part of the study consisted of a series of thirteen separate drawing experiments carried out over a seven day period. The thirteen-experiment data set constitutes the entire set of consecutive experiments carried out in the time available for the study, with no experiments deleted.

The protocol for the experiments was as follows: At the beginning of the experiment either Mr. Geller or the experimenters entered a shielded room so that from that time forward Mr. Geller was at all times visually, acoustically, and electrically shielded from personnel and material at the target location. Only following Mr. Geller's isolation from the experimenters was a target chosen and drawn, a procedure designed to eliminate pre-experiment cueing. The method of target selection involved random procedures, such as randomly opening a dictionary and selecting the first word describing an object that could reasonably be drawn. Furthermore,

in order to eliminate the possibility of pre-experiment target forcing, Mr. Geller was kept ignorant as to the identity of the person selecting the target and as to the method of target selection. Mr. Geller's task was then to reproduce with pen on paper the line drawing being generated by the experimenters at the target location. Following a period of effort ranging from a few minutes to half an hour, Mr. Geller either passed (when he did not feel confident) or indicated he was ready to submit a drawing to the experimenters, in which case the drawing was collected before Mr. Geller was permitted to see the target.

In order to prevent sensory cueing of the target information, Experiments 1 through 10 were carried out using a shielded room in SRI's facility for EEG research. The degree of acoustic and visual isolation provided for this experiment is that afforded by a double-walled steel room, locked by means of an inner and outer door, each of which is secured with a refrigerator-type locking mechanism. The person inside the room is continuously monitored by means of a one-way audio monitor. The target picture was never discussed by the experimenters after the picture was drawn or brought near the shielded room. In our detailed examination of the shielded room and the protocol used in these experiments, no sensory leakage has been found.

The conditions and results for the ten experiments carried out in the shielded room are displayed in Table 1. As indicated in the Table, all experiments, except Experiments 4 and 5, were conducted with Mr. Geller closeted inside the shielded room. In Experiments 4 and 5, the procedure was reversed--i.e., the target was located inside the shielded room, with

TABLE 1. SUMMARY: REMOTE PERCEPTION OF GRAPHIC MATERIAL

<u>Experiment</u>	<u>Date</u>	<u>Geller Location</u>	<u>Target Location</u>	<u>Target</u>	<u>Figure</u>
1	8/4/73	Shielded room #1 ^a	Adjacent room (4.1 m) ^b	Firecracker	1a
2	8/4/73	Shielded room #1	Adjacent room (4.1 m)	Grapes	1b
3	8/5/73	Shielded room #1	Office (475 m)	Devil	1c
4	8/5/73	Room adjacent to shielded room #1	Shielded room #1 (3.2 m)	Solar system	1d
5	8/6/73	Room adjacent to shielded room #1	Shielded room #1 (3.2 m)	Rabbit	No drawing
6	8/7/73	Shielded room #1	Adjacent room (4.1 m)	Tree	No drawing
7	8/7/73	Shielded room #1	Adjacent room (4.1 m)	Envelope	No drawing
8	8/8/73	Shielded room #1	Remote room (6.75 m)	Camel	1e
9	8/8/73	Shielded room #1	Adjacent room (4.1 m)	Bridge	1f
10	8/8/73	Shielded room #1	Adjacent room (4.1 m)	Seagull	1g
11	8/9/73	Shielded room #2 ^c	Computer (54 m)	Kite (computer CRT)	2a
12	8/10/73	Shielded room #2	Computer (54 m)	Church (computer memory)	2b
13	8/10/73	Shielded room #2	Computer (54 m)	Arrow through heart (computer CRT, zero intensity)	2c

^aEEG Facility shielded room (see text).

^bPerceiver-target distances measured in meters.

^cSRI Radio Systems Laboratory shielded room (see text).

Mr. Geller on the outside in an adjacent room. For those experiments in which Mr. Geller was inside the shielded room, the target location was in an adjacent room at a distance of about 4 meters, except for Experiments 3 and 8, in which the target locations were, respectively, an office at a distance of 475 meters and a room down the hall at a distance of about 7 meters.

In Experiment 1, the object drawn on the basis of random dictionary selection was a firecracker, shown in Fig. 1(a). Mr. Geller's immediate verbal response via the audio monitor was that he saw "a cylinder with noise coming out of it." He made two responses to the target, also shown in Fig. 1(a).

In Experiment 2, the target--also chosen by random dictionary selection--was a cluster of grapes. Mr. Geller said that he was quite certain that he had the picture. Both the target picture and Mr. Geller's response have 24 grapes in the cluster (Fig. 1(b)).

In Experiment 3, Mr. Geller was locked in the shielded room with one experimenter outside as a monitor while the target was drawn in another building 475 meters away. The target, again randomly selected from the dictionary, was a devil (Fig. 1(c)). Mr. Geller spent 30 minutes on his drawing and expressed considerable difficulty in getting the target. The results are interesting from the standpoint of possible insight into the process that they provide. His drawings consisted of representations of Biblical symbology, including the "Moses tablets," an apple with a worm, a snake, and a concluding composite picture with the tablets on top of the world and the trident outside. Of these only the trident corresponds

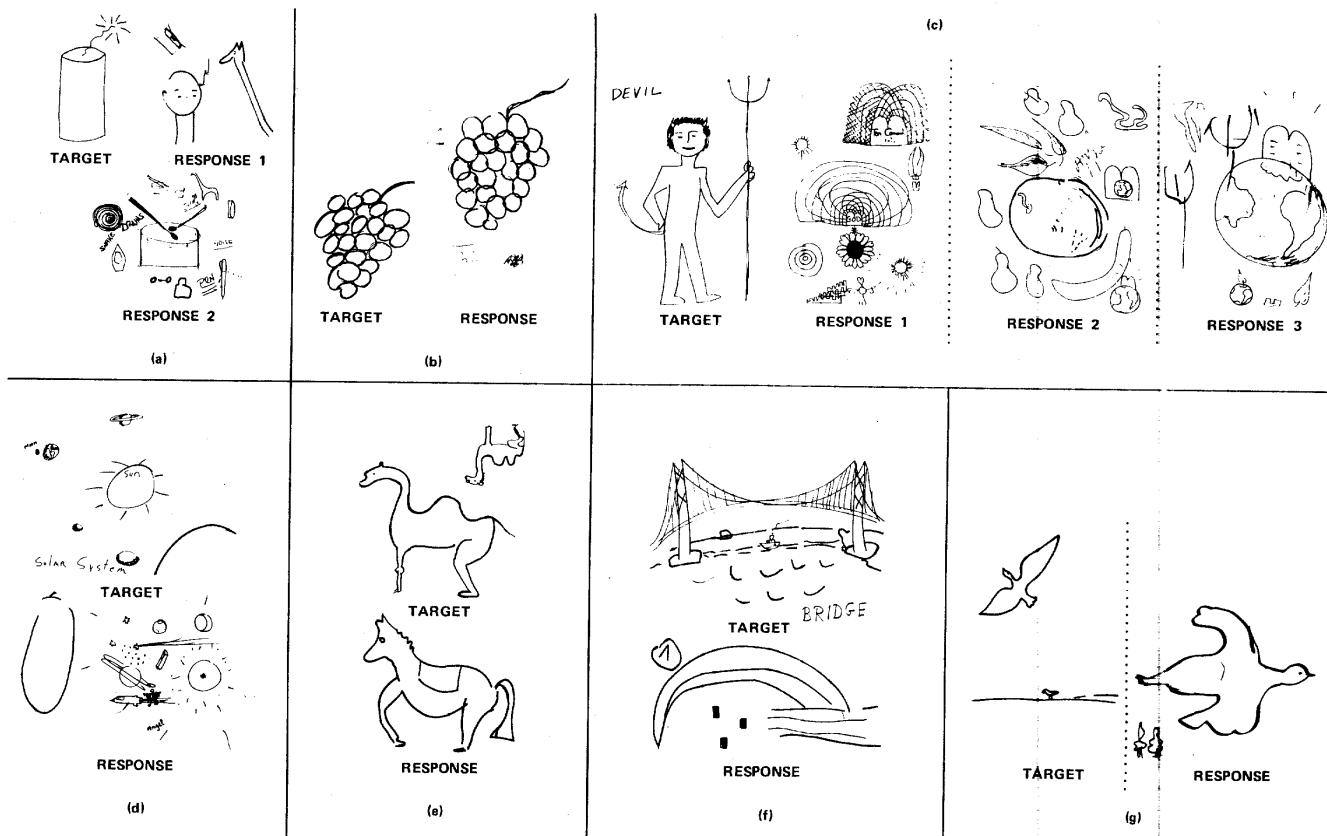

FIGURE 1 GRAPHICAL MATERIAL CONSISTING OF TARGET PICTURES AND RESPONSES DRAWN BY URI GELLER UNDER SHIELDED CONDITIONS

directly to an element in the target drawing. One is led to speculate that the Biblical elements in these three drawings are perhaps associational material triggered by the target.

The target picture for Experiment 4 was drawn by an experimenter while he was inside the shielded room, with Mr. Geller outside the room with another experimenter. In this case the target (Fig. 1(d)) was a representation of the solar system. Mr. Geller's response to the target while outside the room coincides quite well with the target drawing.

In Experiment 5, the person-to-person link was eliminated by arranging for a scientist outside the usual experimental group to draw a picture, lock it in the shielded room before Mr. Geller's arrival at SRI, and leave the area. Mr. Geller was then led by the experimenters to the shielded room and asked to draw the picture inside the room. He said that he got no clear impression and therefore did not submit a drawing. The elimination of the person-to-person link was examined further in the second series of experiments with this subject, which is described later.

Experiments 6 and 7 were carried out while we recorded Mr. Geller's EEG during his efforts to perceive the target pictures. The target pictures were, respectively, a tree and an envelope. He found it difficult to hold adequately still for good EEG records, said that he experienced difficulty in getting impressions of the targets, and again submitted no drawings.

For Experiment 8, the target picture was a camel and Mr. Geller's response was a horse (Fig. 1(e)). In Experiment 9, the target was a bridge. Mr. Geller's drawing bears some resemblance to the target (Fig. 1(f)), but before seeing the target picture he stated that he did not know what the picture was.

At the beginning of Experiment 10, Mr. Geller expressed extreme confidence and entered the shielded room. The target then chosen for Experiment 10 was a bird in flight. Mr. Geller said almost immediately, via the audio monitor in the shielded room, that he saw a swan flying over a hill and that he was sure that his drawing was correct (Fig. 1(g)).

Experiments 11 through 13 were carried out in SRI's Engineering Building, to make use of the computer facilities available there. For these experiments, Mr. Geller was secured in a double-walled, copper-screen Faraday cage 54 meters down the hall and around the corner from the computer room.[†]

For Experiment 11, a picture of a kite was drawn by one of the experimenters on the face of a cathode ray tube display screen, driven by the computer's graphics program. Mr. Geller's response, shown in Fig. 2(a), was a square with diagonals.

For Experiment 12, a picture of a church was drawn and stored in the memory of the computer. Mr. Geller's responses are shown in the drawings of Fig. 2(b). Although his responses have some elements in common with the target drawing, he did not recognize the target as a church.

In Experiment 13, the target drawing, an arrow through a heart (Fig. 2(i)), was drawn on the face of the cathode ray tube and then the display intensity was turned off so that no picture was visible. Mr. Geller immediately

[†]The Faraday cage provides 120 dB attenuation for plane wave radio frequency radiation over a range of 15 KHz to 1 GHz. For magnetic fields the attenuation is 68 dB at 15 KHz and decreases to 3 dB at 60 Hz.

10

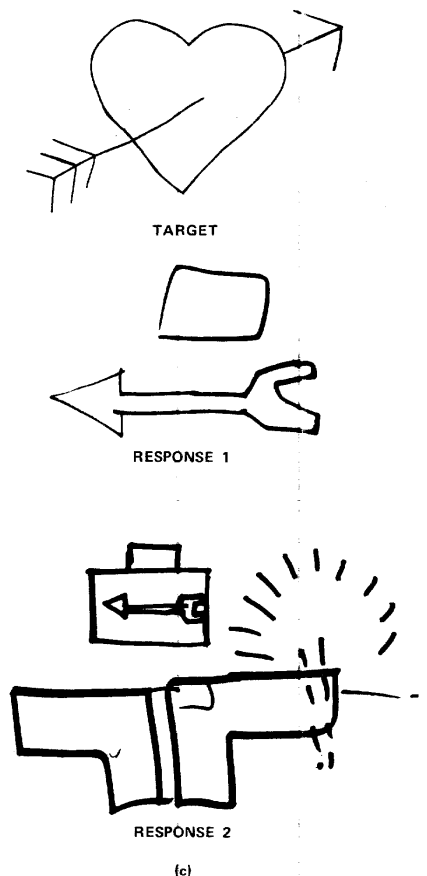
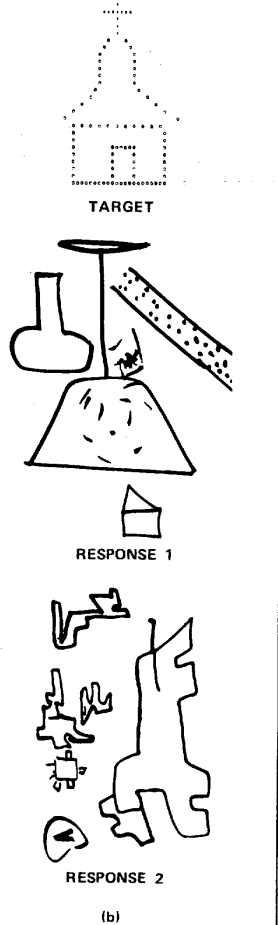
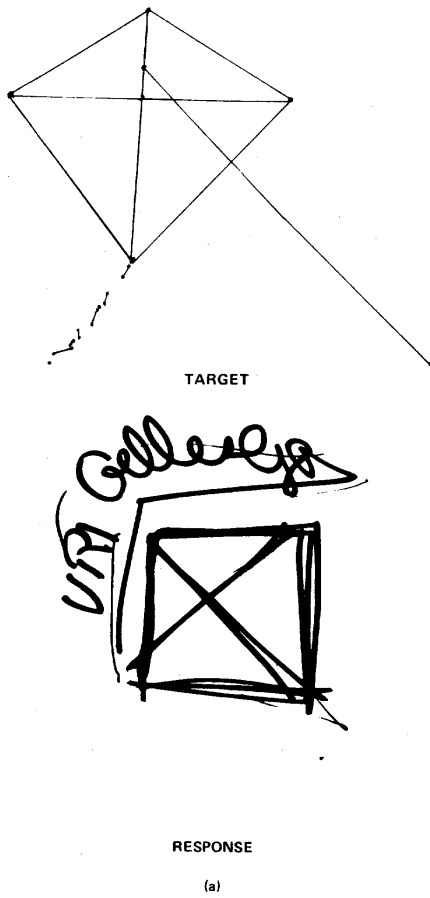

FIGURE 2 GRAPHICAL MATERIAL FROM COMPUTER DRAWING EXPERIMENTS WITH URI GELLER. (a) PICTURE STORED ON PAPER DISPLAY WITH ZERO INTENSITY. (b) PICTURE STORED ON VIDEO DISPLAY WITH ZERO INTENSITY. (c) PICTURE STORED ON VIDEO DISPLAY WITH ZERO INTENSITY.

drew an arrow under a rectangle and then drew another arrow inside a suitcase, which he considered a better representation of the target.

To obtain an independent evaluation of the correlation between target and response data, the experimenters submitted the data for judging on a "blind" basis by two SRI scientists who were not otherwise associated with the research. For the ten cases in which Mr. Geller provided a response, the judges were asked to match the response data with the corresponding target data (without replacement). In those cases in which Mr. Geller made more than one drawing as his response to the target, all the drawings were combined as a set for judging. The two judges each matched the target data to the response data with no error. For either judge such a correspondence has an a priori probability, under the null hypothesis of no information channel, of $p = (10!)^{-1} \cong 3 \times 10^{-7}$.

The quality of match between target and response in certain cases, together with the overall probability of matching obtained by the judges, constitute strong evidence for the existence of a potentially useful information channel.

A second series of experiments was carried out to determine whether direct perception of envelope contents was possible without some person knowing of the target picture.

One hundred target pictures of everyday objects were drawn by an SRI artist and sealed by other SRI personnel in double envelopes containing black cardboard. The hundred targets were divided randomly into groups of 20 for use in each of the three days' experiments.

On each of the three days of these experiments, Mr. Geller passed. That is, he declined to associate any envelope with a drawing that he made. On each day he made approximately 12 recognizable drawings, which he felt were associated with the entire target pool of 100. He seemed to be disturbed by the existence of such a large target pool. On each of the three days, two of his drawings could reasonably be associated with two of the 20 daily targets. On the third day, two of his drawings were very close replications of two of that day's target pictures. We consider that the drawings resulting from this experiment do not depart significantly from what would be expected by chance, which appeared to be Mr. Geller's conclusion also, leading to passes on his part.

Thus, it would appear that eliminating a person knowledgeable of the target degrades the quality of the information channel. However, based on Mr. Geller's subjective impression, there is also the possibility that advance preparation of a large target pool, in comparison with single target preparation, results in cross talk--i.e., diffuses the identity of the target.

In a simpler experiment Mr. Geller was successful in obtaining information in which no persons were knowledgeable of the target. A double blind experiment was performed in which a single die was placed in a small steel box. The box was then vigorously shaken by one of the experimenters and placed on the table. The orientation of the die within the box was unknown to the experimenters at that time. Mr. Geller would then write down his perception as to which die face was uppermost. Thus, in this

case the target pool was known, but the targets were individually prepared in a manner blind to all persons involved in the experiment. This experiment was performed ten times, with Mr. Geller passing twice and giving a response eight times. In the eight times in which he gave a response, he was correct each time.[†] The probability of this occurring by chance is approximately one in a million, $(1/6)^8$.

To summarize the work with Mr. Geller,⁵ we observe that in certain situations significant information transmission can take place under shielded conditions. Factors which appear to be important and therefore candidates for future investigation include whether the subject knows the set of targets in the target pool, the actual number of targets in the target pool at any given time, and whether the target is known by any of the experimenters.

REMOTE VIEWING OF NATURAL TARGETS

In experiments carried out in our program to investigate the abilities of a New York artist, Mr. Ingo Swann, he expressed the opinion that the insights gained during experiments at SRI had strengthened his ability to view remote locations that had been researched before he joined the SRI program.⁶

To test Mr. Swann's assertion, a pilot study was set up in which a

[†]The distribution of responses consisted of three 2s, one 4, two 5s, and two 6s.

series of targets from around the globe were supplied to the experimenters by SRI personnel on a double-blind basis. In our estimation, Mr. Swann's ability to describe correctly details of buildings, roads, bridges, and the like indicated that he could perceive remote locations, sometimes in great detail, given only their geographic latitude and longitude. Thus, we considered the descriptions were sufficiently accurate to warrant our setting up a research program in remote viewing.

We present here the results of a remote viewing experiment, carried out with a second subject in the remote viewing program, Mr. Pat Price, a former California police commissioner and city councilman. This experiment consisted of a series of double-blind, demonstration-of-ability tests involving local targets in the San Francisco Bay area which could be documented by several independent judges. We planned the experiment considering that natural geographical places or man-made sites that have existed for a long time are more potent targets for paranormal perception experiments than are artificial targets prepared in the laboratory. This is based on the opinions of Mr. Swann and Mr. Price that the use of artificial targets involves a "trivialization of the ability" as compared with natural pre-existing targets.

In each of nine experiments involving Mr. Price as remote-viewing subject and SRI experimenters as a target demarcation team, a remote location was chosen in a double-blind protocol. Mr. Price, who remained at SRI, was asked to describe this remote location, as well as whatever activities might be going on there.

Data from the nine experiments are presented in the following paragraphs. Final judging indicated that several descriptions yielded significantly correct data pertaining to and descriptive of the target location.

REMOTE VIEWING PROTOCOL

In the nine double-blind remote-viewing experiments, the following procedures were used. An experimenter was closeted with Mr. Price at SRI to wait 30 minutes to begin the narrative description of the remote location. The SRI locations from which the subject viewed the remote locations consisted of an outdoor park (Experiments 1,2), the double-walled copper-screen Faraday cage discussed earlier (Experiments 3, 4, 6-9), and an office (Experiment 5).

A second experimenter would then obtain a target location from an individual in SRI management, the director of the Information Science and Engineering Division, not otherwise associated with the experiment. This location was either in the form of traveling orders previously prepared, sealed, and randomized by the target selector (Experiments 1, 2, 5, 6), or by his driving the target demarcation team to the target himself without any written indication (Experiments 3, 4, 7-9). The set of targets was chosen from a target-rich environment by asking the selector to use his judgment in providing a set of nine target locations which were clearly differentiated from each other and within thirty minutes driving time from SRI. In all cases, the target demarcation team proceeded directly to the target by automobile without communicating with the subject

or experimenters remaining behind. Since the experimenter remaining with the subject at SRI was in ignorance both as to the particular target and also as to the target pool, he was free to question Price to clarify his descriptions. The demarcation team then remained at the target site for an agreed-upon thirty minute period following the thirty minutes allotted for travel. During the observation period, the remote-viewing subject would describe his impressions of the target site into a tape recorder. A comparison was then made when the demarcation team returned. To represent best the detail and style of these narratives, we have included the entire unedited text of one of the better narratives containing very few incorrect statements, Experiment 7, in an appendix.

In general, the descriptions contained inaccuracies as well as correct statements. To obtain a numerical evaluation of the accuracy of the remote viewing experiment, the nine original target locations were subjected to independent judging on a blind basis by five SRI scientists who were not otherwise associated with the research. The judges were asked to match the nine locations, which they independently visited, against the typed manuscripts of the tape-recorded narratives of the remote viewer. The transcripts were unlabeled and presented in random order. The judges were asked to find a narrative which they would consider the best match for each of the places they visited. A given narrative could be assigned to more than one target location. The hypothesis is that the judges, when asked to match the actual targets with the transcripts, would place the actual target in the most favored category more often than they would be expected to by chance. Table 2 shows the distribution of the

DESCRIPTIONS CHOSEN BY JUDGES		PLACES VISITED BY JUDGES								
		1	2	3	4	5	6	7	8	9
Hoover Tower	1	ABC DE				D				
Baylands Nature Preserve	2		ABC	E				D		D
Radio Telescope	3			ACD		BE				
Redwood City Marina	4		CD		ABD E		E			
Bridge Toll Plaza	5						ABD		DCE	
Drive-In Theatre	6			B		A	C			E
Arts and Crafts Garden Plaza	7							ABC E		
Church	8				C				AB	
Rinconada Park	9		CE							AB

17

TABLE 2. Distribution of correct selections by Judges A, B, C, D, and E in remote viewing experiments. Of the 45 selections (5 judges, 9 choices), 24 were correct. Boxes heavily outlined indicate correct choice.

judges' choices. For purposes of display we present the table such that the main diagonal corresponds to the correct choices. The number of correct matches by judges A through E is 7, 6, 5, 3, and 3, respectively. The expected number of correct matches from the five judges was five; in the experiment twenty-four such matches were obtained.

Among all possible analyses, none is more conservative than a permutation analysis of the majority vote of the judges' selections assuming assignment without replacement. By majority vote, six of the nine descriptions and locations were correctly matched. Under the null hypothesis (no remote viewing and a random selection of descriptions without replacement), this outcome has an a priori probability of $p = 5.6 \times 10^{-4}$, since, among all possible permutations of the integers one through nine, the probability of six or more being in their natural position in the list has that value. Therefore, although Price's descriptions contain inaccuracies, the descriptions are sufficiently accurate to permit the judges to differentiate among the various targets to the degree indicated.

EEG EXPERIMENTS

An experiment was undertaken to determine whether a physiological measure such as EEG activity could be used as an indicator of information transmission between an isolated subject and a remote stimulus. We hypothesized that perception could be indicated by such a measure even in the absence of verbal or other overt indicators.^{7,8} In other words, this experiment examines the hypothesis that perception may take place

at noncognitive levels of awareness and be measurable, even though not expressed verbally.

It was assumed that the application of remote stimuli would result in responses similar to those obtained under conditions of direct stimulation. For example, when normal subjects are stimulated with a flashing light, their EEG typically shows a decrease in the amplitude of the resting rhythm and a driving of the brain waves at the frequency of the flashes.⁹ We hypothesized that if we stimulated one subject in this manner (a sender), the EEG of another subject in a remote room with no flash present, (a receiver), might show changes in alpha (9-11 Hz) activity, or possibly EEG driving similar to that of the sender.

Applying this concept, we informed our subject that at certain times a light was to be flashed in a sender's eyes in a distant room, and if the subject perceived that event, consciously or unconsciously, it might be evident from changes in his EEG output. The receiver was seated in the visually opaque, acoustically and electrically shielded double-walled steel room previously described. The sender was seated in a room across the hall from the EEG chamber at a distance of about 7 meters from the receiver.

In order to find subjects who were responsive to such a remote stimulus, we initially worked with four female and two male volunteer subjects, all of whom believed that success in the experimental situation might be possible. These were designated "receivers." The senders were either other subjects or the experimenters. We decided beforehand to run one or two sessions of 36 trials each with each subject in this selection procedure, and to do a more extensive study with any subject

whose results were positive.

A Grass PS-2 photostimulator placed about 1 meter in front of the sender was used to present flash trains of 10 sec duration. The receiver's EEG activity from the occipital region (O_2), referenced to linked mastoids, was amplified with a Grass 5P-1 preamplifier and associated driver amplifier with a bandpass of 1 to 120 Hz. The EEG data were recorded on magnetic tape with an Ampex SP 300 recorder.

On each trial, a tone burst of fixed frequency was presented to both sender and receiver, and was followed in one second by either a ten-second train of flashes or a null flash interval presented to the sender. Thirty-six such trials were given in an experimental session, consisting of 12 null trials--i.e., no flashes following the tone--12 trials of flashes at 6 fps, and 12 trials of flashes at 16 fps, all randomly intermixed. Each of the trials generated an 11-second EEG epoch. The last 4 seconds of the epoch was selected for analysis to minimize the desynchronizing action of the warning cue. This 4-second segment was subjected to Fourier analysis on a LINC 8 computer.

Spectrum analyses gave no evidence of EEG driving in any receiver, although in control runs the receivers did exhibit driving when physically stimulated with the flashes. However, of the six subjects studied initially, one subject (H.H.) showed a consistent alpha blocking effect. We therefore undertook further study with this subject.

Data from 7 sets of 36 trials each were collected from this subject on three separate days. This comprises all the data collected to date with this subject under the test conditions described above. The alpha

band was identified from average spectra, then scores of average power and peak power were obtained from individual trials and subjected to statistical analysis.

Of our six subjects, H.H. had by far the most monochromatic EEG spectrum. Figure 3 shows an overlay of the three averaged spectra from one of this subject's 36-trial runs, displaying changes in her alpha activity for the three stimulus conditions.

Mean values for the average power and peak power for each of the seven experimental sets were given in Table 3. The power measures were less in the 16 fps case than in the 0 fps in all seven peak power measures and in six out of seven average power measures.

Siegel's two-tailed t approximation to the nonparametric randomization test¹⁰ was applied to the data from all sets, which included two sessions in which the sender was removed. Average power on trials associated with the occurrence of 16 fps was significantly less than when there were no flashes ($t = 2.09$, $df = 118$, $p < .04$). The second measure, peak power, was also significantly less in the 16 fps conditions than in the null condition ($t = 2.16$, $df = 118$, $p < .03$). The average response in the 6 fps condition was in the same direction as that associated with 16 fps, but the effect was not statistically significant.

Spectrum analyses of control recordings made from saline with 12K ohms resistance in place of the subject with and without the addition of a 10 Hz, 50 μ V test signal applied to the saline solution, revealed no indications of flash frequencies, nor perturbations of the 10 Hz signal. These controls suggest that the results were not due to system artifacts.

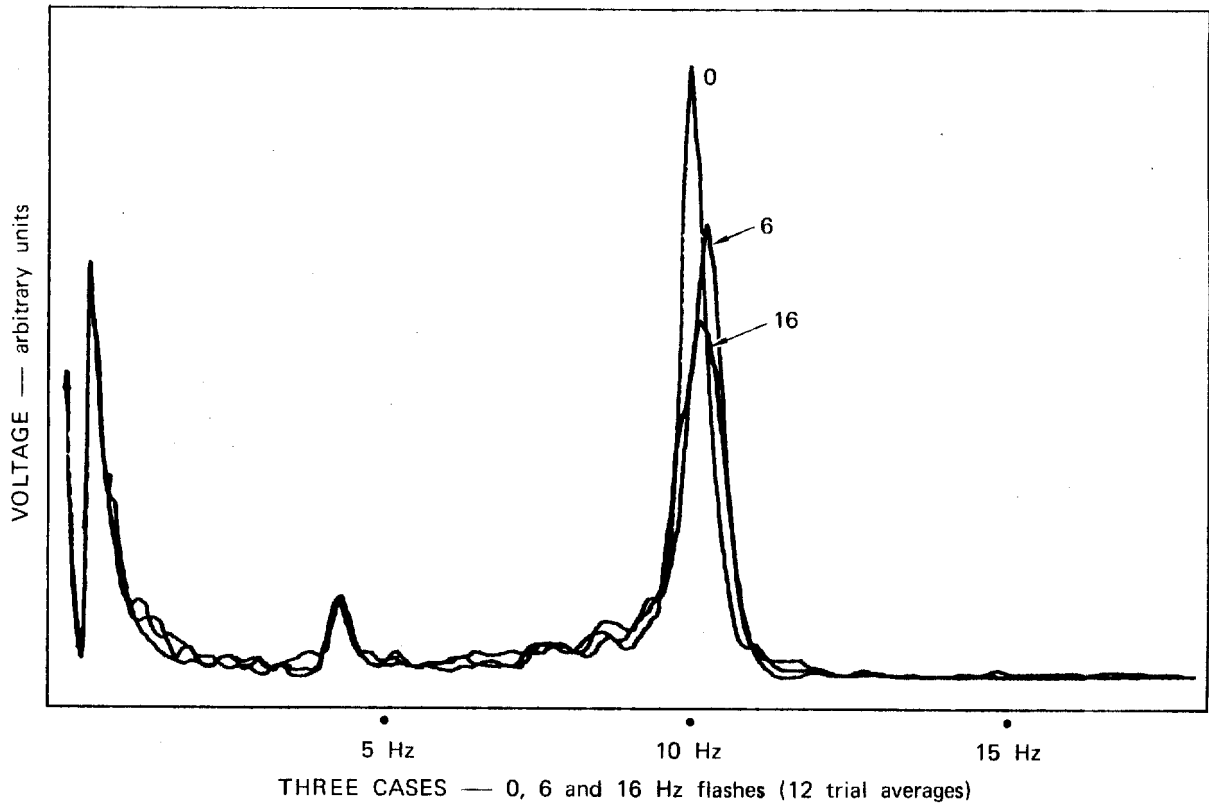

FIGURE 3 OCCIPITAL EEG FREQUENCY SPECTRA, 0 TO 20 Hz, OF ONE SUBJECT (H.H.) ACTING AS RECEIVER SHOWING AMPLITUDE CHANGES IN THE 9-11 Hz BAND AS A FUNCTION OF STROBE FREQUENCY

Flash Frequency Sender	Average Power			Peak Power		
	0	6	16	0	6	16
J.L.	94.8	84.1	76.8	357.7	329.2	289.6
R.T.	41.3	45.5	37.0	160.7	161.0	125.0
No Sender (Subject informed)	25.1	35.7	28.2	87.5	95.7	81.7
J.L.	54.2	55.3	44.8	191.4	170.5	149.3
J.L.	56.8	50.9	32.8	240.6	178.0	104.6
R.T.	39.8	24.9	30.3	145.2	74.2	122.1
No Sender (Subject not informed)	86.0	53.0	52.1	318.1	180.6	202.3
Averages	56.8	49.9	43.1	214.5	169.8	153.5
		-12%	-24% (P<.04)		-21%	-28% (P<.03)

TABLE 3. EEG data for H.H. showing average power and peak power in the 9 - 11 Hz band, as a function of flash frequency and sender. Each table entry is an average over 12 trials.

Further tests also gave no evidence of radio frequency energy associated with the stimulus.

Subjects were asked to indicate their conscious assessment for each trial as to which stimulus was generated. They made their guesses known to the experimenter via one-way telegraphic communication. An analysis of these guesses has shown them to be at chance, indicating the absence of any supraliminal cueing.

Thus, we note that in this pilot study, one of six subjects showed significant EEG changes associated with the presence of remote stimuli under conditions of sensory shielding. This form of noncognitive arousal evidenced by alpha blocking has also been observed by Tart (1963), using a small electric shock stimulus applied to himself as sender in a similar experiment.⁷ We hypothesize that the protocol described here may prove to be useful as a screening procedure for latent remote perceptual ability in the general population.

DISCUSSION

We have presented evidence for the existence of a biological information channel whose characteristics appear to fall outside the range of known perceptual modalities. The precise nature of the channel or channels is as yet undefined, but may involve either direct perception of hidden information content, perception of mental images of persons knowledgeable of target information, precognition, or some combination of these or other information channels.

We have worked with three individuals, two of whom are reported on in detail here, whose remote perceptual abilities were sufficiently developed that they were able to describe both pictorial and geographical material blocked from ordinary perception.

In addition to experiments which centered on subjects' conscious perceptions, we have also conducted EEG experiments in which we have found statistically significant evidence of direct physiological indications of nonconscious perception of remote stimuli. The observation that a nonconscious link with physiological correlates can exist between separated individuals is one that merits considerable study.

From these experiments we conclude that

- A channel exists whereby information about a remote location can be obtained by means of an as yet unidentified perceptual modality.
- As with all biological systems, the information channel appears to be imperfect, containing noise along with the signal.
- While a quantitative signal-to-noise ratio in the information-theoretical sense cannot as yet be determined, the results of our experiments indicate that the functioning is at the level of useful information transfer.

It may be that remote perceptual ability is widely distributed in the general population, but because the perception is generally below an individual's level of awareness, it is repressed or not noticed. For example, two of our subjects (H.H. and P.P.) had not considered themselves to have unusual perceptual ability before their participation in these

experiments. We conjecture that it is partially the prevailing philosophical attitudes of the times in which we live that prevent such ability as may exist from surfacing to a greater extent. Our shared cultural constraints deny permission for the demonstration of such abilities.

With regard to the methodology itself, our observation of the phenomena leads us to conclude that experiments in the area of so-called paranormal phenomena can be scientifically conducted. The results presented here offer a basis from which departures as a function of other observables can be studied. Our goal for future experimentation is the investigation of the physical and psychological laws underlying these phenomena, rather than just the addition of further demonstrations of the statistical appearance of paranormal phenomena in the laboratory.

ACKNOWLEDGMENTS

This research was sponsored by The Foundation for Parasensory Investigation, New York City. We wish to thank its president, Mrs. Judith Skutch, and their representative, Dr. Edgar D. Mitchell of the Institute of Noetic Sciences--as well as our SRI associates, Mr. Bonnar Cox, Mr. Earle Jones, and Dr. Dean Brown--for their support and encouragement throughout this work. We also wish to acknowledge Dr. Wilbur Franklin of Kent State University for his contribution, especially in the early phases of this research. Finally, we acknowledge the many constructive suggestions provided us through conversations with Mrs. Jean Mayo, Dr. Charles Tart, University of California, and Dr. Robert Ornstein and Dr. David Galin of the Langley Porter Neuropsychiatric Institute.

REFERENCES

1. J. Pratt, J.B. Rhine, C. Stuart and J. Greenwood, EXTRA SENSORY PERCEPTION AFTER SIXTY YEARS, New York, Henry Holt, 1940.
2. S. Soal and F. Bateman, MODERN EXPERIMENTS IN TELEPATHY, London, Faber and Faber, 1954.
3. L.L. Vasilliev, EXPERIMENTS IN MENTAL SUGGESTION, Hampshire, England, ISMI Publications, 1963.
4. J.R. Musso and M. Granero, "An ESP Drawing Experiment With a High-Scoring Subject," J. of Parapsychology, Vol. 37, pp. 13-37, March, 1973.
5. It has been widely reported that Mr. Geller has demonstrated the ability to bend metal by paranormal means. Although metal bending by Mr. Geller has been observed in our laboratory, we have not been able to combine such observations with adequately controlled experiments to obtain data sufficient to support the paranormal hypothesis.
6. K. Osis, ASPR Newsletter, No. 14, Summer, 1972.
7. C.T. Tart, PHYSIOLOGICAL CORRELATES OF PSI COGNITION, Intl. J. of Parapsychology, Vol. V, No. 4, Autumn, 1963.
8. E.D. Dean, "Plethysmograph Recordings as ESP Responses," Intl. J. of Neuropsychiatry, Vol. 2, October, 1966.
9. D. Hill and G. Parr, ELECTROENCEPHALOGRAPHY: A SYMPOSIUM ON ITS VARIOUS ASPECTS, Macmillan, New York, 1963.
10. S. Siegel, NONPARAMETRIC STATISTICS FOR THE BEHAVIORAL SCIENCES, pp. 152-156, New York, McGraw-Hill Book Co., Inc., 1956.

APPENDIX

Following is the unedited transcript of remote viewing Experiment 7, where the target was an Arts and Crafts Garden Plaza. This is a large plaza resembling a California mission. There are craft shops around the perimeter of the plaza. In the plaza area are many gardens, flowers, ceramic pots, fountains, and paths. Overhead are vines on arbors of redwood. Price's description is accurate in almost every detail and he omitted little of importance.

1:40 THIS IS A REMOTE VIEWING EXPERIMENT WITH PAT PRICE, DEAN BROWN, AND RUSSELL TARG IN THE SHIELDED ROOM IN BUILDING 30. THE TRAVELLERS TO REMOTE LOCATION ARE BART COX, HAL PUTHOFF, JUDY SCHMICKLEY AND PHYLLIS COLE. WE EXPECT THE TRAVELLERS TO BE AT THEIR PLACE IN ABOUT 10 MINUTES.

IT'S 1:58. OUR TRAVELLERS SHOULD BE NEAR TO ARRIVING AT THE PLACE.

OK. Why don't I start scanning by quadrant using this as a center point. 12-3, 6-9.....

I'll go from 12-3 first. Seems to me right now that I'm picking them up in the 12-3 quadrant, but I'll go on in the rest and look. I haven't actually identified them, I just feel that they're there.

Nope, I don't get them there.

Now I'll go from 6-9. While I was looking at 6-9, it looks to me like I'm looking at an iris, a flower of some kind. I'll come back and identify that later. Just wanted to get it down as having a flash of an iris flower-purplish. I'll continue to scan that quadrant. Nope, don't get them there.

I'll go from 9-12. Don't get them there.

I'll go back 12-3. Yeah, I get them in that quadrant.

Now I'll see if I can locate them physically and identify the area.

I'm looking at something that looks like an arbor, trellis-work arbor. Seems to be cool, shaded. Doesn't seem to me that they're out in the direct sunlight. Be more like there's lots of trees, in an arbor area.

The arbor appears to be made of wood, possibly redwood.

They're just....looks like it's a dirt path, quite wide, I'd say maybe 12 feet. I can see some grass. Looks like possibly a fountain of some kind.

Yeah, I can see Bart in his red shirt and what looks like kind of a gray paisley tie - I didn't really look at that when he was down there. The red shirt, I did. Looks like he has on a gray paisley tie.

It appears they're walking along quite leisurely.

Looks like there's some red brick laid into a walkway. They don't seem to be on it, they just seem to pass over that.

I get - it seems like a little ways away from them there are quite a few people but right where they're walking it doesn't appear to be many right in there.

This is an arbor area. Back of that arbor, back here I'd say 50 feet from that arbor to here, seems to be a lot of people in here. They were walking along here on what looks like about a 12 foot dirt path.

WHAT KIND OF PLACE IS THE ARBOR IN? IS IT A FIELD OUT IN THE OPEN?

No, I want to say park, but it doesn't exactly feel like a park. If you took a - the feeling I'm getting - it's not the specific place - but like the Town and Country Market. That type of an atmosphere, with quite a section of it into a little outdoor park, but basically I'm getting a very strong feeling of flowers.

Like the first one I saw was an iris.

TELL ME ABOUT THE TOWN AND COUNTRY ASPECT. IN WHAT WAY DOES IT REMIND YOU OF TOWN AND COUNTRY.

The buildings, not right where they're at, but very close to them have that same kind of architecture and look. The parking lot looks similar, grand, sweeping, not cluttered, it's more expansive area. You take a place like Sears Mall - it seems cluttered. This seems more leisurely paced.

People are moving about slower - there's not the hustle and bustle - more or less meandering.

TOWN AND COUNTRY MEANS TO ME A COVERED WALKWAY.

Yeah, the back of them it seems to be - where they are seems to be a very large arbor like vines growing over it and things, and there possibly - I haven't looked in there yet to see if there's any displays like pottery and things - I get the feeling that there is right close to it.

ALSO, OUTDOORS?

Yeah, it seems like fairly high shade trees - kinda bordering. The center part doesn't seem to have it - this part in here. The trees seem to be way up in here along like this over here. This seems to be shaded in here, but it's sunny out here.

I just saw something that looked like a windmill - not a farm type windmill - a Dutch-type windmill. It's smaller - it's not a huge thing, but I'm getting a definite feeling that it's like a windmill.

The area in there feels damp - not wet - they're not walking in water, but it's very moist.

The temperature in there...it's secluded. Feels very comfortable. A little on the shady side.

WHAT DO YOU FIND AS THE BOUNDARIES OF THE PLACE THEY'RE AT?

Outside of this little park-like affair that they seem to be in, there's a street. One side of it seems to be a kind of a residential...the other seems to be a little bit more heavily travelled.

Let me pick up a little bit more.

I can see one very large oak tree - exceptionally large.

Right now Bart is trying to point something out that is basically the significance of the whole place. It's like that key thing, well, if you'd have mentioned a salt pile I'd have blown my lid. Well, this has a significance that's just about comparable to that. I'm screening it out.

Thing that just flashed in was kind of like a stadium structure - like looking down into a stadium.

Just when I did that I - I'll have to reorient to make sure I'm looking in the same area now.

Seems like they're - I still get them in the same quadrant I had them in originally. Seems like some decorative brick walls.

THE QUADRANT YOU HAD THEM IN IS BASICALLY THE NORTHEAST QUADRANT?

Yeah, I got them out about this far - it's not far away - I'd say in this direction over here about - feels like a mile to a mile and a half. They don't feel as far away, and I'm not looking at the time continuum. They actually don't feel as far away. I'd say that it is about - not half the distance they were to the marina, and it seems to be on a line just about in that direction but just a hair more - rather than a direct line from here to the marina - they seem to be just slightly more to the left of that line.

I was looking back to where he had the car parked and it seems like it's on asphalt then a curb in front, and then it's like a dirt walkway and then a sidewalk. But I can see eucalyptus buds on the ground and some branches of eucalyptus there.

One of the most dominant things to me in the way of unusualness is the size of the oak tree that I'm looking at. Looks like an arboretum, or I get the definite feeling of flowers.

Almost get the feeling like it's commercial flowers.

In fact, the most predominant feeling that I'm getting right now is flowers.

Don't know why iris particularly.

There's something about the windmill that I was going to look at. Wasn't that what you were....?

Be like one you'd almost see in a miniature golfcourse...the windmill.

Has all the construction and detail but not as large - it's fairly small. Seems to be made out of dark redwood and it's kind of aged.

I'm going to try to look more directly to them. Let's see, there's Bart and Hal, and behind Bart is Judy and behind Hal is Phyllis, kinda staggered there.

Looks like a possible small pool of water - like a garden pond.

Looks like a little bridge.

I was trying to get the feeling of what type of an area it was.

Let me elevate a bit. I'm looking at much too small an area. There's some greater significance there that I feel I'm definitely not looking at - let's jack up a bit...maybe 500 feet.

I see a lot of trees.

I see Judy's red hair and her brown eyes and her flashing teeth - she has beautiful teeth. Hadn't really looked at them before.

Phyllis and her are talking about something and Hal and Bart are talking about something and he's pointing at something and it seems to me that he's pointing over to what I'd call a windmill or something that looks like a windmill.

The water I see looks more like a pool or a pond than it does - you know, it's not big like a lake - not very large, but it looks like a definite pool.

Right where they're at I don't hear too much traffic noise - it seems to be fairly quiet.

Looks like a little wooden walkway.

Feels a little early, but it kinda seems like they're retracing their steps heading back toward the car, but they're still moving quite leisurely.

IF YOU LOOK DOWN ON THE PLACE FROM ABOVE, CAN YOU GET ANY FEELING FOR THE - IS THERE ANY OVERALL LAYOUT OR PLAN?

When I went up I could see trees and stuff, and I kind of got the feeling of like in a corner of a golf course, you know - where there would be a lot of trees overhanging the green and some things in there - that seemed to be out of context, but when I elevated, that's what I got. It kind of looked like an overlap to me, so I didn't talk about it, but I will.

When I elevated it kind of felt like it was right over the corner of a golf course of some kind, with a street running down one side, and they are fairly close to that.

In fact, the bricked area that I looked at or like a patio thing kinda looks like a walkway. Seems like there's small building - small meaning not tall - looks like a single story building. Looks like it has a flat roof - slightly pitched. Looks like 4 x 4 poles supporting it - has a

canopy out over it. They're painted white, place looks like very possible light yellow or cream color.

They're walking not too far from that. Still seems to me that they're on a dirt pathway.

In the area that they're in now I get flowers again - where before they kinda fell out of the flowers.

Looks like maybe 80-100 yards from where they are - looks like 2 guys on a motor scooter. They can see them.

WHAT WOULD YOU SAY IS THE INTEREST TO THIS PLACE? WHAT'S SPECIAL ABOUT THIS PLACE?

It seems to be a kind of a recreational, relaxed...not energetic - looks more relaxed. I'd say it's kind of combination recreational and relaxation area that I'm getting out of it.

That would be the general character of it.

Two aspects - one is aesthetics and the other is a kind of a mild recreational area.

There seem to be some unique features - I don't have it totally into context as yet. There's a number of things that I've rejected - looked at and rejected saying.

First, I got the impression that it was kind of like a miniature golf course - I rejected that. Merely from saying it - I didn't reject the principle - I just rejected saying it.

Then I kind of got the idea of a standard golf course - I also rejected that on the same principle, so I'm just trying to describe the terrain.

Seems expansive - doesn't seem cluttered.

Just got a flash of something that reminded me of the gyroscope - gimbals on the gyroscope.

Drinking fountain - looks like it's made out of kinda like field stone built up into a fountain...bowl.

I'm going to elevate again and go through a search quadrant again.

I still get them in that general location, so that seems to set all right.

Distance - maybe a mile, mile and a half. Doesn't seem much farther - seems fairly close.

The area has an awful lot of grass, lot of trees - looks like dirt walkways, well trimmed. I can see the arbor, and the arbor could be a place to sit and be out of the direct sun.

May be a few little tables and benches and chairs in there.

That outlooks over quite a grassy area - there are quite a few trees. I see basically an oak.

Right after they got out of the car I could see some eucalyptus buds and branches on the ground, and it seemed like the trees were there.

Looked like they got out of the car, stepped upon a curb, dirt parkway, a sidewalk, and then they went into this area.

I get the feeling this windmill type thing - that all seems fairly real.

The feeling is still that it's relaxing and has some recreational aspects - I just haven't put it totally together as to giving it a name.

Right now I get a very strong impression of flowers again.

It seems like right now they're back to right where I originally spotted them only they're going in the opposite direction - like they're moving toward the direction they originally went.

While they were there they walked on several pathways - walked out quite a ways, then swung over and come over and worked around and looked at...

One peculiar thing I might note - so far I haven't sensed, seen nor heard an airplane.

Cars seem quite distant - outside of that little motor scooter affair with the two guys on it. That's about the only vehicular traffic I've seen - except out in the parking lot.

It seems like to me that they've got most of their attention off what they were looking at and they've got their attention more on the car now.

I want to look and find out what the significant thing was that Bart was talking about.

There's something quite unusual there and I ... Darned if I can pick it up.

WAS HAL DOING ANYTHING BESIDES WALKING ALONG - WAS THERE ANY ACTIVITY FOR HAL TO DO?

Most of the time I was looking at Hal, he was kind of listening to Bart and Bart was pointing out a number of things.

Part of the time Bart was walking with Hal; part of the time he was back by Judy.

When I first saw them, it was Bart in the front on the left side, Hal was on his right, Judy was slightly behind - almost between Bart and Hal but behind, and Phyllis to her right.

They wandered around but the first time I picked up - they were that way.

When they were coming back, they just about reversed. Bart would be in front. When they were coming back, it looked like Bart was in front with Phyllis, and Judy was walking more behind Bart and Hal on her right when they were coming back out of there.

They're actually at the car.

2:30 SHALL WE GO DOWNSTAIRS AND SEE HOW THEY'RE DOING?

Perception & Psychophysics
1973, Vol. 14, No. 2, 313-318

A study of sine-wave contrast sensitivity by two psychophysical methods*

D. H. KELLY and R. E. SAVOIE

Stanford Research Institute, Menlo Park, California 94025

In the literature on visual contrast thresholds for sine wave gratings, little attention has been paid to the psychophysical methods used to obtain these spatial-frequency response curves. Here we report a comparison of such data obtained by two quite different psychophysical methods, but otherwise under identical conditions, using five Ss. Both experiments were run by computer: (1) In the method of adjustments, the computer program merely controls the order of the stimuli and records S's contrast settings. (2) In the forced-choice staircase (FCS) technique, the program determines how often S can discriminate the sinusoidal grating from a uniform field, informs S of his accuracy, controls the stimulus contrast on the basis of S's preceding responses, and brackets his threshold by a series of successive approximations. Method 2 eliminates criterion effects that occur in Method 1, and hence tends to minimize individual differences. However, the FCS technique requires an order of magnitude more observing time to obtain equally smooth contrast sensitivity curves. FCS also increases the overall sensitivity of some Ss by as much as five times, but it does not significantly change the *shape* of the contrast sensitivity curve; both methods show strong effects of lateral inhibition at low spatial frequencies.

Measurements of the contrast threshold for a sinusoidal grating as a function of its spatial frequency have been used to study the effects on the visual process of optical, neural, chromatic, temporal, and other factors. Van Meeteren (1966) has reviewed a number of these studies. We are particularly interested in the low-frequency region of such data, below about 2 cycles/deg (cpd), because the monotonic increase of contrast sensitivity with increasing spatial frequency in this region may represent a simple form of lateral inhibition (Kelly, 1973).

In certain cases, little or no low-frequency falloff was reported (e.g., Westheimer, 1960; Campbell & Green, 1965), but this has been attributed to the use of small, sharp-edged targets (Davidson, 1966; Kelly, 1970) or flash presentations (Kelly, 1971, 1973), which are unsuitable for isolating the steady-state response to very low spatial frequencies. However, some Ss report that the task of detecting a low-frequency grating seems different from the high-frequency detection task; this raises the question of whether the apparent inhibition would persist at low frequencies if criterion effects were eliminated.

Many of the data in the literature have been obtained by the psychophysical method of adjustments, which is the easiest and fastest procedure when Ss are experienced in this type of judgment: variations of the method of limits have also been used. But more sophisticated psychophysical methods have been developed in recent years which are essentially independent of threshold criterion: these have not been

applied to the measurement of sine wave contrast thresholds. We therefore undertook to compare the sine wave thresholds obtained by the method of adjustments with those obtained by a forced-choice staircase (FCS) paradigm, in which the S was always informed of the correctness of his choice. Our main purpose was to find out whether the low-frequency inhibition was independent of criterion effects, but our results are also relevant to other sine wave contrast experiments that use subjective judgments.

METHODS

The stimulating apparatus is described in detail elsewhere (Kelly, 1966, 1972); its components are shown schematically in Fig. 1. S is seated comfortably, viewing a cathode ray tube (CRT) 50 cm distant through an artificial pupil, 2.3 mm in diam. He sees an 8-deg circular field, filled by a vertical sinusoidal grating. The spatial frequency of this grating is controlled by a (LINC 8) computer. The dependent variable is the Michelson contrast (m) of the grating, defined as

$$m = \frac{B_{\max} - B_{\min}}{B_{\max} + B_{\min}}$$

where B_{\max} and B_{\min} are the maximum and minimum values of the stimulus waveform, in trolands (td) of retinal illuminance. This contrast is under the control of either the computer or the S, depending on the mode of operation. Since the grating does not flash or flicker in the present experiments, our temporal waveform source was not used (see Fig. 1).

Adjustments Mode

In the method of adjustments, the S controls the contrast of the grating, using a geared-down potentiometer without stops or other mechanical cues. Spinning the knob about 1,200 deg covers the entire adjustment range, which may be either 0-1 or 0-0.1 contrast, depending on a switch controlled by the S. Another switch gives him the option of viewing zero or full contrast at any time, without losing his potentiometer setting. When the setting meets his threshold criterion, he pushes a

*Our work was partly supported by NIH Grant No. NS-08322 and NSF Grant No. GB-11571. Some of the data were reported at the October 1971 meeting of the Optical Society of America in Ottawa, Canada. We thank T. N. Cornsweet for suggesting this study.

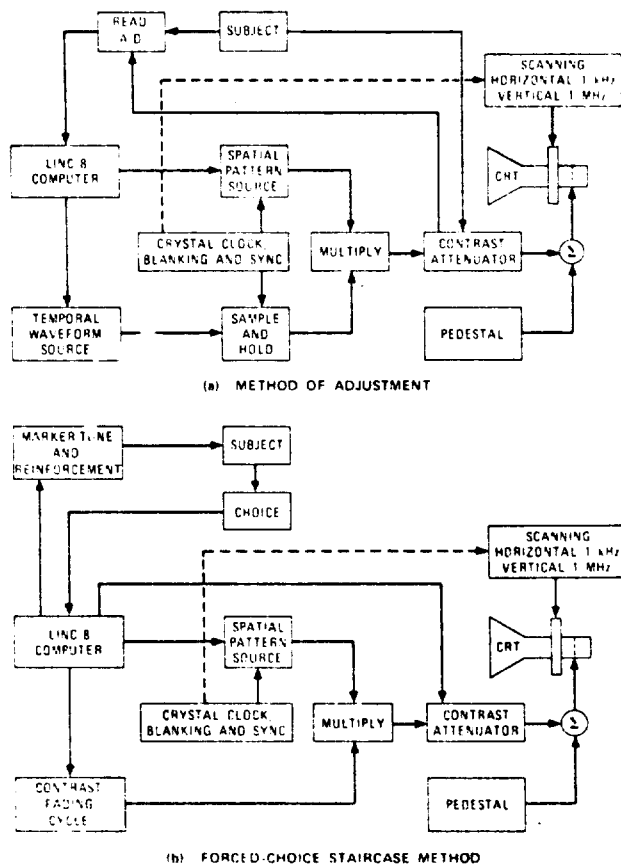

Fig. 1. Signal-flow diagrams of the CRT stimulator. (a) Configuration for method of adjustments. (b) Configuration for forced-choice staircase (FCS) procedure.

button which enters this contrast into the computer.

He is instructed to fixate the center of the grating and to find the contrast at which it can just be discriminated from a uniform field. (This criterion, which we always use for sine wave thresholds, should come close to matching S's performance in the forced-choice task described below.) S spends as much time as he wishes "hunting" back and forth to find his threshold, but we instruct him to make his final judgments only in the steady state; i.e., after he has refrained from changing the contrast for several seconds. Twelve spatial frequencies were tested in one experimental session; each pattern was presented five times in random order, for a total of 60 judgments. The means of these five settings gave fairly smooth spatial-frequency response curves, as described below. An experienced S can complete such a run in 20-25 min.

Forced-Choice Staircase (FCS) Mode

Our criterionless psychophysical procedure combined the staircase method of ordering stimuli (Békésy, 1947; Cornsweet, 1962) with the forced-choice method of response collection (Blackwell, 1946; Heinemann, 1961). In this application, the two techniques complement each other in such a way that S spends most of his time making discriminations near threshold.

The S's task is much simpler in the FCS mode. The same 12 stimulus patterns are used, but their contrast is now under the control of the computer. One stimulus cycle consists of two successive intervals, each 5 sec long; a pattern of nonzero contrast is presented in only one of these intervals, which is determined by the computer from a table of random numbers.

One second after the beginning of each interval, a marker tone sounds to notify S that the stimulus may be visible. He makes his choice of interval by pushing a button, which also starts the next trial; but this button has no effect until after the second tone. In other words, S must make a choice in order to start a new trial, but he cannot do so until after the second interval has started. As soon as he makes his choice, he hears a pleasant tone (different from the marker tone) if he is correct or an unpleasant noise if he is not.

His only other control is a "pause" switch, which interrupts the experiment for rest periods. S may use this switch also to abort a given trial (if, for example, he happened to be looking away when the marker tone sounded). The aborted trial is repeated when the pause switch is reset, but the stimulus will not necessarily occur in the same interval.

In order to avoid transient effects (Kelly, 1971, 1973), as we do in the adjustments mode, the temporal waveform of the FCS stimulus is carefully controlled. The mean luminance of the CRT screen is held constant throughout the experiment. When a given pattern is presented, its contrast is smoothly "faded in" from zero to whatever value is set by the computer, as shown in Fig. 2a. The temporal envelope of the fade-in waveform resembles a half-cycle of a 0.5-Hz cosine wave, so that the full contrast of the pattern is present after 1 sec (this contrast always being zero in either the first or second interval, at random). The pattern is also faded out the same way.

All 12 staircases are independent and randomly interleaved, which helps to eliminate subjective bias effects (Cornsweet, 1962). On each trial, the contrast of the preceding responses to the same pattern, according to an algorithm described in detail in the Appendix. When the responses indicate that S can detect the pattern, the contrast is decreased; when he cannot, the contrast is increased, by a constant logarithmic increment in either case. Thus, the contrast is forced to cross and recross the threshold level (which is about 75% correct). At first, the size of the increment is decreased each time the response sequence indicates that a contrast increase has probably crossed S's threshold. But the third time this indication occurs, the smallest increment (30% contrast change) is maintained and the staircase is terminated with a fixed number of additional trials.

A typical staircase illustrating these properties is shown in Fig. 2b. Each stimulus is first presented at full contrast, to familiarize S with its appearance and to provide a suprathreshold baseline. If he detects it correctly, its next presentation is at a contrast of 0.02; the staircase then enters the main algorithm (see Appendix).

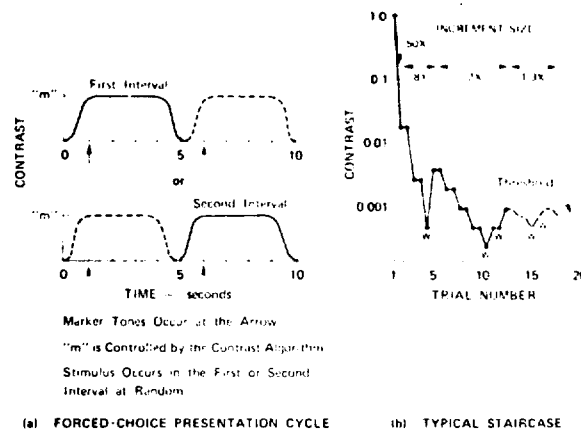

Fig. 2. Details of the FCS procedure. (a) Temporal waveform of one stimulus cycle and timing of alerting tones. (b) A single staircase, reassembled to show all contrasts presented, increment sizes, wrong responses, and calculated threshold.

Several hundred trials are required to terminate all 12 staircases; an experimental session usually takes 65-75 min. regardless of the skill or experience of the S. Most of the variability in length of the individual staircases (Rose et al, 1970) is averaged out by the large number of staircases being run simultaneously.¹

The threshold for each pattern is calculated as the mean of the last eight contrasts presented, no adjacent pair of these being separated by more than the smallest increment. The intersession variability of FCS data obtained in this way is no greater than in the adjustment mode, but is mainly random rather than systematic. Thus, to obtain equally smooth spatial-frequency response curves, one must average the data from three FCS sessions, as described below.

RESULTS

Figure 3 shows some contrast sensitivity data obtained with a 20-year-old emmetropic naive S. The upper curve (filled circles) represents combined data from three FCS runs; three comparable adjustment curves are plotted separately (open circles). These data are typical of our results in three ways. First, the *shape* of the FCS curve is essentially the same as that of the adjustment curves; in both cases, the contrast sensitivity increases steeply at low spatial frequencies, to a maximum near 4 cpd. Second, the FCS sensitivity is systematically greater than that in any of the adjustment runs, by a factor of 2 to 5. Third, there are also systematic differences among the individual adjustment curves, but these are smaller than the FCS-adjustment differences.

The lowest sensitivity in Fig. 3 represents the first

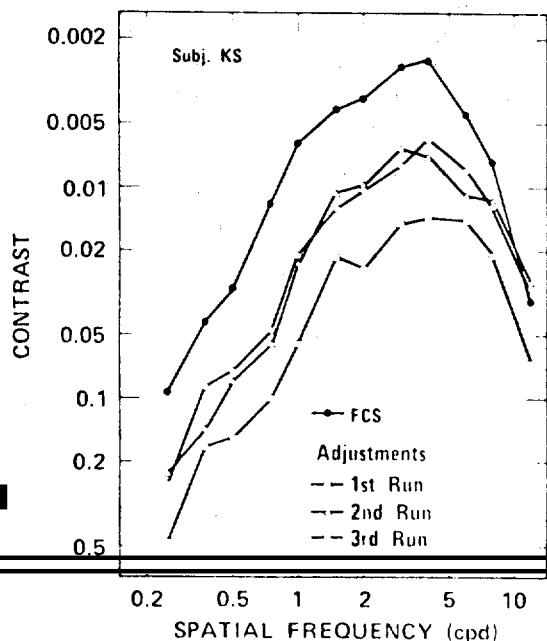

Fig. 3. Contrast sensitivity vs spatial frequency for S.K.S. Retinal illuminance, 1,300 td; artificial pupil, 2. mm. Filled circles are the means of three FCS runs. Open circles represent three successive adjustment runs.

SINE-WAVE CONTRAST SENSITIVITY 315

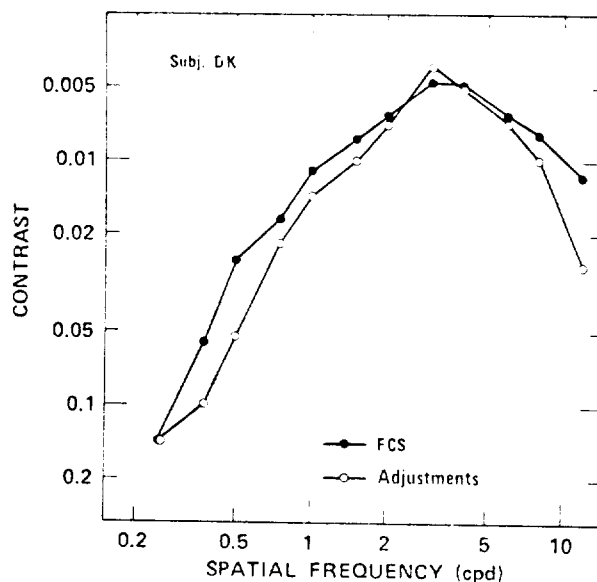

Fig. 4. Contrast sensitivity vs spatial frequency for S.D.K. Same conditions as Fig. 3.

experiment with S.K.S. Her adjustment sensitivity increased subsequently, but leveled off between the second and third adjustment runs. Typically, a naive S starts with a high threshold criterion, which he then lowers after some experience with the method of adjustments. However, his adjustment thresholds seldom get as low as his FCS thresholds; apparently he adopts a criterion in the range of 90%-100% probability of detection (compared to the 75% imposed by the FCS mode).

Figure 4 shows a similar comparison for another S. S.D.K. (one of the authors) is somewhat atypical, having had hundreds of hours of practice in experiments with this particular apparatus. If practice lowers the adjustment threshold, his adjustment sensitivity should be greater than that of S.K.S.; and it is, relative to his FCS sensitivity. His adjustment sensitivity may still be slightly less than his FCS sensitivity, but the two are much closer together than they are for our other Ss. Evidently he uses a lower threshold criterion, closer to the FCS level. As in Fig. 3, the FCS curve in Fig. 4 was obtained by averaging data from three sessions, a total of about 3.5 h observing time.

However, the contrast sensitivity curves obtained from individual FCS sessions are also instructive: these are shown for a third S in Fig. 5. Each of the dashed curves in this figure connects the end points of the 12 staircases obtained in a single experimental session (see Fig. 2b). The mean curve for these three FCS sessions is shown for comparison with the previous figures. Figure 5 also shows some systematic variation among three adjustment runs for this S. (S.H.P. was more experienced than K.S., but even an experienced S will not always hold the same adjustment criterion from one run to the next.) Again, the FCS sensitivity is about five

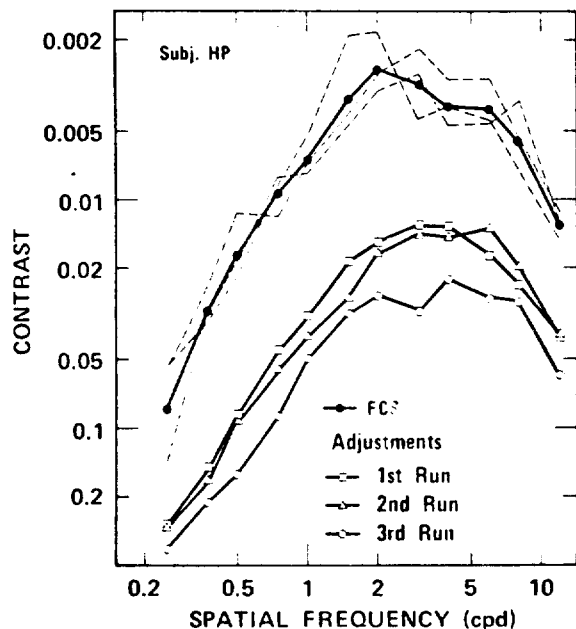

Fig. 5. Contrast sensitivity vs spatial frequency for S.H.P. Same conditions as Figs. 3 and 4. Dashed lines show data from three FCS runs, averaged to obtain filled-circle points.

times greater than the adjustment sensitivity.

The most important result shown in Fig. 5 is the nature of the variability among FCS runs and among adjustments runs. Although the FCS data are about as variable as the adjustment data, the adjustment variability is mainly systematic, while the variability among the FCS runs seems random. (Note that the FCS curves from individual sessions cross and recross each other and the mean curve several times.) The data were subjected to a chi-square test of the hypothesis that mean rank contrast sensitivity is independent of session number. This hypothesis can be rejected for the adjustments data ($p < .001$), but cannot be rejected for the FCS data ($p = .1$).

Now, if the FCS method eliminates systematic intra-S variability from one run to the next, and if this intersession variability is caused mainly by changes in S's criterion, then we would expect this method to minimize the variability among Ss as well. The data shown in Fig. 6 tend to confirm this expectation. Here the mean FCS curve for S.H.P. is repeated, together with similar data for two other young, emmetropic Ss. Note the close similarity among all three contrast sensitivity curves, particularly at frequencies below 2 cpd. These data (and others not reported here) all tend to confirm the presence of a low frequency inhibiting effect with a relatively steep slope (about 2 in log-log coordinates).

DISCUSSION

Instructing S to try to detect any perturbation of the uniform field may be important in making the

adjustment curves so similar in shape to the FCS curves. One should not assume that our results would be obtained if S were instructed to detect the presence of a grating, or to report its orientation, count its fringes, etc. The use of other subjective criteria can doubtless change the shape of the sine wave threshold curve.

When minimum threshold values are not required, and occasional criterion differences among and within Ss can be tolerated, the method of adjustments is obviously preferable, because it yields equally smooth curves in about a 10th of the time required by the FCS method.¹ However, the FCS method eliminates criterion differences and provides information about S's performance (not just his judgments).

Summarizing our results with five Ss, ranging from naive to quite experienced: (1) Both methods yield the same curve shape, but the FCS method gives significantly greater sensitivity than that obtained by the method of adjustments: the increase may be as great as a factor of 5 (depending on S's adjustment criterion). (2) Presumably because it is independent of threshold criteria, the FCS method does not show systematic changes of sensitivity from one run to the next (as the method of adjustments sometimes does.) (3) The variability of the FCS data is mainly random and can therefore be made quite small by taking enough data. (4) When this is done, individual differences (among young, emmetropic Ss) tend to disappear.

These results are essentially what would be expected, based on the differences between the two psychophysical methods. We conclude that, if the S is appropriately instructed, the shape of his sine wave grating sensitivity curve is not affected by using the method of adjustments. Moreover, it seems likely that this negative result would be maintained if the present study were extended to other criterion-dependent

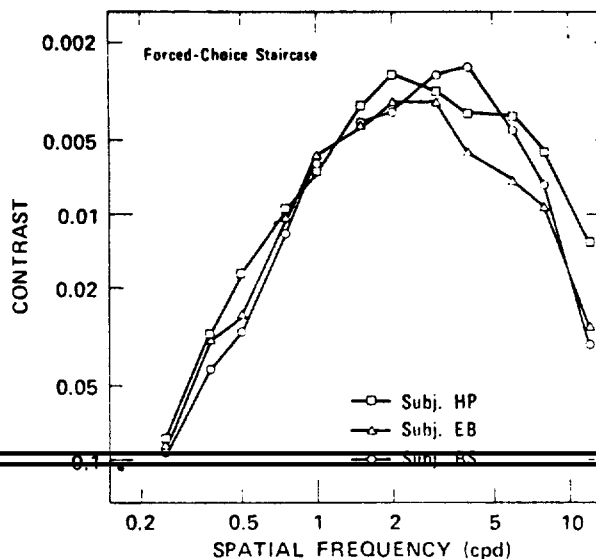

Fig. 6. Contrast sensitivity vs spatial frequency for three young, emmetropic Ss, obtained by the FCS technique.

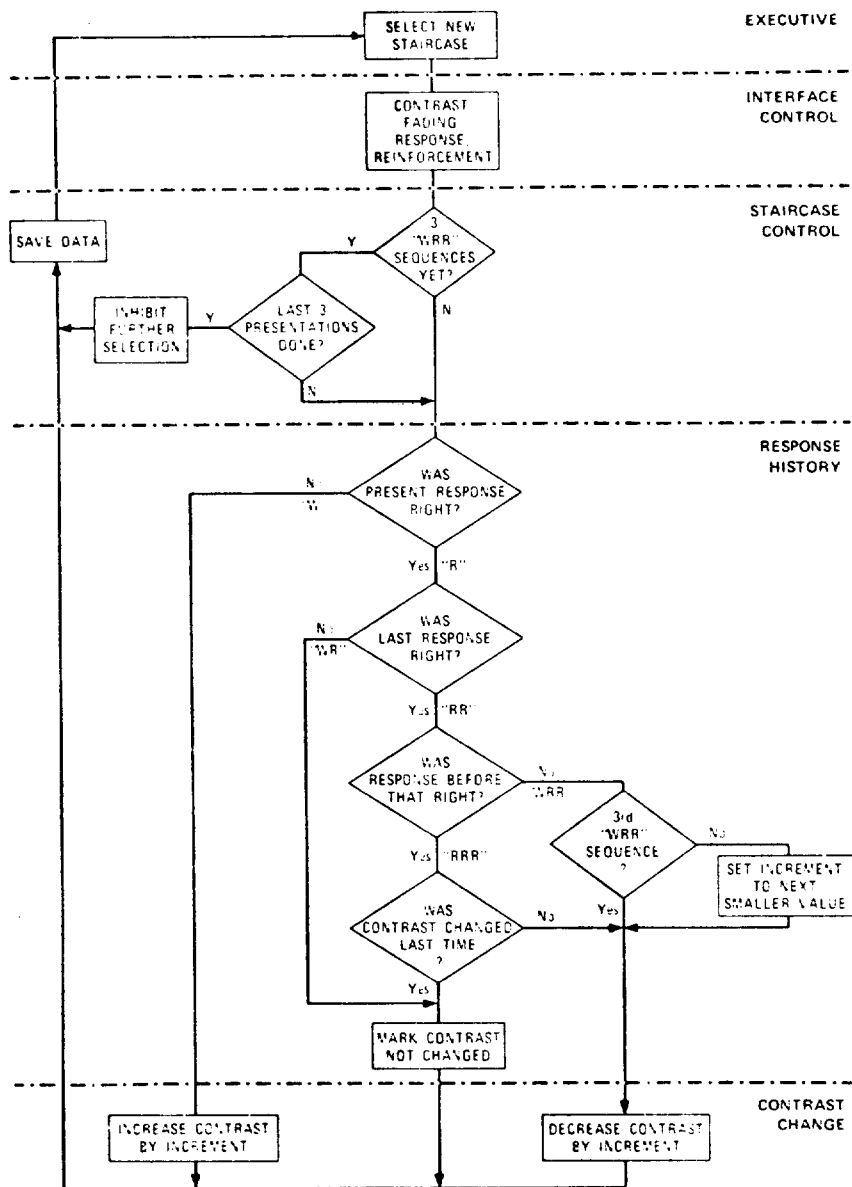

Fig. 7. Flow-chart representation of the FCS computer program.

psychophysical methods in general. Thus, our results tend to support the sine wave threshold data obtained by these methods.

APPENDIX

The Forced-Choice Staircase (FCS) Computer Program

The operation of the FCS computer program can be divided into five functional categories: executive, interface control, staircase control, response history, and contrast change (see Fig. 7).

The executive section of the program initializes the experiment, selects (from a random table) one of the 12 stimulus patterns for presentation at each trial, performs

various bookkeeping functions, and calculates and prints out the average data at the end of an experimental session. The staircase control portion of the program operates on a parameter table for the staircase currently selected; it keeps track of the previous three responses, the previous eight contrasts, the present contrast, and contrast increment size (and other parameters for internal use). These historical data are needed for each staircase to determine its subsequent contrasts.

The interface control portion of the program controls the stimulator interface, which operates the entire sequence of each trial: stimulus generation, contrast fading, marker tones, and reinforcement. When S makes a response, the computer reads data from the interface, indicating whether the response was right or wrong (or

whether the "pause" switch was set).

The response history section is the heart of the FCS program: Fig. 7 shows a flow chart of this section and its relation to the other parts of the program. Each staircase follows the algorithm according to its own history, independent of the other staircases. The next contrast to be presented (for the selected staircase) is calculated on the basis of the present contrast, the present response, the previous two responses, the contrast increment, and whether the contrast was changed after the previous response. The contrast algorithm is as follows: (1) When S makes a wrong (W) response, the contrast of that pattern is increased for its next presentation. After he makes two successive right (R) responses to the same pattern, its contrast is decreased (this sets the average end point of each staircase at about 75% correct). The new contrast is obtained by multiplying (or dividing) the preceding contrast by a fixed ratio (i.e., a constant log increment). (2) Each time the sequence W,R,R occurs, the size of this increment is decreased. (This is most likely to occur when the contrast increases from below to above the 75% correct level.) The successive increment sizes are: 8X, 2X, 1.3X. (3) After the sequence W,R,R has occurred three times with a given pattern, the staircase terminates with three more trials using the smallest increment, and that pattern is not presented again. The session ends when all staircases have terminated.

The last eight contrasts from each staircase are averaged to obtain the threshold. The minimum number of trials before termination but after the second W,R,R sequence is eight. Therefore, all contrasts being averaged were necessarily presented during the period when the smallest contrast increment was in effect.

REFERENCES

- Békésy, G. v. A new audiometer. *Acta Oto-laryngologica*, 1947, 35, 411-422.
- Blackwell, H. R. Contrast thresholds of the human eye. *Journal of the Optical Society of America*, 1946, 36, 624-643.
- Campbell, F. W., & Green, D. G. Optical and retinal factors affecting visual resolution. *Journal of Physiology*, 1965, 181, 576-593.
- Cornsweet, T. N. The staircase method in psychophysics. *American Journal of Psychology*, 1963, 75, 483-491.
- Davidson, M. A perturbation analysis of spatial brightness interaction in flashed visual fields. Doctoral thesis, University of California, Berkeley, 1966.
- Heinemann, E. G. The relation of apparent brightness to the threshold for differences in luminance. *Journal of Experimental Psychology*, 1961, 61, 389-399.
- Kelly, D. H. Frequency doubling in visual responses. *Journal of the Optical Society of America*, 1966, 56, 1628-1633.
- Kelly, D. H. Effects of sharp edges on the visibility of sinusoidal gratings. *Journal of the Optical Society of America*, 1970, 60, 98-103.
- Kelly, D. H. Transient effects on the visibility of low spatial frequencies. *Journal of the Optical Society of America*, 1971, 61, 1576 (A).
- Kelly, D. H. Adaptation effects on spatio-temporal sine-wave thresholds. *Vision Research*, 1972, 12, 89-101.
- Kelly, D. H. Lateral inhibition in human colour mechanisms. *Journal of Physiology*, 1973, 228, 55-72.
- Kohayakawa, Y. Contrast-difference thresholds with sinusoidal gratings. *Journal of the Optical Society of America*, 1972, 62, 584-587.
- Rose, R. M., Teller, D. Y., & Rendleman, P. Statistical properties of staircase estimates. *Perception & Psychophysics*, 1970, 8, 199-204.
- Van Meeteren, A. *Spatial sinewave response of the visual system (a critical literature survey)*. Soesterberg: Institute for Perception RVO-TNO, 1966.
- Westheimer, G. Modulation thresholds for sinusoidal light distributions on the retina. *Journal of Physiology*, 1960, 152, 67-74.

NOTE

1. Because the FCS sessions are long and tiresome, a number of preliminary experiments were conducted to determine the most suitable compromise between speed and end-point stability. We found that the variability shown in Fig. 5 could not be decreased significantly without prohibitive increases in run length. The number and sizes of our increments were governed by the following constraints (see Cornsweet, 1963): (a) For maximum efficiency, the smallest increment must be fixed at about the same size as the contrast-difference threshold for sinusoidal gratings: at a spatial frequency of 2.1 cycles/deg, Kohayakawa (1972) obtained jnds of 30% to 60% with low-contrast gratings. (Note that this is much larger than the jnd of luminance.) (b) All staircases must start at a common baseline; for this purpose, we chose 100% contrast. (To start at equal distances from threshold would require an a priori assumption of the curve shape we are measuring, which could bias the result.) (c) If the contrast is to approach threshold quickly, the initial increment must be much larger than specified in (a). The increment should decrease as the contrast approaches threshold, but not so rapidly as to run a high risk of being "trapped" in a small increment far from threshold. (d) Subject to constraint (c), the total number of increments should be minimized.

(Received for publication January 16, 1973;
accepted March 15, 1973;
revision received March 29, 1973.)

CONFIDENTIAL

15 January 1974

MEMORANDUM FOR THE RECORD

SUBJECT : Special Management Guidelines for the
SRI Paranormal Project

1. Both the nature of research in the paranormal field and the intense interest it excites within our organization and in the public at large, together with the highly competitive and complexly motivated character of other research efforts in this field, make it essential that we formulate and adhere to certain special guidelines for the administration of any new efforts. The real intent and purposes of such guidelines would be to:

- a. simplify the contractor's task by eliminating all unnecessary confusion and distractions;
- b. tighten the responsibility and control functions within the sponsor's organization;
- c. serve both the contractor's and the sponsor's interests by increasing project security; and
- d. permit us to arrive at sound and well-documented, however modest, conclusions by focusing on limited, consistent and explicit objectives.

The guidelines listed below need not be considered definitive; to the extent that modifications seem essential from a practical point of view or that additional guidelines would serve the above purposes, contractor and sponsor personnel should agree on emendations.

2. Data Control. The complex nature of the funding and phasing of SRI's past paranormal investigations makes it virtually impossible to establish, now, which data were developed under whose auspices. Other than portions which clearly relate to sponsor tasking and direct or indirect sponsor validation, no attempt will be made to control use of that data--most of which has already become public knowledge in one form or other. But it will be understood that, from the start of the new (January 1974) contract effort, all data developed will fall under the sponsor's purview and none of it will be released in any form to other than authorized sponsor personnel without prior sponsor approval. On its part, the sponsor undertakes to be as expeditious and liberal as circumstances permit in approving the release of non-sensitive data for open publication.

3. Authorized Personnel. As far as the sponsor's organization is concerned, 'authorized' personnel will be understood to mean: in the first instance, the primary project officer, [redacted] or his immediate superiors [redacted] [redacted] and Mr McMahon); and, in [redacted] absence or with respect to purely 'basic' research matters, his alternate project officer, [redacted] or his immediate superiors [redacted] As far as the contractor's organization is concerned, 'authorized' personnel will

SG1A

SG1A
SG1A

SG1A

be understood to mean: only those (to be listed by name and function) immediately involved in the research effort, the essential chain-of-command superiors and such other SRI specialists as may be required in conducting the research. Individuals other than 'authorized' personnel, whether from the sponsor's or other governmental or non-governmental organizations, will not be given access to project data without prior sponsor approval. Such approval will be limited to individuals essential to the conduct of the research. It is likely that, because of prior associations and publicity, the contractor will receive queries about the status of research and we appreciate the awkwardness this might create; whenever possible, it is suggested that the contractor take the position that, largely on its own resources, the masses of data already collected are being studied and the results may, if appropriate, be published at a later time; the contractor should avoid more explicit comments unless there is prior coordination with the sponsor.

4. Release of Data to Sponsor Personnel. The requirements for progress and financial reports are specified in the contract and they will be released only to 'authorized' sponsor personnel. In the same sense, visits to the paranormal research laboratory should be limited to authorized sponsor personnel. The sponsor will attempt to curtail inquiries and requests for site visits by its personnel and it is suggested that, should it become necessary, the contractor handle such requests by stating that it is now operating under restrictive groundrules and urging the individual to contact the project officer or his alternate.

5. Acceptance of Guidance from Sponsor Personnel. Similarly, to avoid confusion or disruption of the contractor's efforts, tasking and guidance will be accepted only from authorized personnel; unsolicited views may be referred to the project officer or his alternate. It may be that, later, the contractor and the sponsor will wish to brief sponsor personnel and solicit their views and suggestions; but, if so, it should be undertaken in a well-controlled, methodical manner and for quite specific purposes related to the research design and objectives.

6. Other Sponsorship. The sponsor assumes that the scope and terms of the contract are such that SRI's paranormal investigative resources will be fully absorbed by the effort but, since the sponsor's support cannot be alluded to by SRI, that will not preclude offers of sponsorship by others--including the government. It is suggested that, in response to official or unofficial offers, SRI initially state that it is consolidating and studying previously collected data and doesn't wish to undertake new investigations until this analysis is completed. If this response doesn't have the desired result, SRI should inform authorized sponsor personnel before making any commitments or disclosures. SRI and sponsor personnel will then agree on the most effective means of handling the situation.

SG1A

Approved For Release 2003/06/24 : CIA-RDP79-00999A000300100034-4

Next 5 Page(s) In Document Exempt

Approved For Release 2003/06/24 : CIA-RDP79-00999A000300100034-4



SCIENTIFIC RESEARCH AND DEVELOPMENT
Yonkers District Office

1 October 1973

Proposal for Research

SRI No. ISH 73-146

11.21.73/6

ORD # 4718-73

PERCEPTUAL AUGMENTATION TECHNIQUES

Part One--Technical Proposal

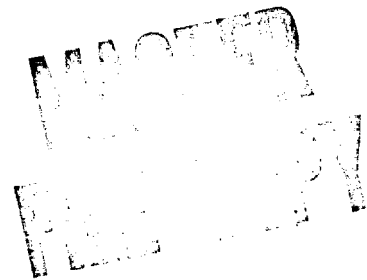

Prepared by:

Harold E. Puthoff
Senior Research Engineer

Russell Targ
Senior Research Physicist

Approved:

Earle D. Jones, Director
Electronics and Bioengineering Laboratory

Bonnar Cox, Executive Director
Information Science and Engineering Division

Copy No. 1

CONTENTS

LIST OF ILLUSTRATIONS.	iii
LIST OF TABLES	iv
I INTRODUCTION.	1
II BACKGROUND.	3
A. Exploratory Research in Remote Viewing	3
1. Global Targets--Training Mode	3
2. Demonstration-of-Ability Tests: Double-Blind Client-Supplied Coordinates	6
B. EEG Experiments.	18
C. Remote Perception of Graphic Material.	23
III PROPOSED PROGRAM.	40
A. Objective.	40
B. Technical Approach	40
C. Statement of Work.	41
D. Reporting Schedule	42
IV QUALIFICATIONS OF STANFORD RESEARCH INSTITUTE	43

ILLUSTRATIONS

1	Training Results (Swann):	4
2	Map No. 1 of West Virginia Site (Swann)	8
3	Map No. 2 of West Virginia Site (Detail--Swann)	9
4	Map of Urals Site (Price)	12
5	Map No. 1 of Kerguelen Island Site (Detail--Swann).	14
6	Map No. 2 of Kerguelen Island Site (Swann).	15
7	Map No. 3 of Kerguelen Island Site (Price).	17
8	Occipital EEG Frequency Spectra, 0 to 25 Hz, of Jean Mayo, Receiver	21
9	Occipital EEG Frequency Spectra, 0 to 25 Hz, of Hella Hammid, Receiver.	22
10	Shielded Room Used for EEG Measurements	24
11	Target 1 (Firecracker) and Geller's Responses	25
12	Target 2 (Grapes) and Geller's Response	27
13	Target 3 (Devil) and Geller's Responses	28
14	Target 4 (Solar System) and Geller's Response	31
15	Target 5 (Camel) and Geller's Response.	33
16	Target 6 (Golden Gate Bridge) and Geller's Response	34
17	Target 7 (Seagull Flying) and Geller's Response	35
18	Target 8 (Kite on CRT Display) and Geller's Response.	36
19	Target 9 (Church, Stored in Memory of Text-Editing Computer) and Geller's Response	37
20	Target 10 (Arrow Through Heart, Stored in Computer Graphics Program) and Geller's Responses.	39

TABLE

1	Results of Global Targets Training--Run 10.	5
---	---	---

I INTRODUCTION

Stanford Research Institute proposes to undertake a one-year research program to investigate, and develop techniques to enhance, human perceptual abilities.*

The perceptual abilities that we have been investigating for the past year are sometimes considered paranormal phenomena. However, our recent work leads us to consider them as, to a greater or lesser extent, latent in all people. The phenomena we have investigated most extensively pertain to the ability of certain individuals to view with great clarity distant scenes not presented to any known perceptual sense. In addition, we have performed more modest experiments with unselected subjects who have been found to exhibit direct physiological (EEG) evidence of perception of remote happenings. Our accumulated data make it appear that both gifted and ordinary persons can be assisted in developing remote perceptual abilities up to a level dictated by their individual potentialities. The purpose of the proposed research is to investigate the physical and psychological variables underlying these phenomena so that we may gain a greater understanding of this ability and a more complete grasp of its limits and applicability.

Section II of this proposal provides background material, detailing the evidence pertaining to remote viewing and other nonregular perceptual abilities. In this section we describe:

- Experiments with two gifted individuals who took part in double-blind experiments to perceive scenes at intercontinental distances.
- Brain wave experiments in which ordinary (not specially selected) subjects were asked to perceive whether or not a remote light was flashing--the EEG data from several of these subjects indicates objectively that they did perceive the presence of the light, even if only at a noncognitive level of their consciousness.

* This proposal has been prepared at the request of the client.

- Carefully controlled remote perception experiments with Mr. Uri Geller, in which he, while located in an electrically shielded room, was able to reproduce target pictures drawn for the occasion at various SRI locations.

Section III describes the proposed program and presents a detailed work statement, along with the major program milestones.

Section IV outlines the experience, facilities, and personnel of Stanford Research Institute, and its Electronics and Bioengineering Laboratory that are available to contribute to the successful completion of this work.

A separate Part Two of this proposal covers contractual matters and costs.

II BACKGROUND

A. Exploratory Research in Remote Viewing

As a result of experimentation carried out in an eight-month program to investigate the abilities of a gifted subject, Ingo Swann, Swann expressed the opinion that the insights obtained had strengthened an ability that has been researched before he joined the SRI program; namely, the ability to view remote locations. To test Swann's assertion, SRI researchers set up a series of experimental protocols on a gradient scale of increasing difficulty.

The first step toward the proof that such an ability might exist in principle was completed in our laboratory in a series of experiments with another subject in which target pictures were successfully received where the subject was separated from the target material either by an electrically isolated shielded room or by the isolation provided by East-coast/West-coast distances. These data are presented in Part C of this section.

1. Global Targets--Training Mode

For the first experiment, considered to be a training mode, 100 targets on the earth's surface (ten per day for ten days) were chosen at random, often by different experimenters. For each ten-trial session, the experiment would begin with the subject (Swann) being given a target location by latitude and longitude only, for which he had to provide an immediate response of what he saw. Following his response, some brief indication was given as to whether any correspondence existed between his description and the target location. The next coordinate was then given until all ten coordinates were exhausted. A run of ten coordinates was always completed in less than 30 minutes.

The results obtained during the training mode are summarized in Figure 1, where a least-squares fit to the data is shown by the solid lines. Details for the final run (Run 10) are shown in Table 1.

The second coordinate in Run 10 (Table 1) affords a surprising example of precision that sometimes occurred. The experimenter chose

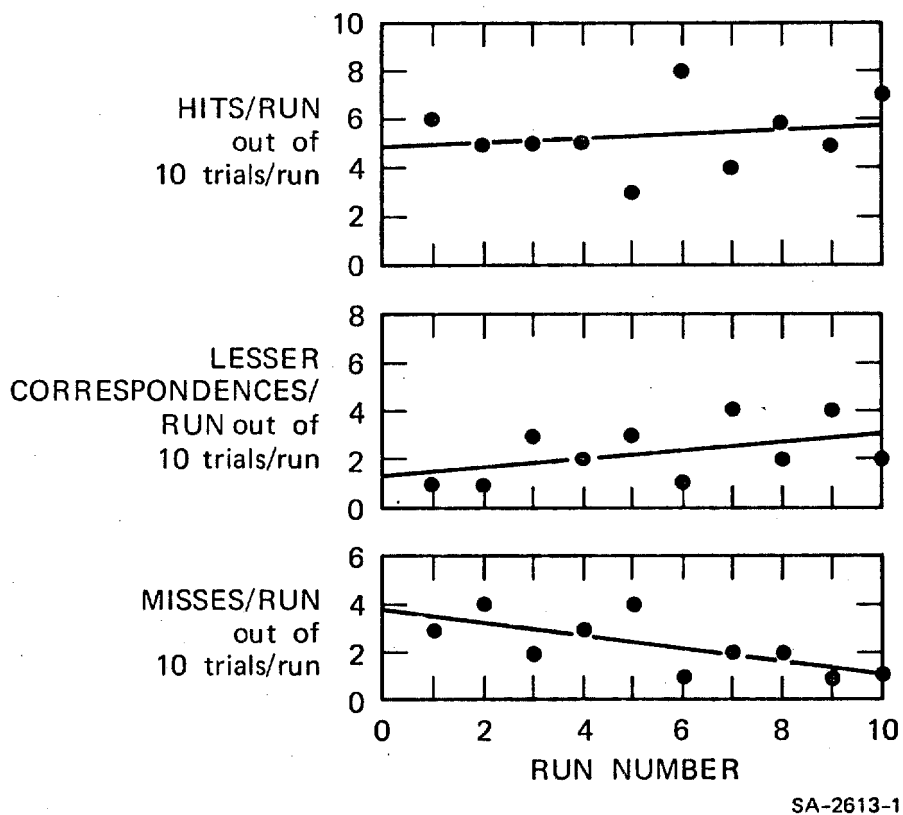

FIGURE 1 TRAINING RESULTS (SWANN)

Table 1

RESULTS OF GLOBAL TARGETS TRAINING--RUN 10

Target	Response	Evaluation*
45°N 150°W (ocean)	Ocean, beautiful blue-green waves, sun shining, ship toward north	H
2°S 34°E (eastern shore, Lake Victoria, Africa)	Sense of speeding over water, landing on land. Lake to west, high elevation	H
55°N 150°E (Sea of Okhotsk)	Not many trees, patches of snow, marsh?	M
64°N 19°W (20 miles ENE of Mt. Hekla volcano, Iceland)	Volcano to southwest. I think I'm over ocean.	H
55°N 130°E (Soviet Union)	Wind blowing there, night, telephone wires. Land, flat place with fields; Cold.	N
60°N 90°W (Hudson Bay)	Open water, stands of pine to north.	H
60°N 91°E (Soviet Union)	City, snow on ground, city to north-east, factory to south.	N
30°S 0° (ocean)	Ocean, Atlantic, deep blue water.	H
42°N 105° (Gobi)	Mountains	H
28°S 137°E (Lake Eyre, Australia)	Islands, Land mass to east, west. An open sea, night.	H

*
H--Hit; good description of area in near vicinity of target.
N--Neutral; some possibility of correspondence.
M--Miss; clear lack of correspondence.

the coordinate from a world map to represent the middle of Lake Victoria, Africa. However, Swann insisted that the coordinate, when given, turned on a picture of land to the right of a large lake. Subsequent checking with a detailed map of the region indicated that his perception had been correct.

We must, of course, point out that the results of such a training mode can be taken as indicative only, since even under the carefully controlled experimental conditions in force,

- An individual could--in principle--obtain good results on the basis of eidetic memory.
- Given the hypothesis of extraordinary functioning an individual could--in principle--obtain the data subliminally from an experimenter who knows the target location.

Therefore, the rapid global targets training mode was followed up with a series of global targets supplied by Stanford Research Institute personnel on a double-blind basis in which detail was obtained on buildings, roads, bridges, and the like. The results were sufficiently accurate to lead us to propose the client-controlled demonstration-of-ability tests described in the following paragraphs. The final evaluation rests on the analysis of the double-blind targets used in the concluding demonstration-of-ability tests.

2. Demonstration-of-Ability Tests: Double-Blind Client-Supplied Coordinates

In order to subject the remote viewing phenomena to a rigorous test under control of the client, a request for coordinates was transmitted to the client. In response, SRI personnel received the first set of coordinates, hereafter referred to as the West Virginia Site.

a. West Virginia Site (Swann)

Date: 29 May 1973, 1634-1640, Menlo Park, California
Protocol: Coordinates 38°23' 45-48"N, 79°25' 00"W
given by Dr. H. E. Puthoff to subject I. Swann to initiate experiment. No maps were permitted and the subject was asked to give an immediate response. The session was recorded on video tape.

Swann response:

This seems to be some sort of mounds or rolling hills. There is a city to the north (I can see the taller buildings and some smog). This seems to be a strange place, somewhat like the lawns that one would find around a military base, but I get the impression that there are either some old bunkers around, or maybe this is a covered reservoir. There must be a flagpole, some highways to the west, possibly a river over to the far east, to the south more city.

The map of Figure 2 was drawn.

On the following morning, Swann submitted a written report of a second reading, dated 30 May 1973, 0735-0758, Mountain View, California.

Cliffs to the east, fence to the north. There's a circular building (a tower?), buildings to the south. Is this a former Nike base or something like that? This is about as far as I could go without feedback, and perhaps guidance as to what was wanted. There is something strange about this area, but since I don't know particularly what to look for within the scope of the cloudy ability, it is extremely difficult to make decisions on what is there and what is not. Imagination seems to get in the way. (For example, I seem to get the impression of something underground, but I'm not sure.) However, it is apparent that on first sighting the general location was correctly spotted.

The map of Figure 3 was drawn.

b. West Virginia Site (Price)

As a back-up test, the coordinates were given to a second subject (Price) who appears to possess similar ability in casual testing. The task was presented to the second subject independently of the first, both to prevent collaboration and to prevent any sense of competition.

Date: 1 June 1973, 1700, Menlo Park, California
Protocol: Coordinates 38°23' 45-48"N, 79°25' 00"W
given by Dr. H. E. Puthoff to subject Price by
telephone to initiate experiment.

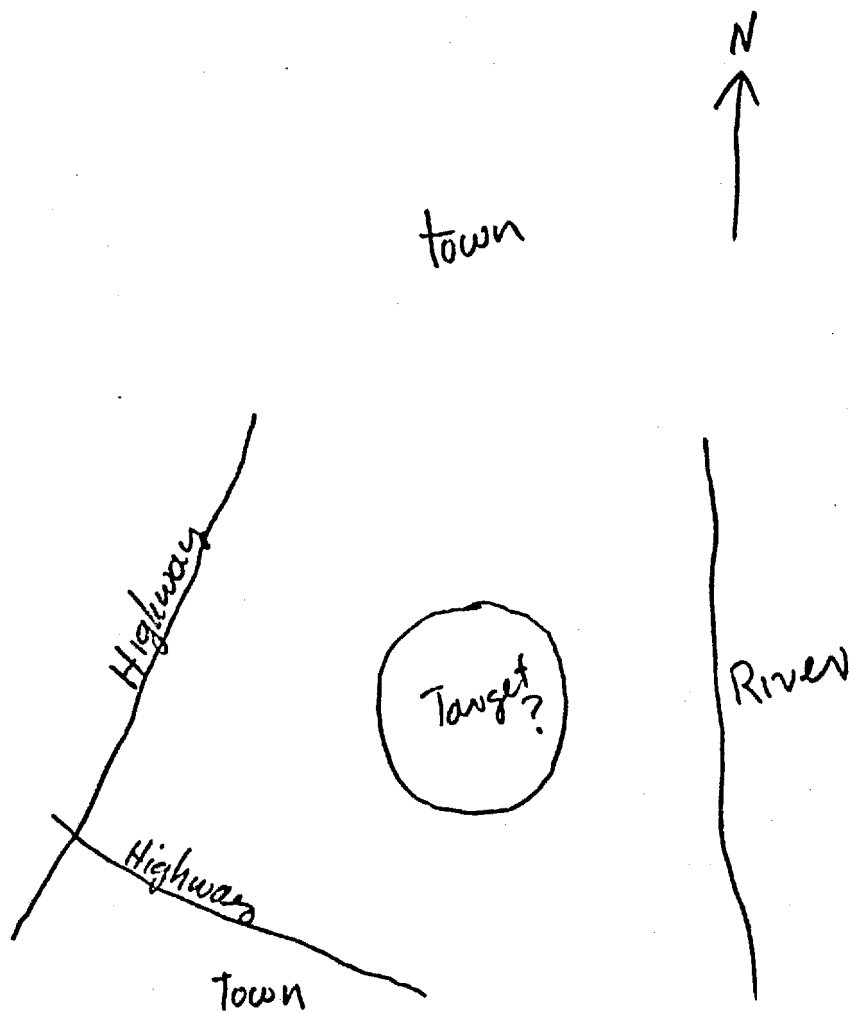

Some sort of camp.

FIGURE 2 MAP NO. 1 OF WEST VIRGINIA SITE (SWANN)

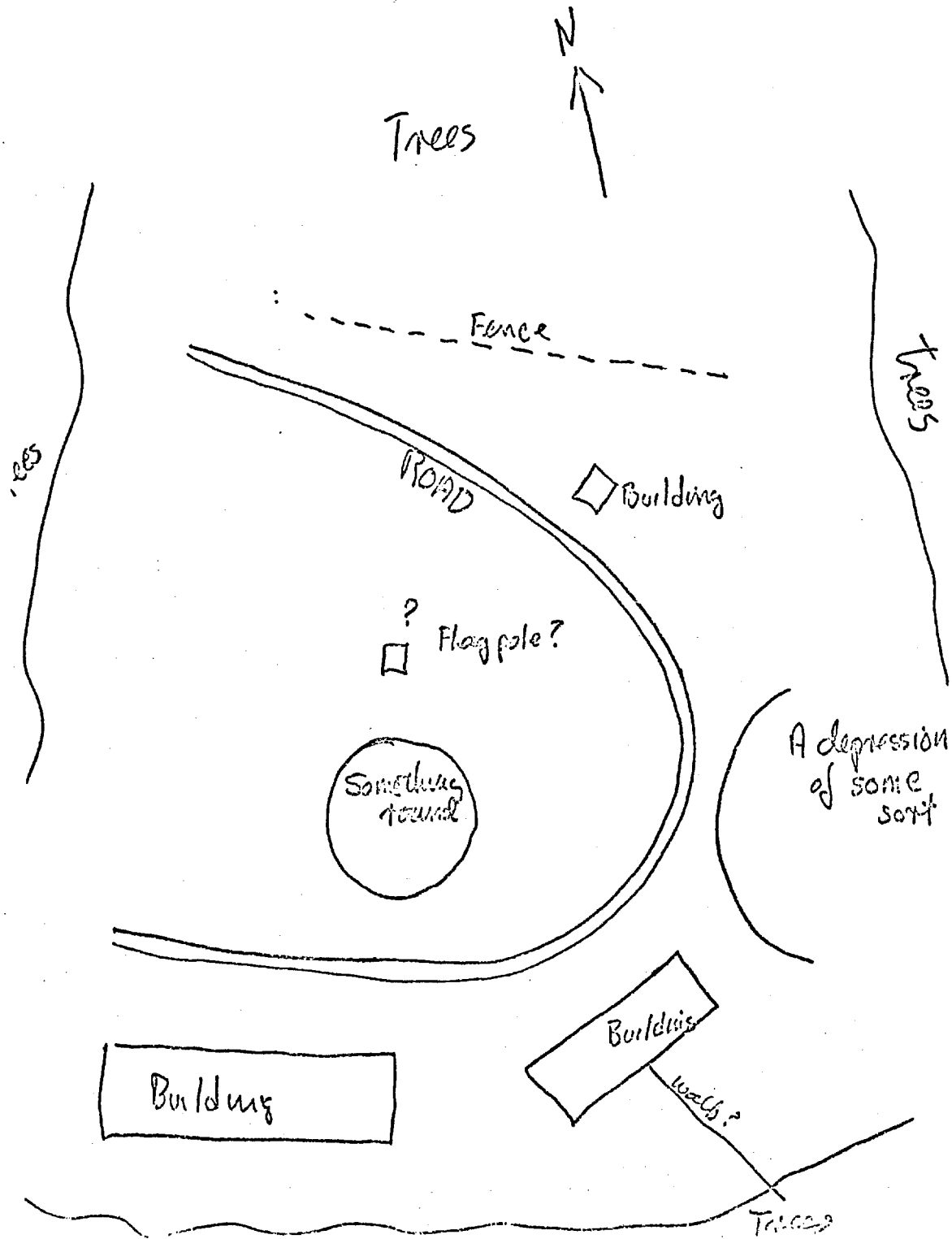

FIGURE 3 MAP NO. 2 OF WEST VIRGINIA SITE (DETAIL—SWANN)

On the morning of 4 June 1973 Price's written response (dated 2 June 1973, 1250-1350, Lake Tahoe, California) was received in the mail.

Looked at general area from altitude of about 1500' above highest terrain. On my left forward quadrant is a peak in a chain of mountains, elevation approximately 4996' above sea level. Slopes are greyish slate covered with variety of broad leaf trees, vines, shrubbery, and undergrowth. I am facing about 3°-5° west of north. Looking down the mountain to the right (east) side is a roadway, freeway country style--curves around base of mountain from S.W.--swings north for a few miles, then heads E.N.E. to a fairly large city about 30-40 miles distant. This area was a battleground in civil war--low rolling hills, creeks, few lakes or reservoirs. There is a smaller town a little S.E. about 15-20 miles distant with small settlements, village type, very rural, scattered around. Looking across the peak, 2500-3000' mountains stretch out for a hundred or so miles. Area is essentially wooded. Some of the westerly slopes are eroded and gully washed--looks like strip mining, coal mainly.

Weather at this time is cloudy, rainy. Temperature at my altitude about 54°--high cumulo nimbus clouds to about 25,000-30,000'. Clear area, but turbulent, between that level and some cirro stratus at 46,000'. Air mass in that strip moving W.N.W. to S.E.

1318 - Perceived that peak area has large underground storage areas. Road comes up back side of mountains (west slopes), fairly well concealed, looks deliberately so. It's cut under trees where possible--would be very hard to detect flying over area. Looks like former missile site--bases for launchers still there, but area now houses record storage area, microfilm, file cabinets; as you go into underground area through aluminum rolled up doors, first areas filled with records, etc. Rooms about 100' long, 40' wide, 20' ceilings with concrete supporting pilasters, flare-shaped. Temperature cool--fluorescent lighted. Personnel, Army 5th Corps Engineers. M/Sgt. Long on desk placard on grey steel desk--file cabinets security locked--combination locks, steel rods through eye bolts. Beyond these rooms, heading east, are several bays with computers, communication equipment, large maps, display type, overlays. Personnel, Army Signal Corps. Elevators.

1330 - Looked over general area from original location again-- valleys quite hazy, lightning about 30 miles north along mountain ridge. Temperature drop about 6°, it's about 48°. Looking for other significances: see warm air mass moving in from S.W. colliding with cool air mass about 100 miles E.S.E. from my viewpoint. Air is very turbulent--tornado type; birds in my area seeking heavy cover. There is a fairly large river that I can see about 15-20 miles north and slightly west; runs N.E.; then curves in wide valley running S.W. to N.E.; river then runs S.E. Area to east, low rolling hills. Quite a few Civil War monuments. A marble colonnade type: "In this area was fought the battle of Lynchburg where many brave men of the Union and Confederate Armys (sic) fell. We dedicate this area to all peace loving people of the future--Daughters G.A.R."

On a later date Price was asked to return to the West Virginia site with the goal of obtaining codeword information, if possible. In response, Price supplied the following information:

Top of desk had papers labeled:

Flytrap

Minerva

File cabinet on north wall labeled:

Operation Pool --- (2nd word unreadable)

Folders inside cabinet labeled:

Cueball

14 Ball

4 Ball

8 Ball

Rackup

Name of site vaguely seems like Hayfork or Haystack. Personnel:

Col. R. J. Hamilton

Maj. Gen. George R. Nash

Major John C. Calhoun??

c. Urals Site (Price)

After obtaining a reading on the West Virginia site, Price volunteered that he scanned the other side of the globe for a Bloc equivalent, and found one in the Urals at 65°00'57"N, 59°59'59"E, described as follows.

Elevation, 6200'. Scrubby brush, tundra type ground hummocks, rocky outcroppings, mountains with fairly steep slopes. Facing

north, about 60 miles ground slopes to marshland. Mountain chain runs off to right about 35° east of north. Facing south, mountains run fairly north and south. Facing west, mountains drop down to foothills for 60 miles or so; some rivers running roughly north. Facing east, mountains are rather abrupt, dropping to rolling hills and to flat land. Area site underground, reinforced concrete, doorways of steel of the roll-up type. Unusually high ratio of women to men, at least at night. I see some helipads, concrete. Light rail tracks run from pads to another set of rails that parallel the doors into the mountain (see Figure 4). Thirty miles north (5° west of north) of the site is a radar installation with one large (165') dish and two small fast-track dishes.

The above reports were submitted to the client for evaluation. A second set of coordinates was requested and obtained, hereafter referred to as the Kerguelen Island Site.

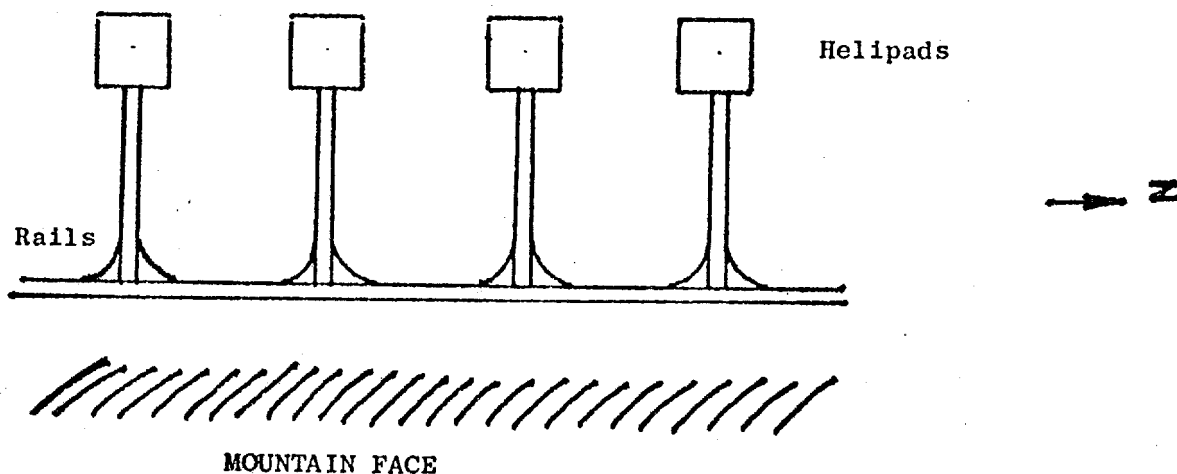

FIGURE 4 MAP OF URALS SITE (PRICE)

d. Kerguelen Island Site (Swann)

Date: 21 July 1973, 1708-1730, Menlo Park, California
Protocol: Coordinates 49°20'S, 70°14'E given by Dr.
H. E. Puthoff to subject I. Swann to initiate experi-
ment. No maps were permitted and the subject was asked
to give an immediate response. The session was recorded
on video tape.

Swann response:

My initial response is that it's an island, maybe a mountain sticking up through a cloud cover. (Experimenter checks, gives positive feedback.) Terrain seems rocky. Must be some sort of small plants growing there. Cloud bank to the west. Very cold. I see some buildings rather mathematically laid out. One of them is orange. There is something like a radar antenna, a round disc. (Subject draws map during report.) Two white cylindrical tanks, quite large. To the northwest a small airstrip. Wind is blowing. Must be two or three trucks in front of building. Behind, is that an outhouse? There's not much there. That's all, I think, for now.

Swann submits map, Figure 5.

On the following day, 1152-1215, the identical protocol was followed for a second reading. Again, no maps were permitted. During this reading, Swann described following the coastline of the island, drawing segments on 8-1/2" x 11" pieces of paper as he went, resulting in Figure 6 when the pieces were assembled.

It's not completely dark there, sort of orangish light. If I look to the west, hills; to the north flatlands and, I think, airstrip and ocean in the distance; to the east, rolling bumpy grasslands with bumps; to the south is -- I can't see anything to the south. I move north to the coastline and follow it around. That's point A (begins to draw map). Point B, rocks sticking up out of the ocean, breakers on them. Point C, little cluster of buildings with wharf, boats. Point D, jutting of land sticking out. Point F* is sand basin, river coming through,

* Lettering out of order.

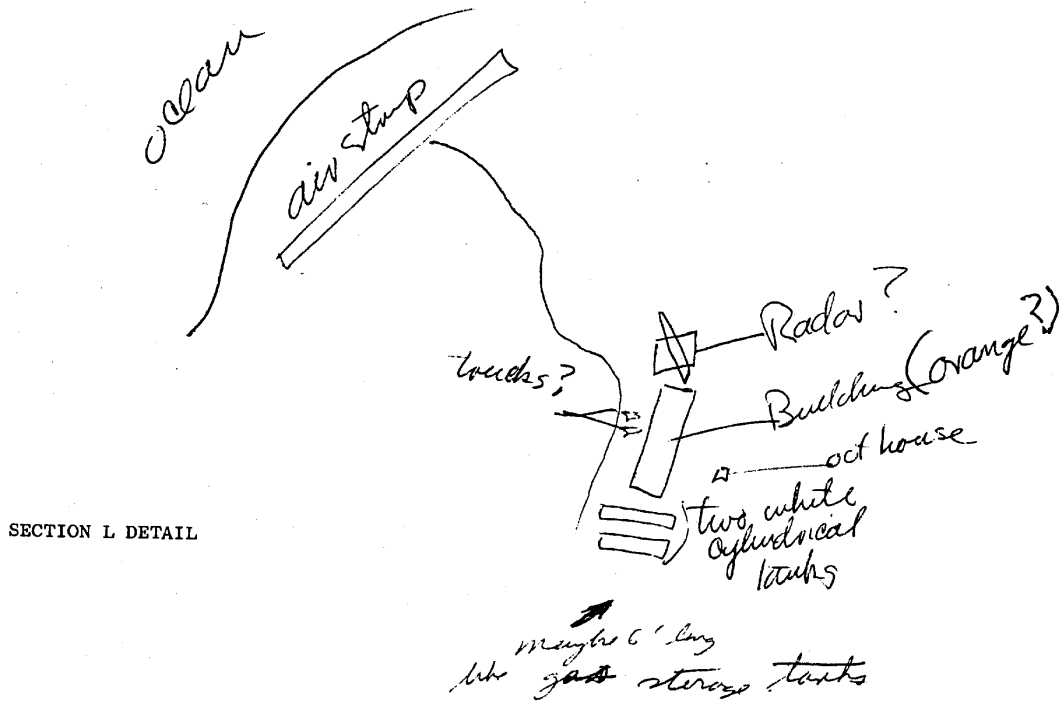

SECTION L DETAIL

FIGURE 5 MAP NO. 1 OF KERGUELEN ISLAND SITE (DETAIL—SWANN)

lots of birds. Point E, brush of small trees. This is fun (laughs), first time I've ever done this. (Following E) almost a straight coastline, cuts in rocks, beach. Then curves back. I see to northwest a mountain rising, snow on top. Area G is irregular. Point H is a high cliff, Point I is a promontory. Point J has big breakers, K is a bay, L is area I drew yesterday (circles area, draws airstrip and buildings for orientation to previous map). That will do for today. May be a lighthouse (on tip?). I lacked courage going around Point G.

e. Kerguelen Island Site (Price)

Date: 20 July 1973, 1400, Menlo Park, California
Protocol: Coordinates 49°20'S, 70°14'E given by Dr.
H. E. Puthoff to subject Price by telephone to initiate
experiment.

Price Response:

On the morning of 21 July 1973 Price's written response (dated 20 July 1973, 2055-2232, Santa Clara, California) was received (hand carried).

Picked 15,000' altitude. Looking south, 4° east of south, see a site located on a cliff about 200' high above the ocean. Installation is a cluster of buildings and radar tracking station (see Figure 7). Radar is a segment concave type rather than circular dish type. Building #1 is the largest, L-shaped, front facing NW, two stories plus basement. Buildings #2 and #3 about 75'-100' east of main building, also two stories plus basement. Building #2 has recreation and dining facilities, building #3 contains living quarters. Building #4 is a shop and maintenance area. Buildings are all interconnected on the ground floor.

I see a dock area at the base of the cliff, and 1/4 to 1/2 mile from the buildings is an airstrip.

The installation has four functions:

- 1) Tracking (space)
- 2) Meteorological station
- 3) Monitoring equipment for radiation readings
- 4) Radio relay station.

I see a couple of other radar installations covered by geodesic domes. There are two small tracking radars interlinked with main radar.

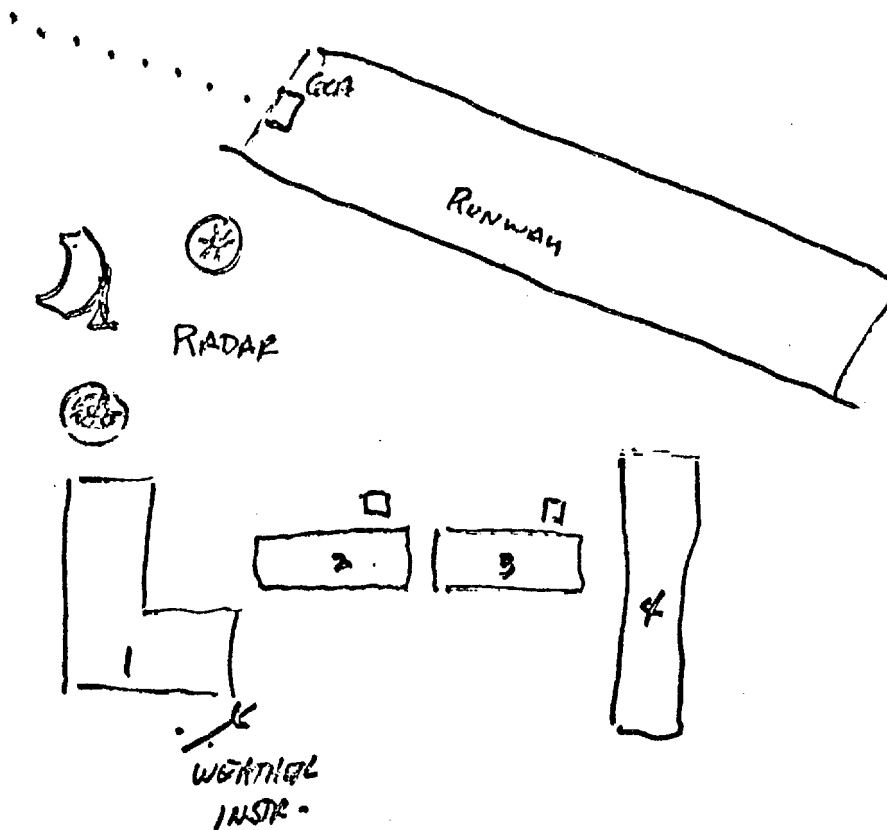

FIGURE 7 MAP NO. 3 OF KERGUELEN ISLAND SITE (PRICE)

I had the impression that the personnel (military and civilian) were French, but since I could understand what was being said I assume personnel are American.

f. Analysis of Results (Double-Blind Client Coordinates)

The results obtained with the double-blind client coordinates have been evaluated separately by the client. (See attached supplement.)

As an additional control with regard to the experimental protocol, SRI personnel have not been informed before, during, or afterward of any details of the target series parameters, including the hit-miss profile. However, SRI personnel have been informed that in each experiment there have been at least some categories of information in which the data exceed any possible bounds of coincidental correlation, and exceed any possible bounds of acquisition by known means. It has also been reported that some of the data possibly constitute "noise" in the signal, but it has usually been difficult to negate totally any information given by the subjects.

Therefore, we conclude from this portion of the study that:

- A channel exists whereby information about a remote location can be obtained in the manner described.
- As with all biological systems the information channel appears to be imperfect, containing some noise along with the signal.
- While a signal-to-noise ratio cannot as yet be determined by SRI personnel with regard to client-controlled targets, a semiquantitative signal-to-noise ratio might be determined with additional experimental effort.

B. EEG Experiments

One premise underlying our investigation is that paranormal functioning is distributed throughout the population in much the same manner as every other ability, and indeed in much the same way as intelligence

is distributed. We further conjecture that it is partially the "world view" of the times in which we live that prevents paranormal ability from surfacing to a greater extent.

Our EEG program was initiated in an effort to determine whether objective physiological measures of paranormal functioning exist and to relieve the subject from the burden of having to demonstrate volitionally any sort of paranormal functioning. We inform our subjects that a light is to be flashed from time to time in a distant room, and if they perceive that light it may be evident from changes in their EEG output. This experiment tests the hypothesis that perception may take place and be measurable at noncognitive levels of consciousness, even though not easily expressed verbally.

In our work with four female volunteer subjects, we have found evidence in three of their EEG spectra that they are influenced by the remote stimulus. Thus it appears from this exploratory work that we have a repeatable perception experiment that yields significant results even with unselected subjects.

The experimental protocol for the experiment is as follows: A subject is seated in a shielded EEG monitoring room in the Life Sciences Building of SRI. A friend of the subject is seated in a remote room with the stimulus generator, in this case a strobe light. The EEG output is recorded from the vertexes and occiputs (regions of the brain) simultaneously from both participants. On each trial, a tone burst precedes by one second a ten-second train of flashes presented to one of the subjects designated as the "sender." The subject who does not see the flashes is designated the "receiver;" this subject also hears the warning signal. This signal evokes a contingent negative variation (CNV) in each of the subjects as they anticipate the occurrence of the flashes. Thirty-six such trials are given, each consisting of 12 null trials, i.e., 0 flashes/second, 12 6-Hz flashes, and 12 16-Hz flashes intermixed in a random order. Each of the 36 trials consists of a ten-second EEG epoch. The EEG data are recorded on magnetic tape and digitized. The 12 data blocks associated with the 0, 6, and 16 Hz trials are averaged. A spectral analysis is then performed on the average.

This analysis has given two types of results. In two subjects we have evidence of actual modulation of the EEG output at the flash frequency. The other (more consistent) observation is that the dominant alpha production of the resting subjects is pulled to higher frequencies during the 6- and 16-Hz trials as compared with the 0 flashes/second trials.

In summary, the "receiver" subject knows when a trial period is beginning but does not know whether the light will be flashed nor what the flash frequency will be. However, from the accumulated EEG data, we tentatively conclude that there is evidence strongly suggesting that human subjects can directly--even though noncognitively--perceive remote stimuli not presented to any known perceptual sense, and the perception event can be recorded by an objective process.

Figure 8 shows the averaged EEG for a subject attempting to perceive the remote stimulus. In this case the twelve averaged trials are for the 6- and 16-Hz light. The spectrum indicates a significant ($p = 0.05$) increase in the 16-Hz component during the 16-Hz period.

Figure 9(a) shows an overlay of the three averaged spectra for a different subject. Figure 9(b) shows the difference spectrum where the 0 trials data are electrically subtracted from the 6-Hz data. This difference curve shows a clear frequency shift in the dominant component of the subject's alpha (9-11 Hz) production. Of our four subjects, this subject had by far the most monochromatic EEG spectrum. Again the frequency shift obtained from comparing the stimulus versus nonstimulus trials was significant at the $p = 0.05$ level for the 6-Hz case and at the $p = 0.005$ level for the 16-Hz case.

A second important use of the EEG technique is to allow a determination to be made of what confidence level to place on what a subject reports that he is perceiving during the course of his remote viewing experience.

Subjects taking part in these EEG experiments are asked to indicate their conscious feelings, on a trial-by-trial basis, as to which stimulus is being generated. They make their guess known to the experimenter via one-way telegraphic communication. An analysis of these guesses has shown a correlation between the correct calls and certain characteristic changes in EEG output. These changes vary from subject to subject but appear to be constant for any one subject. Having observed this apparent correlation in exploratory work, it is important to continue this study further to determine its constancy.

In experiments with Swann, the correlation took the form of a decrease in monochromaticity of his alpha production when his verbal responses to a stimulus condition were correct. (In this experiment Swann was asked to determine whether a remote helium-neon laser was on or off.) In the course of this experiment there was thus an apparent correlation between the accuracy of his perception and his EEG production, even though his overall task performance in this particular experiment did not differ significantly from chance expectation.

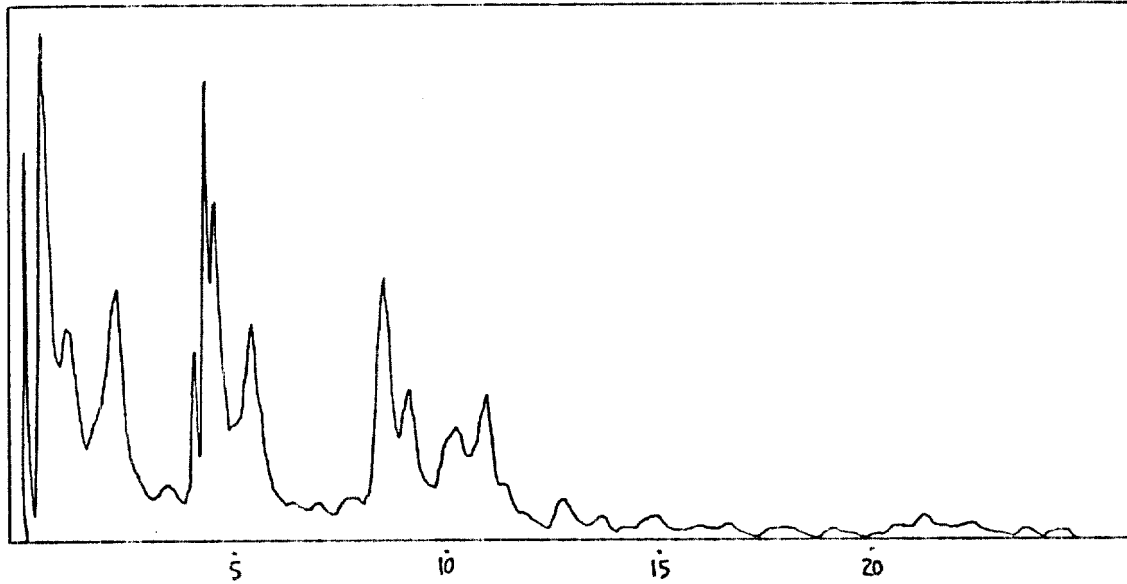

(a) SENDER STIMULATED WITH 6-Hz FLASHES

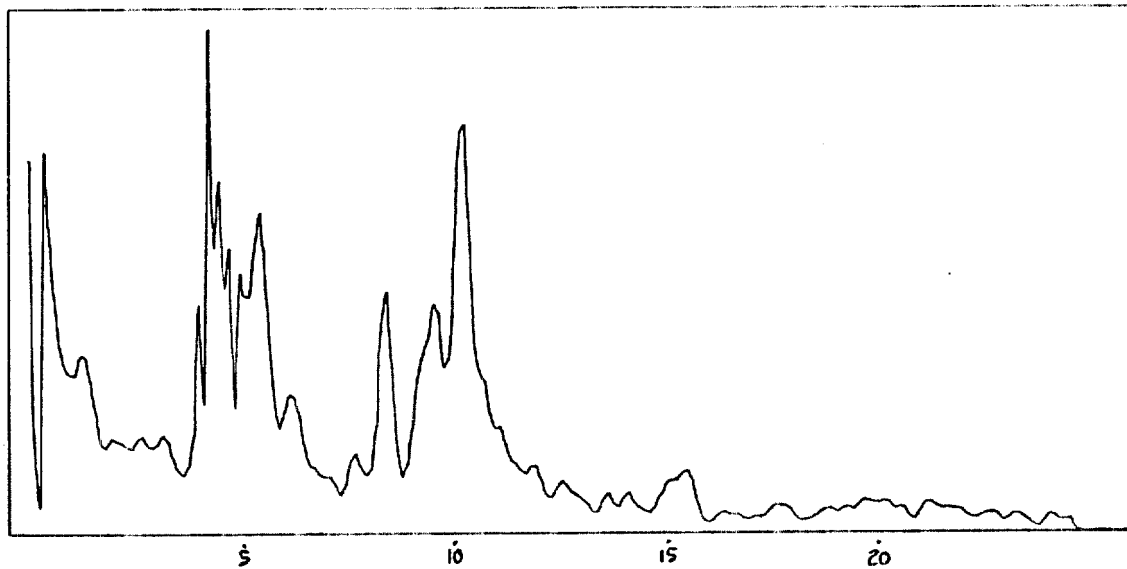

(b) SENDER STIMULATED WITH 16-Hz FLASHES

FIGURE 8 OCCIPITAL EEG FREQUENCY SPECTRA, 0 TO 25 Hz, OF JEAN MAYO, RECEIVER

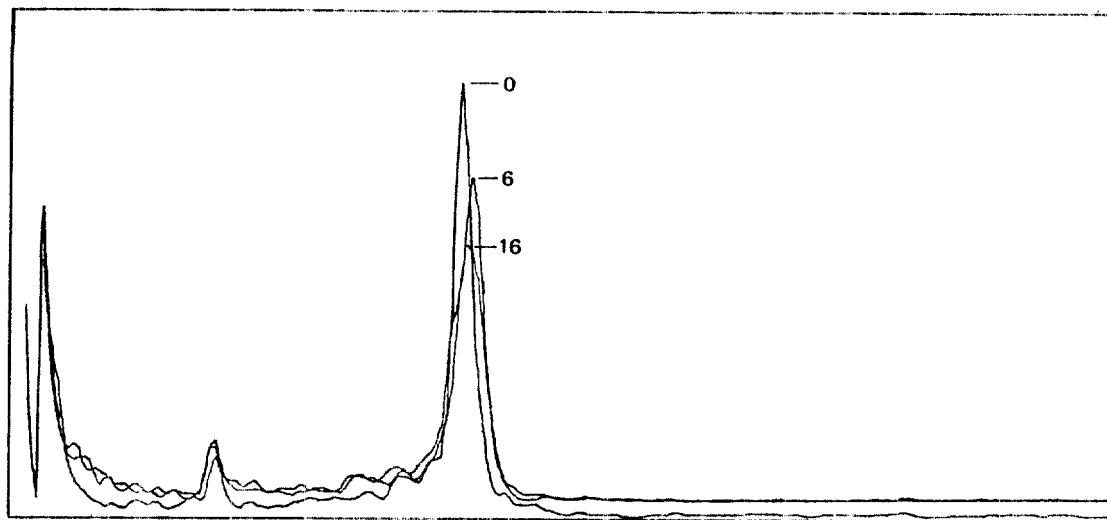

(a) THREE CASES—0-, 6-, AND 16-Hz FLASHES (12-TRIAL AVERAGE)

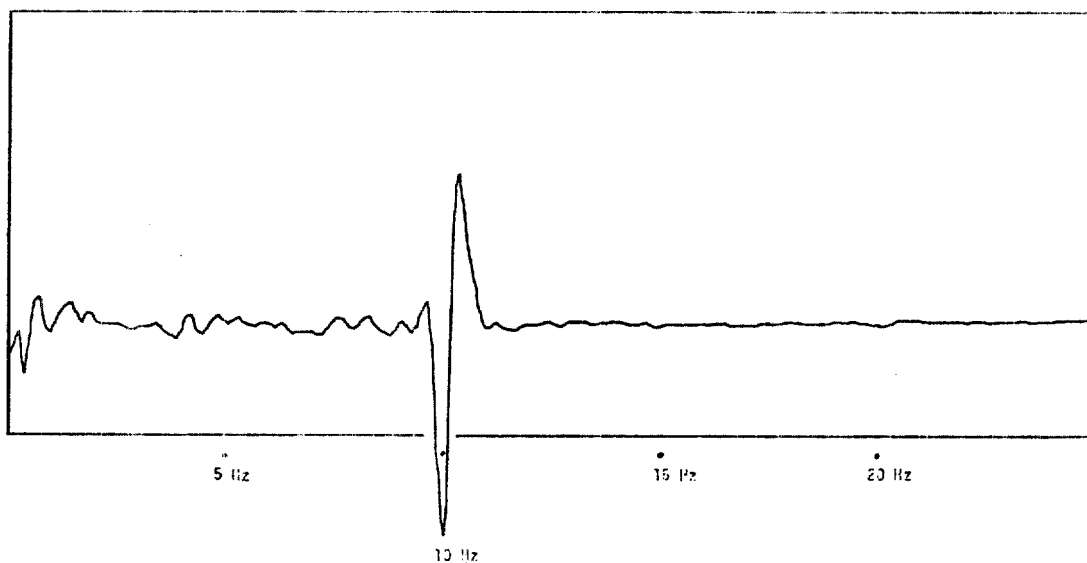

(b) DIFFERENCE SPECTRA—6-Hz MINUS 0-Hz

FIGURE 9 OCCIPITAL EEG FREQUENCY SPECTRA, 0 TO 25 Hz, OF HELLA HAMMID, RECEIVER

In other work with Swann at the American Society for Psychical Research, Dr. Karlis Osis has reported that when Swann attempted to reproduce pictorially the contents of a hidden container, his EEG output would consistently shift from lower to higher frequencies. Swann was highly successful (eight out of eight) in this series of perception experiments.

It therefore appears that monitoring of the EEG may prove to be a good indicator as to the measure of confidence that should be placed in a subject's report about his perception of a remote scene.

C. Remote Perception of Graphic Material

The objective of this group of experimental sessions was to investigate the apparent paranormal perception ability of gifted subject Uri Geller under carefully controlled conditions with the goal of understanding the physical and psychological variables underlying such ability.

On each day of an eight-day experimental period, picture drawing experiments were carried out. In these experiments, Geller was separated from the target material either by an electrically isolated, shielded room or by the isolation provided by having the targets drawn on the East Coast. As a result of Geller's success in this experimental period, we consider that he has demonstrated his paranormal perceptual ability in a convincing and unambiguous manner.

Saturday, 4 August--Two drawing experiments were conducted this day. In both of these, Geller was closeted in an opaque, acoustically and electrically shielded room. This room is the double-walled shielded room used for EEG research in the Life Sciences Division of SRI. It is locked by means of an inner and outer door, each of which is secured with a refrigerator-type locking mechanism, as shown in Figure 10.

The two drawings used in this experiment were selected by randomly opening a large college dictionary and selecting the first word that could reasonably be drawn. The first word obtained in this manner was "fuse" and the object drawn was firecracker [Figure 11(a)]. All target selection and picture drawing was done with Geller already in the shielded room. Geller was notified via intercom when the target picture was drawn and taped to the wall outside his enclosure. He was continuously monitored by a one-way audio circuit.



FIGURE 10 SHIELDED ROOM USED FOR EEG EXPERIMENTS

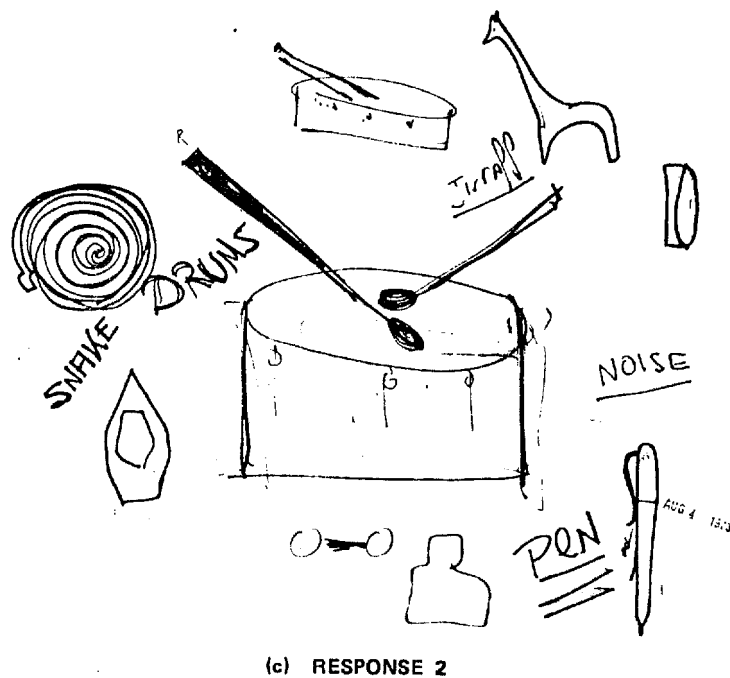
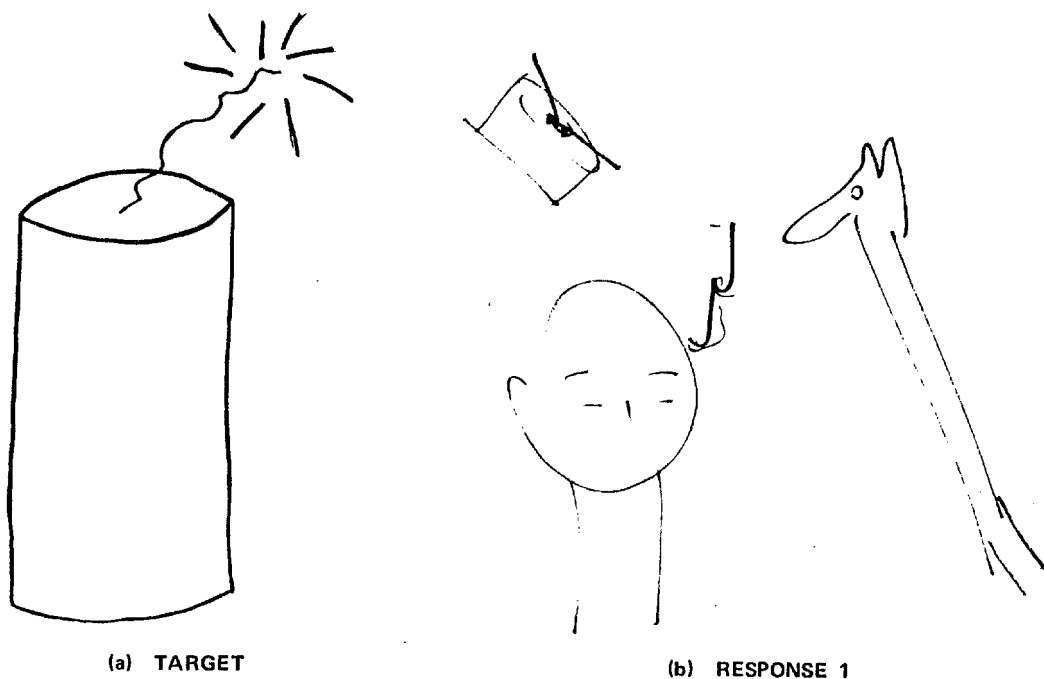

FIGURE 11 TARGET 1 (FIRECRACKER) AND GELLER'S RESPONSES

Geller's almost immediate response was that he saw "a cylinder with noise coming out of it." His drawing representing his response to the target was a drum, along with a number of other cylindrical-looking objects [Figures 11(b) and 11(c)].

The second word selected was "bunch," and the target was a bunch of grapes. Geller's immediate response was that he saw "drops of water coming out of the picture." He then talked about "purple circles." Finally, he said that he was quite sure that he had the picture. His drawing was indeed a bunch of grapes. Both the target picture and Geller's rendition had 24 grapes in the bunch (Figure 12).

In this work the target picture is never discussed by the experimenters after the picture is drawn or brought near the shielded room. The intercom operates only from the inside of the room to the outside, except when the push-to-talk switch is depressed on the outside of the room. In our detailed examination of the shielded room and the protocol used in these experiments no sensory leakage has been found, nor has any defect in the protocol been brought to our attention.

Sunday, 5 August--Geller is locked in the shielded room with one experimenter outside as a monitor while the target is drawn in the other experimenter's office about a half mile away. The target selected from the dictionary was an outline drawing of a man, which evolved through the drawing process into a devil with a trident [Figure 13(a)]. To start the experiment, Puthoff, who was with Geller, called Targ, who was with the drawing. Geller spent almost a half-hour working on the drawing before "passing," as he felt unable to get the drawing. We include his efforts nonetheless for the insight into the process that they provide.

His drawings [Figures 13(b)-13(d)] were as follows:

- "Moses' Tablets," i.e., Ten Commandments.
- Apple with a worm coming out of it, a snake was in the same picture, and the Tablets symbolism of the first drawing.
- Composite picture with the Ten Commandments on top of the world and the trident on the outside, along with a neatly drawn leaf.

One is led to speculate that the Biblical representation in these three drawings is perhaps associational material triggered by the target. The inability on Geller's part to draw the devil may be culturally induced.

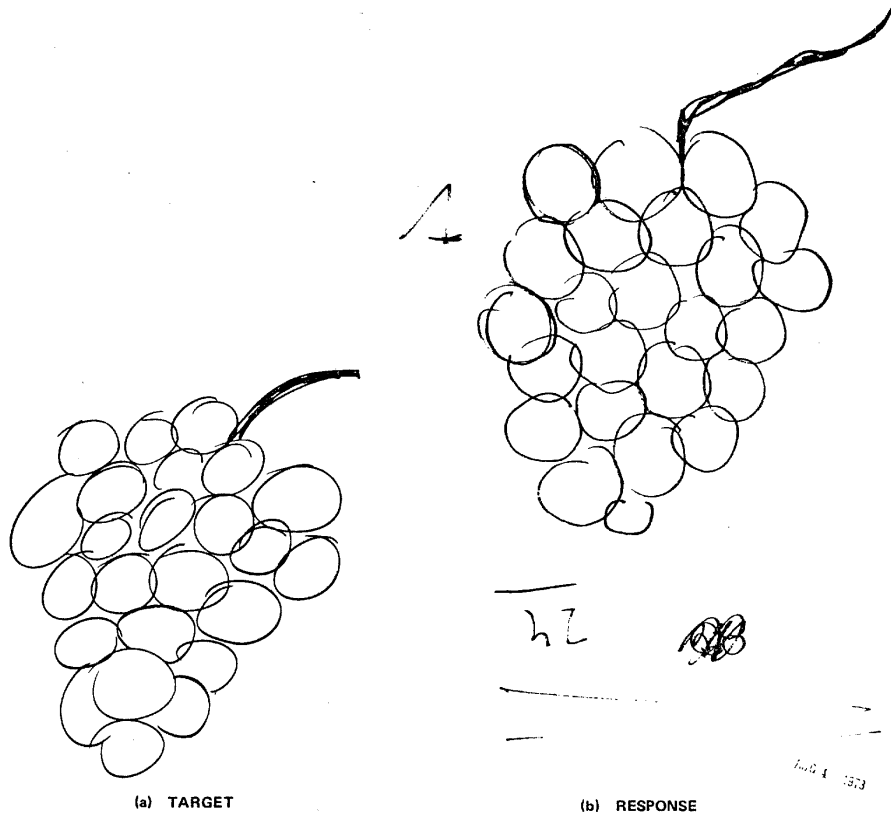

FIGURE 12 TARGET 2 (GRAPES) AND GELLER'S RESPONSE

28

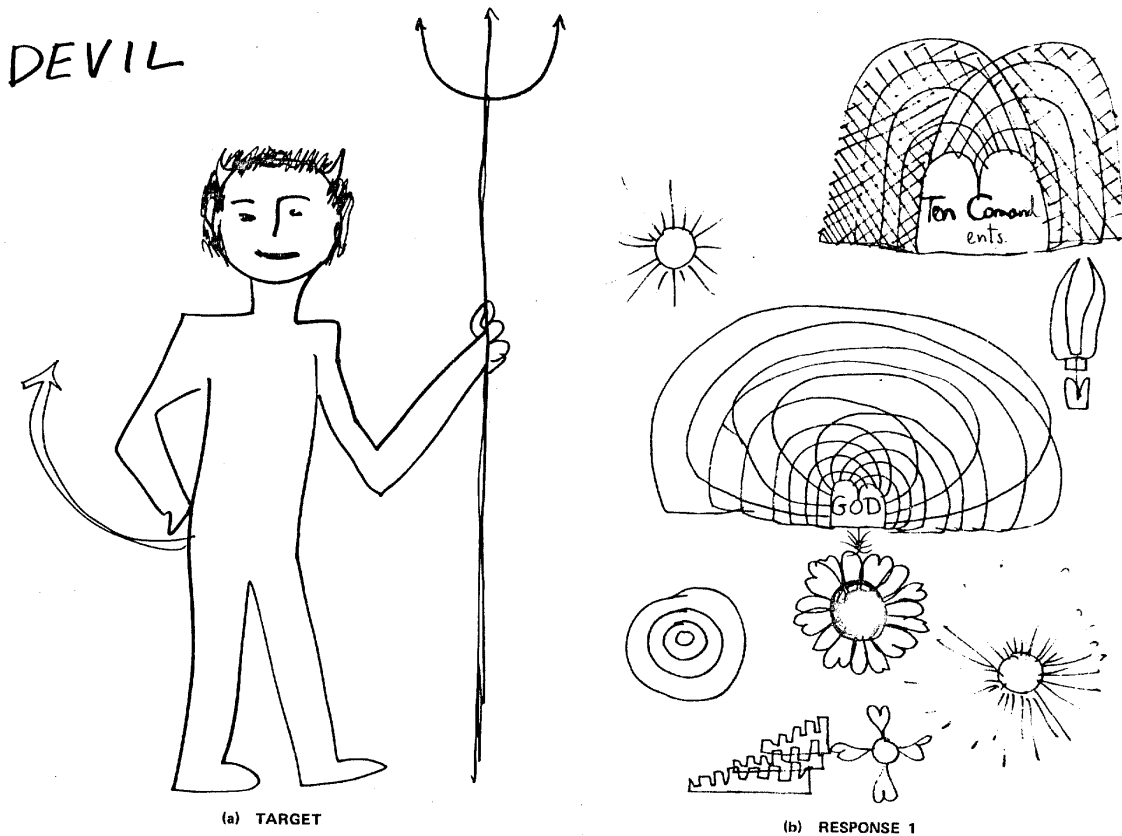

FIGURE 13 TARGET 3 (DEVIL) AND GELLER'S RESPONSES



(c) RESPONSE 2



(d) RESPONSE 3

FIGURE 13 TARGET 3 (DEVIL) AND GELLER'S RESPONSES (Concluded)

With regard to the target picture, Geller did draw the trident from the target picture, but he did not draw the man who was holding it. From this it seems clear that Geller does not simply copy lines from the target picture, but rather he apparently performs some mental processing before drawing them.

The second target picture was drawn by an experimenter while he was inside the shielded room with Geller outside the room with another experimenter. In this case the target [Figure 14(a)] was a representation of the solar system. His immediate verbal reaction before drawing was one of "space." Geller's drawn response to the target while outside the room [Figure 14(b)] coincides well with the target drawing. The block in the center of Geller's picture, according to his statement, was his afterthought suggested by the movie 2001 and was drawn as an addition just before comparing target with response.

Monday, 6 August--The experiment to be done this day was a pure clairvoyance task. A picture was drawn by a scientist outside the usual experimental group. The picture was locked in the shielded room before Geller's arrival at SRI. Geller was then led by the experimenters to the shielded room, and asked to draw the picture inside the room. He drew a number of pictures, all of which he rejected as not being applicable. He said that he got no clear impression and passed. The target was a rabbit, and nothing Geller drew in any way resembled a rabbit. It should be added that the picture was drawn by a scientist of whom Geller is not fond, and Geller asked at the outset if this was the case. The experimenters said that this was not the case, since they did not know who had drawn the picture. Geller felt vindicated to some extent when he found out that his initial guess as to the artist had been correct.

Tuesday, 7 August--This day two target pictures were attempted with Geller in the shielded room. He was connected to an EEG apparatus to allow measurement of his brain waves at the time that he was attempting to perceive a hidden picture. The two target pictures were a tree and an envelope. He experienced difficulty, did not make a drawing that corresponded to either drawing, and passed. Also, he found it very difficult to hold adequately still to make good EEG records. The same skeptical experimenter who drew the rabbit was the EEG operator on this second unsuccessful day.

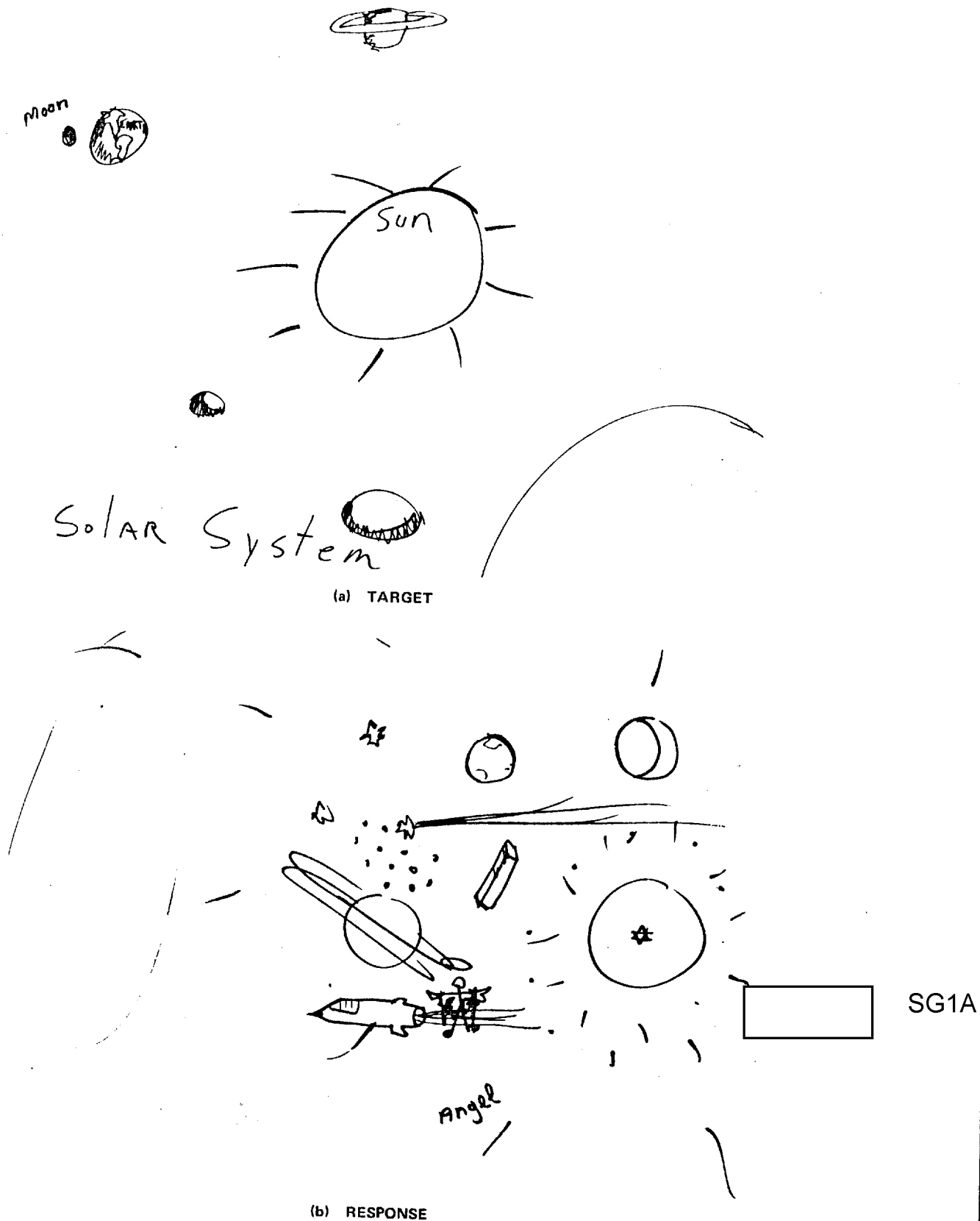

FIGURE 14 TARGET 4 (SOLAR SYSTEM) AND GELLER'S RESPONSE

Wednesday, 8 August--Three targets were drawn during the course of this day's work. In the first, the experimenters closed the outer door of the laboratory in which the shielded room is located (in addition to the inner double doors) and worked in an adjoining room. The target picture in this case was a camel. Geller felt unsure and passed, but his first choice drawing was a horse (see Figure 15).

The experimenters then returned to the room outside the shielded room and drew the second picture, which was the Golden Gate Bridge [Figure 16(a)]. Geller inside the shielded room drew some curved lines with some squares underneath [Figure 16(b)]. He said that he didn't know what the picture was and passed.

The third picture was a flying seagull. Geller said almost immediately that he saw a flying swan over a hill. He drew several birds and said that he was sure that his drawing was correct, which it was (Figure 17).

Experiments were conducted in the shielded room for six days; good results were obtained on four of the days when there was no openly skeptical observer present.

Thursday, 9 August--The experiments were moved to SRI's Engineering Building in order to make use of the computer facilities available. After Geller was secured in a shielded room about 150 feet down the hall and around a corner from the computer room and placed under continuous monitoring, a picture of a kite was drawn on the face of the TV screen driven by the computer's graphics program. Shortly after Geller was notified that the picture had been drawn, he had the computer room called to determine if the target picture was a geometric picture or an object. By talking to an intermediary, who was ignorant of the target picture, we told him that it was an object. Geller's first drawing in this case was a square with the diagonals drawn in. He then also drew some triangular airplanes and passed. His first drawing was a good representation of the actual target picture (Figure 18).

Friday, 10 August--Two pictures were drawn and stored in the computer memory so that no visible evidence was available in the computer room after the picture was drawn.

The first picture was a church. The picture was drawn and stored in the memory of the computer. Geller's responses are shown in the attached collection of drawings (Figure 19). It appears that both of

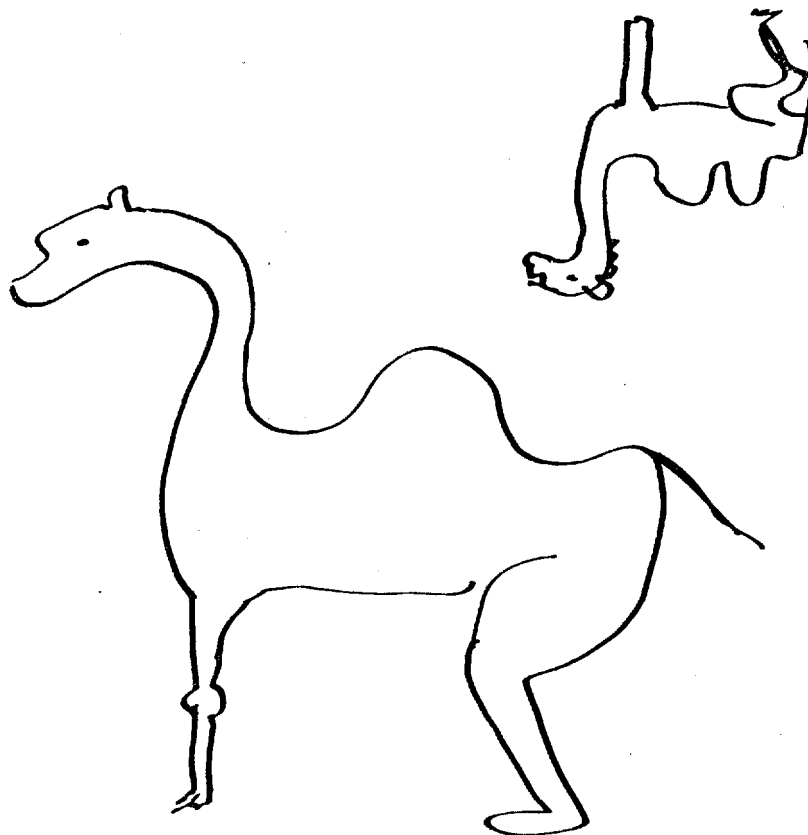

(a) TARGET

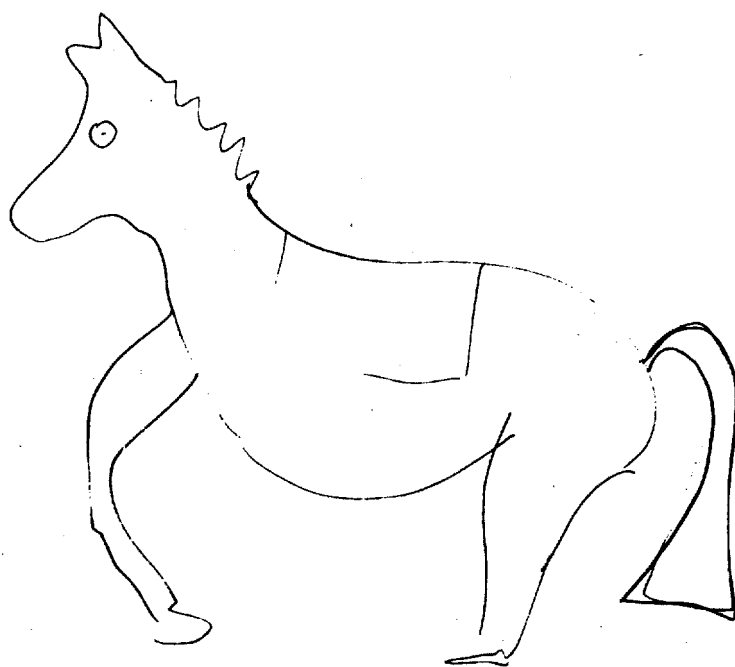

(b) RESPONSE

FIGURE 15 TARGET 5 (CAMEL) AND GELLER'S RESPONSE

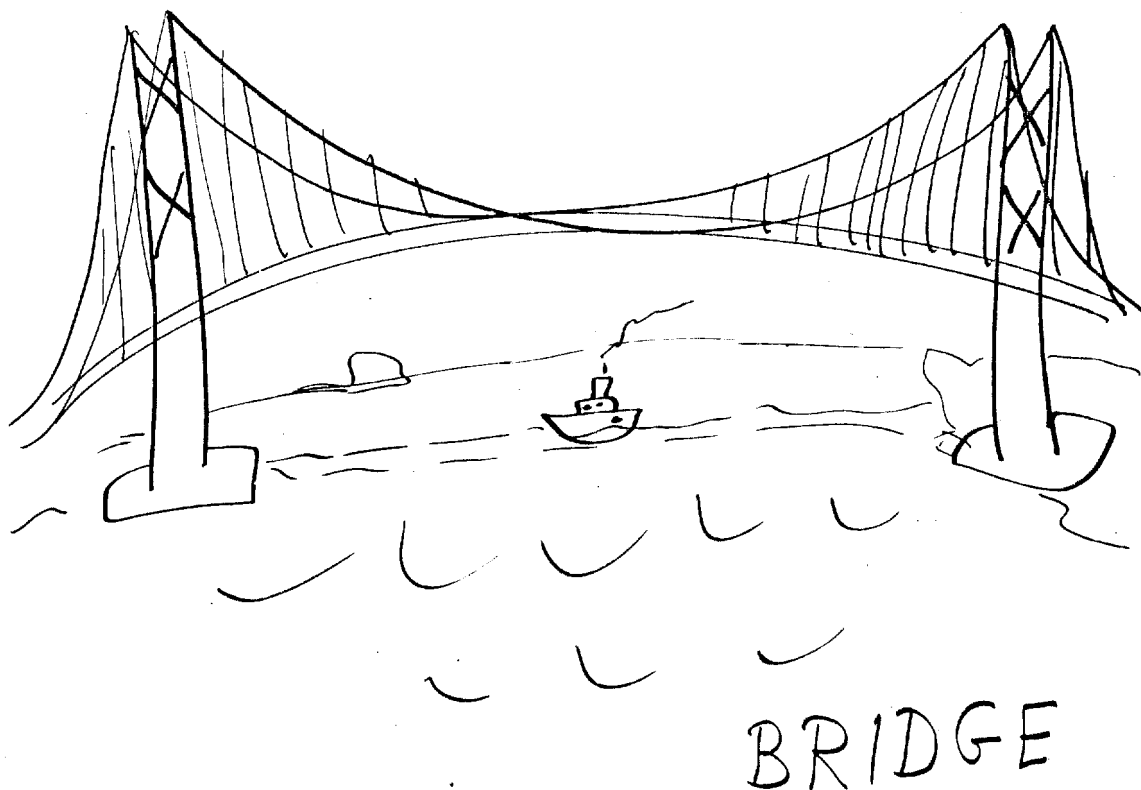

(a) TARGET

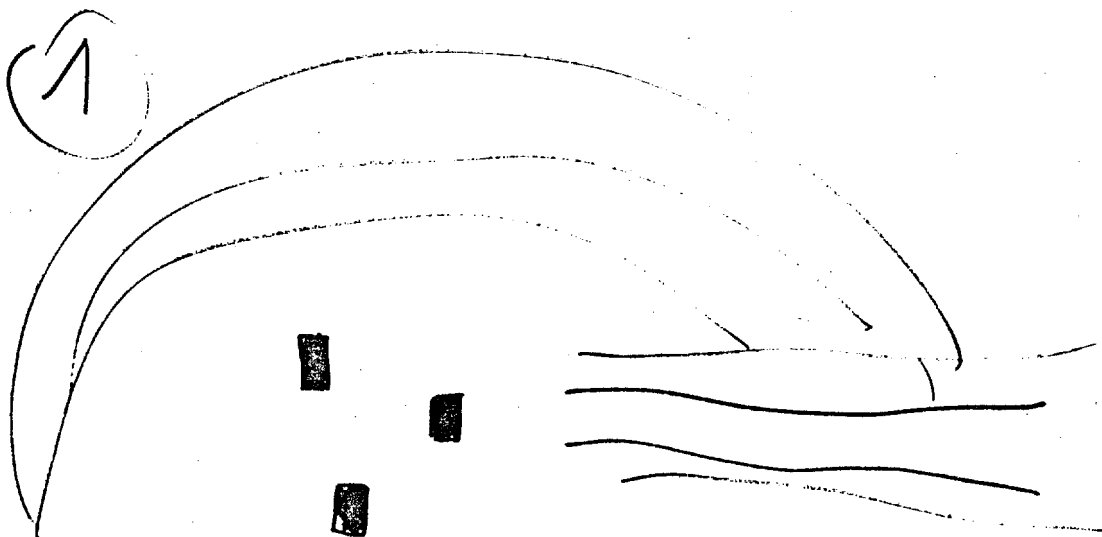

(b) RESPONSE

FIGURE 16 TARGET 6 (GOLDEN GATE BRIDGE) AND GELLER'S RESPONSE



(a) TARGET

(b) RESPONSE

FIGURE 17 TARGET 7 (SEAGULL FLYING) AND GELLER'S RESPONSE

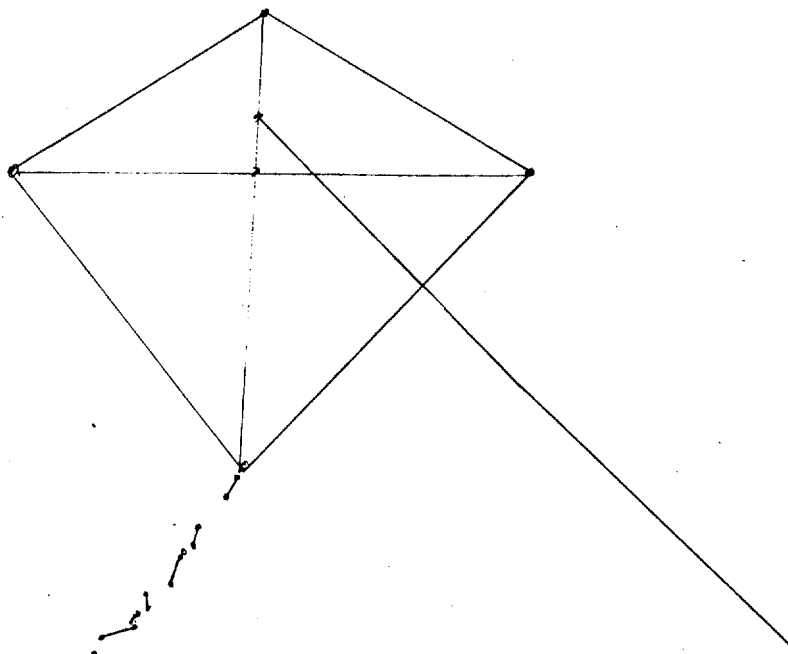

(a) TARGET

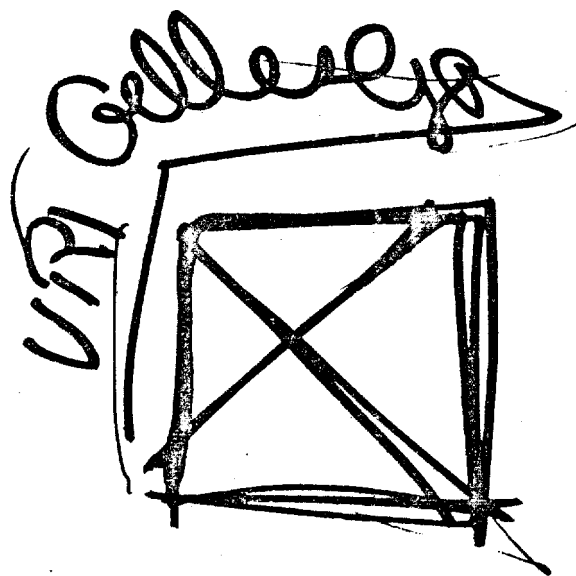

(b) RESPONSE

FIGURE 18 TARGET 8 (KITE ON CRT DISPLAY) AND GELLER'S RESPONSE

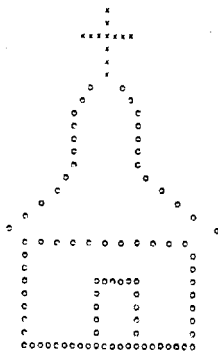

(a) TARGET

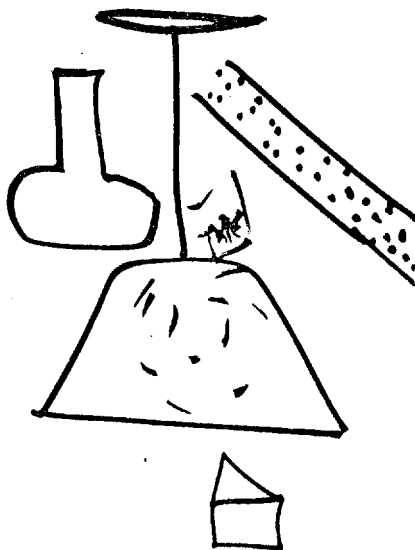

(b) RESPONSE 1

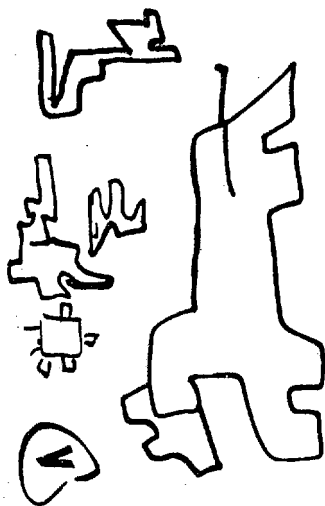

(c) RESPONSE 2

FIGURE 19 TARGET 9 (CHURCH, STORED IN MEMORY OF TEXT-EDITING COMPUTER) AND GELLER'S RESPONSES

his attempts have some elements in common with the target drawing, but he had no idea that it was a church and he passed.

The second target picture was stored on the face of the TV tube with the intensity turned off so that no picture was visible with the room lights turned on. Geller immediately drew an arrow under a rounded brick and then drew another arrow inside a suitcase. We consider the arrow in the suitcase similar to the target, which was an arrow through a heart (Figure 20).

These latter two experiments admit to at least two hypotheses, which will require further work to differentiate:

- Perception of information stored in the computer.
- Perception of mental contents, since there were several people in the computer room, all of whom knew the nature of the target that was stored.

A long-distance telepathy experiment was also done on 10 August. An East Coast scientist was called and asked to draw a simple representational object for Geller to copy. [Following the experiment he indicated that he drew two peaked mountains with a sun in the upper right.] Geller drew two arches side by side with a circle in the upper right. Geller's picture also had a train-like object running through it. We consider this to be suggestive of communication but not conclusive. Further work along these lines is indicated.

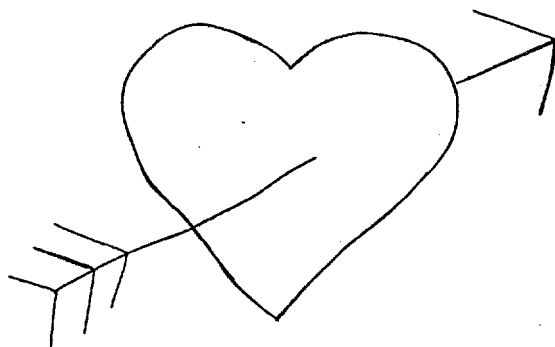

(a) TARGET

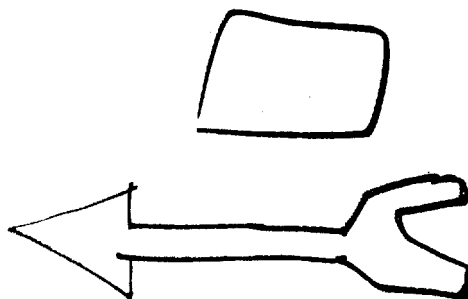

(b) RESPONSE 1

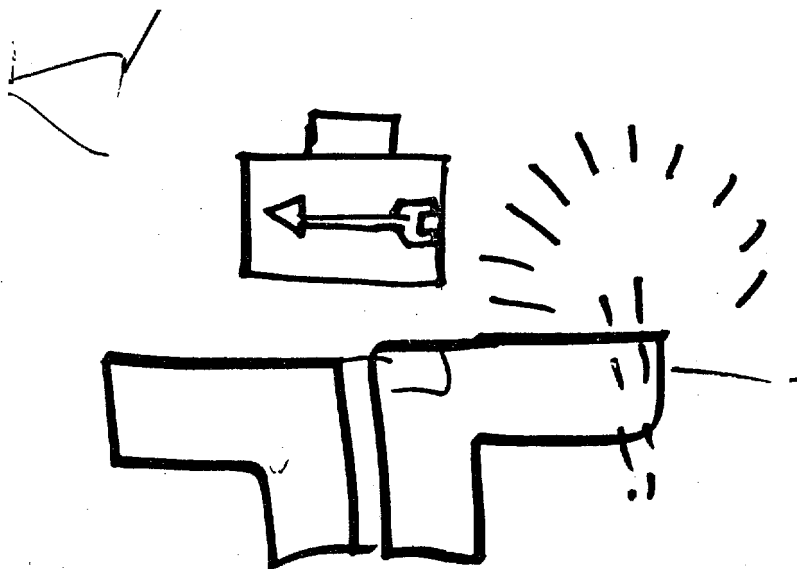

(c) RESPONSE 2

FIGURE 20 TARGET 10 (ARROW THROUGH HEART, STORED IN COMPUTER GRAPHICS PROGRAM) AND GELLER'S RESPONSES

III PROPOSED PROGRAM

A. Objective

The objective of the proposed program is to investigate and develop techniques to enhance human perception of remote stimuli. Independent measures, such as EEG correlates, will be used wherever appropriate as an aid in performance evaluation and enhancement.

B. Technical Approach

Our past year's research has yielded considerable evidence that certain individuals have developed the ability to perceive accurately distant objects and scenes. In addition, it appears that ordinary subjects (not specially selected) can also perceive remote stimuli at a level of awareness sufficient to at least provide direct physiological output as to the nature of the stimulus.

Therefore, SRI proposes to center a research program around gifted subjects who have successfully participated in our research to date, but also including unselected subjects. With these we shall endeavor to define possible limitations with regard to remote viewing. We shall be particularly attentive to the physical, physiological, and psychological parameters governing the phenomenon. We will use a variety of physiological measurements to help both subject and experimenter to measure the accuracy and reliability of the subjects' descriptions. The overall goal of such a program is to make possible the separation of signal (veridical material corresponding to a given remote location) from noise (false internal information) so as to result in an ability that can be usefully applied.

A detailed description of the "method of approach" to be used in this research has been described in Section II of this proposal. The investigation that we propose here is an extension of the work just described, which we have been pursuing for the past year. We plan to continue to employ those methods and techniques that have yielded the greatest success in this recently completed research.

C. Statement of Work

- (1) By working with gifted subjects and SRI-generated target materials, SRI will measure the accuracy of remote viewing as a function of such variables as length of viewing time, target distance, and target complexity. Based on the data accumulated, SRI will attempt to define the characteristics of the information channel in terms of bit rate, resolution, and other parameters of interest. In order to determine the limits of the remote viewing ability, both pictorial and geographic target material will be used.
- (2) In order to discriminate against the possibility of an unknown experimenter/subject leakage channel, for some experiments the client will provide geographical targets unknown to the experimenters to ensure that the subject uses only a remote viewing channel in his determination of the nature of the target.
- (3) Following a lead provided by work at another laboratory in which a subject could identify pictorial material even if the picture was only "mentally projected" onto a card in a sealed envelope, SRI will study the use of pictorial target material with a decreasing density scale from clearly visible to invisible in order to measure the accuracy of perception as a function of target density.
- (4) The EEG portion of the program will be directed toward the determination of physiological correlates of accurate remote viewing. Based on previous work, SRI will investigate in detail the possibility that the frequency shift in the alpha peak can be used as a measure to gauge the reliability of perception of a remote stimulus. This and other measures that may become available during the course of study will be made available as feedback to the subject to determine whether such information can be used to enhance discrimination between correct viewing of a remote scene and false information.
- (5) SRI will continue and expand our study with subjects whose EEG patterns show direct frequency correlations with the flicker frequency of a remote stimulus. We will determine whether such a (generally unconscious) perception channel has sufficient reliability to serve as a possible communication channel. If continuing positive results accrue, we will determine the effects of shielding and distance on the efficiency of this channel.

- (6) The effects of the introduction of persons at the remotely viewed target locations will be investigated to determine possible enhancement or degradation of signal-to-noise ratio.
- (7) In view of the exploratory nature of the program, 15 percent of the effort will be set aside to explore, with the client's cognizance, avenues of research other than those listed and that may surface during the course of the program.

SRI proposes to provide approximately 28 man-months of professional effort with appropriate support toward accomplishment of the foregoing.

D. Reporting Schedule

Brief monthly progress letters will be delivered the tenth day of each contract month, following the previous month's activity.

A final technical report will be delivered 13 months after the commencement date of the contract.

Throughout this program the investigators plan to remain in close telephonic communication with the client.

IV QUALIFICATIONS OF STANFORD RESEARCH INSTITUTE

Stanford Research Institute is an independent, nonprofit organization performing a broad spectrum of research under contract to business, industry, and government. The Institute, which was formerly affiliated with Stanford University, was founded in 1946. Its operations include the physical and life sciences, industrial and development economics, management systems, engineering systems, electronics and radio sciences, information science, urban and social systems, and various combinations of disciplines within these fields.

Stanford Research Institute has no endowment; payments by clients under research contracts and grants amount to approximately \$70 million annually and are used to cover all operating costs. Such revenue also helps the Institute maintain the excellence of its research capabilities.

SRI's facilities include more than one million square feet of office and laboratory space and incorporate the most advanced scientific equipment, including unique instrumentation developed by the staff. The bulk of these facilities and most of the research staff are located at the Institute's headquarters in Menlo Park, California. Regional office locations include Washington, D.C.; New York City; Chicago; Houston; and Los Angeles.

Of SRI's total staff of 2600, approximately one-half are in professional and technical categories. Some 400 members of the professional staff have Ph.D. or equivalent degrees; 600 others have their Master's degree.

The project leader and other research personnel who would be active in the proposed work are members of the Electronics and Bioengineering Laboratory. This group currently occupies 40,000 square feet of laboratory space, divided into many separate laboratory rooms, technicians' work areas, a machine shop, and a computer room housing a LINC-8 and related terminals and equipment. In addition, a well-equipped computation center is available.

The Electronics and Bioengineering Laboratory employs a number of technicians and engineering assistants and has available electronics material and test equipment useful in the development and testing of

the teaching machines. Especially suited to the work described in the proposal are a number of shielded rooms with various instrumentation available.

Finally, a backup team of psychologists and statisticians can be brought into the project on an internal consulting basis.

The proposed research will be conducted by SRI staff members within the Electronics and Bioengineering Laboratory under the management of its director, Mr. Earle Jones. The principal investigator will be Dr. Harold Puthoff. Mr. Russell Targ, of the Electronics and Bioengineering Laboratory and Dr. Charles Rebert, a neuro-physiologist in SRI's Life Sciences Division will be co-investigators. Professor Gerold Feinberg of Columbia University and Professor Charles Tart of the University of California may be called upon to act as consultants throughout this program.

In addition to the scientific personnel directly engaged in the research aspects of this investigation, Stanford Research Institute has established an internal technical advisory board. This board consists of several directors of SRI's operating divisions, together with our legal counsel, all under the chairmanship of the senior vice president for research. It is the function of this advisory board not only to make recommendations and approve or disapprove every new direction taken by the Institute in this research area but to monitor related ongoing projects as well.

EARLE D. JONES, DIRECTOR
ELECTRONICS AND BIOENGINEERING LABORATORY
INFORMATION SCIENCE AND ENGINEERING DIVISION

Specialized professional competence

- Analysis and design of electronic-optical systems; design of television systems; facsimile systems, including bandwidth compression; electrostatic printing

Representative research assignments at SRI (since 1956)

- Character generator for high-speed electrostatic printer
- Delay line scanning techniques
- High-density photographic recording of television information
- Bandwidth reduction study for satellite cloud photographs
- Design of bandwidth reduction system for facsimile
- Development of communication line equalization system using automatic transversal filters
- Color facsimile systems with electrostatic printing
- Design of a new frequency synthesizer

Other professional experience

- Student engineer, Boeing Company; microwave airborne radar
- Designer, Square D. Company; electrical equipment design

Academic background

- B.S. in electrical engineering (1956), Georgia Institute of Technology;
M.S. in electrical engineering (1958), Stanford University

Publications and patents

- "A Versatile Character Generator with Digital Input," 1959 IRE WESCON Conv. Rec.
- "Character Generator for Digital Computers," *Electronics* (February 1960)
- Six patents in electronic circuitry, character generators, frequency synthesizers, and electrostatic printing systems

Professional associations and honors

- Institute of Electrical and Electronics Engineers
- Optical Society of America
- Society for Motion Picture and Television Engineers
- Eta Kappa Nu
- Phi Kappa Phi
- Tau Beta Pi
- Phi Eta Sigma

HAROLD E. PUTHOFF, SENIOR RESEARCH ENGINEER
ELECTRONICS AND BIOENGINEERING LABORATORY
INFORMATION SCIENCE AND ENGINEERING DIVISION

Specialized professional competence

- Tunable laser research and development; quantum electronics; electron beam devices; biofeedback and biomeasurement research

Representative research assignments

- Development of tunable ultraviolet laser source for pollution studies and medical research
- Development of high-power tunable infrared laser source (50-250 microns) for materials research
- Assessment of potential of fiber optics and lasers for use in optical computers
- Development of biofeedback monitors (GSR) for use in educational computers and other man-machine links
- Research and development in biofield measurements

Other professional experience

- Research associate, Hansen Laboratories of Physics and lecturer, Department of Electrical Engineering, Stanford University (1967-71); teaching, textbook author, and research supervisor of Ph.D. candidates in the area of lasers and nonlinear optics
- Consultant on application of lasers to industrial and medical problems and research assistant, Stanford University (1963-67)
- Lt., USNR (1960-63); in-house research and contract monitoring on DoD (NSA) contracts concerned with the development of ultra high-speed (GHz) computers
- Research engineer, Sperry Electronic Tube Division and Sperry Fellow, University of Florida (1958-60); design and testing of electron beam focusing systems for use in microwave tubes

Academic background

- B.E.E. (1958) and M.S.E. (1960), University of Florida; Ph.D. in electrical engineering (1967), Stanford University

Publications and patents

- Coauthor of textbook, *Fundamentals of Quantum Electronics*, Wiley; 2 reference book contributions; 23 papers in professional journals; 14 national symposium papers; numerous technical reports
- 2 patents

Professional associations and honors

- Institute of Electrical and Electronics Engineers; Sigma Tau; Phi Kappa Phi; Phi Eta Sigma; Sigma Xi

PUBLICATIONS OF HAROLD E. PUTHOFF

- W. W. Peterson and H. E. Puthoff, "A Theoretical Study of Ion Plasma Oscillations," IRE Elect. Devices, Vol. ED-6, p. 372 (1959).
- H. E. Puthoff, "Crossed-Field Focusing of a Hollow Cylindrical Electron Beam," M.S. Thesis, University of Florida, Gainesville, Florida (January 1960).
- A. D. Sutherland et al., "On the Use of Periodic Electrostatic Focusing in Klystrons," presented at Int. Congress on Microwave Tubes, Munich, West Germany (June 1960). Also presented at 18th Conf. on Electron Tube Research, Seattle, Washington (June 1960).
- H. E. Puthoff, "Design of a Crossed-Field Electron Gun," presented at 18th Conf. on Electron Tube Research, Seattle, Washington (June 1960).
- H. E. Puthoff, "Scaling Matrix for the Analog Computer," NSA Tech. Jour., Vol. 7 (1962).
- J. T. Tippett and H. E. Puthoff, "The Status of Optical Logic Elements for Nanosecond Computer Systems," Proc. Pacific Computer Conf., Pasadena, California (March 1963). Also published in NSA Tech. Jour., Vol. 8 (1963).
- H. E. Puthoff, R. H. Pantell, and B. G. Huth, "Tunability of the Raman Laser," J. Appl. Phys., Vol. 37, p. 860 (1966).
- R. H. Pantell et al., "Mode Coupling in an External Raman Resonator," Appl. Phys. Letters, Vol. 9, p. 104 (1966).
- B. G. Huth et al., "Characteristics of the Stimulated Raman Effect in an external Resonator," Proc. Sixth Int. Conf. on Microwave and Optical Generation and Amplification, Cambridge, England (September 1966).
- _____, "Q Quantitative Study of the Stimulated Raman Effect Using an Off-Axis Resonator," IEEE J. Quant. Elect., Vol. QE-2, p. 763 (1966).
- R. Pantell et al., "Theoretical and Experimental Values for Two, Three, and Four Photon Absorptions," J. Chem. Phys., Vol. 46, p. 3507 (1967).
- H. E. Puthoff et al., "Near-Forward Raman Scattering in LiNbO_3 ," J. Appl. Phys., Vol. 39, p. 2144 (1968).
- H. E. Puthoff, "The Stimulated Raman Effect and Its Application as a Tunable Laser," Ph.D. Thesis, Stanford University, Stanford, California (June 1967).
- R. H. Pantell, G. Soncini, and H. E. Puthoff, "Stimulated Photon-Electron Scattering," IEEE J. Quant. Elect., Vol. QE-4, p. 903 (1968).
- J. Gelbwachs et al., "A Tunable Stimulated Raman Oscillator," Appl. Phys. Letters, Vol. 14, p. 258 (1969).

J. M. Yarborough et al., "Efficient Tunable Optical Emission from NiNbO_3 without a Resonator," Appl. Phys. Letters, Vol. 15, p. 102 (1969).

S. S. Sussman et al., "A New Source of Tunable Optical and Infrared Radiation," Proc. Polytechnic Institute of Brooklyn International Symposium of Submillimeter Waves, New York, New York (March 1960).

B. C. Johnson et al., "Power and Linewidth of Tunable Stimulated Far IR Emission in LiNbO_3 ," Appl. Phys. Letters, Vol. 18, p. 181 (1970).

E. Amzallag et al., "Stimulated Raman and Polariton Scattering in LiIO_3 ," J. Appl. Phys., Vol. 43, p. 3251 (1971).

D. L. Hecht et al., "Dye Lasers With Ultrafast Transverse Flow," IEEE J. Quant. Elect., Vol. QE-8, p. 15 (1972).

H. Puthoff and R. H. Pantell, Fundamentals of Quantum Electronics (John Wiley & Sons, Inc., New York, New York, 1969). Published in Russian by Mir Publishing House, Moscow, 1972.

PHYLLIS M. COLE, RESEARCH ANALYST
INFORMATION SCIENCE LABORATORY
INFORMATION SCIENCE AND ENGINEERING DIVISION

Specialized professional competence

- Author of mathematics textbooks; curricula developer and author of computer-assisted instruction courses

Representative research assignments at SRI

- Survey and analysis of instructional technology for ARPA
- Development of curricula for Educational Laboratory at SRI
- Organized a continuing regional seminar on computer-assisted instruction

Other professional experience

- Mathematics teacher for secondary school students, elementary school students, and teachers
- Participated in development of elementary school mathematics textbook series *Sets and Numbers*
- Writer-in-chief for computer-assisted instruction project to teach mathematics at Brentwood (elementary) School
- Project leader, curriculum author of project to teach computer programming to ghetto high school students via computer-assisted instruction
- Research associate, Institute for Mathematical Studies in the Social Science, Stanford University (1963-71)

Academic background

- B.A. in mathematics (1962), Middlebury College; M.A.T. in secondary mathematics education (1963), Harvard University

Publications

- Coauthor, junior-high school textbook series *Sets, Numbers, and Systems*; "CAI for Elementary Computer Programming: SIMPER, LOGO, and BASIC," Technical Report, Stanford University; coauthor of several SRI reports

CHARLES S. REBERT, PROJECT SUPERVISOR
NEUROPHYSIOLOGY PROGRAM
LIFE SCIENCES DIVISION

Specialized professional competence

- Physiological psychology, especially the relationships between electrophysiology and behavior; DC potentials; single and multiple units; animal behavior; electrical and chemical brain stimulation; experimental design and statistics

Representative research assignments at SRI (since 1968)

- Development of human EEG laboratory
- Development of mosquito olfaction laboratory
- Studies on DC potentials in humans, monkeys, and cats
- Spreading depression in the brain
- Olfactory-trigeminal interactions
- DC and multiple unit responses
- Electrophysiology of paranormal perception

Other professional experience

- Research assistant, Division of EEG and Neurophysiology, Department of Psychiatry, The University of Iowa
- Instructor, University of California Extension; courses included Introductory Psychology; The Electrical Activity of the Brain; Man and His Brain: A Survey

Academic background

- A.B. (1961) and M.A. (1964) in psychology, San Diego State College; Ph.D. in physiological psychology (1968), the University of Iowa

Publications

- Author of 22 scientific publications

Professional associations

- American EEG Society
- Neuroscience Society

PUBLICATIONS OF CHARLES REBERT

D. A. Irwin, J. R. Knott, D. W. McAdam, and C. S. Rebert, "Motivational Determinants of the 'Contingent Negative Variation,'" Electroenceph. Clin. Neurophysiol., Vol. 21, pp.538-543 (1966).

D. W. McAdam, D. A. Irwin, C. S. Rebert, and J. R. Knott, "Conative Control of the Contingent Negative Variation," Electroenceph. Clin. Neurophysiol., Vol. 21, pp. 154-155 (1966).

C. S. Rebert, D. W. McAdam, J. R. Knott, and D. A. Irwin, "Slow Potential Change in Human Brain Related to Level of Motivation," J. Comp. Physiol. Psychol., Vol. 63, pp. 20-23 (1967).

D. W. McAdam, J. R. Knott, and C. S. Rebert, "Cortical Slow Potential Changes in Man Related to Interstimulus Interval and to Pre-Trial Prediction of Interstimulus Interval," Psychophysiology, Vol. 5, pp. 349-358 (1969).

J. Kaplan and C. S. Rebert, "The Effect of Pressurized Air in Establishing Discriminative Response Suppression in Stump-Tailed Macaques," Behavior Research Methods and Instrumentation, Vol. 6, pp. 262-263 (1959).

C. S. Rebert, "D. C. and Multiple Unit Recording in Lateral Geniculate Body of the Cat," Proc. American Psychological Association Convention, Vol. 77, pp. 215-216 (1969).

C. S. Rebert and D. A. Irwin, "Slow Potential Changes in Cat Brain During Appetitive and Aversive Classical Conditioning of Jaw Movement," Electroenceph. Clin. Neurophysiol., Vol. 27, pp. 152-161 (1969).

D. A. Irwin and C. S. Rebert, "Slow Potential Changes in Cat Brain During Classical Appetitive Conditioning of Jaw Movement Using Two Levels of Reward," Electroenceph. Clin. Neurophysiol., Vol. 28 pp. 119-126 (1970).

C. S. Rebert, "Spreading Depression in Squirrel Monkey Lissencephalic Cortex," Physiol. and Behav., Vol. 5, pp. 239-241 (1970).

C. S. Rebert, and J. R. Knott, "The Vertex Non-Specific Evoked Potential and Latency of Contingent Negative Variation," Electroenceph. Clin. Neurophysiol., Vol. 28, pp. 561-565 (1970).

H. Stone and C. S. Rebert, "Observations on Olfactory and Trigeminal Interactions," Brain Research, Vol. 21, pp. 138-142 (1970).

C. S. Rebert, "The Effect of Reaction Time Feedback on Reaction Time and Contingent Negative Variation," Psychophysiology, Vol. 9, pp. 334-339 (1972).

C. S. Rebert, "Cortical and Subcortical Slow Potentials in the Monkey's Brain During a Preparatory Interval," Electroenceph. Clin. Neurophysiol., Vol. 33, pp. 389-402 (1972).

E. D. Davis and C. S. Rebert, "Elements of Olfactory Receptor Coding in the Yellow Fever Mosquito," J. Econ. Entomol., Vol. 65 pp. 1058-1061 (1972).

G. T. Steinmetz and C. S. Rebert, "Post-Reinforcement Changes of Steady Potentials in Premotor Cortex of Monkeys," Physiol. Behav., Vol. 9, pp. 769-772 (1973).

- C. S. Rebert and K. G. Sperry, "Subjective and Response-Related Determinants of CNV Amplitude," Psychophysiology, Vol. 10, pp. 139-144 (1973).
- C. S. Rebert, "A Technique for Simultaneous Measurement of DC and Multiple Unit Responses," Electroenceph. Clin. Neurophysiol., Vol. 34, pp. 324-326 (1973).
- C. S. Rebert and D. A. Irwin, "Simple Electrode Configuration for Chronic or Acute Recording of DC Potentials from Subcortical Nuclei of the Brain," Electroenceph. Clin. Neurophysiol., Vol. 34, pp. 440-442 (1973).
- C. S. Rebert, "Some Elements of a General Cerebral System Related to CNV Genesis," in W. C. McCallum and J. R. Knott (eds.), Event Related Slow Potentials of the Brain: Their Relation to Behavior, Amsterdam: Elsevier (1973, in press).
- C. S. Rebert and J. J. Tecce, "A Summary of CNV and Reaction Time, in W. C. McCallum and J. R. Knott (eds.), Event Related Slow Potentials of the Brain: Their Relation to Behavior, Amsterdam: Elsevier (1973, in press).
- C. S. Rebert, "Further Analysis of CNV and Reaction Time," Electroenceph. Clin. Neurophysiol., Abstract (1973, in press).
- C. S. Rebert, "Slow Potential Correlates of Neuronal Population Responses in the Cat's Lateral Geniculate Nucleus," Electroenceph. Clin. Neurophysiol., Vol. 35, pp. 511-515 (1973).
- C. S. Rebert, "Slow Potential Changes in the Monkey's Brain During Reaction Time Foreperiod," in W. C. McCallum and J. R. Knott (eds.) Third Congress on Event Related Slow Potentials (1974, in press).
- C. S. Rebert, G. T. Pryor, and J. Schaeffer, "Slow Cortical Potential Consequence of Electroconvulsive Shock in Rats," Physiol. Behav. (1974, in press).
- C. S. Rebert, R. Berry, and J. Merlo, "DC Potential Consequences of Induced Muscle Tension: Effects on Contingent Negative Variation," in W. C. McCallum and J. R. Knott (eds.) Third Congress on Event Related Slow Potentials (1974, in press).

- C. S. Rebert and K. G. Sperry, "Subjective and Response-Related Determinants of CNV Amplitude," Psychophysiology, Vol. 10, pp. 139-144 (1973).
- C. S. Rebert, "A Technique for Simultaneous Measurement of DC and Multiple Unit Responses," Electroenceph. Clin. Neurophysiol., Vol. 34, pp. 324-326 (1973).
- C. S. Rebert and D. A. Irwin, "Simple Electrode Configuration for Chronic or Acute Recording of DC Potentials from Subcortical Nuclei of the Brain," Electroenceph. Clin. Neurophysiol., Vol. 34, pp. 440-442 (1973).
- C. S. Rebert, "Some Elements of a General Cerebral System Related to CNV Genesis," in W. C. McCallum and J. R. Knott (eds.), Event Related Slow Potentials of the Brain: Their Relation to Behavior, Amsterdam: Elsevier (1973, in press).
- C. S. Rebert and J. J. Tecce, "A Summary of CNV and Reaction Time, in W. C. McCallum and J. R. Knott (eds.), Event Related Slow Potentials of the Brain: Their Relation to Behavior, Amsterdam: Elsevier (1973, in press).
- C. S. Rebert, "Further Analysis of CNV and Reaction Time," Electroenceph. Clin. Neurophysiol., Abstract (1973, in press).
- C. S. Rebert, "Slow Potential Correlates of Neuronal Population Responses in the Cat's Lateral Geniculate Nucleus," Electroenceph. Clin. Neurophysiol., Vol. 35, pp. 511-515 (1973).
- C. S. Rebert, "Slow Potential Changes in the Monkey's Brain During Reaction Time Foreperiod," in W. C. McCallum and J. R. Knott (eds.) Third Congress on Event Related Slow Potentials (1974, in press).
- C. S. Rebert, G. T. Pryor, and J. Schaeffer, "Slow Cortical Potential Consequence of Electroconvulsive Shock in Rats," Physiol. Behav. (1974, in press).
- C. S. Rebert, R. Berry, and J. Merlo, "DC Potential Consequences of Induced Muscle Tension: Effects on Contingent Negative Variation," in W. C. McCallum and J. R. Knott (eds.) Third Congress on Event Related Slow Potentials (1974, in press).

RUSSELL TARG, SENIOR RESEARCH PHYSICIST
ELECTRONICS AND BIOENGINEERING LABORATORY
INFORMATION SCIENCE AND ENGINEERING DIVISION

Specialized professional competence

- Development of new gas lasers; FM laser and supermode laser techniques; laser noise reduction; optical modulation and demodulation; experiments in new gaseous laser media; microwave diagnostic techniques; microwave generation from plasmas

Professional experience

- Sylvania Corporation (1962-72); investigation of techniques for development of new gas lasers, making use of his research with compact, self-contained multi-kilowatt CO₂ lasers
- Technical Research Group (1959-62); experiments in new gaseous laser media
- Polytechnic Institute of Brooklyn; assisted in the establishment of the Electron Beam Laboratory
- Sperry Gyroscope Company, Electron Tube Division (1956-59); experimental work in microwave generation from plasmas; early work in the technology of ultrahigh-vacuum and ion-pump design

Academic background

- B.S. in physics (1954), Queens College, New York; graduate work in physics (1954-56), Columbia University, New York

Publications and inventions

- Author of "Optical Heterodyne Detection of Microwave-Modulated Light," *Proc. IEEE* (1964); coauthor of numerous articles on lasers and plasma oscillations
- Invention of the tunable plasma oscillator at microwave frequencies

Professional associations and honors

- IEEE; American Physical Society; The Optical Society of America
- Awarded the position of research associate with the Polytechnic Institute of Brooklyn

PUBLICATIONS OF RUSSELL TARG

- R. Targ and L. P. Levine, "Backward-Wave Oscillations in a System Composed of an Electron Beam and a Hydrogen Gas Plasma," J. of Appl. Phys., Vol. 32, No. 4, pp. 731-737 (April 1961).
- M. Ettenberg and R. Targ, "Observations of Plasma and Cyclotron Oscillations," Proc. of the Symposium on Electronic Waveguides, Polytechnic Institute of Brooklyn, New York (April 8-10, 1958).
- P. Rabinowitz, S. Jacobs, R. Targ, and G. Gould, "Heterodyne Detection of Phase-Modulated Light," Proc. IRE, Vol. 50, No. 11 (November 1962).
- G. Grosz and R. Targ, "Enhancement in Mercury-Krypton and Xenon-Krypton Gaseous Discharges," Appl. Optics, Vol. 2, No. 3, pp. 299-302 (March 1963).
- R. Targ, "Optical Heterodyne Detection of Microwave-Modulated Light," Proc. IEEE (Correspondence), pp. 303-304 (March 1964).
- R. Targ, D. E. Caddes, and B. J. McMurtry, "The Traveling-Wave Phototube. Part II: Experimental Analysis," IEEE Trans. on Electron Devices, Vol. ED-11, pp. 164-170 (April 1964).
- S. E. Harris and R. Targ, "FM Oscillation of the He-Ne Laser," App. Phys. Letters, Vol. 5, No. 10, pp. 202-204 (15 November 1964).
- R. Targ, G. A. Massey, and S. E. Harris, "Laser Frequency Translation by Means of Electro-Optic Coupling Control," Proc. IEEE (correspondence), Vol. 52, No. 10, pp. 1247-1248 (October 1964).
- R. Targ and W. D. Bush, "Automatic Frequency Control of a Laser Local Oscillator for the Heterodyne Detection of Microwave-Modulated Light," Appl. Optics, Vol. 4, No. 11, pp. 1523-1527 (December 1965).
- G. A. Massey, M. K. Oshman, and R. Targ, "Generation of Single-Frequency Light Using the FM Laser," Appl. Phys. Letters, Vol. 6, No. 1, pp. 10-11 (January 1965).
- L. M. Osterink and R. Targ, "Single-Frequency Light from an Argon FM Laser," Appl. Phys. Letters, Vol. 10, No. 4, pp. 115-117 (February 1967).
- R. Targ and J. M. French, "Stabilization of a He-Ne Laser," Proc. IEEE, Vol. 55, No. 7, pp. 1185-1192 (July 1967).
- L. M. Osterink and R. Targ, "Single-Frequency Light Using the Super-Mode Technique with an Argon FM Laser," Proc. of the Symposium on Modern Optics, Polytechnic Institute of Brooklyn, New York (March 22-24, 1967).
- R. Targ and L. M. Osterink, "Frequency Stabilization and Quieting of the FM Laser," 1967 WESCON Convention Record, San Francisco, California.
- R. Targ and J. M. Yarborough, "Mode-Locked Quieting of the He-Ne and Argon Lasers," Appl. Phys. Letters, Vol. 12, No. 1, pp. 3-4 (1 January 1968).

- D. E. Caddes, L. M. Osterink, and R. Targ, "Mode-Locking of the CO₂ Laser," Appl. Phys. Letters, Vol. 12, No. 3, pp. 74-76 (1 February 1968).
- R. Targ, J. M. Yarborough, and J. M. French, "Frequency Stabilization and Noise Suppression in the Argon FM Laser," IEEE J. of Quant. Elect., Vol. QE-4, pp. 644-648 (October 1968).
- W. B. Tiffany, R. Targ, and J. D. Foster, "Kilowatt CO₂ Gas-Transport Laser," Appl. Phys. Letters, Vol. 15, No. 3 (1969).
- W. B. Tiffany, and R. Targ, "The Gas-Transport Laser--A New Class of High-Power Electro-Optic Devices," Laser Focus, pp. 48-50 (September 1969).
- R. Targ and W. B. Tiffany, "Gain and Saturation in Transverse Flowing CO₂-N₂-He Mixtures," Appl. Phys. Letters, Vol. 15, No. 9 (1 November 1969).
- S. E. Schwarz, T. A. deTemple, and R. Targ, "High Pressure Pulsed Xenon Laser," Appl. Phys. Letters, Vol. 17, No. 7 (1 October 1970).
- J. D. Taynai, R. Targ, and W. B. Tiffany, "An Investigation of Tellurium for Frequency Doubling with CO₂ Lasers," IEEE J. of Quant. Elect., Vol. QE-7 (8 August 1971).
- R. Targ and M. W. Sasnett, "High Repetition Rate Xenon Laser with Transverse Excitation," IEEE J. of Quant. Elect., Vol. QE-8, pp. 166-169 (February 1972).
- R. Targ and M. W. Sasnett, "Xenon-Helium Laser at High Pressure and High Repetition Rate," Appl. Phys. Letters, Vol. 19, No. 12 (15 December 1971).
- R. Targ, "Pulsed Nitrogen Laser at High Repetition Rate," IEEE J. of Quant. Elect., Vol. QE-8, pp. 726-728 (August 1972).
- R. Targ and D. Hurt, "Learning Clairvoyance and Precognition with an Extrasensory Perception Teaching Machine," Parapsychology Review, pp. 9-11 (July 1972).