

STA

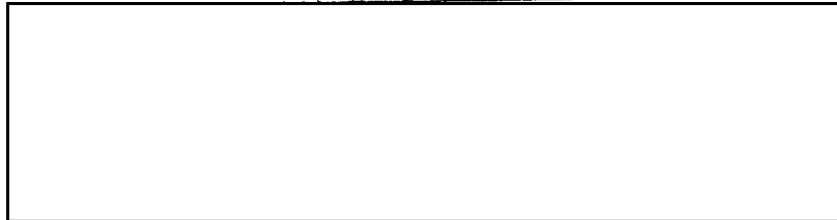

Bob

07/12/51

Since your people prefer we not use the Post Office return receipt, I would like to use the form 1856 which is a convenient form to tell me you received my report.

I also provided an envelope for your convenience. *Phil*
COMPLIMENTS OF CARLISLE STATIONERS

Declass Review by NGA.

File

998765



STAT

MAILING ADDRESS



Aug. 6, 1965

STAT

Dear Bob and John:

Since the computer analysis of the floor slab frequency in Chris' area was much lower than we expected, we would like to verify our assumptions of the floor construction. Attached is a sketch (Fig. 1b) of the floor structure and also attached are our assumptions based on verbal information received in June. I believe that confirming data can be obtained directly from architects drawings, if they are available. Most satisfactory procedure would be to send us a clean copy of the architects floor structure drawing.

Regards.

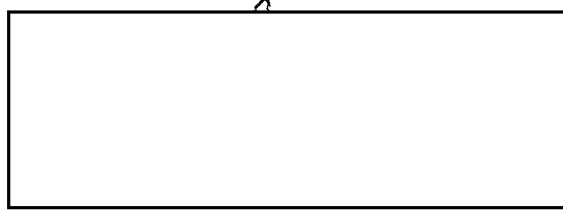

STAT

	<u>Present Assumption</u>	<u>Revised Assumption</u>
A. Concrete floor slab thickness	10 in.	
B. Column cap thickness	4 in.	
C. Column Collar Diameter	8 ft.	
D. Column Collar height, to top of floor slab	50 in.	
E. Column Diameter	2 ft.	
F. Column center to center distance	20 ft.	
G. Reinforcing bar location in concrete floor slab (distance from top of slab)	8 in.	
H. Concrete strength	2,000 psi.	
I. Design load condition	uniform 200 lbs. per sq. ft.	
J. Reinforcing Rod distribution	$\frac{1}{2}$ " Diam. Rods 6" c-c both ways.	

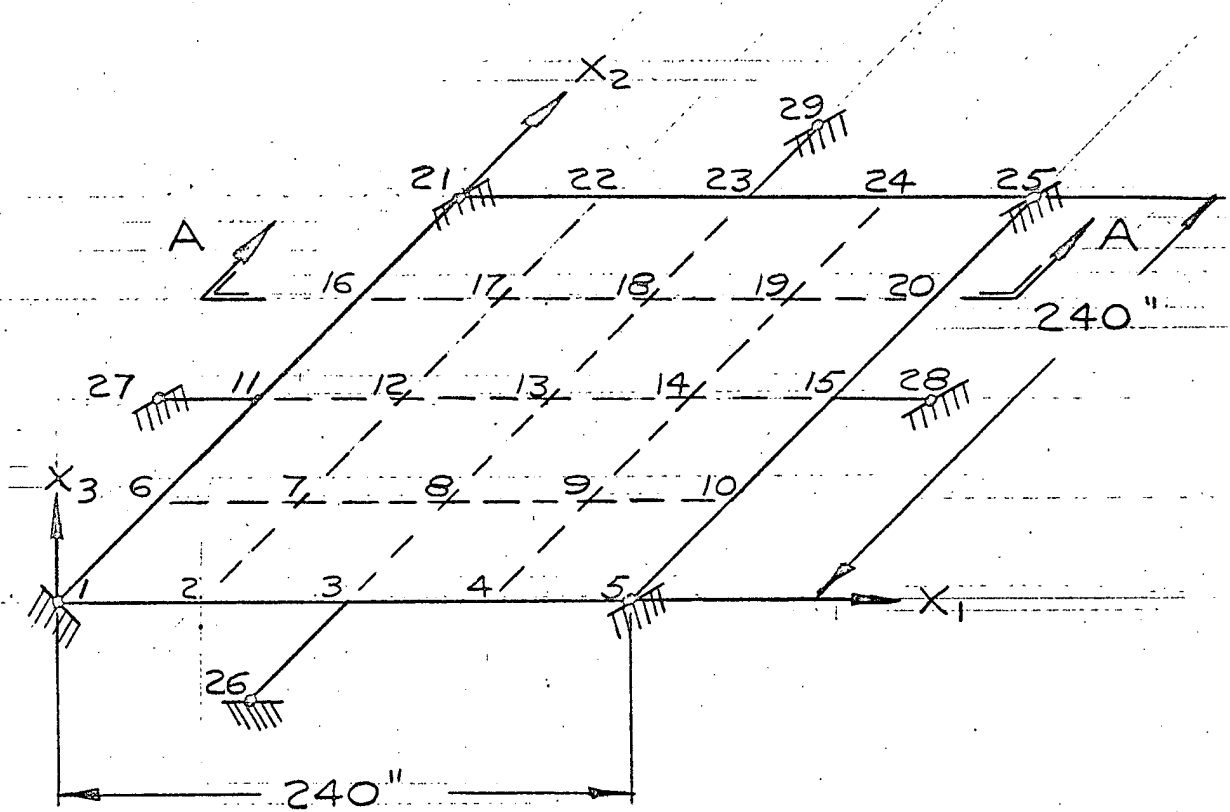

Figure 1a Floor Slab Grid Framework

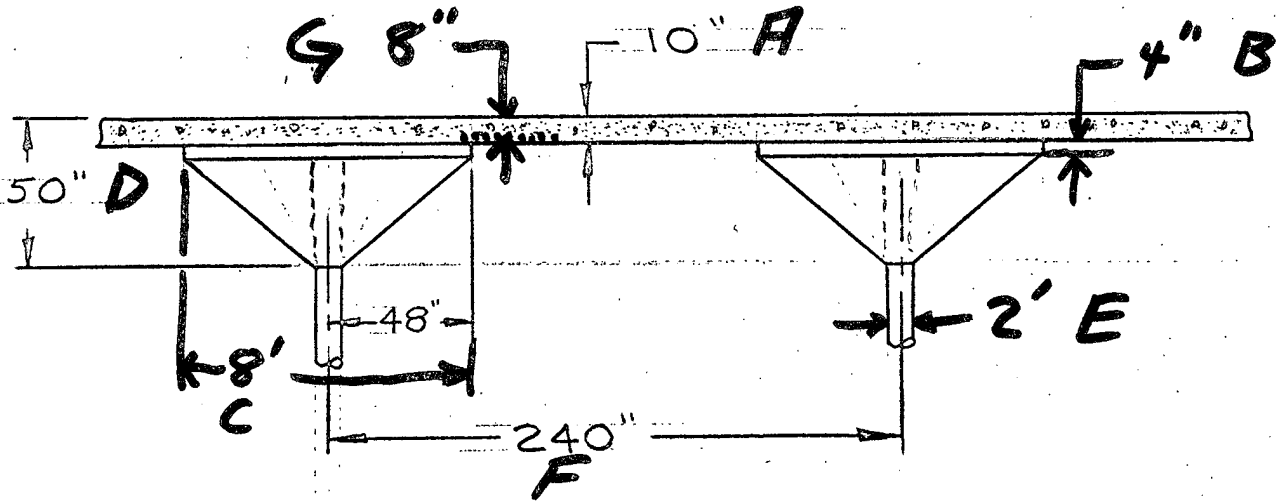
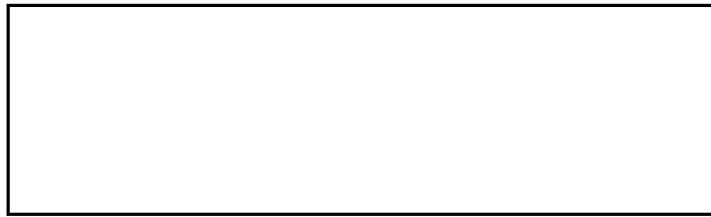

Figure 1b Section A-A of Floor Slab

998245

STAT



August 5, 1965

Dear Bob N:

Enclosed is one copy of 4th Report on
Submicron Measuring.

Three copies were separately sent to John R
and two copies to the Contracting Officer.

Regards,



STAT

998263

August 5, 1965

STAT

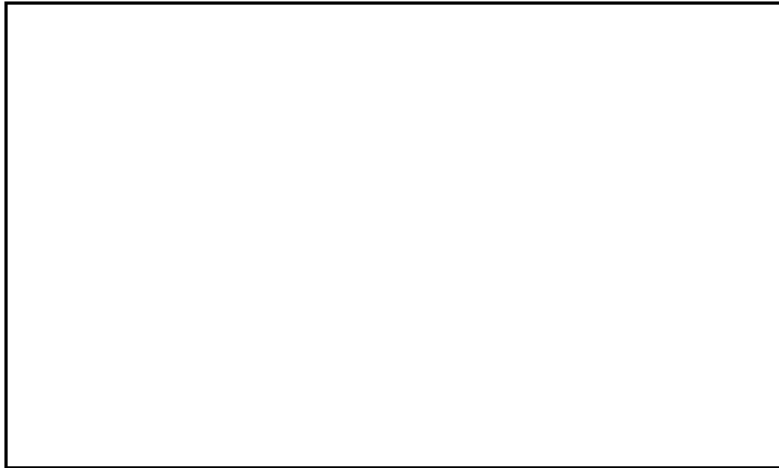

Submittal of Technical Report

Dear Sir:

Enclosed are two copies of the 4th Preliminary Technical Report on Task II, Item 1 "Submicron Measurement Error Analysis" of the subject contract. Three additional copies were submitted under separate cover on August 5, 1965, to the Technical Representative of the Contracting Officer.

Very truly yours,

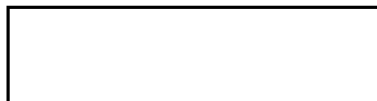

STAT

WAS:ws

Enclosures

August 5, 1965

Dear John R.

Enclosed are 3 copies of the 4th Report on Submicron Measuring.

In addition, I sent one copy to Bob N and two copies to the Contracting Officer (as required by terms of the contract).

The 4th report presents the results of the computer analysis of the floor slab frequencies. The fundamental was found to be 15.6 cps. This is an important figure and should be verified with better input data.

Regards,

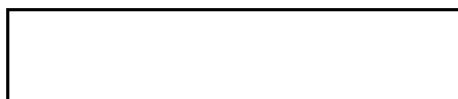

STAT

998745
STAT

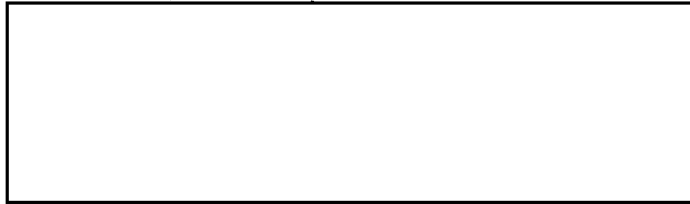

July 30, 1965

STAT



Task II, Item 1, 4th Preliminary Technical Report

Item 1. Submicron Measurement Error Analysis

WORK STATEMENT

Evaluate the physical and metallurgical properties of materials used in measuring engine construction to determine comparative suitability to submicron measuring. Materials to be considered are: Meehanite, steel, granite, aluminum, magnesium, and glass, and other materials that may be particularly suitable.

Evaluate physical properties and structural concepts appropriate to achievement of vibration levels and structural rigidity compatible with submicron measuring requirements. Evaluate methods of measuring the small vibration levels expected in a high performance structure.

Reports No. 1 and No. 2 dealt with the physical and metallurgical properties of materials. Report No. 3 dealt with structural rigidity and vibration control of the machine structure. This report, No. 4, presents results of a computer analysis of building floor vibration frequency.

Submitted by:

STAT

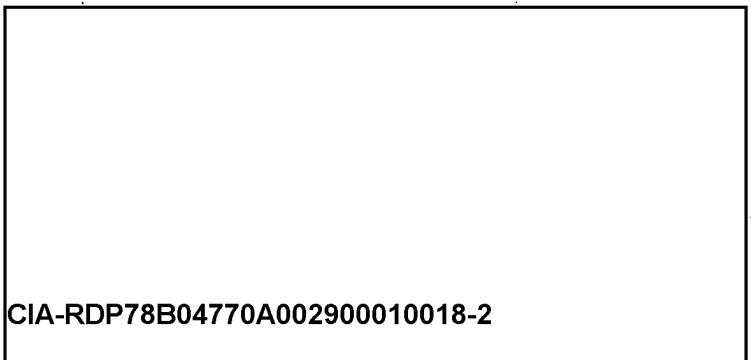

STAT



Task II, Item 1, 4th Preliminary Technical Report

CONTENTS

1. Summary
2. Structural Dynamic Model of the Floor Slab
3. Input Data
4. Output Data
5. Discussion of Results

LIST OF FIGURES AND TABLES

- | | |
|-----------|---|
| Figure 1a | Floor Slab Grid Framework |
| Figure 1b | Section A-A of Floor Slab |
| Table 1 | Tabulation of Input Data and Concrete Floor Free Vibration Analysis |
| Table 2 | Tabulation of Mode Shapes and Frequencies |

1. SUMMARY

A free vibration analysis of one typical bay of an upper story floor of a building has been made. The floor is a multiple bay slab-column structure. The purpose of the analysis was to determine the fundamental and higher mode frequencies of the floor slab. Knowledge of the floor frequencies is important to determine the interaction of floor with the vibration isolation system of a projected submicron measuring machine.

The assumed floor structural dynamic model is shown in Figure 1a and 1b. The analysis was carried out by an existing IBM 7094 routine. The result of the computation indicates the fundamental frequency is 15.6 cycles per second. If the data on the floor construction is accurate the analysis will yield a 10% accurate fundamental frequency. The fundamental frequency may therefore vary from 14 to 17 cps. The computed 15.6 cps. fundamental floor frequency is much lower than the 20 cps. to 65 cps. anticipated in report No. 3. If the floor frequency is that low, it would necessitate a machine vibration isolator system of much lower natural frequency than the 8 cps. suggested in report No. 3.

Before proceeding further on the structure evaluation, the floor frequencies will be reexamined with more accurate data on the floor construction.

2. STRUCTURAL DYNAMIC MODEL OF THE FLOOR SLAB

Figure 1a shows the grid framework of the floor slab.

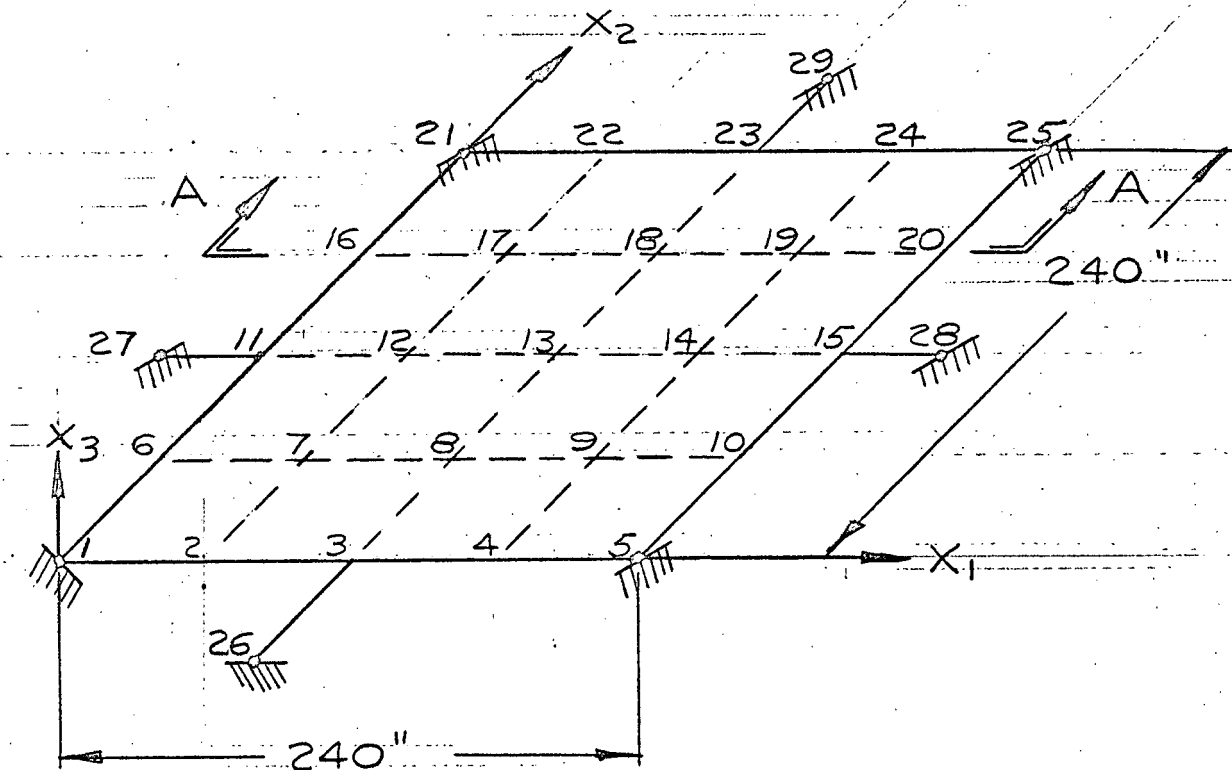

Figure 1a Floor Slab Grid Framework

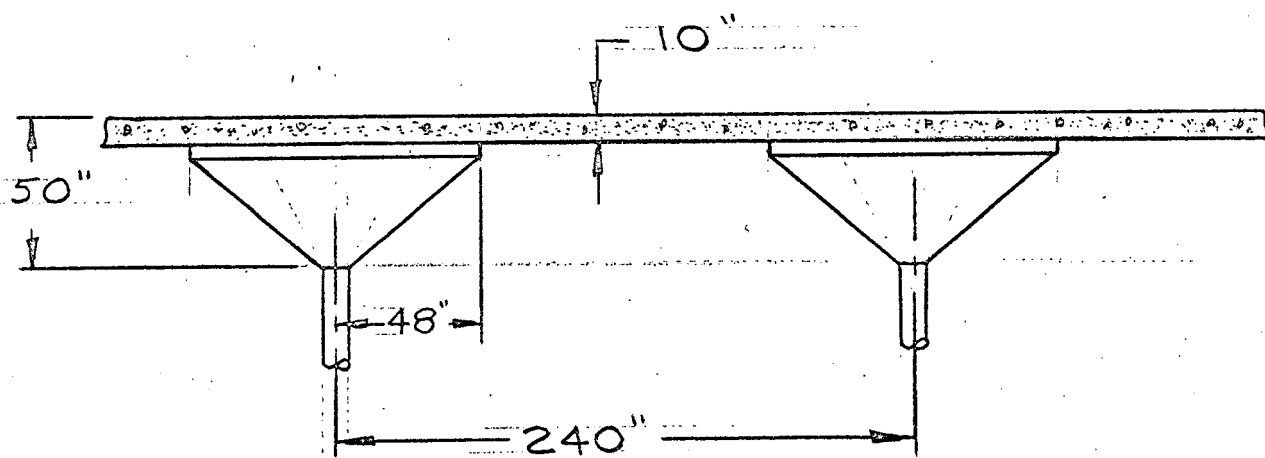

Figure 1b Section A-A of Floor Slab

Figure 1b shows a cross section of the floor slab.

The assumptions of the floor slab model are:

- (1) The effective depth of the members adjacent to the columns is 32 inches.
- (2) The effective depth (top fiber to the center of reinforcing rod) of the remaining members is 8 inches.
- (3) The concrete strength is 2000 psi which results in $E_c=2,000,000$ psi.
- (4) The distributed concrete dead weight of the slab is 125 psf.
- (5) Members 3-26, 11-27, 15-28, and 23-29 in Figure 1a are dummy members simulating the stiffness of the adjacent floor bays. Joints 1, 5, 21, 26, 27, 28, and 29 are restrained in all directions.

3. INPUT DATA

Table I lists the inputs data to the existing computer program, LESAR, for the free vibration analysis of the 20'x20' concrete floor slab. The quantities are as follows

- (1) Joint Coordinates
There are three columns, joint number, X1 and X2 coordinates in inches.
- (2) Member Properties
The first two columns indicate the ends of members. A(3) and A(4) are width and depth of members. The effective moment of inertia and torsional rigidity of each member will be computed by the input width and depth.
- (3) Restraints
Those joints that are restrained are shown.

4. OUTPUT DATA

Table II lists the modes and frequencies computed for the floor slab. Six frequencies and the corresponding mode shapes are given for this run. In the mode shape columns, there are three quantities associated with each joint. The first of these numbers is the dimensionless deflection in X3 direction. The second and third numbers are rotational modes in X1 and X2 directions. All these quantities are normalized so that the maximum is equal to unity. The modes corresponding to X3 deflection are of interest. Figure 2 shows the fundamental mode shape of the floor slab.

5. DISCUSSION OF RESULTS

The fundamental frequency of the floor slab obtained from the computer run is 15.578 cps. This floor diaphragm frequency is low and considered critical as far as the effect to the overall accuracy of the submicron measuring system is concerned.

Since the computation was based on the assumed structural dynamic floor model, the result should not be considered final. Further analysis should be performed to confirm the data.

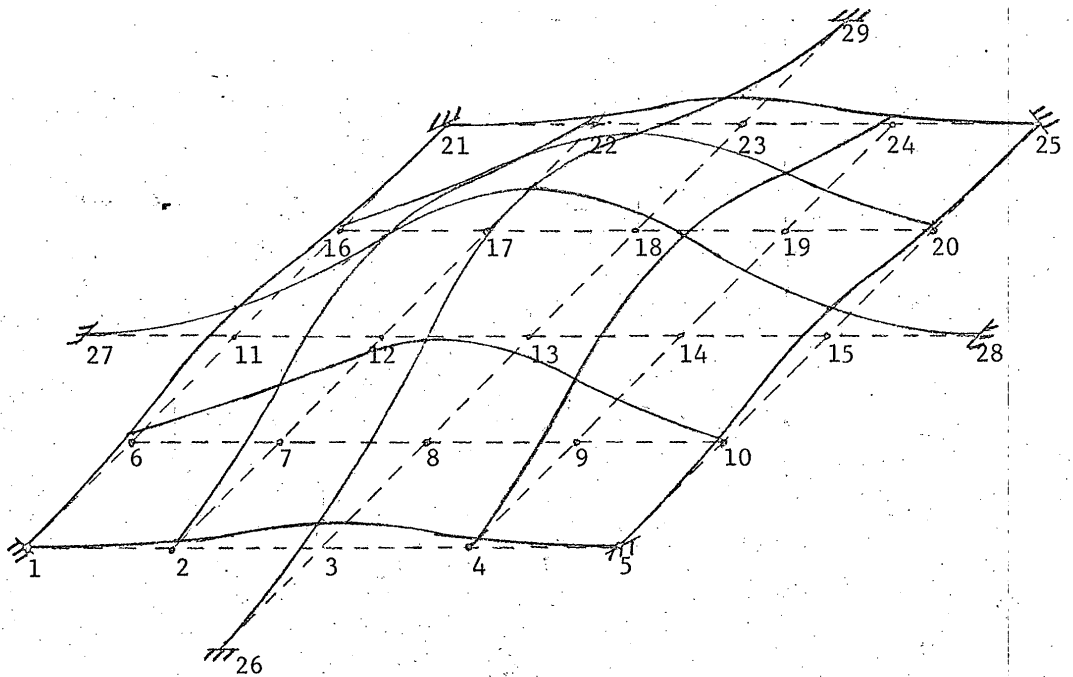

Figure 2 Fundamental Mode Shape of the 20' x 20' Concrete Floor Slab

CONCRETE FLOOR FREE VIBRATION ANALYSIS (TYPE 4 GRID STRUCTURE)
 20 FEETX20 FEET BAY, 6 MODES REQUIRED,

STAT

INPUT DATA

JOINT COORDINATES

JOINT	X(1)	X(2)	X(3)
1	0.	0.	-0.
2	60.00000	0.	-0.
3	120.00000	0.	-0.
4	180.00000	0.	-0.
5	240.00000	0.	-0.
6	0.	60.00000	-0.
7	60.00000	60.00000	-0.
8	120.00000	60.00000	-0.
9	180.00000	60.00000	-0.
10	240.00000	60.00000	-0.
11	0.	120.00000	-0.
12	60.00000	120.00000	-0.
13	120.00000	120.00000	-0.
14	180.00000	120.00000	-0.
15	240.00000	120.00000	-0.
16	0.	180.00000	-0.
17	60.00000	180.00000	-0.
18	120.00000	180.00000	-0.
19	180.00000	180.00000	-0.
20	240.00000	180.00000	-0.
21	0.	240.00000	-0.
22	60.00000	240.00000	-0.
23	120.00000	240.00000	-0.
24	180.00000	240.00000	-0.
25	240.00000	240.00000	-0.
26	120.00000	-60.00000	-0.
27	-60.00000	120.00000	-0.
28	300.00000	120.00000	-0.
29	120.00000	300.00000	-0.

MEMBER PROPERTITES

JTA	JTB	A(1)	A(2)	A(3)	A(4)
1	2	0.	-0.	30.00000	32.00000
2	3	0.	-0.	30.00000	8.00000
3	4	0.	-0.	30.00000	8.00000
4	5	0.	-0.	30.00000	32.00000
6	7	0.	-0.	60.00000	8.00000
7	8	0.	-0.	60.00000	8.00000
8	9	0.	-0.	60.00000	8.00000
9	10	0.	-0.	60.00000	8.00000
11	12	0.	-0.	60.00000	8.00000
12	13	0.	-0.	60.00000	8.00000
13	14	0.	-0.	60.00000	8.00000
14	15	0.	-0.	60.00000	8.00000
16	17	0.	-0.	60.00000	8.00000

TABLE I CONTINUE

Approved For Release 2005/06/23 : CIA-RDP78B04770A002900010018-2

17	18	0.	-0.	60.00000	8.00000
18	19	0.	-0.	60.00000	8.00000
19	20	0.	-0.	60.00000	8.00000
21	22	0.	-0.	30.00000	32.00000
22	23	0.	-0.	30.00000	8.00000
23	24	0.	-0.	30.00000	8.00000
24	25	0.	-0.	30.00000	32.00000
1	6	0.	-0.	30.00000	32.00000
6	11	0.	-0.	30.00000	8.00000
11	16	0.	-0.	30.00000	8.00000
16	21	0.	-0.	30.00000	32.00000
2	7	0.	-0.	60.00000	8.00000
7	12	0.	-0.	60.00000	8.00000
12	17	0.	-0.	60.00000	8.00000
17	22	0.	-0.	60.00000	8.00000
3	8	0.	-0.	60.00000	8.00000
8	13	0.	-0.	60.00000	8.00000
13	18	0.	-0.	60.00000	8.00000
18	23	0.	-0.	60.00000	8.00000
4	9	0.	-0.	60.00000	8.00000
9	14	0.	-0.	60.00000	8.00000
14	19	0.	-0.	60.00000	8.00000
19	24	0.	-0.	60.00000	8.00000
5	10	0.	-0.	30.00000	32.00000
10	15	0.	-0.	30.00000	8.00000
15	20	0.	-0.	30.00000	8.00000
20	25	0.	-0.	30.00000	32.00000
3	26	0.	-0.	60.00000	8.00000
11	27	0.	-0.	60.00000	8.00000
15	28	0.	-0.	60.00000	8.00000
23	29	0.	-0.	60.00000	8.00000

RESTRAINTS, 1--YES, 0--NO

JOINT	X(1)	X(2)	X(3)
1	1	1	1
5	1	1	1
21	1	1	1
25	1	1	1
26	1	1	1
27	1	1	1
28	1	1	1
29	1	1	1

TABLE II

Approved For Release 2005/06/23 : CIA-RDP78B04770A002900010018-2

FREQUENCIES (CPS)

15.578 28.702 28.702 37.182 43.583 49.409

MODE SHAPES

1	0.	0.	0.	0.	0.	0.
	0.	0.	0.	0.	0.	0.
	0.	0.	0.	0.	0.	0.
2	0.03941	0.07687	0.11934	0.12956	-0.09119	-0.08618
	0.00043	0.00031	0.00098	0.00030	-0.00025	0.00032
	-0.00111	-0.00216	-0.00322	-0.00362	0.00245	0.00245
3	0.18725	0.62561	0.62561	1.00000	-0.82252	-1.00000
	0.00539	0.01110	0.01110	0.01112	-0.00404	-0.00041
	-0.00000	-0.00347	0.00157	-0.00000	0.00000	-0.00166
4	0.03941	0.13532	0.09285	0.12956	-0.09119	-0.03125
	0.00043	0.00124	0.00056	0.00030	-0.00025	0.00099
	0.00111	0.00363	0.00256	0.00362	-0.00245	-0.00110
5	0.	0.	0.	0.	0.	0.
	0.	0.	0.	0.	0.	0.
	0.	0.	0.	0.	0.	0.
6	0.03941	-0.07332	0.07683	-0.12956	-0.09120	0.02811
	0.00111	-0.00206	0.00203	-0.00362	-0.00245	0.00074
	-0.00043	0.00028	-0.00082	0.00030	0.00025	-0.00026
7	0.39555	0.01310	0.72430	0.00000	-0.15353	0.19111
	0.00695	-0.00784	0.00451	-0.01084	0.00273	0.00380
	-0.00695	-0.00809	-0.00902	-0.01084	-0.00273	-0.00015
8	0.68551	1.00000	1.00000	0.80594	-0.04620	0.18746
	0.00823	-0.00368	-0.00368	-0.01390	0.01725	0.01195
	-0.00000	-0.01220	0.00553	-0.00000	0.00000	-0.00475
9	0.39555	0.99197	0.28076	0.00000	-0.15353	0.68977
	0.00695	0.00916	-0.00319	-0.01084	0.00273	0.00508
	0.00695	0.00937	0.00844	0.01084	0.00273	0.00135
10	0.03941	0.13334	-0.01681	-0.12956	-0.09120	0.08542
	0.00111	0.00357	-0.00052	-0.00362	-0.00245	0.00216
	0.00043	0.00123	0.00014	-0.00030	-0.00025	0.00092
11	0.18725	-0.60931	0.27608	-1.00000	-0.82259	-0.01037
	0.00000	-0.00356	-0.00356	-0.00000	0.00000	-0.00213
	-0.00539	0.01081	-0.00490	0.01112	0.00404	0.00000
12	0.68551	-0.97394	0.44130	-0.80594	-0.04618	0.00194
	0.00000	-0.01253	-0.01253	-0.00000	0.00000	-0.00654
	-0.00823	-0.00358	0.00162	-0.01390	-0.01725	-0.00012
13	1.00000	0.00000	0.00000	0.00000	1.00000	0.00000
	0.00000	-0.01986	-0.01936	-0.00000	0.00000	-0.01089
	-0.00000	-0.01934	0.00876	-0.00000	-0.00000	0.00011
14	0.68551	0.97394	-0.44130	-0.80594	-0.04618	-0.00194
	0.00000	-0.01253	-0.01253	-0.00000	0.00000	-0.01627
	0.00823	-0.00358	0.00162	0.01390	0.01725	-0.00012
15	0.18725	0.60931	-0.27608	-1.00000	-0.82259	0.01037
	0.00000	-0.00356	-0.00356	-0.00000	0.00000	-0.00553
	0.00539	0.01081	-0.00490	-0.01112	-0.00404	0.00000
16	0.03941	-0.13334	0.01681	-0.12956	-0.09119	-0.02932
	-0.00111	0.00357	-0.00052	0.00362	0.00245	0.00077
	-0.00043	0.00123	0.00014	0.00030	0.00025	0.00024
17	0.39555	-0.99197	-0.28076	-0.00000	-0.15346	-0.18198
	-0.00695	0.00916	-0.00319	0.01084	-0.00273	0.00379
	-0.00695	0.00937	0.00844	-0.01084	-0.00273	0.00006
18	0.68551	-0.97394	0.44130	-0.80594	-0.04618	0.00194
	-0.00823	-0.00368	-0.00368	0.01390	-0.01726	0.01195

Approved For Release 2005/06/23 : CIA-RDP78B04770A002900010018-2

TABLE II CONTINUE

Approved For Release 2005/06/23 : CIA-RDP78B04770A002900010018-2

	-0.00000	-0.01220	0.00553	-0.00000	-0.00000	0.00498
19	0.39555	-0.01310	-0.72430	-0.00000	-0.15346	-0.69890
	-0.00695	-0.00784	0.00451	0.01084	-0.00273	0.00509
	0.00695	-0.00809	-0.00902	0.01084	0.00273	-0.00144
20	0.03941	0.07332	-0.07683	-0.12956	-0.09119	-0.08420
	-0.00111	-0.00206	0.00203	0.00362	0.00245	0.00212
	0.00043	0.00028	-0.00082	-0.00030	-0.00025	-0.00094
21	0.	0.	0.	0.	0.	0.
	0.	0.	0.	0.	0.	0.
	0.	0.	0.	0.	0.	0.
22	0.03941	-0.13532	-0.09285	0.12956	-0.09120	0.08735
	-0.00043	0.00124	0.00056	-0.00030	0.00025	0.00030
	-0.00111	0.00363	0.00256	-0.00362	0.00245	-0.00248
23	0.18725	-0.62561	-0.62561	1.00000	-0.82265	1.00000
	-0.00539	0.01110	0.01110	-0.01112	0.00404	-0.00041
	-0.00000	-0.00347	0.00157	-0.00000	-0.00000	0.00174
24	0.03941	-0.07687	-0.11934	0.12956	-0.09120	0.03008
	-0.00043	0.00031	0.00098	-0.00030	0.00025	0.00100
	0.00111	-0.00216	-0.00322	0.00362	-0.00245	0.00107
25	0.	0.	0.	0.	0.	0.
	0.	0.	0.	0.	0.	0.
	0.	0.	0.	0.	0.	0.
26	0.	0.	0.	0.	0.	0.
	0.	0.	0.	0.	0.	0.
	0.	0.	0.	0.	0.	0.
27	0.	0.	0.	0.	0.	0.
	0.	0.	0.	0.	0.	0.
	0.	0.	0.	0.	0.	0.
28	0.	0.	0.	0.	0.	0.
	0.	0.	0.	0.	0.	0.
	0.	0.	0.	0.	0.	0.
29	0.	0.	0.	0.	0.	0.
	0.	0.	0.	0.	0.	0.
	0.	0.	0.	0.	0.	0.

Approved For Release 2005/06/23 : CIA-RDP78B04770A002900010018-2

998245

STAT

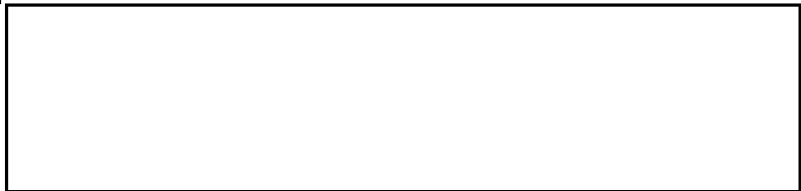

STAT



August 6, 1965

Dear Bob,

For your information and file, enclosed is a copy of a letter to Lou advising him that [redacted] has given up consulting and has taken a position in San Diego. Peter is now in process of relinquishing his financial interest in [redacted]

STAT

STAT

Regards, *P*

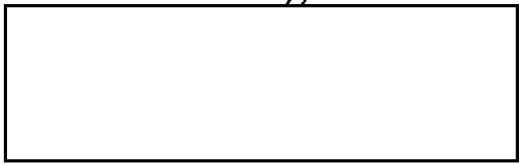

STAT

STAT



August 6, 1965

Dear Lou,

Enclosed is form 1841 advising you that
[redacted] has resigned from the company. He
has given up Consulting Engineering and taken a
position with [redacted]

[redacted]
[redacted] is presently divesting himself of his
financial interest in [redacted]

Very truly yours,

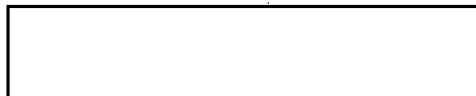

STAT

STAT
STAT

STAT

STAT

STAT