

63

April 29, 1963

DECLASS REVIEW by NIMA/DOD

Bolling Air Force Base
Washington, D. C.



Per your request, we are pleased to submit our proposal for a Digitized On Line Measuring Equipment System. Each system consists of a control panel, two each bi-directional counter and register, a synchronizer and format output control unit. The following paragraphs detail the functions and performance of these units.

STATINTL

STATINTL

DESCRIPTION OF #2825A CONTROL PANEL Dwg. No. 5000-121)

The 2825A Control Panel is designed for remote operation of the 2827A Synchronizer and two 2826A or B Bi-Directional Counters. The following controls and indicators are provided:

STATINTL

- 1.1 Display 2 sets of 7 Nixie * indicator tubes (6 numerals 0-9 and ± sign).
To receive drive power from 2826A or B Counters.
- 1.2 Preset-reset 2 sets of 7 switches to select remotely preset-reset setting of 2826A or B Counters.
- 1.3.2 Preset-reset command push-button switch for remote operation of 2826A or B Counter.
- 1.4.2 Reset to 0 command push-button switch for remote operation of 2826A or B Counter.
- 1.5.2 Counting direction selector switches for remote selection of counting direction of 2826A or B Counters.
- 2.1 16 instruction character pushbutton switches to remotely control the 2827A Synchronizer (See Para. 4.6 on Synchronizer specification).
- 2.2 5 readout pushbutton switches to remotely control the 2827A Synchronizer (See Para. 4.7 on Synchronizer specification).

* trademark

STATINTL

212/63

STATINTL



Page 2

April 29, 1963

STATINTL

DESCRIPTION OF 2825A CONTROL PANEL (Continued)

- 2.3 Ten 11 position rotary switches to generate remotely special characters in the 2827A Synchronizer (See Para. 4.9 of Synchronizer specification).
- 2.4 1 transmission indicator light, powered by the 2827A Synchronizer.

STATINTL

STATINTL

DESCRIPTION OF #2826A BI-DIRECTIONAL COUNTER

Dwg. No. 5000-119)

The 2826A Bi-Directional Counter is a 6 digit, bi-directional totalizer which will register the algebraic sum of the number of input pulses fed into the inputs A and B.

- Input requirements, Channel A and B:
Pulse, 5μsec wide, +1V peak amplitude in reference to 0 volts, rise time 1μsec or less.
- Maximum Counting Rate: 100KC May be expanded to 1MC (Option).
- Minimum spacing between pulses on either channel: 10μsec.
- Preset-reset capability: From 000,000 through 999,999 by remote selection, BCD 1-2-4-8 coded switches necessary. Preset voltage supply from counter. Preset command is remote by contact closure.
- Reset capability: To 000,000, by remote contact closure.
- Output specifications: BCD 1-2-4-8. Logic 1 = -8V±2V; Logic 0 = -.5V or less over 6.8K series resistor. BCD output is from built-in register.
- Storage capability: The counter has a register which will follow the counting decades until a keying command is issued. Upon this command the information contained in the register is being held until removal of the keying command. The keying command is a level change from -6V - -12V to -.5V - +6.0 Volts. The register store BCD coded information, not the 10 line-output to drive the remote readout.
- Readout: Remote, 10-line output to drive standard Nixie* tube.
- Counting direction: Normal or reversed by external contact closure.

STATINTL

* trademark

STATINTL

[]

Page 3

April 29, 1963

STATINTL
STATINTL

DESCRIPTION OF [] 2826B BI-DIRECTIONAL COUNTER

[] #2826B Bi-Directional Counter has the identical specifications, except for the input specifications.

- 2826B Input requirements: 2 sine - or square waves, 90° out of phase min. amplitude: 90mV Peak-to-Peak.
- Input impedance: 5K ohms shunted by 30pf.
- Power requirements: 115VAC ±10%, 50/60cps, 60 watts.
- Dimensions: Approximately 19" x 5 1/4" x 12 1/2" (without connectors)
Rack mount, all connectors on rear panel.
- Weight: Approximately 35 lbs. net.

STATINTL
STATINTL
STATINTL

DESCRIPTION OF [] #2827A SYNCHRONIZER & FORMAT OUTPUT CONTROL
[] Dwg. No. 5000-120)

General:

The [] #2827A Synchronizer and Format Output Control accepts up to 42 digits or characters in BCD coded form and converts these into serial form.

- 1.1 Speed: 1200 letters per second ±.001%.
- 1.2 Input requirements: Up to 42 1-2-4-8 coded parallel inputs. Logic 1 equals -4.5 to -12 volts, logic 0 equals -.5 volts or less into 3.9K load.
- 1.3 Receive data lead (RDL): +8 ±2V for space, -8 ±2 for mark into 4.7K load.
- 1.4 Clear to send (CTS) signal: -8V ±2 for Off, +8 ±2V for On into 4.7K load.
- 1.5 Interlock to transmission equipment: 0V for Off, +8 ±2 for On into 4.7K load.
- 1.6 Send Data Lead (SDL): +10 ±2V for space, -10 ±2 V for mark @ 2mA each.
- 1.7 Request to Send (RTS) signal: -8V ±2V for Off or Hold; +8 ±2V for On or Transmission.

STATINTL

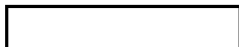

Page 4

April 29, 1963

STATINTL DESCRIPTION OF  #2827A SYNCHRONIZER & FORMAT OUTPUT CONTROL
(Continued)

- 2.1 In addition to the information bits to be transmitted, two pulsing bits are generated for each character. A start pulse is a space or (0) and is the same duration of the other bits. A stop pulse is a mark or (1) and is a minimum of 1.5 bits in length but may be longer.
- 3.1 CODE: The code generated will meet the following requirements:
- 3.2 Code to be used is Field Data Code, consisting of a 6-bit character plus one parity bit. Parity is odd.
- 3.3 The 2^o or least significant information bit is the first bit to be transmitted from each character.
- 3.4 Parity is to be the 2⁶ bit and is the last information bit of each character.
- 4.1 MESSAGE GENERATED: The message generated by the Synchronizer consists of:
 - 4.2 Digital coordinate values for each axis of the system. This shall normally consist of six decades plus sign per axis.
 - 4.3 A start of message character (SOM).
 - 4.4 An end of transmission character (EOT). (This bit configuration would normally be a parity error).
 - 4.5 A message parity count (MPC). This is the sum of bits of all characters transmitted (including SOM and EOT), and is non carry add. Lateral parity is odd. Longitudinal parity is even. The parity bit is to be the sum of the longitudinal bits.
 - 4.6 Four special instruction characters, each generated by four operator controlled push on, push off back lit switches, two dummy bits (mark or 1), and a parity bit generated by the equipment based on the condition of the four switches. The fixed dummy bits occupy the 2⁴ and 2⁵ bit positions.
 - 4.7 A special readout character generated by five momentary contact push button switches and two fixed dummy bits occupying the 2⁵ and 2⁶ bit positions. The dummy bits are spaces or 0's. It is understood that the parity (2⁶) is to be fixed at 0 so that if two of the five switches are pressed at the same time, a parity error will be detected. The five switches are understood as readout switches and also control the request to send, SOM and text as later described.

STATINTL

[Redacted]

Page 5

April 29, 1963

STATINTL

DESCRIPTION OF [Redacted] # 2827A SYNCHRONIZER & FORMAT OUTPUT CONTROL
(Continued)

- 4.8 Three rotary switches are provided for machine identification purposes. These switches are to have the capability to create 0 to 9 and are placed at the rear panel of the synchronizer so that only the maintenance engineers have the capability to change them.
- 4.9 10 special characters, generated by remote switch setting. These switches have the capability of producing 0 to 9, minus (-).
- 5.1 SPECIAL CIRCUITS: There is to be no character by character acknowledge signal received by the digitizer output circuit. However, there is to be a message acknowledge or error signal received on the basis of the total message transmitted. The reply consists of SOM, A or E, EOT, and MPC. In addition, a timer is incorporated in the equipment to trigger an alarm if the reply is not received in a time of 3 seconds to be specified by the customer. The output is to be held in the digitizer buffer until an acknowledge is received or the timer alarm is triggered. If an error signal is received due to a bad transmission, the timer is reset and another attempt at transmission is made. If, after a set number of attempts of retransmission (under computer control), an acknowledge or error signal is not returned, the timer will time out. If a read-out is initiated but no acknowledge or error signal is received, the timer will also time out, warning the operator that the transmission is not taking place.

In addition, an indicator light is to be placed on the control panel in close proximity to the readout switches. On depressing any one of the five readout switches the light is to turn on and remain on for approximately one second or until an acknowledge signal is received, whichever is longer, This will indicate to the operator that a readout has been initiated within the digitizer.

STATINTL

STATINTL

The price for the Model 2825A Control Panel is [Redacted]

The price for the Model 2826A Bi-Directional Counter (2 required) is [Redacted]

The price for the Model 2826B Bi-Directional Counter (2 required) is [Redacted]

The price for the Model 2827A Synchronizer is [Redacted]

STATINTL

STATINTL

[Redacted]

Page 6

April 29, 1963

STATINTL

All prices are FOB [Redacted] Delivery of the first system is 120 days after receipt of order. The second system, 130 days after receipt of order. Terms are net 30 days.

If further information and/or comment is desired, please do not hesitate to contact us.

Very truly yours,

STATINTL

[Redacted Signature]

Regional Sales Manager

MGS:bg
Enclosures

Tues April 30, 1963

Digital Counter for Measuring Machines. (proposal)

STATINTL



As of Tues. April 30, 1963

STATINTL

 did not get his proposal finished Friday, it went out Monday. He went into quite a bit of detail on the specifications of each unit involved.

A complete counter consists of the following:

For an  measuring machines:

- 1 ea Control Panel, Model 2825 A
- 2 ea Counter , Model 2826 A
- 1 ea Synchronizer, Model 2827 A

For an  measuring machine:

- 1 ea Control Panel, Model 2825 A
- 2 ea Counter , Model 2826 B
- 1 ea Synchronizer , Model 2827 A

A Z-axis count can be added by adding a counter (a variation of the model 2826) and a set of 6-digit nixies on the control panel or adjacent to it.

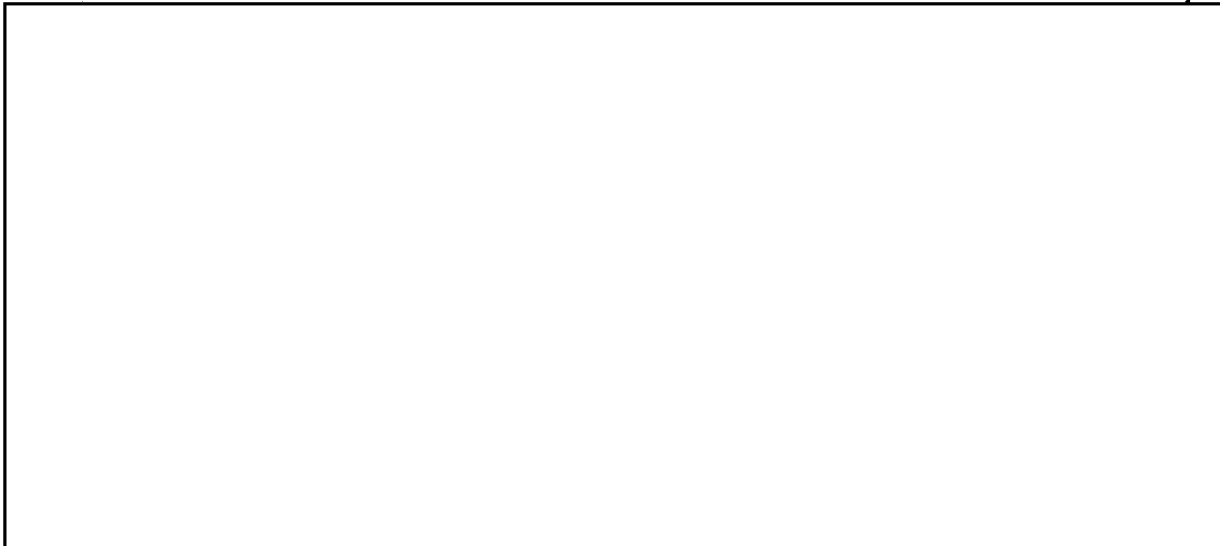

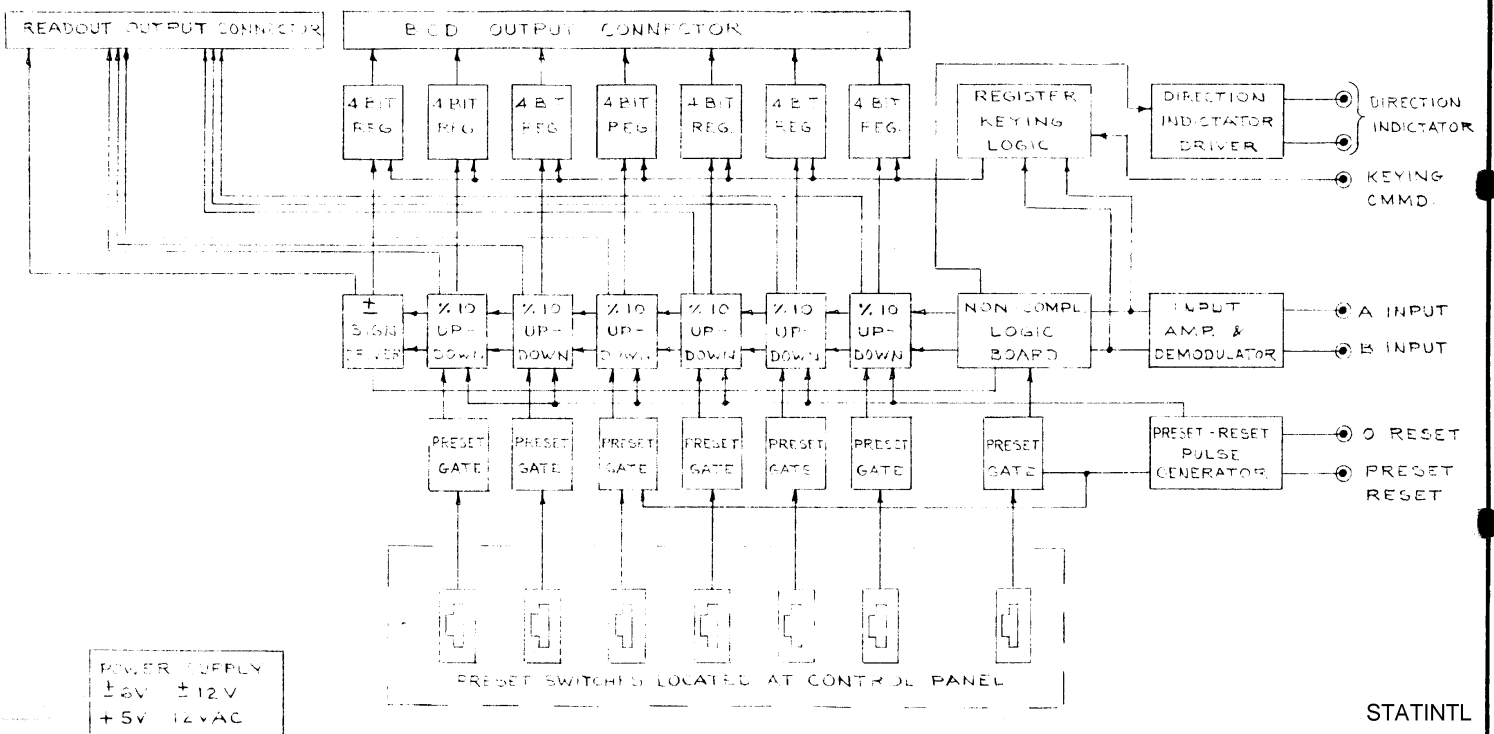

POWER SUPPLY
 +6V ±12V
 +5V ±2VAC

STATINTL

| | | | | |
|-----------------------------------------------------------------------------------------------------------|------------------|-----------------|------------------------------------------------------|---------------------|
| DIMENSIONS IN INCHES UNLESS OTHERWISE SPECIFIED ALL DIMENSIONS ARE TO CENTER UNLESS NOTED OTHERWISE | DRAWN A. L. | DATE 4-19-57 | PROJECT BOLLING FIELD PROPOSAL UP-DOWN COUNTER | SHEET NO. 1 OF 2 |
| MATERIALS NONE | CHECKED A. L. | DATE 4-19-57 | APPROVED [Signature] | [Signature] |

Approved For Release 2002/11/01 : CIA-RDP78B04747A001800110036-2

ILLEGIB

Approved For Release 2002/11/01 : CIA-RDP78B04747A001800110036-2

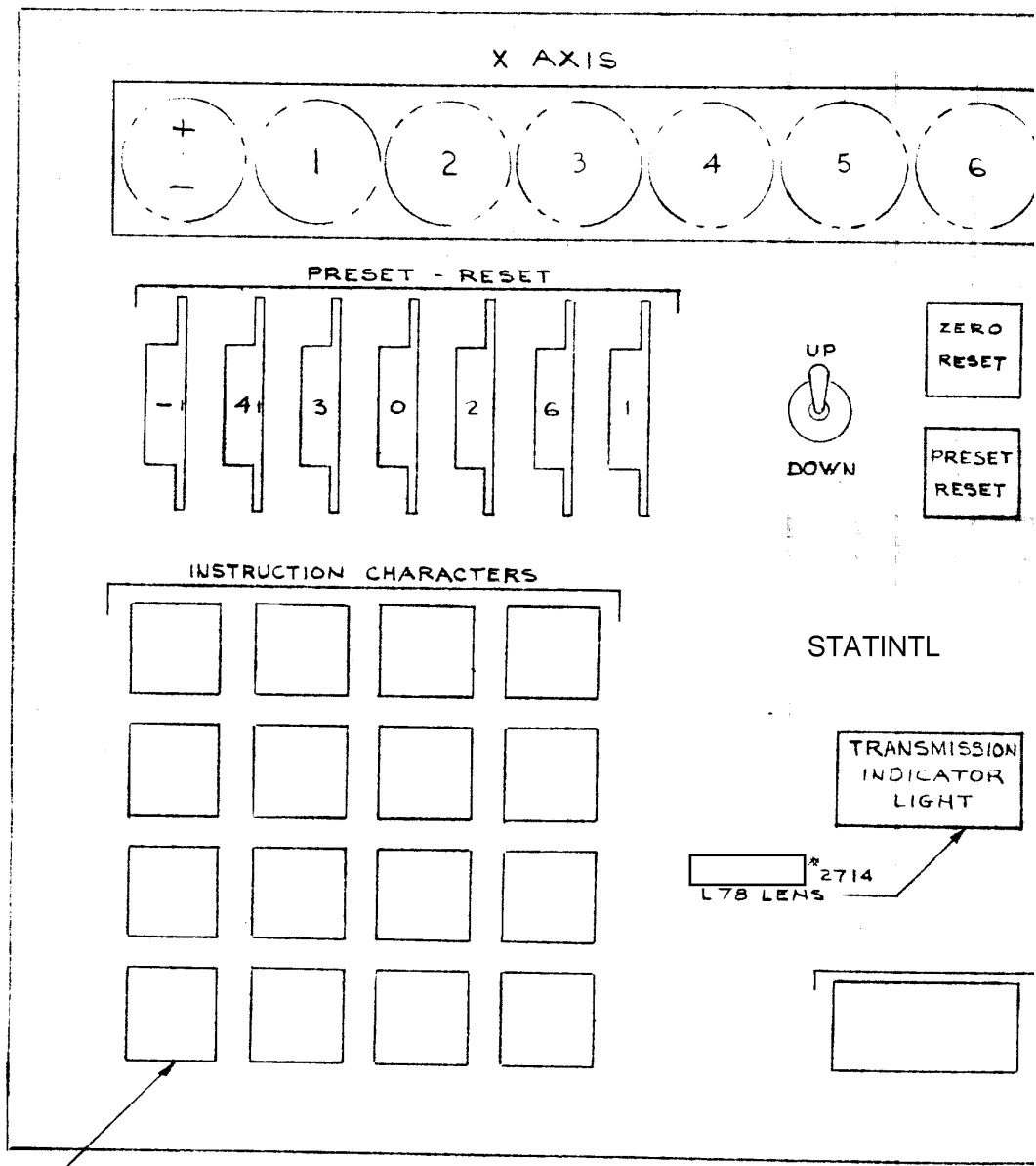

STATINTL

*1226
L 51 LENS

*2714
L78 LENS

| REV. LOT NO. | DATE | ECO. NO. | DESCRIPTION | CHECKED | APPROVED |
|--------------|---------|----------|------------------|---------|----------|
| A | 4-25-63 | | PROPOSAL CHANGES | | |

Y AXIS

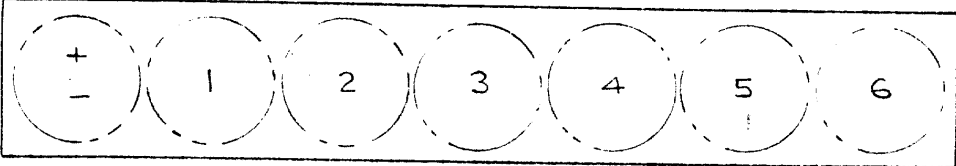

PRESET - RESET

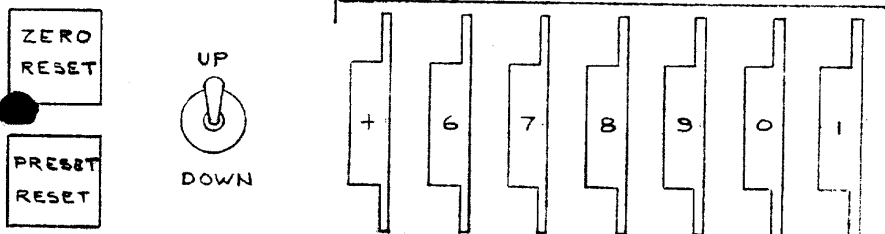

SPECIAL CHARACTERS

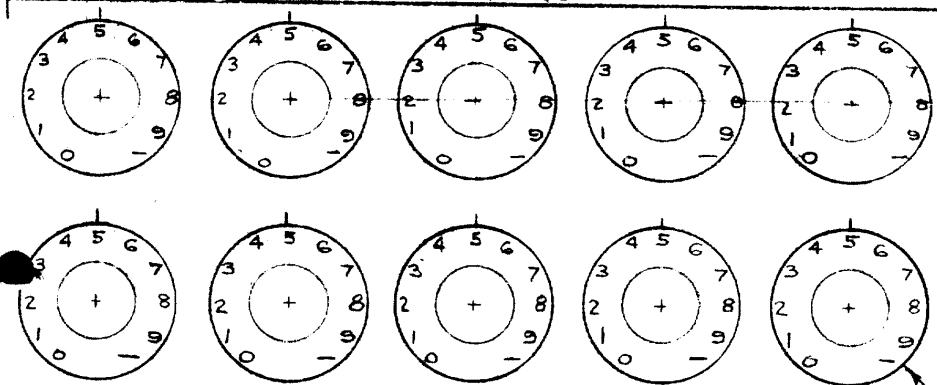

READOUT CHARACTERS

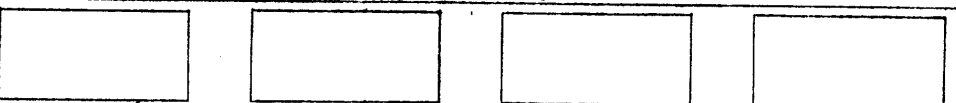

PA-024
CENTRALAS
OR EQUIV.

STATINTL

* 1023
L78 LENS

STATINTL

| | | | | | |
|--------------------------------------------------------------------------------------------------|---------------|-----------------|--------------------------------------------------|---------|------------|
| DIMENSIONS IN INCHES TOLERANCES UNLESS SPECIFIED .XX ± .03 .XXX ± .015 ANGULAR ± .0° | DRAWN A.L. | DATE 4/23/63 | TITLE BOLLING FIELD PROPOSAL CONTROL PANEL | | |
| | CHECKED | DATE | | | |
| MATERIAL | APPROVED J | DATE | SCALE | JOB NO. | NEXT ASSY. |
| Approved For Release 2002/11/01 : CIA-RDP78B04747A001800110036-2 | | | | | |

SECRET
(When Filled In)

TECHNICAL BACKGROUND PROCUREMENT INFORMATION

I. Contractor

A. Name and address: _____ 25X1A

_____ 25X1A

B. Evaluation of previous performance: No previous record

II. Brief description of this procurement: Development of a digital readout of

comparator information for on line use with a Univac 490

Estimated total amt. _____ 25X1A

A. Deliverable items: Two each electronic counters.

B. Is this procurement for other than a standard, "off the shelf" or slightly modified commercial item? YES If "yes", is it anticipated that any more of this unit will be procured? YES If so, a complete set of directly reproducible manufacturing drawings and specifications would normally be included in this procurement. Comments: _____

C. Will contract cover a period of more than 90 days? YES
If "yes", are progress reports desired? NO If so, indicate frequency, content and number of copies desired: _____

Delivery should be completed within 120 days.

D. Is any Government-owned property to be provided to the contractor?
NO If so, list and indicate its availability (where, when, etc.) _____

SECRET
(When Filled In)

SECRET
(When Filled In)

E. Is any special tooling involved? NO

F. Security:

1. Association with the Sponsor is Secret

2. The specifications and/or drawings are Unclassified

3. The item is Unclassified

4. Contractor personnel known to be aware of this proposed procurement:

25X1A

[Redacted box]

5. Other security information Preliminary plant inspection

Completed by security

III. Reasons for selection of this source. If other sources were considered, indicate results. If no other sources were considered, list the reasons why this firm is considered to be uniquely qualified to perform this work.

25X1A

25X1A

25X1A

Proposals solicited from [Redacted]

[Redacted] did not reply and the [Redacted] unpriced proposal was not considered technically acceptable. In addition, it is felt that [Redacted] has the best plant facility and production capability at the lowest unit cost.

25X1A
25X1A

25X1A

IV. Technical contact [Redacted]
Name Telephone

In the event additional space is required, use the reverse side(s) of this form, with a reference to the item number to which the comment applies.

SECRET
(When Filled In)