

SECRET

8 Feb 1956

TIME SCHEDULE FOR

25X1

- | | | |
|---------------------------|--|------|
| 23 Jan-13 Feb
3 weeks | Design transistorized audio amplifier to feed MINIFON. | X |
| 13 Feb-27 Feb
2 weeks | Design matching section from Microstrip horn to crystal. | |
| 27 Feb-5 Mar
1 week | Out for crystal conference. | |
| 5 Mar-26 Mar
3 weeks | Cold test amplifiers and compensate for temperature range. | |
| 26 Mar-9 Apr
2 weeks | Cold test batteries and design power pack. △ | |
| 9 Apr-30 Apr
3 weeks | RF test antenna and detector unit to obtain optimum sensitivity and sensitivity calibration over the frequency range required. | X |
| 30 Apr-7 May
1 week | Design external switch. △ | |
| 7 May-14 May
1 week | △ | 25X1 |
| 14 May-23 May
2 weeks | Pot amplifiers and make final adjustments on demand system. | |
| 23 May-11 June
2 weeks | Complete assembly of final model. | |
| 11 June-13 June
1 week | Final test. | |

Present estimated delivery dates for components of the project are as follows:

- | | |
|--------------------------------|------------------|
| Hewlett Packard test equipment | 1 April (approx) |
| Haydon timing motor | 1 Mar |
| Miniature relay | 27 Mar |

~~SECRET~~

DOC <u>B</u>	REV DATE <u>2-12-80</u>	BY <u>008632</u>
ORIG COMP _____	ORIG _____	TYPE _____
ORIG CLASS <u>5</u>	PAGE _____	REV LISTS <u>C</u>
JUST <u>22</u>	NEXT REV <u>2018</u>	AUTH: NR 70-2

Antenna

16 Mar 56

ACS

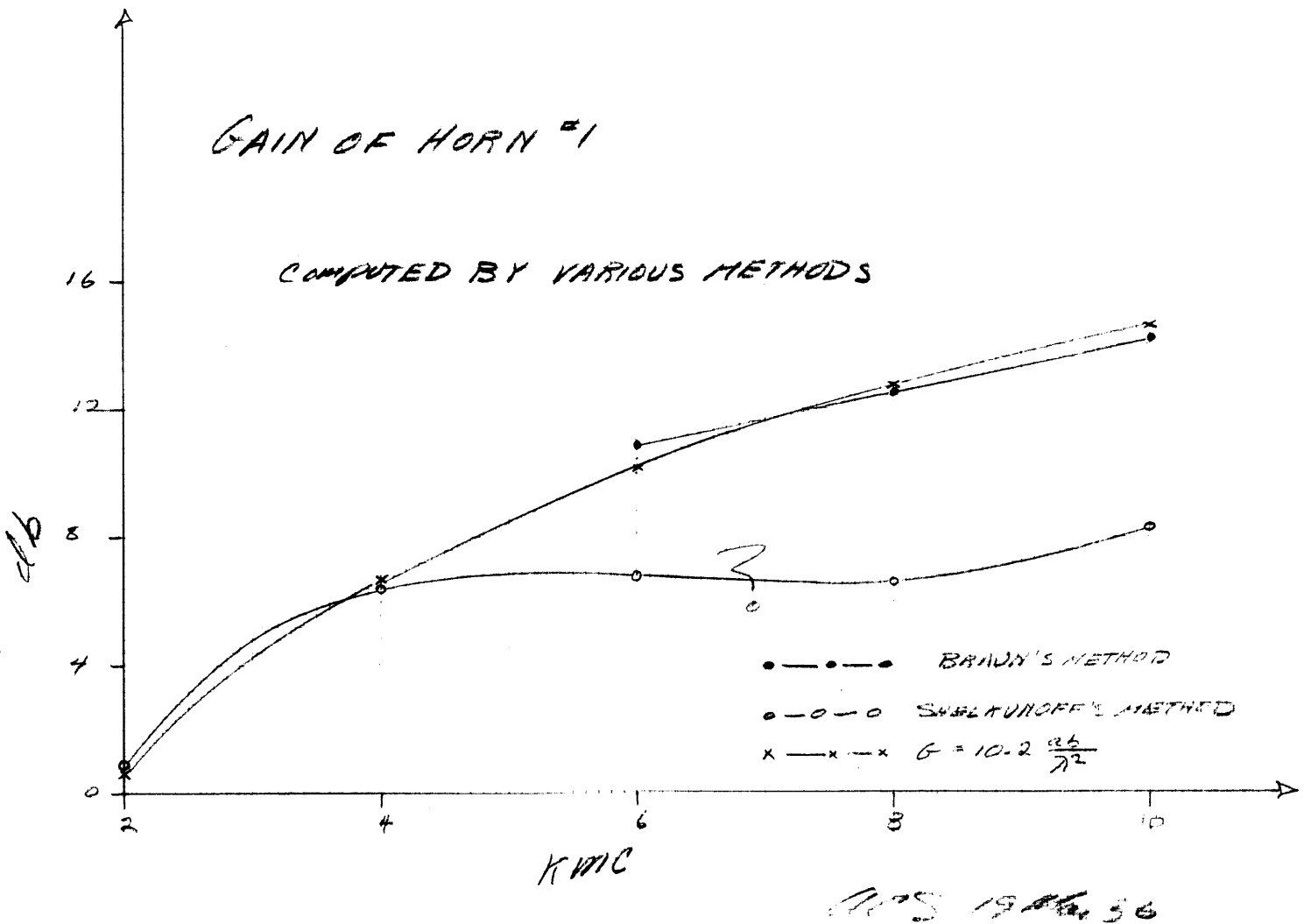

005

100 56

GAIN

The gain of the antenna can be calculated from the formulas and/or nomographs on pp. 586-589 in Silveis, Microwave Antenna Theory & Design which is volume 12 of the Rad. Lab series.

Using his notation:

$$a = 4" \quad l_a = 5.47"$$

$$b = 1" \quad l_b = 6.875"$$

thus:

freq. (mc)	λ (ins)	a/λ	b/λ	$R_{a/\lambda}$	$R_{b/\lambda}$
2	5.9	.68	.17	.93	1.16
4	2.95	1.35	.34	1.85	2.33
6	1.97	2.03	.51	2.78	3.49
8	1.47	2.72	.68	3.72	4.68
10	1.18	3.39	.85	4.63	5.82

$$G_E = \frac{64 a l_0}{\pi \lambda b} \left[C^2 \left(\frac{b}{\sqrt{2 \lambda l_0}} \right) + S^2 \left(\frac{b}{\sqrt{2 \lambda l_0}} \right) \right]$$

where C and S are the Fresnel integrals which are tabulated in Tables of Functions by Jahnke and Emde, P. 34.

thus

freq. (KMC)	$\frac{b}{\sqrt{2 \lambda l_0}}$	C	S	C^2	S^2	$C^2 + S^2$	G_E
2	.115	.115	0	.0132	-	.0132	1.25
4	.1575	.157	0	.0246	-	.0246	4.67
6	.193	.193	.003	.0372	-	.0372	10.62
8	.219	.219	.005	.0479	-	.0479	18.28
10	.249	.249	.01	.062	.0001	.062	29.4

$$\frac{64 a}{\pi} \frac{q}{b} = 81.5$$

$$G_H = \frac{4\pi b l a}{\lambda a} \left\{ [C(u) - C(v)]^2 + [S(u) - S(v)]^2 \right\}$$

$$\text{where } u = \frac{1}{\sqrt{2}} \left[\frac{\sqrt{\lambda l a}}{a} + \frac{a}{\sqrt{\lambda l a}} \right]$$

$$v = \frac{1}{\sqrt{2}} \left[\frac{\sqrt{\lambda l a}}{a} - \frac{a}{\sqrt{\lambda l a}} \right]$$

freq. (Kmc)	$\frac{\sqrt{\lambda l a}}{a}$	$\frac{a}{\sqrt{\lambda l a}}$	u	v	C(u)	C(v)
2	1.42	.705	1.5	.505	.45	.50
4	1.005	.995	1.42	.007	.525	.007
6	.822	1.22	1.44	-.281	.505	.281
8	.710	1.41	1.5	-.495	.45	.49
10	.635	1.575	1.56	-.665	.40	.635

cont on next page

④

cont.

freq. (Kmc)	S(u)	S(v)	$[C(u) - C(v)]^2$	$[S(u) - S(v)]^2$
2	.696	.068	.0025	.395
4	.715	0	.268	.511
6	.712	.011	.056	.492
8	.696	.061	.0016	.403
10	.665	.15	.053	.423
<hr/>				
	$[C(u) - C(v)]^2 + [S(u) - S(v)]^2$	$\frac{4\pi^2 b}{a} \frac{L_0}{\lambda}$	GH	
2	.397	2.92	1.16	
4	.779	5.8	4.52	
6	.548	8.73	4.79	
8	.405	11.7	4.75	
10	.476	14.5	6.9	

$$\frac{4\pi^2 b}{a} = \pi$$

⑤

$$\text{then } G = \frac{\pi}{32} \left(\frac{\lambda}{b} G_H \right) \left(\frac{\lambda}{a} G_E \right)$$

freq Kmc	$G_H \cdot G_E$	$\left(\frac{\pi}{32} \frac{G_H G_E}{ab} \right)$	G	$10 \log_{10} G$
2	1.45	.0356	1.24	.92
4	21.1	.515	4.48	6.4
6	50.9	1.25	4.85	6.85
8	86.8	2.12	4.58	6.6
10	202.3	1.95	6.9	8.38

$$\frac{\pi}{32 ab} = \frac{\pi}{128} = .0245$$

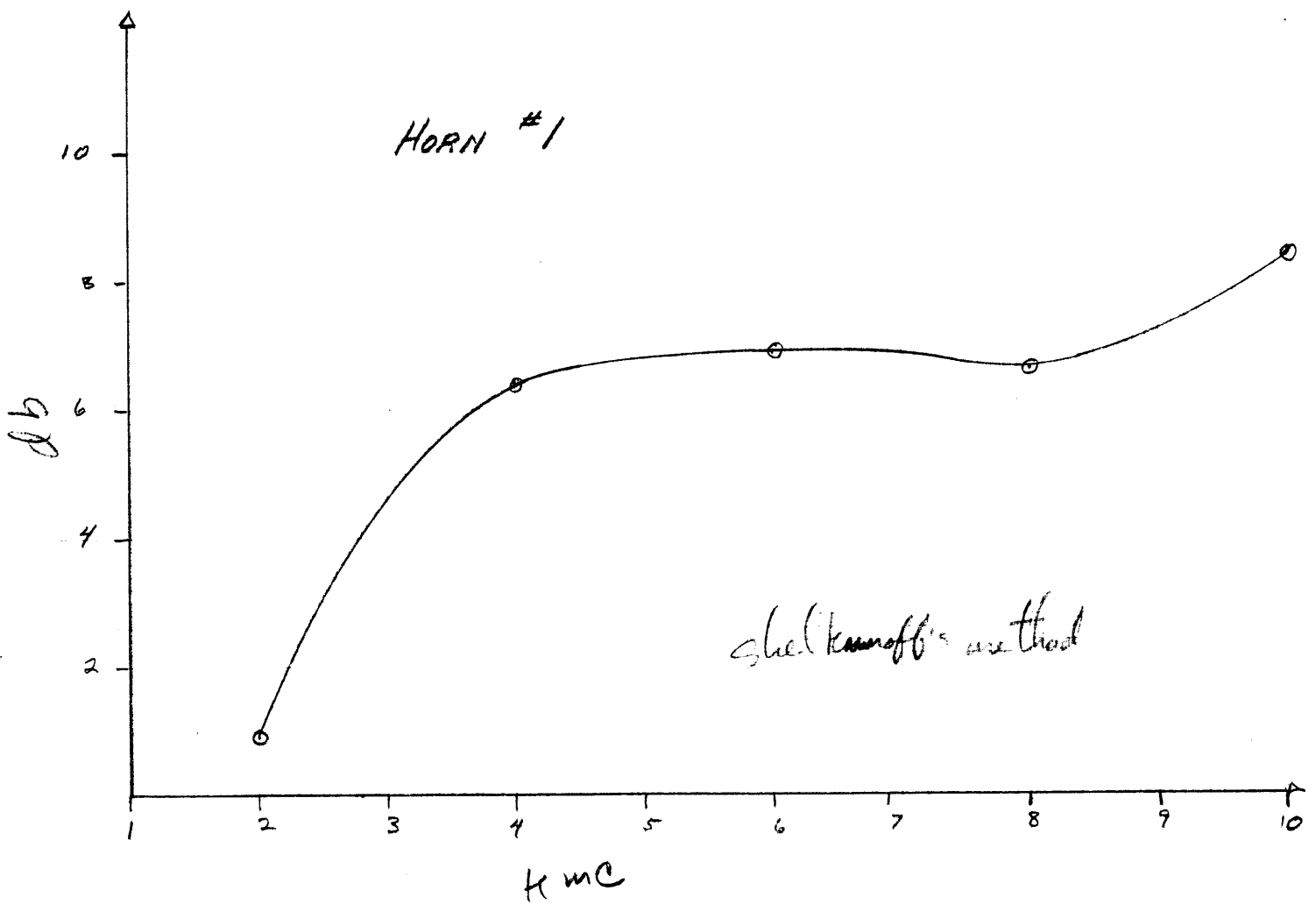

(6)

The gain is again calculated using the method of Braun, ("Some Data for the Design of Electromagnetic Horns", IRE Transactions on Antennas, Jan 1956):

freq. (Kmc)	a	b	L_E	L_H
2	.678	.1695	.927	1.165
4	1.355	.339	1.855	2.33
6	2.03	.508	2.78	3.49
8	2.72	.68	3.72	4.68
10	3.37	.847	4.63	5.82

freq
(Kmc)

	A	B	$\sqrt{\frac{50}{L_H}}$	$\sqrt{\frac{50}{L_E}}$
--	---	---	-------------------------	-------------------------

2	4.44	1.245	6.55	7.35
---	------	-------	------	------

4	6.28	1.76	4.64	5.2
---	------	------	------	-----

6	7.68	2.16	3.78	4.24
---	------	------	------	------

8	8.88	2.49	3.27	3.67
---	------	------	------	------

10	9.94	2.78	2.93	3.29
----	------	------	------	------

	G_H	G_E	8	$10 \log_{10} g$
2	45.04	-		

4	63.0	-		
---	------	---	--	--

6	74.35	22.0	9.93	9.96
---	-------	------	------	------

8	84.7	25.35	17.6	12.45
---	------	-------	------	-------

10	91.4	28.3	26.4	14.2
----	------	------	------	------

(8)

The gain may also be approximated from the formula:

$$\text{Gain} = 10.2 \frac{ab}{\lambda^2}$$

So

freq (KMC)	G	$10 \log_{10} G$
---------------	---	------------------

2	1.16	0.64
---	------	------

4	4.65	6.67
---	------	------

6	10.04	10.17
---	-------	-------

8	18.6	12.7
---	------	------

10	29	14.62
----	----	-------

1) Input to detector mount should be 40Ω
 if the microstrip feeding the mount has $h = 3/16$, $b = 1.5$, the impedance is about 45Ω

2) If microstrip of dimensions (b, h) tapers into horn (B, H) , the impedance ratio will be:

$$\frac{Z_2}{Z_1} = \frac{H}{B} \cdot \frac{b}{h} \quad \text{which in this case is}$$

$$Z_2/Z_1 = 8 \frac{H}{B}$$

3) If $\frac{H}{B} = 1/4$ and the reflections in the horn are to be kept small ; the length in wavelengths at the lowest frequency must be:

$$\ln\left(8 \frac{H}{B}\right) = \ln(2) = .694$$

This means the horn must be 4.2" deep at 2.0 kmc to minimize loss from reflections.

80

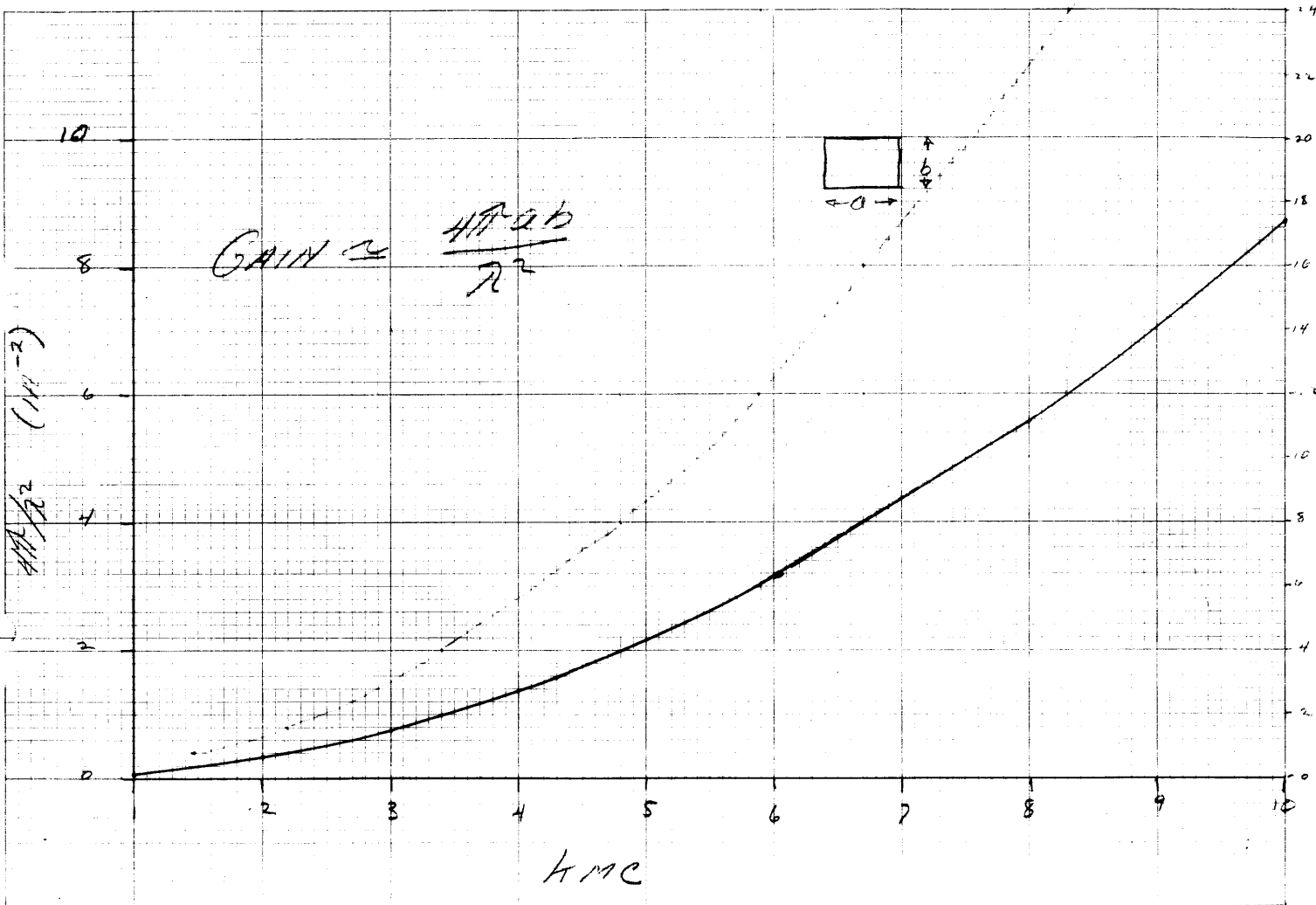

20 Feb 1956

?

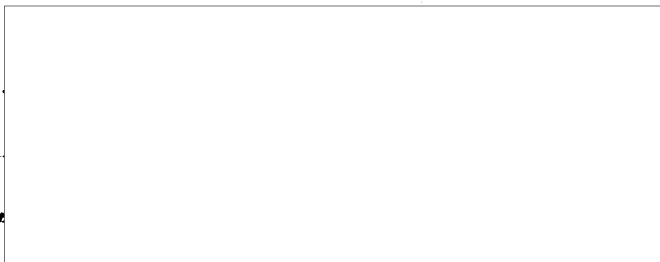

25X1

1.
 2. Type of frequency coverage desired

- a. broad band, low sensitivity
- b. restricted band, high sensitivity

3 Standby hours desired ✓

4 Video bandwidth desired.

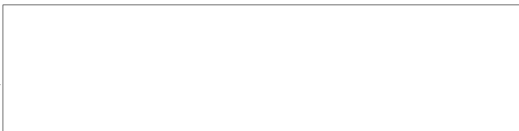

25X1

5

2.5 - 9.5

1N358

switch - completely off
stand by

video bandwidth - OK

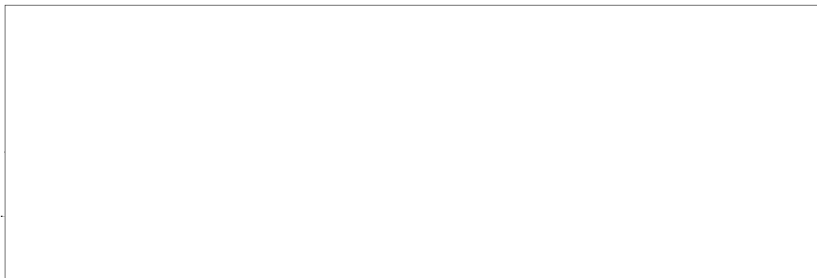

25X1

SECRET

ok



25X1

2/30/56

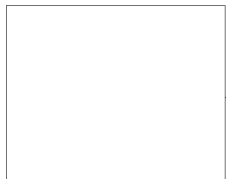

25X1

folder.

SECRET

3/30/56

25X1
25X1

[redacted] (Summary of [redacted] unit included).

1. Work remaining.

- a. Electrical (Relay for demand feature)
- (1) Attempt to reduce noise input from timing motor.
 - (2) obtain data on motor speed - vs. battery voltage.
 - (3) Run data on response - vs. PRF and pulse width.
 - (4) Test system in local area.
 - (5) Final Assembly.
 - (6) Installation of Silver-cell batteries.
 - (7) Photographs prior to assembly.

b. Mechanical

- (1) Arrange fixed [redacted] to be readily removable.
- (2) Final mechanical assembly.

25X1

2. Info. from [redacted]

25X1

- (1) Max. idle time on battery \approx 1 month - charges not required with unit.
- (2) Switch arrangement ok.
- (3) DC power from [redacted]
- (4) Design entire [redacted] to be readily removable.

25X1

25X1

3. Info. from [redacted] attached.

25X1

Norman:

Per telephone conversation with [redacted]

25X1

<

Cells will be shipped fully charged via air freight on 2 of 3 rd of April
I am going to call him back and make arrangements for [redacted] to be informed of carrier 25X1
and date when the batteries are shipped - [redacted] will pick them up at National Airport. 25X1

Answers to questions:

Ideal storage conditions: Optimum temperature: minus 20 deg F.
Anything plus 32 to minus 20 deg F provides good storage conditions.
Cells should be stored in fully charged state.

Expected shelf life:

fully charged
partially charged
fully discharged

The charged condition has little bearing on shelf life.

the cells will store in any condition for at least
6 mos. once wet
the cells will store for an indefinite period if
dry.

cells stored in a discharged state do not store as well as those stored in a charged state.

Effects of temperature extremes: temperature below minus 40 deg F can do ~~harm~~
harm is ~~period of time is long~~ ~~harm~~ this will, however, not destroy.

at temperatures above 100 deg F the cell will self discharge - in direct proportion to how high the temperature goes.

eg. at 165 deg F the cell will fully discharge in 2 weeks
at 135 deg F the cell will discharge 25% in 1 month.

If you have anyother questions I have to call [redacted] and can get the answers them.

back today

25X1

[redacted]

25X1

Page Denied

$$R = K \sqrt{P_t G_t}$$

$$\frac{1}{2} \lambda = .9 \times 10^{-4} \text{ miles}$$

$$R = \frac{\lambda}{4\pi} \sqrt{\frac{P_t}{P_r} G_t G_r}$$

freq. kHz	λ miles $\times 10^{-4}$	P_r watts $\times 10^{-8}$	G_r	window loss	$\frac{\lambda}{4\pi} \sqrt{\frac{G_r}{P_r}}$ miles (watt) ^{1/2} $\times 10^{-2}$	K
2	.9	5	1.2		.035	3.5
4	.45	10	4.4		.0238	2.4
6	.3	40	9.5		.0163	1.6
8	.225	40	19.5	0.91	.011 .0125	1.15 1.2
10	.18	400	29	0.805	.00314 .00386	.314 .39

$$\frac{.9 \times 10^{-4}}{4\pi} \sqrt{\frac{1.2 \times 10^6}{5}}$$

h_1	h_2	3.16	7.1	10	22.4	31.6	71	100	224
10	10	6.32							
50	50	10.26	14.2						
100	100	13.16	17.1	20					
500	500	25.56	29.5	32.4	44.8				
1000	1000	34.66	38.7	41.6	54	65.2			
5000	5000	74.2	78.1	81	93.4	102.6	142		
10000	10000	103.2	107.1	110	122.4	131.6	171	200	
50000	50000	227.2	231.1	234	246.4	255.6	295	324	448

	10	50	100	500	1000	5000	10000	50000
10	8.95		18.6	26.1	49.0	105		
50	14.5	20.1	21.2	31.7	51.7	100.8		
100	18.6	24.2	28.3	35.8	56.9	111.8		
500	36.1	41.7	45.8	63.5	76.4	132		
1000	49.0	54.7	58.9	76.4	89.4	115		
5000	105	110.8	114.8	132	145	201		
10000	146	152	155.5	173	186	242	283	
50000	321	327	331	348.5	361	417	458	635

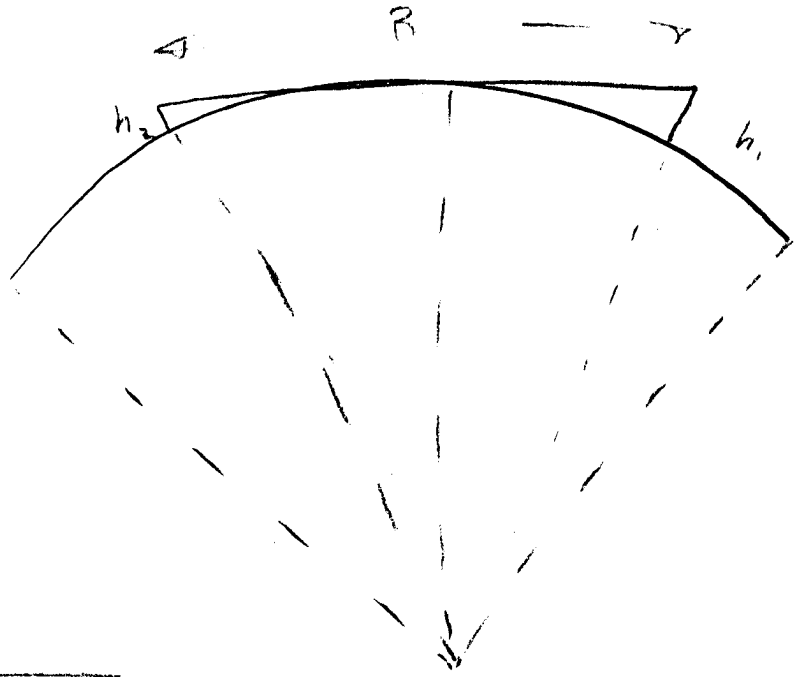

$$R^2 = \sqrt{(h_1 + a)^2 - a^2}$$

$$+ \sqrt{(h_2 + a)^2 - a^2}$$

$$= \sqrt{h_1^2 + 2h_1a} + \sqrt{h_2^2 + 2h_2a}$$

$$\approx h_1 \sqrt{2 \frac{a}{h_1} + 1} + h_2 \sqrt{2 \frac{a}{h_2} + 1}$$

$$= (\sqrt{h_1} + \sqrt{h_2}) \sqrt{2a}$$

1.42 (

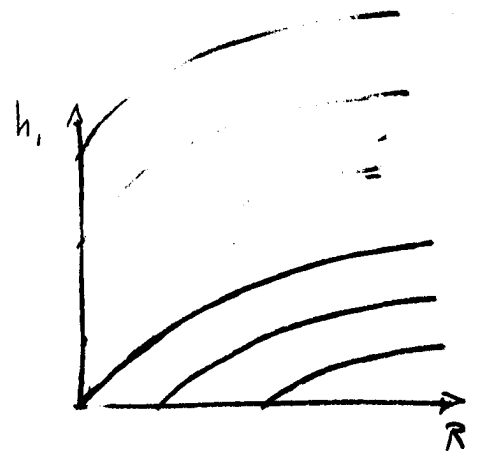

$$\sqrt{2a} = \sqrt{2 \cdot 5280 \cdot 5280}$$

$$= \sqrt{2} \times 5280 (\text{ft})^2$$

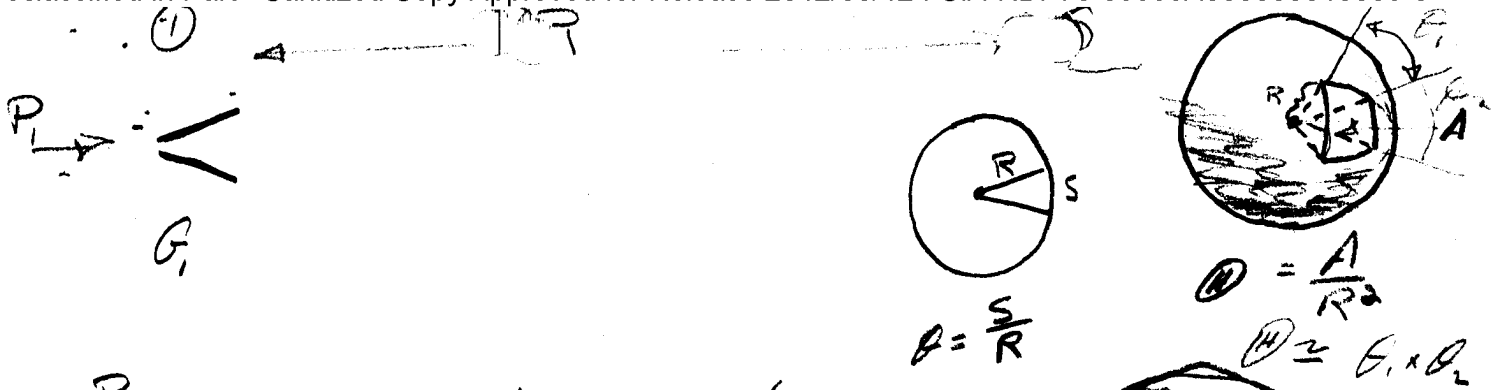

$$\frac{P_1}{4\pi} \frac{G_1}{R^2} = \text{intensity at } \textcircled{2}$$

$$\frac{P_1 G_1 A}{4\pi R^2} = \text{power at } \textcircled{2}$$

$$A = \frac{\pi^2}{4\pi} G_2$$

$$\frac{P_1 G_1 G_2}{(4\pi)^2} \frac{\pi^2}{R^2} = \text{power at } \textcircled{2}$$

if P_2 is min detectable power
then

$$R = \frac{\pi}{4\pi} \sqrt{\frac{P_1}{P_2} G_1 G_2}$$

is the maximum range

$$G = \frac{1}{\theta^2} =$$

$$\begin{aligned} \frac{\pi}{2R} &= \theta \\ \theta &= \pi R^2 \\ &= \frac{\pi}{R^2} \end{aligned}$$

$$\theta = \frac{\lambda}{2r}$$

$$\theta = \frac{\lambda^2}{4r^2}$$

$$G = \frac{4\pi}{\theta}$$

$$= \frac{4\pi r^2}{\lambda^2}$$

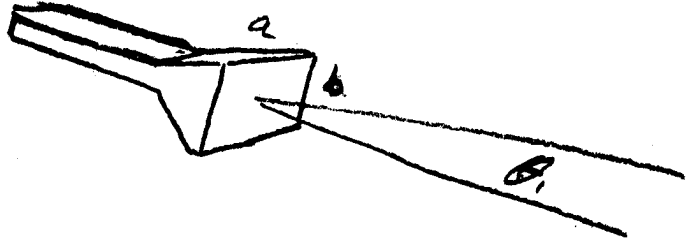
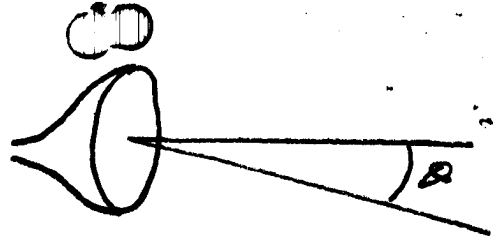

$$\theta_1 = \frac{\lambda}{a}, \theta_2 = \frac{\lambda}{b}$$

$$\theta = \frac{\lambda^2}{ab}$$

$$\text{gain} = \frac{4\pi}{\theta}$$

$$= \frac{4\pi ab}{\lambda^2}$$

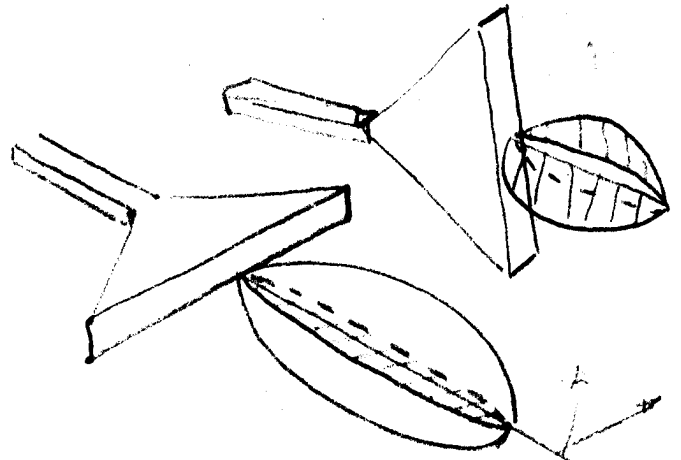
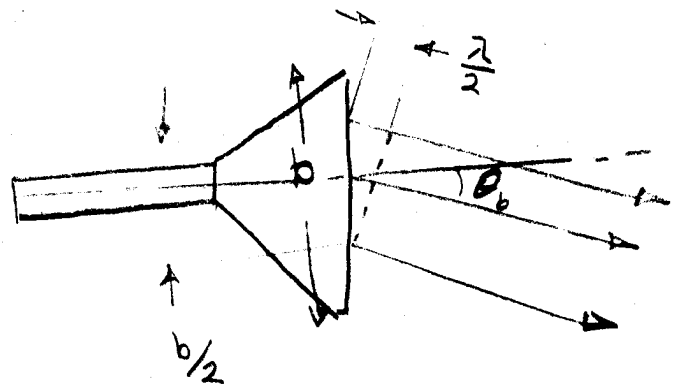
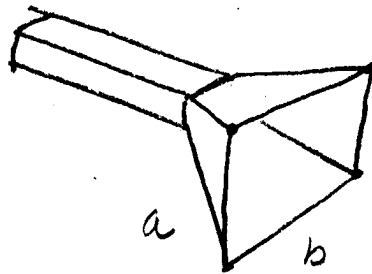

plane angle and solid angle

$$\text{GAIN} = \frac{\text{Power/unit solid angle}}{\text{total power}/4\pi}$$

Receiving cross-section:

$$\text{Power received} = \text{incident intensity} \times A$$

$$A = \frac{\lambda^2}{4\pi} G$$

Beam width:

Gain varies inversely as beam solid angle. - High gain antennas must necessarily be sharply focused.

High gain antennas are achieved by exciting a large area (a b) in phase. Horns, parabolas, arrays, etc are all methods of doing this

5

5

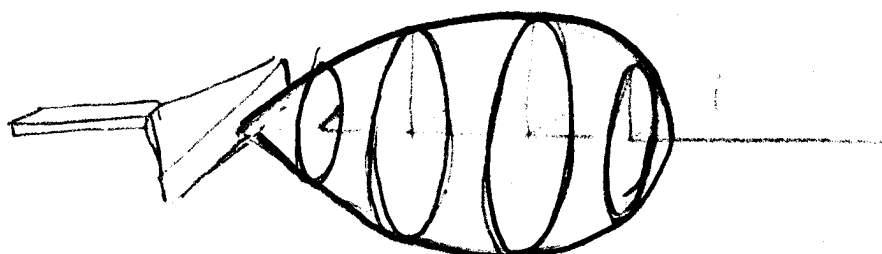
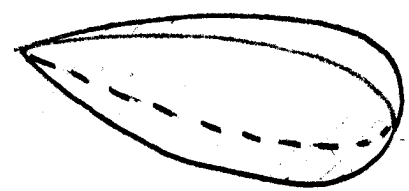

$$\lambda = 10 \text{ cm}$$

$$P_2 = -50 \text{ dbm} \quad 10 \text{ cm} = 10^{-4} \text{ km}$$

$$G_1 = 1$$

$$R = \frac{10^3}{4\pi}$$

$$G_2 = 10$$

$$R = 800 \text{ km}$$

$$P_1 = 10 \text{ kW}$$

=

$$P_2 = -90 \text{ dbm}$$

$$\frac{P_1}{P_2} = \frac{10^4}{10^{-8}} = 10^{12}$$

$$R =$$

$$R = \frac{\lambda}{4\pi} \times 10^7$$



The 10 db width in degrees
can be calculated from the formula
on page 365 of Silver:

$$\Theta_H\left(\frac{1}{10}\right) = 31 + 79 \frac{\lambda}{A} \quad \text{where } A = 4''$$

10.15 cm

so for:

freq. (Kmc)	λ cm	λ/A	Θ_H degrees
2	15	1.475	148
4	7.5	.739	89
6	5	.492	70
8	3.75	.369	60
10	3	.295	54