

file
P-130 50X1

SECRETED
SECURITY INFORMATION

16 September 1953

MEMORANDUM FOR: THE RECORD

SUBJECT: Discussion with [redacted] About
Information Sampler, Telephone, Electronic

50X1

1. On 1 September 1953, [redacted] of APD met with [redacted]
Vice President of [redacted] to discuss the
Information Sampler problem.

50X1
50X1

2. [redacted] thought the problem straight forward and
suggested the method of multiple carrier modulation as a means
of accomplishing the task. It was agreed that this would be
a satisfactory approach to the problem.

50X1

3. [redacted] would be interested
and would present a proposal shortly.

50X1

[redacted]

50X1

TSS/APD

Distribution:

Orig. - P-130

[redacted] - 1

APD - Chrono

[redacted]

50X1

50X1

SECRETED
SECURITY INFORMATION

Declassified in Part - Sanitized Copy Approved for Release 2014/05/20 : CIA-RDP78-03153A001800220005-8

D-50-411

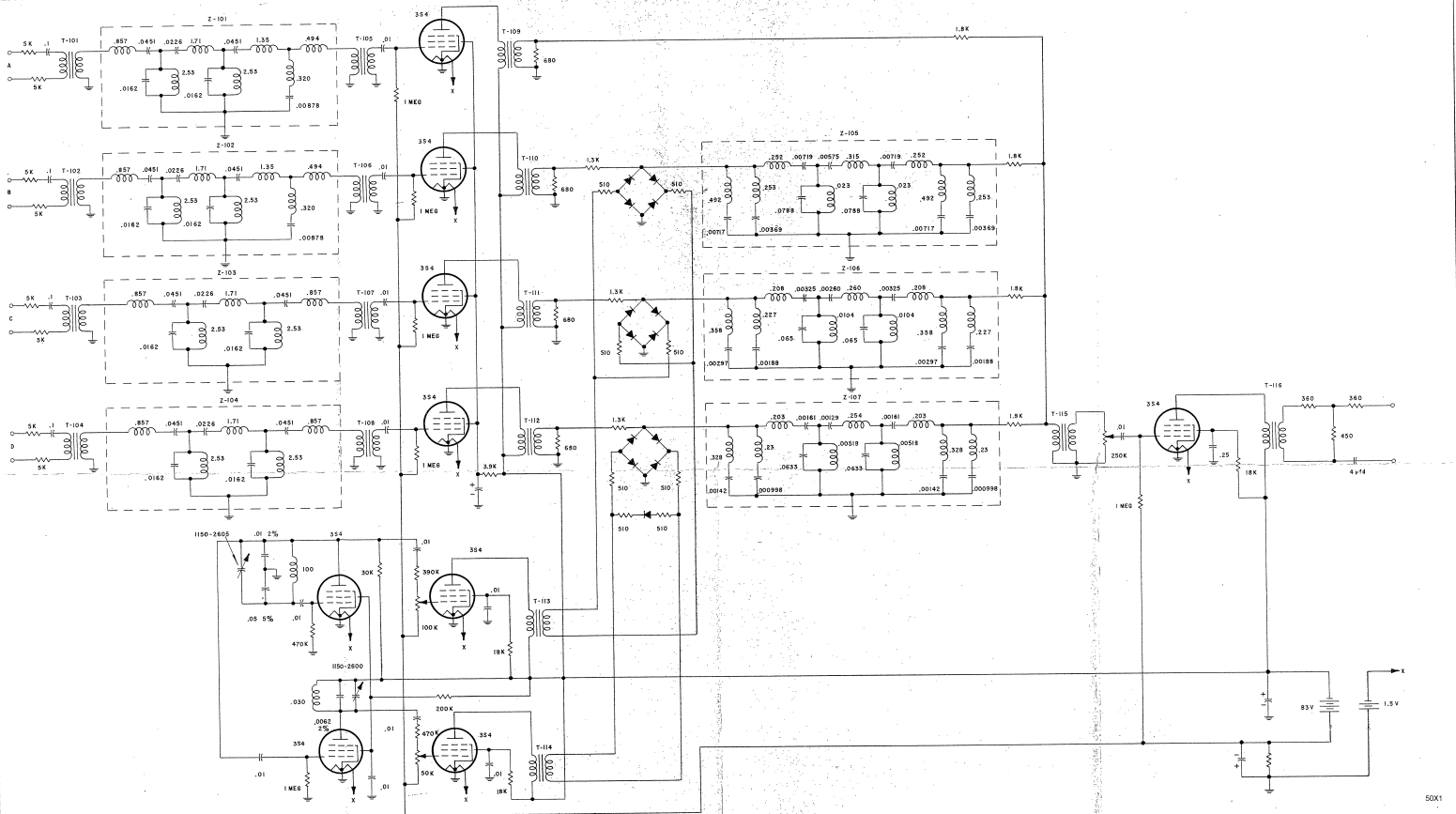

50X1

REVISIONS

| REV | DATE | BY | DESCRIPTION |
|-----|------|----|-------------|
| 1 | | | |
| 2 | | | |
| 3 | | | |
| 4 | | | |
| 5 | | | |
| 6 | | | |
| 7 | | | |
| 8 | | | |
| 9 | | | |
| 10 | | | |

LINE SAMPLING DEVICE
TRANSMITTER SCHEMATIC

SCALE: 1:1

D-50-411

Declassified in Part - Sanitized Copy Approved for Release 2014/05/20 : CIA-RDP78-03153A001800220005-8

RECEIVER

9-30-54

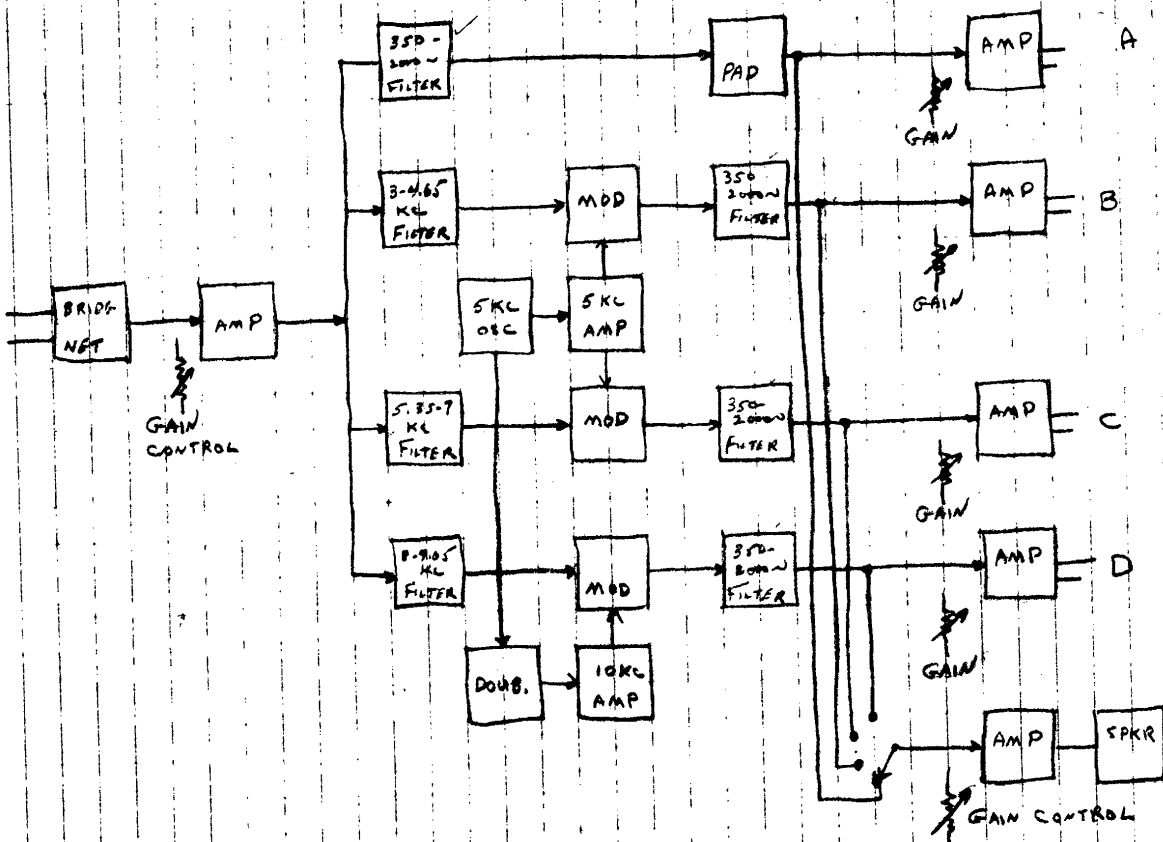

12 tubes
9 transformers
7 filters

TRANSMITTER

9-30-54

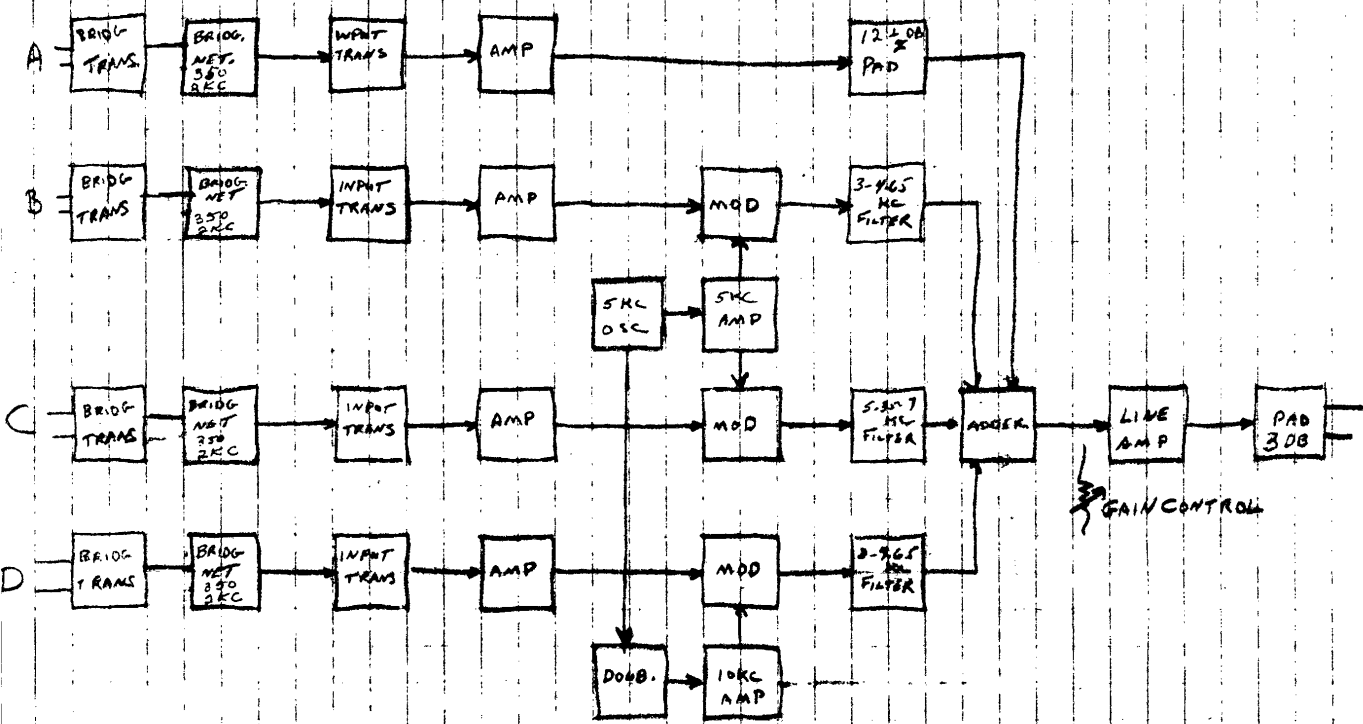

9 tubes
16 transformers

9-24-54

Z-200

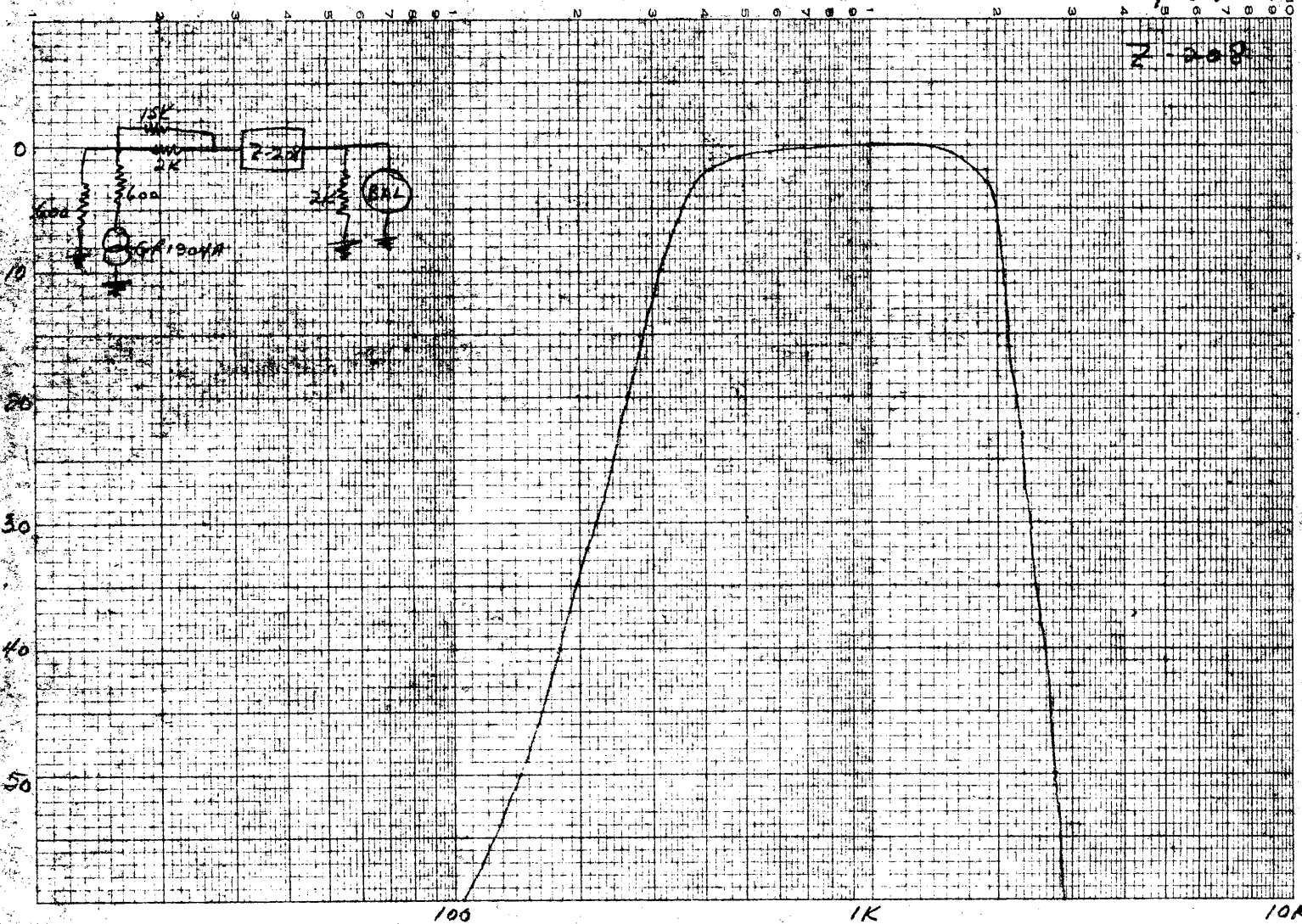

Page 3

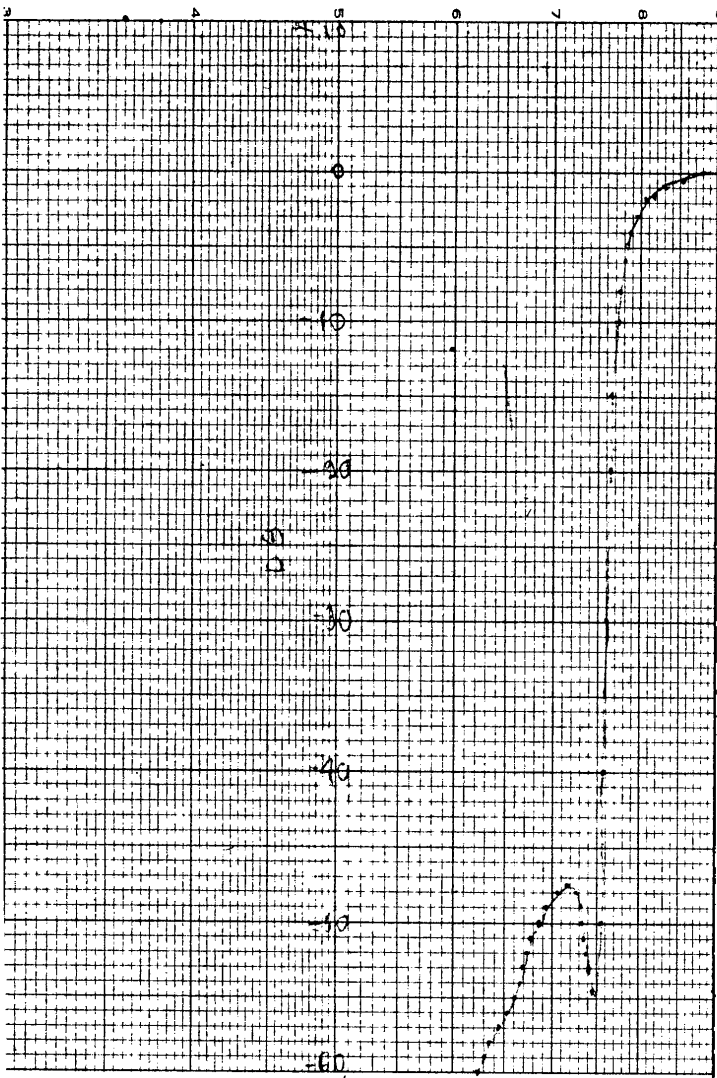

5KC EPB in cycles

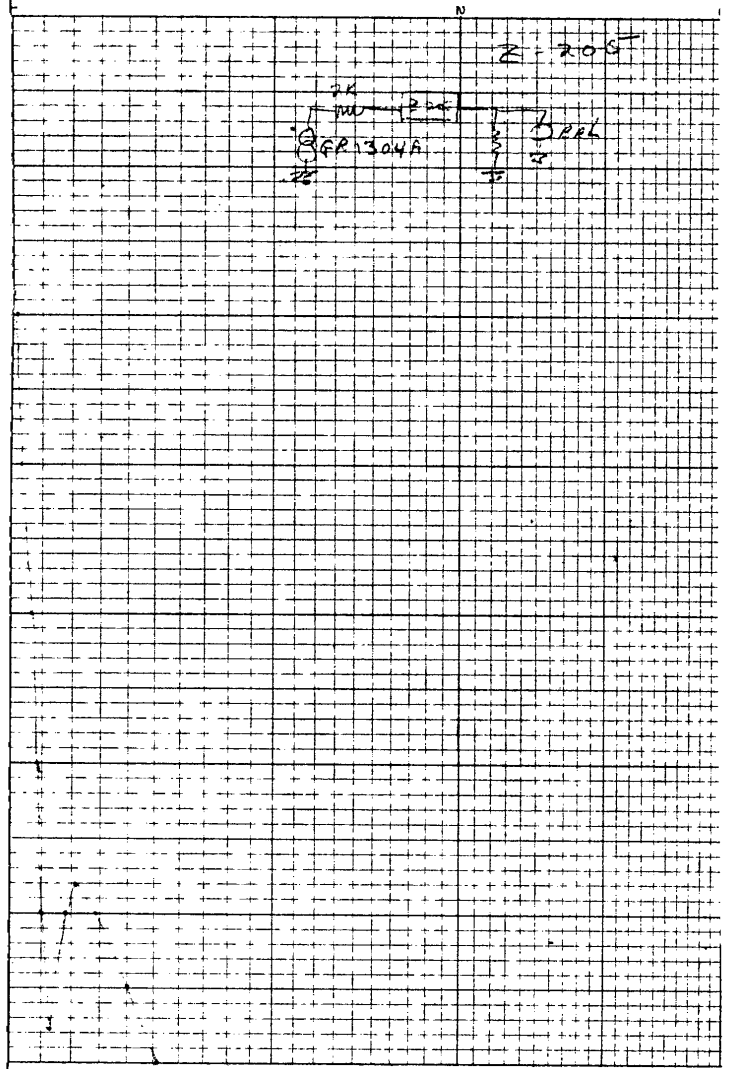

15KC

Pos 9-23-54

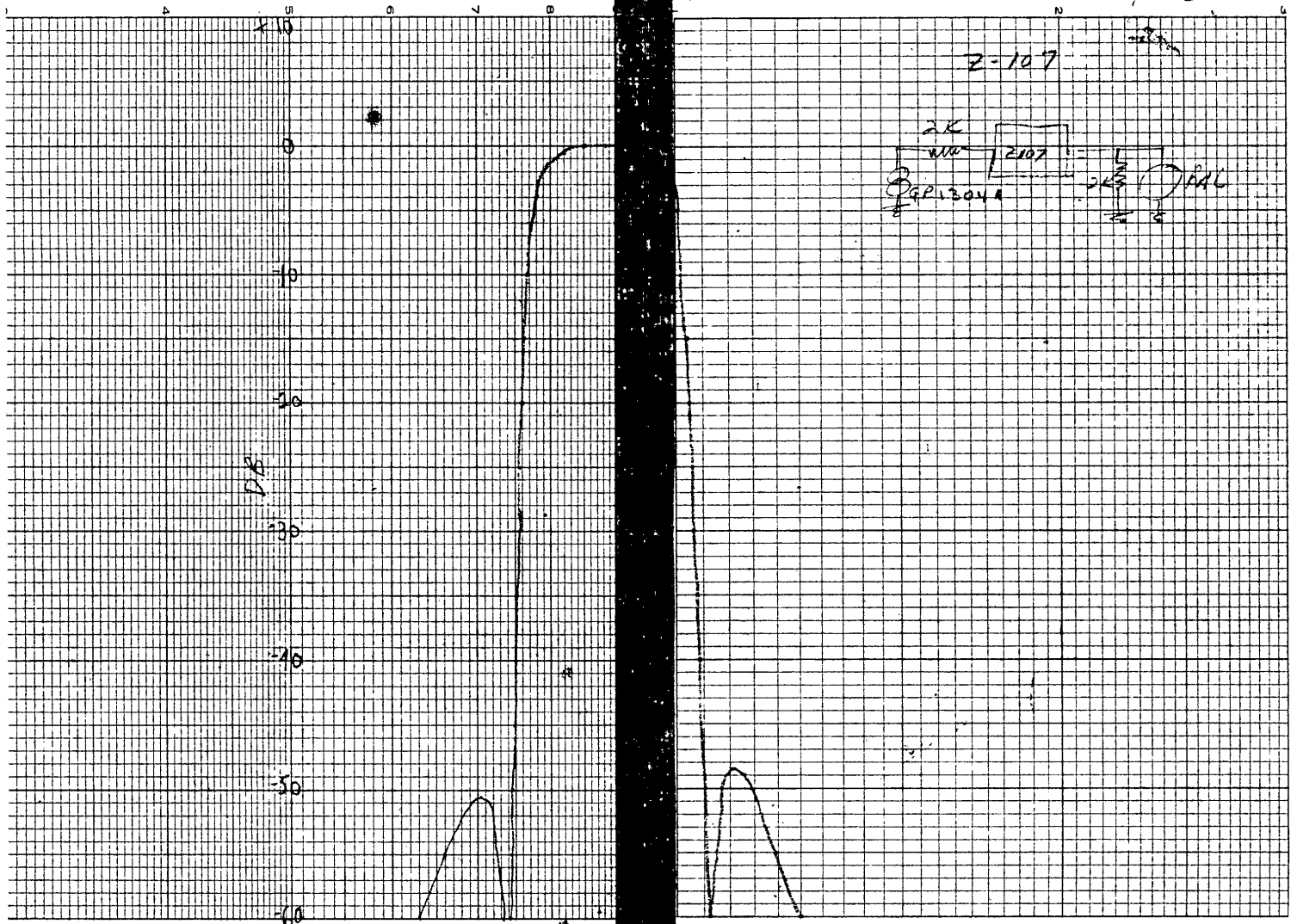

Z-205

.00518

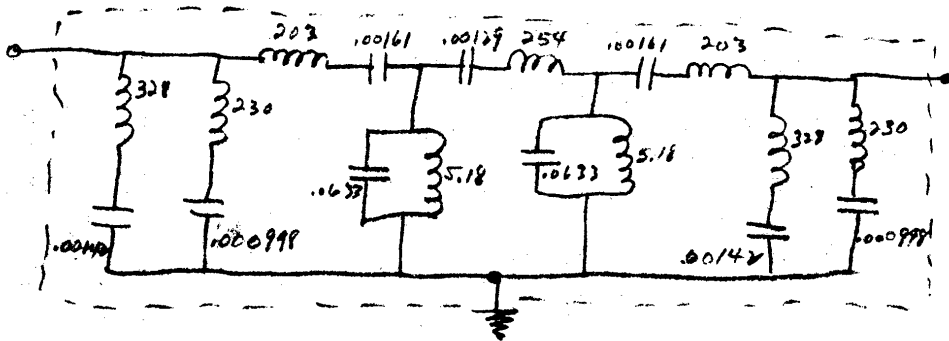

INDUCTORS IN MILLIHENRIES
CAPACITORS IN MICROFARADS

Z-102

9-23-64

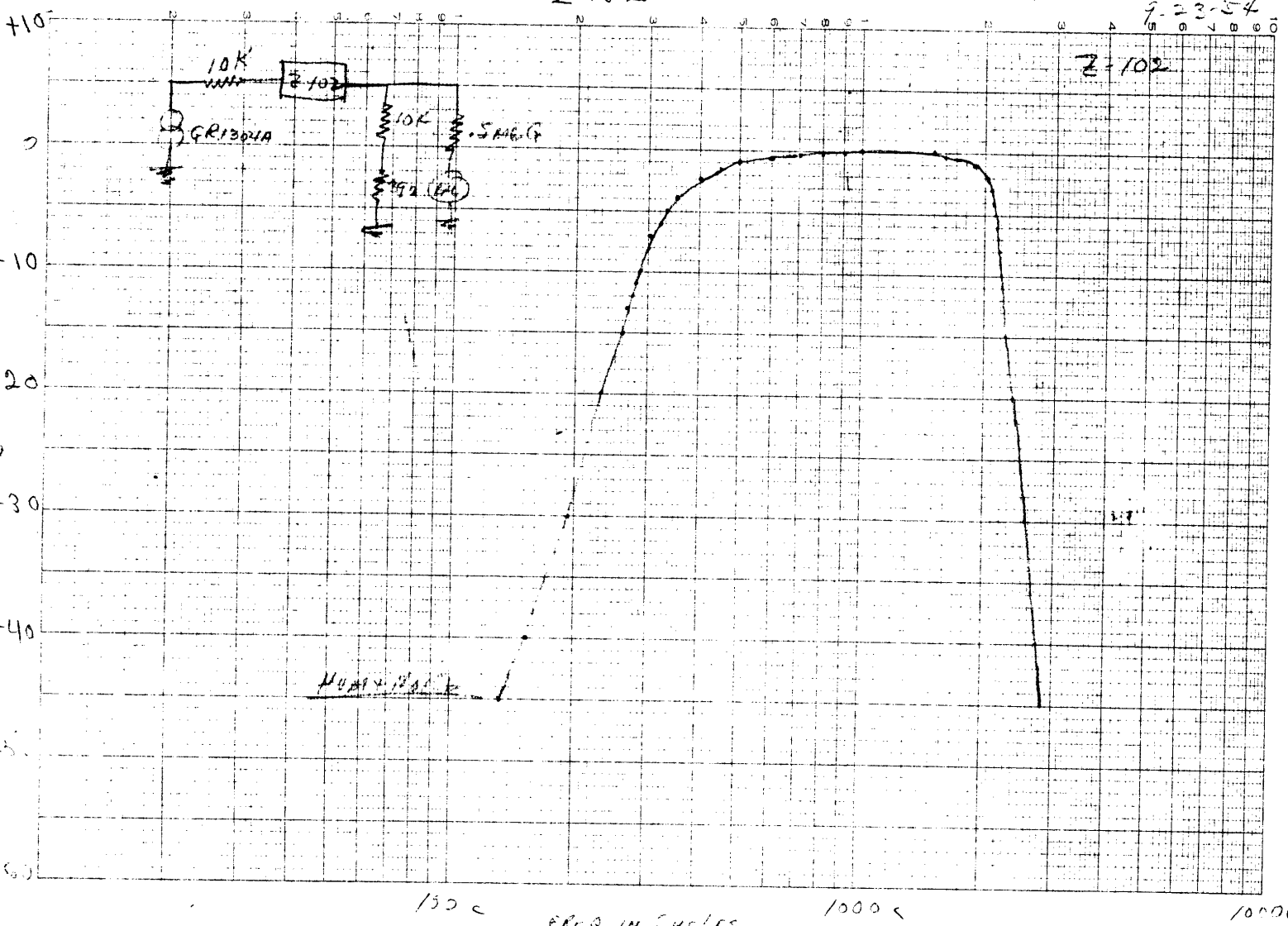

9-24-54

Z-706

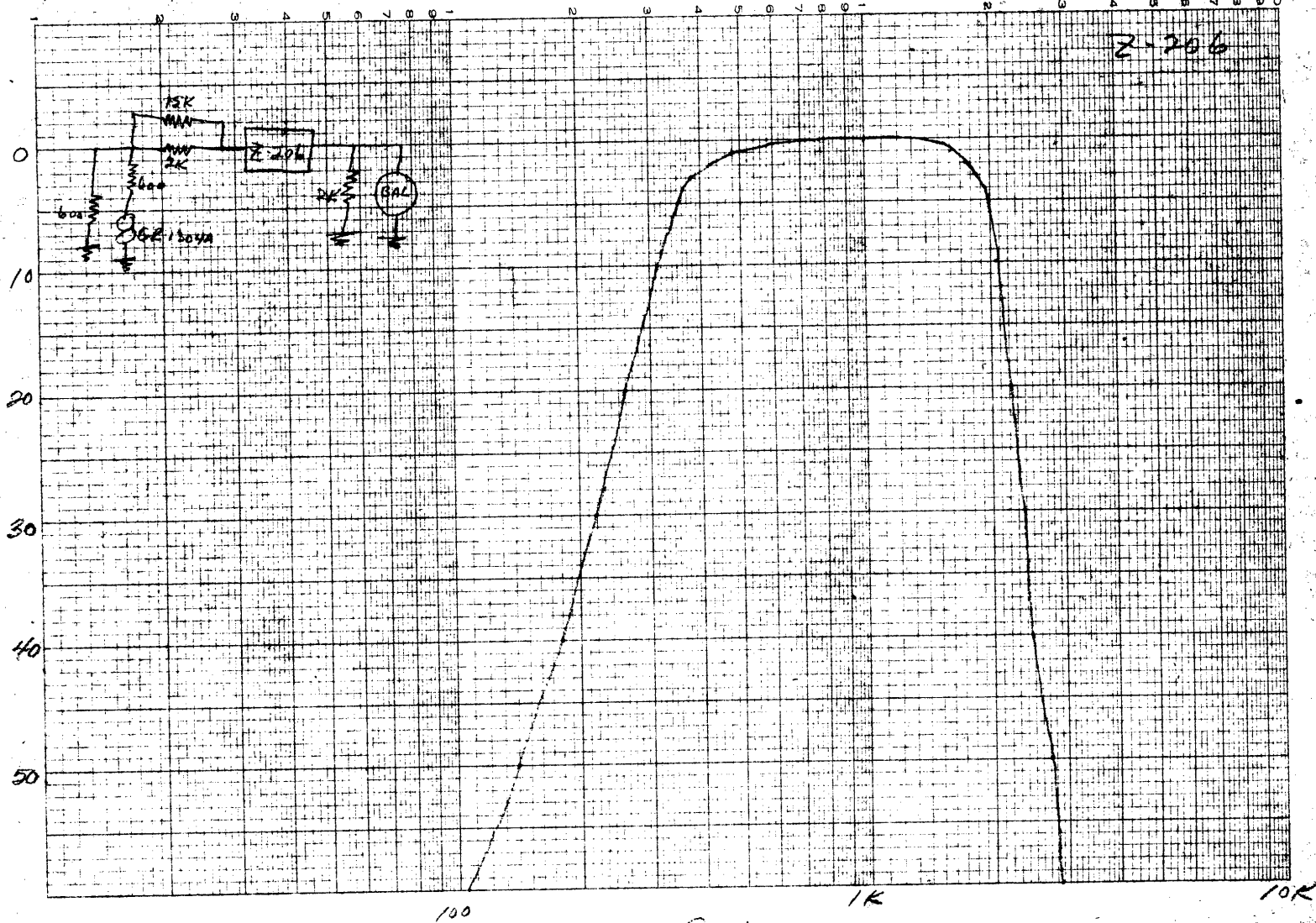

Declassified in Part - Sanitized Copy Approved for Release 2014/05/20 : CIA-RDP78-03153A001800020005-8

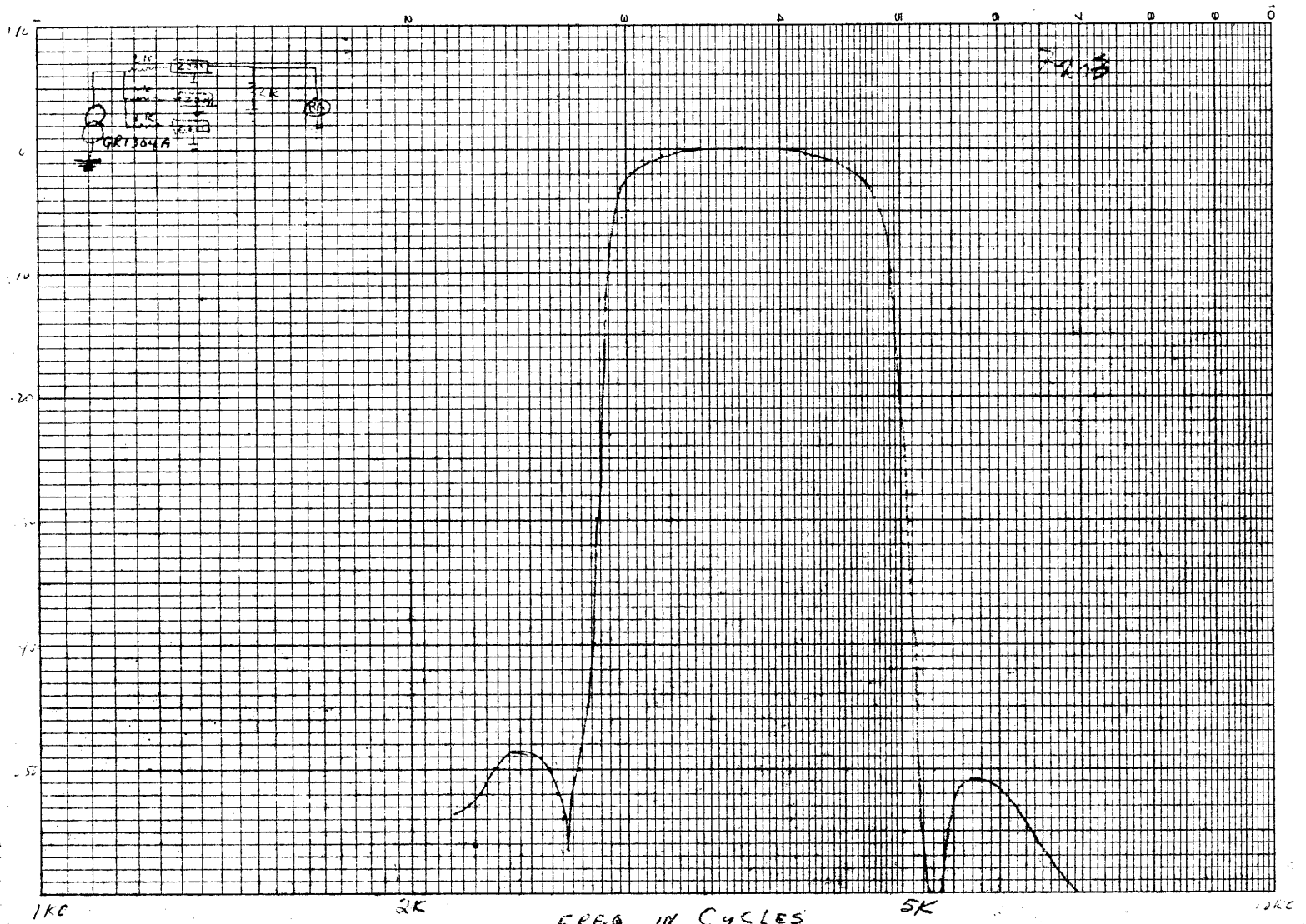

Declassified in Part - Sanitized Copy Approved for Release 2014/05/20 : CIA-RDP78-03153A001800020005-8

Z-104

9-23-54

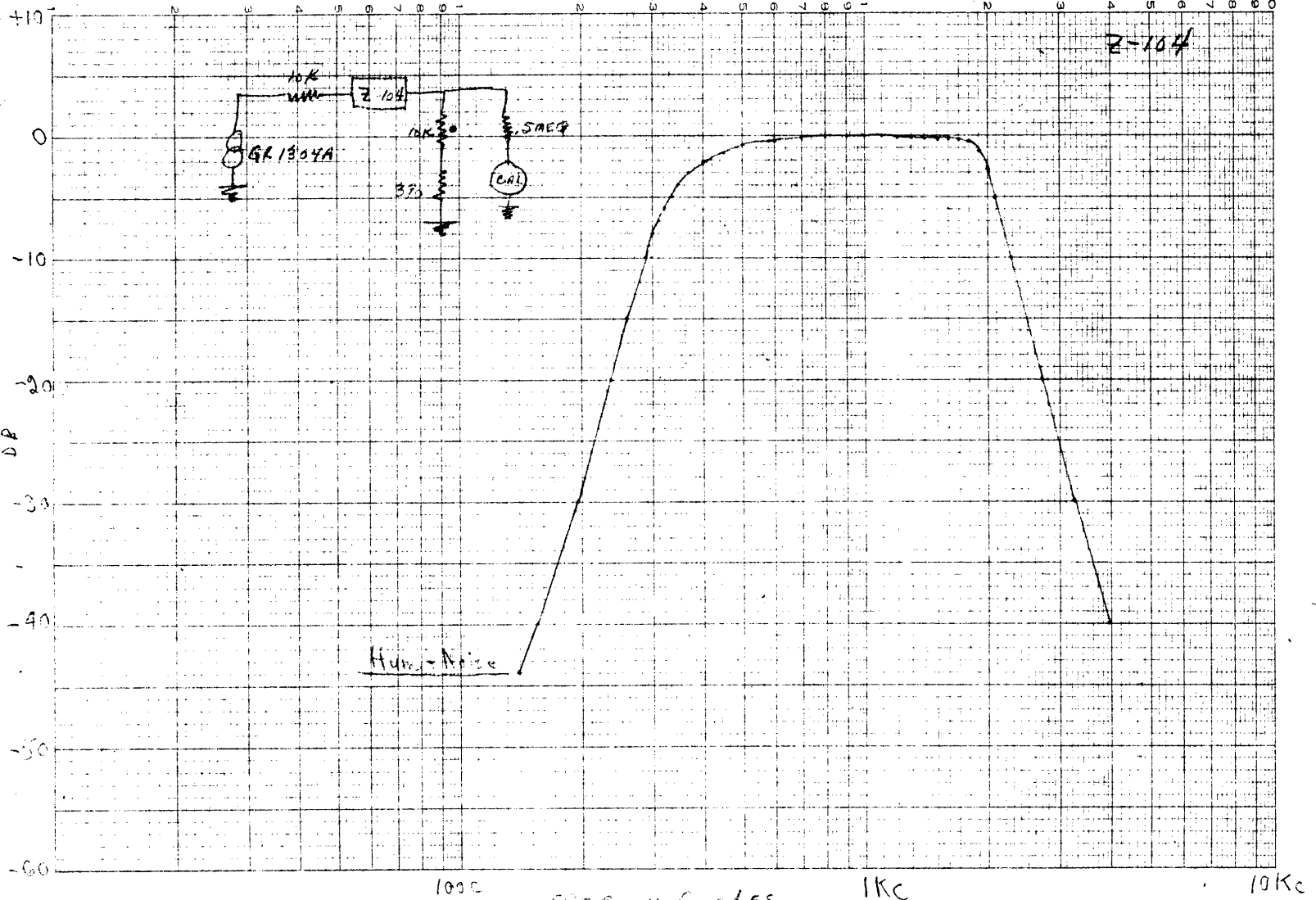

9-24-54

8-209

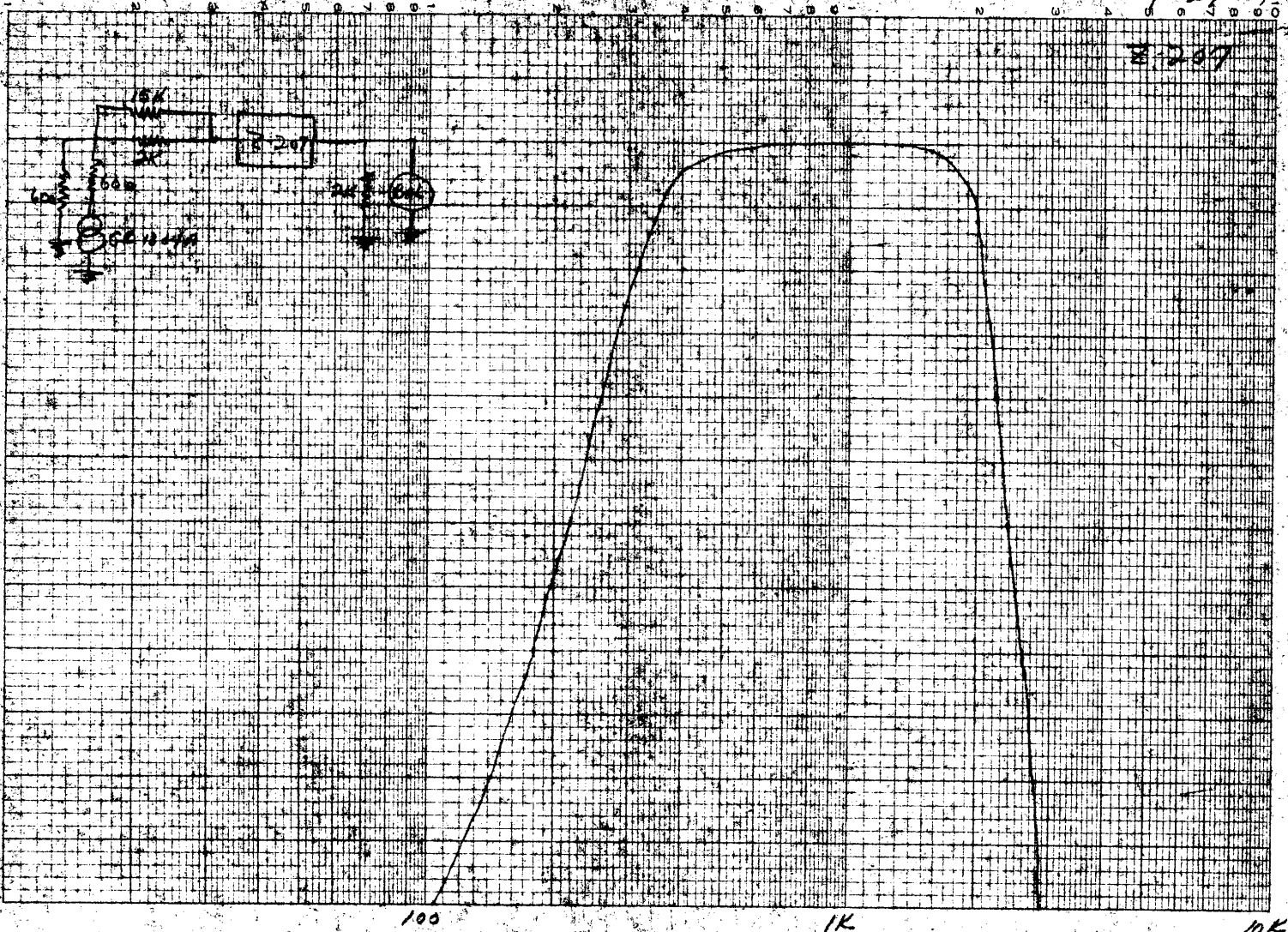

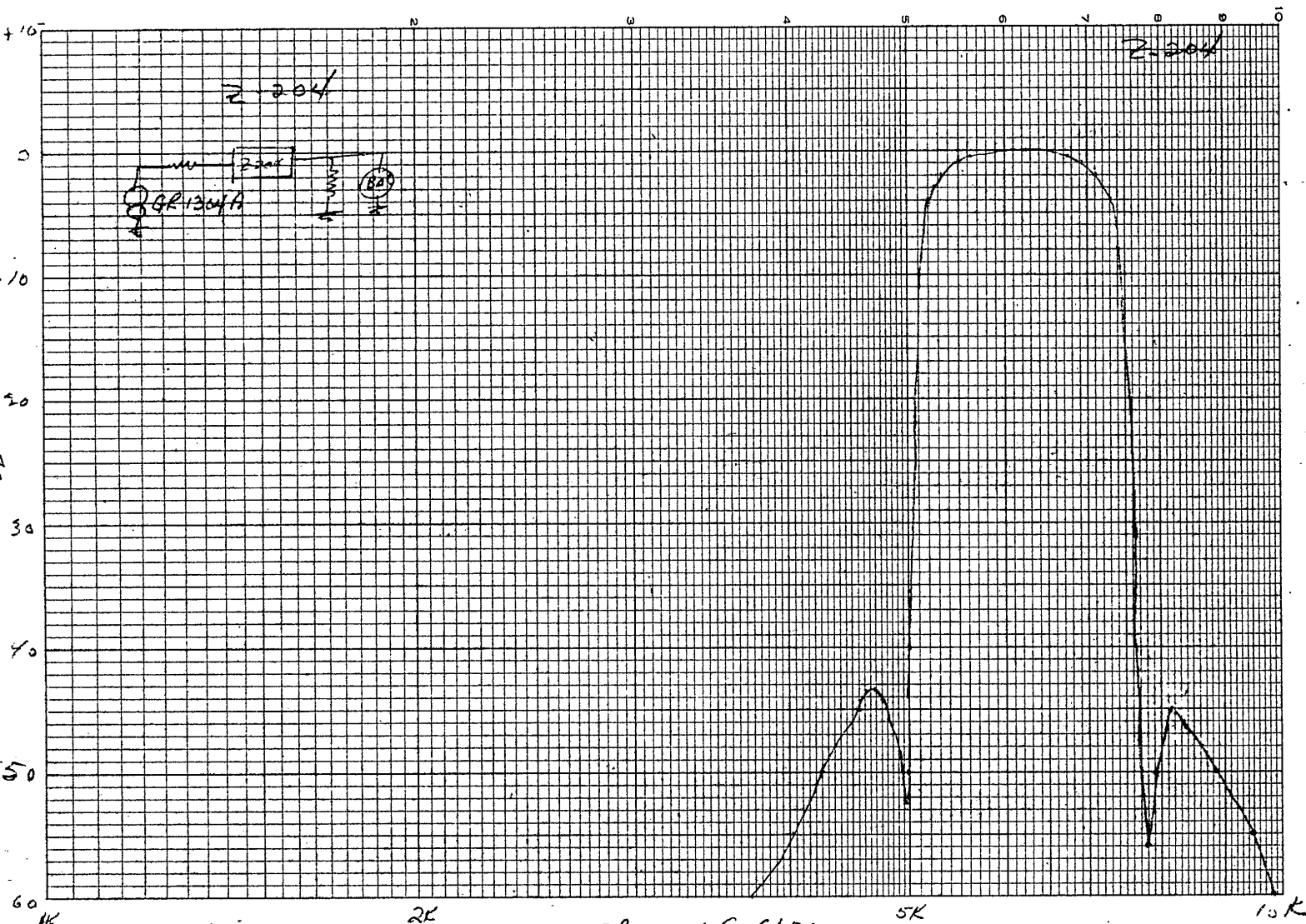

9-23-54

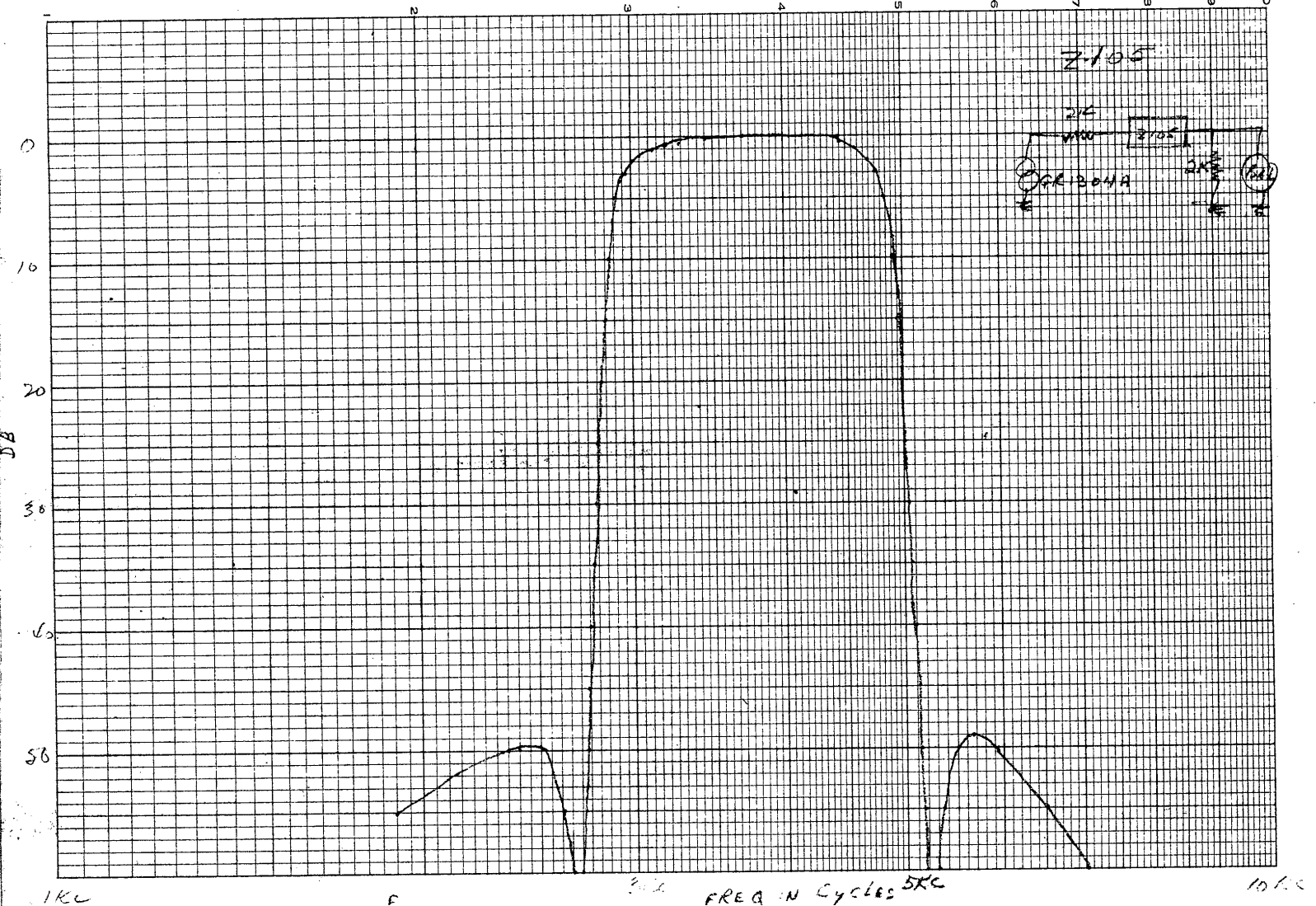

9-23-54

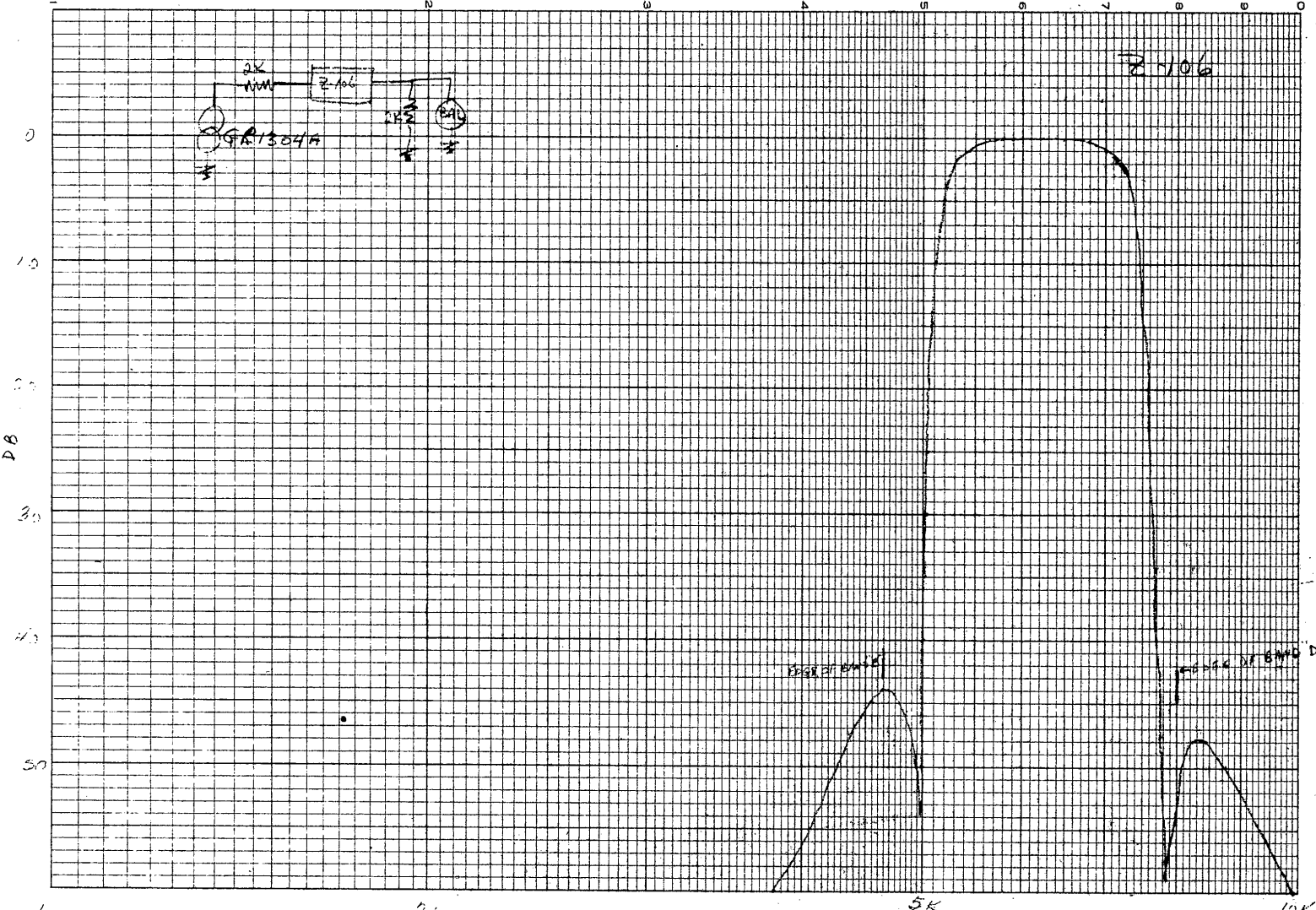

SEMI-LOGARITHMIC - 3 CYCLES X 70 DIVISIONS

9-23-54

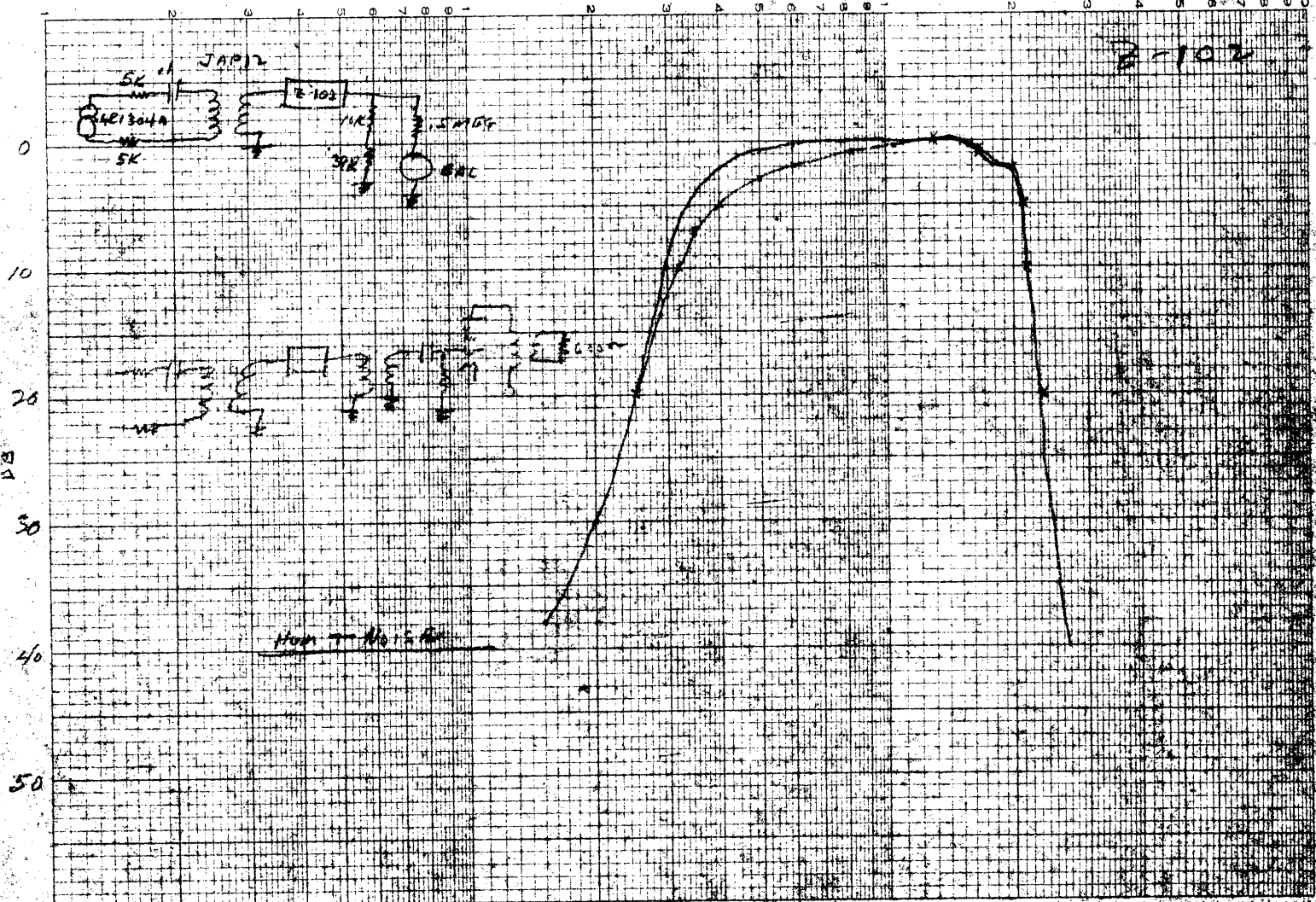

9-23-54

Z-101

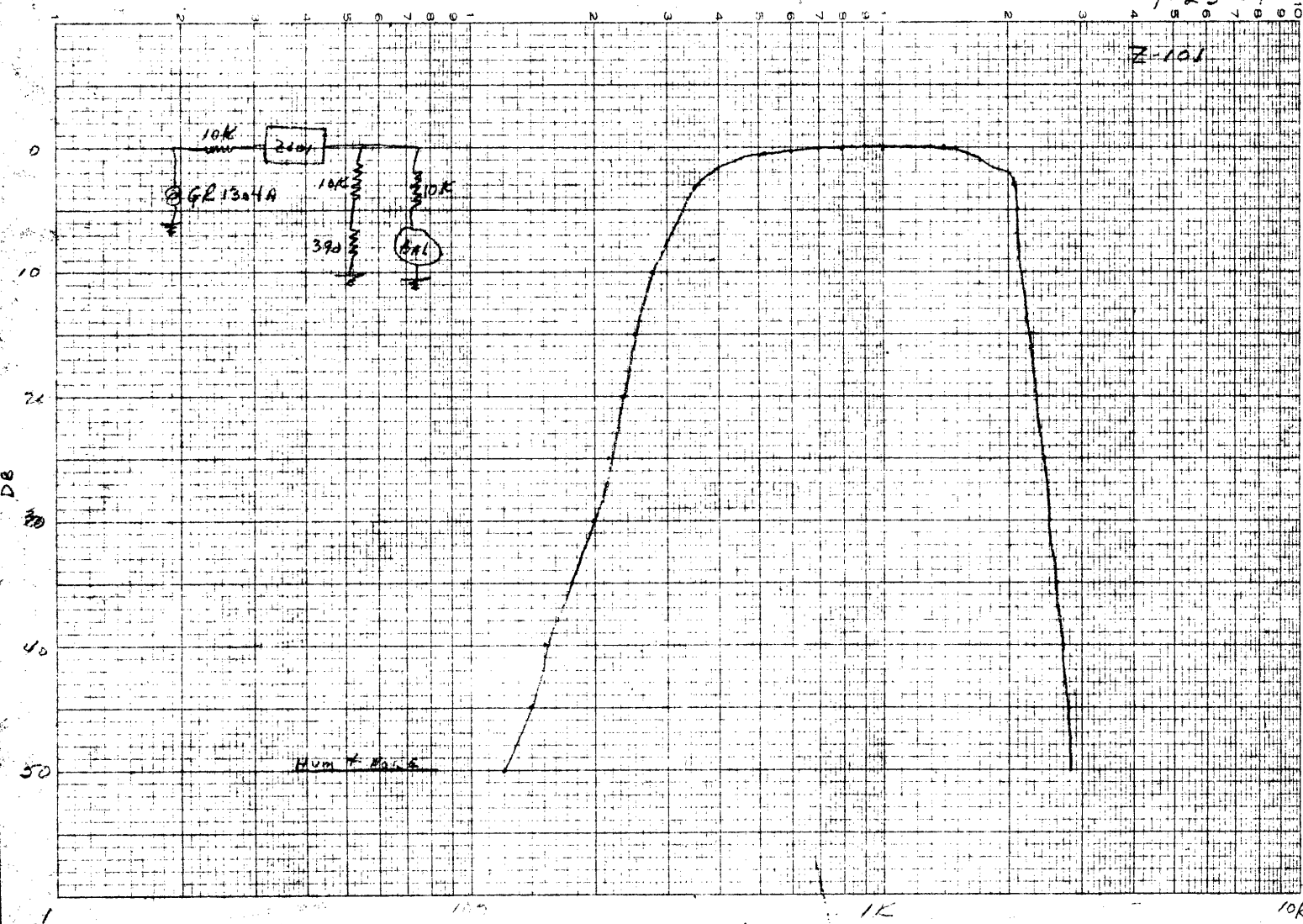

7-103, 104

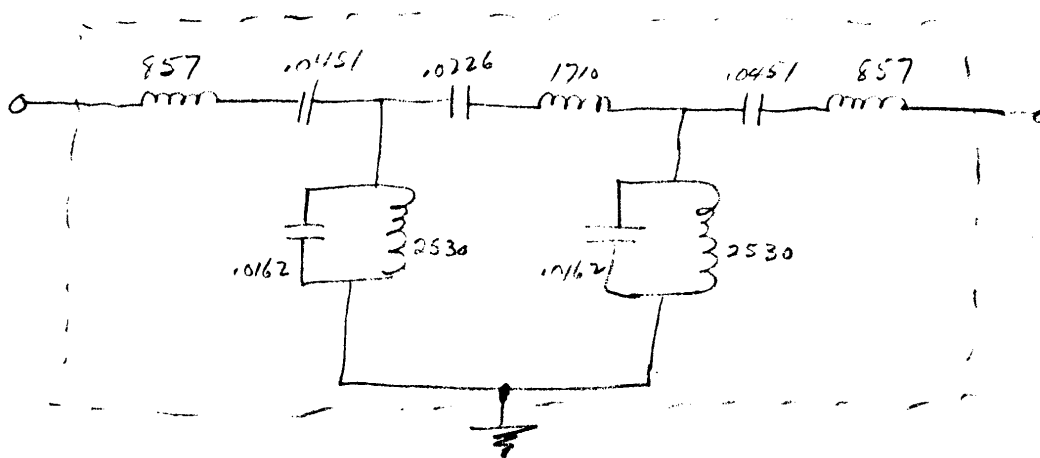

7-103, 104

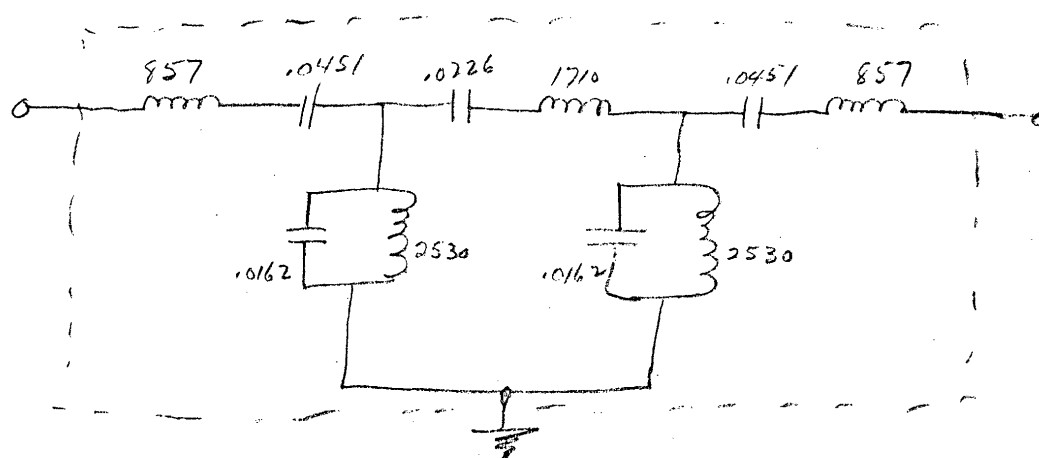

Declassified in Part - Sanitized Copy Approved for Release 2014/05/20 : CIA-RDP78-03153A001800020005-8

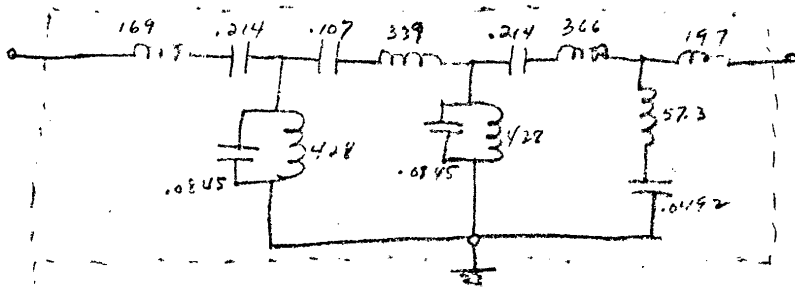

802-202, 206, 207, 208

Declassified in Part - Sanitized Copy Approved for Release 2014/05/20 : CIA-RDP78-03153A001800020005-8

Z-101, 102

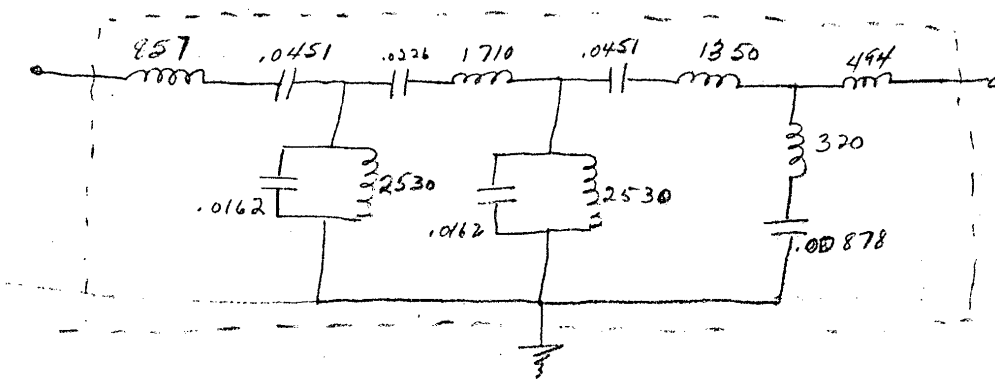

Z-204

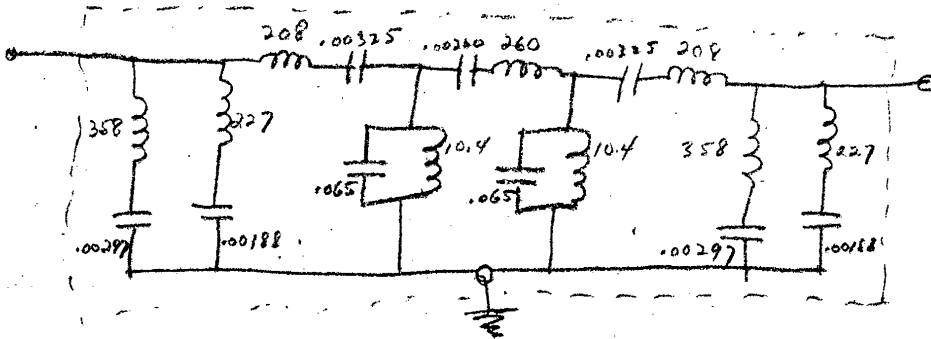

Z-203

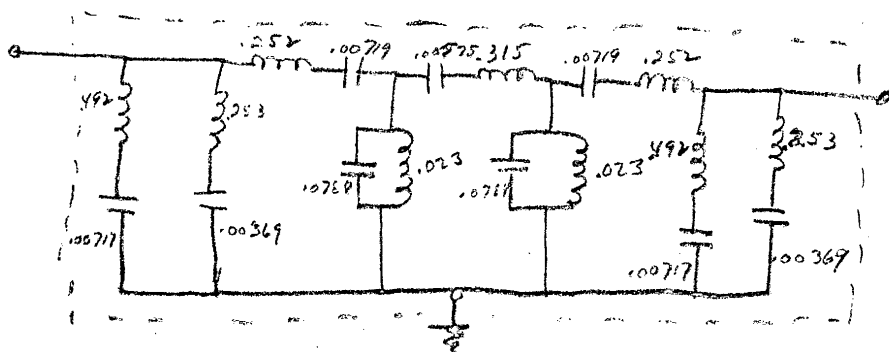

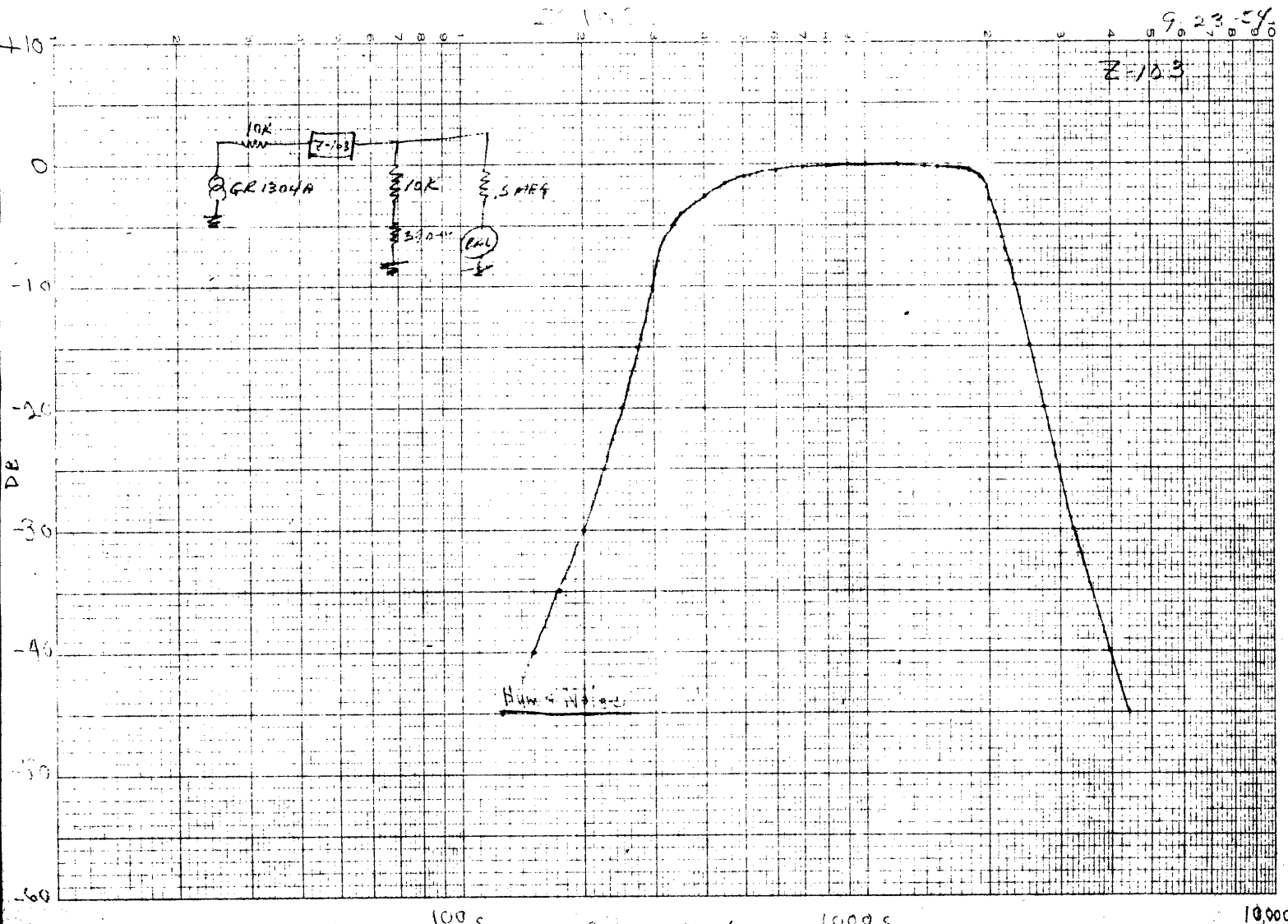

9-24-54

Z-202

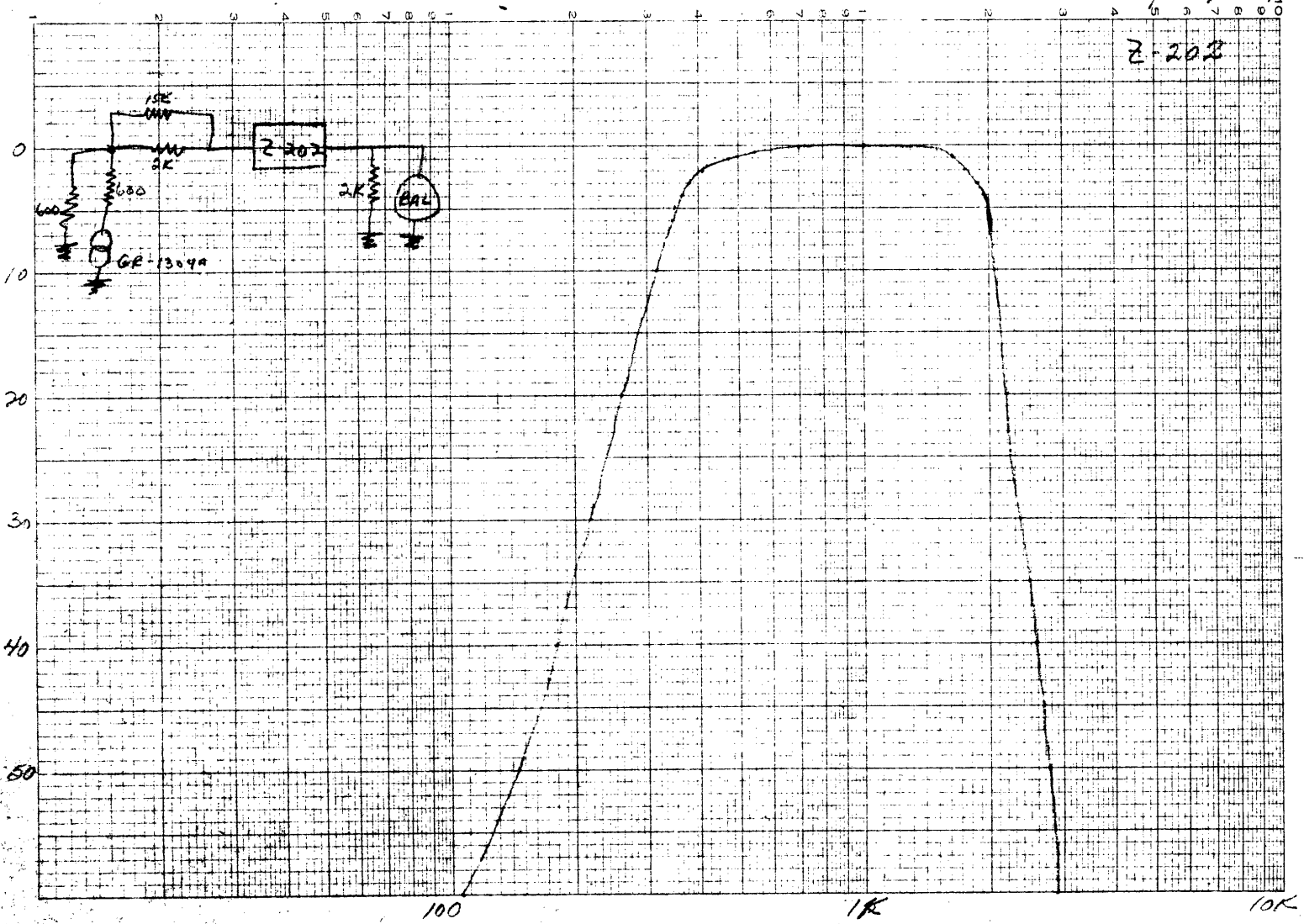

PRODUCTION NO. 3252-2

ORDERED BY

DESCRIPTION OF WORK

| DRAWING AND PART NUMBER | PART NAME | KIND OF MATERIAL | FINISH | UNIT AMT. | AMT. THIS ORDER | AMT. ORDERED | ORDERED FROM | ORDER NO. | DATE ORDERED | PROMISED | RECEIVED | COST |
|-------------------------|---------------------|------------------|-------------------------|-----------|-----------------|--------------|--------------|-----------|--------------|----------|----------|------|
| | Transformer 2nd | 45-60 | | | | 6 | New 9007 | 6150 | shilby | | | |
| | | JAF-1 | | | | 1 | | 66616 | shilby | | | |
| | Inductor | CTR #VIC-3 | Van. 100 | | | 4 | Kearney | 66673 | shilby | | | |
| | Hydro Seal Inductor | Upper E-11-3 | 2 1/2" x 1 1/2" x 5/16" | | | 4 | Beulagoin | 66644 | shilby | | | |
| | | | | 11.4 | | 4 | | | | | | |
| | | | | 23.0 | | 4 | | | | | | |
| | | | | 59.8 | | 5 | | | | | | |
| | | | | 167 | | 5 | | | | | | |
| | | | | 197 | | 5 | | | | | | |
| | | | | 203 | | 4 | | | | | | |
| | | | | 208 | | 4 | | | | | | |
| | | | | 221 | | 5 | | | | | | |
| | | | | 267 | | 4 | | | | | | |
| | | | | 232 | | 4 | | | | | | |
| | | | | 252 | | 4 | | | | | | |
| | | | | 253 | | 5 | | | | | | |
| | | | | 261 | | 2 | | | | | | |
| | | | | 262 | | 2 | | | | | | |
| | | | | 315 | | 2 | | | | | | |
| | | | | 328 | | 2 | | | | | | |
| | | | | 337 | | 5 | | | | | | |
| | | | | 358 | | 4 | | | | | | |
| | | | | 421 | | 10 | | | | | | |
| | | | | 472 | | 2 | | | | | | |
| | | | | 511 | | 1 | | | | | | |
| | | | | 52 | | 1 | | | | | | |
| | Spring | 6SP47352 | OPRANAS | | | 5 | Spring | 16197 | shilby | | | |
| | | 6SP56352 | | | | 5 | | | | | | |
| | | 6SP62352 | | | | 10 | | | | | | |
| | | 6SP82352 | | | | 15 | | | | | | |
| | | 6SP18452 | | | | 10 | | | | | | |
| | | 6TA | DTS | | | 10 | | | | | | |
| | | | | | | 10 | | | | | | |
| | | | | | | 10 | | | | | | |
| | | | | | | 10 | | | | | | |
| | | | | | | 10 | | | | | | |
| | | | | | | 10 | | | | | | |
| | | | | | | 10 | | | | | | |
| | | | | | | 10 | | | | | | |
| | | | | | | 10 | | | | | | |
| | | | | | | 10 | | | | | | |
| | | | | | | 10 | | | | | | |

| PRODUCTION NO. 3252-1 | | ORDERED BY | | DESCRIPTION OF WORK | | DATE | | | | | | |
|-------------------------|---------------|------------------|--------|---------------------|-----------------|--------------|--------------|-----------|--------------|----------|----------|------|
| DRAWING AND PART NUMBER | PART NAME | KIND OF MATERIAL | FINISH | UNIT AMT. | AMT. THIS ORDER | AMT. ORDERED | ORDERED FROM | ORDER NO. | DATE ORDERED | PROMISED | RECEIVED | COST |
| | 2-in. HS-60 | 2-in. HS-60 | | | | 6 | K... | 6251 | 11/14 | | | |
| | JAF-1 | JAF-1 | | | | 1 | | 6251 | 11/14 | | | |
| | U.T.C. #VIC-3 | #VIC-3 | | | | 4 | K... | 6253 | 11/14 | | | |
| | EM-3 | EM-3 | | | | 2 | ... | 6254 | 11/14 | | | |
| | EM-3 | EM-3 | | | | 4 | ... | 6254 | 11/14 | | | |
| | | | | 15.4 | | 4 | | | | | | |
| | | | | 23.0 | | 4 | | | | | | |
| | | | | 59.3 | | 5 | | | | | | |
| | | | | 169 | | 5 | | | | | | |
| | | | | 199 | | 5 | | | | | | |
| | | | | 203 | | 4 | | | | | | |
| | | | | 258 | | 4 | | | | | | |
| | | | | 22 | | 5 | | | | | | |
| | | | | 261 | | 4 | | | | | | |
| | | | | 230 | | 4 | | | | | | |
| | | | | 252 | | 4 | | | | | | |
| | | | | 253 | | 5 | | | | | | |
| | | | | 201 | | 2 | | | | | | |
| | | | | 250 | | 2 | | | | | | |
| | | | | 315 | | 2 | | | | | | |
| | | | | 229 | | 2 | | | | | | |
| | | | | 331 | | 5 | | | | | | |
| | | | | 353 | | 4 | | | | | | |
| | | | | 428 | | 10 | | | | | | |
| | | | | 41 | | 2 | | | | | | |
| | | | | 51 | | 1 | | | | | | |
| | | | | 56 | | 1 | | | | | | |
| | Springs | 6SP 47352 | PAONAS | | | 5 | Ag... | 6257 | 11/14 | | | |
| | | 6SP 56352 | | | | 5 | | | | | | |
| | | 6SP 62352 | | | | 10 | | | | | | |
| | | 6SP 82352 | | | | 15 | | | | | | |
| | | 6SP 10452 | | | | 10 | | | | | | |
| | | 6TA DTS | | | | 10 | | | | | | |
| | | -D 2 | | | | 10 | | | | | | |
| | | -D 2 | | | | 10 | | | | | | |
| | | -D 2 | | | | 10 | | | | | | |
| | | -D 4 | | | | 10 | | | | | | |
| | | -D 4 | | | | 10 | | | | | | |
| | | -D 5 | | | | 10 | | | | | | |
| | | -D 5 | | | | 10 | | | | | | |

| DRAWING AND PART NUMBER | | PART NAME | KIND OF MATERIAL | FINISH | UNIT AMT. | AMT. THIS ORDER | AMT. ORDERED | ORDERED FROM | ORDER NO. | DATE ORDERED | PROMISED | RECEIVED | COST |
|-------------------------|--|-----------------|------------------|----------|---------------------|-----------------|--------------|-----------------|-----------|--------------|----------|----------|------|
| Production No. 3352-C | | ORDERED BY | | | DESCRIPTION OF WORK | | | | | | | | |
| | | Hydro Condenser | EM-1 P | .001 | 4 | | 4 | D. C. Jones | 6592 | 4/11/54 | | h | |
| | | | | .002 | 4 | | 4 | | 2 | | | h | |
| | | | | .003 | 4 | | 4 | | 3 | | | h | |
| | | | | .005 | 4 | | 4 | | 4 | | | h | |
| | | | | .01 | 4 | | 4 | | 5 | | | h | |
| | | | | .02 | 4 | | 4 | | 7 | | | h | |
| | | | | .03 | 4 | | 4 | | 7 | | | h | |
| | | | | .05 | 4 | | 4 | | 8 | | | h | |
| | | | | .1 | 4 | | 4 | | 9 | | | h | |
| | | | | .2 | 4 | | 4 | | 11 | | | h | |
| | | | | .3 | 4 | | 4 | | 12 | | | h | |
| | | | | .5 | 4 | | 4 | | 13 | | | h | |
| | | | | 1. | 4 | | 4 | | 15 | | | h | |
| | | 1W74 Crystal | | | 10 | | 10 | Th. E. Jones | 6601 | 4/11/54 | | h | |
| | | Substrates | UTC | 11-211 | 2 | | 2 | Kenn. S. Abbott | 6612 | 4/11/54 | | h | |
| | | " | " | 11-214 | 2 | | 2 | " | " | " | | h | |
| | | " | " | 11-210 | 2 | | 2 | " | " | " | | h | |
| | | Hydro Condenser | EM-3 | .059 | 6 | | 6 | B. C. Jones | 6617 | 4/11/54 | | h | |
| | | " | " | .038 | 6 | | 6 | " | 2 | | | h | |
| | | " | " | .007 | 6 | | 6 | " | 3 | | | h | |
| | | " | " | .001 | 6 | | 6 | " | 4 | | | h | |
| | | 082 Capacitor | 2004 | 1MF | 10 | | 10 | General Corp | 6617 | 4/11/54 | | h | |
| | | | | .25MF | 10 | | 10 | " | 2 | | | h | |
| | | | | .1MF | 20 | | 20 | " | 3 | | | h | |
| | | | | .05MF | 30 | | 30 | " | 4 | | | h | |
| | | | | .02MF | 10 | | 10 | " | 5 | | | h | |
| | | | | .01MF | 30 | | 30 | " | 6 | | | h | |
| | | | | .005MF | 30 | | 30 | " | 7 | | | h | |
| | | Capacitor | W #2413 | Springer | 2 | | 2 | Kenn. S. Abbott | 6611 | 4/11/54 | | h | |
| | | Substrates | 2nd JAF-26 | | 1 | | 1 | Kenn. S. Abbott | 6638 | 4/11/54 | | h | |
| | | " | " | -15 | 1 | | 1 | " | 2 | | | h | |
| | | " | " | -11 | 1 | | 1 | " | 3 | | | h | |
| | | " | UTC H-31 | | 1 | | 1 | " | 4 | | | h | |
| | | " | UTC-A-25 | | 2 | | 2 | Capacitor Radio | 6636 | 4/11/54 | | h | |
| | | " | A-11 | | 2 | | 2 | " | " | " | | h | |
| | | Transformer | Field HS-60 | | 1 | | 1 | Kenn. S. Abbott | 6632 | 4/11/54 | | h | |
| | | Substrates | 2nd JAF-2 | | 1 | | 1 | Kenn. S. Abbott | 6649 | 4/11/54 | | h | |

| PRODUCTION No. 332-2 | | ORDERED BY | | | | DESCRIPTION OF WORK | | | | | | | |
|-------------------------|-----------------|------------------|----------|-----------|-----------------|---------------------|-----------------|-----------|--------------|----------|----------|------|--|
| DRAWING AND PART NUMBER | PART NAME | KIND OF MATERIAL | FINISH | UNIT AMT. | AMT. THIS ORDER | AMT. ORDERED | ORDERED FROM | ORDER NO. | DATE ORDERED | PROMISED | RECEIVED | COST | |
| | 2.000 | EM-1 P | .001 | 4 | 4 | 4 | B... | 6590 | 3/1/54 | | | | |
| | | | .02 | 4 | 4 | 4 | | 2 | | | | | |
| | | | .03 | 4 | 4 | 4 | | 3 | | | | | |
| | | | .05 | 4 | 4 | 4 | | 4 | | | | | |
| | | | .01 | 4 | 4 | 4 | | 5 | | | | | |
| | | | .02 | 4 | 4 | 4 | | 6 | | | | | |
| | | | .03 | 4 | 4 | 4 | | 7 | | | | | |
| | | | .05 | 4 | 4 | 4 | | 8 | | | | | |
| | | | .1 | 4 | 4 | 4 | | 9 | | | | | |
| | | | .2 | 4 | 4 | 4 | | 10 | | | | | |
| | | | .3 | 4 | 4 | 4 | | 11 | | | | | |
| | | | .5 | 4 | 4 | 4 | | 12 | | | | | |
| | | | .1 | 4 | 4 | 4 | | 13 | | | | | |
| | WV Crystals | | | | | | The E. Company | 6601 | 4/1/54 | | | | |
| | 2.000 | UTC | 11-311 | | | 2 | Korn O. P. Co. | 6612 | 4/1/54 | | | | |
| | | | 11-3 | | | 2 | " | " | " | | | | |
| | | | 11-313 | | | 2 | " | " | " | | | | |
| | Hygro Low | EM-3 | .050 | 6 | 6 | 6 | B... | 6621 | 4/1/54 | | | | |
| | | | .038 | 6 | 6 | 6 | | 2 | | | | | |
| | | | .067 | 6 | 6 | 6 | | 3 | | | | | |
| | | | .200 | 6 | 6 | 6 | | 4 | | | | | |
| | OSB Corporation | 2.000 | IMF | | | 10 | Chemical Corp | 6624 | 4/1/54 | | | | |
| | | | 250E | | | 10 | | 2 | | | | | |
| | | | 1.2E | | | 20 | | 3 | | | | | |
| | | | 0.7E | | | 30 | | 4 | | | | | |
| | | | 1.3-1E | | | 10 | | 5 | | | | | |
| | | | 0.20E | | | 30 | | 6 | | | | | |
| | | | 1.1E | | | 20 | | 7 | | | | | |
| | Capacitors | CD #2813 | Springer | 2 | 2 | 2 | Korn O. P. Co. | 6611 | 4/1/54 | | | | |
| | Transformer | 2.000 | JAF-28 | | | 1 | Korn O. P. Co. | 66308 | 4/1/54 | | | | |
| | | | -15 | | | 1 | | 2 | | | | | |
| | | | -11 | | | 1 | | 3 | | | | | |
| | | | UTC H-31 | | | 1 | | 4 | | | | | |
| | | | UTC H-25 | | | 2 | Capacitor Radio | 66301 | 4/1/54 | | | | |
| | | | H-11 | | | 2 | | | | | | | |
| | Transformer | Field | 45-60 | | | 1 | Korn O. P. Co. | 66320 | 4/1/54 | | | | |
| | Transformer | 2.000 | JAF-2 | | | 1 | Korn O. P. Co. | 66419 | 4/1/54 | | | | |

PRODUCTION No. 3352-c

ORDERED BY

DESCRIPTION OF WORK

| DRAWING AND PART NUMBER | PART NAME | KIND OF MATERIAL | FINISH | UNIT AMT. | AMT. THIS ORDER | AMT. ORDERED | ORDERED FROM | ORDER NO. | DATE ORDERED | PROMISED | RECEIVED | COST |
|-------------------------|---------------------|--------------------|--------|-----------|-----------------|--------------|--------------|-----------|--------------|----------|----------|------|
| | Aluminum Capacitors | CM 20D 821 | | | | 5 | Ames | 61140 | 5/2/51 | | | |
| | | CM 20D 112J | | | | 5 | | | | | | |
| | | CM 20D 122J | | | | 5 | | | | | | |
| | | CM 30D 132 | | | | 5 | | | | | | |
| | | CM 30D 222+1 | | | | 5 | | | | | | |
| | | CM 30D 272+ | | | | 5 | | | | | | |
| | | CM 30D 302+ | | | | 5 | | | | | | |
| | | CM 30D 352+ | | | | 5 | | | | | | |
| | | CM 30D 512+ | | | | 5 | | | | | | |
| | | CM 30 7651 | | | | 10 | | | | | | |
| | Transformer | JAF-15 | | | | 3 | Trans. Co. | 61121 | 5/2/51 | | | |
| | Resistor | 1/2 W, 200 Ohm, 1% | | | | 2 | Resistor Co. | 61157 | 5/2/51 | | | |
| | | 414 | " | | | 2 | | | | | | |
| | | 1.35 | " | | | 2 | | | | | | |
| | | 1.11 | " | | | 4 | | | | | | |
| | | 2.53 | " | | | 8 | | | | | | |
| | Spring | 6SP 2253 | | | | 5 | Spring Co. | 61122 | 5/2/51 | | | |
| | | 6SP 235- | | | | 10 | | | | | | |
| | | 6SP 235- | | | | 5 | | | | | | |
| | | 6SP 2752 | | | | 10 | | | | | | |
| | Transformer | JAF-12 | | | | 1 | Trans. Co. | 61250 | 5/2/51 | | | |
| | | | | | | 4 | | 61323 | 5/2/51 | | | |
| | Capacitor | MPT 115 | | | | 2 | Trans. Co. | 61340 | 5/2/51 | | | |
| | CD UP 3215 | Capacitor | | | | 2 | Trans. Co. | 61298 | 5/2/51 | | | |
| | Batteries | PC 4 VS112 | | | | 6 | | | | | | |
| | PC 4 | #6 | | | | 4 | | | | | | |
| | Spring | JAF-15 | | | | 10 | Trans. Co. | 61289 | 5/2/51 | | | |
| | | D2 | | | | 10 | | | | | | |
| | | D22 | | | | 10 | | | | | | |
| | | D3 | | | | 10 | | | | | | |
| | | D4 | | | | 10 | | | | | | |
| | | D47 | | | | 10 | | | | | | |
| | | D5 | | | | 10 | | | | | | |
| | | D6 | | | | 10 | | | | | | |
| | | D68 | | | | 10 | | | | | | |
| | CD Cap. T | B18P 100.15 | | | | 3 | Trans. Co. | 61293 | 5/2/51 | | | |

| PRODUCTION No. 3352-c | | ORDERED BY | | | DESCRIPTION OF WORK | | | | | | | |
|-------------------------|---------------------|-----------------------------|---------|-----------|---------------------|--------------|-----------------|-----------|--------------|----------|----------|------|
| DRAWING AND PART NUMBER | PART NAME | KIND OF MATERIAL | FINISH | UNIT AMT. | AMT. THIS ORDER | AMT. ORDERED | ORDERED FROM | ORDER NO. | DATE ORDERED | PROMISED | RECEIVED | COST |
| | Aluminum Capacitors | CM 20D 82K | | | | 5 | Ames Part | 1 | 60146 | 5/21/51 | | |
| | | CM 20D 112K | | | | 5 | | 2 | | | | |
| | | CM 20D 132K | | | | 5 | | 3 | | | | |
| | | CM 20D 132 | | | | 5 | | 4 | | | | |
| | | CM 30D 222K | | | | 5 | | 5 | | | | |
| | | CM 30D 272K | | | | 5 | | 6 | | | | |
| | | CM 30D 302K | | | | 5 | | 7 | | | | |
| | | CM 30D 332K | | | | 5 | | 8 | | | | |
| | | CM 30D 512K | | | | 5 | | 9 | | | | |
| | | CM 30 762K | | | | 10 | | 10 | | | | |
| | Transformer | JAF-15 2.2 | | | | 3 | Kam G. Co. | 1 | 61121 | 5/21/51 | | |
| | Resistor | 200 Ohm, 2% = 175, .320 Ohm | | | | 2 | B. M. Co. | 1 | 61185 | 5/21/51 | | |
| | | .414 " | | | | 2 | | | | | | |
| | | 1.35 " | | | | 2 | | | | | | |
| | | 1.91 " | | | | 4 | | | | | | |
| | | 2.53 " | | | | 8 | | | | | | |
| | Spacers | 65P 9225B | | | | 5 | Spencer Station | 1 | 61131 | 5/21/51 | | |
| | | 65P 1235 | | | | 10 | | | | | | |
| | | 65P 2322 | | | | 5 | | | | | | |
| | | 65P 2952 | | | | 10 | | | | | | |
| | Transformer | JAF-12 | | | | 1 | Kam G. Co. | 1 | 61250 | 5/21/51 | | |
| | | " | | | | 4 | | | 61313 | 6/1/51 | | |
| | | " | | | | 2 | | | 61318 | 6/1/51 | | |
| | Capacitors | MT115 Ohmic | | | | 2 | Kam G. Co. | 2 | 61291 | 6/1/51 | | |
| | CD UP3015 | Capacitors | | | | 2 | | | | | | |
| | Batteries | RAK V6112 | | | | 6 | | | | | | |
| | Resistor | 100 Ohm | | | | 4 | | | | | | |
| | Transformer | JAF-12 | | | | 10 | Kam G. Co. | 1 | 61289 | 6/1/51 | | |
| | | Capacitors | WTM-D15 | | | 10 | | | | | | |
| | | D2 | | | | 10 | | | | | | |
| | | D22 | | | | 10 | | | | | | |
| | | D3 | | | | 10 | | | | | | |
| | | D4 | | | | 10 | | | | | | |
| | | D47 | | | | 10 | | | | | | |
| | | D5 | | | | 10 | | | | | | |
| | | D6 | | | | 10 | | | | | | |
| | | D68 | | | | 10 | | | | | | |
| | CD Cap. T. | B1BR100.15 | | | | 3 | Kam G. Co. | 4 | 61293 | 6/1/51 | | |

PRODUCTION NO. 330.5.C

ORDERED BY

DESCRIPTION OF WORK

| DRAWING AND PART NUMBER | PART NAME | KIND OF MATERIAL | FINISH | UNIT AMT. | AMT. THIS ORDER | AMT. ORDERED | ORDERED FROM | ORDER NO. | DATE ORDERED | PROMISED | RECEIVED | COST |
|-------------------------|---------------|---------------------------------|--------|-----------|-----------------|--------------|-----------------|-----------|--------------|----------|----------|------|
| | Coils | Hycon EM-3 | | | | 5 | Hycon Sales Co. | 68216 | 7-21-54 | | done | |
| | Coils | Hycon EM-3 | | | | 5 | Hycon Sales Co. | 68216 | 7-21-54 | | done | |
| | Transformer | Triad HS-60 | | | | 3 | Kenn Plant | 68203 | 7-21-54 | | done | |
| | Toroidal Coil | Hycon EM-3 .336 heavy $\pm 1\%$ | | | | 5 | Hycon Sales Co. | 68216 | 7-21-54 | | done | |
| | Coils | Hycon EM-3 | | | | 5 | Hycon Sales Co. | 68216 | 7-21-54 | | done | |
| | Coils | Hycon EM-3 .336 heavy $\pm 1\%$ | | | | 5 | Hycon Sales Co. | 68216 | 7-21-54 | | done | |
| | Transformer | JA-12 | | | | 2 | JA-12 | 67114 | 8-17-54 | | done | |

| DRAWING AND PART NUMBER | | PART NAME | KIND OF MATERIAL | FINISH | UNIT AMT. | AMT. THIS ORDER | AMT. ORDERED | ORDERED FROM | ORDER NO. | DATE ORDERED | PROMISED | RECEIVED | COST |
|-------------------------|--|---------------|----------------------------|--------|-----------|-----------------|--------------|-----------------|-----------|--------------|----------|----------|------|
| | | Transformer | Triad HS-60 | | | | 3 | Kamm Pilot | 68203 | 7-21-54 | | in | |
| | | Toroidal Coil | Hycon EM-3 .336 henry ± 1% | | | | 5 | Hycon Sales Co. | 68216 | 7-21-54 | | in | |
| | | Coils | Hycon EM-3 .336 henry ± 1% | | | | 5 | Hycon Sales Co. | 68216 | 7-21-54 | | in | |
| | | Transformer | HS-60 | | | | 2 | Hycon Sales Co. | 68216 | 7-21-54 | | in | |