RECORDS MANAGEMENT HANDBOOK

Mechanizing Paperwork

SOURCE DATA AUTOMATION

1965



GENERAL SERVICES ADMINISTRATION
NATIONAL ARCHIVES AND RECORDS SERVICE
OFFICE OF RECORDS MANAGEMENT

Federal Stock Number
7610-782-2670

MORI/CDF

RECORDS MANAGEMENT HANDBOOKS are developed by the National Archives and Records Service as technical guides to reducing and simplifying paperwork.

RECORDS MANAGEMENT HANDBOOKS:

Managing correspondence: <i>Plain Letters</i>	1955	47 p.
Managing correspondence: <i>Form Letters</i>	1954	33 p.
Managing correspondence: <i>Guide Letters</i>	1955	23 p.
Managing forms: <i>Forms Analysis</i>	1959	62 p.
Managing forms: <i>Forms Design</i>	1960	89 p.
Managing mail: <i>Agency Mail Operations</i>	1957	47 p.
Managing current files: <i>Protecting Vital Operating Records</i>	1958	19 p.
Managing current files: <i>Files Operations</i>	1964	76 p.
Managing noncurrent files: <i>Applying Records Schedules</i>	1956	23 p.
Managing noncurrent files: <i>Federal Records Centers</i>	1954	25 p.
Mechanizing paperwork: <i>Source Data Automation</i>	1965	78 p.
Mechanizing paperwork: <i>Source Data Automation Systems</i>	1963	150 p.
Mechanizing paperwork: <i>Source Data Automation Equipment Guide</i>	1963	120 p.
General: <i>Bibliography For Records Managers</i>	1965	58 p.

FOREWORD

Source data automation generally involves capturing data in punched tape, edge-punched cards, or punched cards the first time it is transcribed, so its subsequent reproduction can be mechanical rather than manual.

GSA's source data automation program is aimed at mechanizing the thousands of small operations in the Federal Government, which are currently decentralized. In addition to the clerical cost savings SDA almost always makes possible, it brings several other advantages:

- SDA provides the fundamentals for appreciating paperwork automation. This may eventually decrease the Government's recurring shortage of knowledgeable computer specialists.
- SDA increases the speed and accuracy of clerical processing and, as a result, improves service both internally and to the taxpayer.
- SDA is, in some larger offices, the first step toward automated data processing.
- The systems study which must be made as a prelude to SDA results in better operating methods. And, of course, SDA is not the goal—systems improvement is.

This handbook is designed as an introduction to the subject. The reader will find, I am sure, that it does just that.

TABLE OF CONTENTS

I. INTRODUCTION			
Short History.....	Page	Byproduct Creation of a Native Lan-	Page
Definition of Terms.....	1	guage.....	32
The Languages of Source Data Auto-	1	Holes in Tape.....	32
mation.....	2	Holes in Cards.....	35
Information Capture.....	3	Holes in Tags.....	36
Application of Source Data Automa-	3	Perforations in Coupons.....	38
tion.....	4	Dots.....	38
Benefits of Source Data Automation..	4	Bars.....	38
II. HOLES AS THE NATIVE LANGUAGE		Selected Typefaces.....	39
Tapes as Carriers.....	5	Magnetic Ink.....	40
The Physical Characteristics of		Conversion Creation of a Native Lan-	
Tape.....	5	guage.....	40
Number of Channels.....	5	V. MACHINEABLE FUNCTIONS	
Advantages of Wide Tape.....	8	What Functions.....	45
Punched Cards as Carriers.....	9	Performing Functions with Punched	
The Physical Characteristics of		Paper Tape.....	46
Punched Cards.....	9	Interpreting.....	46
Code Structure.....	10	Verifying.....	46
Tags as Carriers.....		Writing.....	47
The Physical Characteristics of		Duplicating.....	48
Tags.....	12	Arranging.....	48
Punched Code.....	13	Selecting.....	48
Processing Tags.....	13	Merging.....	49
Coupons as Carriers.....	13	Matching.....	49
The Physical Characteristics of		Counting.....	49
Coupons.....	14	Correlating Statistics.....	49
Perforating Code.....	14	Computing.....	50
Processing Coupons.....	15	Communicating.....	51
III. THE NATIVE LANGUAGES OF READ-		Performing Functions with Punched	
ING MACHINES		Cards.....	52
Dots as a Native Language.....	17	Interpreting.....	52
Bars as a Native Language.....	18	Verifying.....	52
Code Structure.....	18	Writing.....	54
Imprinting Code.....	19	Duplicating.....	55
Processing Data.....	20	Arranging.....	57
Selected Type Faces as a Native		Selecting.....	57
Language.....	21	Merging.....	59
Code Structure.....	21	Matching.....	59
Processing Data.....	22	Correlating Statistics.....	59
Magnetic Ink as a Native Language..	24	Counting.....	59
Code Structure.....	24	Computing.....	60
Data Fields.....	24	Communicating.....	62
Processing Data.....	24	VI. FINDING AND DEVELOPING APPLI-	
IV. MODES OF CAPTURING DATA		CATIONS	
Deliberate Creation of a Native Lan-		What is Systems Analysis.....	63
guage.....	29	Finding the Area to Study.....	63
Holes in Tapes.....	29	What to Look For.....	63
Holes in Cards.....	29	Where to Look.....	67
Holes in Tags.....	31	Conducting the Study.....	69
Perforations in Coupons.....	31	A Total Systems Study.....	71
Dots.....	31	Data Analysis.....	71
Bars.....	31	Reports Evaluation.....	72
Selected Typefaces.....	31	Developing the New System.....	73
Magnetic Ink.....	32	Considering a Specialty Form.....	74
		Selecting the Medium.....	76
		Selecting Specific Equipment.....	76
		Do's and Don'ts of Automation.....	77

I. INTRODUCTION

During the last 50 years the American economy has become increasingly dependent upon paperwork. The ratio of clerical workers, in the process, has gone from 1 in 40 of the total work force at the beginning of the century to 1 in 6 at the present.

Paperwork processing in this country now costs about \$40 billion a year for clerical salaries and for office tools—everything from typists, punchcard operators, and bookkeepers to pencils, paper, typewriters, adding machines, duplicators, and items of electronic hardware. Of this grand total, the annual Federal outlay is nearing \$5 billion.

Today about 20 percent of the paperwork in the Federal Government has been automated in one way or another. An account of this would tend to be divided into three parts: (1) automated data processing, (2) automated information storage and retrieval, and (3) source data automation. This handbook is concerned with the last, and with the other two only when a controlling interrelation exists.

SHORT HISTORY

Jean Emile Baudot provided the possibility for source data automation when he built a paper-tape punch and reader in the 1870's. About the same time, two other important machines were invented. William Burroughs, a bank clerk, invented the first commercially practical adding machine. Christopher Sholes invented the first commercially practical typewriter. A little later, William Hollerith and Charles Powers, realizing the value of holes as a language carrier, devised punchcards as we know them today.

In those inventions, source data automation machines had their genesis. The adding machine provided the basis for mechanical mathematics; i.e., addition, multiplication (repeat addition), subtraction, and division (repeat subtraction). The typewriter provided the basis for printing. When converted to type segments on tabulators, it provided higher speed printing.

Source data automation has progressed much more slowly than other technological improvements. The reason was probably the reluctance of executives to accept change. It was difficult to sell the idea that a machine could accurately produce, in 1 day's time, four to five times more work than a clerk could produce manually.

In 1912, John Wahl combined the adding machine with the typewriter to produce the first descriptive accounting machine. This made it possible, for the first time, to type item descriptions and to compute account balances in a single operation, rather than two separate operations.

The first front-carriage-feed accounting machine was marketed in 1928. This machine made it possible to produce, in one writing, multiple forms of differing content. No longer was it necessary to prepare statements, ledgers, and journals in three independent steps. By means of carbon paper, all could be created in one operation. The first accounting machine synchronized with a paper-tape punch was developed in 1935. The first paper-tape typewriter was introduced in the 1940's as an automatic letterwriting machine.

Although punched-card tabulating machines had been available for several decades, it must be noted that more improvements, more new models, and more new applications have been introduced in the last decade than in all preceding years. Thus it was in the early 1950's that "Integrated Data Processing" began to be forcefully and dramatically demonstrated by the equipment industry.

DEFINITIONS OF TERMS

The term "Integrated Data Processing" was first coined to describe systems involving paperwork, mechanized from initiation to completion. Integrated Data Processing was then applied to punched-card systems and, to a certain extent, to computer systems. Finally, it became so closely related to large-scale systems as to take its place with Electronic Data Processing (EDP) and Automatic Data Processing (ADP). In

the process the term lost its original meaning of source paperwork handling. The technique, therefore, had to gain its own stature and a more descriptive term. The term chosen was "Source Data Automation" (SDA). Here is the logic of the newer term:

Source—Where data begins
Data—Required information
Automation—In machine language for machine-to-machine processing

Thus the basic principle of capturing information in a usable medium, at the point of origin, for further processing, introduces a number of concepts which require further explanation.

Source

The beginning of a paperwork cycle is the source. This can be anywhere—in different offices, in a different city, across town, or right in the same office. Regardless of the physical location, *the source is always the beginning of the paperwork cycle.*

Data

Information is always data. It can be on a form. It can be part of a form. It can be on several related or unrelated forms. Data are always recorded on some medium in some manner. The recording may be merely an "X" or a checkmark in a box. It may be handwritten. It may be mechanically transcribed. Data, for source data automation purposes, must have three basic characteristics. First, it must be of a reasonably repetitive nature. Second, it must be machinable. Third, it must exist in sufficient volume to justify the smallest of automated equipments.

THE LANGUAGES OF SOURCE DATA AUTOMATION

Much harm has been done to serious consideration of the technique of source data automation by casual use of the two words "common language." The origin of the phrase is not too hard to pinpoint. Early in the formative period of automation, the only language medium which could be understood by *all* the available

machines of that period was the five-channel punched paper tape. While five-channel paper tape is still the only carrier accepted by many final processing machines today, the limitations of this carrier have virtually eliminated it as a true common language.

Native Language

Every available automatic machine on today's market operates on a language. It is true the language of one machine may be recognized by the machine of a different manufacturer, but the fact still remains that each machine has its own language built into it by its makers. The languages of machines, therefore, are not common languages but are the native languages of specific machines. In source data automation one should speak of a machine's native language and forget, for the time being at least, the phrase "common language." In illustration of this point, here are some of the basic native languages and carriers of our common systems and machines:

- Communications machines use five-channel punched paper tape.
- Paper tape typewriters use six-, seven-, and eight-channel paper tape.
- Punched-card systems use a language expressed in round or rectangular holes punched into equal-size cards.
- Scanning machines use special type fonts and magnetic ink impressions.

The requirement for different machines to talk to each other, in some systems, has led to the development of language-converting machines. These will be described in detail later. The only point to be remembered here is that regardless of the native language of any machine, it can be converted into the native language of another machine.

The native language machines in source data automation need the abilities to—

- Create data, including simple calculations when required during the paperwork cycle.
- Accept and record additional data as it occurs in a paperwork system.
- Convert data to another machinable form, if conversion is required in a paperwork system.

- Produce, as byproducts, data for the next step in a paperwork cycle.
- Integrate dissimilar machines into a single coordinated mechanized system.
- Communicate with the more complex machines, such as computers.

Common Language

The native language impressed on the carriers discussed above is a code pattern formed on the carrier by the recording machine. These code patterns, when read by the "mother" machine, result in the creation of an electronic pulse that causes the machine to react in accordance with the instruction indicated by that pulse.

The most common everyday illustration of pulse control is the dial telephone. When a number is dialed, a small contact under the dial makes and breaks a circuit the number of times called for by the dialed number. The circuit make-and-break causes a stepping relay to move to the numeric position of the number. When a person finishes his complete number dialing, the encoded positions of the stepping relays are decoded into a single pulse. This causes the called telephone to be connected with the calling phone and to ring. All source data machines operate on the encoding-decoding principle, and decoded pulses cause—

Reading	Calculating
Writing	Recording
Controlling	Verifying
Communicating	Language Conversion

The electric pulse is identical for a given code pattern of a given carrier, whether transmitted over long distances or short distances—

From Washington, D.C., to San Francisco, Calif., via wire or wireless.

From one machine in a room to another machine in the same room.

From one end of a machine to the other end.

INFORMATION CAPTURE

When Jean Emile Baudot invented the native language and the machine to "automate" sending messages over the telegraph wire,

there was only one mode of capturing data, the deliberate creation of the punched paper tape by the manual depression of the keys of a punching device. But, with today's modern equipment, three major modes are available for capturing the selected data in the native language of the machines to be used:

- Deliberate creation.
- Byproduct creation.
- Conversion creation.

The machinery may be capable of performing in more than one mode. For example, a machine which punches a tape as a primary function may also be capable of producing a second byproduct tape in the same or different native language. (See ch. IV.)

Source data automation attempts to obviate person-to-person processing by substituting machine-to-machine, as shown in chapter V. Most of the machines involved have been pictured and described in the National Archives and Records Service handbook titled *Source Data Automation Equipment Guide*, which should be used to supplement this handbook. (Federal Stock No. 7610-059-2773)

Machine-to-machine processing came of age with the advent of converters. These machines can translate or convert any native language into any other native language. They can, for example, convert the native language of the punched tape typewriter to the native language of the punched card, if such conversion is required for completing the paperwork cycle. Some of the common converters are:

Paper Tape

- Any number of channels of paper tape to any other number of channels of paper tape.
- Any variety of paper tape to any variety of punched card.
- Any variety of paper tape to any variety of magnetic tape.
- Any variety of magnetic tape to any number of channels of paper tape.

Punched Card

- Any variety of punched card to any other variety of punched card.
- Any variety of punched card to any number of channels of paper tape.
- Any variety of punched card to any variety of magnetic tape.

Tag

- Any variety of punched tag to any variety of punched card.
- Any variety of punched tag to any variety of paper tape.

APPLICATION OF SOURCE DATA AUTOMATION

Finding a paperwork function or type of operation in which some Federal agency has not applied the principles of source data automatic would be difficult.

The potential applications are limited principally by the imagination of the person who studies an existing paperwork cycle. Successful applications have been developed in property and supply management, personnel management and statistics, production planning and control, work measurement and reporting, fiscal management and accounting, as well as in the major substantive functions performed in Federal agencies. Over 70 representative applications are contained in the National Archives and Records Service handbook *SDA Systems*, that supplements this handbook. (Federal Stock No. 7610-985-7272)

Source data automation can bring the advantages of mechanical or electronic operation to all levels of an organization. It can ease the paperwork burden in the small office as well as in the large one involved in voluminous and complicated tasks. It can be developed---

- For any size operation.
- In stages, a step at a time.
- For utilizing dissimilar office machines in "teams."

- As a direct means for communication with the more complex electronic computer.

BENEFITS OF SOURCE DATA AUTOMATION

New achievements are possible for the office with source data automation. It can help integrate communications. To management it provides the ability to systematize operations. It supports forecasting with methodically developed data. Such data are not the result of mere coordination of clerical tasks; it is the result of thorough dovetailing of procedures and functions. This integration often crosses department, agency, or bureau organization lines. It makes the work of all easier, quicker, and more effective.

Tangible benefits include---

Savings--Labor costs, the greatest part of paperwork expense, are reduced.

Accuracy--Errors are decreased or eliminated, as automatic production is more reliable than manual.

Speed--Processing time in the complete paperwork cycle is reduced, as automatic production is faster than manual.

Better Information--More efficient systems are possible since data recorded at birth was used for all processing steps.

Better Decisions--Fast and accurate decisions are based on up-to-date information.

II. HOLES AS THE NATIVE LANGUAGE

When holes are used to obtain the common language pulse, mentioned in the introductory chapter, four types of carriers are available for source data automation applications:

- TAPES
- CARDS
- TAGS
- COUPONS

Each carrier uses its own code structure. Differences in code structure occur among similar pieces of equipment, using the same carrier, when made by different manufacturers.

TAPES AS CARRIERS

Paper tapes were used as early as the 1870's for sending messages over a wire and for playing back the message. Glossaries define many kinds of tape—read-in, readout, feed, by-product, master, program, chadless. Any appreciation of what source data automation can do depends on an understanding of tape.

The Physical Characteristics of Tape

Width. In a set of the different tapes used by the various machines which operate from or produce tapes, the differences in width would be noted at once. The basic widths are as follows:

- $\frac{1}{16}$ inch 5-channel communications equipment.
- $\frac{1}{8}$ inch 6- and 7-channel equipment.
- 1 inch 7- and 8-channel equipment.
- 3 inches to $8\frac{1}{2}$ inches. Edge punched cards (wide tape) for 5-, 6-, 7, or 8-channel equipment.

Color. Punched paper tapes were once produced in one color—light beige. Today, as an aid to identifying different tape contents or distinguishing security classification, tapes can be produced in many colors. Popular colors include beige, pink, blue, green, yellow, and white.

Oiliness. Originally all tapes used in the communications industry were impregnated

with oil to give added strength to the paper and increase the resistance to wear. This oil-impregnated tape served the purpose until someone tried to file the tape away for a period of time—perhaps with some other papers. Then problems appeared, as the tape bled oil on any absorbent material it touched. Today many nonbleeding tapes are manufactured that have the same durability and resistance to wear as the bleeding varieties. They are impregnated with an oil that will not transfer to other papers they might contact. If bleeding tapes are filed for any period of time, special filing arrangements must be provided to protect other papers.

Durability. Several different weights (thicknesses) of tape are available today, the thinnest at the lowest prices and increasing in cost as the thickness increases. For extreme durability Mylar tapes are also available, two layers of paper with a layer of Mylar plastic between them. Mylar tape has the highest cost per roll. Selection of tape for durability characteristics should be based on—

- Value of the tape content.
- Number of times tapes will be used.
- Number of handlings of the tape.

Forms of Tapes. The tape originally used by the communications industry was available only in rolls. Since the tape used in source data automation may be filed for long periods of time between uses, some means of filing, other than as a roll, is frequently desirable. Tapes can be purchased today in flat folds or fanfolds of varying length. Almost any length fold can be ordered. Wide tape (edge punched cards) is available as a single card for a unit record of a predetermined length or as a continuous fanfold for records of unknown length. (See fig. 1.)

Number of Channels

A specific location in the space across the width of a tape is called a channel or level of punching. Coding is accomplished through punching a hole or series of holes in specific channels. Each

WIDE TAPE (Edge Punched Cards)

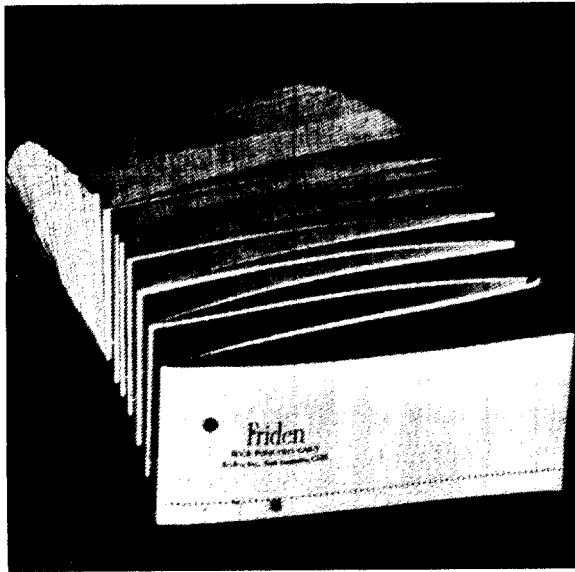

Fig. 1

7-channel tape— 2^7 —128 different patterns.
8-channel tape— 2^8 —256 different patterns.

TAPE PUNCHING LEVELS

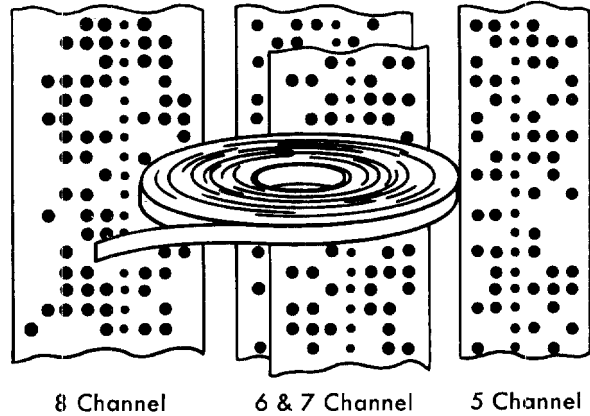

Fig. 2

pattern of holes represents a character, digit, or function of the machine.

There are four different levels of punching available. (See fig. 2.) The maximum number of code patterns which can be punched into the various levels of paper tape is expressed by a single mathematical formula:

5-channel tape— 2^5 —32 different patterns.
6-channel tape— 2^6 —64 different patterns.

Since 26 alphabetic characters, supplemented by 10 numeric digits, are used to transmit the English language, a bit of hasty mathematics shows that the 5-channel tape is inadequate, 32 possibilities as against 36 needed.

To overcome the shortage of codes, the communications industry resorts to a technique called precedent punching. One of the combinations is reserved to signal the machine to shift to "uppercase," which includes punc-

STANDARD TELECOMMUNICATIONS
CODE FOR 5 CHANNEL TAPE

	-	?	:	\$	3	*	&	£	8	B E L	()	.	,	9	0	1	4	▼	5	7	;	2	/	6	"	S O P A P	F I G S	L I N E S P R I N T	L E T T E R S	C U R L E R	B L A N K	
	A	B	C	D	E	F	G	H	I	J	K	L	M	N	O	P	Q	R	S	T	U	V	W	X	Y	Z							
1	●	●	●	●	●	●	●	●	●	●	●	●	●	●	●	●	●	●	●	●	●	●	●	●	●	●	●	●	●	●	●	●	●
2	●	●	●	●	●	●	●	●	●	●	●	●	●	●	●	●	●	●	●	●	●	●	●	●	●	●	●	●	●	●	●	●	●
3	●	●	●	●	●	●	●	●	●	●	●	●	●	●	●	●	●	●	●	●	●	●	●	●	●	●	●	●	●	●	●	●	●
4	●	●	●	●	●	●	●	●	●	●	●	●	●	●	●	●	●	●	●	●	●	●	●	●	●	●	●	●	●	●	●	●	●
5	●	●	●	●	●	●	●	●	●	●	●	●	●	●	●	●	●	●	●	●	●	●	●	●	●	●	●	●	●	●	●	●	●

Fig. 3

ADDRESS PORTION OF A TYPICAL TELECOMMUNICATIONS MESSAGE TAPE

Carriage Return	Line Advance	Letters	J	O	H	N	Space	D	O	E	Carriage Return	Line Advance	Figures	4	3	Space	Letters	R	Y	E	Space	S	T	R	E	E	T	Carriage Return	Line Advance
		●	●					●		●			●	●			●	●	●		●			●	●				Channel 1
	●	●	●									●	●	●			●	●						●				●	Channel 2
	●	●	●	●	●	●	●	●	●	●	●	●	●	●	●	●	●	●	●	●	●	●	●	●	●	●	●	●	Feed Holes
		●			●	●	●								●	●	●	●			●	●						Channel 3	
●	●	●	●		●	●	●	●	●	●	●	●	●			●	●							●			●	Channel 4	
	●	●	●	●				●				●					●	●				●				●		Channel 5	

Fig. 4

tuation, numerals, and special symbols. Another combination is reserved to signal the machine to shift to "lowercase," which contains the alphabetic characters in all capitals. Still other combinations are reserved for space, line feed, and carriage return. The code structure (combinations of holes) used by the communications industry is illustrated in figure 3.

With the precedent punching technique, the communications industry increased the coding capacity of 5-channel tape to 52 possible combinations for characters, numbers, and punctuation marks—still leaving 6 code combinations to control certain machine functions. The items marked **FIGS** and **LETTERS** in figure 3 are the precedent punching codes for numeric or alphabetic entries.

To send a message via the telecommunications code, the operator first punches the desired precedent code. Then the operator punches one or more carriage returns and line advances to get blank paper in front of the keys of the receiver and to position the carriage at the beginning of a line. The operator then proceeds to punchout the message. Figure 4 illustrates the address portion of a typical message punched in tape. Figure 5 illustrates how this address would appear when typed by the receiver on a telecommunications circuit.

The five-channel code, the same basic code developed by Jean Emile Baudot in 1870, satisfied the communications industry—and still satisfies it today. When an attempt was made to apply the tape-producing typewriter

ADDRESS AS TYPED BY THE TELECOMMUNICATIONS RECEIVER FROM THE ABOVE TAPE

JOHN DOE
43 RYE STREET

NOTE: The numerals 4 and 3 are identical in code structure to the alphabetical characters R and E. They would have been received as letters except that they had been preceded by the precedent punch for FIGURES. Also, note that all alphabetical characters are capital letters.

Fig. 5

to other operations, however, it was discovered that some things the typewriter can do could not be done by the telegraph equipment. The message was limited to capital letters, for example.

Modern source data automation obviously requires more than the 32 basic codes provided by the 5-channel tape. Capital and lower-case alphabet, punctuation, special characters, and machine control codes are needed. Tapes with six, seven, and eight channels meet these requirements. No standard arrangement for the code designations exists. Figure 6 illustrates the most commonly used eight-channel paper-tape code configurations.

Advantages of Wide Tape

Short bits of information, used repetitively, are hard to file and find in rolls of tape. Interpretation, that is translation, onto the tape of the meaning of the holes in the tape is done by very few machines—thus data are blind in most tapes. Relevant data, other than that to be processed by machine, cannot be made part of the tape.

Wide tape overcomes most of these difficulties. Wide tapes were designed to store coded information, with additional space allowed for written information. They are easily filed in conventional card-filing equipment. Wide tapes may be of almost any size, style, or shape—provided sufficient space is available along the edge to contain the five-, six-, seven-, or eight-channel code structure to be used. Samples of wide tapes are shown in figure 7.

Some of the advantages of wide tapes over rolled or folded narrow tapes are:

- Small bits of data can be found more readily.
- Small bits of data can be filed more easily.
- Interpretation (translation of the punched holes) can be printed.
- Identification of the contents by filing or locating symbols can be included.
- Instructions for use, and other pertinent handling information, can be placed on wide tape.

- Relevant data, other than that to be “machined,” can be written on wide tape.
- Wide tape can be filed “visually” in any visible records system for quicker filing and finding.

COMMON EIGHT CHANNEL PAPER TYPE CODE CONFIGURATION

CARD PUNCH	8 Channel								AUTOMATED TYPEWRITER
	8	7	6	5	4	3	2	1	
0 (ZERO)			6		*				(ZERO) 0 - 1
1					*			1	1 -
2					*		2		2 @
3				5	*		2 1		3 #
4					*	3			4 \$
5				5	*	3	1		5 %
6				5	*	3	2		6 ^
7					*	3	2 1		7 &
8					4	*			8 *
9				5	4	*		1	9 (
A		7	6			*		1	a - A
B		7	6			*	2		b - B
C		7	6	5		*	2 1		c - C
D		7	6			*	3		d - D
E		7	6	5		*	3 1		e - E
F		7	6	5		*	3 2		f - F
G		7	6			*	3 2 1		g - G
H		7	6		4	*			h - H
I		7	6	5	4	*		1	i - I
J		7	6	5		*		1	j - J
K		7	6	5		*	2		k - K
L		7	6			*	2 1		l - L
M		7	6	5		*	3		m - M
N		7	6			*	3 1		n - N
O		7	6			*	3 2		o - O
P		7	6	5		*	3 2 1		p - P
Q		7	6	5	4	*			q - Q
R		7	6		4	*		1	r - R
S			6	5		*	2		s - S
T			6	5		*	2 1		t - T
U			6	5		*	3		u - U
V			6	5		*	3 1		v - V
W			6	5		*	3 2		w - W
X			6	5	4	*	3 2 1		x - X
Y			6	5	4	*			y - Y
Z			6	5	4	*		1	z - Z
SPACE				5	*				SPACE
/		7	6	5		*		1	/ ?
#			6	5		*		1	#
\$		7	6	5	4	*	2 1		\$
.			6	5	4	*	2 1		.
,		7	6	5	4	*	2 1		,
@			6	5	4	*	3		@
%			6	5	4	*	3		%
^		7	6	5	4	*	3		^
&		7	6	5	4	*	3		&
*		7	6	5	4	*	3		*
(7	6	5	4	*	3		(
[7	6	5	4	*	3		[
&		7	6	5	4	*	3		&
SKIP			6	5	4	*	3 2		SKIP
END CARD 1				4	*	3 2			END CARD 1
END CARD 2			6	4	*	3 2 1			END CARD 2
COR. TAB				5	4	*	3 2 1		COR. TAB
ERROR		7	6	5	4	*	3 2 1		ERROR
PI - 1				5	4	*	2		PI - 1
PI - 2		7	6	5	4	*	2		PI - 2
PI - 3			6	5	4	*	2		PI - 3
PI - 4			6	5	4	*	3 1		PI - 4
PI - 5		7	6	5	4	*	3 1		PI - 5
PI - 6		7	6	5	4	*	3 1		PI - 6
PI - 7				4	*	3 1			PI - 7
SP - 1		7	6	5	4	*	2		SP - 1
SP - 2		7	6	5	4	*	3 2		SP - 2
CR		7	6	5	4	*	3 2		CR
TAPE FEED		7	6	5	4	*	3 2 1		TAPE FEED
END LINE	8					*			END LINE
	EL	X	O	CH	8	*	4	2 1	

Fig. 6

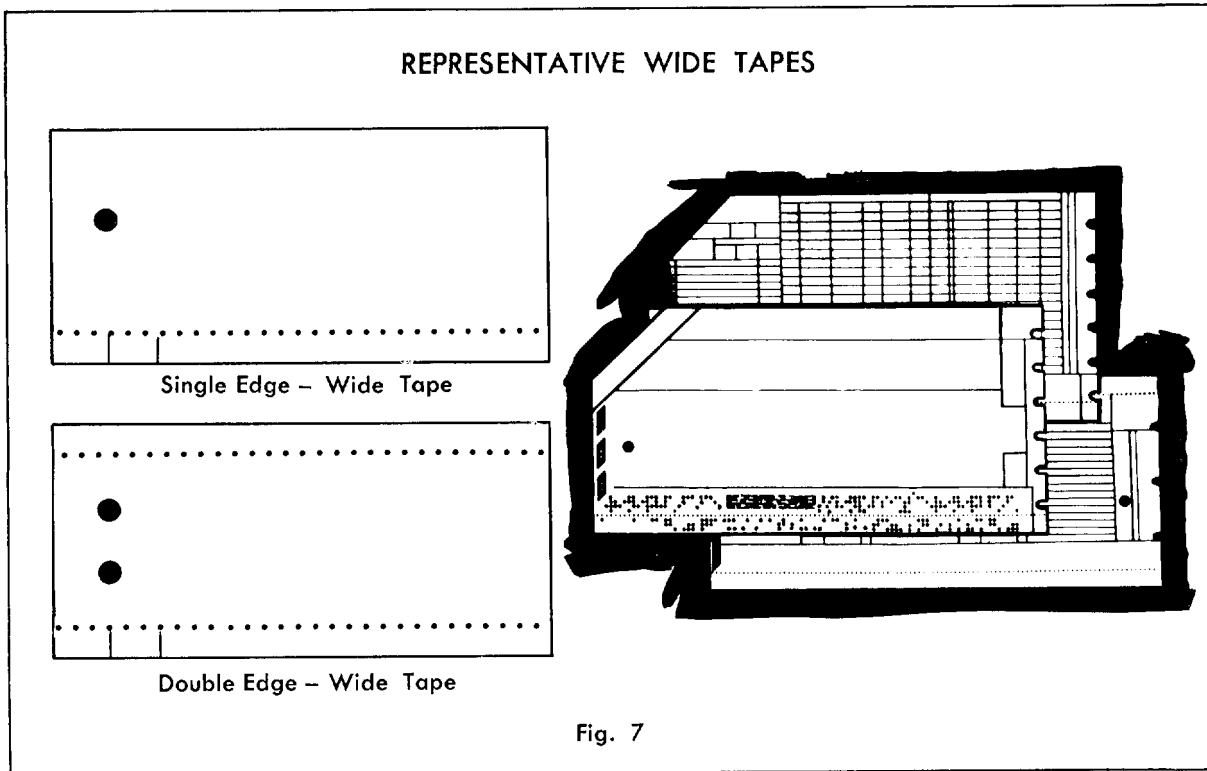

Wide tapes of the conventional 3- by 7-inch fanfold variety are supplied in boxes of 1,000 each. They may be torn apart into unit records of one or more 7-inch lengths, to fit the job requirements. They may be cut apart by a precision cutter which removes one code position at the beginning of each series of cards. Wide tapes of almost any dimension, limited in size only by use and filing requirements, can also be obtained. These cut cards must have the prepunched feed holes needed for source data automation equipment.

PUNCHED CARDS AS CARRIERS

The first punchcard equipment made its appearance around 1890. At that time the equipment was designed for the production of numeric statistics only. Sensing a hole punched in a card actuated dials or counters which recorded selected statistical factors.

For the next 25 to 30 years improvements were introduced and usage gradually widened. Printing machines were produced to write the statistical data. Alphabetic information was added to the card and to the printouts. Counters were added to permit limited mathematical operations.

Today, punched cards are employed in a multiplicity of operations of a numeric, alphabetic, or alphanumeric nature. New capabilities are constantly being added to already existing machines, or completely new machines are being marketed. Speeds have increased over the course of time, and more prompt and timely reporting is achievable.

The Physical Characteristics of Cards

Size. A set of the different cards used by the various machines which operate from or produce cards includes the following sizes:

7 $\frac{3}{8}$ inches wide by 3 $\frac{1}{4}$ inches long—

Used for the 80-column International Business Machines Corp. card and the 90-column cards of the Sperry Rand Corp. (formerly Remington Rand, Inc.).

Any width less than 7 $\frac{3}{8}$ by 3 $\frac{1}{4}$ inches long.

Used as a detachable coupon from either the International Business Machines or the Sperry Rand card.

Color. The most common color is white. For distinguishing different decks of cards,

for identifying special-purpose cards, and for visual spot checking, cards may be obtained in almost any color; white, salmon, yellow, green, blue, and red predominate. In addition, striped cards can be procured which have a narrow band or stripe of color across the top edge of the card. Combining stripes and card colors affords all needed color distinction.

Shape of Holes. The code structure used by the International Business Machines Corp. is punched into 80-column cards in rectangular holes. Sperry Rand expresses code structure in round holes. Because of differences in the code structure and in the internal mechanisms of the various machines, a card punched with rectangular holes cannot normally be used in a round hole machine, or the reverse.

Fields. In planning the use of any card, the number of columns available in the card is divided into fields. A field is a column or group of columns reserved to record a certain kind of alphabetic or numeric data. For example, columns 1 through 23 could be reserved for employee names; columns 24 through 30 for employee number.

Card Stock. The holes in the cards must be sensed by the machines through which they pass. This is accomplished—

- Electrically with cards containing rectangular holes.
- Mechanically with cards containing round holes.
- Photoelectrically with cards containing round holes.

In the electrical process, figure 8, the card passes over a metal roller and under a series of metal brushes. As a metal brush feels a hole, contact is made with the roller, thus completing an electrical circuit. Completing the circuit sends a pulse to tell the machine what function to perform. The pulse is identified in the equipment by—

- Location of the brush; that is, the column of the card.
- Timing of the pulse corresponding to the position of the hole; that is, the 4 position.

Since the contact between the brush and the roller is important to operate the machine, a contact must not be made unless there is a

hole in the card. Thus, cards must be non-electrical conducting and free of carbon spots.

In the mechanical process, metal pins pass through the holes in a card and activate mechanical devices to perform a specified function; the metal pins are stopped by the card when there is no hole.

In the photoelectrical process, cards are light sensed. Cards pass over a bank of photoelectric cells above which is positioned a bank of lights. If a hole exists in the card, light is passed and the machine is actuated.

Thickness of the card is critical in all processes, as each machine must be able to separate one card from the next card rapidly. Thus all card stock is of a uniform thickness, adequate to provide strength and durability.

Code Structure

The native languages of the 80- and 90-column cards are different. Since the number of columns in the card is interrelated to the code structure of these native languages, each card column capacity must be discussed separately.

80-Column Card. From left to right, columns of the card are numbered 1 through 80. Each column contains 12 possible punching positions, or locations for holes. The punching positions are identified, starting from the bottom of the card with 9 and proceeding back through 0 in numerical regression. The 11th punching position, known to the trade as the 11 or X position, is located above the 0 position. The 12th punching position, known as the 12 or R position, is located above the 11th. Positions 1 through 9 are known as digit positions; X and R as zone positions; and 0 as a digit or zone position depending upon its use.

In the native language, a digit is represented by punching a single hole in the appropriate digit position in a column of the card. The alphabet is represented by punching a hole in a zone position and a digit position in a single column of the card. Symbols are represented by combinations of zone and digit position punches in a single column of the card. Figure 9 illustrates the code structure, the native language of the 80-column card.

Zone punches (X and R positions), without any accompanying digit position punch, are also frequently used for card identification or for control of certain machine functions.

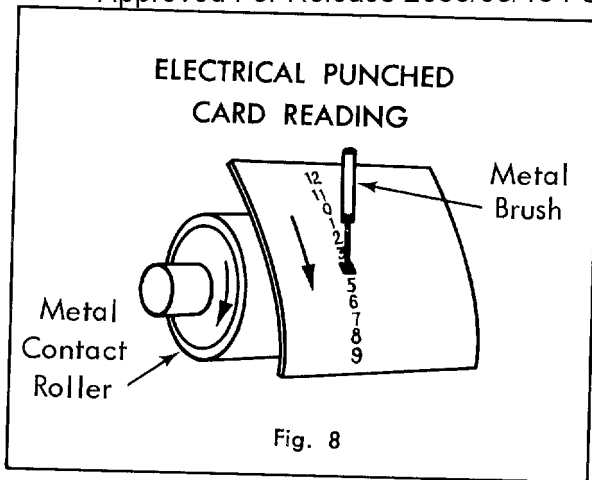

Fig. 8

90-Column Card. The card is first divided into two halves horizontally. The upper half contains columns 1 through 45, from left to right. The lower half contains columns 46 through 90, from left to right.

Each column, in each half of the card, has six possible punching positions—locations for a hole. The punching positions are identified, starting with the bottom of each column, as the 9, 7, 5, 3, 1, and 0 positions.

The code structure, native language, is punched into the cards as follows:

NUMERIC INFORMATION

Odd-Numbered Digits and Zero—
A single hole in the position of the number desired.

Even-Numbered Digits—
A hole in the 9 position and a second hole in the position one number lower than the number desired. Hence holes in the "9" and "1" positions give "2," and holes in the "9" and "5" positions give "6."

ALPHABETIC INFORMATION

A combination of two or three holes in a single column gives an alphabetic character. Ten characters use 2-hole combinations, and the remaining 16 use 3-hole combinations.

Figure 10 illustrates the code structure, the native language of the 90-column card.

CODE STRUCTURE FOR 80 COLUMN PUNCHED CARD

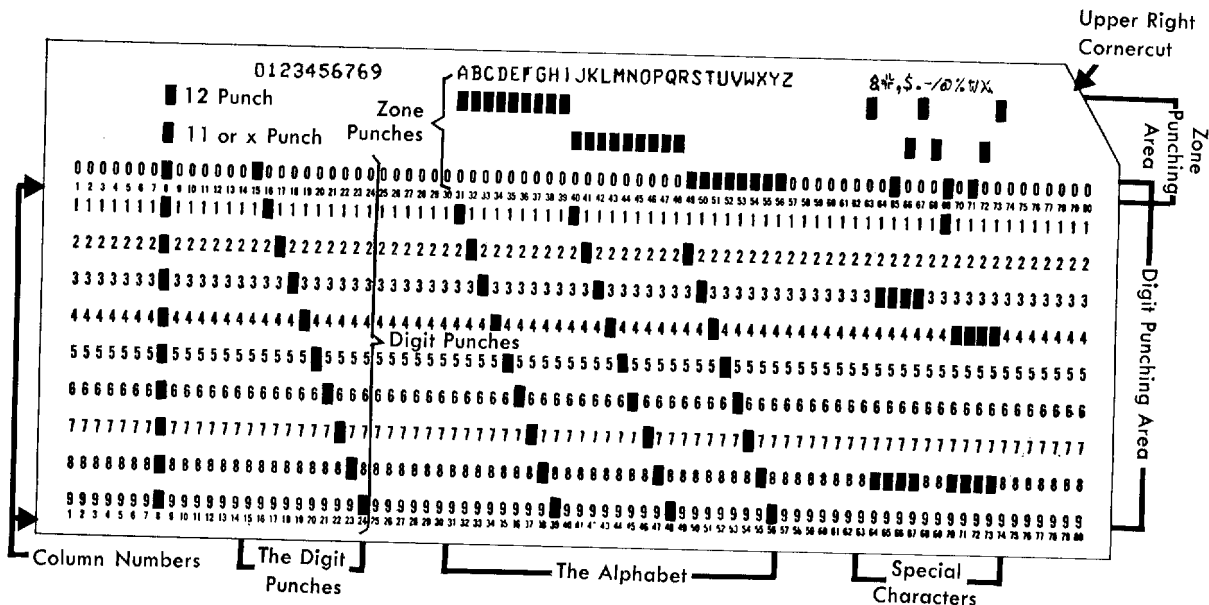

Fig. 9

CODE STRUCTURE FOR 90 COLUMN PUNCHED CARD

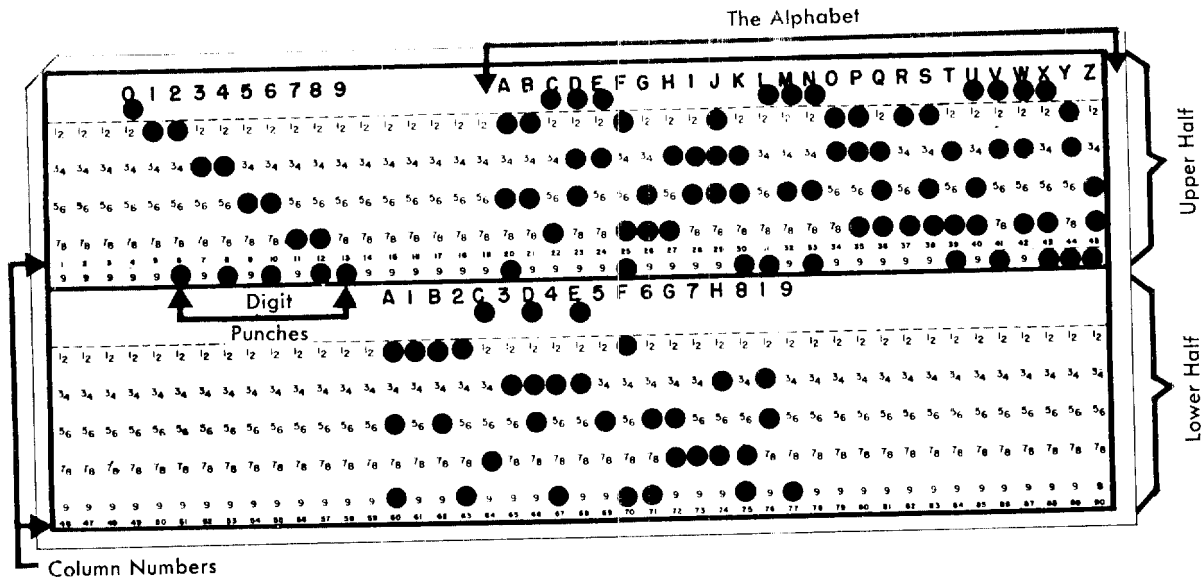

Fig. 10

TAGS AS CARRIERS

The newest method of source data automation is the print-punch tag attached to many items in modern department stores. The tag contains a series of small holes, the native language, as well as printed information identifying the user and the item to which the tag is attached.

The tag may be a single part (one stub) or several parts (two or more detachable stubs), depending upon the procedures developed for the user. The holes in the tag represent selected data which the user requires for automated operations.

Although most of the applications for print-punch tags have been in the merchandising of material from a store to a customer, applications are not limited to this field. Inventory control, manufacturing records, production control, material inspection, and piecework payroll have successfully utilized tags as the medium of source data automation. Print-punch tags are particularly useful when small size or ability to withstand heavy abuse are important factors.

The Physical Characteristics of Tags

Size. A set of the different tags used by the various machines which operate from or produce tags would include—

	<i>Dimensions of tag (in inches)</i>	<i>Number of tags to a set</i>
Small.....	2.2 by 1.....	2 to 6.
Medium.....	2.7 by 1.....	1 to 10.
Large.....	3.2 by 1.....	1 to 10.

Color. Most tags are produced in white. Since most tags are printed with at least the identification (name and address) of the user, colored stripes of all varieties can be obtained for color-coding purposes.

Stock. Tags must withstand frequent handlings by customers, store employees, or production workers. They must frequently be re-marked to reflect price adjustments. Accordingly tags are produced on card stock 13 points in thickness (0.0013 inch thick). Extra heavy tags of 15 points thickness can be procured to meet abnormal conditions. Tag stock can be coated with or impregnated with various waxes or chemicals. Such coating permits the tags to be attached to items of manufacture, for production control, while these items are being processed through the assembly and production lines.

Capacity. Capacity of a tag is measured in two areas—printing and punching. Maximum

capacities are as follows:

	<i>Digits of information</i>	
	<i>Punching</i>	<i>Printing</i>
Small tag.....	20	37
Medium tag....	25	47
Large tag.....	31	59

If tags are to be converted to cards or tape, and data are to be added which is not punched into the tag, the first space from the left of the tag must be reserved as a control column.

Printing is accomplished by setting dials on equipment developed to print and encode the tags simultaneously. Items which are encoded in the punched holes of the tag may be printed or not printed, as determined by needs of the user. If the user is willing to forego using 10 digits of printed information on the tag, provision can be made to substitute logotype printing (slugs of type containing fixed descriptions) of such things as fiber content and fiber name.

Figure 11 is an illustration of upper and lower line printing on the large tag. The amount of data that can be included on a tag by well-planned coding is noteworthy.

LARGE PRINT-PUNCH TAG
WITH UPPER & LOWER LINE PRINTING



Fig. 11

Punched Code

The code structure, native language, for recording selected data in the tag is similar to the five-channel code structure used in the communications industry (described under the discussion of tape). Five small holes, in a vertical line, represent a single digit of data. Punching is numeric only.

Processing Tags

Within the maximum capacity of the tag, all identifying data known about a unit of merchandise can be punched in five-channel code. This recording is done to permit picking up these data after the item has been sold. At present, no known equipment will directly process from print-punch tags. Conversion to another of the native languages, punched cards, paper tape, or magnetic tape, is necessary. Data encoded in the print-punch tag may be processed by--

- Conversion to punched card, paper tape, or magnetic tape by an off-line converter.
- Conversion to paper tape or magnetic tape at the time of sale by using a point-of-sale recorder. Supplementary data, such as salesperson, date, or price, known only at the time of sale may be added to the tape simultaneously.

Since the print-punch tag may be multipart, several conversions may be necessary in a paperwork cycle, each conversion serving a specific purpose in the overall procedure. Figure 12 illustrates a multipart tag which could require two conversion operations.

COUPONS AS CARRIERS

The average American homeowner, car owner, or installment buyer is aware of the perforated coupon as a method of source data automation. The amounts, dates, and payment numbers, which are perforated in the coupon, are readable.

The perforated coupon has been in use for a long time. It has been common in banks, finance companies, mortgage companies, and department stores for many years. Recent improvements have expanded the potential of coupons as a means of source data automation. These improvements now deserve attention in a number of areas of Government paperwork.

Perforations, it must be remembered, are in the native language of the human eye, since they form readable characters and figures. Today machines are designed to read and translate these data into a native machine language for processing the coupon.

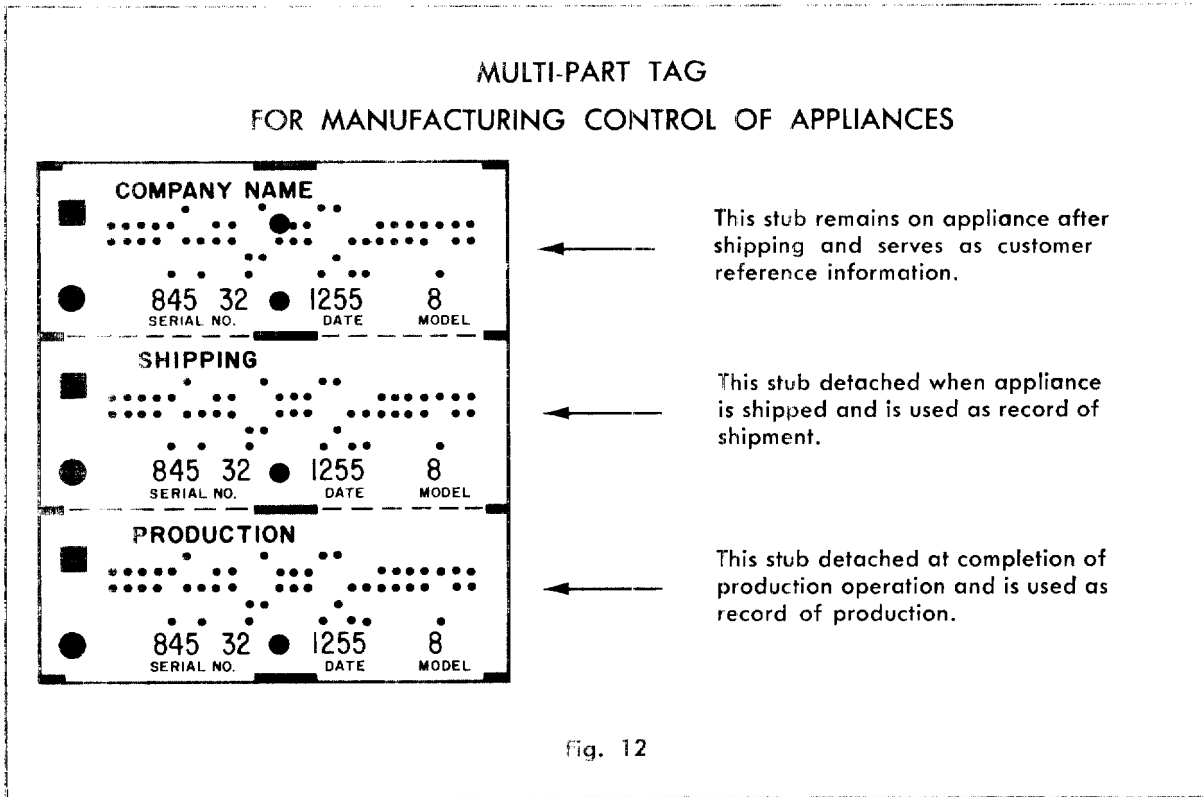

The Physical Characteristics of Coupons

Size. A representative set of the different coupons used would show wide divergence in size. Any size paper adequate to contain perforations read by the human eye can be processed through coupon-reading machines. Figure 13 shows a typical coupon.

Methods also have been developed for including selected data, not readable to the human eye, in the coupon in a native machine language. Capacity of the coupon to store data has been increased.

Coupon Stock. Almost any weight of paper, suited to the purpose, can be used as a coupon. It is well to remember, however, that books containing multiple coupons are all perforated simultaneously. Thus, a heavier weight paper may reduce the number of coupons produced in one perforating operation. The average perforator can generate 20 coupons in 1 operation.

Perforating Code

The in-line code of the five-channel variety similar to the native language of the communi-

cations industry can be included in the coupon. In the financial world, for example, the five-channel code can contain selected data of interest to the financier but not readable by the borrower. Figure 14 illustrates some in-line five-channel coding as contained in a coupon.

To permit the machines to read numeric information—information perforated for the

A TYPICAL COUPON (about 1/4 actual size)

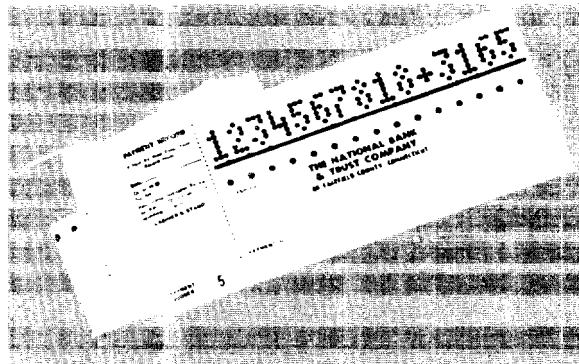
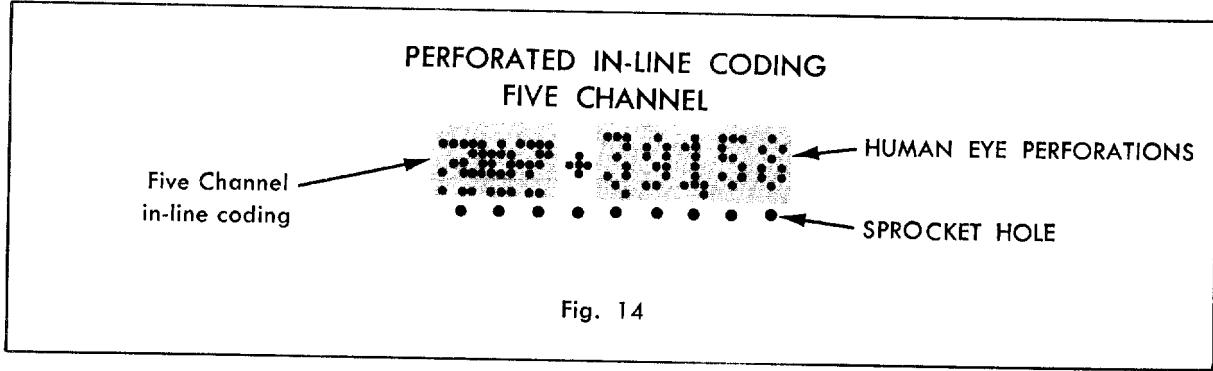

Fig. 13



human eye—the five-channel in-line code pattern is spread into three adjoining columns instead of a single vertical column. Figure 15 illustrates the method of accomplishing this spread into three columns. The complete digital pattern for three-column coding—the native language of the perforated coupon—is illustrated in figure 16. For visual reading, seven channels are perforated. However, for mechanical reading, only five of the channels are utilized.

Comparing the digit reading pattern (three-column code) with the in-line reading pattern (five-channel code) indicates that very little difference exists. As a result, coupon-reading equipment can perform dual reading tasks, switching from one reading pattern to the other upon receipt of a switching symbol. This symbol serves in the same manner as the

precedent symbol for the tape machines.

Figure 17 illustrates a technique for combining into one set of perforations the code for both the three-column reading and the five-channel reading.

Processing Coupons

Sorters are available to place randomly received coupons in account number order for processing. Readers are available to sense the native language of the coupon and emit the pulse for translation of the holes into the native language of paper tape, punched card, or magnetic tape. During processing, some additional data may be encoded in-line, five-channel code, onto the coupon by some model readers. Beyond the sorting and reading, all other processing is done after conversion to another native language.

READING PATTERN COMPARISON BETWEEN 5 CHANNEL PUNCHED TAPE AND PERFORATED CHARACTERS

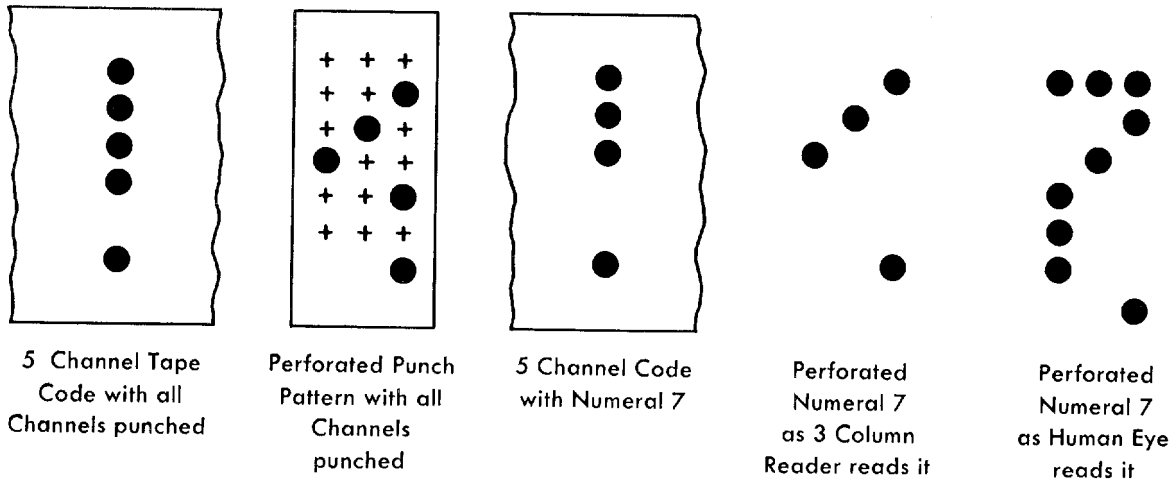

Fig. 15

PERFORATED CHARACTER CODES
(3 COLUMN READER)

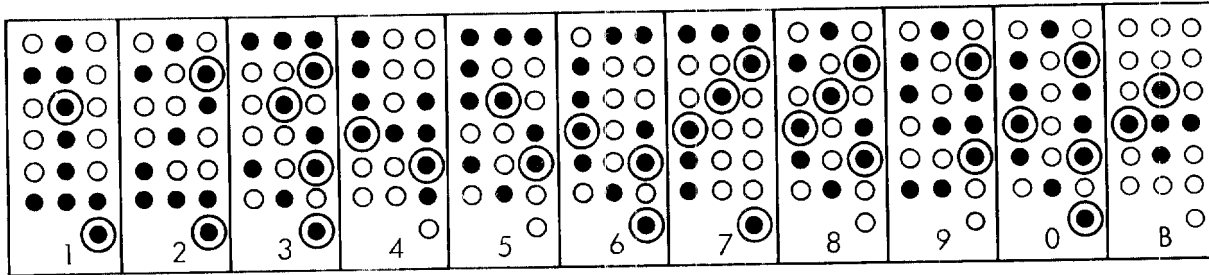
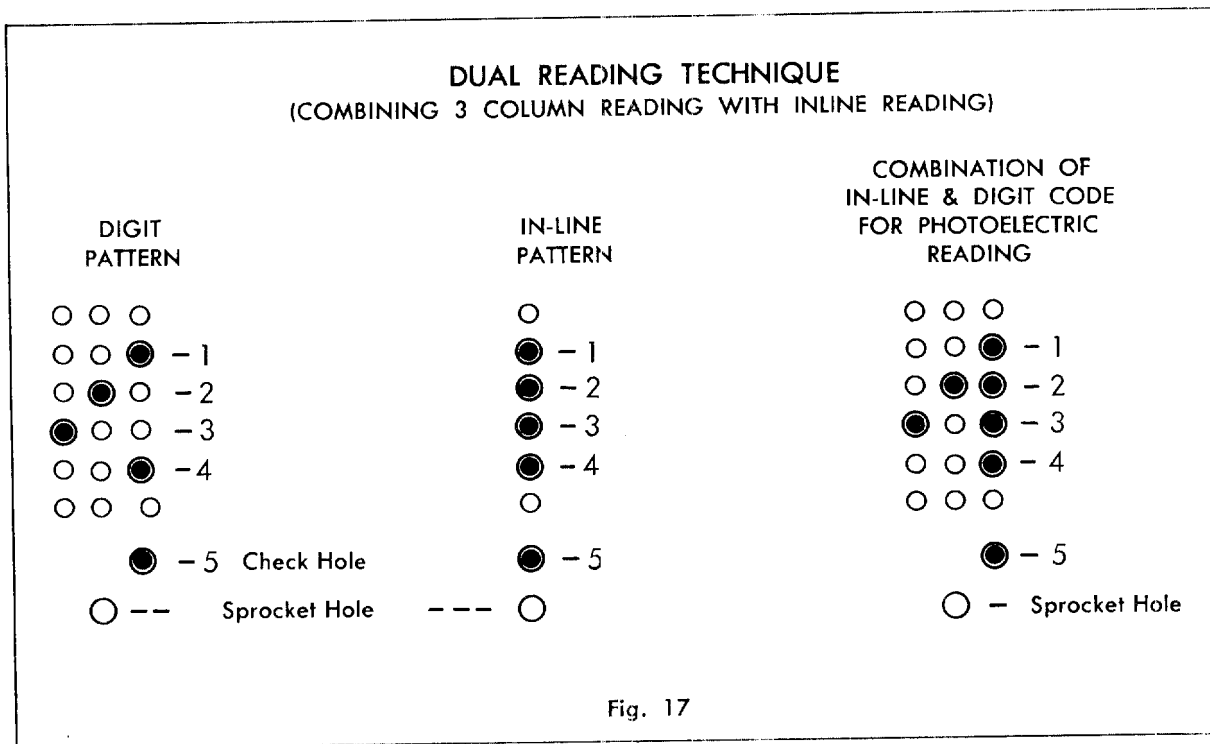

Fig. 16

NOTE: Only the circled black dots are read by the three column reading mechanism



III. THE NATIVE LANGUAGES OF READING MACHINES

Native languages are not limited to holes. There are machines that read text, or read characters (as those in magnetic ink on bank checks), or read dots and dashes (bars) placed on documents by credit card imprinters. They read the print and convert it into the native language of the machines involved so that the machines can talk to each other.

Many people believe that these machine reading methods open up an entirely new vista of opportunity for source data automation. Collectively they are often referred to as scanning methods, or optical character recognition.

For a native language, one of the following types of objects will be read:

- DOTS
- BARS
- SELECTED TYPE FACES
- MAGNETIC INK

DOTS AS A NATIVE LANGUAGE

At this time, two machines use dots as a native language. One is known to the trade as FOSDIC, Film Optical Sensing Device for Input to Computers, and is owned and operated by the Department of Commerce, Bureau of the Census. The other is known as DocuTran and is owned and operated by Science Research Associates, Inc.

FOSDIC was used in the 1960 Census of Population and Housing, one of the world's largest statistical operations. The individual census enumerator obtained information concerning a person, a family, and housing facilities. He received the information (data) orally from the householder or in a written form on documents which had been previously mailed to the householder. The data were recorded by checking boxes or by writing dates or other facts on a conventional form.

In the quiet of his home, the enumerator transcribed data from the conventional form on which it was recorded to a form specially designed to capture the native language of FOSDIC. Transcription was accomplished by

filling in the small circles under the appropriate columns on the special form, figure 18.

After the recording of data on the special forms was completed, they were microfilmed. The negative microfilm was processed through FOSDIC, whose electronic circuitry translated little dots of light (negative appearance of a filled-in circle) into a pulse for recording directly onto magnetic tape.

The pulse was created at the rate of 1,000 spots per second for translation to the native language of the computer. Data recorded by the enumerator at the source were used to feed a computer.

The black rectangles on the form, figure 18, serve one or more of the following purposes:

Tilt Marks—To permit FOSDIC to determine how the microfilm image is aligned in relation to its scanner mechanism.

Size Checks—To permit FOSDIC to adjust for slight variation in microfilm reduction ratios.

Index Checks—To permit FOSDIC to position its scanning beam on a field of data.

Special form techniques had to be developed to record certain data in the native language of FOSDIC. Section P6 of figure 18 indicates how *birth date* had to be recorded, in lieu of writing six Arabic digits as normally used.

The DocuTran System of Science Research Associates, Inc., varies principally from FOSDIC in the direct use of the paper documents as input, instead of microfilm images.

Forms, used as input to DocuTran, may be a minimum size of 5 by 3 inches; a maximum of 8½ by 11 inches. Each position for recording data is indicated by a tiny printed circle. Data are recorded by filling in a circle with a common pencil. On a maximum size form there are 5,320 possible positions (called response positions) for recording data. Several positions may be dedicated to a multiple-choice answer and as such are called a field. Figures 19 through 21 illustrate several of the techniques used to record various types of data.

FORM USED FOR FOSDIC RECORDING THE NATIVE LANGUAGE IN DOTS

CONFIDENTIAL—This information is to be used only by authorized personnel. The Census Bureau is not responsible for its use.

U.S. DEPARTMENT OF COMMERCE—BUREAU OF THE CENSUS
1960 CENSUS OF POPULATION AND HOUSING

2. Page No. **5**

Make no mark in this space

FIRST—Copy sample key and address from listing sheet to P1, H1, and E2.

SECOND—Relationship in P3. Before listing "other and out if they have separate quarters. If no ACR, ask: the name of the head of this household? The names of all other persons who live here but is temporarily away? If no ACR, ask: Are there any persons staying here now who have no usual residence elsewhere? I have names now. Is that right?

FOURTH—List ACR, check listing. Ask: Is there anyone else who usually lives here but is temporarily away? If no ACR, ask: Are there any persons staying here now who have no usual residence elsewhere? I have names now. Is that right?

FIFTH—Full P3-P7 for each person.

SIXTH—Check for other units.

EIGHTH—Check for other units. If no ACR, ask: Do any persons live in this building or elsewhere on this property? Are there any vacant apartments or any vacant rooms for rent?

NINTH—Ask about next unit: Name? No. of people? Who home? If vacant—Whom to see?

P1. Sample key

Household head of all "60" persons? (A B C D) GO

Persons listed in order of age

P4. Sex (Male Female)

P5. Color or race (White Negro American Indian Japanese Chinese Filipino Other) Specify other

P6. What is the month of birth (Jan Feb Mar Apr May Jun Jul Aug Sep Oct Nov Dec) Specify other

P7. MARITAL STATUS—Is he now: (Married Widowed Divorced Never married)

Line No. 1 2 3 4 5 6 7 8 9 10

Make no mark in this margin

Fig. 18

When the circles are filled in, the completed paper forms are processed through a DocuTran reader where photoelectrically operated circuitry reads the filled-in circles. Reading sensitivity of the DocuTran can be set for a wide range of mark intensity, thus permitting the selection of the darkest mark in a field of data and the rejection of stray marks and erasures. Circuitry permits reading both sides of a paper document simultaneously. Internal circuitry permits the reader to translate the data into the native language of punched cards, paper tape, or magnetic tape. It can also transmit the data directly to the memory of a computer.

Special considerations have to be given to quality control in printing forms for FOSDIC and DocuTran. In addition, special quality control must be exercised in the production of microfilm copies for FOSDIC.

BARS AS A NATIVE LANGUAGE

Persons with gasoline credit cards may already have seen this media of source data automation.

In such credit cards an arrangement of bars embossed on the card represents the account number. Figure 22 illustrates a typical credit card with bars—the native language—for source data automation of sales information.

Code Structure

The code structure consists of short and long bars to encode numeric data only. The digits

RECORDING NUMERIC DATA FOR DOCUTRAN READER

IDENTIFICATION INFORMATION

ID NUMBER	TEST SERIES	ELIGIBLE PRESENT REGISTER	YEARS CAREER EXPER	BIRTHDATE	
				Month	Year
0 3 2 1 8 5 1 8	18	Yes	10	JAN	1 5
0 3 2 1 8 5 1 8	19	No	10	FEB	1 5
0 3 2 1 8 5 1 8	20	No	10	MAR	1 5
0 3 2 1 8 5 1 8	20	No	10	APR	1 5
0 3 2 1 8 5 1 8	20	No	10	MAY	1 5
0 3 2 1 8 5 1 8	20	No	10	JUN	1 5
0 3 2 1 8 5 1 8	20	No	10	JUL	1 5
0 3 2 1 8 5 1 8	20	No	10	AUG	1 5
0 3 2 1 8 5 1 8	20	No	10	SEP	1 5
0 3 2 1 8 5 1 8	20	No	10	OCT	1 5
0 3 2 1 8 5 1 8	20	No	10	NOV	1 5
0 3 2 1 8 5 1 8	20	No	10	DEC	1 5

Fig. 19

RECORDING ALPHABETIC IDENTIFICATION
FOR DOCUTRAN READER

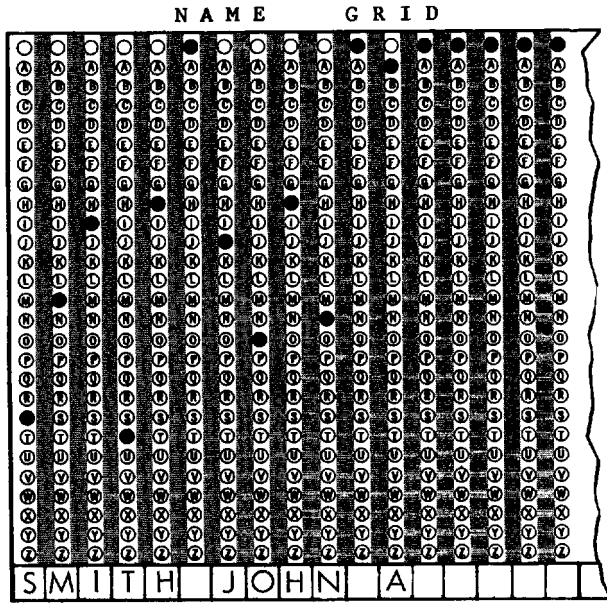

Fig. 20

FIELDS DEDICATED TO RESPONSES TO
MULTIPLE CHOICE QUESTIONS
FOR DOCUTRAN READER

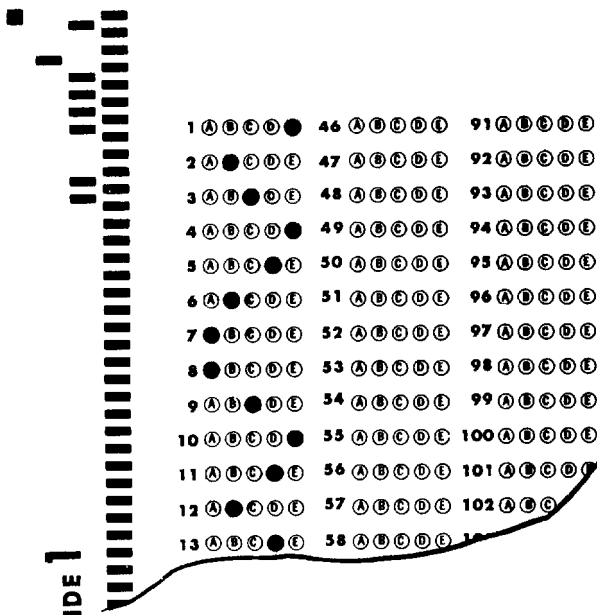

Fig. 21

A CREDIT CARD
WITH BARS FOR NATIVE LANGUAGE

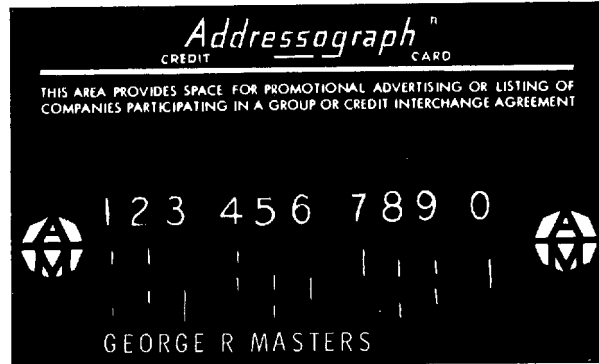

Fig. 22

are designated by the position of the bars. What appears to be a long bar to the human eye is actually read by the machines as two short bars. Thus, the position of one short bar represents the digits and the other short bar serves as a parity check for the reading machine to check on the loss of a bar during transmission of the pulse.

Imprinting Code

The bar code is normally carried in a plastic or metal card in a raised type which permits recording equipment to obtain an impression of the code on a paper form. Data are embossed on the plastic or metal card in bar code and human-readable characters by Graphotype machines. These machines are keyboard operated or are tape or punched card actuated. The cards are used in a recording machine which makes an imprint of the code, through a ribbon of the machine or through carbon paper, onto a punched card. At the time of use, the recorder can imprint:

Constant Data—From the card of the customer, as well as from a plastic card identifying department, station, or salesperson.

Common Data—From a series of wheels in the imprinter, such as date of transaction.

Variable Data—From a set of print wheels positioned by sliding levers, such as amount of sale.

AN IMPRINTING DEVICE FOR RECORDING BAR CODE

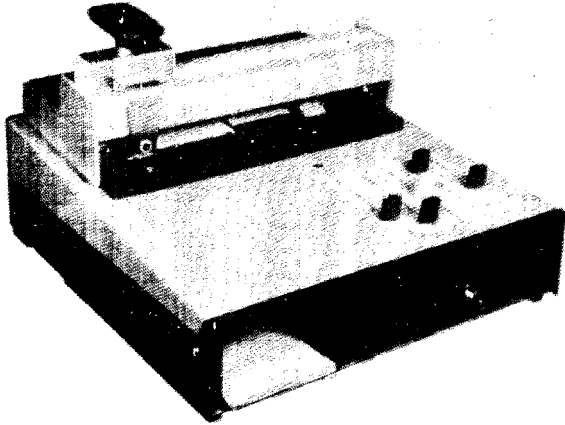

Fig. 23

Figure 23 illustrates an imprinting device for recording bar code from an embossed card onto a punched card.

Processing Data

Since the code is imprinted on a punched card of 80 columns or on a 51-column portion of such a card, the information is ultimately processed through ancillary punched-card equipment, such as sorters, collators, and tabulators.

The first step in the cycle, however, is the reading of the imprinted bars. The machine, figure 24, reads the bar code and punches the rectangular holes into the same card, converting the native language of the bar to the native language of the punched card. The reading machine can punch on—

80-column card—27 columns of read information and 13 columns of preset information—total of 40 columns per card.

51-column card—20 columns of read or preset information.

A sample of the data read from bar code and punched into the same card is shown in figure 25.

With special machines designed for bar-code reading, the following additional functions can also be performed:

Accumulate—Add imprinted amount on detail cards, and punch a summary card.

List—List data, from each detail card, for a transaction register or batch control.

BAR CODE READER

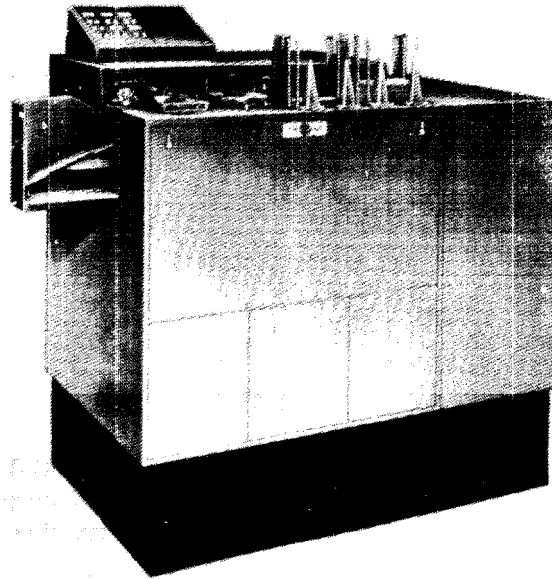

Fig. 24

DATA READ FROM BAR CODE AND PUNCHED INTO SAME CARD

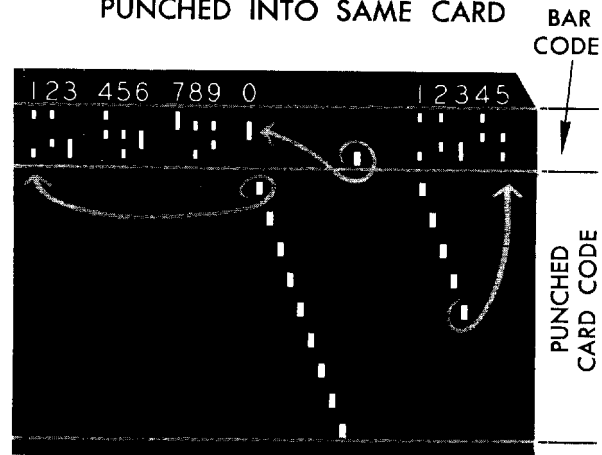

Fig. 25

Number—Assign a consecutive number (six-digit maximum) to each detail card for reconciliation or batch control.

Balance—Compare a stored total from an accumulator to a predetermined total on a batch control card.

SELECTED TYPEFACES AS A NATIVE LANGUAGE

Another widespread method of machine reading involves the reading of selected typefaces. Credit cards often have numbers embossed on the card to represent the account number. The digits may be accompanied by the bars previously described or may appear by themselves on the card. The numbers sometimes have a rather odd, highly stylized appearance.

Figure 26 illustrates a typical card with a stylized typeface, a native language. Some of the stylized type fonts are designed specifically for a particular method of machine reading. For other methods of reading, a stylized typeface may be helpful, but not necessary. The embossed numbers are often stylized to improve the print quality and machine recognition.

The machine-reading results are always best if the print is of a consistent and reliable quality.

Code Structure

Existing machines read one of three codes. These code structures are—

- Numeric data only.
- Numeric and upper case alphabetic data.
- Numeric and upper and lower case alphabetic data.

Each alphabetic character or numeric digit has been designed as a distinctive shape that cannot be read as another character or digit regardless of the quality of the image. For example, the numeral "6" cannot be read by the machine as the numeral "8" because of a poor impression or carbon.

A CREDIT CARD WITH STYLIZED TYPE FACE

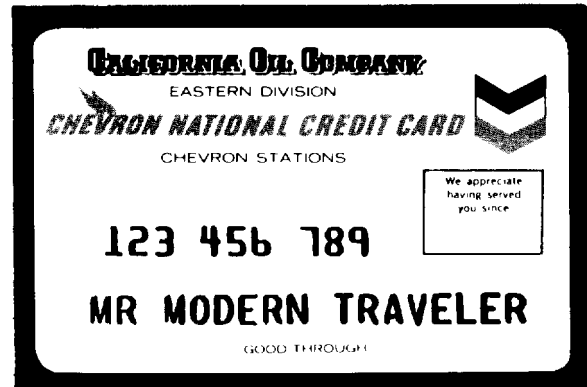

ANOTHER MODEL OF AN IMPRINTING DEVICE

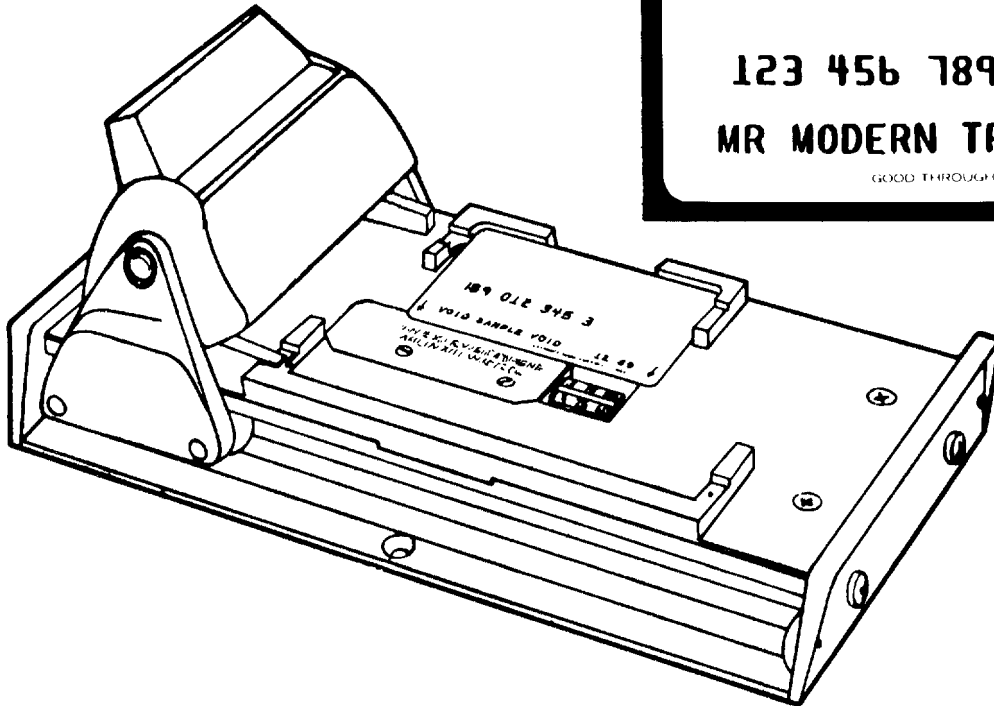

Fig. 26

Figure 27 is illustrative of another selected type font containing numerals, and also upper and lower case alphabetic data for a specific model machine. Though the typeface looks only slightly different from the printed word we read daily, it is in reality a native language for a particular machine.

Processing Data

Machines which read type faces and process the data vary widely. The data generated by reading machines are frequently used in conjunction with other data-processing equipment, such as punched card or computer equipment. Thus, the output of reading machines is often the native language of the paper tape, punched card, or magnetic tape machines. Many reading machines can also be connected to electronic computers as a direct on-line input device.

Machines are not only restricted to reading one of the three possible code structures, but are also restricted to reading this structure on a certain medium. Machines may be categorized as Document Readers, Page Readers, and Self-punch Readers. The capabilities of each kind of reader are briefly described in the following paragraphs.

Document Reader. The document reader is a machine, similar to the one in figure 28, that has the capability of reading one or two lines of data at a time, from paper or card stock documents ranging in size from 2½ inches by 2¾ inches up to 8½ inches by 6 inches. It will

accept data printed by many conventional machines, such as typewriters, adding machines, and high-speed printers. Pencil or ink marks in preprinted mark guides may be used to produce specific codes in the output. Location of lines to be read may vary from one application to another within the specified margin requirements of the reader.

Some of the features which may be added to the document reader are as follows:

Batch header—Allows data read from the first document, a header document, to be recorded in the output for all subsequent documents.

Accumulator—Accumulates variable amounts from documents it has read and transfers totals to output. Device will print on a lister, if desired, as well as add, subtract, and read signs (plus and minus).

List printer—Prints on a continuous tape the data received from the reader or accumulator.

Serial numberer—Generates an ascending serial number for each document read, and includes that number in output.

Page Reader. The page reader is a machine, similar to the one in fig. 29, that has the capability of reading all of the information contained on pages ranging in size up to 8½ inches by 13½ inches. Information contained on a

A TYPE FONT FOR A READING MACHINE

This electronic wonder performs the same function you are performing now; it reads this type style, upper and lower case alphabetic characters, common punctuation marks, and numeric characters, 0123456789. Model IP5P has ability either to read full pages of typewritten information, single or double-spaced, or to scan entire pages in search of particular information, further translating it into a punched paper tape code. Whether the 5-level or the 6-level code is used, the page reader scans and punches 240 characters per second, automatically feeding from page to page. Among the many potential uses, the IP5P offers automated systems in such areas as communications transmission, typesetting, data reduction, scientific literature abstraction, catalog-indexing and language translation.

Fig. 27

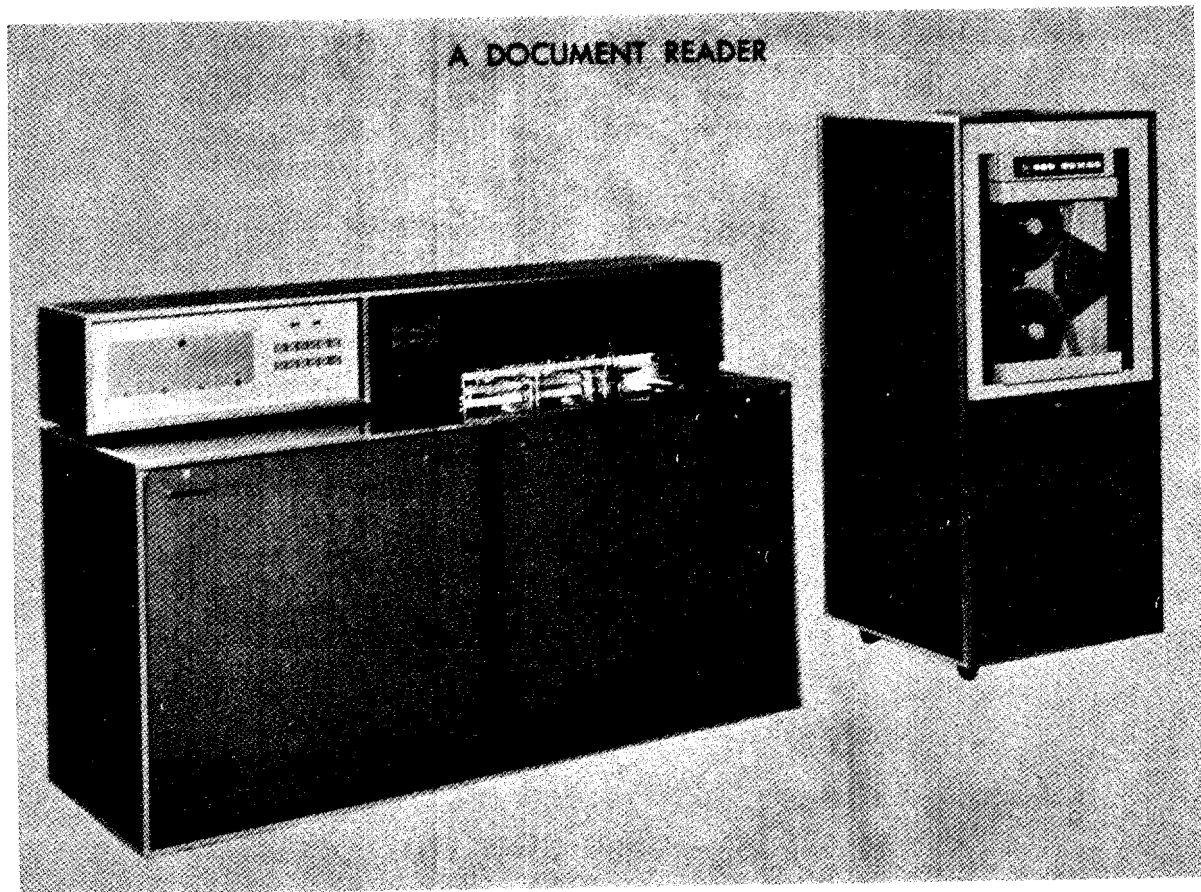

Fig. 28

page is read a line at a time from documents printed with the type font selected for that machine. It will accept data printed by many conventional machines, such as typewriters, adding machines, and high-speed printers. The page reader is normally equipped with locators which enable the machine to find the vertical position of the first line to be read and to ignore all printing above that first line.

Some of the features which may be added to the page reader are as follows:

Counters—Count the lines read and the punched cards produced by the reader.

Serial numberer—Generates an ascending serial number for each page read and includes that number in output.

Shift registers—Position variably right registered fields, such as money amounts, in the correct columns of a field of data on a punched card.

Selfpunch Reader. The selfpunch reader is a machine, like the one in figure 30, that has the capability of reading data imprinted on a card and punching the data into the same card. A single line of data on each punched card is read and punched. Data to be read are most frequently imprinted from metal or plastic cards containing the appropriate typeface embossed thereon. Punching into the card is machine verified to assure accuracy.

Some of the features which may be added to a selfpunch reader are as follows:

Preprogrammer—Permits adding constant data to each record read.

Accumulator—Accumulates variable amounts from documents it has read and transfers totals to output.

Serial numberer—Generates an ascending serial number for each document read and includes that number in output.



Fig. 29

Tabulator—Prints out and totals a proof journal of all punched data.

List printer—Lists on a continuous form the data received during the reading cycle or received from an auxiliary punched-card input.

MAGNETIC INK AS A NATIVE LANGUAGE

In April 1959, the American Bankers Association published the specifications for a native language to be used in the banking industry, Magnetic Ink Character Recognition, familiarly called MICR.

This native language and its associated equipment unlocked the door to source data automating the largest non-government paperwork-handling application made to date.

Code Structure

The MICR language consists of 10 digits, zero through 9, and 4 special symbols, figure 31, printed in a stylized typeface with an ink containing particles of iron oxide.

The digits can be read by the human eye, with a little imagination on the part of the reader. They resemble the shapes of the digits we are familiar with.



Fig. 30

Data Fields

To make MICR usable as a native language, it was necessary to define what magnetic printing was essential and where it should appear on a check.

The bottom five-eighths inch is reserved for encoding in MICR. A space of 6 inches, measured from the right edge of the check, is specified as the universal imprinting area. On large checks data can be recorded outside the 6-inch universal area, which will not be processed by other banks handling the check during clearance.

Specific areas within the universal 6-inch area are designated to contain specific types of data common to all banking operations. All data fields, as illustrated in figure 32, are measured from the right edge of the check.

All data, except the amount, can be printed before the bank issues the check to the user. The amount is encoded by the first bank receiving the check for processing.

Processing Data

The particles of iron oxide in the MICR ink are magnetized by the machines which process the

MAGNETIC INK CHARACTER RECOGNITION TYPE FONT

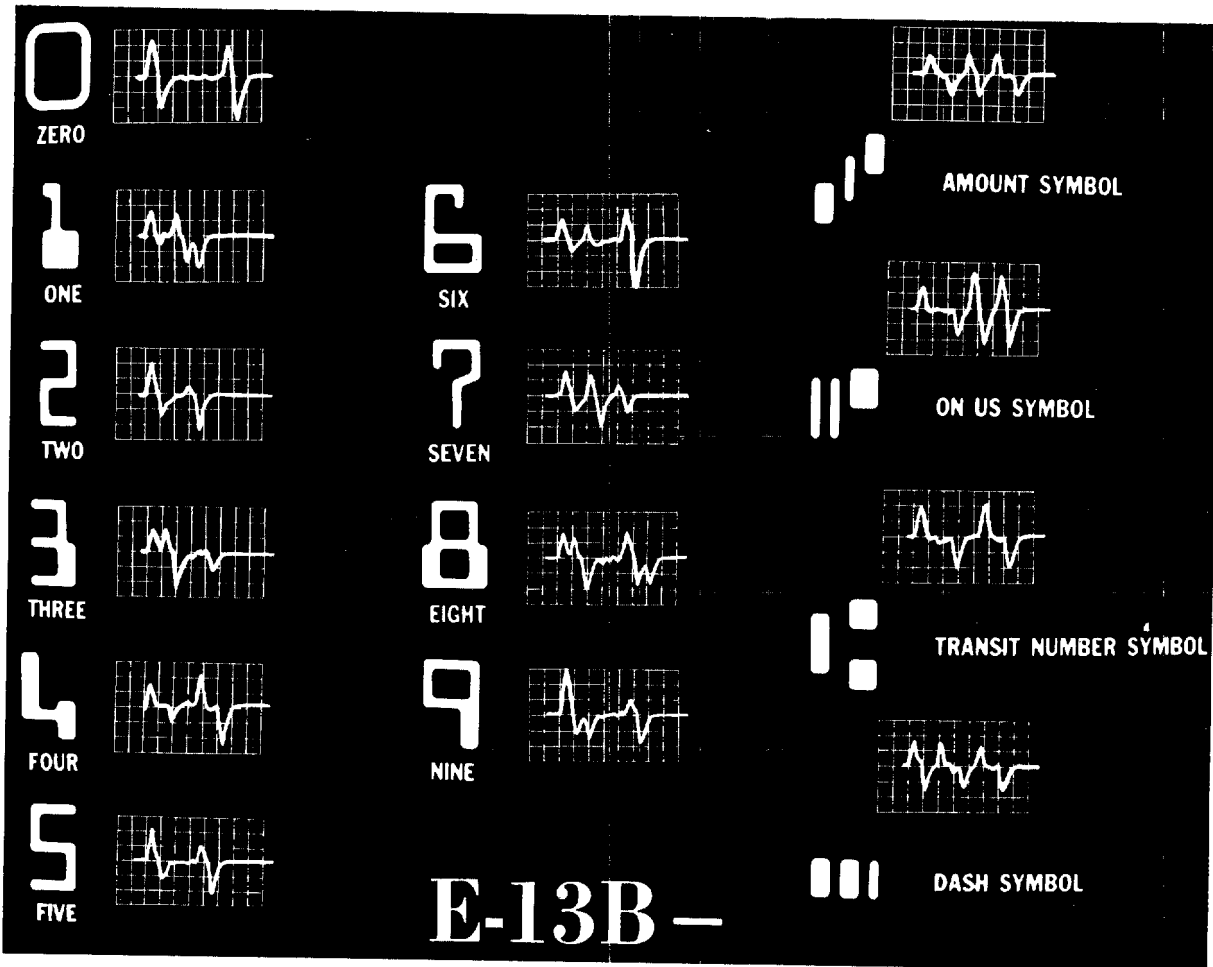

Fig. 31

DATA FIELD LOCATION FOR MICR

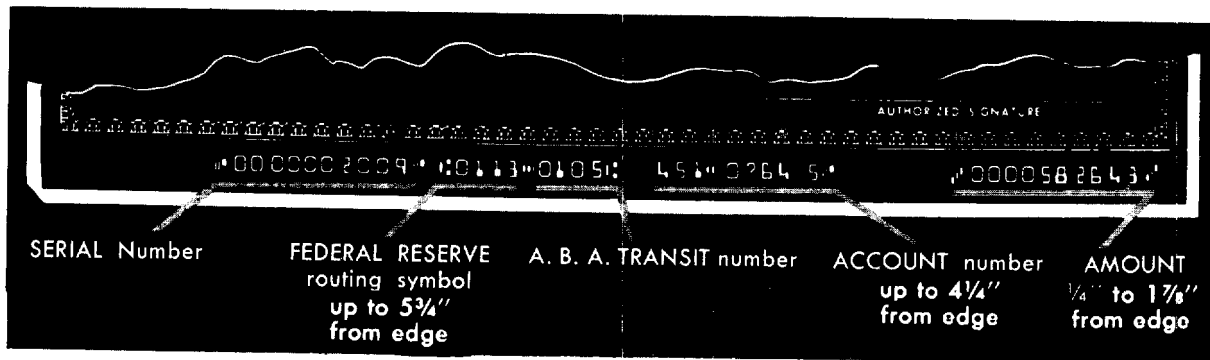

Fig. 32

documents and the magnetized fields are detected by magnetic reading heads, very similar to those in home tape recorders.

When MICR characters are magnetized in the processing equipment, they send out pulse patterns illustrated beside each digit and symbol in figure 31. These pulse patterns are distinguished in the circuitry of the processing machines to actuate other circuitry to perform automated functions.

Sorting of checks by Federal Reserve bank symbol, by American Bankers Association transit number, and individual bank account number is the current practice. This sorting alone saves much labor and speeds up getting the check to the bank on which it is drawn.

Further mechanization can be accomplished with specific models of MICR equipment. The

magnetic ink may control the actual posting to the proper accounts, the preparation of statements, and the preparation of reports for the bank and for the Federal Reserve System.

For convenience and economy of printing, magnetic ink is permissible on any part of the check. The MICR machines read only characters in the areas on the document specified by the American Bankers Association. Regular ink appearing anywhere on the form, even over data imprinted in magnetic ink in the specified location, will have no effect on the processing of the selected data, since it does not have the ability to receive and maintain magnetic charge.

MICR can be converted to punched holes in tapes or cards, or magnetic tape, or fed directly to a computer.

IV. MODES OF CAPTURING DATA

With today's modern source data automation equipment there are available three major modes of capturing selected data in the native language of machines:

- DELIBERATE CREATION
- BYPRODUCT CREATION
- CONVERSION CREATION

The machines used in source data automation may be capable of performing in more than one mode. For example, a machine which punches a tape as a primary function may also be capable of producing a byproduct tape in the same native language.

DELIBERATE CREATION OF A NATIVE LANGUAGE

The techniques of source data automation require the manual depression of a key to record a native language on a carrier. This is the oldest method of deliberately creating a native language. Key punching of cards, an example of this mode, is still the widest used manual method of data capture.

The following pages describe machines which deliberately produce native language carriers. Evaluation of each machine in the framework of source data automation must be based on the needs of the individual application.

Holes in Tapes

When tape is to be generated, it is possible to create the native language deliberately by depressing the keys of a punching device, similar to that shown in figure 33. On most

DELIBERATE CREATION OF A PUNCHED PAPER TAPE WITH A TYPEWRITER

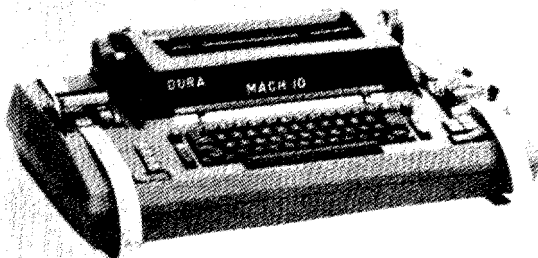

Fig. 33

models of equipment, production of the tape is accompanied by simultaneous production of a ribbon (hard) copy of the data on paper or forms.

Another deliberate tape-generating mechanism, without the production of hard copy, is a data recorder similar to the one shown in figure 34. Variable data are manually set in the keyboard of this device and all keyed data are punched at one time into a five-channel tape. Fixed data, in limited amounts, can be punched from code bars built into the machine at the time of manufacture. Mechanical interlocks make the keyboard accept only certain digits in selected fields, when a control bar is depressed. For example, if "Style Bar" in the machine in figure 34 is depressed, selected columns will be limited to certain predetermined numbers, thus reducing the possibility of human error. Data can also be captured from print-punch tags inserted in the recorder at the time of operation.

DELIBERATE CREATION OF A PUNCHED PAPER TAPE WITHOUT A HARD COPY

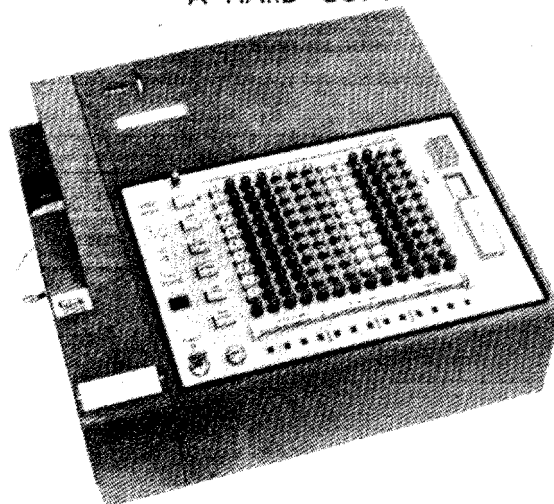

Fig. 34

Holes in Cards

When punched cards are to be generated, it is possible to create the native language deliberately by using—

A keyboard-actuated punch, figure 35, to produce an 80- or 90-column card.

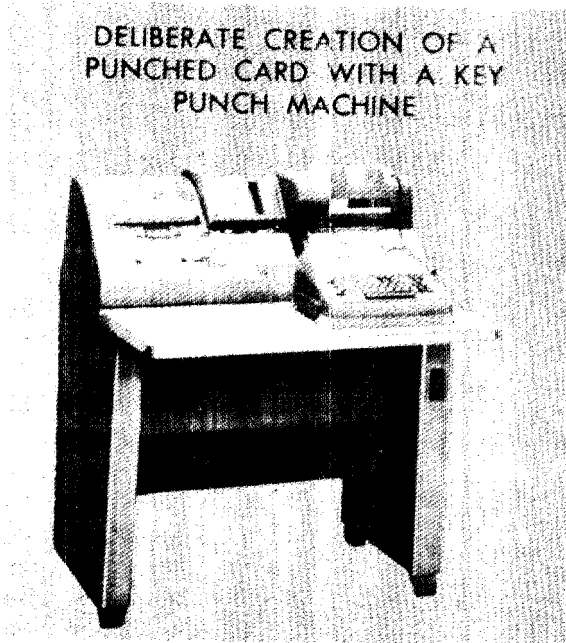

Fig. 35

A stylus and a prescored card, figure 36, to record a maximum of 40 columns in an 80-column card.

DELIBERATE CREATION OF A PUNCHED CARD USING PRESCORED CARD AND STYLUS

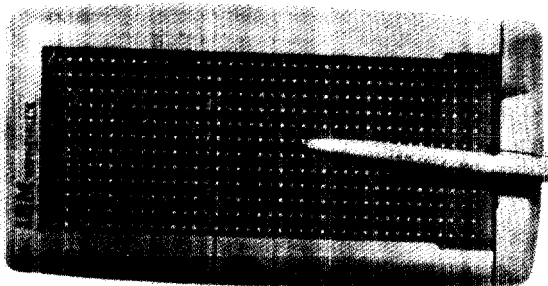

Fig. 36

A conductor's punch and a card with prepunched pilot holes, figure 37, to record up to 90 columns in a round-hole card.

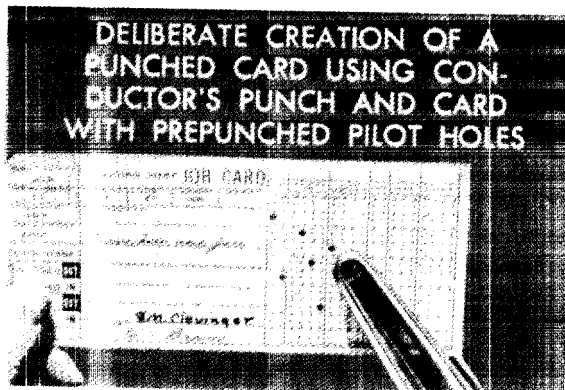

Fig. 37

DELIBERATE CREATION OF A PUNCHED CARD USING PORTABLE DATA RECORDER

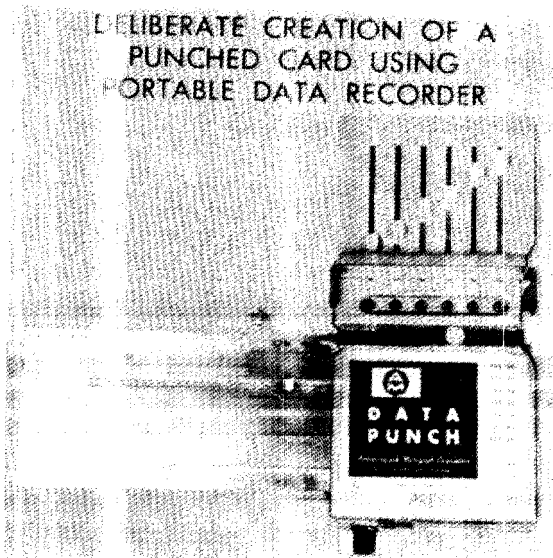

Fig. 38

A portable nonelectric, lever set punch, figure 39, to record information in a standard or special plastic punched card.

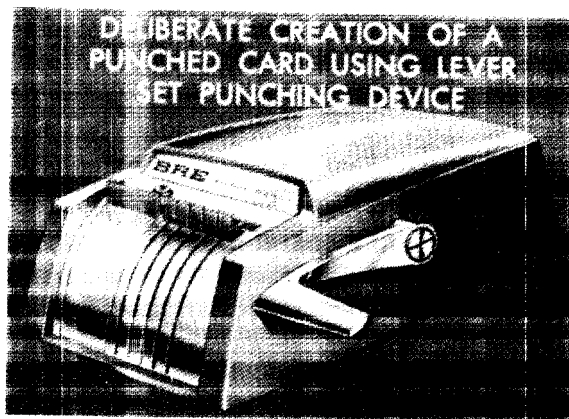

Fig. 39

A portable data recorder, figure 38, to punch up to 80 columns of information, 6 columns at a time in an 80-column card.

A special electrographic pencil and a specially printed card, figure 40, to record up to 27 columns of information on an 80-column card.

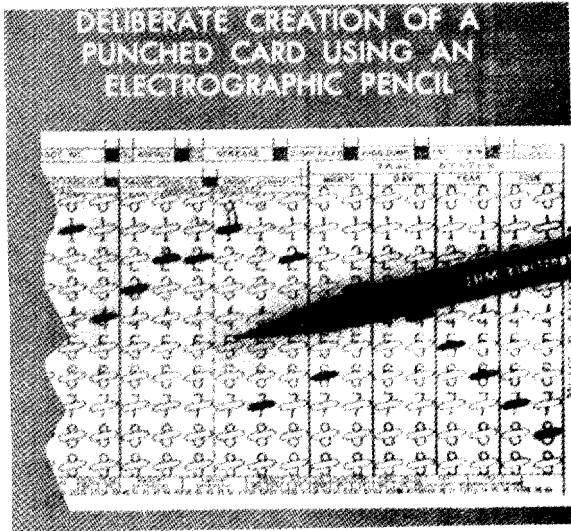

Fig. 40

Holes in Tags

When tags are used, it is possible to create the native language deliberately, only by setting the dials of a print-punch recorder, figure 41. Once the dials are set, many tags

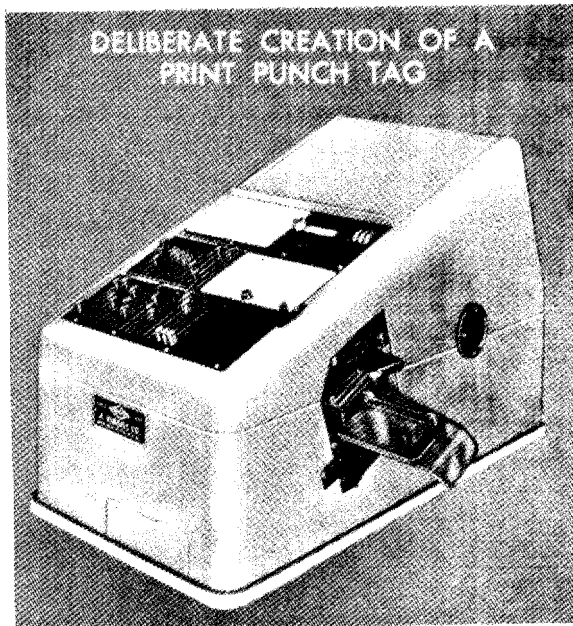

Fig. 41

containing the necessary data may be made automatically without resetting the dials.

Perforations in Coupons

When coupons are used, it is possible to create the native language deliberately, only by setting dials, inserting pins, or depressing the keys of a perforator, figures 42 and 43. Once set, the machine will perforate many coupons simultaneously.

Dots

When dots are to be scanned as the input, it is possible to create the native language only by blacking-in a circle with a pencil on a specially designed form.

Bars

When bars are to be scanned as the input for selected data, it is possible to create the native language deliberately by obtaining an impression of the code from a metal or plastic plate, using a device similar to that in figure 23.

Selected Typefaces

When selected typefaces are to be read, it is possible to create the native language deliberately with a data recorder similar to that in figure 23. The native language can also be

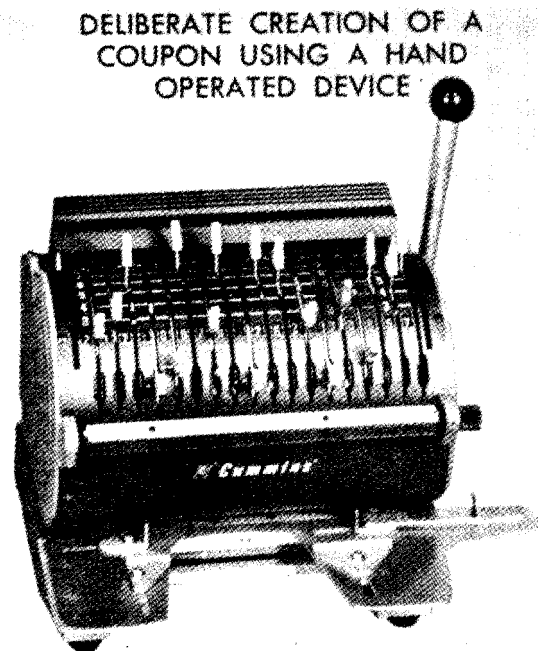

Fig. 42

DELIBERATE CREATION OF A
COUPON USING AN
ELECTRICALLY OPERATED
PREFORATOR

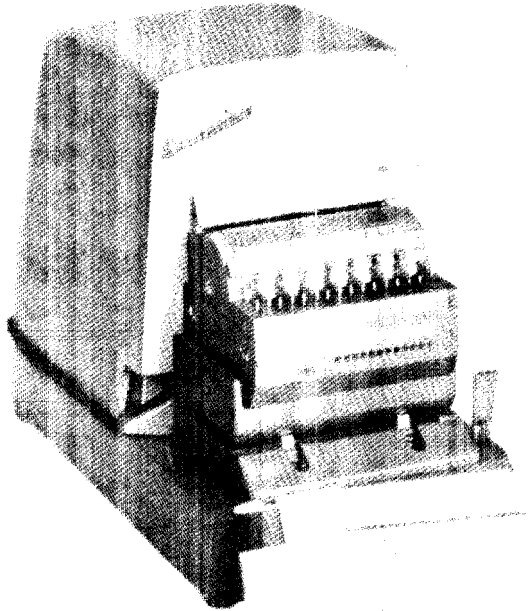

Fig. 43

created by typing or printing with the proper typeface.

Magnetic Ink

When magnetic ink is used as the native language for source data automation, it is possible to create the language in an iron-oxide-bearing ink, by use of standard duplicating or printing equipment. Another way of creating the language involves imprinting with a device similar to that in figure 23, equipped with a special ribbon bearing iron oxide ink.

BYPRODUCT CREATION OF A NATIVE LANGUAGE

The byproduct capture of data in the native machine language is not new, though it sometimes has not been recognized as such. For many years it has been possible to list detailed transactions from unit records in punched cards and simultaneously create, through a cable connected piece of auxiliary equipment, a summary card indicating total transactions on a class of items.

Methods of creating byproducts vary. The following pages describe machines which capture native languages as the byproduct of an essential operation.

Holes in Tape

Most models of equipment using tape as the carrier of the native language produced the tape and a ribbon copy simultaneously. Often it is essential to type data, at its inception, on some form or document. If at this time a tape is produced for other steps in the paperwork cycle, the tape may be considered as the byproduct of a necessary operation.

Most models of equipment which basically operate from or produce paper tape permit the simultaneous creation of one or two byproducts in native languages.

Figure 44 is an illustration of a procurement system existing in many places today. Byproduct tapes can be produced by the punching device which is an integral part of the typewriter, by a cable connected auxiliary tape punch, or by both punches. The byproduct tape being used in the second typewriter (B), figure 44, is producing still another byproduct tape for further source data automation.

When a keypunch machine, 80 or 90 columns is connected by cable to the tape-actuated typewriter (fig. 45), punched cards are produced in their native language, as the byproduct of a necessary typing operation. It is worth noting that the tape-actuated typewriter in this instance is reading punched cards as its input, rather than conventional tape. Typing from the punched card is controlled by the program tape in the equipment called the selective secondary input (2).

The punching devices, either those that are integral parts of the typewriter or those cable connected to the typewriter, may be capturing in a native language all of the data, selected bits of data, or a combination of all and selected bits.

It is frequently possible to produce a byproduct 5-, 6-, 7-, or 8-channel tape or punched cards of the 80- or 90-column variety without the use of a tape or punched card device as the basic input. If a typewritten document is not needed at the source of the

PURCHASE ORDER AND CHECK WRITING SYSTEM USING BY PRODUCT DATA CAPTURE

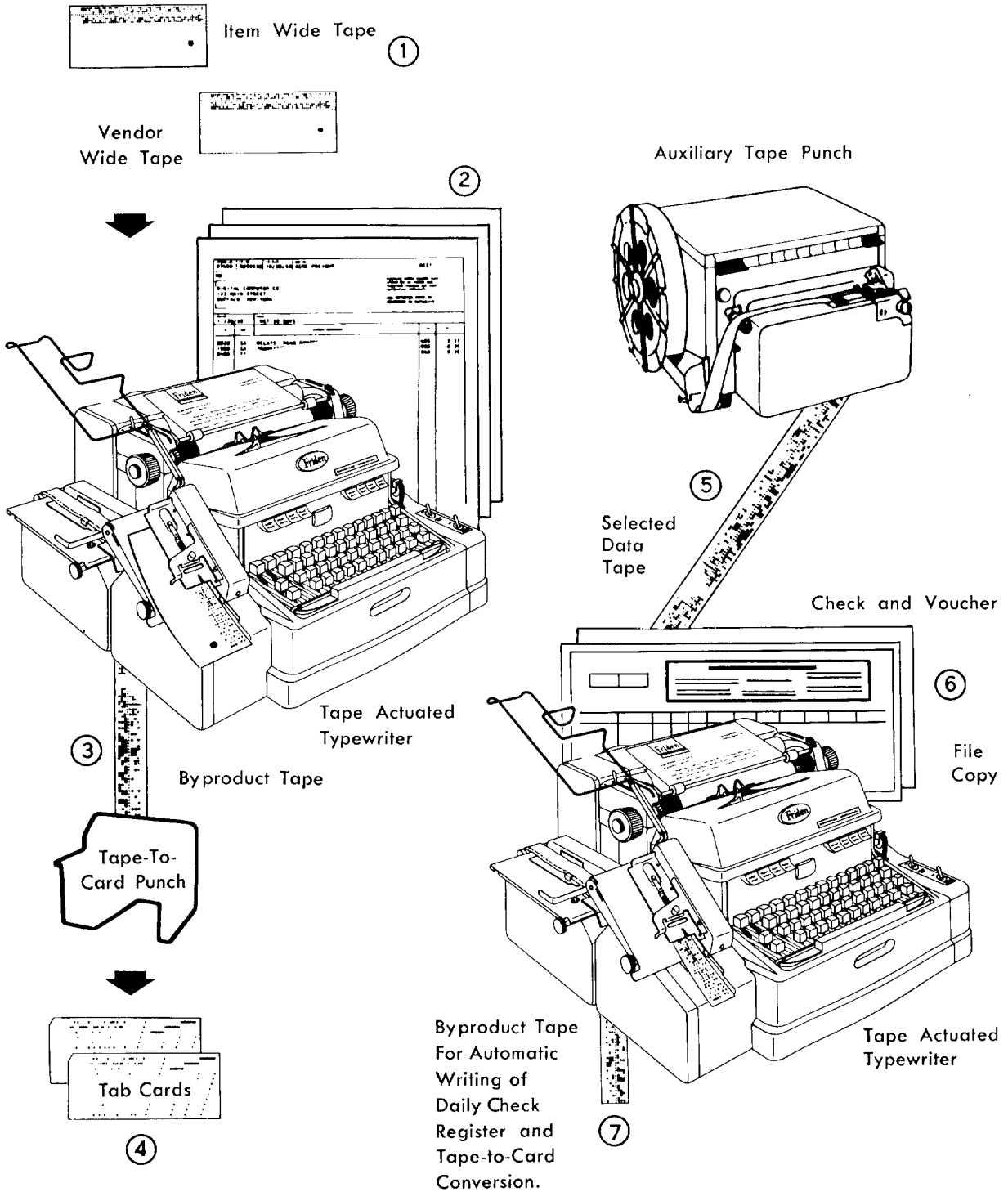

Fig. 44

SALES ORDER SYSTEM USING PUNCHED CARDS AND TAPE ACTUATED TYPEWRITER

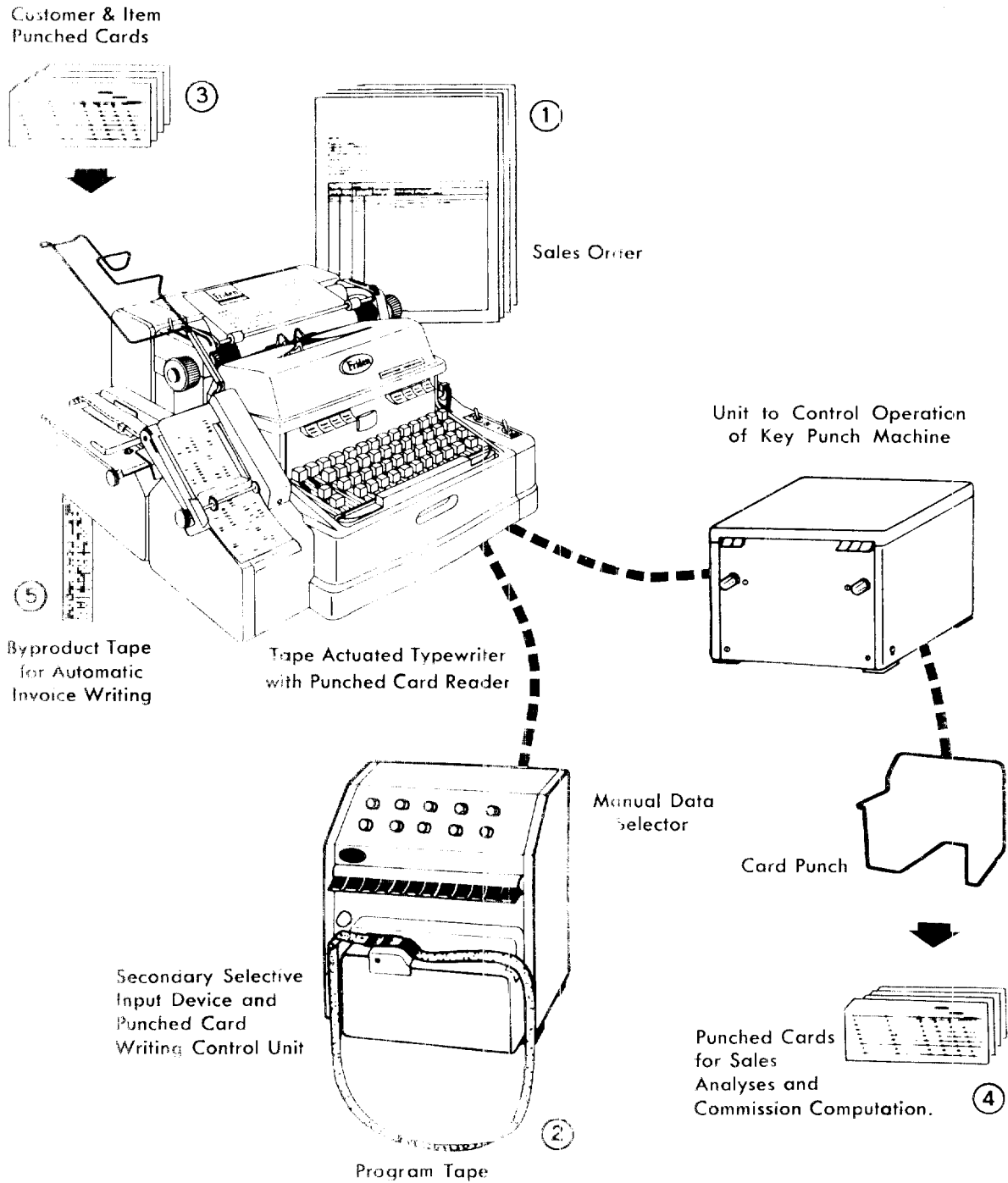

Fig. 45

Approved For Release 2006/08/10 : CIA-RDP70-00211R000500040034-4
data, a paper tape or a punched card can be created from the following conventional pieces of office equipment:

Adding machines, figure 46, which perform all the regular functions of such a machine and produce a punched paper tape.

Accounting machines, figure 47, which produce either paper tape or punched cards as a byproduct of normal descriptive accounting procedures.

Bookkeeping machines, figure 48, which produce either paper tape or punched cards as a byproduct of normal non-descriptive accounting procedures.

Cash registers, figure 49, often called point-of-sale recorders, which produce either paper tape or punched cards as a byproduct of on-the-spot sale recordings.

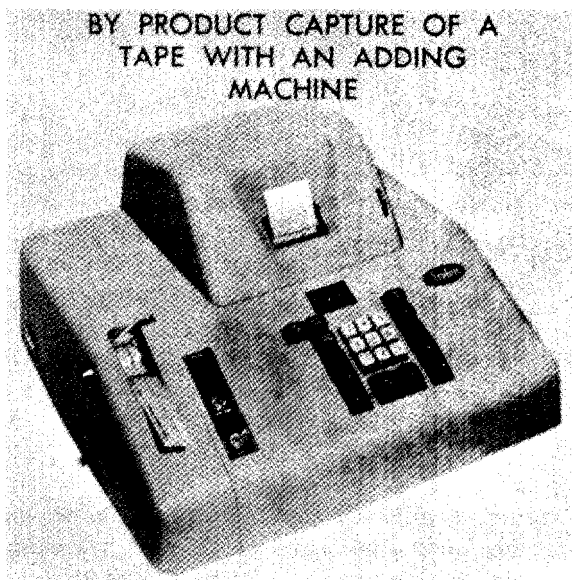

Fig. 46

Holes in cards

Many of the machines described in the previous paragraphs, that are capable of producing tape as a byproduct, can also produce punched cards as a byproduct.

Perhaps the best known byproduct of punched cards is the summary card. This card is produced by cable connecting a device known as a summary punch or document originating machine to the electric accounting

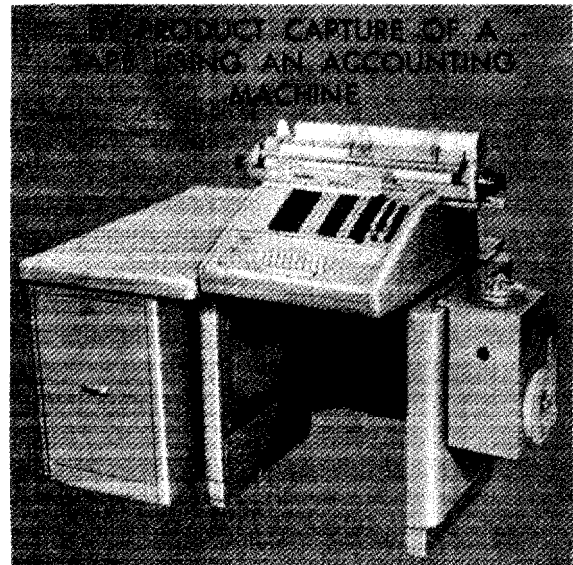

Fig. 47

machine (commonly called a tabulator, which trade term is used hereafter to avoid any confusion with other types of accounting machines). Figure 50 illustrates typical equipment. The tabulator could be producing a summary listing or a detail unit record listing of the cards it is reading, at the same time it is producing the punched summary card.

Another byproduct of a punched card is the result of card duplicating. The keypunch machine, figure 51, used to create deliberately the native language of the punched card, has the ability to duplicate selected data from the last card it punched into the card it is now punching. Thus, the card duplicating feature permits creation of a byproduct unit record from its previously punched unit record.

Byproduct punched cards are also possible as the result of time and attendance recording. A timeclock, figure 52, used to record time-in, time-out, or other time factors, can print the time on the card and simultaneously punch an 80-column card.

Metal or plastic identification cards, similar to gasoline company credit cards, can contain embossed data for repetitive writing in the lower portion of the card and an in-line five-channel code in punched holes in the upper portion—another native language similar to the five-channel telecommunications code. A card of this nature is illustrated as figure 53. When this card is used in a device similar to that



Fig. 48

shown in figure 54, the holes in the upper portion of the card actuate a punching mechanism to punch selected data, such as account number, directly into a punched card. Variable information may be lever set or key set to be punched into the same card. Thus, the punched-card native language is being produced as a byproduct of a writing (imprinting) operation.

Holes in Tags

At the present there is no known method of creating the native language of the print-punch tag as the byproduct of another operation. Tags can be used to produce a byproduct five-, six-, seven-, or eight-channel tape with an auxiliary reader attached to a point-of-sale

recorder, similar to that shown in figure 49. Variable data can be keyed in with the cash register, and fixed data can be obtained from the tag attached to the merchandise. Thus, a byproduct tape can be produced every time a sale is rung up, in a native language acceptable for further source data automation.

Tags can be used to inventory merchandise on the shelves. A portable unit for reading tags attached to merchandise produces a byproduct tape containing data from the tag and variable data which has been entered from a keyboard or dials. Figure 55 illustrates such a reader for print-punch tags, while figure 56 illustrates such a reader for plastic or metal card. With these devices, a byproduct of

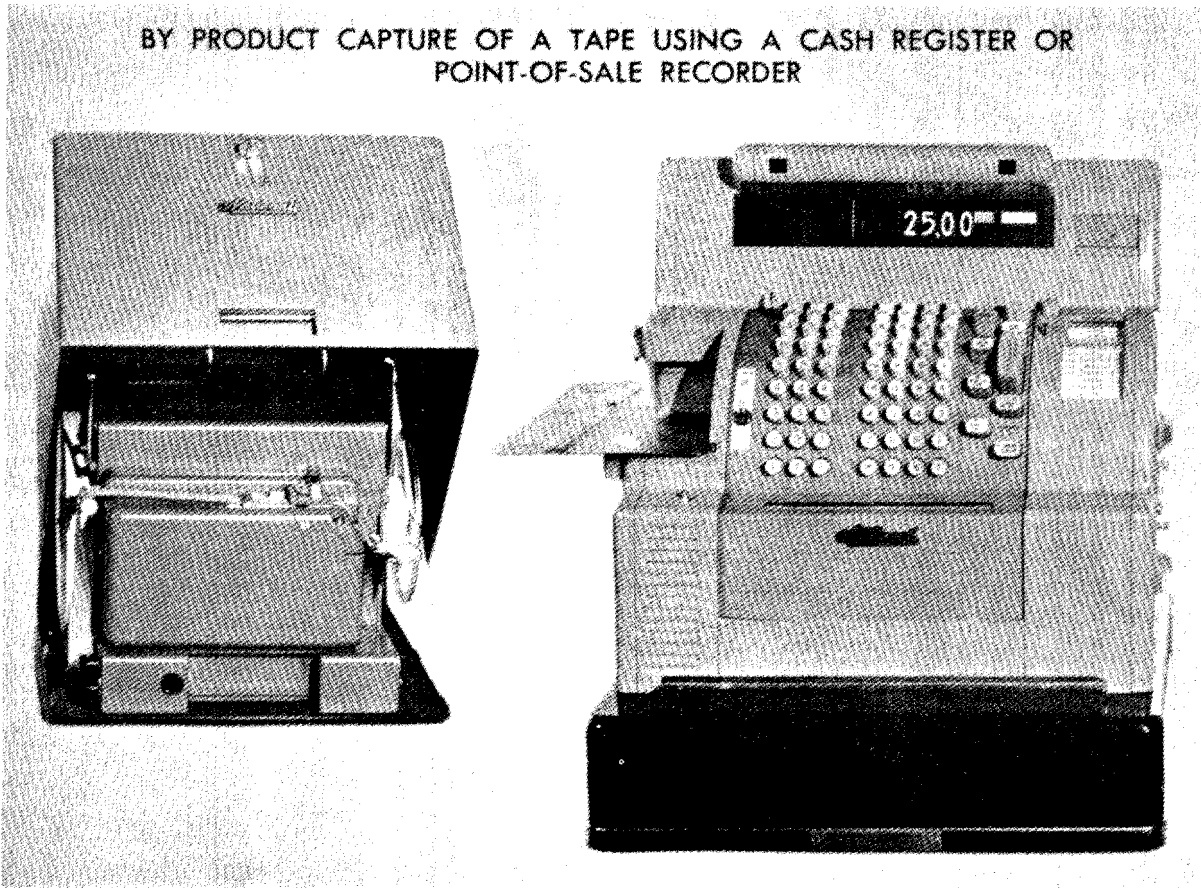

Fig. 49

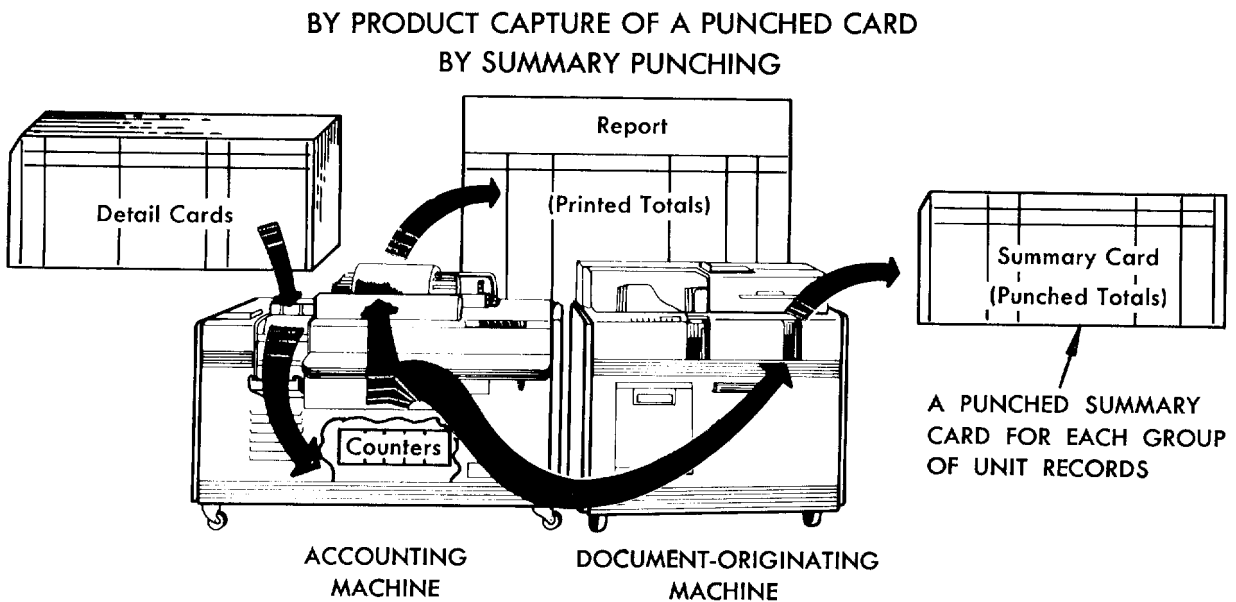

Fig. 50

BY PRODUCT CAPTURE OF A PUNCHED CARD THRU THE KEY PUNCH MACHINE
(DUPLICATING)

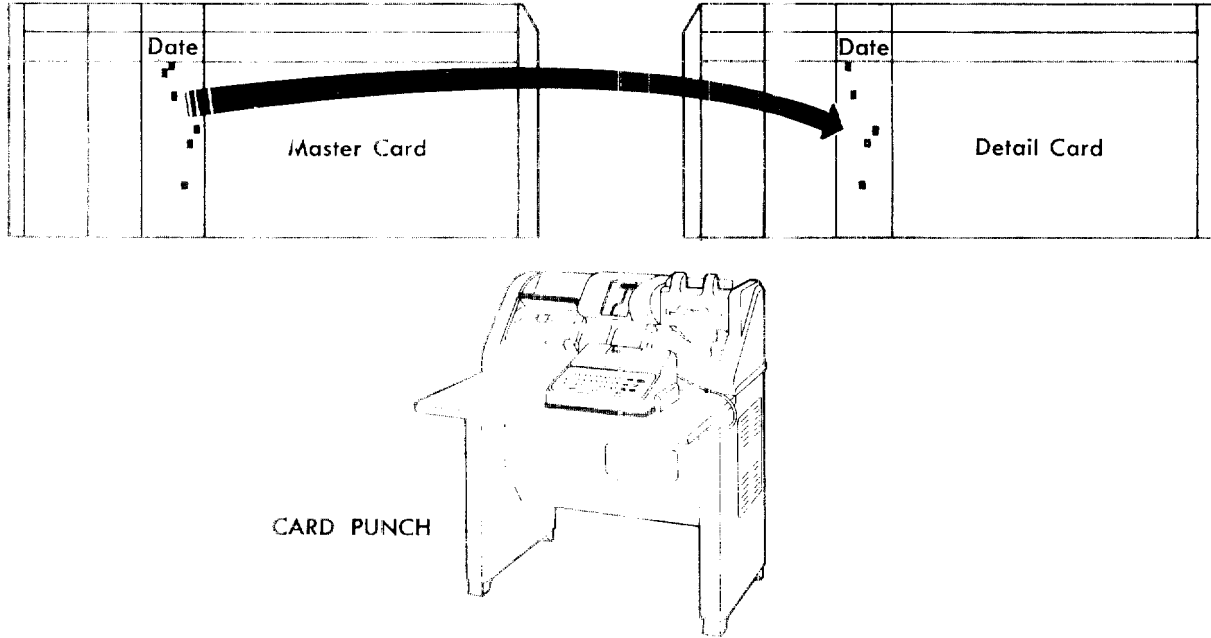

Fig. 51

BY PRODUCT CAPTURE OF A
PUNCHED CARD USING TIME
AND ATTENDANCE RECORDER

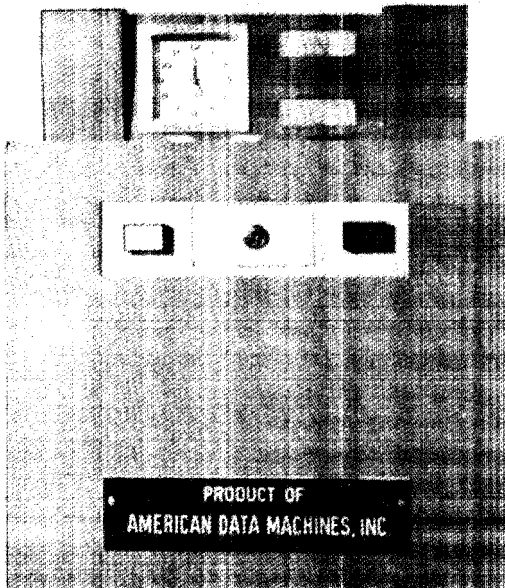

Fig. 52

inventorying materials is a tape in the required native language for further source data automation.

Perforations in Coupons

Only one known means of creating the native language of the coupon as the byproduct of another operation now exists. The batch number and amount can be perforated into coupons, with a combined adding machine and perforator, while the adding machine produces a printed adding machine tape. Figure 57 illustrates such a device.

Dots

There is no known method, at this time, of producing dots as the byproduct of another operation.

Bars

Bars as a native language are always a by-product of an imprinting operation. Each time the imprinter produces an image on a paper document, the necessary numerical data in the native language of the bar-reading devices is also produced.

BY PRODUCT CAPTURE OF A PUNCHED CARD USING AN EMBOSSED CREDIT CARD

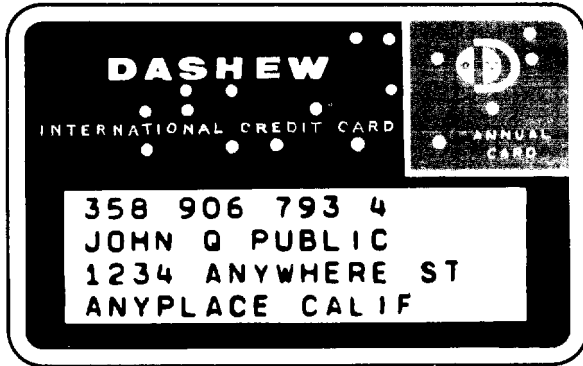

Fig. 53

BY PRODUCT CAPTURE OF A PUNCHED CARD READER FOR EMBOSSED CARDS

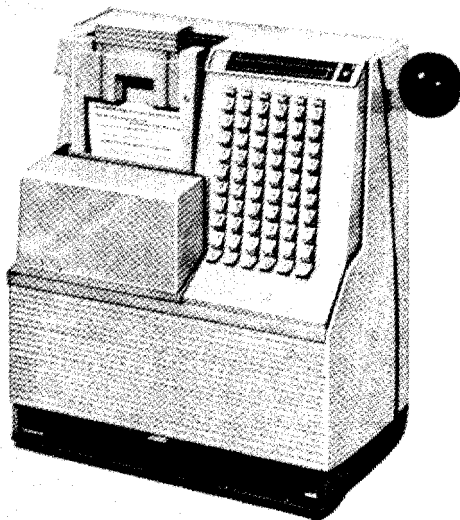

Fig. 54

Name, address, and account number, already captured in the native language of tape or punched cards, can be used to produce metal or plastic identification cards. Figure 58 illustrates an embossing machine used to produce metal or plastic identification cards from tape or punched cards which may have been captured as the byproduct of another necessary operation.

BY PRODUCT USE OF PRINT PUNCH TAG FOR INVENTORYING MERCHANDISE

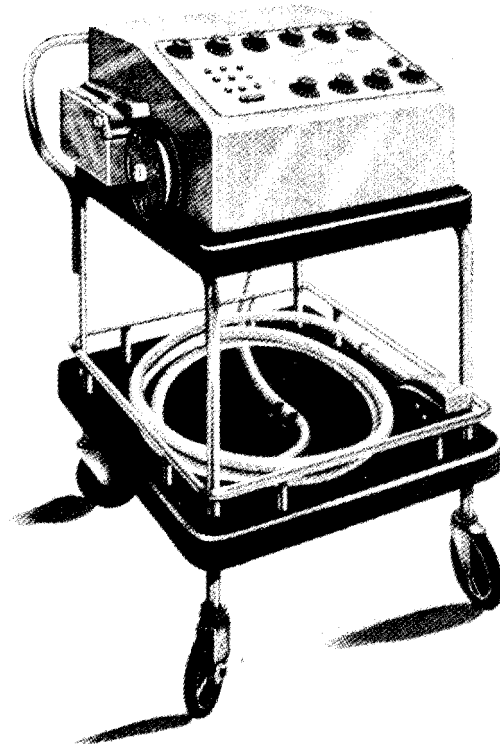

Fig. 55

Identification cards can have "human" readable language as well as the bar code for numerical data. Similar competitive devices can produce the five-channel in-line punched hole code in plastic cards, in lieu of the bar code.

Selected Typefaces

The use of selected typefaces as a native language for reading is predicated on the production of selected data in the required native language as the byproduct of a necessary writing operation.

In plastic or metal identification cards, stylized typefaces have all of the same attributes as the bar code. Imprinting from the plates produces the necessary native language as a byproduct. Plates can be produced through an embossing machine, figure 58, as the byproduct of another necessary operation.

BY PRODUCT USE OF METAL OR PLASTIC
EMBOSSER CARD FOR INVENTORYING

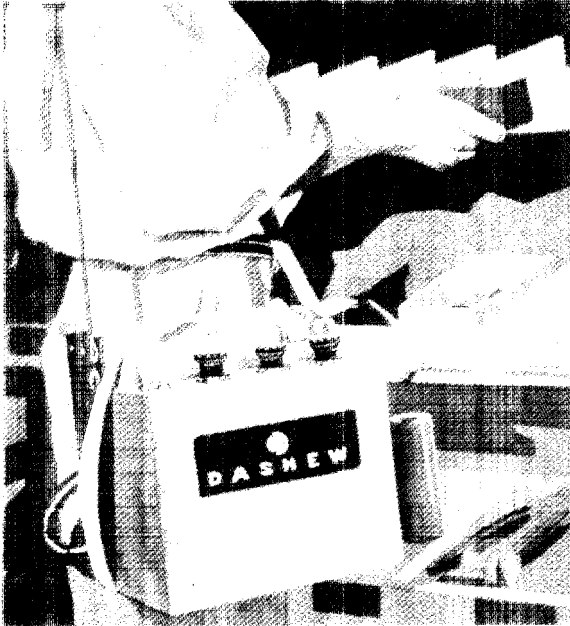

Fig. 56

BY PRODUCT PRODUCTION OF
EMBOSSER PLATES FROM TAPE
OR PUNCHED CARDS

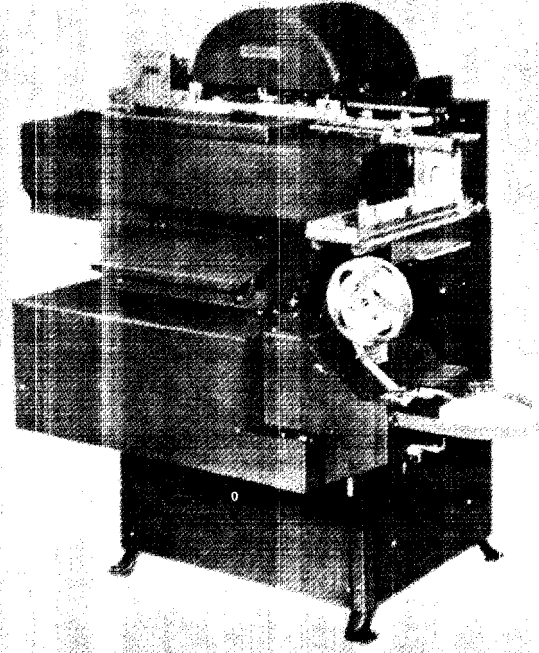

Fig. 58

BY PRODUCT COUPON PERFORATION
WITH AN ADDING MACHINE

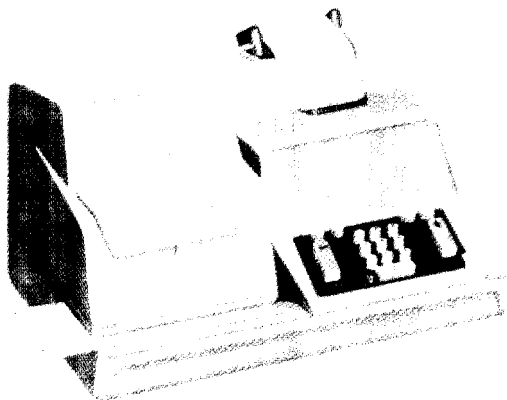

Fig. 57

Typing or printing on a necessary form or document, in the selected typeface, makes that form or document acceptable as input to the reader in use. Thus, each form of document prepared as a necessary typing or printing operation automatically produces the native

language as a byproduct to that writing operation.

Magnetic Ink

In the banking industry, most of the data are deliberately created by printing or imprinting in an iron oxide ink. Plastic cards, embossed with E13 B typeface, can be used to imprint account numbers on deposit slips carbonized with special iron oxide carbon paper. These slips are scanned by a machine similar to the one in figure 59. Still missing from the papers, however, is the amount of money for which the check or other financial instrument is drawn. The missing data can be placed on the document in magnetic ink, as a byproduct of an adding or bankbook machine operation.

CONVERSION CREATION OF A NATIVE LANGUAGE

Until recently each manufacturer made only equipment that operated from the carriers he had selected and that operated only from the native language he wanted. The preceding discussion of the byproduct creation of a native

SCANNING MAGNETIC INK CHARACTERS PRODUCED FROM
EMBOSSSED PLATES

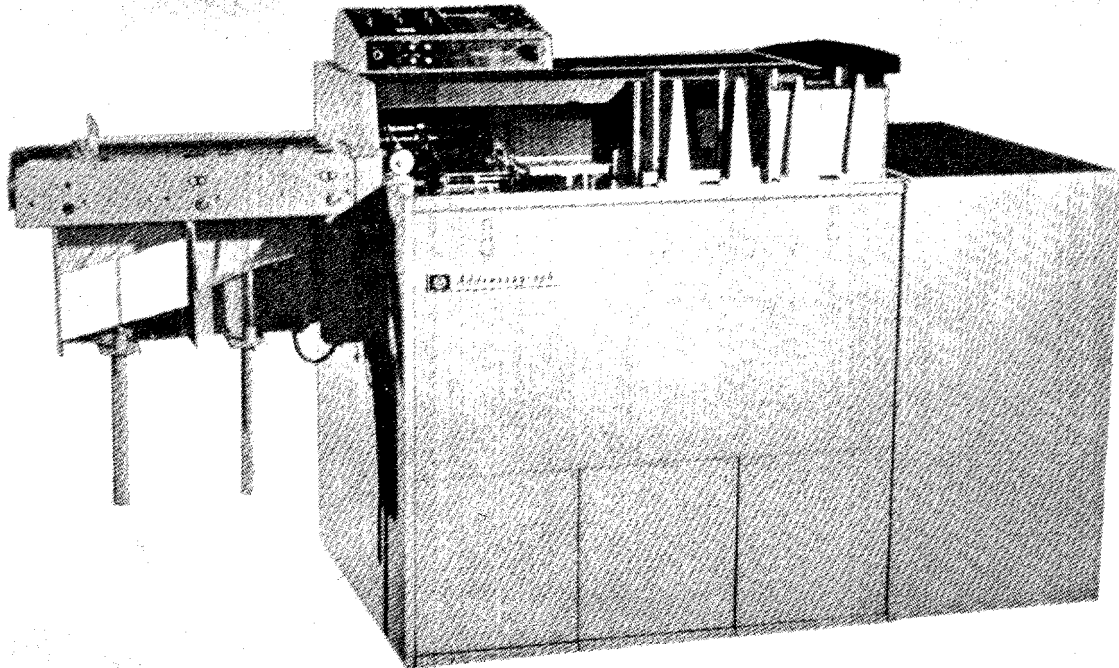

Fig. 59

language has given some indication of how this picture has changed in recent years. The discussion has covered the byproduct capture of a native language: on punched cards from tape-actuated machines, on tape from punched-card-actuated typewriters, and on punched cards or tape from machines not normally associated with source data automation, such as accounting, bookkeeping, and adding machines.

However, using a single native language for a complex paperwork system hampers mechanization to its full potential. Manufacturers of data-processing equipment recognize that one organization may justify a tape-actuated system while another requires a punched-card system. Perhaps even a computer may be required for a still larger organization. The data flowing between these three different organizations would not have been compatible. The native language of each set of equipment was not uniform or interchangeable. Although the data had once been put in a native language, that language was valueless to the other organizations

without their resorting to manual key depressions. With this condition becoming more and more prevalent, manufacturers brought forth a new type of equipment—thus was born the line of equipment called converters.

It is safe to say that any native language used to source-data-automate any paperwork system can, if the need exists, be converted to any other native language by the use of the proper converter. If a new native language is developed by a manufacturer, a converter to change that new language to any other native language will soon appear on the market.

Some of the representative converters now available are described in the table, figure 60.

Another device for conversion is called an intercoupler. Intercouplers are electromechanical units which interconnect two machines, thereby making the operation of one or both machines automatic. The intercoupler may be used to feed data, in a native language, to a conventional office machine; to operate another

conventional office machine: or to produce a byproduct in a native language from a conventional office machine. The illustration, figure

67, depicts an intercoupler attached to a conventional accounting machine to permit the machine to accept a native language as input.

REPRESENTATIVE CONVERTERS

INPUT	OUTPUT	SEE FIGURE	REMARKS
PAPER TAPE			
Any 5-, 6-, 7-, or 8-channel tape.	Any other 5-, 6-, 7-, or 8-channel tape.	61	Output may be conventional type fonts, selected type fonts for reading, in-line punching in upper part of a plastic card, combinations of foregoing.
	Any magnetic tape.	62	
	80- or 90-column punched cards.	63	
	Embossed metal or plastic cards.	68	
Any 5-, 6-, 7-, or 8-channel wide tape.	Any 8-channel narrow tape.	64	
MAGNETIC TAPE			
Any magnetic tape.	Any 5-, 6-, 7-, or 8-channel paper tape. 80 or 90-column punched cards.	62	
PUNCHED CARD			
Any 80- or 90-column card.	Any 5-, 6-, 7-, or 8-channel paper tape. Any magnetic tape. Embossed metal or plastic cards.	68	Output may be conventional type fonts, selected type fonts for reading, in-line punching in upper part of a plastic card, combinations of foregoing.
PRINT-PUNCH TAG			
Any size print-punch tag.	Any 5-, 6-, 7-, or 8-channel paper tape. 80- or 90-column punched cards.	65	Conversion is a necessity. No equipment is available for direct processing. Dials in converter permit addition of constant information during conversion.
COUPON			
Any size perforated coupon.	Any 5-, 6-, 7-, or 8-channel paper tape.	66	Conversion is a necessity. Except for sorting coupons, no equipment is available for direct processing.
BAR CODE			
Bar code impressed on an 80- or 90-column card.	Punched holes in the same card.	64	

Figure 60

CONVERTER—PAPER TAPE TO
PAPER TAPE

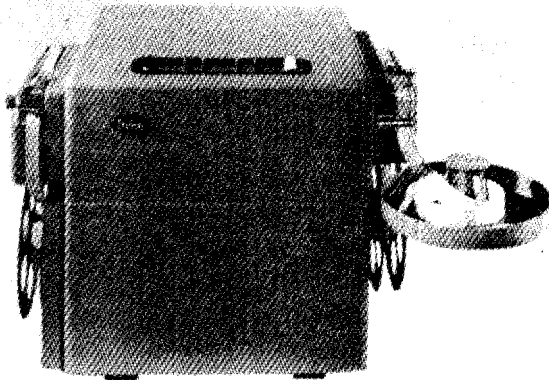

Fig. 61

CONVERTER—WIDE PAPER TAPE TO
NARROW PAPER TAPE

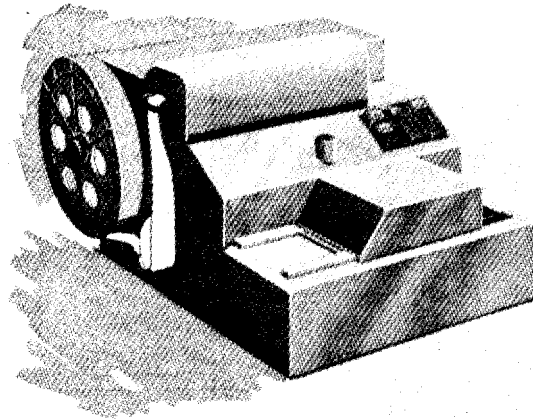

Fig. 64

CONVERTER—PAPER TAPE TO
MAGNETIC TAPE

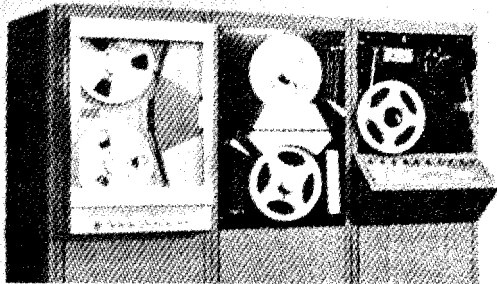

Fig. 62

CONVERTER—PAPER TAPE TO
PUNCHED CARD

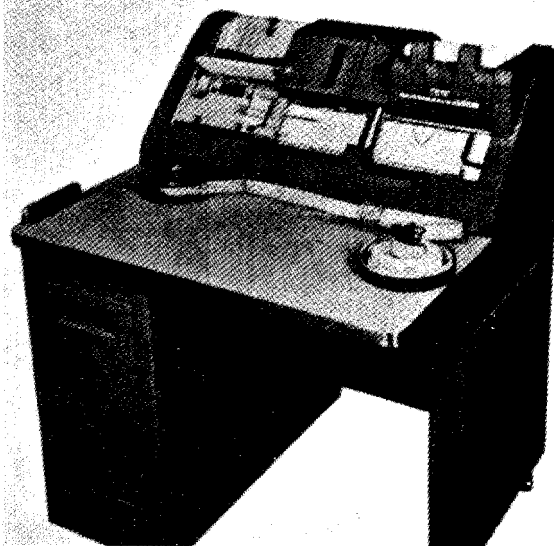

Fig. 63

CONVERTER—PRINT PUNCH
TAG TO PAPER TAPE OR
PUNCHED CARD

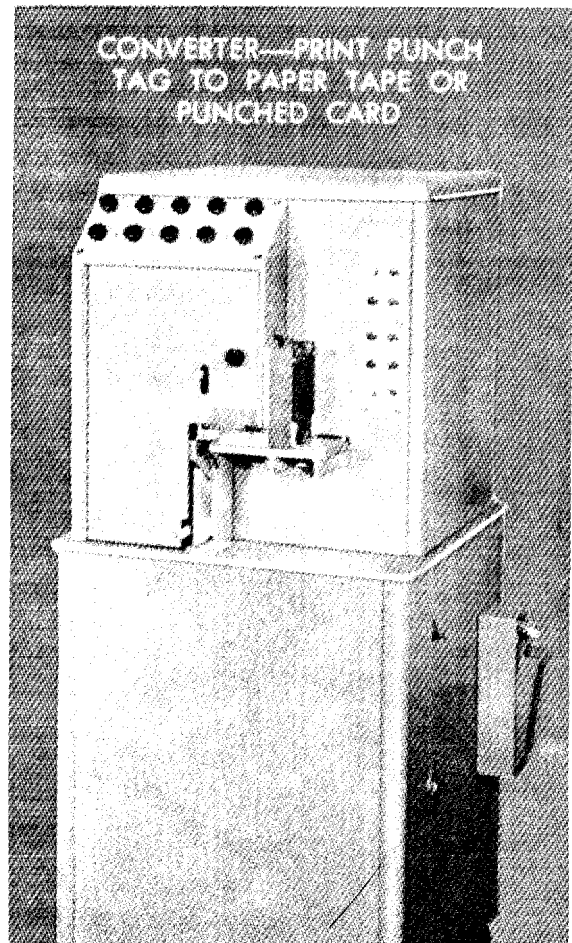

Fig. 65

CONVERTER—COUPON TO PAPER TAPE OR PUNCHED CARD

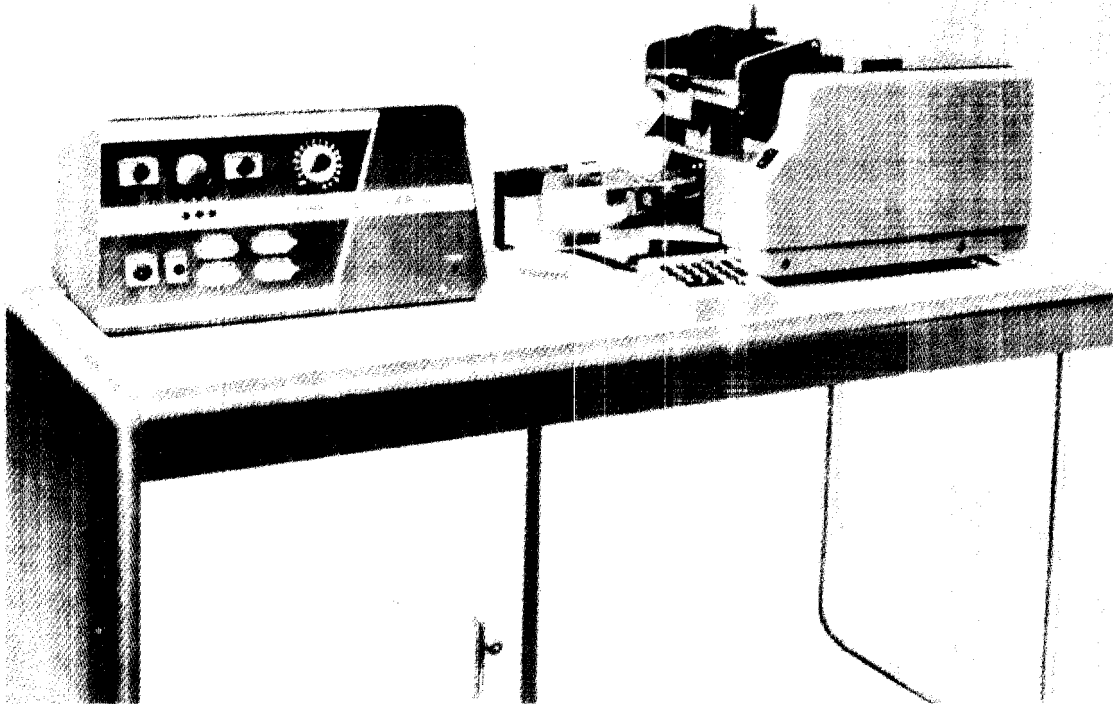

Fig. 66

CONVERTER—INTERCOUPLER BEING ATTACHED TO
A CONVENTIONAL BOOKKEEPING MACHINE

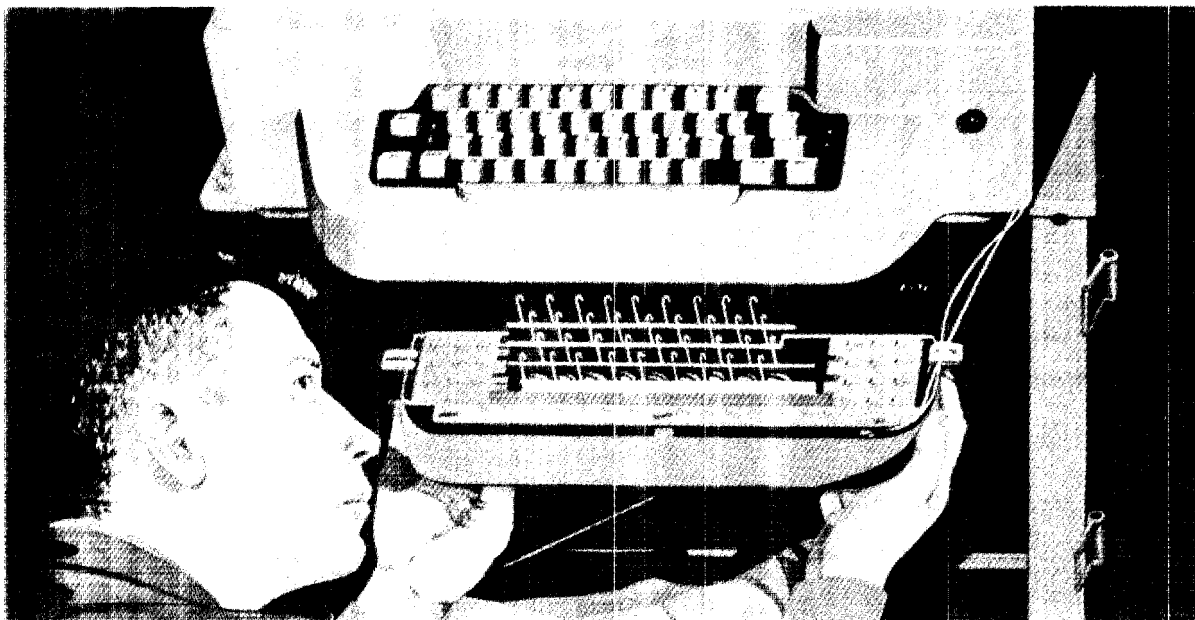

Fig. 67

V. MACHINABLE FUNCTIONS

No simple and straightforward answer is possible to the question, "Which machine or machines are best adapted to a specific paperwork system or office function?" Since there are many variables, each proposed application must be weighed on its own merits.

One of the principal variables influencing selection of equipment is the function, or combination of functions, to be performed in the complete paperwork cycle. A particular function in a system may be best performed with tape, while another function in the same system can best be carried out with punched cards. Selection of tape equipment, card equipment, or combinations of both, must be determined by the overall advantages to the total system.

Since the function to be performed strongly influences selection of equipment, the capabilities of certain machines for performing office functions should be compared. At this point only tapes and cards as the carriers of the native language are discussed, since—

- Processing with tags is accomplished after conversion to tapes, cards, or magnetic tapes.
- Processing with coupons is accomplished after conversion to tapes, cards, or magnetic tapes, except for sorting the coupons.
- Processing with bars, dots, and selected type faces is accomplished principally after conversion to tapes, cards, or magnetic tapes.
- Processing with magnetic ink is at present limited to the banking industry, although some office applications may be developed at a later date.

At this point, a subject not mentioned before is introduced—the transmission of data. Data can be transmitted in two basic ways: over a wire, as by telephone, or over the air, as by radio. Regardless of the method elected, the means of transmission is called a communications network. Networks may be:

Rented on a toll basis—Paid for by the time the circuit is actually tied up.

Rented on an hourly basis—Paid for at an hourly rate, by the hours the circuit

is in use. Hourly costs vary, depending on anticipated volume of traffic.

Leased—Paid for at a flat rate. Available at all hours.

Owned privately—Built and operated at will by individual owners.

Communications networks are required whether the distance involved is across the room to another piece of equipment or across the country to another office. Cable connecting two pieces of adjoining source data automation machinery is really the equivalent of a communications network. The manufacturer, however, frequently furnishes the necessary wires and contacts as integral parts of his machines.

Depending upon the type and model of equipment in use, communications equipment may allow sending and receiving only one message at a time from each end of a circuit, or as many as four sending and four receiving machines operating simultaneously at each end. Thus, it may be possible to send only one message in one direction at a time, as many as four messages in one direction at a time, or four messages in both directions simultaneously.

The speed of transmission of data varies according to the type and model of equipment at each end of the circuit. Speeds of most standard equipment vary from 60 words (300 letters, spaces, or symbols) per minute to approximately 2,500 characters per minute. In general, the higher the transmission speed, the greater the cost of the equipment required at each end of the network.

Accuracy of transmission depends upon the quality of the communications network. Like static, which destroys enjoyment of a radio program, noise on a communications network destroys the accuracy of data transmission. The accuracy of a network and its costs are in direct ratio. Higher transmission speeds also require networks with a greater degree of accuracy. If data transmission is a vital part of a paperwork system, it is suggested that a communications specialist be consulted.

WHAT FUNCTIONS?

After repetitive data have been captured in a native language, many routine office functions

can be performed by machine. A specific function, such as arranging, may best be performed with punched cards, while another function, such as completing a form, may best be performed with paper tape.

Some of the functions which can be performed by machines are defined as follows:

INTERPRETING ONTO CARRIERS (INTERPRETATION)

Interpretation, as used here, is printing on the source data automation carrier the translation of the holes contained in the carrier, thus making the native machine language readable to the human eye.

VERIFYING THE ACCURACY (VERIFICATION)

Verifying is checking the accuracy of the punching of the native language--making sure that data recorded in holes have been recorded without error.

WRITING (PRINTING)

Writing, as a mechanical function, means converting the native language into an alphabetic and numeric language that can be read.

DUPLICATING

Duplication, in the automation sense, is the production of copies of complete or selected data in a native machine language, for additional machine operations.

ARRANGING (SORTING)

Arranging is placing cards or tapes into specified sequence according to a factor contained in the cards or tapes.

SELECTING

Selecting cards or tapes means segregating from a mass of unit records, certain records that require attention or further machine handling.

MERGING (COLLATING)

Merging involves combining two sets of unit records into one set in a given sequence.

MATCHING

Matching recorded facts is checking for agreement between two sets of unit records--making sure that each set contains the same records.

COUNTING

Counting pertains to tallying the number of cards or tapes by the type of data recorded in each unit record.

CORRELATING STATISTICAL DATA

Correlating statistical data is assembling information, by machine, from more than one source, into related analyzed statistical reports.

COMPUTING RECORDED DATA

Computing recorded data from unit records involves not only performing of arithmetical operations and updating recorded facts involving arithmetic, but also distributing and proofing of financial data or other statistics.

COMMUNICATING (COMMUNICATIONS)

Communicating, as a machine function, is transmitting all or portions of data from one machine in one location to another machine in another location, near or far.

PERFORMING FUNCTIONS WITH PUNCHED PAPER TAPE

Interpreting

Most common paper tape equipment produces the equivalent of a blind code in narrow tape. Translation or interpretation onto these common tapes cannot be accomplished.

Wide tapes lend themselves to content identification. The interpretation is usually in the form of a pressure-sensitive label affixed to the card. The production of this label should be the automatic byproduct of a step in the system and not a separate manually typed operation or function.

Several of the five-channel tape-producing machines used in the telecommunications industry can produce a tape with a visual translation of the holes. This is accomplished by not punching the holes completely through the tape. Tape of this type is called "chadless" tape.

Figure 68 illustrates a punched tape with interpretation and compares it with the conventional blind code punched tape.

Verifying

A paper tape is ordinarily verified visually by reading the hard copy which is produced simultaneously with the tape. A surer way is by reading the hard copy produced by the tape and comparing it with the original. Tapes which have been interpreted (fig. 68) can be proofread against the document from which data were extracted.

Mechanically duplicated tapes, or tapes produced as a byproduct, are automatically verified by machine circuitry which assures that the hole punched in the tape agrees with the signal or pulse sent by the originating machine.

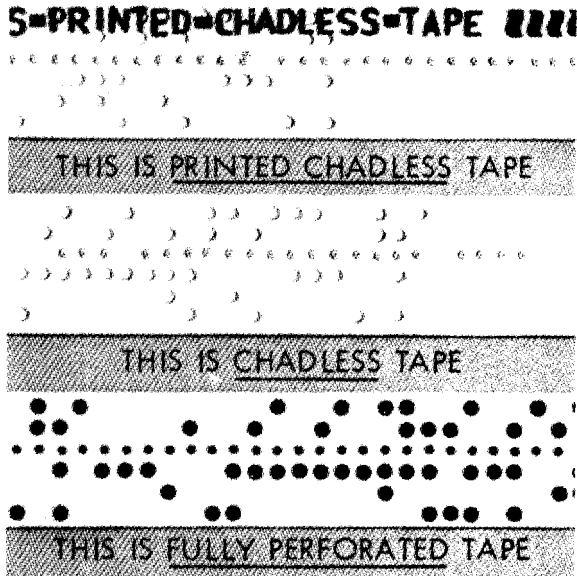

Fig. 68

Writing

Writing is most frequently accomplished in a tape-actuated typewriter. Such typewriters will—

- *Type by Keyboard Depression*
Typing on an electric typewriter and simultaneously producing both a tape and a hard copy. Inserting variable data is also accomplished by keyboard depression when the machine is operating from a previously produced tape.
- *Read From a Primary Tape*
Typing from a tape containing repetitive data which has been previously created deliberately or as a byproduct of another operation, but using only one reader as input.
- *Read From a Primary and Secondary Tape*
Typing repetitive data from a primary tape reading unit and a limited amount of variable data from a secondary reader. The finished product may be the result of switching from primary to secondary reader several times during the writing operation. Figure 69 illustrates an auxiliary tape reader.

AUXILIARY TAPE READER

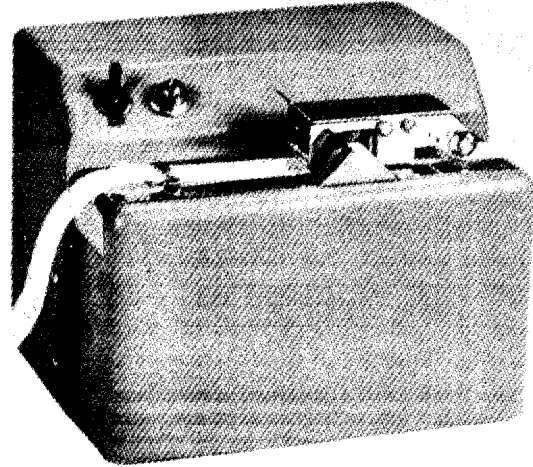

Fig. 69

- *Read From Dials*

With a secondary reader, setting such information as date or invoice number in dials to be typed on successive documents until the dials are reset. One of these readers is illustrated in figure 70.

AUXILIARY TAPE READER WITH MANUAL DATA SELECTOR

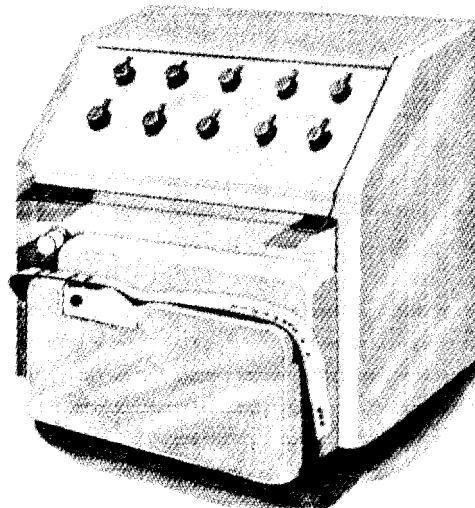

Fig. 70

- **Read From a Punched Card**

Writing from punched cards, when the primary tape reader was exchanged for a punched-card reader. The secondary reader, in this case, is used to control the space between words and the line advance.

- **Search for Coded Data**

With secondary reader, searching and selecting variable data contained in its tape, either by special codes or by manually set switches. Figure 71 illustrates one such unit.

- **Write and Compute**

By merging a tape-actuated typewriter with a computing unit into a specialized piece of machinery, writing data from tapes while a limited amount of multiplying, adding, subtracting, and dividing is also being accomplished. The mathematical results are printed out automatically by a signal sent by the computing unit. Figure 72 illustrates a tape-operated writing-computing machine.

Duplicating

The best known method of duplicating tapes is to engage the primary punch of the tape typewriter, producing a duplicate tape as a by-product of an operation. This tape is normally a complete tape containing all data. Two complete tapes can be produced simultaneously by connecting a secondary output by cable to a tape typewriter.

To produce a tape containing selected data, it is necessary to have programed the original tape with punch-on and punch-off codes to provide self-control of the duplicating operation. If these controls were not programed into the original tape, stop-codes must be present to permit the operator to engage and disengage the punching mechanisms manually. Using a secondary output, two tapes may be made simultaneously. The two tapes may be duplicates of each other or each tape could contain different selected data, depending upon the programing present in the original tape.

Arranging

Tapes are arranged by hand from some identification written on the tape itself. The

interpretation of the native language onto wide tapes permits easier manual arranging. Like the narrow tape, wide tapes cannot be sequenced by machine.

Selecting

Tapes are usually selected manually from tape filed in a specified sequence in some type of file housing. A limited amount of mechanical

AUXILIARY TAPE READER
WITH AUTOMATIC ADDRESS
SELECTION AND MANUAL DATA
SELECTOR

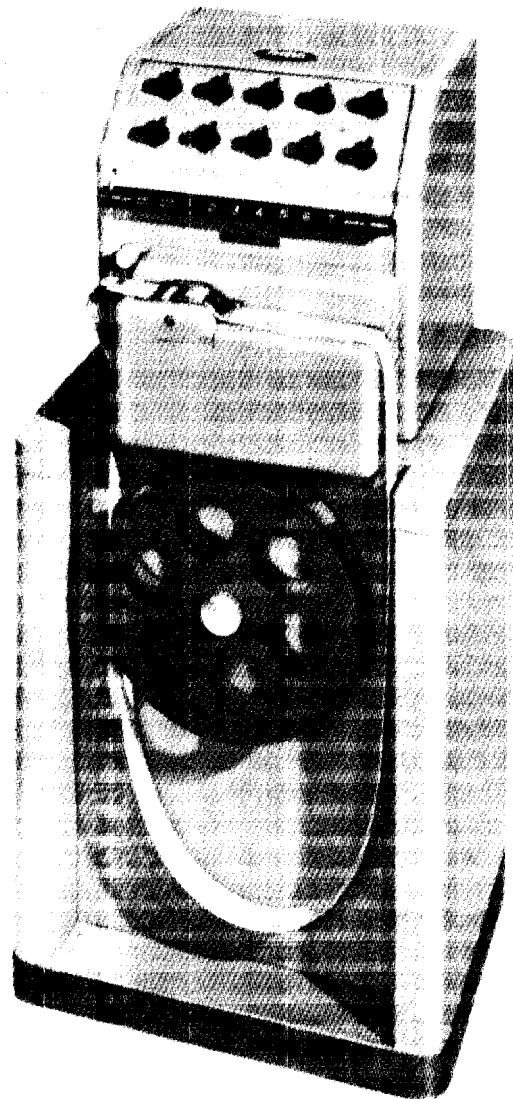

Fig. 71

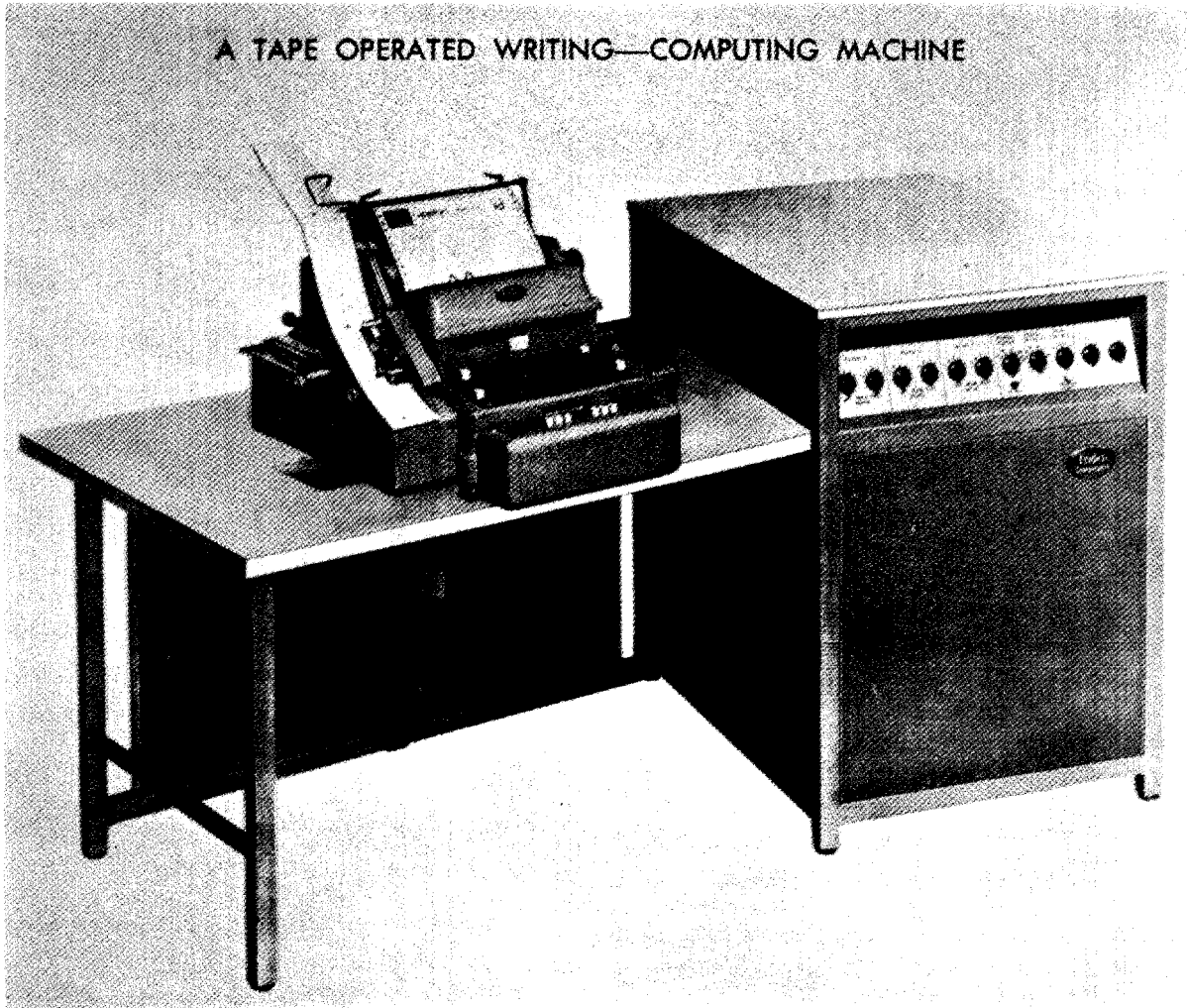

Fig. 72

selection can be accomplished on the basis of a code punched into the tape when a selective secondary input is used.

Merging

Tapes to be merged are manually selected and collated. The collated tapes are then passed through a tape machine in proper sequence to produce a merged tape.

Matching

Tapes are matched by running them through a tape-actuated typewriter and proofreading the hard copy. Small pieces of tape may be matched visually by sighting through the holes of two pieces of tape laid together.

Counting

Since tapes must be arranged by hand, counting is limited to manual counting.

Correlating Statistics

Capturing production-planning data or statistical data as the byproduct of a necessary office or factory operation is often desirable. In the factory, for example, capturing several items of variable data as the byproduct of a manufacturing operation is frequently essential. Such data frequently include man data, machine data, quantitative data, and time data. Machines known as transaction recorders or known collectively as data-recording systems have the capability to record simultaneously all of these variable factors in a native machine language.

When a data-recording system is used, some of the variables must be described in a prepunched native language. For example, in the factory, such prepunched data include—

Man Data—Employee number, clock number, badge number, and other coded data which identify a particular employee.

Machine Data—Machine number, machine type, and other coded information which identify the specific machine a particular man is operating.

Job Data—Job number, project number, operation number, accounting data (when job cost is part of the required analysis), and other coded information identifying the work being performed.

When the prepunched data, similar to that previously described, is available, the machine used in a data recording system can originate variable data as follows:

Time—Time of arrival or departure of employees, time a specific job was started and completed, or other essential time data, may be recorded from a signal emitted from a self-contained clock.

Quantity—Number of items produced, number of documents processed, or other quantitative data, may be recorded by setting dials built into the machine.

Fixed Variables—Date or other variables which are constant for a specified period, may be recorded by setting and locking dials built into the machine.

One of the most familiar jobs being performed on data collection systems is production planning. Data collection stations are located at or near various machines used in a manufacturing operation. These stations record time and attendance of each employee, time of starting and completing each operation, quantity of items completed, and project accounting data. During the night, computing equipment produces, from the information assembled by the data systems machines, the reports necessary for effective management. Reports prepared include a production plan for the next day, time and leave status of each employee, and cost accounting analysis.

The principal parts of equipment used for correlating statistical data are:

Self-Contained Data Station—Recording data in a native language at the station, figure 73. May be moved from

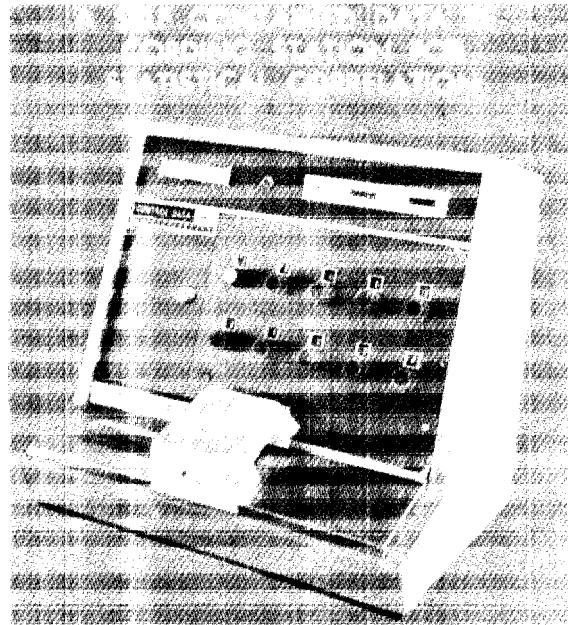

Fig. 73

point to point in the production area as workload shifts.

Remote-Recording Data Station—Recording data in a central compiling station to which it is connected by a multiwire cable, figures 74 and 75. Many remote-recording stations may be wire connected to a single compiling station.

Badge-Reading Data Station—Attachable to either a remote-recording or self-contained data collection station, figure 76. Utilizes a prepunched plastic identification badge.

Data systems machines may utilize either paper tape or punched card as input; they produce either paper tape or magnetic tape as output. Data may be processed through conventional punched-card equipment or electronic computers.

Computing

Figure 72 illustrates one type of machine for performing mathematical operations with the native tape language through the merger of a tape-actuated typewriter with a computing into a computing typewriter.

This machine will add, subtract, multiply, and divide factors contained in specified fields of its calculator, and store or print out (signaling the typewriter to print) the mathematical

results. Its primary use is for billing or for other operations containing mathematics similar to a billing operation, such as purchase order writing. The table below indicates the mathematical capabilities of this type of equipment.

Communicating (Communications)

Standard telecommunication is conducted in five-channel paper tape by commercial communications companies. If data are to be transmitted over these commercial company networks, it may have to be converted to five-channel code. (See fig. 61.)

When Government-furnished machines are at each end of an owned or leased network, data may be sent in five-, six-, seven-, or eight-channel native languages. Figure 77 illustrates a tape transmitter-receiver which can transmit five-, six-, seven-, or eight-channel coded information and can receive in an identical number of channels.

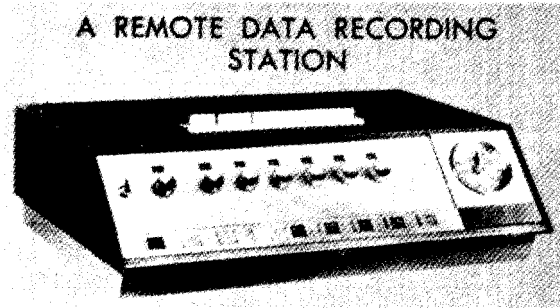

Fig. 74

Figure 78 illustrates a five-, six-, seven-, or eight-channel paper tape transmitter-receiver which can be used in conjunction with the Bell Telephone Co. Dataphone equipment. With this device a sender places a call to a receiving number; after contact has been established he can turn the transmitter on to send and receive tape over the same voice communication lines.

MATHEMATIC CAPABILITIES

NET EXTENSION:

$$\text{Quantity} \times \text{Price} = \text{Net}$$

DISCOUNT EXTENSION:

$$\text{Quantity} \times \text{Price} \left(\text{Net} \times \frac{\text{Discount rate}}{100} \right) = \text{Adjusted Net}$$

GROUP DISCOUNT EXTENSION:

$$\begin{aligned} &\text{Quantity} \times \text{Price} \\ &\text{Quantity} \times \text{Price} \\ &\text{Quantity} \times \text{Price} \end{aligned}$$

$$\text{Sum of above} \left(\text{Net} \times \frac{\text{Discount rate}}{100} \right) = \text{Adjusted Group Net}$$

TRADE DISCOUNT EXTENSION:

$$\text{Successive discounts; e.g., Net}-10\%-2\frac{1}{2}\%-1\% = \text{Adjusted Discounted Net}$$

INVOICE TOTAL

Sum of—

$$\begin{aligned} &\text{Net Extensions} + \text{Tax} + \text{Shipping} = \text{Total, or} \\ &\text{Discount Extensions} + \text{Tax} + \text{Shipping} = \text{Total} \\ &\text{Group Discount Extension} + \text{Tax} + \text{Shipping} = \text{Total} \\ &\text{Trade Discount Extension} + \text{Tax} + \text{Shipping} = \text{Total} \end{aligned}$$

DAILY GRAND TOTAL:

Grand total of net amount, tax amount, shipping costs, etc., will accumulate in the calculator for all documents processed; on call, a summary of the day's business is printed out.

5. CENTRAL COMMUNICATIONS SYSTEM
FOR USE WITH READER
DATA RECEIVERS

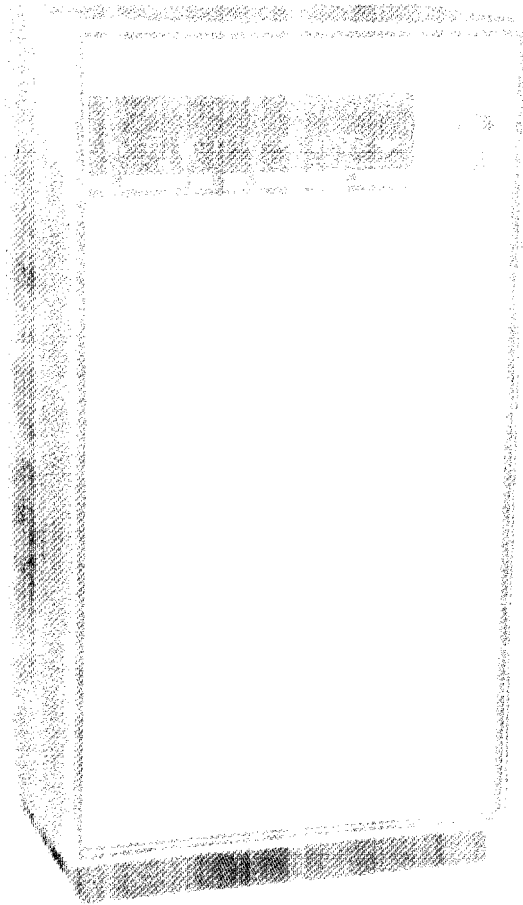

Fig. 75

The receiver can perforate tape and produce hard copy simultaneously.

PERFORMING FUNCTIONS WITH PUNCHED CARDS

Interpreting

Two types of punched-card interpretations are available. First is the use of the printing punch which prints the character directly above the card column where the punching takes place and during the card-punching operation. The second method is accomplished by a separate pass of the punched card through a separate machine known as an interpreter. This permits the printing positions to be assigned to card

8. CARD READING DATA
RECEIVER

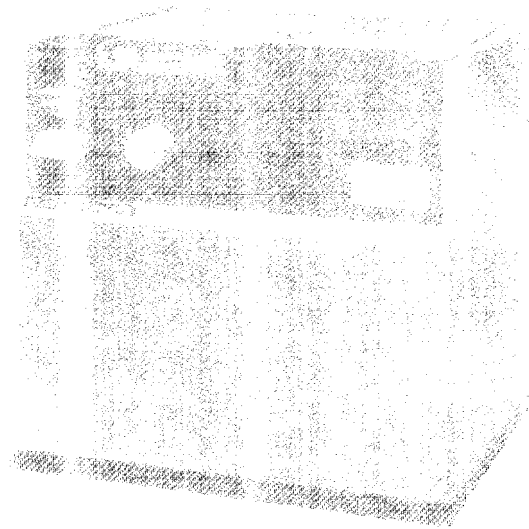

Fig. 76

fields different from those in which the actual punching exists.

Figure 79 illustrates a punched card interpreted in both fashions.

Verifying

Verification of punched cards requires the re-punching of the card on another machine, preferably by another operator.

Cards of 80 columns are verified by a second operator using a verifier. On the previously punched cards this operator simulates the original keypunching, using the source document. If the code for the depressed key

6. TAPE TRANSMITTER UTILIZ-
ING 5, 6, 7, OR 8 CHANNEL TAPE

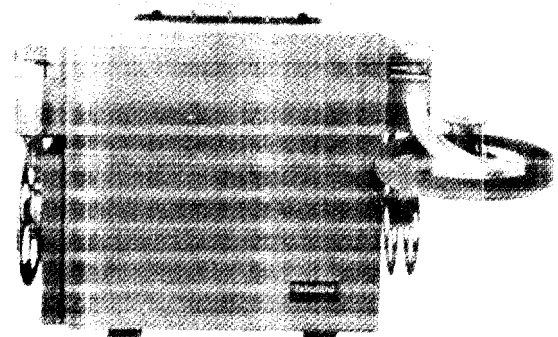

Fig. 77

agrees with the code punched into the card, the machine releases to the next column. If a disagreement occurs, the machine locks. In this event, the operator repeats the operation to be absolutely certain an error really exists. If an error exists it is indicated by a mark in the appropriate column. A correct card is indicated by a notch punched into the edge of the card, figure 80.

Cards of 90 columns are verified with the same procedure as 80-column cards except that the keypunches are combination machines. Pushing a slide on the keypunch converts it into a verifying punch. Actual punching takes place in the verifying operation. The normal round hole is elongated and the operator visually inspects the card through a mirror arrangement when it is ejected. Round holes indicate an error. In addition, a separate automatic verifying machine is available. Verified punched cards are passed through this machine which detects errors. A different-colored card is inserted mechanically behind the card containing an error, to call it to the operator's attention.

Mechanically duplicated cards, or cards prepared as a byproduct, are not manually verified. They are automatically verified by machine circuitry which assures that the punched hole agrees with the pulse sent out by the originating machine.

Writing

Writing data recorded in cards are most frequently accomplished with a tabulator. The tabulator will write recorded facts as—

Detail Listings. Printing a line of information from each card produces a detail listing. During the listing operation the machine may add, subtract, cross-add, or cross-subtract to print out many different machine-generated totals. Figure 81 illustrates a detail listing and the typical associated equipment for producing such a listing.

Group Listings. Group listing is printing on a single line the constant information concerning a group of unit records, such as stock description; and the summary

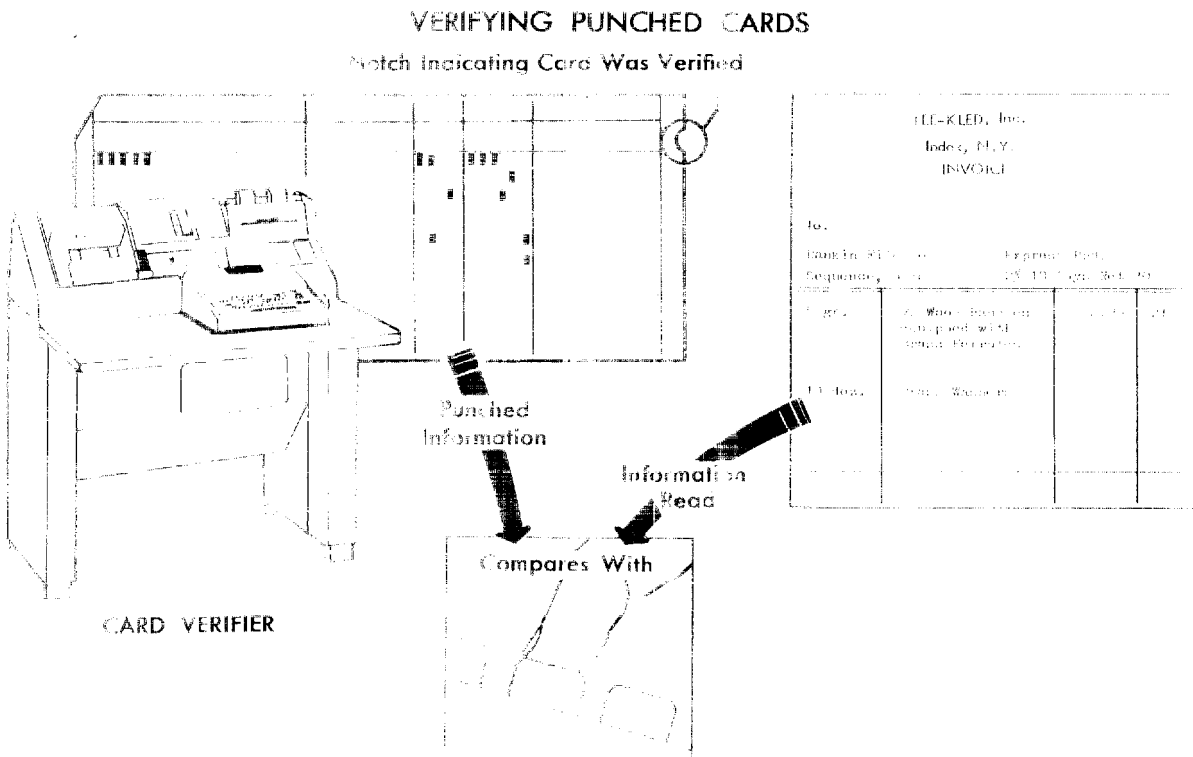

DETAIL WRITING WITH PUNCHED CARD

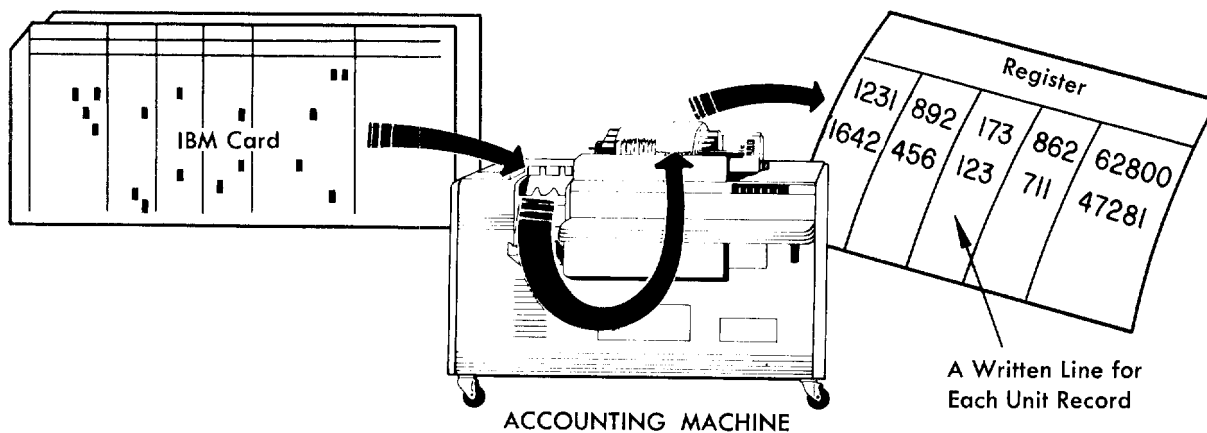

Fig. 81

of the transactions concerning that group, such as issues, receipts, and new balance on hand. During this operation, information from each card is stored in counter units. At the end of each group of unit records, totals are read out of the counters and printed. During the operation, the machine may add, subtract, cross-add, or cross-subtract to produce the machine-generated totals. Figure 82 illustrates a group listing and the typical associated equipment for producing such a listing.

Listings and Punched Cards. While printing either a detail listing or group listing, the machine can produce a punched card containing constant information and summarized numeric data. This requires that a summary punch or document originating machine be cable connected to the tabulator. Figure 50 illustrates a printed report and card operation and the typical associated equipment used for such an operation.

When the tabulator is writing recorded facts, the sequence of data on detail or group listings need not conform to the sequence of data as contained in the card. For example, data punched in columns 75-80 in the card may be more meaningful, useful, and desirable to management if printed in columns 1-6 of the listing. This shift in position can be accom-

plished by a few changes in the control panel of the tabulator. The same thing is true for the summary card produced during report and card operations. Information may be rearranged in punched-card formats by changing the control panel of the summary punch.

Duplicating

A limited amount of duplicating can be accomplished with the keypunch. Data punched into one card can be duplicated, one column at a time, into the same column of the card or cards that follow. (See fig. 51.) Date of transaction, for example, once punched correctly can be duplicated until a new date is necessary.

Another technique of duplicating is known to the trade as reproducing. In this process, punched cards are fed into two hoppers of a single machine; one hopper containing cards with recorded data and the other containing blank cards. The cards are fed synchronously from both hoppers. Data (punched holes) are duplicated card for card. The data in the reproduced deck may be selected data (omitting some facts contained in the already punched deck) or all of the data. The data in the reproduced deck may be rearranged through the control panel of the reproducer. Figure 83 is typical of a reproducing operation with the associated machinery.

Still another method of duplicating is known as "gang punching." In this operation

GROUP LISTING (WRITING) WITH PUNCHED CARDS

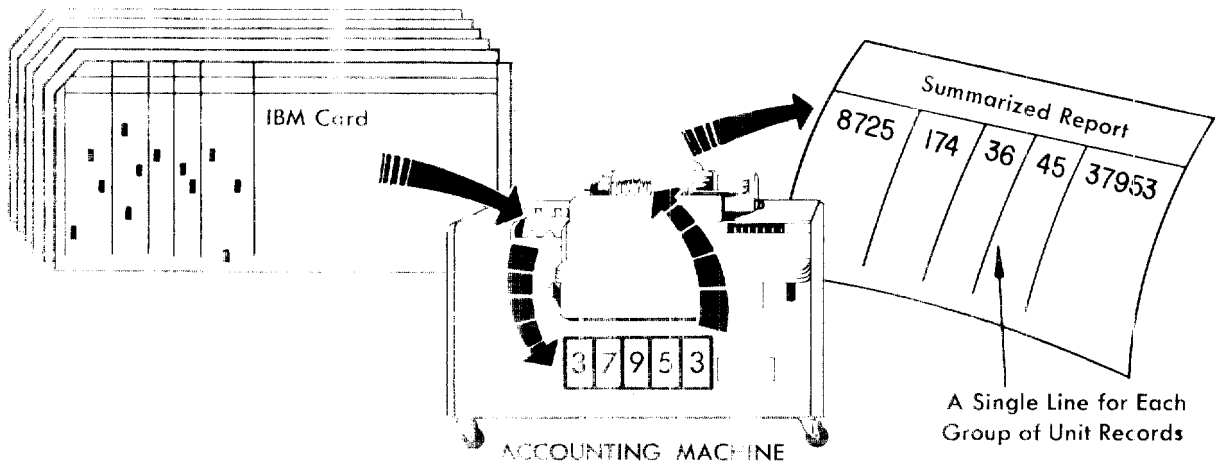

Fig. 82

REPRODUCING PUNCHED CARDS

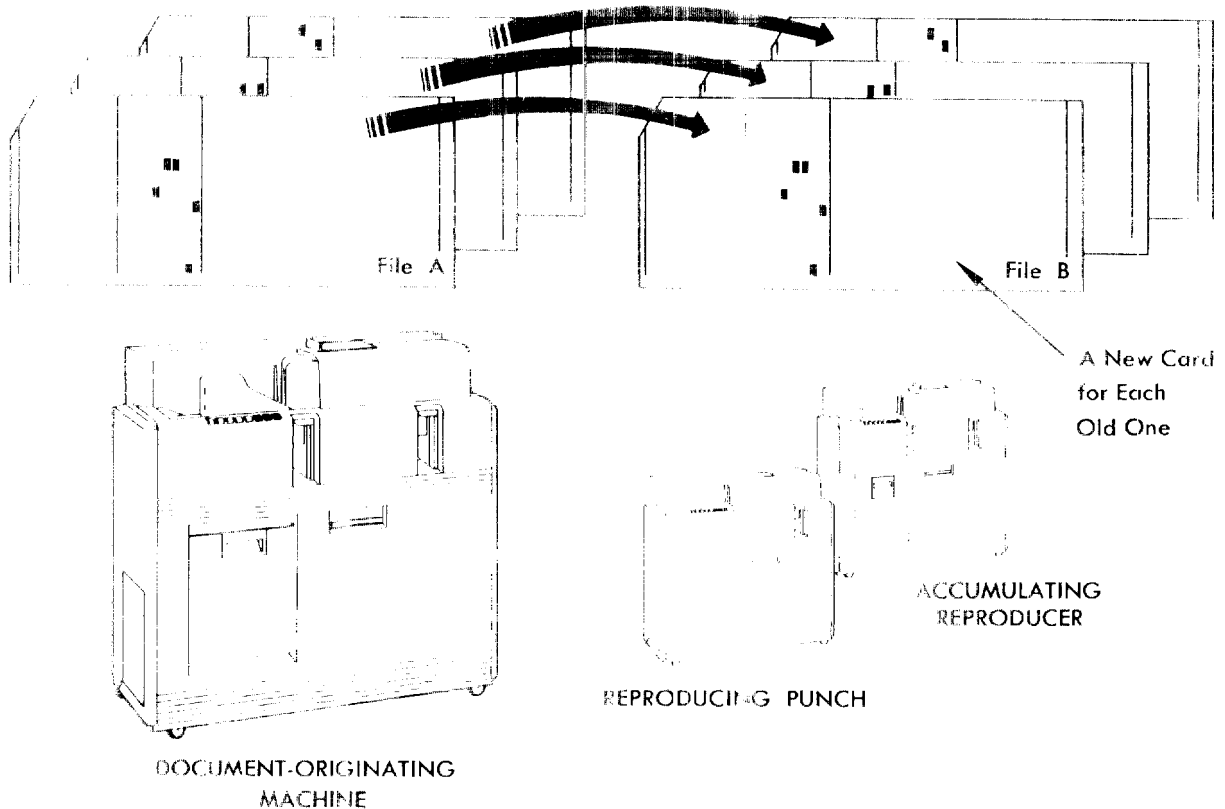

Fig. 83

a master card (card containing data to be duplicated) is placed in front of the number of blank cards into which the data are to be punched. The assembly, master card and blank cards, is then placed into a single hopper of the machine for copying. Data from the master card are automatically duplicated into all blank cards that follow. Duplicating will stop when the machine senses a new master card. Figure 84 illustrates a typical gang-punching operation with its associated machinery.

Arranging

Punched cards are arranged by a machine called a sorter. Figure 85 illustrates a typical sorting operation and associated machines.

Cards are sorted into numerical sequence, one column at a time. An 11-digit stock number requires 11 passes through the sorter to be in complete numerical sequence.

Since alphabetical information is punched with two or more holes in the same column, sorting requires two or more separate passes through the sorter for each column to achieve strict alphabetic sequence.

Selecting

Cards are selected either by a sorter or a collator. Determination of which machine to use is based on the number of cards from which selection must be made and the presence or absence of specific codes upon which the selection is to be made.

Typical selections are—

- Cards punched with a specific digit or character.
- Certain types of cards for a specific date.
- Cards higher or lower than a specific number.
- Cards between two specific numbers or dates.
- First or last card of a group of item records.
- Unmatched cards (when matching one deck against another deck).
- Cards out of sequence, either numerical or alphabetical.

Figure 86 illustrates a typical selection operation and the associated equipment.

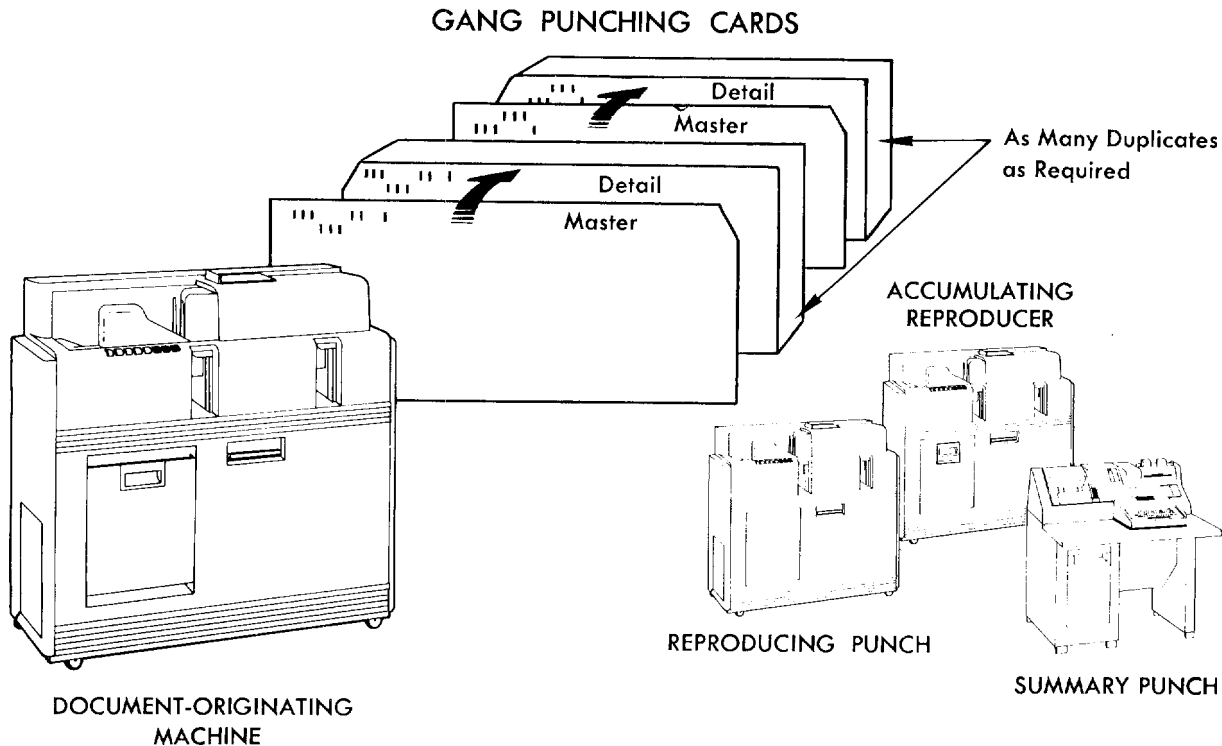

Fig. 84

ARRANGING PUNCHED CARDS

ELECTRONIC STATISTICAL MACHINE

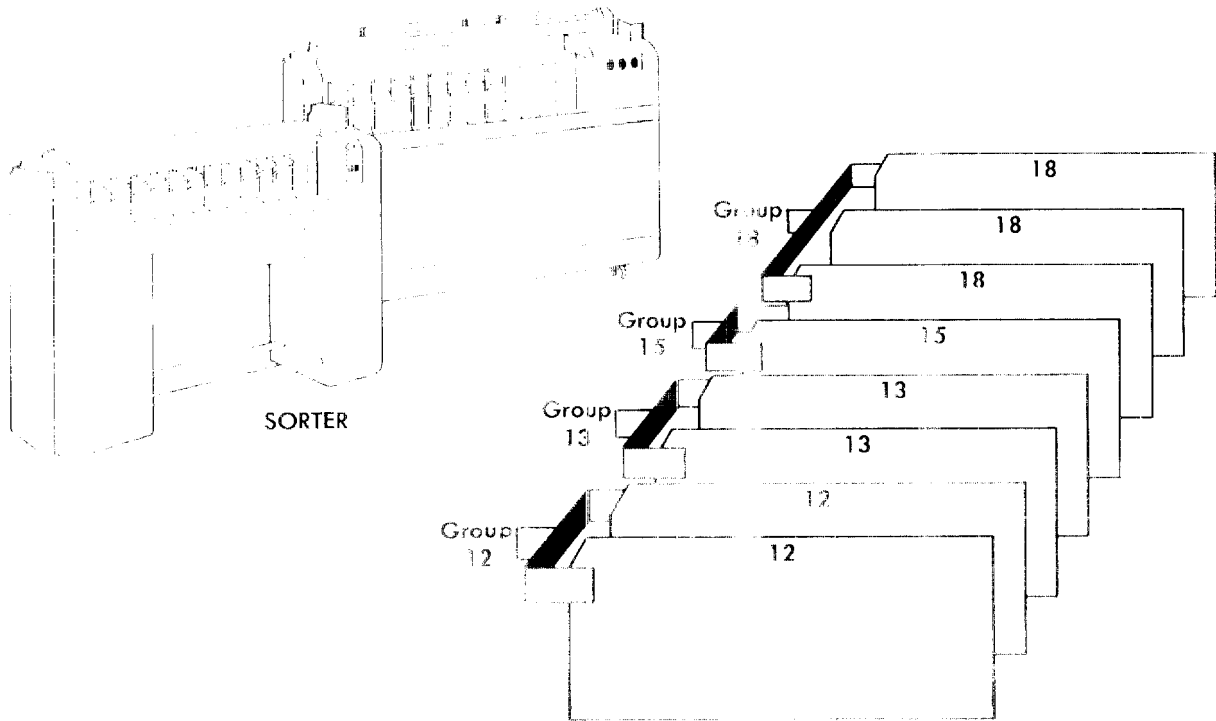

Fig. 85

SELECTING PUNCHED CARDS

ELECTRONIC STATISTICAL MACHINE

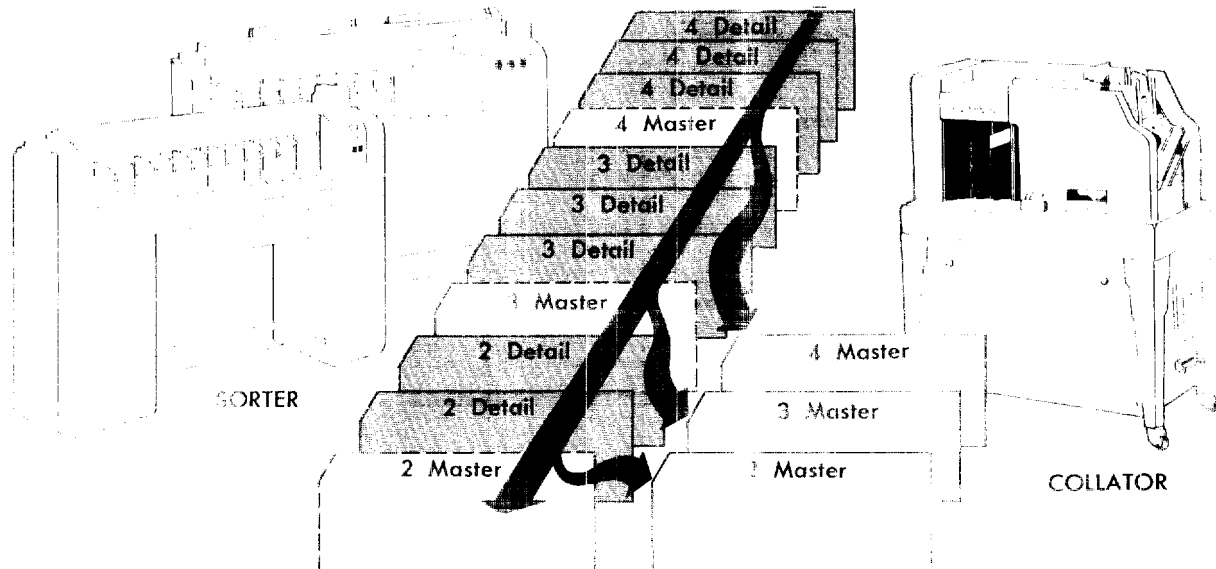

Fig. 86

Merging

Merging punched cards is accomplished with the collator. Two separate decks of cards, each in the same sequence, are placed into two input hoppers. The machine advances cards from each deck independently, tests each card to determine which is of the higher numeric or alphabetic order, and passes the card of the lower order. The machine feeds another card from the hopper which has just passed a card and performs the same checking operation again, checking against the card which was held from the first check. Thus, the two decks of cards are merged into a single sequence in the receiving hopper.

A typical merging operation with associated equipment is shown in figure 87.

Matching

Groups of cards in one deck are matched or compared with similar groups in a second deck by means of a collator. Unmatched cards in either deck may be separated.

Matching is frequently performed in conjunction with merging. Cards in one deck are

merged with a matching card in the other deck; at the same time cards which are not matched by a like card are selected from the deck. Figure 88 illustrates a typical matching and selecting operation.

Correlating Statistics

Discussion of data collection systems equipment is contained in the section "Performing Functions With Punched Paper Tape." Machines can use either punched cards or punched tape as input.

Counting

Counting can be accomplished with the sorter. Each sorter pocket can be equipped with a counting device to record the number of cards in that pocket. The feed hopper can also be equipped with a counter to record the number of cards that have passed through the machine. Thus, the totals of the cards in each pocket can be summed up to equal the number that have passed through the machine.

Another piece of equipment, commonly used for counting recorded facts, is known as

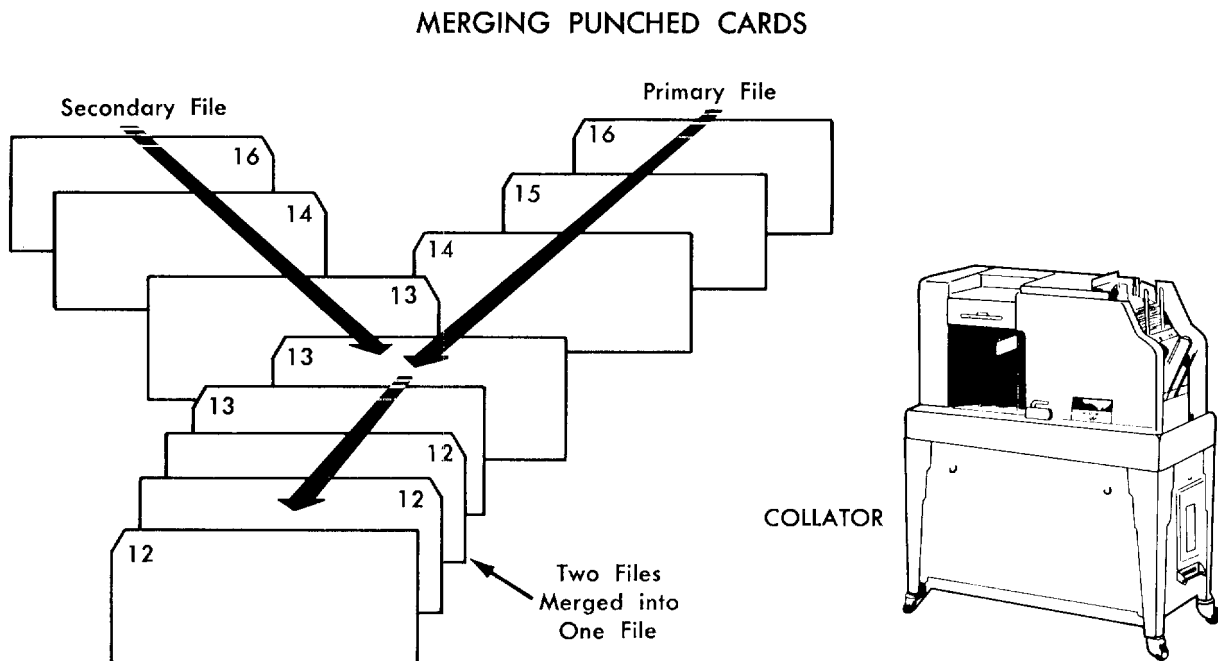

Fig. 87

the statistical sorting machine. This machine consists of a sorter and a stripped-down tabulator capable of performing limited mathematical operations and limited printing. Among its functions the machine sorts, counts, checks for consistency, adds, and produces printed summaries. When not in use to perform statistical work, this machine can be used as a conventional sorter. Figure 89 shows such machine.

Computing

The type of computation required determines the type and models of punched card computing machines used.

A tabulator, such as that illustrated in figure 81, will, for example-

- **ADD** any field punched in a series of cards until a signal is received from the machine that a minor class break has occurred (e.g., a change in stock number).

- **SUBTOTAL** any field punched in a series of cards until a signal is received from the machine that an intermediate class break has occurred (e.g., a change in a group of stock numbers).
- **TOTAL** any field punched in a series of cards until a signal is received from the machine that a major class break has occurred (e.g., a change in a class of stock numbers).
- **GRAND TOTAL** any field punched in a series of cards until all of the cards in that particular job have been completed (e.g., the dollar value of all stock items issued today).
- **SUBTRACT** any field punched in a series of cards to affect the addition, subtotal, total, and/or grand total of that field. A signal (hole punched somewhere in the card) must indicate that the quantity is to be subtracted.

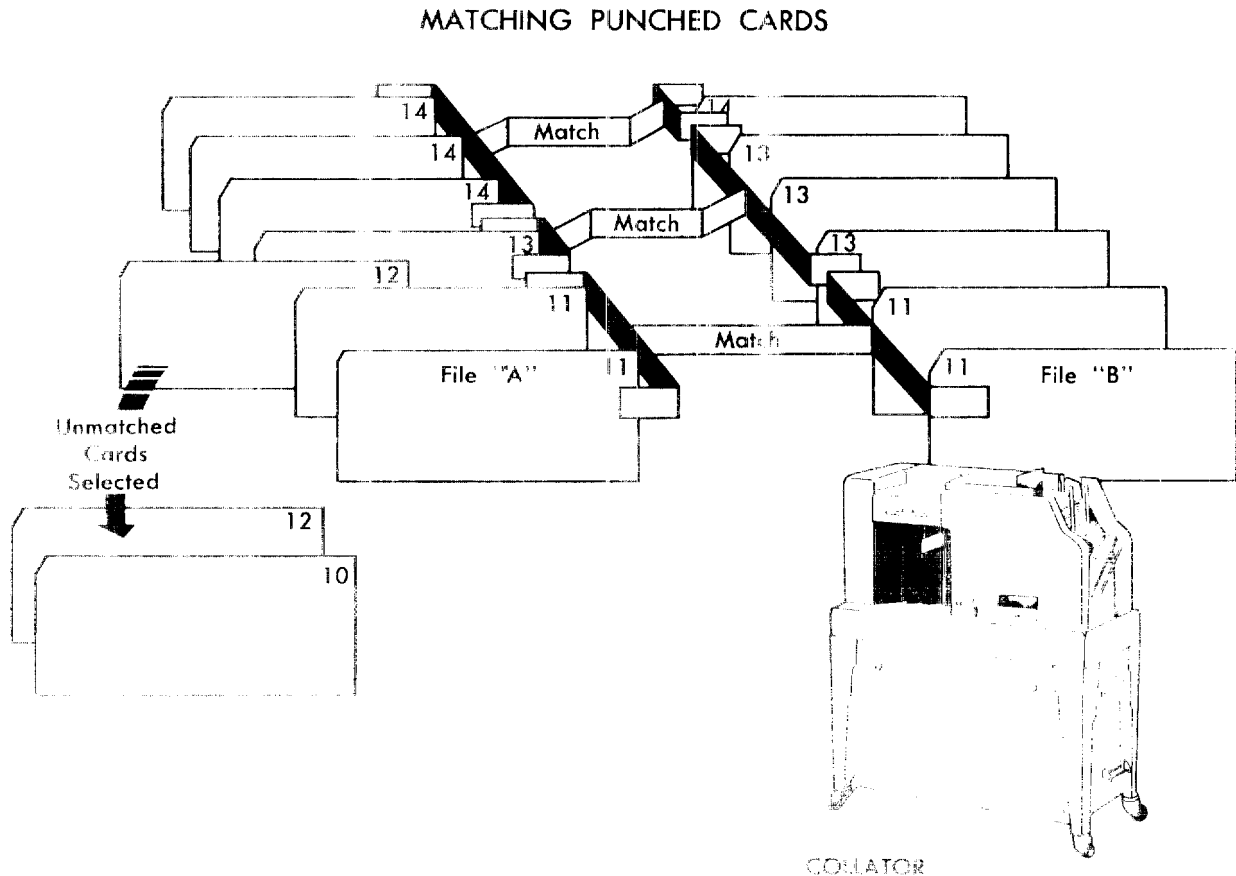
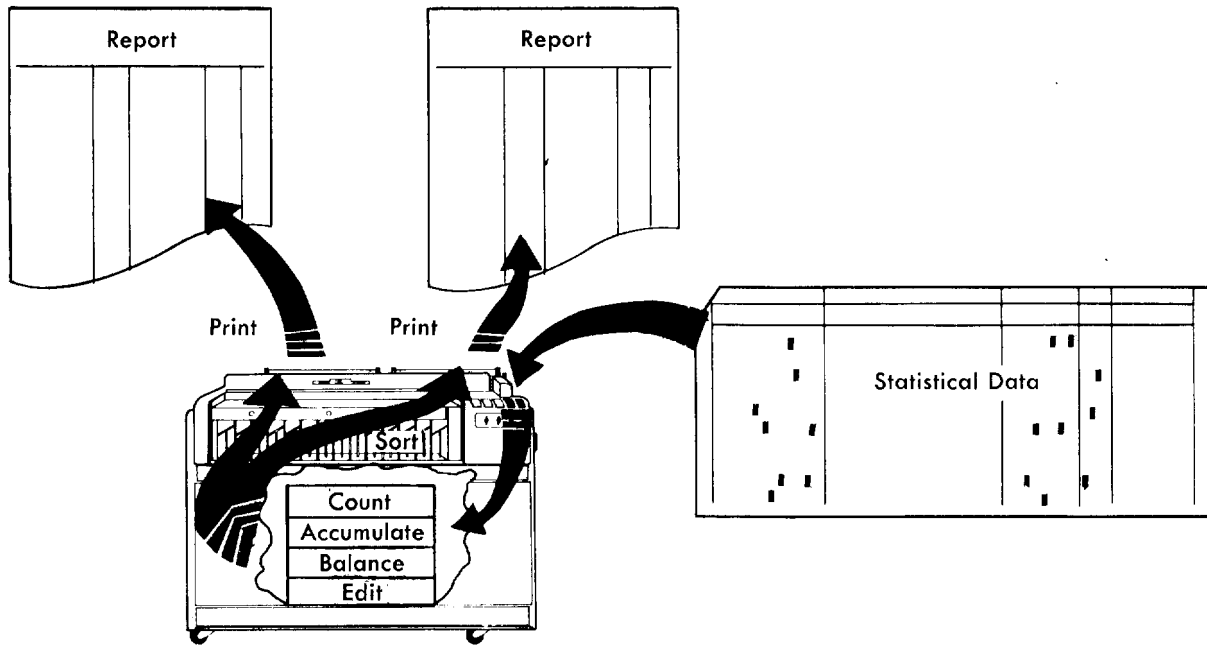

Fig 88

COUNTING AND STATISTICS WITH PUNCHED CARDS



ELECTRONICS STATISTICAL MACHINE

Fig. 89

- **CROSS-FOOT** add or subtract across a single line entry to arrive at an updated total for that line (e.g., opening balance—shipments+receipts=new balance for an item of stock).

Any totals can be printed on the report being prepared by the tabulator or can be punched in a summary card. Both products can be obtained simultaneously when a summary punch is connected to the tabulator. (See fig. 50.)

The printed result of mathematical operations may be located immediately below a column of figures, as on an adding machine tape; or may be located on another part of the line to make the result outstanding, as on a book-keeping ledger.

With the addition of another piece of punched card equipment, the calculating punch, multiplication and division can also be performed.

Factors to be calculated may be—

- Read from a single card.
- Read from a series of cards.

- Emitted by devices within the machine.
- Developed by the accumulation of a series of results of calculations.

With the calculating punch, as its name signifies, the final result or intermediate results are punched into a card for processing by other punched-card machines and are not printed directly to a report.

Cable connecting the tabulator, the calculating punch, and a storage unit produces an assembly of punched-card equipment known as a card-programed-calculator. When this is used, the tabulator reads from the punched cards the factors for calculation and the instruction codes. The factors and instructions are then introduced into the several cable-connected machines. Calculations are performed in accordance with the instructions. The storage unit makes possible the holding of figures until they are needed in the calculations. Upon completion of the calculations, results may be printed on a report by the tabulator, punched into a card by the calculating punch, or both.

Figure 90 illustrates a card-actuated typing calculator. Functions performed by this machine are similar to those described for the tape-actuated computing typewriter.

Communicating

Data on punched cards may be sent over a communications network and recorded at the other end on punched cards. If volume transmission is required, machines called transceivers are used to serve both transmitting and receiving functions. Figure 91 is typical of a transceiver.

If a small number of cards is involved in transmission, Bell Telephone Co.'s Dataphone may be used. This operates in the same manner as previously described for transmission of data from tapes.

A PUNCHED CARD ACTUATED
WRITING—COMPUTING MACHINE

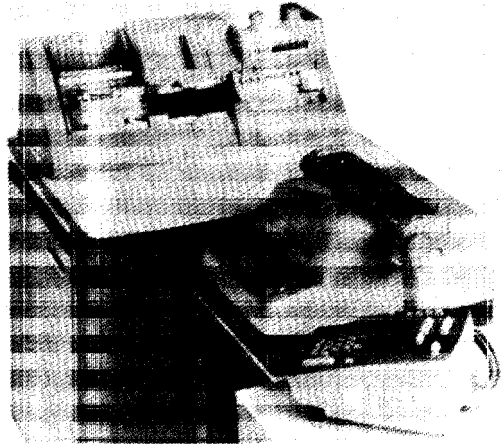

Fig. 90

TRANSMISSION OF PUNCHED CARDS

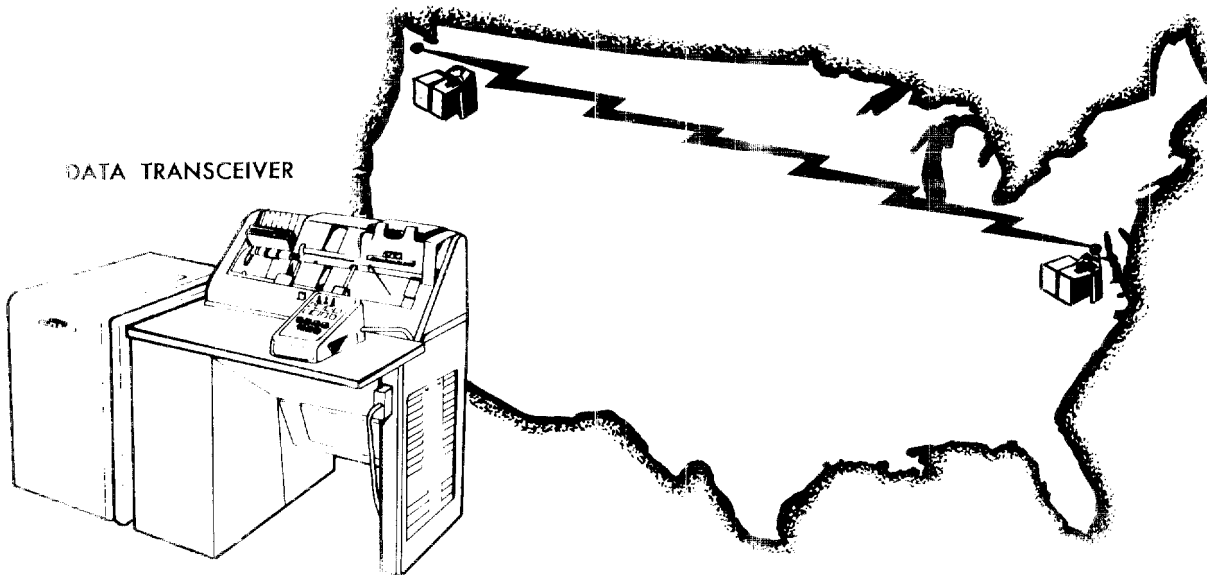

Fig. 91

VI. FINDING AND DEVELOPING APPLICATIONS

Finding and developing a source data automation application is not different, to any great degree, from any other paperwork systems project. A systems analysis is required. Certain portions of that analysis and study, however, take on added significance when the potential of mechanization is included.

WHAT IS SYSTEMS ANALYSIS?

Systems analysis is the examination, *in detail*, of the functions, routines, procedures, and methods, which go to make up a system, and the organization which fathers the system. The analysis includes defining a problem area, describing existing ways of performing work, exposing the deficiencies of those ways, determining what the *real needs* are, systematizing present operations, and developing new means to accomplish program objectives.

Frequently a systems analysis is undertaken to apply the techniques of source data automation. It must be remembered, however, that a paperwork study should have as its objective systems improvement, not necessarily automation. No one advocates mechanization for the glamour of owning automated equipment. The systems study undertaken to consider the possibilities of mechanization offers an opportunity to eliminate inefficiencies in existing methods and procedures, even when the final conclusion does not support mechanization. The time spent on systems analysis is not wasted when mechanization is not the final result—other systems improvements will usually pay for the effort.

This chapter will not be full-scale instruction on how to conduct a systems analysis. That is a subject entirely too broad for treatment here. Rather, the chapter briefly reviews the major systems areas which merit greater study when source data automation becomes involved in the solution of a problem.

FINDING THE AREA TO STUDY

Clues to the need for paperwork systems studies include, among other things, difficulty in obtaining needed documents or information,

peak workloads requiring excessive overtime, inability of a step in the paperwork cycle to keep pace with the other related operations, high error rates, inaccurate information, and so on. Within these broad clues to potential improvements, however, there are specific clues that lead to source data automation as a potential solution to problems.

What To Look For

The four clues to potential source data automation applications are—

- Repetition.
- Volume.
- Urgency.
- Errors.

The first two of these clues will always be present in potential source data automation situations—they are by far the most important considerations. Someone has said: “Repetition is the key to source data automation, and volume the justification for the change and the procurement of necessary equipment.”

The last two of these clues may or may not be found, but if they are found they usually add to the justification for automation. Occasionally, they may even outweigh volume as a justification, though volume is usually also present.

Repetition

What is meant by repetition? The typist in a stenographic pool prepares letters all day long. Her work may look to her like repetition, one letter after another all day long. Her work, though incessant, is not suited to automation. The kind of repetition that offers possibilities for source data automation is repetition of data, not repetitive tasks. The typist may have repetitive data, if pattern paragraphs can be used to answer a substantial portion of the correspondence, but not if each letter is different and must be individually composed to fit each case.

Examples of the types of repetitive data found in potential source data automation applications are the same name, address, date

of birth, sex, and nearest of kin; the same stock number, stock description, shipping point, and destination of shipped material; or the same project number, project description, expenditure account number, and project status. This repetitive data may be written two, three, four, or even a thousand times during a paperwork cycle.

An employee first reporting for duty is confronted with form-to-form repetition. He repeats his name, address, age, social security number, marital status, and sex several times over as he fills in form after form. The items are not always in the same location on each form, nor in the same sequence on each form. Only part of the information is needed on some of the forms. But the answers are the same each time—repetitive data.

Other common paperwork cycles which contain highly repetitive data include procurement, project progress reporting, work measurement, accounting, and disbursement. Most of these systems require the same data on many different forms serving many different purposes.

LOOK for Repetition

REPETITIVE USE OF DATA

NOT REPETITIVE TASKS



Fig. 92

There are several different categories of repetition, including:

Form-To-Form Repetition The transfer of repetitive data from one form in a paperwork system to another form in the same system is a common type of repetition. The repetitive data may be placed in another location on the second form, additional data may be added, or only part of the repetitive data may be used.

Recurrent Repetition Recurrent repetition, as used here, means use of repetitive data over and over on the *same* form in a paperwork system. Each time the form is used it may contain data different from that appearing the preceding time. However, an analysis of many of the forms might show the same data appearing occasionally or at regular intervals. Perhaps the best example of this type of recurrent repetition is an invoice. The customer identification remains the same even though a sale is not made to him every day. It remains constant regardless of the items of merchandise sold him on a particular day. The item description of the merchandise remains the same regardless of the customer to whom sold. These are examples of recurrent data. The quantity, the price, the extension

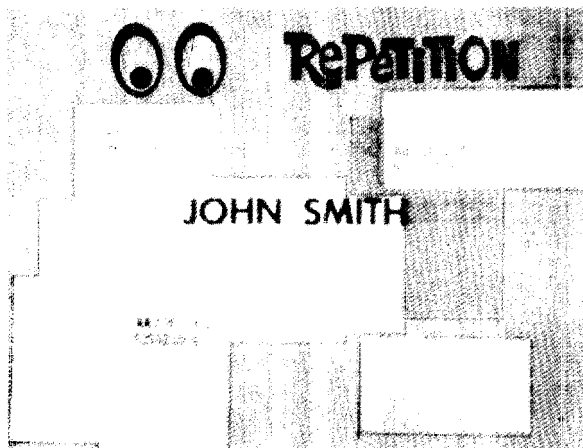

Fig. 93

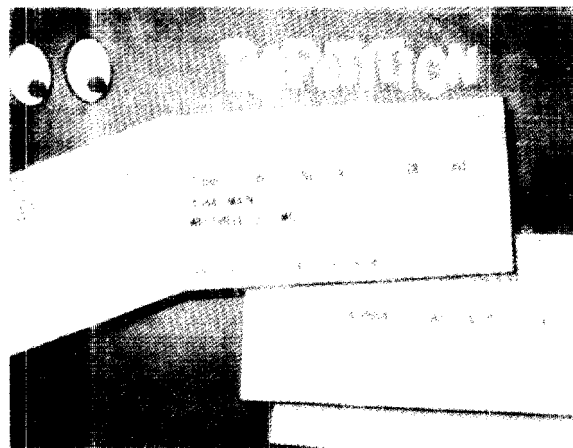

Fig. 94

and the discount may vary from sale to sale, from customer to customer.

Other paperwork cycles which contain recurrent repetitive data include purchase-order writing, personnel promotion and reassignment, contract preparation, shipment and back-order writing, and correspondence answerable by pattern paragraphs.

Statistical Repetition Here is a more illusive type of repetition than those types discussed before. It is the repetition of numbers, which may lose their identity in summaries at different levels of agency organization.

Perhaps the best example of statistical repetition is that usually found in reporting progress on some project. The production figures of the employees at the bottom of a reporting ladder become lost as they are absorbed in the cumulative figures sent forward.

Even though the original figures appear to have been lost, they are actually still involved. Hence, repetitive data is still present.

Other paperwork cycles which contain statistical repetition include work measurement, fiscal accounting, performance recording, and stock-class accounting.

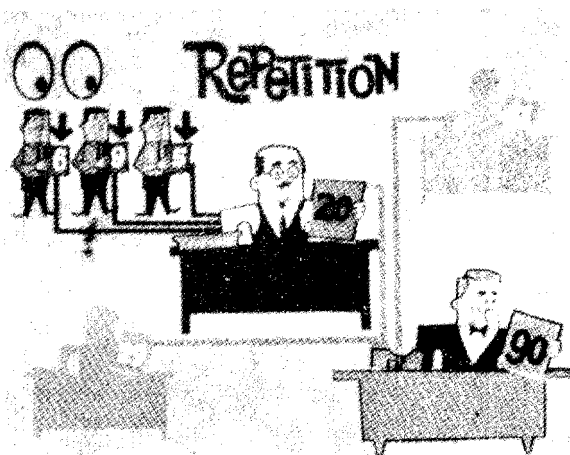

Fig. 95

Volume

What is volume? How much volume is adequate to justify source data automation? The clerk in one office has a high stack of papers on his desk. Is this the kind of volume adapted to automation? Probably not. The kind of volume that lends itself to automation is the volume of repetitive data, not total workload.

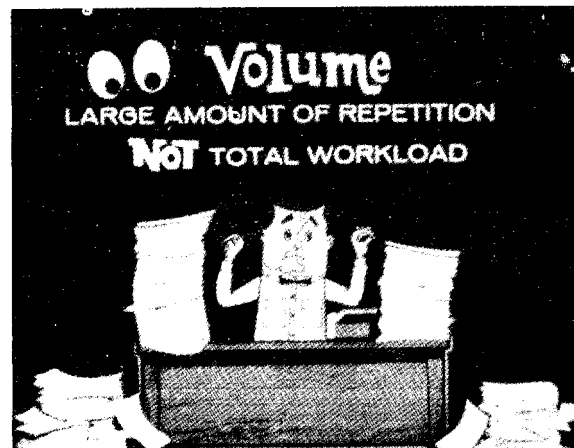

Fig. 96

Repetition of data is the key to a potential source data automation application, and volume of repetitive data is the principal justification. There are several different categories of volume:

Gross Volume Gross volume includes use of repetitive data from form to form, recurrent repetition, or both. The number of times that repetitive data are used in a complete paperwork cycle is the key to potential automation.

The best examples of gross volume are the previously discussed operations of the personnel records and the invoicing operation. Perhaps only a small portion of the complete data is repetitive, but the number of forms used per day, or the number of different forms on which the data appear, soon builds up sufficient gross volume of repetitive data to justify source data automation.

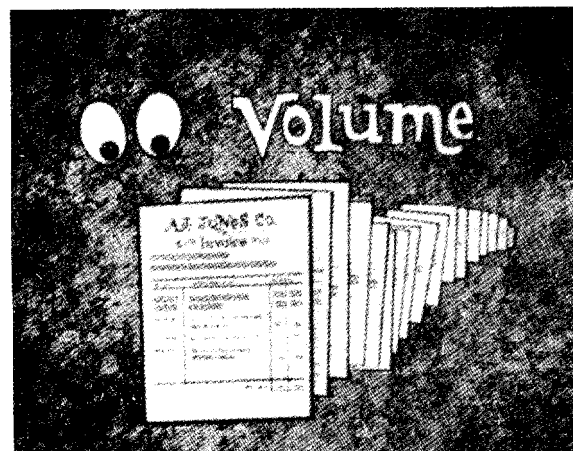

Fig. 97

Dispersed Volume Many of the typists in a personnel typing pool have a pile of varied forms and letters to type each day. Part of the daily volume for each girl is a number of Standard Form 50's to be prepared. Any one desk does not have sufficient volume of these forms to justify source data automation. However, repetitive data are present in volume: it is simply dispersed among the individual typists. Concentration of the form 50's at one desk of the typing pool may produce sufficient volume to justify source data automation.

Repetition in dispersed volume is often difficult to recognize. It may be beyond the confines of one room - it may cross section, bureau, division, branch, or agency organizational lines. It may even be dispersed between industry and the Government or between Federal agencies and the people they serve.

Examples of dispersed volume include reporting of earnings to social security, checking age and survivors benefit eligibility, billing insurance premiums, and purchasing of stock items.

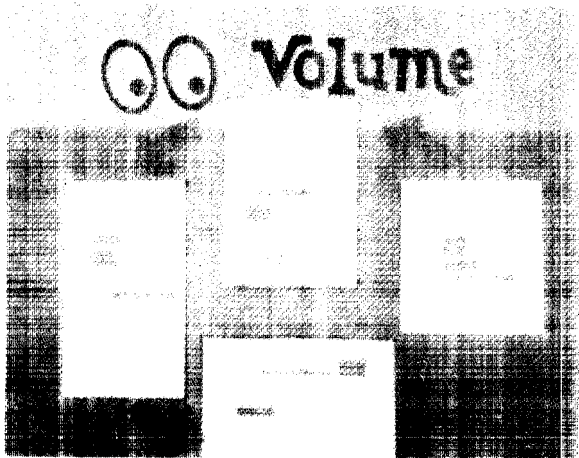

Fig. 95

Urgency

The typist in an office has a desk full of typing that must get out before the close of business today. Is this the kind of urgency looked for? Certainly this job appears to have urgency and volume, but not necessarily enough volume of repetitive data.

When other conditions have been met, source data automation can help offices to meet

realistic deadlines. Automation can be particularly useful where periodic peakloads are involved. Frequently, for example, project progress reports from field offices to a central office reflect conditions at the close of a month. These statistics must be keypunched for machine analysis before the fifth day of the next month, if the report is to be timely and useful to management. Certainly this kind of operation has the sought-for repetitive data, repetitive volume, and urgency. Perhaps, the data could be source data automated in the field offices, eliminating the urgent keypunching operation in the central office.

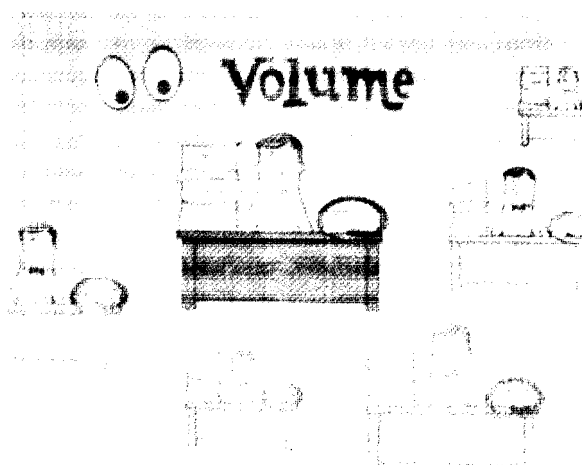

Fig. 96

At times the work of several employees is checked for accuracy by a single reviewer; then it flows to several more employees for the next step in the operation. That review may be creating a bottleneck, no matter how important the task. Perhaps automating the work of the employees can eliminate the check and break the bottleneck.

A wage earner is retired from his job. He applies for his pension. He awaits patiently the check due him on the first of the month. In fact he may be desperately in need of the money for the essentials of life. Source data automation may make it easier for the office to meet this deadline.

Urgency is usually not in itself sufficient justification for source data automation. Often however, urgency stimulates inspection of the paperwork cycle, which in turn reveals sufficient volume of repetitive data to justify automation.

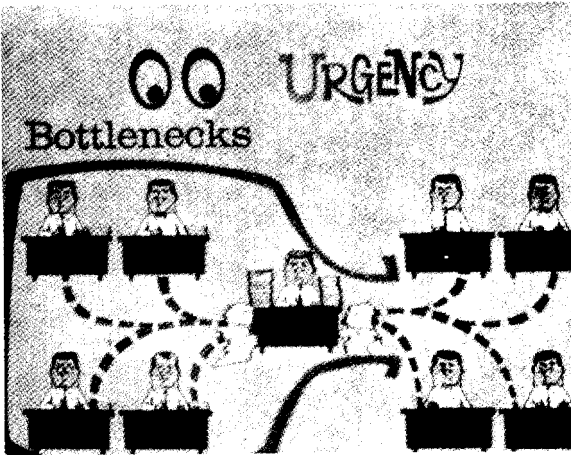

Fig. 100

Errors

An invoicing clerk typed the form shown in figure 101. That error cost \$135. A mathematical error, to be sure, but one which a machine would not have made.

A stenographer was told to type the bottom line, shown in figure 102. She wrote the top one instead; once in the mail, the document became a binding letter of intent, a costly error.

Correction of errors of this nature is not sufficient reason for source data automation, unless they involve repetitive data. Human errors occur in the handling of volume repetitive data—errors of transcription, transposition, or mathematical computation. These are errors that a machine, properly operated from a native language, will not make.

QUANTITY	PRICE	AMOUNT
3,000	\$.05	\$15.00

QUANTITY	PRICE	AMOUNT
3,000	\$.05	\$150.00

Fig. 101

Areas which warrant further exploration for errors are the typing of stock numbers, phone numbers, social security identification, employee number, project numbers, and so on.

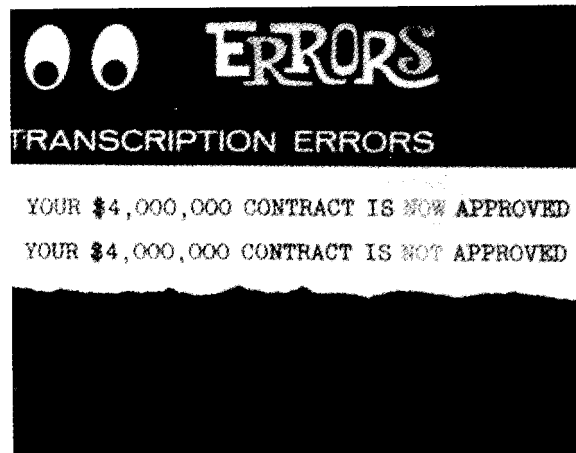

Fig. 102

Where To Look

The question of what to look for inevitably raises the question of where to look. Where are repetition, volume, urgency, and error to be found?

Potential applications of source data automation can turn up anywhere. Several places,

SOURCE SPOT OF AUTOMATION

It has become more and more apparent that with the planning and installation of grandiose electronic data processing equipment, too little attention has been devoted to the concepts and techniques of source data automation.

This inattention to capturing and processing data in machine language at the source has led to serious problems and increased costs in some of our Navy EDP systems

The time to apply source data automation to our integrated information systems is long overdue. Why not realize the benefits of source data automation by (1) recording information at the point of origin in order to utilize the full potential of our electronic data processing machines, and (2) record and process data at the source in order to capitalize on the advantages of automation at the operating level?

Figure 103

however, are almost certain to be hiding possibilities, waiting to be found.

No doubt, most of the existing source data automation applications were found in one or more of the following places:

- Where native languages are deliberately produced.
- Where information is recorded about—
Persons.
Places.
Things.
- Where two or more machines are used in a paperwork chain.
- Where more than one form is used in a system.
- Where statistical reports originate.

Deliberately Producing Native Languages
Papers flowing into a machine processing room, tabulating section, data processing center, punched-card room, or similar area are coming there for one purpose: translation into a native language, such as punched card, punched tape, or magnetic tape, for further machine processing. The Department of the Navy, in figure 103 published in the Navy Management Review of August 1958, recognized this fact.

It is reasonably certain that any job being performed in a machine-processing section has repetitive data in sufficient volume to justify source data automation. Someone found these clues in the past, in order to get the job into the machine-processing operation. Now the problem is moving the automation, the capturing of data, closer to the source. Perhaps the data could be captured as a byproduct of a necessary operation, or even placed into a native machine language by the originator.

The slowest, most tedious, and most costly operation in a machine-processing section is the manual depression of the keys of a machine to translate data into a native machine language. The accuracy of all future results depends upon the accuracy of keypunching and key verifying. If the personnel who have a vital interest in the data can create a native language, as the byproduct of a necessary operation, the accuracy of machine results will be increased.

Recording Data About Persons, Places, or Things. Many of the source data automation systems operating today involve the use of data concerning persons, places, and things.

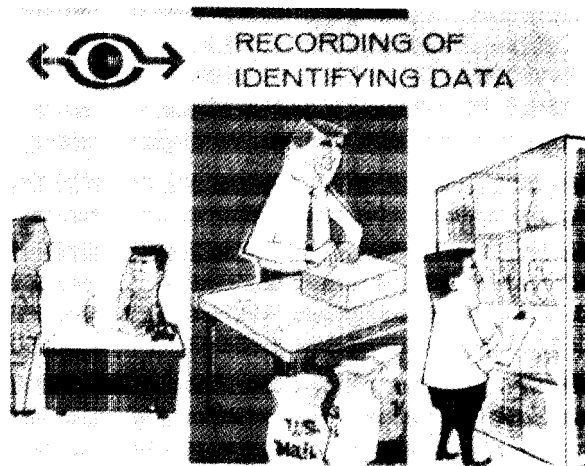

Fig. 104

Personnel offices, both civilian and military, have found it advantageous to capture personnel identification in a native machine language.

Transportation offices have discovered applications involving shipping data, consignee data, and carrier routing, which have reduced their operating costs. Supply and contract offices have found automation helpful in requisitioning, receipting, and managing inventories.

Two or More Machines in a Paperwork Chain. Whenever two or more machines are involved in the same paperwork chain, it is almost certain that data are being written a second, third, or fourth time. It is repetitive data that could be source data automated.

The first person in the systems cycle, figure 105, may use a typewriter to create a document; the second may use a calculator to compute



Fig. 105

statistics or extensions on the document; and the third may retype part of the document with summary totals. The cycle is then repeated from office to office.

Application of the technique of source data automation can often permit bypassing the second or third machine; or byproducts produced in a native machine language at the first operation can operate the second or third machine.

More Than One Form in a System. One of the first types of repetition discussed in this chapter is the "form-to-form repetition" of data. Thus it follows that a logical place to look for source data automation potential is where two or more forms are used in a paperwork chain.

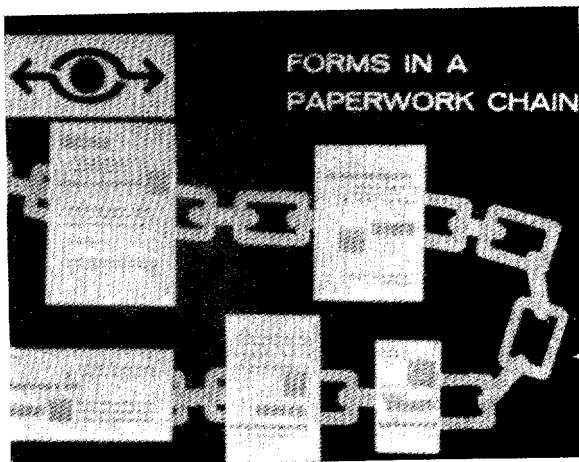

Fig. 106

It is almost a certainty that, if more than one form is used in a paperwork cycle, data will be repeated from form to form. All or part of the data recorded on the first form will be transcribed to the second; the data, all or in part, from the second to the third; the data from the third to the fourth and so on.

Source data automation can often mechanically produce the repetitive data onto the second or third form involved. The chances are that in any form handled daily there is a potential application.

Originating Statistical Reports. Administrators, whether of sections, branches, divisions, or agencies, need reports to run their organizations effectively. These reports to management start a tremendous paperwork operation.

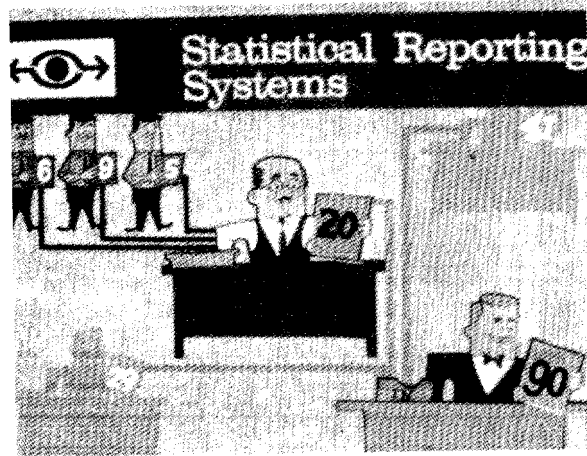

Fig. 107

In almost all statistical reporting, data are consolidated at every echelon of organization, for passing up the line. Much of the data is repeated over and over. All that changed was the summarization of several individual reports into one report. An effective technique involves passing the data directly from the originator to a point as far up the line as possible. Data are then digested at this point, and summary data transmitted to the echelons that were bypassed. More accurate reports are thus obtained at each level, and more timely reports are available for the higher levels of management.

CONDUCTING THE STUDY

Supervisors have a tendency to omit or overlook some vital factor in a paperwork chain when they develop revised methods. For prevention of loss of some vital data or factor of the paperwork cycle, the facts obtained by a systems study should be in writing. Frequently an overlooked item gives rise to much additional work, causes a procedure modification, or even destroys the validity of the whole effort.

Figure 108 summarizes the many facets of a systems study. Factors are also reflected in the chart which must be taken into account if the application is designed to capture data for ultimate use in a computer.

The importance of obtaining facts about the job directly from the working level cannot be over emphasized. Interviews with officials and working-level personnel can succeed in gaining their support of methods improvements.

FACETS OF A SYSTEMS STUDY

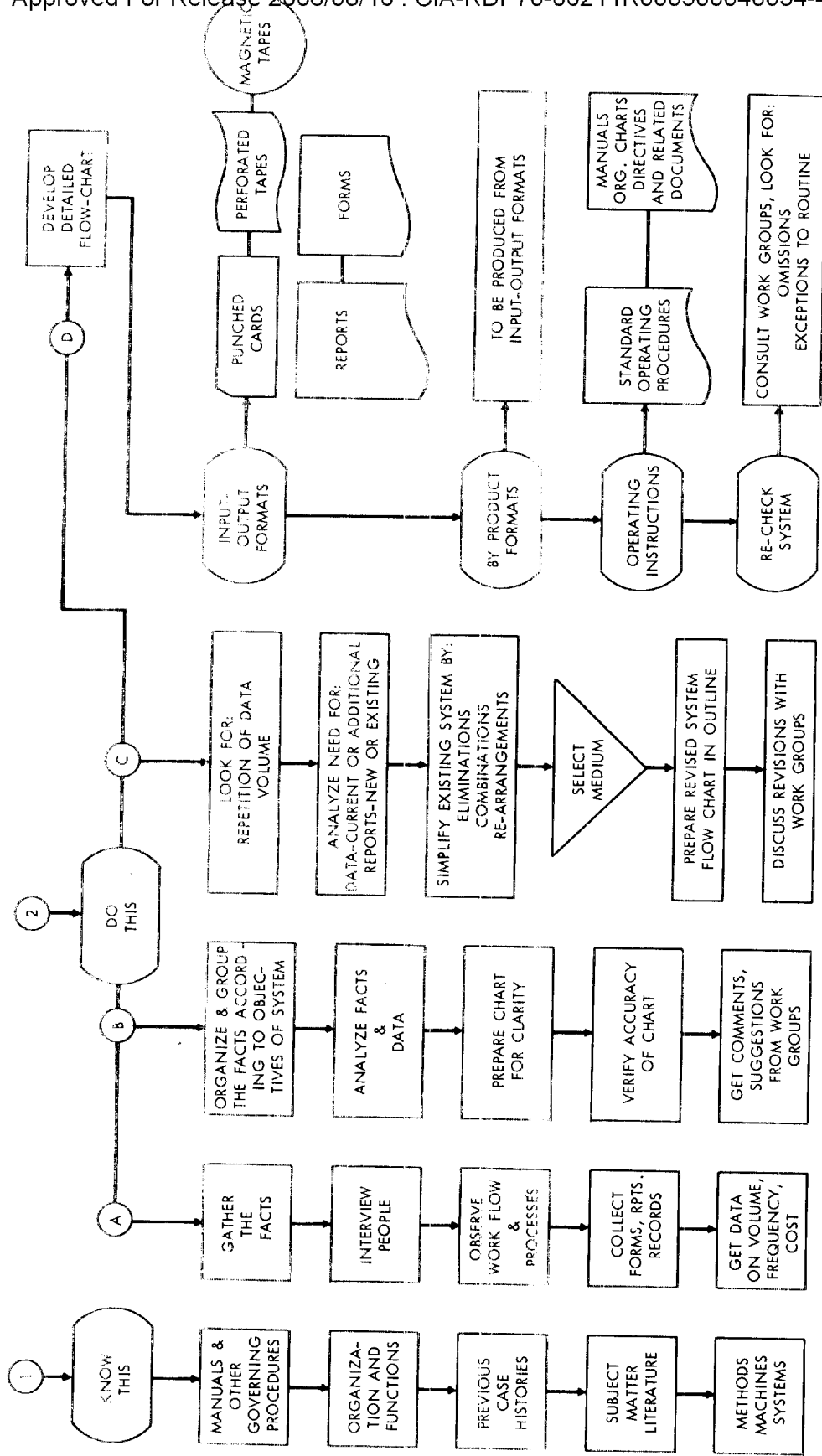

Fig. 108

A Total Systems Study

Frequently source data automation applications cross section, branch, division, office, or even agency organizational lines. Thus, one of the first considerations is the need for a study of a *total system*.

A systems study would prove ineffective if, in automating one step of a paperwork cycle, it complicated another step in the cycle. If it destroyed, unwittingly, the existing mechanization of a step of the system, it could be costly. It is imperative therefore that every detail of the entire paperwork cycle be fully understood; that the effect of the system on related paperwork, reports, operations, and organizational structures be clearly foreseen.

A total systems study of the paperwork cycle may result in—

- Elimination of the operation or elimination of steps in the complete paperwork cycle.
- Reorganization to bring together adequate volume to justify mechanization.
- Drastic change in the basic approach to the entire paperwork system.

Data Analysis

Another element of a systems study to take on added significance is that of data analysis. Frequently bits of data have been collected because someone thought they would be nice to have; that someday someone might ask for them. Data collected in an automated system must serve some useful and productive purpose, if the effort expended for its collection is to be justified. On the other hand, all data essential

REQUISITION—SDA1					
APPROPRIATION CHARGEABLE CO. 1102-2. 41501. 262		REQUISITION DATE 15 April 1962		REQUISITION NO. 39101-108	
TO			SHIP TO United States Automation Agency Washington 25, D.C.		
MARK FOR Training Department		ORGANIZATION Records Mgmt.		F. O. B. Shipping Point	
DATE REQUIRED 15 May 1962		ROUTING Air Express		TERMS 30 Days Net	
QUOTATION APPROVED BY John Smith		PRICE			
ITEM	QUANTITY	NOMENCLATURE AND DESCRIPTION			PRICE
	12	265-9847. Films (SDA Workshop)			
SDA 1					

Fig. 109

REQUEST FOR QUOTATION—SDA2				
APPROPRIATION CHARGEABLE CO. 1102-2. 41501. 262		QUOTATION DATE 16 April 1962	QUOTATION NO. 39101-108	
TO (Various Vendors)		SHIP TO United States Automation Agency Washington 25, D.C.		
MARK FOR Training Department		ORGANIZATION Records Mgmt.	F. O. B. Shipping Point	
DATE REQUIRED 15 May 1962	ROUTING Air Express	TERMS 30 Days Net	QUOTATION APPROVED BY E. A. Jones	
ITEM	QUANTITY	NOMENCLATURE AND DESCRIPTION		PRICE
1	12	265-9847. Films (SDA Workshop)		
SDA 2				

Fig. 110

to the end products of a paperwork cycle must be available. It must be recorded in a native language to take full advantage of the automatic equipment selected for the job.

One of the best ways to determine the data that are repetitive is to assemble a complete set of all of the forms currently used in the paperwork system—filled in for every item of information. Areas on the forms which contain data that are repeated from form to form are colored in. Care should be exercised to get the repetitive data, not necessarily the repetitive item identifications. Varying title or item identifications may be used to record repetitive data in the various steps of a paperwork cycle. Although the identification used on a different form may vary, the filled-in data are identical. On the four forms shown as figures 109, 110, 111, and 112, various captions are used to identify the same filled-in data.

In the analysis, all data from all forms involved in the paperwork system are recorded on a "Recurring Data Analysis Chart" (Optional Form 18). Figure 113 is a chart of this nature, filled in for the four forms previously mentioned.

Coloring-in the areas containing identical data establishes the data which is repetitive and which lends itself to being recorded in a native machine language. Recording the data on a "Recurring Data Analysis Chart" identifies the number of times each item is repeated. It also establishes the point of first writing for each item of repetitive data, the point where the data are best recorded in a native machine language.

Reports Evaluation

The fact that a report is presently prepared in a specified manner, with certain information, does not necessarily justify its continuance.

The fact that a report does not presently exist is no indication that management does not need a report of that nature and with that information. In developing a paperwork system, it is frequently necessary to start with the information needed by management, in the form of reports, and to work backwards to the data needed to assemble or construct such reports.

First, a set of reports prepared during the paperwork cycle is assembled. The data in the reports are analyzed in the same manner as the data in the forms used in the total system. The next step is a preparation of "Recurring Data Analysis Chart," which keys the items of data in the reports to their source in the forms. It should now be determined how data appearing in reports but not in forms are developed—whether by mathematical operations, by data manipulation such as file updating, or by procedural controls such as

insertion of a constant by the machine.

Management of the organizations affected is consulted to determine whether essential reports are missing, were not prepared because they took too much time, or were too expensive. Frequently reports of this nature are achievable with mechanized equipment. If new reports are furnished, do they supersede any presently prepared reports?

DEVELOPING THE NEW SYSTEM

Unfortunately, few general principles of systems development are available. Perhaps the greatest ingredient of the development of any paperwork system is imagination—the ability to visualize the capabilities of various machines, to picture the use of a selected machine to handle a specific problem, and to determine the feasibility of a new approach.

Not all persons are endowed with the same degree of imagination. Where one can imagine

PURCHASE ORDER—SDA3				
APPROPRIATION CHARGEABLE CO. 1102-2. 41501. 262		P.O. DATE 26 April 1962	P.O. NO. 39101-108	
TO (The low bidder from among the various vendors)		SHIP TO United States Automation Agency Washington 25, D.C.		
MARK FOR Training Department		ORGANIZATION Records Mgmt.	F. O. B. Shipping Point	
DATE REQUIRED 15 May 1962	ROUTING Air Express	TERMS 30 Days Net	VENDOR'S NO. PO - 1808 - 502	
ITEM	QUANTITY	NOMENCLATURE AND DESCRIPTION		PRICE
1	12	265-9847. Films (SDA Workshop)		\$120.00
SDA 3				

Fig. 111

RECEIVING REPORT—SDA4

APPROPRIATION CHARGEABLE CO. 1102-2. 41501. 262		P.O. DATE 26 April 1962	P.O. NO. 39101-108	
RECEIVED FROM (The low bidder from among the various vendors)		SHIP TO United States Automation Agency Washington 25, D.C.		
MARK FOR Training Department		ORGANIZATION Records Mgmt.	F.O.B. Shipping Point	
DATE REQUIRED 15 May 1962	ROUTING Air Express	TERMS 30 Days Net	VENDOR'S NO. PO - 1808 - 502	
ITEM	QUANTITY	NOMENCLATURE AND DESCRIPTION	QUANTITY ACCEPTED	QUANTITY REJECTED
	12	265-9847. Films (SDA Workshop)		

SDA 4

Fig. 112

the possibility of solving his problem by a mechanical means, from origin of data to its ultimate uses in a computer, another with the same facts may be able only to visualize a streamlined conventional manual method. Where one can imagine a completely new approach to a paperwork problem, eliminating many steps of a paperwork cycle and many reports, another may be able to make only minor procedural improvements in the old and tried system.

The possibilities of source data automation are limited only by the imagination of those who conduct systems studies needed. It may be profitable, however, to point out here some areas of systems development on which greater emphasis must be placed when source data automation is considered.

Considering a Specialty Form

Perhaps the first question to be answered in the development of a new system would be,

“Is equipment *really* needed?” Perhaps a specialty form will provide a desirable solution without new or automated equipment.

Specialty forms often permit the writing of all data at one time onto many different forms fastened together into a single set. Separating the form-set into smaller parts (smaller form-sets) often permits adding data during further processing in the paperwork cycle. Factors affecting the construction of specialty forms include—

Eliminating Data From Some Forms in the Set by—

- Varying the length or width of some of the parts of the set.
- Varying the length or width of some of the carbon papers in the set.
- Devising carbon blockouts.
- Using strip carbons or spot carbons.
- Sensitizing parts of the set in selected spots by carbon backing.

RECURRING DATA ANALYSIS CHART

RECURRING DATA ANALYSIS CHART		TITLE, DESCRIPTION, OR SOURCE																PAGE	OF	PAGES	
SUBJECT OF ANALYSIS OR ACTIVITY		REQUISITION	REQUEST FOR QUOTATION	PURCHASE ORDER	RECEIVING REPORT															TOTAL	
STUDY OF PURCHASING - RECEIVING CYCLE																					
ANALYZED BY	DATE																				
J. J. SMITH	16 Apr 62																				
ITEM	NO. SDA 1	NO. SDA 2	NO. SDA 3	NO. SDA 4	NO.	NO.	NO.	NO.	NO.	NO.	NO.	NO.	NO.	NO.	NO.	NO.	NO.	NO.	NO.	NO.	TOTAL
1. Appropriation Chargeable	x	x	x	x																	4
2. Requisition Date	x																				1
3. Requisition - Quotation - Purchase Order Number	x	x	x	x																	4
4. Ship To	x	x	x	x																	4
5. Mark For	x	x	x	x																	4
6. Organization	x	x	x	x																	4
7. F. O. B.	x	x	x	x																	4
8. Date Required	x	x	x	x																	4
9. Routing	x	x	x	x																	4
10. Terms	x	x	x	x																	4
11. Requisitioned By	x																				1
12. Item	x	x	x	x																	4
13. Quantity	x	x	x	x																	4
14. Nomenclature and Description	x	x	x	x																	4
15. Price				x																	1
16. Quotation Data		x																			1
17. To - Received From				x	x																2
18. Quotation Approved By		x																			1
19. P. O. Date				x	x																2
20. Vendor's No.				x	x																2
21. Quantity Accepted					x																1
22. Quantity Rejected						x															1
23.																					
24.																					
25.																					
TOTAL	14	14	16	17																	61

REPETITIVE DATA WITH DIFFERING FORM IDENTIFICATION

Fig. 113

Separating the Form Into-

- Individual copies.
- Smaller sets for further processing of each (small set) independently.

Getting a Sufficient Number of Copies by --

- Using carbonless paper to reduce the bulk of the form set.
- Using an offset master, hectograph master, or die impressed stencil to

Produce both form and variable data simultaneously onto blank paper.

Print into specific locations on preprinted paper forms by the manner of positioning different forms in the duplicating machine.

Eliminate certain data from some forms either by the manner of positioning the forms in the duplicator or by blocking out certain areas on the master.

- Generating a new offset master for further processing with some data added at a later date.

Like the whole area of systems development, the design of specialty forms to meet the requirements of specific paperwork systems is limited only by the imagination of the designer.

Selecting the Medium

The next consideration in systems development is the selection of the medium to carry the native language. The *medium* is the basic starting point for devising the new system and for selecting the specific models of equipment needed.

Each *medium*, tapes, cards, tags, and so on, has advantages that are valid only when considered in the light of a *specific* source data automation application. Chapters III through VI of this handbook outline the advantages of each medium and the specific functions that are machinable with such medium. The advantages of each medium must be carefully considered in comparison with the specific needs of a paperwork system. Figure 114 shows how some of the analysis of the medium might be reduced to writing.

ANALYSIS OF VARIOUS MEDIA FOR A PARTICULAR SYSTEM

FACTORS	PAPER TAPES	WIDE TAPES (EDGE PUNCHED CARDS)	PUNCHED CARDS
Sorting.....		O	X
Random Access.....		O	X
Capacity.....	X	O	
Visual Reading.....		O	
Recording Speed.....	X	O	
Writing Speed.....			X
Equipment Expense.....	X	X	
Byproduct of forms writing at the source.....	X		
Portability.....	?		?
Computation.....			X

Key: X— best.
O—next best.

Figure 114

Selecting Specific Equipment

The final consideration in systems development is the determination of the specific make and model of equipment to meet the desired systems improvement. Descriptions of available makes and models are contained in "Source Data Automation Equipment Guide," a companion publication of this handbook.

Selection of equipment is frequently influenced by the equipment already owned or operated by the agency. Compatibility of equipment is likely to save money in the long run. Operators are already familiar with the operating principles and techniques of the existing equipment. Additional training on the new models may be required, but it is seldom necessary to conduct a complete training program. Compatibility eliminates much conversion from one native language to another or from one medium to another.

Equipment selected for the paperwork system must have adequate capacity and sufficient gadgets to perform all of the necessary operations without over- or under-mechanization. Each basic model of equipment has the ability to perform specified functions.

Additional functions can often be performed by cable connecting an auxiliary device or by building in some additional gadget. Procurement of these additional devices is uneconomical unless a real need for them is present in the requirements of the system. On the other hand, many of the additional devices require factory installation. Omitting the device at time of purchase can be costly in the long run.

In the selection of equipment give careful consideration to capturing information as the byproduct of a basic processing step. Effort should be made to eliminate the need for human intervention in an automated system. Full advantage should be taken of the automated features of the various makes and models of equipment.

Costs of the present (manual or semi-mechanized) system should be compared with those of the prospective system and with alternate prospective systems using other machines or media. It is necessary to consider the cost of rental, purchase, and lease-purchase arrangements for the equipment. The procurement plan that is economically sound for the particular paperwork system studied should be selected. Usually the purchase or rental of equipment should be amortized within 3 years by savings in personnel, time, or other operational costs. If the equipment does not amortize in this period of time, probably only a portion of the paperwork system was studied, not a *total system*. It is also possible that other potential source data automation applications in the same organization can share the cost of equipment procurement or rental.

Need for employee training influences selection of the make and model of equipment. The availability of training should be checked, if any is required. Will it be conducted by the equipment manufacturer with a standard training program or will it be necessary for the agency to develop in-house training programs? The amount of training necessary depends on the complexity of the equipment selected for the paperwork system, as well as on the amount of procedural change made in the system.

After a tentative equipment selection has been made, it is desirable to see a demonstration of that equipment actually performing the

agency's paperwork problem. Such demonstrations may be performed in the showroom of the manufacturer or in the office of a customer. Demonstration frequently brings to light an essential operation overlooked in preliminary selection of equipment. During a demonstration every detail of the job is again questioned, as it is performed by the machine. Particular emphasis, during a demonstration, should be placed on how the equipment handles exceptions to the routine.

DO'S AND DON'TS OF AUTOMATION

Perhaps, what has been said in this chapter is best summarized by listing some of the Do's and Don'ts of source data automation.

DO—

- Look for repetition, volume, urgency, and error as clues to potential source data automation applications.
- Study the system in depth. Automation requires precision. Machines are less flexible than people. Every detail of the system must be worked out in advance. Machines bind you to the system.
- Study the system from birth (source) of data to its final resting place.
- Consider another approach besides automated equipment.
- Remember that systems improvement is the objective, not necessarily automation.
- Analyze the need for the data being collected. Collect only data which will serve a purpose.
- Remember that each field of data must be completely disciplined from one record to another, from one medium to another.
- Consider necessary controls. A suitable source data automation system must contain: (1) a selected number of controls to assure accuracy of results; (2) a number of checkpoints to which we can return when an error is detected, without having to return all the way to the beginning of the paperwork system.

- Consider standardized coding of information. Codes must be developed for uniform application and each term must be defined to prevent miscoding of information.
 - Take advantage of byproduct production of native language media-byproduct to a necessary basic step in the paperwork system.
 - Consider training. Either develop in-house, on-the-job programs or arrange to have training conducted by the equipment manufacturers.
 - Conduct a trial run to debug your proposal. It is better to discover an error or overlooked item early in the game.
 - Make doubly sure that the preparation of input or conversion of already existing data involves—
 - Proper recording and validation of raw data.
 - Proper coding of data.
 - Verification of accuracy of data transcription.
 - Periodic machine testing to detect malfunctions.
 - Use your *Imagination*.
- DON'T
- Buy equipment first and then attempt to determine what to do with it.
 - Try to do the job without putting the facts about the present system and your proposal in writing.
 - Try to do the job alone. Instead get the cooperation of the people involved in the operation.
 - Over- or undermechanize, or mechanize for the glamour of automation.
 - Install an agencywide system overnight. Try a pilot installation first, installing others on a scheduled basis.
 - Look at a single step of a paperwork system. Instead study the whole system.
 - Try to carry on operations with the present forms. Probably all forms involved in the paperwork cycle will require revision.
 - Ignore the problems of converting existing data to the native language you have chosen.
 - Blindly prepare the same reports used in the present system.
 - Ignore comments and suggestions from the operating personnel.
 - Buy a "pig-in-the-poke". Instead get demonstration of the equipment performing the routine paperwork cycle and all the exceptions to the routine.
 - Select a medium for the native language without analysis of the advantages in relation to the specific paperwork system.

Washington: 1965

Page Denied